



Digital Cel-Gro Tissue Culture Rotator

88882015 & 88882016

In the United States:

For customer service, call 1-800-766-7000
To fax an order, use 1-800-926-1166
To order online: thermofisher.com

In Canada:

For customer service, call 1-800-234-7437
To fax an order, use 1-800-463-2996
To order online: thermofisher.ca

Find out more at thermofisher.com

ThermoFisher
SCIENTIFIC

Operating Manual

Revision A .04 01 2021

ThermoFisher
SCIENTIFIC

Contents

Section 1 Important Information	1
Disposing of Product	2
<hr/>	
Section 2 Introduction	3
<hr/>	
Section 3 Inspection and Installation	4
Packing List	4
Connections	5
Structure Diagram	5
<hr/>	
Section 4 Overview	6
Specifications	6
Environmental Conditions	6
Safety Instructions	7
<hr/>	
Section 5 Operation	8
Control Panel	8
Installation	9
Accessory Installation	9
Settings	13
<hr/>	
Section 6 Safety Tips and Maintenance	15
<hr/>	
Section 7 Troubleshooting	16
<hr/>	
Section 8 Optional Accessories	17
<hr/>	
Section 9 Warranty Information	19
<hr/>	
Section 10 Compliance	20
<hr/>	

Section 1 Important Information

Ignoring the following warnings could cause serious injuries or even fatal accidents.

Check the voltage, phase and capacity of power supply on the ID plate before installation. Connect properly.

Power supply must be properly grounded. Abnormal grounded connection causes serious damage. Grounded connection must not be on the water pipe and gas pipe.

Use provided power cord. Power cord: Wall outlet with grounded terminal power cord 250V 10A.

Do not install the product in a place that gas could leak. Do not use in a place that has industrial oil smoke or metallic dust. It causes fire or electric shock. Do not use the machine near to places where explosion could happen due to organic evaporating gases.

Explosive materials: acid, ester, nitro compound.

Inflammable materials: salt peroxides, inorganic peroxide, salt acids.

Check equipment for permissible environmental conditions when using inside of Temperature and Humidity Chamber or Incubator. It can be the cause of fire or trouble by stirrer electricity, electronic, and damage of motor.

Rotator's permissible environmental condition. Temperature 5°C to 40°C, Maximum relative humidity 80%.

Unplug if there is a strange sound, smell and/or smoke from the product. Stop

operating and request the service.

Keep out of the direct sunlight. It may influence product life and proper operation.

Do not use the machine at places where moisture is high and flooding can happen.

Do not assemble, repair, modify on your own. Changes to the product could result in product inefficiency. Also this will void warranty. Which also indicates a hazardous situation, if not avoided may result in minor or moderate injury.

Indicates a hazardous situation which, if not avoided, may result in minor or moderate injury.

Do not put heavy things on the power cord. Do not put the machine on the cord. It may take off the wire coating and cause electric shock or fire.

Do not touch it with wet hands and place the main plug correctly. It could cause the electric shock or injuries.

Installing power outlet near instrument may be convenient. Allow adequate spacing around the product to ensure proper ventilation, accessibility to the power switch and for allowing the instrument to run without impediment.

Do not install the stirrer near machinery generating high frequency noise. Avoid installation close to high frequency-welding machine, sewing machine, or mass SCR controller.

Do not inject any liquid and inflammable things inside of product.

Do not pour water or put liquid on the top of the product when cleaning. Disconnect the main power immediately and request the service if water may be in the product.

Do not let the product take any strong shock or vibration. It could cause abnormal operation or trouble. It may deteriorate the ability of the product operation and not obtain correct results.

Do not sprinkle insecticide or flammable spray on the product. Use smooth cloths. Cleaning with solvent can cause fire and deformity.

Power off while product cleaning. It may cause electric shock or fire.

Do not drop or allow the machine to fall. It will cause wrong operation and malfunction.

Only accessories that meet the manufacturer's specifications shall be used.

Disposing of Product

Dispose of the unit by separating the plastic, motor and electronics and dispose according to local laws and regulations.

Section 2 Introduction

Welcome to use Thermo Scientific Digital Cel-Gro Tissue Culture Rotator.

Rotator is designed to mixing operations in different areas, including gel colorization / decolorization, sample cleaning, anti body staining, hybridization, immunoprecipitation, west blot, and various volume tissue culture.

Rotator is designed for the different application ,such as schools, laboratories, hospitals.

Rotator is used for routine blood test, and other mixing applications.

This product is intended to be used in a laboratory setting and is not to be used in a clinical setting.

Features:

Rotator provides an efficient and gentle mixing to keep biological samples in suspension. It is applied in the occasions of preventing blood clotting, latex diagnosis,immunoprecipitation,and so on.

- Compact design saves space and can be used in incubator.
- A variety of independent clamps to choose from,it's convenient to use the different combination,the clamps have different models fit to1.5-50ml tube.
- Digital type instrument with adjustable speed, maximum speed 80rpm.

Section 3 Inspection and Installation







Before unpacking the unit, first check for damages in the package of the unit.

Then unpack the unit. Check carefully to see if there were damages incurred during transit.

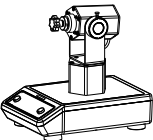
After unpacking, check that all unit parts and accessories are as listed below. Contact us or the agent from which you purchased the unit if any components were omitted.

3.1 Packing List

Table -1. Packing List

Description	Catalog Number		Figure
Digital Cel-Gro Tissue Culture Rotator	88882015	88882016	
General Power Adaptor	1	1	
US Plug	1	N/A	
CN Plug	N/A	1	
EU Plug	N/A	1	
UK Plug	N/A	1	
Screw Driver	1	1	

3.2 Connections

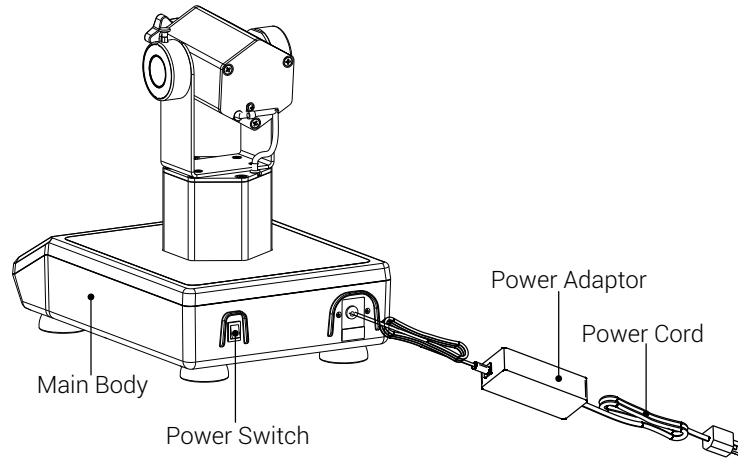

3.3 Structure Diagram

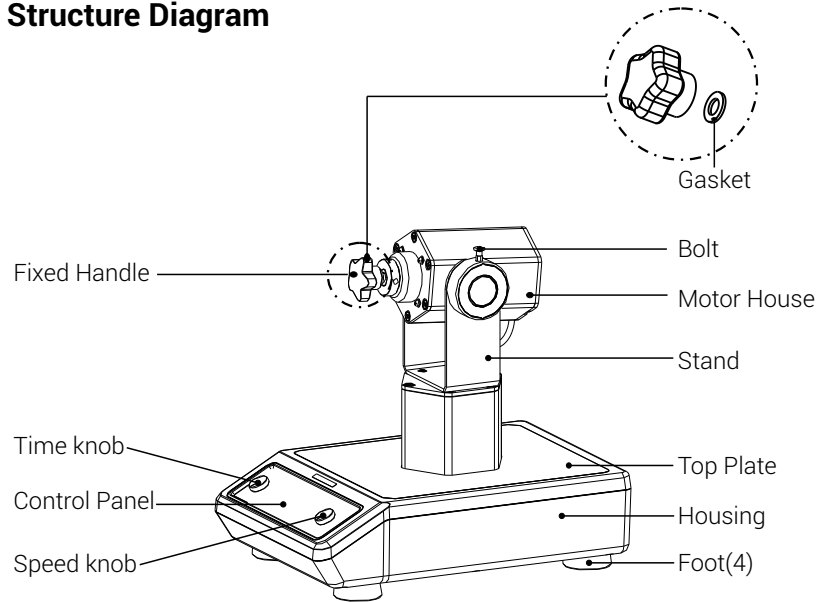

Section 4 Overview

4.1 Specifications

Rotation Speed	Speed Range.....	5~70rpm
	Speed Accuracy.....	± 1rpm
	Display.....	LED
	Adjustable.....	Knob
Angle	Angle Adjustment Range.....	95°~180°
	Angle Accuracy.....	± 2°
Load	Max Load (Contain rotator drum weight).....	5kg
Time	Timing Range.....	0~9999min.
Size	Overall Dimensions.....	383×260×412mm
	Packaging Dimensions.....	486×381×470mm
Weight	Net Weight.....	8.2Kg(18.1lb)
	Gross Weight.....	10.4Kg(22.9lb)
Power Supply	Input Requirement.....	100-240VAC~, 50/60Hz, 8W, 0.2A
	Output Requirement.....	24V=, 2.5A
Others	Certification.....	RoHS, WEEE, cCSAus, CE Mark
	Noise Level.....	≤55dB with no load

4.2 Environmental Conditions

Application Environmental Conditions: indoor use
 Temperature..... 5 to 40°C
 Voltage Fluctuation..... ±10% of the nominal voltage
 Altitude..... ≤2,000 m
 Humidity..... 20% to 85%

Storage Environmental Conditions
 Temperature.....0 to 60°C
 Humidity.....20% to 90%, non-condensing

3.3 Safety Instructions

Please read the entire instruction manual before operating the Digital Cel-Gro Tissue Culture Rotator .

⚠ WARNING DO NOT use the Digital Cel-Gro Tissue Culture Rotator in a hazardous atmosphere or with hazardous materials for which the unit was not designed. Also, the user should be aware that the protection provided by the equipment may be impaired if accessories used are not provided or recommended by the manufacturer, or are used in a manner not specified by the manufacturer.

CAUTION ! To avoid electrical shock, completely cut off power to the unit by disconnecting the power cord from the unit or unplugging from the wall outlet. Disconnect unit from the power supply prior to maintenance and service. Any spills should be removed promptly. Bio hazard spills should be cleaned using approved liquid promptly. Solvent spills are a fire hazard.

Stop the unit immediately, and DO NOT operate until clean up is complete and vapors have dissipated.

DO NOT immerse the unit for cleaning.

DO NOT operate the unit if it shows signs of electrical or mechanical damage.

Note: The rotary plate may have a little vibration below 11 rpm. The vibration will relieve or disappear when more load is added.

Various independent clamps are available with this Digital Cel-Gro Tissue Culture Rotator for convenient combination use. It is applicable for 1.5ml to 50ml microtubes to mix liquid efficiently and gently. It has an angle range of 95 to 180 degrees and can maintain suspension state of biological samples such as blood mixing. Applications include blood coagulation prevention, emulsion diagnosis, immunoprecipitation, and other related areas.

Section 5 Operation

This chapter covers the control panel and its operation.

5.1 Control Panel

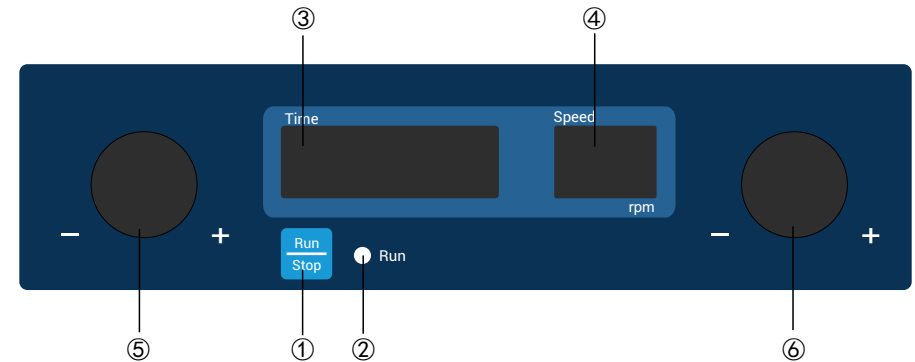

- ①. Run/Stop button: Start or stop the instrument.
- ②. Run indicator: The light is on when the instrument is running and off when the instrument is in standby.
- ③. Time display window: The window displays cumulative time (in continuous mode) or remaining time (in timer mode).
- ④. Speed display window: The window displays set speed (when the instrument is in standby) or current speed (when the instrument is running).

- ⑤. Time setting knob: The knob is used to increase or decrease the set time of the instrument.
- ⑥. Speed setting knob: The knob is used to increase or decrease the set speed instrument.

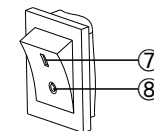

- ⑦. Gear I: When the switch is in "gear 1", the instrument power is on.
- ⑧. Gear 0: When the switch is in "gear 0", the instrument power is off.

5.2 Installation

1. Connect all the components according to the figures shown on page 4 of this manual. Use grounded power outlet. Ensure the machine is on a flat surface prior to operating.
2. Press down the power switch on the back right side of the instrument and put it to the "I" state and then the instrument is in standby.

5.3 Accessory Installation

Only accessories that meet the manufacturer's specifications shall be used.

Angle Adjustment Method

1. Pull out the bolt.

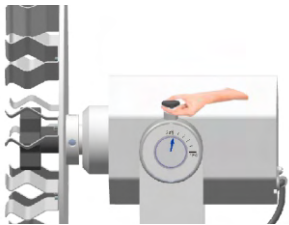

Pull the bolt up

Note: If the bolt cannot be pulled out, please operate according to the following instructions.

- 1) Turn the motor housing back and forth gently by hand and pull the bolt up at the same time.

- 2) If the bolt still cannot be pulled out, please use vise grip plier to pull the bolt up and turn the motor housing at the same time.
- 3) Please contact us immediately if the problem still exists.

2. Rotate the motor housing gently by hand to adjust the angle.



3. Insert the bolt.

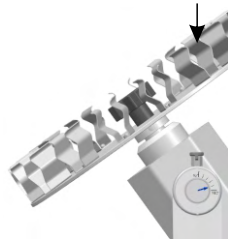

Note: If the bolt does not fit completely, Push the motor housing gently until the bolt fits well.

4. Angle adjustment range is shown in the following figures.

Single Tray Angle range

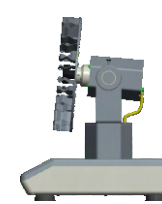

Mixing angle 95°

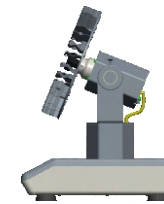

Mixing angle 112°

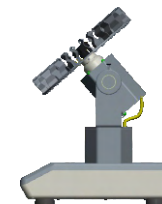

Mixing angle 129°

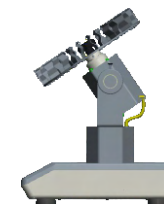

Mixing angle 146°



Mixing angle 163°

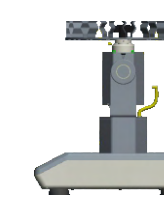

Mixing angle 180°

Double Tray Angle range

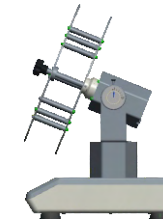

Mixing angle 112°

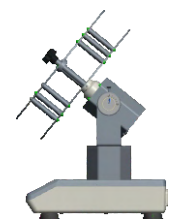

Mixing angle 129°

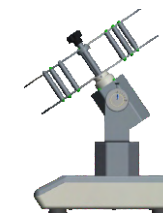

Mixing angle 146°

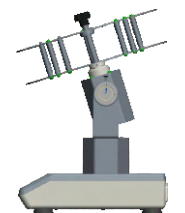

Mixing angle 163°

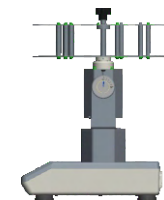

Mixing angle 180°

Single Tray Installation

1. Insert the screw on the rotation shaft into the center hole of the tray and make sure the tray firmly touches the fixing block of the rotary plate, as shown in figure 1.
2. Tighten the fixed handle until the tray is fasten, as shown in figure 2.
3. The tip of the screw driver is aligned with the hole at the side of the fixing block to ensure that the fixing block of the rotary plate does not move and continue to tighten the fixed handle until the tray is fastened tightly, as shown in figure 3.

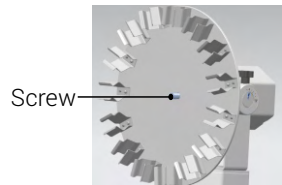

figure 1



figure 2

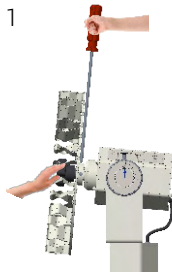
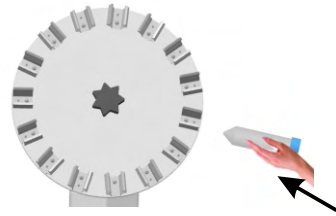

figure 3

4. Insert the test tube into the test tube holder until it reaches the appropriate position.



Double Tray Installation

1. Insert the stud on the rotation shaft into the center hole of the tray and make sure the tray firmly touches the fixing block of the rotary plate, as shown in figure 4.



figure 4

2. Insert the fixed handle into the center hole and screw in the stud until the tray is fastened, as shown in figure 5.



figure 5

3. Fasten the screw on the tray with the screw driver to ensure that the tray is fixed well, as shown in figure 6.

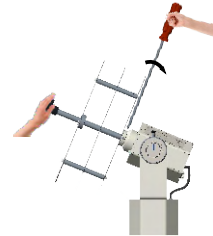
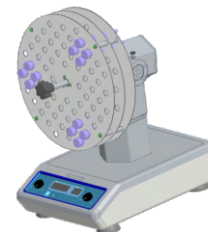

figure 6

Caution:

Failure to load or unload the tray as listed above may result in uneven tray rotation or possible stalling of the tray.

4. Insert the test tube into the hole. Make sure to place the test tubes close to the center or symmetric around the axis.



Note:

1. Minimum angle adjustment for Double Tray is 112°
2. After continued and extended operation, it is possible for the tray to exhibit uneven or erratic rotation. This does not necessarily indicate equipment malfunction and a cause for returning the unit to the manufacturer.

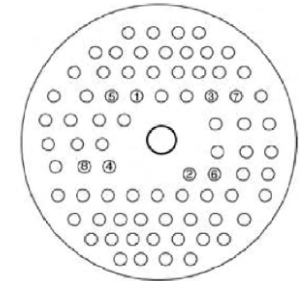

Tray, Front Facing

Loading and Unloading the Tray:

1. Insert or remove culture tubes starting from the center to the outside edge of the tray.
2. Make sure the weight is distributed evenly on the tray.
3. Maintain the overall balance of the tray, especially when it is moving.

5.4 Settings

Time Settings

1. Continuous mode

Press the Time setting knob. When the Time display window starts flashing, turn the knob to increase or decrease the time to 00:00 and then press the knob within 5s.

2. Timer mode

Press the Time setting knob. When the number shown on the Time display window starts flashing, turn the knob to increase or decrease the time value. Press the knob when the time shown on the Time display window reaches the set value within 5s.

Speed Settings

Press the Speed setting knob. When the Speed display window starts flashing, turn the knob to increase or decrease the speed value. Press the knob when the speed shown on the Speed display window reaches the set value within 5s.



Run and Stop

1. Continuous Mode

Press the  button and the instrument will start running with the specified settings and the RUN indicator light will be on. The TIME display window will show the cumulative time and the SPEED display window will show the current speed.

Press the  button again and the instrument will slow down until it stops. The instrument will then be in standby and the two display windows will show the set values.

2. Timer Mode

Press the  button and the instrument will start running with the specified settings and the RUN indicator light will be on. The TIME display window will show the remaining time and the SPEED display window will show the current speed. Press the  button again and the instrument will slow down until it stops. The instrument will then be in standby and the two display windows will show the set values.

Finish Operation

After the operation is finished, press the power switch at the back right side the instrument and put it into the "O" state. Unplug the instrument and store the instrument according to the storage guide.

Note: To ensure shaking operation smooth and steady, it may take 1 minute for the microprocessor control system to accelerate the tray to the set speed.

Alarm System

Err1: If running speed does not match the setting speed, the instrument will have a three-time reboot, and after the three reboots failed, there will be a buzzer, and then Err1 will be displayed in the Time display window .

End of timer: The instrument buzzing alarm, the "End" is displayed in the Time display window.

When the instrument alarms, press any key and the instrument goes into standby mode.

Power Recovery

If the power supply is cut off suddenly while the instrument is in operation, the unit will automatically run at the previously set parameter upon power restoration. The display windows will flash. Press any button to stop the display window from flashing.

Section 6 Safety Tips and Maintenance

Safety Tips

1. Use independent power supply.
2. Check if the local power supply voltage is suitable for use.
3. Do not drag the power supply cable when unplugging.
4. Do not use non-specified power cable or damage cable.
5. Service should only be performed by a qualified professional.
6. The power supply must be unplugged under the following situations:
 - (1). When the unit is moved
 - (2). When the electrical cabinet or the moving component is opened
 - (3). When the equipment is malfunctioning
 - (4). When the equipment is not in use
7. Check that the instrument and the accessories are in good condition before each operation.

Cleaning

In order to ensure the safe use of the instrument, please follow the manufacturer's recommendations for cleaning when cleaning the instrument.

- Unplug the power first when cleaning.
- Wipe the instrument with a damp, soft cloth or non-corrosive cleaning agent.
- Direct spray instruments are prohibited.
- Make sure that the instrument is completely dry before operating it.
- Please wear gloves when cleaning.

Warning: Avoid dripping detergent or water into the inside of the instrument during cleaning.

Clean Spill

If accidental spillage of liquids caused by mishandling or contained breakage occurs on the surface of the instrument, please shut down the instrument and clean up the liquid immediately.

If the liquid has already spilled into the unit, cut off the power supply first and immediately clean up the liquid at the surface of the instrument. Place the instrument in a ventilated and dry environment for 24 hours before reuse. If the instrument is not functioning after drying for 24 hours, please contact the manufacturer.

Warning: The operator is not permitted to gain access using a tool, to a part which in normal use may be hazardous live.

Section 7 Troubleshooting

Please refer to the following table to troubleshoot if any malfunction occurs.

If the problem still exists, contact your local sales representative.









Error	Cause	Solution
Cannot start instrument, LED display window off	Power disconnected	Connect the power
	Power switch off	Switch on power
	Power adaptor failure	Replace power adaptor
No rotation of the drum	Over-weighted or unbalanced load	Adjust the weight and position of load, decrease rotation speed
	Electrical malfunction	Contact Thermo Scientific
	Mechanical malfunction	Contact Thermo Scientific
Loud noise	Component loose	Fasten screws
	Rotary plate loose	Fasten fixed handle
	Uneven or resonant surface	Place instrument at a level and firm surface
Other	Keep record for maintenance	

Note:

Err1 – Speed alarm

If Err1 occurs, please contact Thermo Scientific Customer Service for solutions.

Section 8 Optional Accessories

Description	Cat. No.	Dimensions	Max. Qty.	Figure
50x1.5/2.0ml Rotator Drum	88882149	Ø290×24mm	1	
30x15ml Rotator Drum	88882150	Ø290×31mm	1	
15x50ml Rotator Drum	88882151	Ø290×48mm	1	
10x10/15ml + 20x5/7ml Drum	88882152	Ø290×31mm	1	
64x14mm Rotator Drum	88882153	Ø310×75mm	1	
64x18.5mm Rotator Drum	88882154	Ø310×115mm	1	
142xØ17mm Rotator Drum	88882155	Ø380×78mm	1	
76xØ26mm Rotator Drum	88882156	Ø380×73mm	1	
60xØ30mm Rotator Drum	88882157	Ø380x78mm	1	

Note:

Minimum angle adjustment for Double Tray Drum (88882153 / 88882154 / 88882155 / 88882156 / 88882157) is 112°

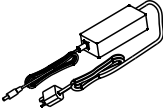
Description	Cat. No.	Dimensions	Max. Qty.	Figure
General Power Adaptor w/US plug	88870126	125VAC 10A 1.8m	1	
General Power Adaptor w/AUS, CN plug	88870127	250VAC 10A 1.8m	1	
General Power Adaptor w/EU plug	88870128	250VAC 16A 1.8m	1	
General Power Adaptor w/UK plug	88870129	250VAC13A 1.8m	1	

Section 9 Warranty

THERMO FISHER SCIENTIFIC STANDARD PRODUCT WARRANTY

The Warranty Period starts two weeks from the date your equipment is shipped from our facility. This allows for shipping time so the warranty will go into effect at approximately the same time your equipment is delivered. The warranty protection extends to any subsequent owner during the first year warranty period.

During the first two (2) years, component parts proven to be non-conforming in materials or workmanship will be repaired or replaced at Thermo's expense, labor included. Installation and calibration are not covered by this warranty agreement. The Technical Services Department must be contacted for warranty determination and direction prior to performance of any repairs. Expendable items, glass, filters and gaskets are excluded from this warranty.

Replacement or repair of components parts or equipment under this warranty shall not extend the warranty to either the equipment or to the component part beyond the original warranty period. The Technical Services Department must give prior approval for return of any components or equipment. At Thermo's option, all non-conforming parts must be returned to Thermo Fisher Scientific postage paid and replacement parts are shipped FOB destination.

THIS WARRANTY IS EXCLUSIVE AND IN LIEU OF ALL OTHER WARRANTIES, WHETHER WRITTEN, ORAL OR IMPLIED. NO WARRANTIES OF MERCHANTABILITY OR FITNESS FOR A PARTICULAR PURPOSE SHALL APPLY. Thermo shall not be liable for any indirect or consequential damages including, without limitation, damages relating to lost profits or loss of products.

Your local Thermo Sales Office is ready to help with comprehensive site preparation information before your equipment arrives. Printed instruction manuals carefully detail equipment installation, operation and preventive maintenance.

If equipment service is required, please call your Technical Services Department at 1-866-984-3766, option number 2. We're ready to answer your questions on equipment warranty, operation, maintenance, service and special application. Outside the USA, please contact local Thermo Technical Services Department or local distributor for warranty information.

Section 10 Compliance

1. European Union

 The European voltage models of this product meet all the applicable requirements of the European Directives and therefore display the CE Marking. These Directives are captured in the EU Declaration of Conformity which may be obtained from the manufacturer.

2. Product Safety

This product family has been tested to applicable productsafety standards by a Nationally Recognized Test Laboratory (NRTL) and may bear the NRTL's mark of safety compliance to those applicable standards.

3. Electromagnetic Compatibility

3.1 FCC Statement (USA)

 Any changes or modifications not expressly approved by the party responsible for compliance could void the user's authority to operate the equipment.

Note: This equipment has been tested and found to comply with the limits for a Class B digital device, pursuant to part 15 of the FCC Rules. These limits are designed to provide reasonable protection against harmful interference when the equipment is operated in a commercial environment. This equipment generates, uses, and can radiate radio frequency energy and, if not installed and used in accordance with

the instruction manual, may cause harmful interference to radio communications. Operation of this equipment in a residential area is likely to cause harmful interference in which case the user will be required to correct the interference at his own expense.

3.2 Canadian ISCED IC Notice

This ISM digital apparatus complies with Canadian ICES-001. Cetappareil ISM estconformeá la norme NMB-001 du Canada.owing optimum tray rotation.

3.3 Korean KC Registration

 사용자안내문
이기는은무용환경에서사용할 목적으로적합성평가를받은기기로서가정용환경에서사용하는경우전파 간섭의우려가있습니다

WARNING Statement: EMC Registration is done on this equipment for business use only. It may cause interference when the product would be used in home. This warning statement applies a product for business use.

4. Environmental Compliance

4.1 Evaluation of Chemicals - Regulations and Directives

4.1.1 REACH - Europe

 Thermo Fisher Scientific is committed to meeting all compliance obligations to evaluate, communicate, and register any Substances of Very High Concern (SVHC), and finding alternates where

appropriate.

4.1.2 RoHS - Europe

Thermo Fisher Scientific is determined to reduce the impact we have on the environment, and so can declare that this product fully complies with the European Parliament's RoHS2 (Restriction of Hazardous Substances) Directive 2011/65/EU, with respect to the limitation for the following substances:

- Lead (0.1 %)
- Mercury (0.1 %)
- Cadmium (0.01 %)
- Hexavalent chromium (0.1 %)
- Polybrominated biphenyls (PBB) (0.1 %)
- Polybrominated diphenyl ethers (PBDE) (0.1 %)

2015/863 Annex II (RoHS2 Amendment, In effect after July 22, 2021)

- Bis(2-ethylhexyl) phthalate (DEHP) (0.1 %)
- Butyl benzyl phthalate (BBP) (0.1 %)
- Dibutyl phthalate (DBP) (0.1 %)
- Diisobutyl phthalate (DIBP) (0.1 %)

Our compliance is witnessed by written declaration from our suppliers and/or component testing. This confirms that any potential trace contamination levels of the substances listed above are below the maximum level set by the latest regulations or follow established

exemptions of the regulation due to their application.

4.1.3 RoHS - China

This product complies with the requirements of the legislative act Administration on the Control of Pollution Caused by Electronic Information Products (ACPEIP). A label of conformance, such as one of the following, may be found on the product:



5. End of Life Care

Some considerations and suggestions are listed below for proper disposal of this product. While addressing these actions for safe recycling and disposal, please follow all guidelines, Safety Data Sheets (SDS), or regulations applicable to your location.

- This product has materials and components that may be recycled or reused according to local guidelines and regulations.
- Clean up any chemical or biological safety hazards.



WEEE Compliance. This product is required to comply with the European Union's Waste Electrical & Electronic Equipment (WEEE) Directive 2012/19/EU. It is marked with the following symbol. Thermo Fisher Scientific has contracted with one or more recycling/disposal

companies in each EU Member State, and this product should be disposed of or recycled through them. Further information on our compliance with these Directives, the recyclers in your country, and information on Thermo Scientific products which may assist the detection of substances subject to the RoHS Directive are available at www.thermofisher.com/