

Thermo Scientific
Heratherm
Advanced Protocol and
Advanced Protocol Security
Microbiological Incubators

IMH 60/100/180

IMH 60-S/100-S/180-S/400-S/750-S

Operating Instructions

50125555 B

14.06.12



© 2012 Thermo Fisher Scientific Inc. All rights reserved.

These operating instructions are protected by copyright. Rights resulting thereof, particularly reprint, photomechanical or digital postprocessing or reproduction, even in part, are only allowed with the written consent of Thermo Electron LED GmbH.

This regulation does not apply to reproductions for in-plant use.

The contents of this operating instructions manual may change at any time and without any prior notice. Concerning translations into foreign languages, the German version of these operating instructions is binding.

Trademarks

Heratherm[®] is a registered trademark of Thermo Scientific.

Thermo Scientific is a brand owned by Thermo Fisher Scientific Inc.

All other trademarks mentioned in the operating instructions are the exclusive property of the respective manufacturers.

Thermo Electron LED GmbH
Robert-Bosch-Straße 1
D - 63505 Langenselbold
Germany

Thermo Electron LED GmbH is an affiliate to:

Thermo Fisher Scientific Inc.
81 Wyman Street
Waltham, MA 02454
USA

Thermo Fisher Scientific Inc. provides this document to its customers with a product purchase to use in the product operation. This document is copyright protected, and any reproduction of the whole or any part of this document is strictly prohibited, except with the written authorization of Thermo Fisher Scientific Inc.

The contents of this document are subject to change without notice.

All technical information in this document is for reference purposes only. System configurations and specifications in this document supersede all previous information received by the purchaser.

Thermo Fisher Scientific Inc. makes no representations that this document is complete, accurate or error-free and assumes no responsibility and will not be liable for any errors, omissions, damage or loss that might result from any use of this document, even if the information in the document is followed properly.

This document is not part of any sales contract between Thermo Fisher Scientific Inc. and a purchaser. This document shall in no way govern or modify any Terms and Conditions of Sale, which Terms and Conditions of Sale shall govern all conflicting information between the two documents.

Contents

Chapter 1	Safety Notes	1-1
	Basic Operating Precautions	1-1
	Operational Safety Rules	1-2
	Warranty	1-2
	Explanation of Safety Information and Symbols	1-3
	Safety Notes and Symbols used throughout these Operating Instructions	1-3
	Additional symbols for safety information	1-4
	Symbols on the Incubator	1-5
	Intended Purpose of the Incubator	1-6
	Intended Purpose of the Incubator	1-6
	Incorrect Use	1-6
	Standards and Directives	1-6
Chapter 2	Delivery of the Incubator	2-1
	Packaging	2-1
	Acceptance Inspection	2-1
	Scope of Supply	2-2
Chapter 3	Installation	3-1
	Ambient Conditions	3-1
	Location Requirements	3-1
	Intermediate Storage	3-2
	Room Ventilation	3-2
	Space Requirement	3-3
	Installation Built-in Units	3-3
	Table-top units	3-4
	Floor stand units	3-5
	Transport	3-7
	Stacking Kit	3-9
	Installing the Stacking Feet	3-9
	Installing the Stacking Adapter	3-10
	Installing the Anti-tilt Anchor	3-11
	Floor stand unit spacers	3-13
Chapter 4	Product Description	4-1
	Heratherm IMH Series Incubator Overview	4-1
	Heratherm IMH-S Incubator Overview	4-4
	Safety Devices	4-11
	Work Space Atmosphere	4-11
	Door switch	4-11
	Sensing and Control System	4-12

Data Communications & Alarm Interface	4-13
RS 232 interface	4-13
Alarm contact	4-13
Mains connection	4-13
Fuses.....	4-13
Work Space Components	4-14
Inner Chamber	4-14
Connecting Nozzles for Fresh-air Filters (Accessory Items)	4-14
Access port.....	4-15
Tube Access Ports	4-17
Chapter 5 Installation procedures	5-1
Table-top units	5-1
Installing the Shelf System	5-1
Initial installation	5-1
Installing the Perforated Shelves	5-2
Preparing the useable space.....	5-2
Installation or Removal of the Support Rails.....	5-3
Installing and Uninstalling the Air Baffle.....	5-4
Levelling the Incubator.....	5-4
Commissioning of floor-mounted units.....	5-5
Installing/Removing air baffles (IMH-S Series).....	5-5
Commissioning, general	5-6
Installing the Shelf Support Brackets	5-6
Installing the Perforated Shelves	5-7
Mains connection	5-7
Connection to the power supply source	5-8
Connecting the RS-232 Interface	5-9
Interconnecting the Incubator with a Computer.....	5-9
Wiring the Alarm Contact	5-11
Function Description	5-11
Alarm Relay Specifications.....	5-11
Connection Example	5-12
Chapter 6 Operation.....	6-1
Preparing the Incubator.....	6-1
Starting Operation.....	6-1
Chapter 7 Handling and Control	7-1
Powering Up	7-6
Switching the Incubator Off / Powering Down	7-6
Temperature Set Value	7-7
Timer	7-8
Setting a Fixed-time On or Off Timer.....	7-10
Setting a Weekly Timer	7-11
Stopping a Timer.....	7-13
Light.....	7-15
Decontamination.....	7-16
Fan	7-19
Table-top units	7-19

Floor stand units	7-20
Settings	7-22
Error Log	7-22
Calibration	7-23
Date and Time	7-24
Temperature Display Unit	7-27
Chapter 8 Shut-down	8-1
Shutting the Incubator Down	8-1
Chapter 9 Cleaning and Disinfection	9-1
Cleaning.....	9-1
Cleaning Exterior Surfaces.....	9-1
Wipe / Spray Disinfection	9-1
Preparing the manual wipe/spray disinfection.....	9-2
Predisinfection	9-3
Cleaning.....	9-4
Final disinfection.....	9-4
Starting the Decontamination Routine.....	9-4
Chapter 10 Maintenance.....	10-1
Inspections and checks	10-1
Regular Checks.....	10-1
Semi-annual Inspection	10-1
Service Intervals.....	10-2
3-monthly service	10-2
Annual service	10-2
Preparing Temperature Calibration	10-3
Comparison Measurement Procedure.....	10-3
Temperature Calibration Procedure	10-4
Replacing the Door Seal.....	10-4
Replacing the Power Cord.....	10-5
Returns for Repair	10-5
Chapter 11 Disposal.....	11-1
Overview of Materials Used	11-1
Chapter 12 Error Codes.....	12-1
Chapter 13 Technical Data	13-1
Chapter 14 Spare Parts and Accessories	14-1
Chapter 15 Device Log	15-1
Chapter 16 Contact	16-1

List of Figures

Figure 3-1 Table-top incubators, dimensions and required clearances.....	3-4
Figure 3-2 Floor stand incubators, dimensions and required clearances.....	3-5
Figure 3-3 Floor stand incubators, dimensions and required clearances.....	3-6
Figure 3-4 Lift Points.....	3-7
Figure 4-1 Heratherm IMH 60/ IMH 100/ IMH 180 Front View.....	4-2
Figure 4-2 Heratherm IMH 60/ IMH 100/ IMH 180 Rear View.....	4-3
Figure 4-3 Heratherm IMH 60-S/ IMH 100-S/ IMH 180-S Series Front View	4-5
Figure 4-4 Heratherm IMH 60-S / IMH 100-S / IMH 180-S Series Rear View	4-6
Figure 4-5 Heratherm IMH 400-S Series Front View.....	4-7
Figure 4-6 Heratherm IMH 400-S Rear View	4-8
Figure 4-7 Heratherm IMH 750-S Front View.....	4-9
Figure 4-8 Heratherm IMH 750-S Rear View	4-10
Figure 4-9 Sensor System (for table-top units)	4-12
Figure 4-10 Sensor System (for floor stand units)	4-12
Figure 4-11 Signal Interfaces and Power Socket.....	4-13
Figure 4-12 Connecting Nozzles for Fresh-air Filters (Accessory Items)	4-15
Figure 4-13 Shelf System	4-16
Figure 4-14 Tube Access Ports.....	4-17
Figure 5-1 Sliding the Retaining Spring into the Support Rail.....	5-1
Figure 5-2 Installing the Shelving	5-2
Figure 5-3 Support Rail Installation.....	5-3
Figure 5-4 Removing the Air Baffle	5-4
Figure 5-5 Removing the bottom plate	5-5
Figure 5-6 Removing the left and right support profiles.....	5-5
Figure 5-7 Removing the rear air baffle IMH 400-S / 750-S.....	5-6
Figure 5-8 Shelf Support Bracket Installation	5-6
Figure 5-9 Installing the Perforated Shelves	5-7
Figure 5-10 AC Power Supply Socket	5-8
Figure 5-11 Alarm Relay Connection Example	5-12
Figure 7-1 Control Panel for Heratherm IMH Series and IMH-S Series Incubators	7-1
Figure 10-1 Door Seal Replacement	10-4

List of Figures

Safety Notes

Basic Operating Precautions

These operating instructions describe Heratherm incubators.

Heratherm incubators have been manufactured to the latest state of the art and have been tested thoroughly for flawless functioning prior to shipping. However, the incubator may present potential hazards, particularly if it is operated by inadequately trained personnel or if it is not used in accordance with the intended purpose. Therefore, the following must be observed for the sake of accident prevention:

- Heratherm incubators must be operated by adequately trained and authorized professional personnel.
- Heratherm incubators must not be operated unless these operating instructions have been fully read and understood.
- The present operating instructions, applicable safety data sheets, plant hygiene guidelines and the corresponding technical rules issued by the operator shall be used to create written procedures targeted at personnel working with the subject matter device, detailing:
 - the decontamination measures to be employed for the incubator and the accessories used with it,
 - the safety precautions to be taken when processing specific agents,
 - the measures to be taken in case of accidents.
- Repair work on the incubator must be carried out only by trained and authorized expert personnel.
- The contents of these operating instructions are subject to change at any time without further notice.
- Concerning translations into foreign languages, the German version of these operating instructions is binding.
- Keep these operating instructions close to the incubator so that safety instructions and important information are always accessible.
- Should you encounter problems that are not detailed adequately in these operating instructions, please contact Thermo Electron LED GmbH immediately for your own safety.

Operational Safety Rules

The following rules must be heeded when working with Heratherm incubators:

- Observe the sample weight limits specified for your Heratherm incubator as a whole and its shelving in particular; see “[Technical Data](#)” on [page 13-1](#).
- Do not load the bottom of the interior workspace to avoid the risk of overheating any samples placed there and to prevent the temperature sensor from being damaged.
- Arrange the samples evenly throughout the work space, making sure not to place them too closely to the interior walls to ensure a uniform temperature distribution.
- Do not load your Heratherm incubator with substances that exceed the capabilities of the available lab apparatus and Personal Protection Equipment to provide sufficient degrees of protection to users and third parties.
- Check the door seal every six months for proper sealing performance and possible damage.
- Do not process any samples containing hazardous chemical substances that may be released into the ambient air through defective seals or may cause corrosion or other defects on parts of the Heratherm incubator.

Warranty





Thermo Fisher Scientific warrants the operational safety and functions of the Heratherm incubators only under the condition that:

- the incubator is operated and serviced exclusively in accordance with its intended purpose and as described in these operating instructions,
- the incubator is not modified,
- only original spare parts and accessories that have been approved by Thermo Scientific are used (third-party spares without Thermo Scientific approval void the limited warranty),
- inspections and maintenance are performed at the specified intervals,
- an operation verification test is performed after each repair activity.









The warranty is valid from the date of delivery of the incubator to the customer.

Explanation of Safety Information and Symbols

Safety Notes and Symbols used throughout these Operating Instructions

	 DANGER Indicates a hazardous situation which, if not avoided, will result in death or serious injuries.
	 WARNING Indicates a hazardous situation which, if not avoided, could result in death or serious injuries.
	 CAUTION Indicates a situation which, if not avoided, could result in damage to equipment or property.
	 NOTE Is used for useful hints and information regarding the application.

Additional symbols for safety information

	Wear safety gloves!
	Wear safety goggles!
	Harmful liquids!
	Electrical shock!
	Hot surfaces!
	Fire hazard!
	Explosion hazard!
	Suffocation hazard!
	Biological hazard!
	Contamination hazard!
	Danger of tipping!

Symbols on the Incubator



Observe operating instructions



VDE test mark



CE-conformity mark: confirms conformity according to EU Guidelines



Alarm contact

Intended Purpose of the Incubator

Intended Purpose of the Incubator

Heratherm incubators are laboratory devices for preparing and cultivating cell and tissue cultures. The devices employ precision temperature control for simulating the specific physiological ambient conditions for these cultures.

Incorrect Use

To avoid the risk of explosion do not load the incubator with tissue, material, or liquids that:

- are easily flammable or explosive,
- release vapor or dust that forms combustible or explosive mixtures when exposed to air,
- release poisons,
- release dust,
- exhibit exothermic reactions,
- are pyrotechnical substances.
- refrain also from pouring any liquids onto the internal base plate or inserting bowls filled with liquids into the sample compartment.

Standards and Directives

The incubator complies with the following standards and guidelines:

- IEC EN 61010 - 1, IEC EN 61010 - 2 - 010
- Low Voltage Directive 2006/95/EC
- EMC Directive 2004/108/EC

Additionally, the incubator is in compliance with many other international standards, regulations and directives not listed here. Should you have any questions regarding compliance with national standards, regulations and directives applicable for your country, please contact your Thermo Fisher Scientific sales organization.

Delivery of the Incubator

Packaging

Heratherm incubators are delivered in a rugged packaging box. All packaging materials can be separated and are reusable:

Packaging materials

Packaging carton: Recycled paper

Foam elements: Styrofoam (CFC-free)

Pallet: Chemically untreated wood

Packaging film: Polyethylene

Packaging ribbons: Polypropylene

Acceptance Inspection

After the device has been delivered, check the delivery immediately for:

- completeness,
- possible damage.

If components are missing or damage is found on the device or the packaging, in particular damage caused by humidity and/or water, please notify the carrier as well as Thermo Scientific Technical Support immediately.

	 WARNING	Risk of injury
<p>Should sharp edges have formed in damaged areas or elsewhere on the device, take all necessary precautions to protect personnel handling the incubator. For example, have them wear protective gloves and other personal protection equipment.</p>		

Scope of Supply

Incubators

Quantity of components supplied (pieces)	IMH Series IMH-S Series
Perforated shelves	2
Support rail for shelf table-top units	2
Shelf support	4
Power cord	1
Connector, potential-free contact	1
Clip springs for table-top units	2
Plug	1
Anti-tilt anchor	1
Operating manual	1
Short reference guide	1

Installation

Ambient Conditions

Location Requirements

Built-in units of incubators can, heating and drying ovens must be operated with an air exhaust system and exhaust hose (only original Thermo accessory should be used).

For safety reasons, the installation space should be made of non-combustible materials, according to DIN 4102.





NOTE

During installation of built-in units, ensure that the escaping air will be safely discharged out of the installation space.

The incubator must only be operated in a location that meets all of the ambient condition requirements listed below:

- Installation location indoors in dry areas free from drafts.
- The dust burden may not exceed the contamination category 2 based on EN 61010-1. Using the incubator in an atmosphere with electrically conductive dust is prohibited.
- The minimal distance to adjacent surfaces must be observed on all sides (see section “Space Requirement” on page 3-3).
- The operating room must be equipped with appropriate ventilation.
- Solid, level, fire-proof surface; no flammable materials opposite to the rear panel of the incubator.
- Vibration-proof substructure (floor stand, lab table) capable of bearing the dead weight of the incubator and its accessories (in particular when stacking the table-top units).
- The electrical circuitry of the incubator has been designed for an operating height of up to 2000 m above sea level.
- Relative humidity up to 80% (maximum; preferably 60-70%), non condensing.
- Condensation must be avoided - for example, after moving or transporting the device. Should condensation exist, wait until the moisture has evaporated completely before connecting the incubator to a power source and powering up.
- The ambient temperature must be within a range of +18 °C to +32 °C (64.4 °F to 89.6 °F).

- Avoid direct exposure to sunlight.
- Devices that produce excessive amounts of heat must not be placed near the incubator.
- Place the incubator on a floor stand (option; to be ordered separately), never on the lab floor. This prevents the penetration of dust or dirt into the device.
- Power line voltage variations must not exceed $\pm 10\%$ of the nominal voltage.
- Transient surges must lie within the range of levels that normally occur in the power supply system. The impulse withstand voltage based on surge category II of IEC 60364-4-443 shall be applied at the nominal voltage level.
- Consider installing one dedicated upstream circuit breaker per incubator to avoid multiple device failures in case of an electrical fault.

	<table border="1"><tr><td data-bbox="526 739 901 840"> WARNING</td><td data-bbox="933 795 1252 828">Contamination hazard</td></tr><tr><td colspan="2" data-bbox="518 862 1436 1030">Do not place the incubator directly on the lab floor, but mount it on the floor stand or on a lab work surface (option; to be ordered separately). Contaminants, such as bacteria, viruses, fungi, prions, and other biological substances may use the open door to migrate easily from the floor into the incubator's work space.</td></tr></table>	 WARNING	Contamination hazard	Do not place the incubator directly on the lab floor, but mount it on the floor stand or on a lab work surface (option; to be ordered separately). Contaminants, such as bacteria, viruses, fungi, prions, and other biological substances may use the open door to migrate easily from the floor into the incubator's work space.	
 WARNING	Contamination hazard				
Do not place the incubator directly on the lab floor, but mount it on the floor stand or on a lab work surface (option; to be ordered separately). Contaminants, such as bacteria, viruses, fungi, prions, and other biological substances may use the open door to migrate easily from the floor into the incubator's work space.					

Intermediate Storage

When the incubator is placed in intermediate storage, which is permissible for a maximum of four weeks, make sure that the ambient temperature is between 20 °C to 60 °C (68 °F to 140 °F) and the maximum relative humidity does not exceed 90%, non-condensing.

Room Ventilation

Heat dissipating from the incubator during continuous operation may cause a change in the room climate.

- Therefore, the incubator must only be installed in rooms with sufficient ventilation.
- Do not install the incubator in room recesses without ventilation.
- When several devices are to be placed in the same room, additional ventilation may have to be provided as necessary.
- To avoid any impact of the heat dissipated by the incubator on the ambient climate the room must be vented by means of a laboratory-grade ventilation system that complies with applicable local and national health and safety regulations and has sufficient capacity.
- If excessive temperatures tend to occur in the operating room, be sure to provide a thermal protection means that cuts out the power supply to mitigate the impact of overtemperature scenarios.

Space Requirement

For built-in units following clearances should be kept:

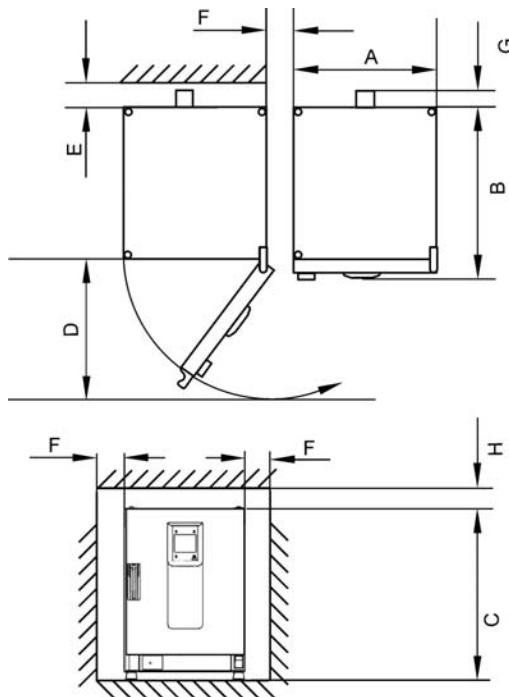

A, B, C and D see Operating Instructions of the unit.

E (mm/inch)	F (mm/inch)	G (mm/inch)	H (mm/inch)
100 / 4	50 / 2	80 / 3.2	30 / 1.2

Installation Built-in Units

IGS	Clearances, as Fig. 3, without exhaust hose.
IMH/IMH-S	Clearances, as Fig. 3, close air port with plug, supplied with the unit.
OGS/OMS	Clearances, as Fig. 3, with additional space to operate to air slide, with air exhaust system and exhaust hose Ø 40 mm (1.58 in)/1.5 m (59 in) (original Thermo accessory), shortened to required length, installed according to Fig. 1 and 2.
OGH/OGH-S OMH/OMH-S	Clearances, as Fig. 3, with air exhaust system and exhaust hose Ø 40 mm (1.58 in)/1.5 m (59 in) (original Thermo accessory), shortened to required length, installed according to Fig. 1 and 2, operating temperature up to max. 250 °C (482 °F).



After connecting the built-in unit to the electrical power supply, avoid damaging the power cord, then sliding into the installation position.

When installing the incubator, make sure that the installation and supply connections remain freely accessible.

The specified side clearances represent minimum distances.

Table-top units

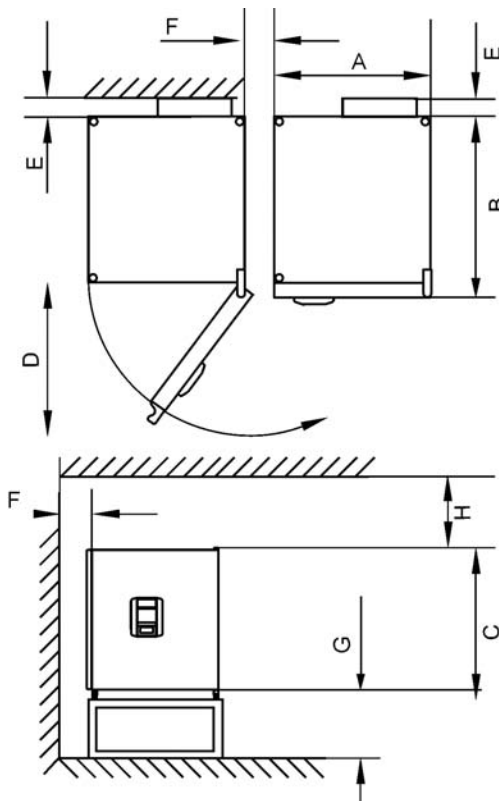

Figure 3-1 Table-top incubators, dimensions and required clearances

Table 3-1 Incubator Dimensions

Model	A (mm)	B (mm)	C (mm)	D (mm)
IMH 60	530/20.1	565/22.2	720/28.3	540/21.3
IMH 100	640/25.2	565/22.2	820/32.3	650/25.6
IMH 180	640/25.2	738/29.1	920/36.2	650/25.6
IMH 60-S	530/20.1	565/22.2	720/28.3	540/21.3
IMH 100-S	640/25.2	565/22.2	820/32.3	650/25.6
IMH 180-S	640/25.2	738/29.1	920/36.2	650/25.6

* Depth of handle /display (66 mm/2.6 in) not included in overall depth specified; height of adjustable feet (36 mm/1.4 in) not included in overall height specified.

Table 3-2 Required Clearances

E (mm)	F (mm)	G (mm)	H (mm)
80/3.1	50/2.0	200/7.9	300/11.8

Floor stand units

400 liter units

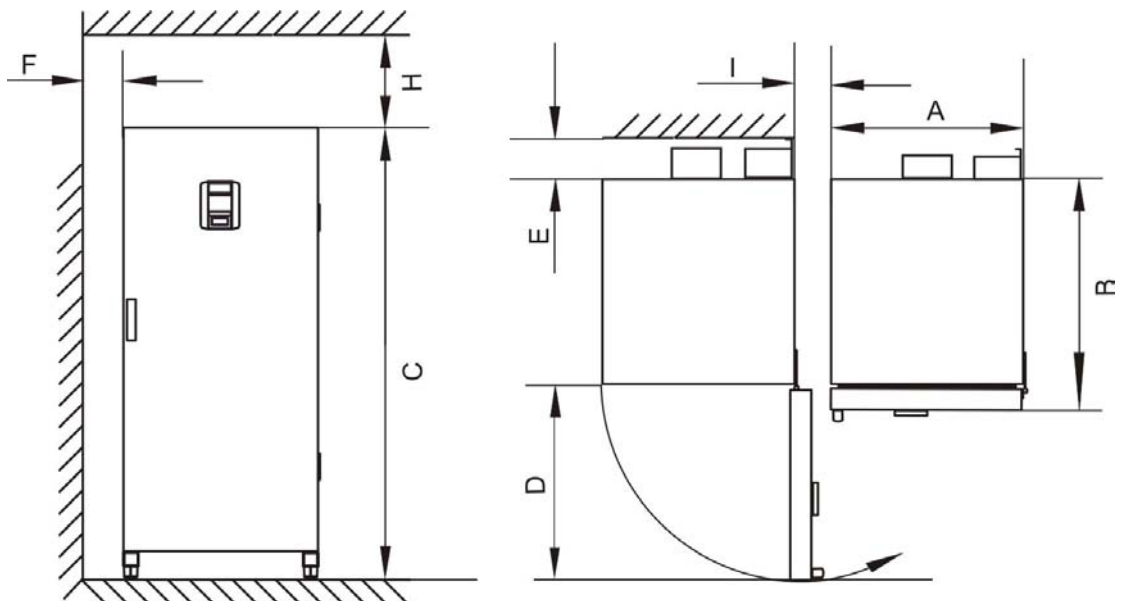

Figure 3-2 Floor stand incubators, dimensions and required clearances

Table 3-3 Incubator dimensions

Model	A (mm/inch)	B (mm/inch)	C (mm/inch)	D (mm/inch)
IMH 400-S	755/29.7	770/30.3	1655/65.2	810/31.9

* Depth of handle /display (66 mm/2.6 in) not included in overall depth specified. The width of the hinge (23 mm) is not included in the overall width.

Table 3-4 Required Clearances

E (mm)	F (mm)	H (mm)	I (mm)
120/4.7	50 / 2	200 / 8	200/7.9

750 liter units

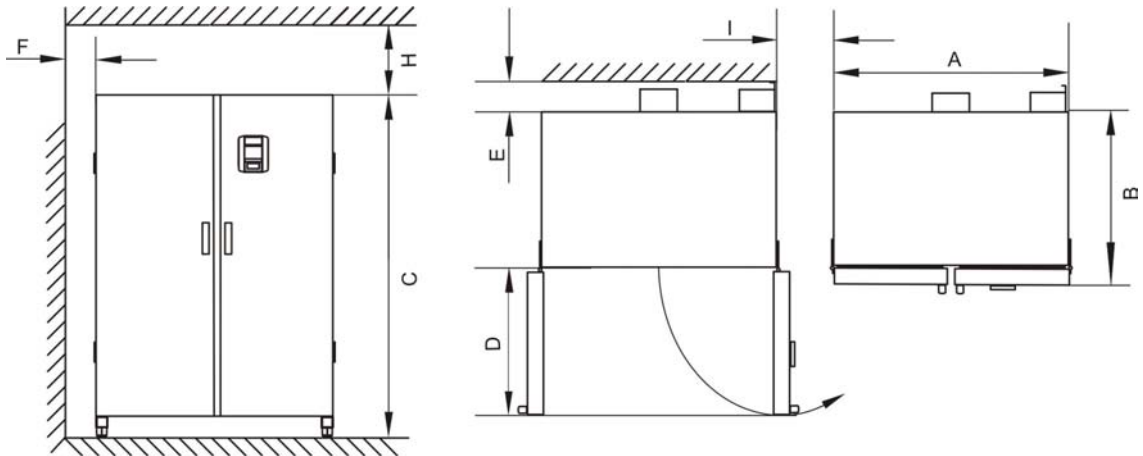

Figure 3-3 Floor stand incubators, dimensions and required clearances

Table 3-5 Incubator dimensions

Model	A (mm/inch)	B (mm/inch)	C (mm/inch)	D (mm/inch)
IMH 750-S	1215 / 47.8	770/30.3	1655/65.2	670/26.4

* Depth of handle /display (66 mm/2.6 in) not included in overall depth specified. The width of the hinge (23 mm) is not included in the overall width.

Table 3-6 Required clearances

E (mm/inch)	F (mm/inch)	H (mm/inch)	I (mm/inch)
120/4.7	50/2.0	200/7.9	350/13.8

Transport

Table-top units

For transport, do not lift the incubator using the doors or components attached to the incubator as lift points.

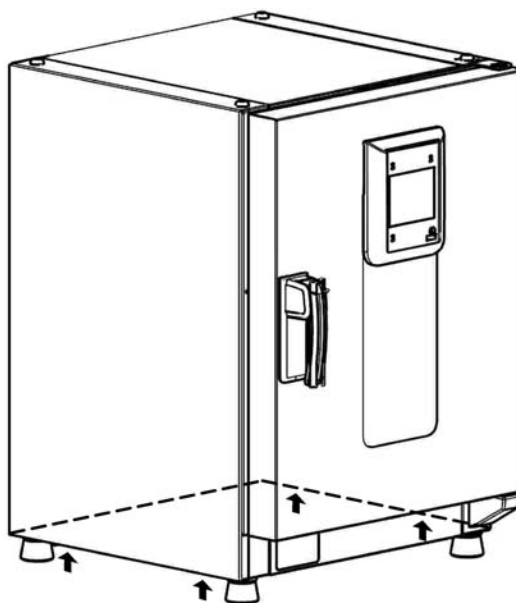

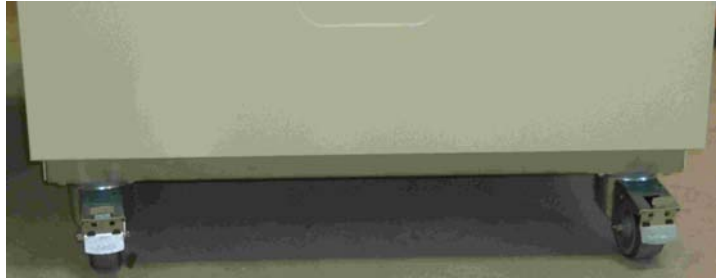

Figure 3-4 Lift Points

		<p>Heavy loads! Lift with care!</p> <p>To avoid injury through physical strain, such as strain traumata and slipped discs, do not attempt to lift the incubator alone!</p> <p>To avoid injury through dropped loads, be sure to wear Personal Protection Equipment, such as safety shoes, when lifting the incubator.</p> <p>To avoid crushing your fingers or hands (particularly in a closing door) or damaging the incubator, do not use any other lift points than those indicated in the illustration above.</p>
--	---	--

Floor stand units



The floor stand units come equipped with four (4) casters. The lever for releasing the caster is located above the locking lever. After positioning the unit in its installation location ensure that the locking levers are pressed down on the casters.

To ensure the degree of stability specified by safety requirements the front casters must be turned so that they are facing forward after the unit has been positioned in its installation location and the locking levers pressed down on these casters.

		Danger of tipping when moving!
<p>Before moving the unit, ensure that it has been unplugged.</p> <p>Move the Heratherm floor stand units with caution.</p> <p>Quick starts and stops can result in tipping!</p> <p>Always ensure that the doors are closed when moving the unit.</p>		

Stacking Kit

The stacking adapter is available only for table-top units.

Material Number	Description
50126665	Stacking adapter Heratherm 60L
50126666	Stacking adapter Heratherm 100L
50126667	Stacking adapter Heratherm 180L

Scope of Delivery:

- 1 stacking adapter
- 1 anti-tilt anchor
- 1 plastic bag with 2 stacking feet and 2 M4x16 Torx screws.

Required Tools:

Slotted screwdriver 5,5x100 or Torx screwdriver 20x100.

Installing the Stacking Feet

Remove the left and right blank plugs at the top blank.

Install the stacking feet with the enclosed screws using a slotted or Torx screwdriver.

Installing the Stacking Adapter

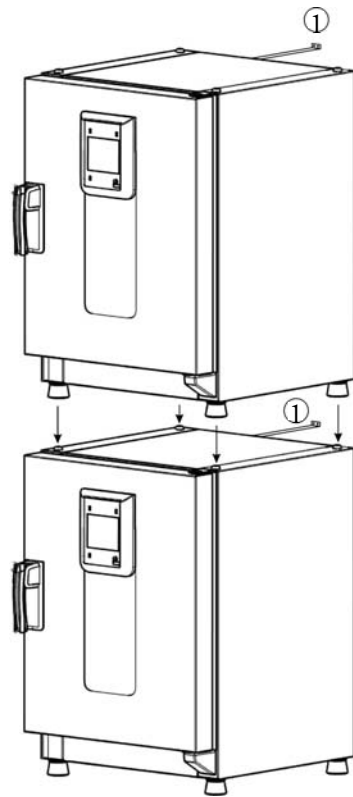

1	Anti-tilt anchor
---	------------------

Stack as follows when using a stacking adapter (numbers denote incubator volumes in liters):

- for 60 l or 100 l on 180 l use stacking adapter Heratherm 180L,
- for on 100: use stacking adapter Heratherm100L.

To prevent the top device from slipping and dropping down, the following requirements must be fulfilled before devices may be stacked:

- Only two units may be stacked together. When stacking devices with the same type of enclosure, yet with a different footprint the device with the smaller footprint must be placed on top of the one with the larger footprint at all times.
- The bottom device must be correctly levelled.
- Be sure to use the appropriate stacking adapter.
- The levelling feet on the top device must be screwed in all the way.
- The levelling feet of the top device must be aligned with and placed exactly on the stacking pads of the stacking adapter.
- The anti-tilt anchor must be installed on the top device.

Installing the Anti-tilt Anchor

Table-top units

The anti-tilt anchor secures the top device in a stack to a solid part of a building. The anti-tilt anchor is to be mounted on the side opposite of the door hinges.

Bend the fixing tabs of the anti-tilt anchor up on one side and down on the other by an angle of approx. 90°.

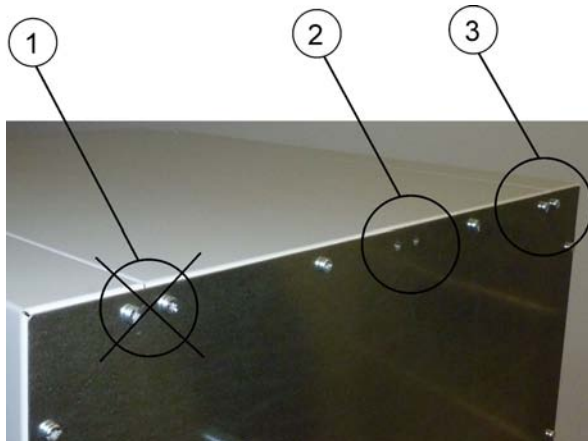

1. Do not use this position if the door is hinged on this side. Right-hand hinges represent the standard configuration.
2. Preferred position.
3. Alternative position. Do not use if the door is hinged on this side.

Remove the bracket screws. Use the preferred position, if possible.

Fix the anti-tilt anchor with the bracket side down to the unit (see figure).

Position the unit with the anti-tilt anchor to in an angle of approx. 90° +/- 20%.

Take care that the stacking feet of the unit are still in correct place on the lower unit or on the stacking adapter.

Fix the anti-tilt anchor to a solid part of the building.

Floor stand units

NOTE

Heratherm floor stand units must always be attached to the wall using two (2) retaining brackets on the outer left and right side on the back of the unit.



Remove the screws.

Attach the end of the retaining bracket that is facing downward to the unit.

Align the device at roughly 90°, +/-20° to the retaining bracket.

Affix the retaining bracket to the wall.





Unsafe part of the building!

Install the anti-tilt anchor to a solid part of the building, which is able for shoring loads.

The installation has to be carried out by qualified personnel only.

The connection to the building must be carried out with appropriate screws and dowels according to the consistence of the building part.

Additionally, the following caution notes must be heeded at all times:

	 <p>Risk of overheating with stacked devices</p> <p>To avoid the risk of electrical components and the outer enclosure overheating or temperature control failing due to insufficient ventilation, do not exceed the specified stacking height!</p>
	 <p>Risk of tipping and dropping of stacked devices</p> <p>You should be aware at all times that stacked devices do not form a stable unit, even when the stacking pads and frames are used correctly. The top device may tip over and drop down when being transported in a stack. To avoid injury to persons and damage to equipment, do not attempt to move stacked devices as a unit! Separate and move each device one by one, then restack them.</p> <p>Thermo Scientific accepts no responsibility or liability whatsoever with regard to stacked third party devices; this is at the user's own risk.</p>

Floor stand unit spacers

The spacer on the electrical module must be pulled out and fixed in place before installing the floor stand unit at its installation location.



- 1 Loosen the 2 screws
- 2 Pull out the spacer and slide the screws into the recesses
- 3 Tighten the two screws

Installation
Floor stand unit spacers

Product Description

This section describes Heratherm advanced protocol microbiological incubators for high-end laboratory applications, which are available in two different versions distinguished by safety level:

- Heratherm IMH Series advanced protocol microbiological fan convection incubators (see “[Heratherm IMH Series Incubator Overview](#)” on [page 4-1](#));
- Heratherm IMH-S Series advanced protocol security microbiological fan convection incubator for more exacting safety level requirements (see “[Heratherm IMH-S Incubator Overview](#)” on [page 4-4](#)).

Heratherm IMH Series Incubator Overview

IMH Series advanced protocol microbiological incubators come equipped with the following features:

- high-precision work space temperature control, adjustable in steps of one-tenth of a degree up to 105°C (221°F)
- a variable-speed work space fan, adjustable on the control panel

	NOTE	At high ambient temperatures the maximum speed is reduced.
--	-------------	--

- countdown, fixed-time, and weekly timers for timed process control
- two perforated shelves
- an access port for tubing, sensor leads, etc.

Product Description
Heratherm IMH Series Incubator Overview

The individual features of IMH Series incubators are shown in the figures below.

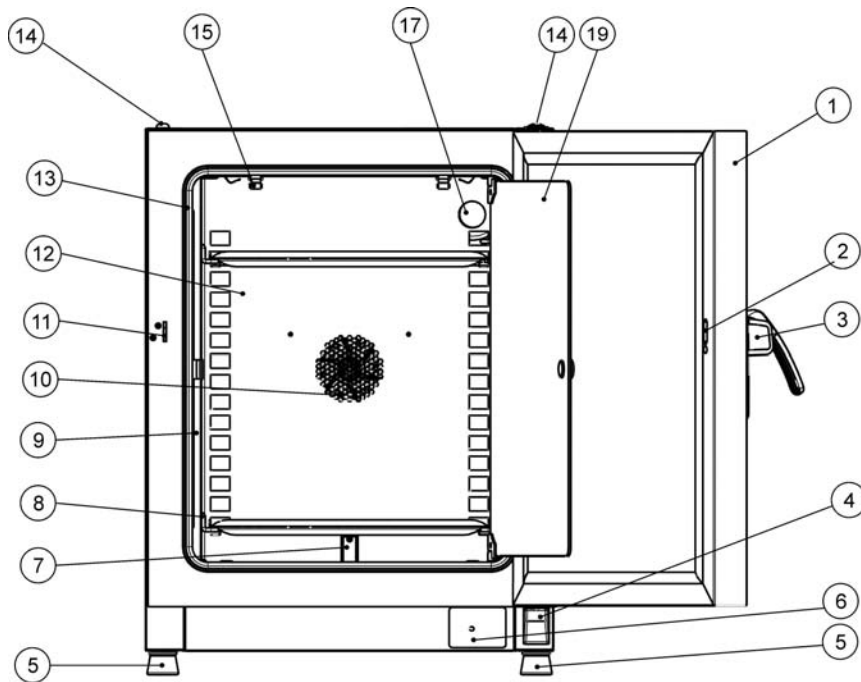

Figure 4-1 Heratherm IMH 60/ IMH 100/ IMH 180 Front View

- [1] Outer door
- [2] Door latch cutout
- [3] Door latch and handle
- [4] Door hinge, lower
- [5] Levelling foot
- [6] Nameplate
- [7] Temperature sensor
- [8] Support rail for perforated shelf
- [9] Shelf support
- [10] Fan opening, air baffle
- [11] Door hook catch
- [12] Air baffle
- [13] Door seal
- [14] Stacking pad
- [15] Spring
- [16] -
- [17] Access port
- [18] -
- [19] Glass door

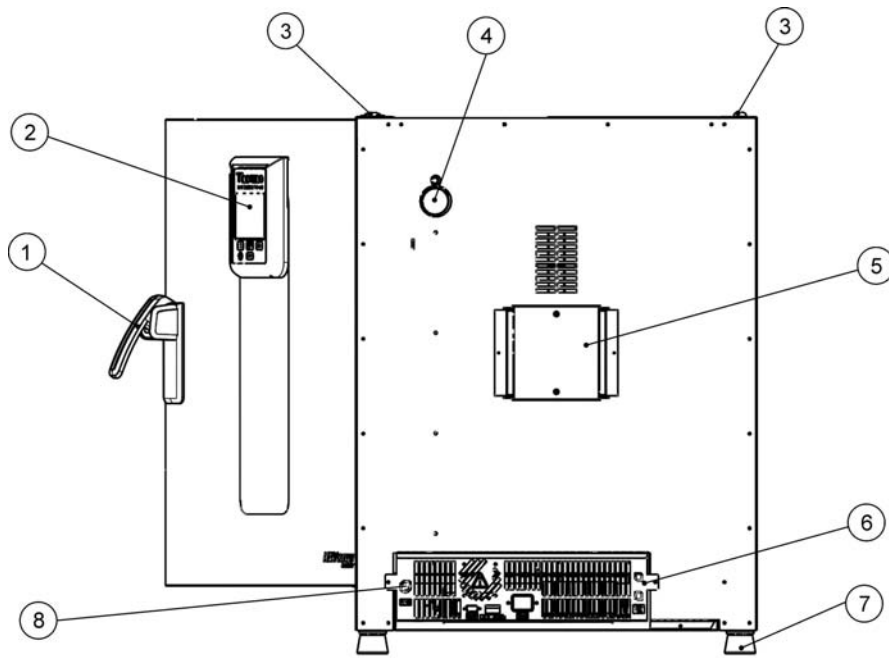

Figure 4-2 Heratherm IMH 60/ IMH 100/ IMH 180 Rear View

- [1] Door latch and handle
- [2] Control panel
- [3] Stacking pad
- [4] Access port
- [5] Fan
- [6] Electronics compartment
- [7] Levelling foot
- [8] Sample sensor connection (IMH-S only)

Heratherm IMH-S Incubator Overview

IMH-S Series advanced protocol security microbiological mechanical convection incubators come equipped with the features also found in IMH Series devices, including:

- high-precision work space temperature control, adjustable in steps of one-tenth of a degree up to 105°C (221°F)
- a variable-speed work space fan, adjustable on the control panel

	NOTE	At high ambient temperatures the maximum speed is reduced.
--	-------------	--

- countdown, fixed-time, and weekly timers for timed process control
- two perforated shelves for sample containers
- an access port for tubing, sensor leads, etc.

Additionally, IMH-S Series incubators offer the following extra functionality:

- Monitoring of lower temperature
- Connection for Acceptable temperature sensor (accessory, must be ordered separately)
- a lockable door to secure a running process against unauthorized access
- door switch and indicator on the control panel to indicate that the door is open
- a built-in, fully automatic decontamination routine

The individual features of IMH-S Series incubators are shown in [figure 4-3](#) and [figure 4-4](#) below.

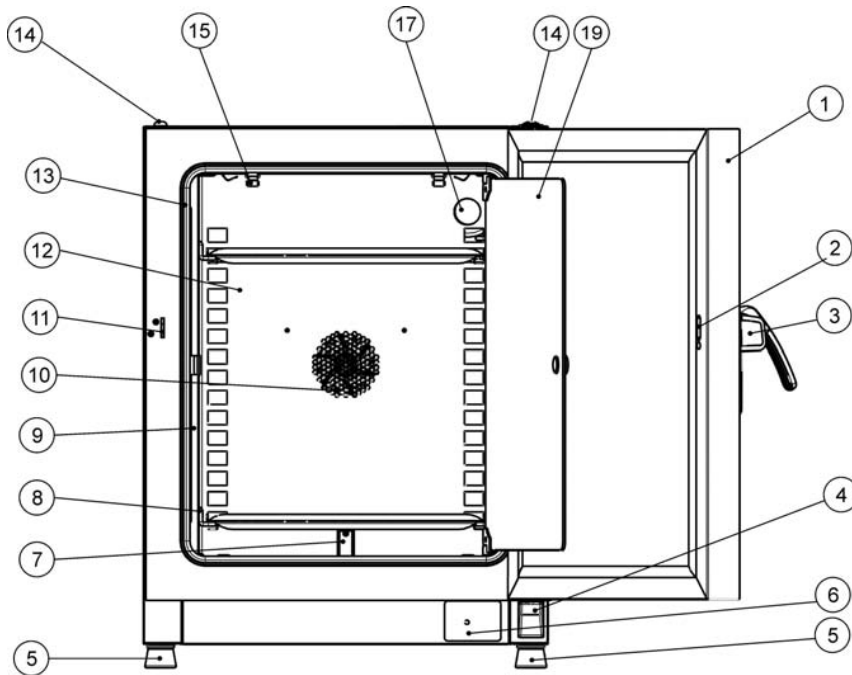

Figure 4-3 Heratherm IMH 60-S/ IMH 100-S/ IMH 180-S Series Front View

- [1] Outer door
- [2] Door switch
- [3] Door latch and handle, with lock
- [4] Door hinge, lower
- [5] Levelling foot
- [6] Nameplate
- [7] Temperature sensor
- [8] Support rail for perforated shelf
- [9] Shelf support
- [10] Fan opening, air baffle
- [11] Door hook catch
- [12] Air baffle
- [13] Door seal
- [14] Stacking pad
- [15] Spring
- [16] -
- [17] Access port
- [18] -
- [19] Glass door

Product Description
Heratherm IMH-S Incubator Overview

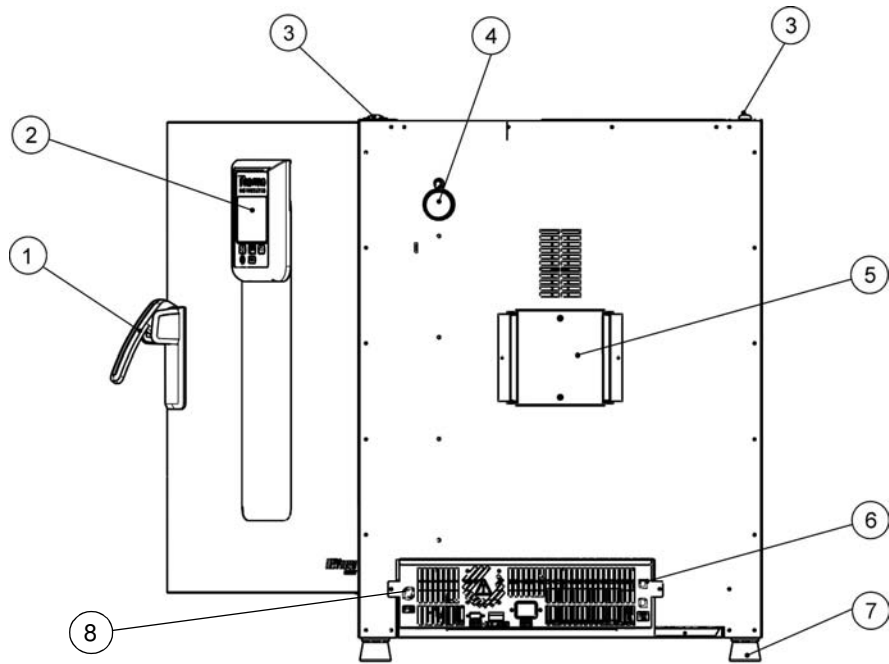

Figure 4-4 Heratherm IMH 60-S / IMH 100-S / IMH 180-S Series Rear View

- [1] Door latch and handle
- [2] Control panel
- [3] Stacking pad
- [4] Access port
- [5] Fan
- [6] Electronics compartment
- [7] Levelling foot
- [8] Sample Sensor connection

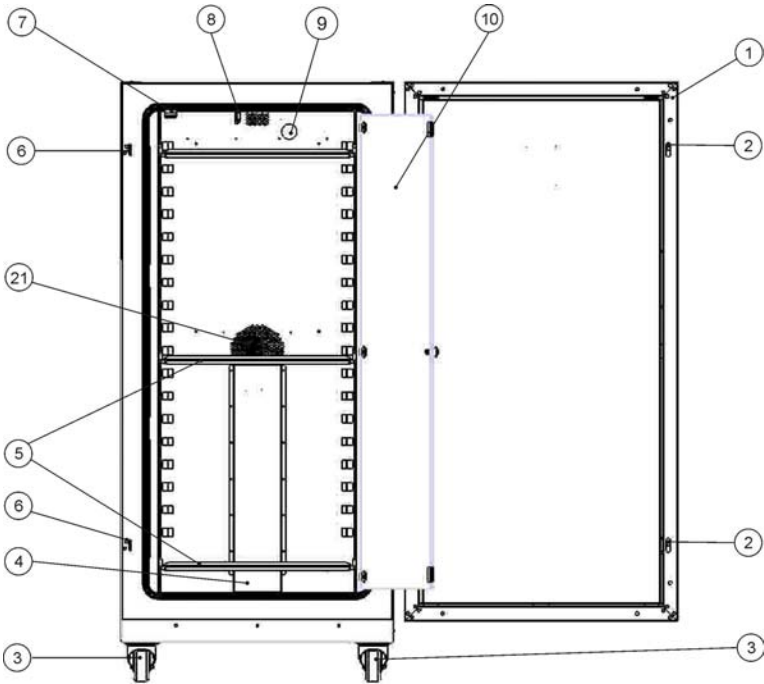

Figure 4-5 Heratherm IMH 400-S Series Front View

- [1] Outer door
- [2] Door latch
- [3] Unit caster
- [4] Air baffle
- [5] Perforated shelf
- [6] Door hook catch
- [7] Glass door latch
- [8] Temperature sensor
- [9] Access port
- [10] Glass door
- [11] -
- [12] -
- [13] -
- [14] -
- [15] -
- [16] -
- [17] -
- [18] -
- [19] -
- [20] -
- [21] Fan opening, air baffle

Product Description
Heratherm IMH-S Incubator Overview

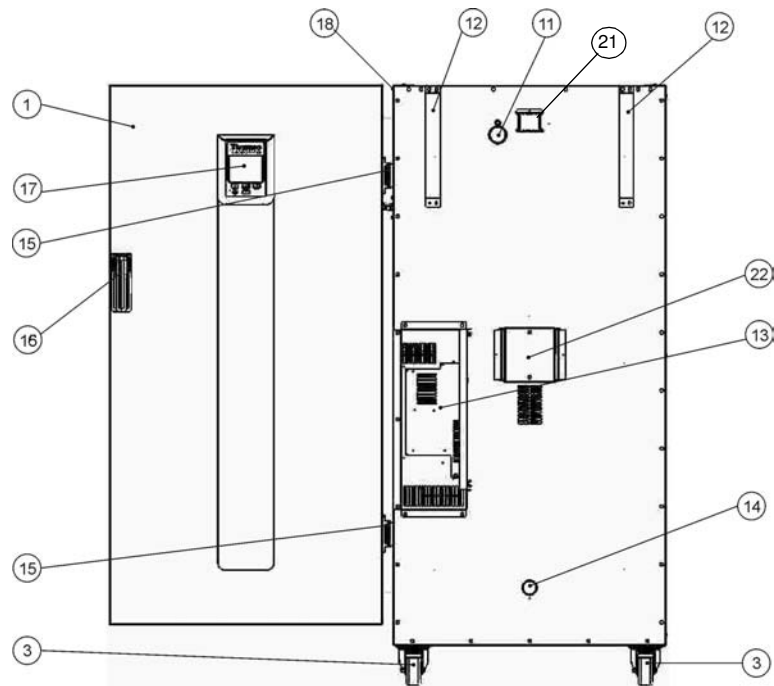

Figure 4-6 Heratherm IMH 400-S Rear View

- [1] Outer door
- [2] -
- [3] Unit caster
- [4] -
- [5] -
- [6] -
- [7] -
- [8] -
- [9] -
- [10] -
- [11] Access port
- [12] Anti-tilt anchor
- [13] Electronics compartment
- [14] Inlet air tube
- [15] Hinge
- [16] Door handle
- [17] Display
- [18] Nameplate on sidewall
- [19] -
- [20] -
- [21] Exhaust air tube
- [22] Fan

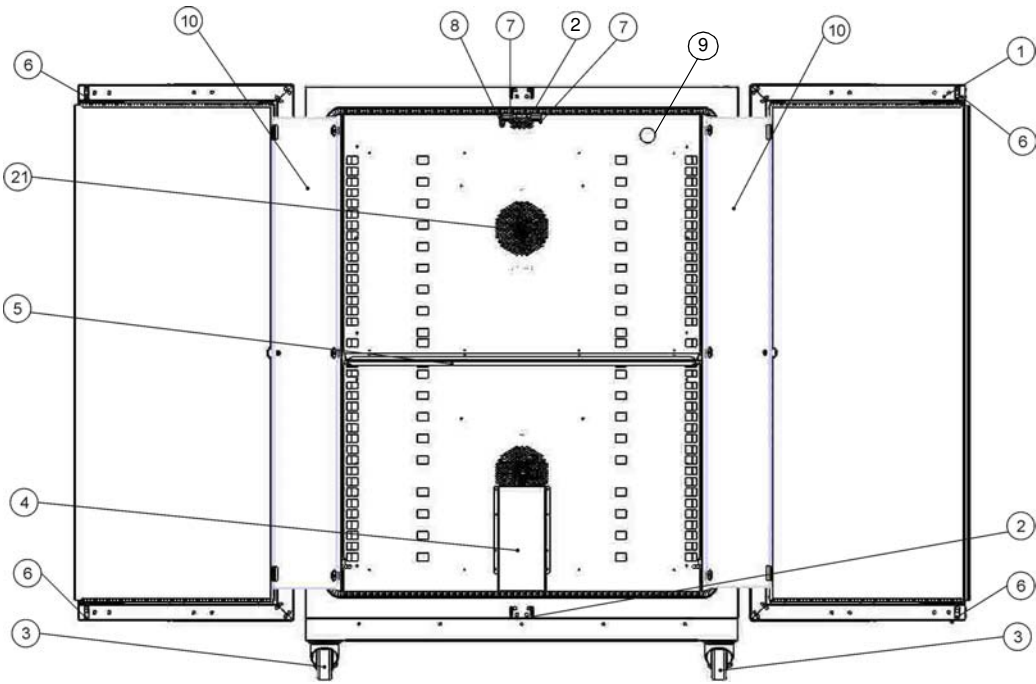

Figure 4-7 Heratherm IMH 750-S Front View

- [1] Outer door
- [2] Door hook catch
- [3] Unit casters
- [4] Air baffle
- [5] Perforated shelf
- [6] Door latch
- [7] Glass door latch
- [8] Temperature sensor
- [9] Access port
- [10] Glass door
- [11] -
- [12] -
- [13] -
- [14] -
- [15] -
- [16] -
- [17] -
- [18] -
- [19] -
- [20] -
- [21] Fan opening, air baffle

Product Description
Heratherm IMH-S Incubator Overview

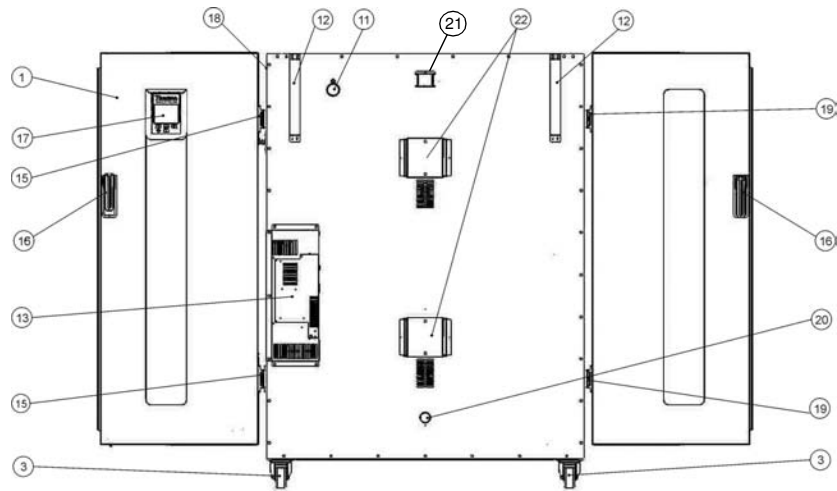

Figure 4-8 Heratherm IMH 750-S Rear View

- [1] Outer door
- [2] -
- [3] Unit caster
- [4] -
- [5] -
- [6] -
- [7] -
- [8] -
- [9] -
- [10] -
- [11] Access port
- [12] Anti-tilt anchor
- [13] Electronics compartment
- [14] -
- [15] Hinge, right
- [16] Door handle
- [17] Display
- [18] Nameplate on sidewall
- [19] Hinge, left
- [20] Inlet air tube
- [21] Exhaust air tube
- [22] Fan

Safety Devices

The incubators are equipped with the following safety features:

- a sample protection feature that safeguards the samples against destruction through overheating in case of controller failure;
- an overheat protection cut-out feature that shuts down the incubators IMH-S completely when excessive temperatures occur in the workspace;
- an alarm relay that is energized, along with audible and visual alarms, to indicate errors encountered during operation;
- dual fuses rated at 16 amperes.

Work Space Atmosphere

To ensure undisturbed operation, the ambient temperature in the operating room must be at least 18 °C (64.4 °F).

The heating system uses this temperature threshold to control the ambient temperature plus 5 °C (41 °F) up to the maximum of 105 °C (221 °F).

Door switch

Heratherm IMH 60/100/180/400/750 S incubators come with a door switch [1] integrated into the latch mechanism. If the door switch is activated by opening the door, heating operations in the work space are suspended and an icon is illuminated in the display window (see D4 in [figure 7-1](#) on [page 7-1](#)).

If the door remains open for more than 30 seconds, a short audible alarm is sounded in addition to the icon in the display window. If the door is left open for more than 10 minutes, an audible alarm is sounded, a “door open” (E001) alarm message appears in the display and is issued through the RS-232 interface, and the alarm relay is energized.

Sensing and Control System

The PT 100-type sensor for the control of the work space temperature and for the thermal protection [1] is installed on the bottom of table-top units and in the top of floor stand units.

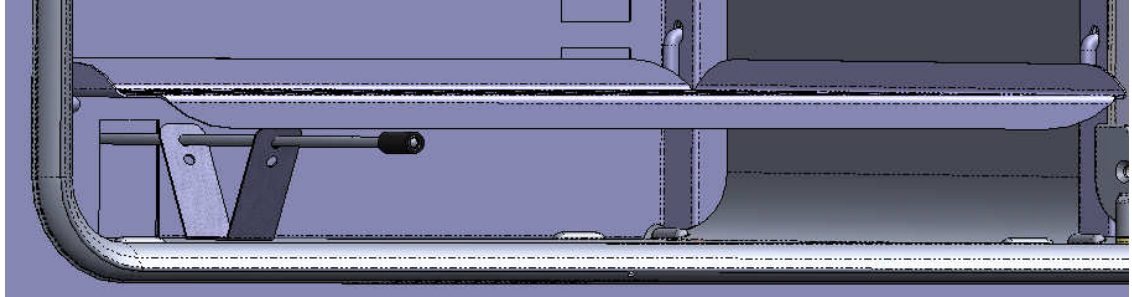

Figure 4-9 Sensor System (for table-top units)

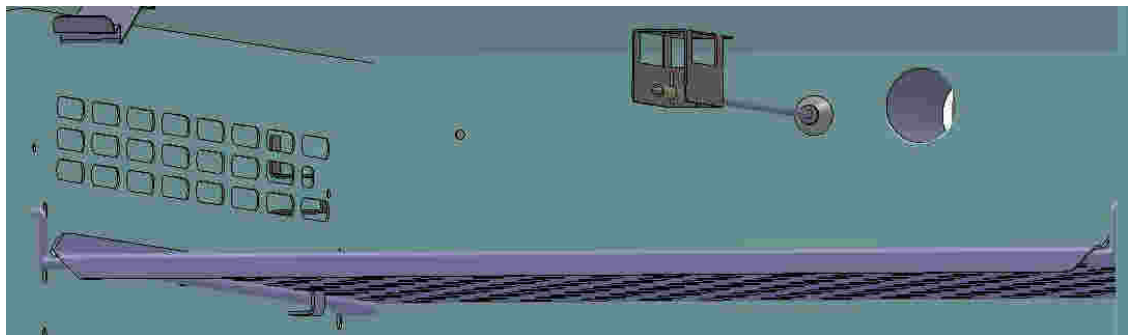

Figure 4-10 Sensor System (for floor stand units)

The work space temperature sensor provides the inputs to the incubator's built-in controller, which continuously compares the measured values to the user-specified set value and adjusts the heaters according to the result.

NOTE
Do not remove the protective hose from the sensor. Protect the sensor from mechanical damage.

The unit features a thermal protection function that is factory-preprogrammed and not adjustable. It protects the samples in the work space from overheating: Thermal protection kicks in on a brief violation of the upper limit, based on the defined setpoint temperature, at between 2 and 3 °C (35.6 °F and 37.4 °F) (37 °C (99 °F): 2 °C (35.6 °F), > 50 °C (122 °F): automatically reducing the work space temperature to the user-specified set value and allowing the incubation process to be continued even in case of a controller malfunction. If the thermal protection is activated, the error message (E111) "Temperature too high" appears in the display window and an audible alarm is sounded.

When the user acknowledges the error message, the red alarm icon (D4 in [figure 7-1](#) on [page 7-1](#)) is illuminated and the Temperature Set Value icon (see [table 7-3](#) on [page 7-4](#)) is highlighted by a red border to indicate that thermal protection has kicked in.

Data Communications & Alarm Interface

All signal connections are installed in the electrical interface panel at the rear of the incubator.

RS 232 interface

The RS- 232 interface (item 1 in [figure 4-11](#) below) may be used to connect Heratherm incubators to the serial interface port of a computer to allow for the computer-aided acquisition and documentation of major operating parameters (temperature, error codes, etc.).

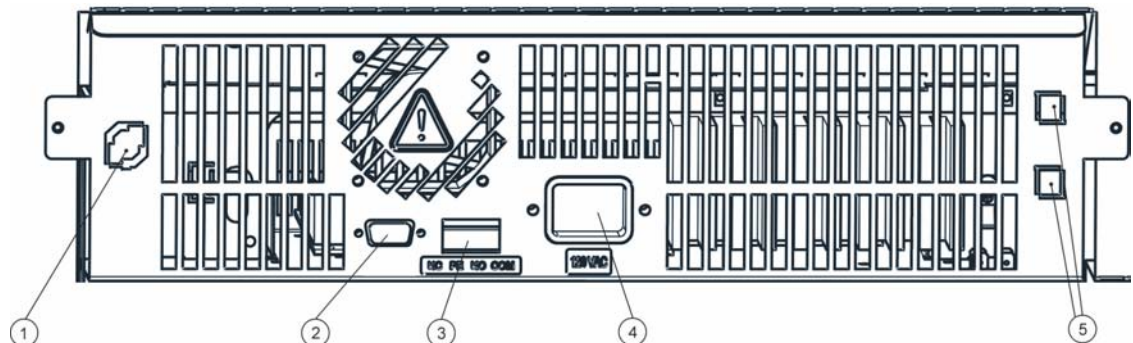

- [1] Sample Sensor (only with IMH 60/100/180/400/750-S)
- [2] RS 232 interface
- [3] Alarm contact
- [4] Power socket
- [5] 2 fuses 2 A, for socket and lamp (nur bei US-Tischgeräten)

Figure 4-11 Signal Interfaces and Power Socket

Alarm contact

The incubator can be connected to an on-site, external alarm system (such as a private branch telephone exchange, a facility monitoring system, visual or audible alarm indicators). For this purpose, the devices come with a pre-wired potential-free alarm contact (item 2 in [figure 4-11](#)). The alarm contact is energized whenever an error occurs in an internal control loop or the incubator's electrical circuits or hardware (see [chapter 12, "Error Codes."](#)).

Mains connection

The incubator is connected to the AC supply mains via the socket (item 3 in [figure 4-11](#)), which accepts a power cord with an IEC standard plug).

Fuses

Two 16 A slow-blow fuses mounted on the incubator's main electronic circuit board protect internal circuitry from the impact of excessive power consumption.

	<p>NOTE</p> <p>Replacement should only be carried out by skilled and authorized qualified personnel of electrotechnology/signal engineering!</p>
--	--

	<p>NOTE</p> <p>Fuse replacement</p> <p>The device fuses are not user-serviceable. When the incubator exhibits the typical signs of a blown fuse (no response to pressing the On/Off button, control panel remains extinguished, no heating operation), call Thermo Fisher Scientific Customer Service to have the fuses replaced.</p>
--	---

Work Space Components

Inner Chamber

All components of the work space are made of corrosion-resistant stainless steel and have an absolutely smooth and easy-to-clean surface. Any embossings have a large radius.

Connecting Nozzles for Fresh-air Filters (Accessory Items)

Observe the following note for IMH Series and IMH-S Series incubators with connecting nozzles for fresh-air filters (accessory item).

	<p>NOTE</p> <p>Connecting nozzle for fresh-air filters</p> <p>The connecting nozzle for the fresh-air filter (accessory item) may neither be extended with nor be diverted through other tubing.</p>
--	--

A fresh-air filter can be attached to the connecting nozzle. After puncturing the plastic cap the fresh-air filter can be screwed onto the nozzle.

The connecting nozzle can be closed off using the 1/8" closure plug delivered with the unit after opening the plastic cap.

The connecting nozzle for the Heratherm IMH 60/100/180 and IMH 60-S/100-S/180-S incubators has a G 1/8" threaded fitting.

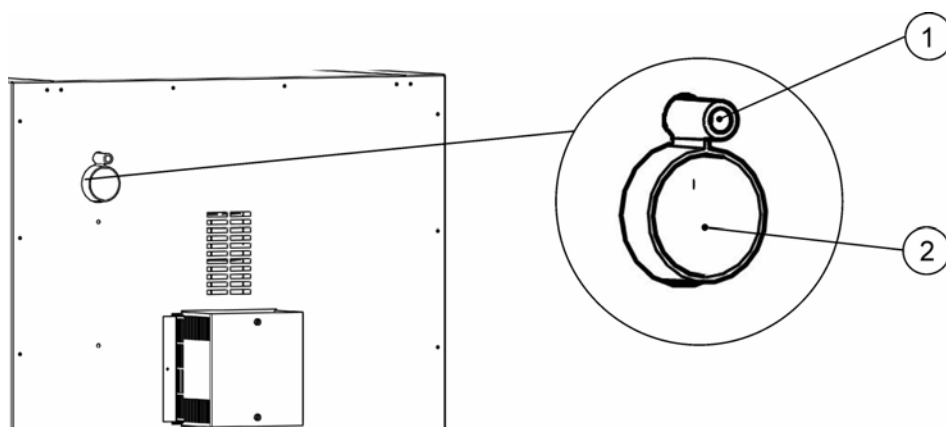

Figure 4-12 Connecting Nozzles for Fresh-air Filters (Accessory Items)

Access port

A re-sealable, capped access port (can be closed off using the plugs delivered with the unit) (Heratherm IMH 60/100/180 and IMH 60-S/100-S/180-S/400-S/750-S only) allows cables, hoses or additional sensor leads to be routed into the work space of the incubator.

The access port [2] has a diameter of 42 mm.

NOTE	<p>Operating conditions</p> <p>When accessories are to be operated in the work space of the incubator, the ambient condition requirements must be observed (see table below). The energy introduced into the work space has an impact on the lower end of the temperature control range. When additional heating sources are introduced into the work space, temperature control may be adversely affected.</p>
-------------	--

Shelf System

The incubator is supplied with two perforated shelves. The shelf support rails [1] have an alternating pattern of oblong and round perforations spaced evenly at 30 mm, allowing the shelf support [8] to be inserted without any room for error, yet in a very flexible way to accommodate any required height of sample container. The shelves [2] have an integrated tilt protection and pull-out stop. For details on using the shelf system, see [“Installation procedures”](#) on page 5-1.

Product Description
Work Space Components

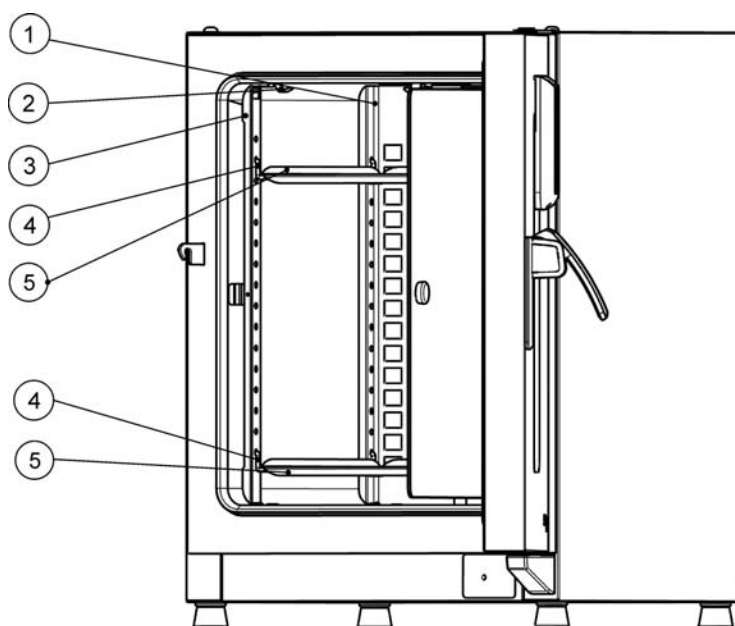

- [1] Air baffles
- [2] Retaining Springs (only for table-top units)
- [3] Support rails
- [4] Shelf support
- [5] Perforated plates

Figure 4-13 Shelf System

Tube Access Ports

Heratherm incubators may be equipped with additional tube access ports in the side and top panels.

Available tube access port options are listed in [table 4-1](#) below.

Table 4-1 Tube Access Ports for Heratherm Incubators (Option)

Model	Side Panel Mounted Port, dia. in mm/inch	Top Panel Mounted Port, dia. in mm/inch
IMH and IMH-S	24/0.95 or 58/2.28	24/0.95 or 58/2.28

The tube access ports are mounted in fixed locations in the side and top panels (see [figure 4-14](#)).

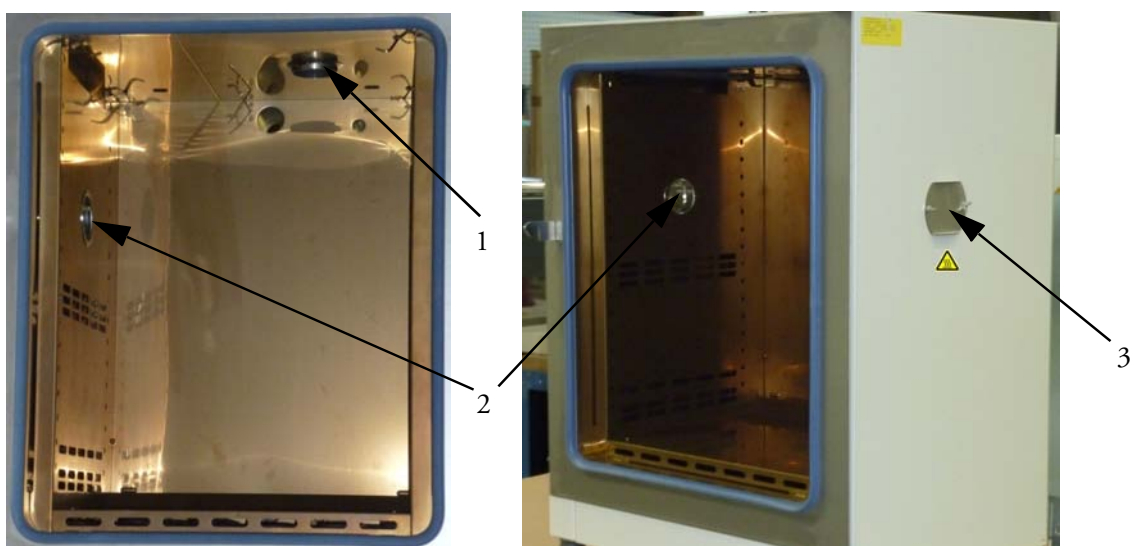



Figure 4-14 Tube Access Ports

- [1] Top panel mounted tube access port
- [2] Side panel mounted tube access port
- [3] Sealing cap for side panel mounted tube access port

Once the cables, tubes or other conduits have been inserted, the tube access ports must be padded with the heat-resistant fiber pads shipped with the device and the cap must be mounted to seal the port as far as possible.

	 WARNING	Risk of Burning on Hot Surface
<p>The surface around the tube access ports may become extremely hot.</p>		

Product Description
Tube Access Ports

Installation procedures

Table-top units

Installing the Shelf System

The installation of the shelf system does not require any tools. The support rails are secured in place by spring action. Once the shelf support have been inserted into the rails, the perforated shelves can be simply pushed onto their support hooks to complete the installation.

NOTE

The support rails of the floor stand units cannot be removed.

Initial installation

1. Peel off the protective foil from the support rails.
2. Push the retaining spring [1] into the guide on the support rail [2], making sure that the locking nub [3] on the retaining spring safely engages with the matching hole in the support rail.

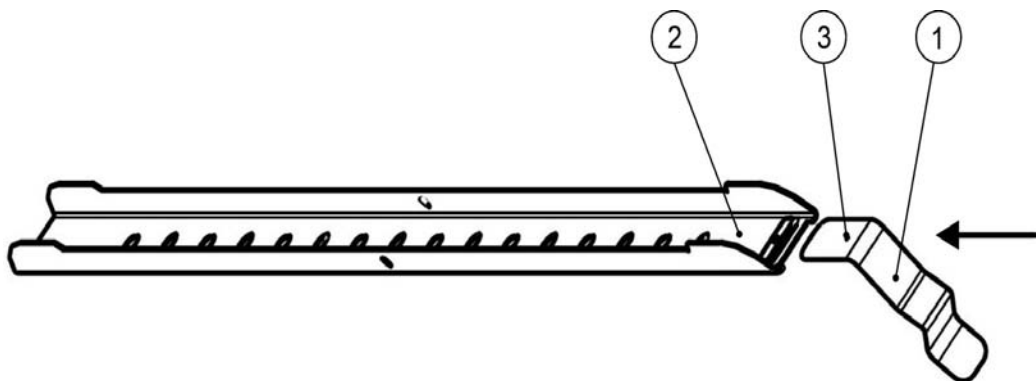
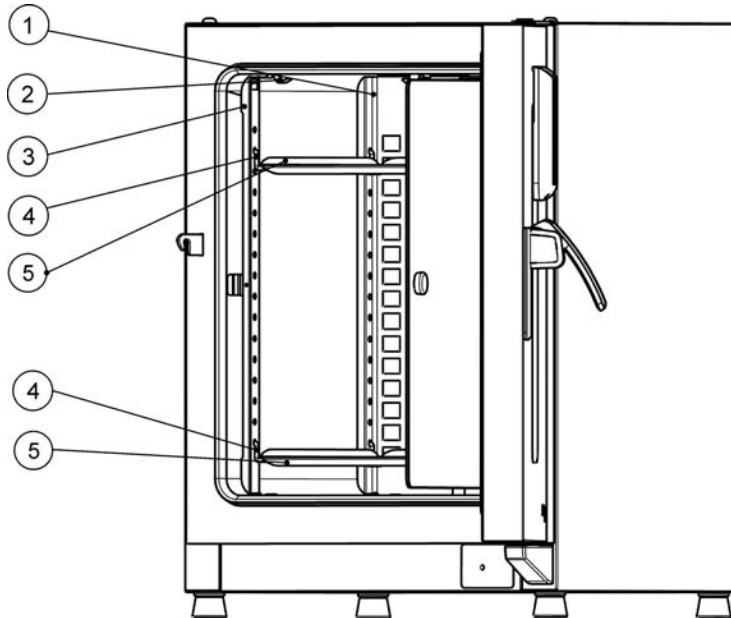

Figure 5-1 Sliding the Retaining Spring into the Support Rail

Installing the Perforated Shelves

The illustrations below show the placement of the shelf system elements.



- [1] Air baffles
- [2] Retaining Springs (only for table-top units)
- [3] Support rails
- [4] Shelf support
- [5] Perforated shelves

Figure 5-2 Installing the Shelving

Preparing the useable space

Upon delivery, Heratherm incubators are not in a sterile state. Before the initial start-up, the incubator must be decontaminated.

The following work space components should be checked for cleanliness and disinfected prior to use:

- Support rails
- Shelf support
- Perforated plates
- Useable space surfaces,
- Work space seals and gaskets,
- Glass door

NOTE

Cleaning and disinfection

For details about the cleaning and disinfection of the incubator, please refer to “[Cleaning and Disinfection](#)” on [page 9-1](#).

Installation or Removal of the Support Rails

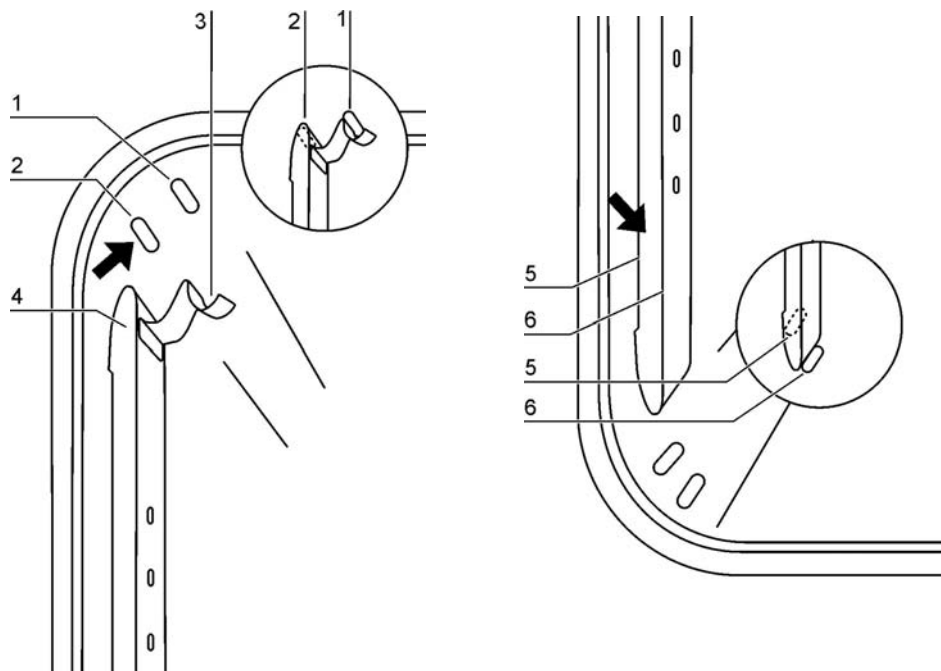

Figure 5-3 Support Rail Installation

The embossings at [2] and [5] act as lateral guides for the support rails, while the embossings at [1] and [6] secure the support rails in place. For the support rails to install correctly the retaining spring [3] must be facing upwards.

1. Place the support rail [4] on the lower embossing [6] and tilt it upwards against the work space side wall so that the rail is positioned over the two embossings at [5] and [2].
2. Clamp the retaining spring [3] behind the upper embossing [1].
3. To remove the support rails, pull the retaining spring tab down out of the embossing and remove the support rail assembly.

Installing and Uninstalling the Air Baffle

Heratherm IMH and IMH-S Series incubators are shipped from the factory with the air baffle readily pre-installed. Before the air baffle can be removed from the back wall, the support rails need to be uninstalled.

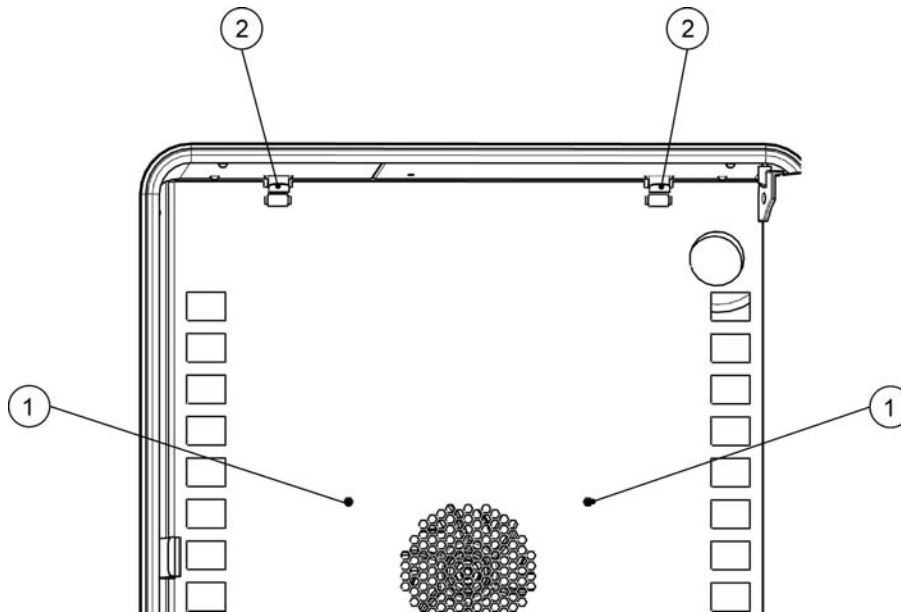

Figure 5-4 Removing the Air Baffle

1. Loosen the two screws [1] that hold the air baffle to the interior container back wall.
2. Grab the two retaining springs [2] at their tabs and pull them downwards out of the embossings, then take off the air baffle from the back wall.
3. For the air baffle to install correctly, the retaining springs must be facing upwards. Place the air baffle on the lower embossings and tilt it upwards against the back wall of the work space.
4. Clamp the two retaining springs [2] into the upper embossings.
5. Secure the air baffle against the interior container back wall by fastening the two screws at [1].

Levelling the Incubator

1. Position a bubble level onto the center shelf.
2. Manually adjust the levelling feet until the shelf is horizontally aligned in all directions. Perform the adjustment of the levelling feet from left to right and from rear to front.

Commissioning of floor-mounted units

Installing/Removing air baffles (IMH-S Series)

The section below describes how to install/remove the bottom plate.

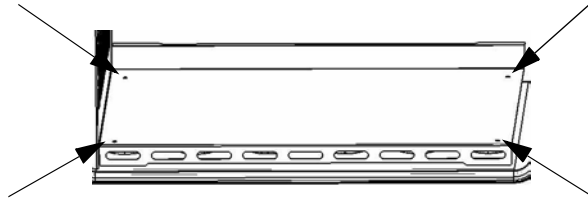

Figure 5-5 Removing the bottom plate

1. Loosen and remove the four (4) screws in the bottom plate and then remove the bottom plate completely.

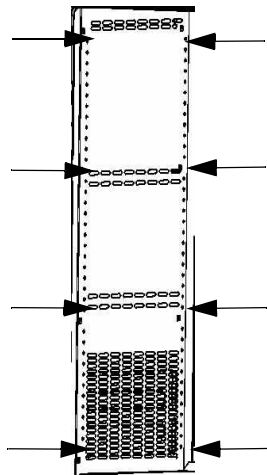

Figure 5-6 Removing the left and right support profiles

Loosen and remove the eight (8) screws for the left and right support profiles and then take out the lateral air baffles.

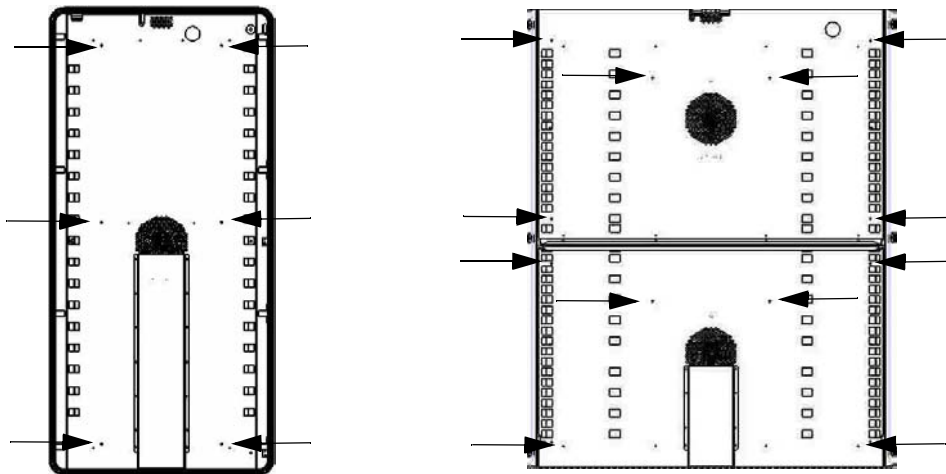

Figure 5-7 Removing the rear air baffle IMH 400-S / 750-S

On the IMH-S 400 model loosen and remove the six (6) screws for the rear air baffle and for model IMH-S 750 loosen and remove the six (6) screws for the top and bottom air baffles and then remove the air baffle(s).

Commissioning, general

Installing the Shelf Support Brackets

1. Insert the shelf support bracket [3] into the perforations [1] of the support rail and tilt it downwards.
2. Make sure that the two vertical elements [2] of the shelf support bracket butt against the support rail.

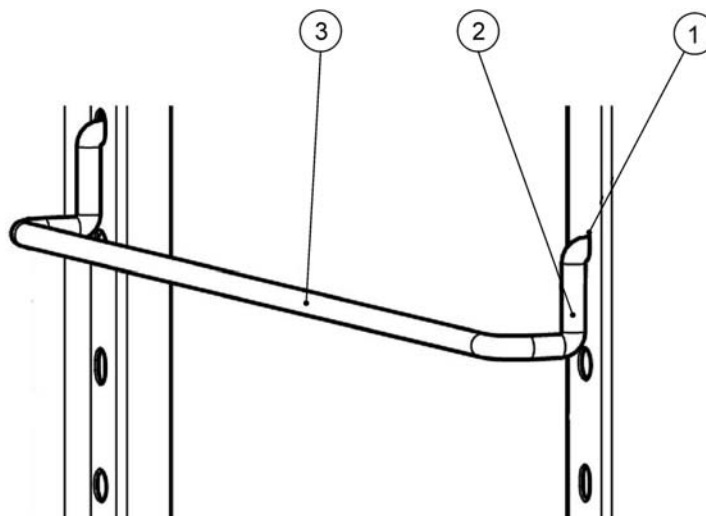
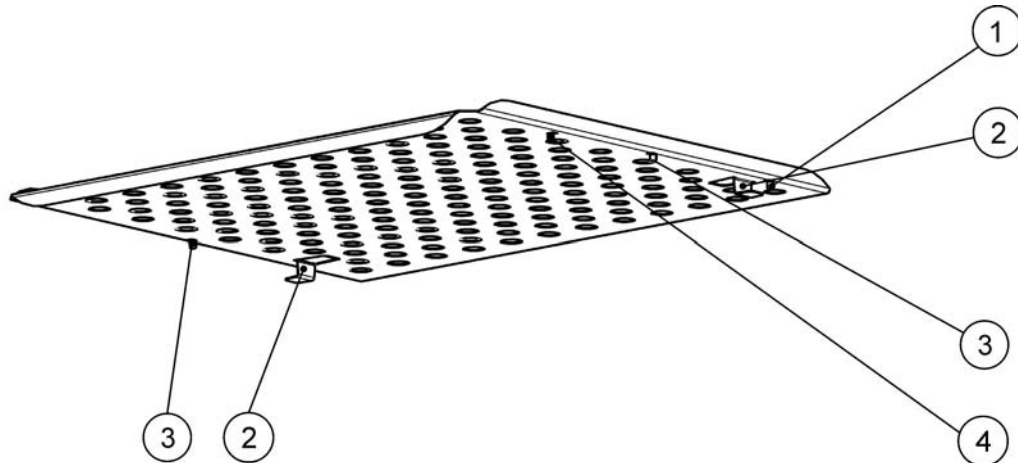

Figure 5-8 Shelf Support Bracket Installation

Installing the Perforated Shelves





- [1] Rear Pull-out Stop
- [2] Anti-tilt anchor
- [3] Front Pull-out Stop
- [4] Shelf

Figure 5-9 Installing the Perforated Shelves

1. Push the shelf [4] onto the shelf support with the tilt protection devices [2] facing the rear panel of the incubator.
2. Slightly raise the perforated shelf so that the pull-out stops [1] and [3] can slide over the shelf support.
3. Make sure that the shelves and both of their tilt protection devices are free to move over the shelf support.

Mains connection

	 Electrical shock
	<p>Contact with live electrical components may cause a lethal electric shock.</p> <p>Before connecting the device to the power supply, check the power cord and the plug for damage. Do not use damaged cables for connecting the device to the power supply!</p>

The incubator has a class I, protection-earthed enclosure. To minimize the risk of electrical shock, use the AC power cord supplied to connect the incubator to a correctly installed and protection-earthed power supply source, with the following features in place for each incubator:

- T 16 A slow-blow fusing
- B 16 circuit breaker

Connection to the power supply source

1. Before connecting the incubator to the power source, check to see if the power supply voltage corresponds with the specifications on the nameplate on the front of the incubator. If the voltage (V) and current (A) ratings given are not as required, do not connect the device to the power source!
2. Make sure the alarm contact remains disconnected at this time. If connected, disconnect it now to avoid a false alarm on the receiving end. You will get back to the alarm contact later on as you work your way through this start-up procedure.
3. Connect the IEC connector to the socket at the rear of the incubator.
4. Route the power cord along a path that does not cross exhaust air piping or passageways and aisles. With stacked devices, keep the power cord away from hot spots on the other incubator in the stack.
5. Connect the protection-earthed plug of the power cord to a correctly protection-earthed and earth leakage circuit breaker fused power socket.
6. Make sure the power cord is not subjected to tensile or compressive force.

	<p style="text-align: center;">NOTE</p> <p>Make sure that power outlets remain freely accessible at all times!</p> <p>In an emergency the power connection must be rapidly disconnectable; so be sure to have the power outlets freely accessible at all times!</p>
--	---



Figure 5-10 AC Power Supply Socket

	<p style="text-align: center;">NOTE</p> <p>Condensation</p> <p>When taking the incubator into operation for the first time allow some time before switching on for stabilization to avoid condensation forming on live parts.</p>
--	---

Connecting the RS-232 Interface

	 NOTE
	Replacement should only be carried out by skilled and authorized qualified personnel of electrotechnology/signal engineering!

The RS-232 data communication interface supports the querying of status information and temperature data from the incubator by entering basic commands in a standard terminal window provided by your computer's operating system. The interconnection requires a standard RS-232 cable with 9-pin connectors and a straight "1:1" pinout without any crossed wires, which is not supplied with the incubator.

Users may employ the RS-232 command inventory listed in [table 5-1](#) below for automating process data logging - for example, by embedding these commands in scripts that run on a remote computer.

	 CAUTION	RS-232 interface compatibility
		To avoid overloading and damaging the RS-232 interface check the interfacing parameters against the pin-out description given above and make sure that computer's interface port works with a signal level of +/- 5V DC.

Interconnecting the Incubator with a Computer

1. Turn the computer off.
2. Route the serial interface cable along a path that does not cross hot exhaust air piping, tables, aisles or passageways. With stacked devices, keep the serial interface cable away from hot spots on the other incubator in the stack.
3. Connect one connector of the serial interface cable (cable length, 5 to max. 10 m, not supplied as a standard item) to the socket labeled RS 223 in the computer and alarm interface section at the rear of the incubator.
4. Connect the second connector to an unused COM 1 /COM 2 or other serial port on the computer.
5. Boot the computer.
6. Launch your standard terminal program and set up the connection with the following parameters:
 - 57600 bits per second
 - 8 Data bits
 - 1 stop bit

- No Parity
- 7. Once your terminal indicates that serial communication has been established successfully, enter any of the commands listed in Table 5-2 below, depending on what type of information you want to query.
- 8. Use the following generic command syntax:

?:aaaa:bb::cc<CR>, where:

- **?:** identifies the command line as a query;
- **aaaa:** is the parameter address;
- **bb::** is a query, that must be left at „00” for technical reasons;
- **cc** is for a command - specific checksum listed in the table below.
- **<CR>** is for carriage return.

You will receive a response of the following general format

!:aaaa:bb:XXXXX:cc<CR> , where:

- **!:** identifies the line as a response to a query;
- **aaaa:** is the parameter address entered with the query;
- **bb:** is the number of payload bytes in hexadecimal code - for example, 1F for the decimal value 31;
- **XXXXXX:** is the significant status information queried;
- **cc:** is a check sum (technically an inverted XOR of all bytes returned, excluding the check sum bytes and the <CR> character);
- **<CR>** is for carriage return.

Table 5-1 Terminal Commands for Querying Data

Command Syntax	Response Example
Combined Date and Time	
?:0010:00::c1	!:0010:11: 31.07.10;01:02:23 :e2 Date Time
Date only	
?:0011:00::c0	!:0011:08: 31.07.10 :d2 Date
Time only	
?:0012:00::c3	!:0012:08: 01:02:23 :dc Time

Table 5-1 Terminal Commands for Querying Data

Command Syntax	Response Example
	Temperature Set Value (T1); Current Work Space Temperature (T2); Reference Temperature (T3); Sample Sensor Temperature (T4)
?:3010:00::c2	!:3010:1f:+125.00;+124.96;+000.000;+000.00:b0 T1 T2 T3 T4

Wiring the Alarm Contact

	<div style="background-color: #0056b3; color: white; padding: 5px; display: inline-block;">NOTE</div>	<p>Skilled work</p> <p>Thermo Scientific warrants the operational safety and the operativeness of the incubator only if installation and repairs are performed by skilled personnel.</p> <p>The connection of the incubator to an external alarm system must only be carried out by adequately trained and authorized electrical engineering or telecommunications expert personnel!</p>
--	--	---

Function Description

When system errors and failures occur in the temperature control circuits, an alarm message is issued to the connected alarm monitoring system. The potential-free contact (single changeover-type contact) has been designed for the circuit configuration specified below.

	<div style="background-color: #0056b3; color: white; padding: 5px; display: inline-block;">NOTE</div>	<p>Switching behavior</p> <p>The alarm relay is energized by all error conditions reported by internal control loops.</p>
--	--	--

Alarm Relay Specifications

Circuit	Voltage	External fusing
Circuits with system voltage	max. 250 V ~	max. 2 A
SELV circuits (cf. VDE 0100, Part 410)	25 V ~	max. 2 A
	60 V =	max. 1 A
SELV-E circuits (cf. VDE 0100, Part 410)	50 V ~	max. 1 A
	120 V =	max. 0.5 A

	<p>Alarm contact electrical compatibility considerations</p> <p>To avoid overloading and damaging the alarm contact, check the electrical interfacing parameters of the alarm-receiving system for compatibility with the alarm relay specifications given above.</p>
---	---

Connection Example

The connector [5] for the interface cable is supplied with the incubator as a standard item. Specifications for the operating voltage and the fusing of external alarm circuitry are given in the table on the previous page.

1. Wire the individual conductors [1] through [4] of the interface cable as shown in the wiring diagram.
2. Route the alarm cable along a path that does not cross hot exhaust air piping, tables, aisles or passageways. With stacked devices, keep the serial interface cable away from hot spots on the other incubator in the stack.
3. Plug the alarm system interface cable connector into the interface port [5] in the rear panel of the incubator.

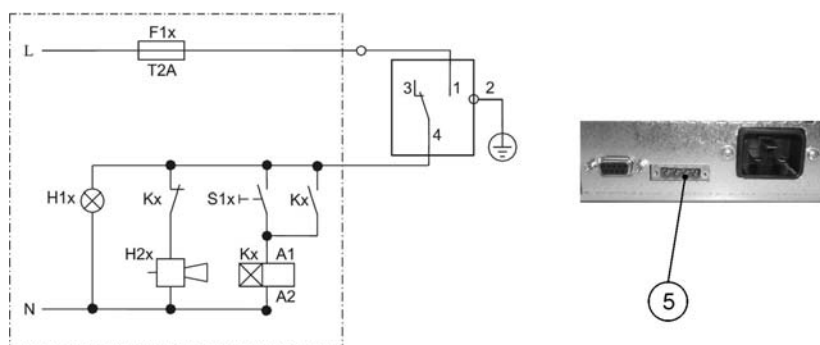

Figure 5-11 Alarm Relay Connection Example

The circuit diagram shown above represents the undisturbed condition of operation. In case of an error condition - including a power outage - contact closure occurs on the path between contacts 1-4.

Operation

Preparing the Incubator

The incubator must not be released for operation before all major start-up activities have been completed (see “[Installation procedures](#)” on [page 5-1](#)).

Device Check

Prior to starting operation, the following incubator components must be checked for their correct function:



- The door seal in the front frame must not be damaged.
- The glass door must not be damaged.
- The shelving components must be installed safely.
- Disinfecting the Incubator’s Work Space

Run the decontamination routine (Heratherm IMH 60/100/180/400/750-S devices only; see section “[Decontamination](#)” on [page 7-16](#)) or disinfect the work space according to the operator-specified hygiene guidelines.



Disinfect the work space according to the operator-specified hygiene guidelines.

Starting Operation

1. Turn the incubator on using the control panel.
2. Adjust the temperature set value on the control panel.
3. Launch decontamination (optional with Heratherm IMH 60/100/180/400/750-S devices only; see “[Decontamination](#)” on [page 7-16](#)).
4. The temperature controller starts adjusting the work space to the user-specified temperature set value now.

		<p>To avoid any risk of explosion or fire</p> <ul style="list-style-type: none">•refrain from loading the incubator with any of the substances listed in the section “Incorrect Use” on page 1-6• make sure that the ambient air is free of any solvents• do not operate the incubator in areas with an explosion hazard
---	---	--

5. Load the work space with samples.

		<p>Hot surfaces</p> <p>The screen of the glass door, the interior panel of the outer door as well as the surfaces of the shelving and the work space become hot while the incubator is running through its heating cycles and need some time to cool down.</p> <p>When removing samples from a running or recently completed heating cycle, always wear safety gloves and other appropriate personal protection equipment to avoid burns on hot surfaces!</p>
---	---	--

	<p>Risk of overloading</p> <p>Overloading may damage the shelves or cause the shelves and/or the incubator to tilt when the shelves are being drawn out, ultimately destroying the samples. To avoid overloading the incubator or its shelving be sure to observe the sample weight limits specified in “Technical Data” on page 13-1.</p>
---	--

	<p>Proper loading</p> <p>To ensure sufficient air circulation and uniform heating of the samples, do not use more than 70% of the maximum surface area of the work space. Bulky objects in the work space that dissipate heat may impair heat distribution.</p>
---	--

Handling and Control

Heratherm IMH Series and IMH-S Series incubators come with a front panel mounted control unit consisting of a multifunctional display, four control buttons, and an on/off button. The four control buttons interact with the display window to let users access all of the user control functions and adjustments of the incubator, including - for example, the temperature set value, timer, energizing/de-energizing the AC outlet in the work space, as well as a variety of other functions.

Under normal operating conditions the display presents user with the work space temperature. The display returns to its default mode upon completion of the adjustments or whenever no entries have been made for a period of 30 seconds.



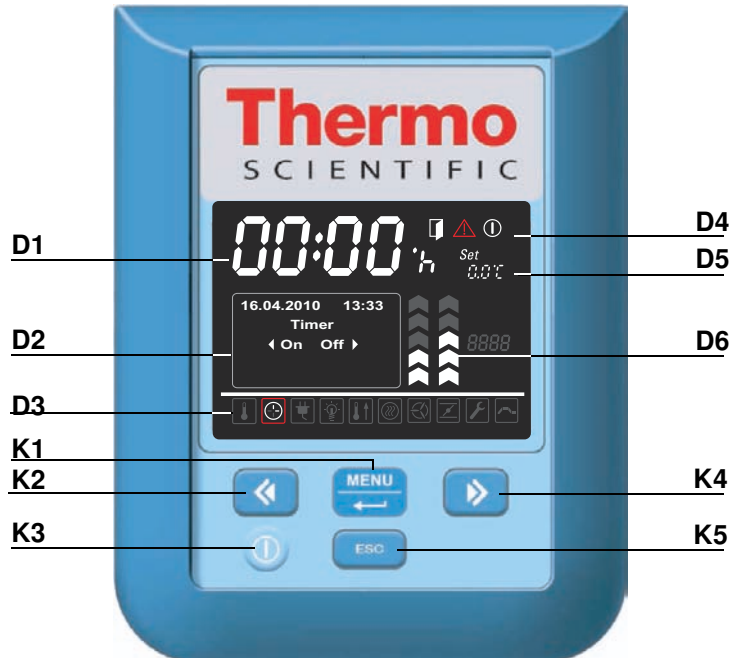

The graphic below shows the Heratherm IMH 60/100/180 and IMH 60/100/180/400/750-S control panel with all of its visualization elements and controls.

Figure 7-1 Control Panel for Heratherm IMH Series and IMH-S Series Incubators



The table below contains brief descriptions of the buttons on the control panel (items K1 through K5 in [figure 7-1](#)).

Table 7-1 Control Buttons

Icon	Item	Function
	K1	<p>Menu/Enter button</p> <p>First key press: Activates the menu, highlighting the first menu item with a red border.</p> <p>Second key press: Selects the currently activated menu item (as highlighted by the red border), depending on the currently selected function, pressing this button enables entries with item D2, D5 or D6.</p> <p>Third key press (once a setting has been changed): Confirms a previous entry or selection.</p>
	K2	<p>Left button</p> <p>After the first press of Menu/Enter button:</p> <ul style="list-style-type: none"> - Moves the selection in the menu (see item D3) to the next icon on the left. <p>Once a menu item has been selected:</p> <ul style="list-style-type: none"> - Decreases an adjustable parameter value - for example, the temperature set value in D5. Holding this button depressed for a few seconds changes the selected value in quick run mode. - Moves the selection in the multifunctional display pane at D2 to the next option on the left - for example, from the Off state of the timer to On.
	K3	<p>On/Off Button</p> <p>Holding this button depressed for 2 seconds switches the incubator off. The display window goes out, except for the readiness indicator icon in the status display area at item D4. The temperature display pane D1 provides as dimmed readout of the work space temperature, provided that the temperature exceeds 50 °C (122 °F).</p>
	K4	<p>Right button</p> <p>After the first press of Menu/Enter button:</p> <ul style="list-style-type: none"> - Moves the selection in the menu (see item D3) to the next icon on the right. <p>Once a menu item has been selected:</p> <ul style="list-style-type: none"> - Increases an adjustable parameter value - for example, the temperature set value in D5. Holding this button depressed for a few seconds changes the selected value in quick run mode. - Moves the selection in the multifunctional display pane at D2 to the next option on the right - for example, from the On state of the timer to Off.
	K5	<p>Escape button</p> <p>Returns to the previous level of the menu or standard display. Upon exiting from the current menu item the user may be prompted to save any previously made settings.</p>

The table below contains brief descriptions of the display features of the control panel (items D1 through D6 in [figure 7-1](#); the identifiers K1 through K4 refer to the buttons shown in that figure).

Table 7-2 Display Features







Feature	Item	Function
	D1	Display pane showing a permanent readout of the actual temperature in the work space either in °C or °F (depending on the user's preferences, see "Temperature Display Unit" on page 7-27). At temperatures below 105 °C or 221 °F the temperature readout has one digit after the decimal point, while temperatures beyond are shown without any decimal places. Alternatively, a flashing time entry prompt of the general format hh:mm (hours:minutes, both with two digits) appears in this place while the user is setting the incubator's built-in clock.
	D2	Four-line multifunctional display pane with fields for date and time, a display area for the specific options of the selected menu item, alarm codes, progress indicators for continuous processes (for example, program-controlled temperature ramping), etc.
	D3	Menu bar with iconized representations of adjustable parameters. A red border is used to highlight the current Menu item, as selected using the Menu (K1) and arrow buttons Left (K2) and Right (K4). Brief descriptions of the individual menu items are given in table 7-3. Note If a menu item cannot be selected, then the function it represents is not part of the equipment configuration of your unit.
	D4	Status display area with three icons representing specific statuses of the incubator (from left to right): - The Door open icon appears when the front door of the incubator is open or has not been closed correctly (see "Door switch" on page 4-11). Note The Door open icon is only functional with IMH-S Series devices. - Upon occurrence of an error condition, the red alarm icon will be illuminated. At the same time the current error code will flash in the display pane D2. The alarm may be acknowledged by pressing the button  . - The readiness indicator icon appears when the incubator has been switched off using the figure 7-1 On/Off button (item K3).
	D5	Settings pane labeled Set for temperature set value in either °C or °F (depending on the user's preferences; see "Toggling the Temperature Display Unit" on page 7-27). At temperatures below 105 °C or 221 °F the temperature readout has one digit after the decimal point.

Table 7-2 Display Features

Feature	Item	Function
	D6	<p>The left one of the two vertical bar graphs belongs to the Fan icon directly beneath it and displays the current fan speed level.</p> <p>Fan speed level for table-top units Bar graph for fan speed setting (in 6 steps: 0 – 5) - 0% (no chevron illuminated) - 20% (chevron 1 illuminated) - 40% (chevrons 1 and 2 illuminated) - 60% (chevrons 1 through 3 illuminated) - 80% (chevrons 1 through 4 illuminated) - 100% (chevrons 1 through 5 illuminated)</p> <p>Fan speed level for floor stand units Bar graph for fan speed setting (in 2 steps) Minimum fan speed level (chevrons 1 through 3 illuminated) Maximum fan speed level (chevrons 1 through 5 illuminated)</p>

The table below contains brief descriptions of the menu bar icons (position D3 in [figure 7-1](#))

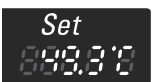
Table 7-3 Menu Bar Icons







Icon	Function
	<p>Temperature Set Value Allows for changing the temperature set value (factory-preset to 37 °C/99 °F) within the permissible temperature range. The set value can be changed by pressing the Left and Right (item K2 or K4) and you can, after confirming your changes with the Menu/Enter button (item K1), track the impact on the actual temperature in the multifunctional display pane at D1. Instructions: “Temperature Set Value” on page 7-7.</p>
	<p>Timer Allows for having the unit turn on or off upon expiry of a user-specified countdown period or at a fixed on or off time, or having it operate on a complete weekly schedule of daily on and off times. When the user enables an “on timer” the display goes out. A rotating arrow in the Timer icon and the illuminated readiness indicator icon in the status display area indicate that the timer is running. Instructions: “Timer” on page 7-8.</p>
	<p>Light Toggles the interior light in the work space of the incubator on and off (requires optional inspection package). Instructions: “Light” on page 7-15.</p>

Table 7-3 Menu Bar Icons

Icon	Function
	<p>Decontamination (IMH-S series only) Starts the integrated decontamination. Instructions: “Decontamination” on page 7-16.</p>
	<p>Fan Turns the fan on and allows for choosing the fan speed levels described under D6. The current setting is shown by the bar graph located directly above the icon and spelled out as a numeric value in the display pane at D2. Instructions: “Fan” on page 7-19.</p>
	<p>Settings Invokes a submenu with the following functions:</p> <ul style="list-style-type: none"> - Read access to error log - Calibrating the incubator - Setting date and time - Toggling the temperature display unit between °C and °F - Entering a configuration control code <p>(Instructions: “Settings” on page 7-22)</p>

Powering Up

1. Plug the power plug of the incubator into a suitable protection-earthed AC power outlet.



In the display window on the front panel the readiness indicator icon (rightmost icon in the status display area at D4 in [figure 7-1](#) on [page 7-1](#)) is illuminated.



2. Keep the **On/Off** button depressed for two seconds.

An initialization routine will be run after the incubator has been powered up. Once initialization has been completed, the display will light up and the current work space temperature will appear in the temperature display pane (item D1 in [figure 7-1](#) on [page 7-1](#)). The incubator is ready for use now.

Switching the Incubator Off / Powering Down



1. **Keep the** On/Off button depressed for two seconds.



The display window goes out, except for the readiness indicator icon (rightmost icon in the status display area at D4 in [figure 7-1](#) on [page 7-1](#)) and a residual heat temperature readout in case the work space temperature is still ≥ 50 °C/122 °F. The incubator is switched off now.







2. If required, unplug the AC power plug to power down the incubator completely.



Temperature Set Value

Heratherm incubators allow for setting the desired work space temperature directly using only a few button presses. After confirming the new temperature set value in the settings pane **Set** (item D5 in [figure 7-1](#) on [page 7-1](#)), the user may trace the resulting temperature change in the temperature display pane (item D1 in [figure 7-1](#) on [page 7-1](#)).

Table 7-4 Adjusting the Temperature Set Value

	<p>Press  to activate the menu bar, then use  to select the Temperature icon and press  to confirm.</p>
	<p>In the flashing settings pane Set, press  or  to adjust a new temperature set value, then press  to confirm your settings.</p>
	<p>The display returns to its default mode. The actual temperature measured in the work space and shown in the temperature display area starts to change until it reaches the newly adjusted set value.</p>



Timer

The **Timer** feature from the menu bar enables the user to turn the incubator on and off at scheduled times. The timer supports three different modes of operation, depending on the user's preferences:

- **Countdown-type on or off timer:** Turns the incubator on or off after a user-specified period of time. Instructions on setting the preferences for this option are given in [table 7-5](#) below, while its use as an off timer and on timer are described in [table 7-6 on page 7-9](#) and [table 7-7 on page 7-9](#), respectively.
- **Fixed-time on or off timer:** Turns the incubator on or off at a scheduled time. Instructions on setting the preferences for this option are given in [table 7-8](#), while its use as an off timer and on timer are described in [table 7-9 on page 7-10](#) and [table 7-10 on page 7-10](#), respectively.
- **Weekly timer:** Turns the incubator on or off at scheduled times on specific days of the week. The process for setting the preferences for this option is described in [table 7-11](#), while instructions for programming the daily turn-on and turn-off times are given in [table 7-12 on page 7-11](#).

Programming a turn-on time causes the incubator to shut down until it is scheduled to restart, while a turn-off time keeps it running before it shuts down at the user-specified time. The timer starts running immediately as soon as the user confirms his or her entries.

The decontamination routine overrides timer schedules, that is, a pre-programmed timer will not start before decontamination is finished.

Table 7-5 Presetting the Countdown Timer Mode of Operation

	Press to activate the menu bar, then use to select the Settings icon and press to confirm.
	Press to switch to the Timer menu item and confirm the selection with .
	Press or to preselect the Countdown timer as the mode of your choice, then use to confirm the selection.
	The display returns to its default mode.

Table 7-6 Setting a countdown-type off timer















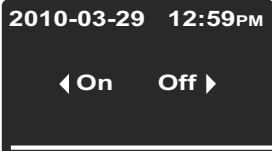

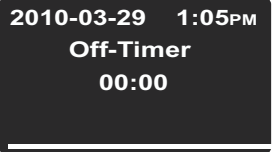





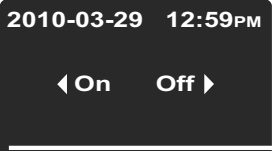

	<p>Press  to activate the menu bar, then use  to select the Timer icon and press  to confirm.</p>
	<p>Press  to select the off timer option Off.</p>
	<p>Set the hours and minutes until the incubator is supposed to shut down by pressing  or , then press  to confirm.</p>
	<p>The display returns to its default mode. In the menu bar, the Timer icon  is illuminated and an arrow is rotating on the icon's face.</p>

Table 7-7 Setting a Countdown-type On Timer

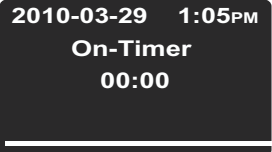
	<p>Press  to activate the menu bar, then use  to select the Timer icon and press  to confirm.</p>
	<p>Press  to select the on timer option On, then  to confirm.</p>
	<p>Set the hours and minutes until the incubator is supposed to turn on by pressing  or , then press  to confirm.</p>
 	<p>The incubator switches off. The display goes out, the Timer icon is illuminated in the menu bar with a hand rotating on its face. Additionally, the readiness indicator icon is illuminated.</p>

Setting a Fixed-time On or Off Timer

Table 7-8 Presetting the “Fixed-time” Timer Mode of Operation











	<p>Press  to activate the menu bar, then use  to select the Settings icon and press  to confirm.</p>
	<p>Press  to switch to the Timer menu item and confirm the selection with .</p>
	<p>Press  or  to preselect the Absolute fixed-time timer as the mode of your choice, then  to confirm the selection.</p>
	<p>The display returns to its default mode.</p>

Table 7-9 Setting a Fixed-time Off Timer



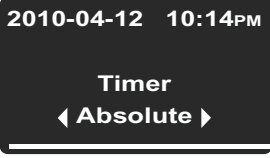







	<p>Press  to activate the menu bar, then use  to select the Timer icon and press  to confirm.</p>
	<p>Press  to select the off timer option Off.</p>
	<p>Set year, month, day, hours and minutes using  or , followed by  to confirm.</p>
	<p>In the menu bar, the Timer icon is illuminated and an arrow is rotating on the icon's face.</p>

Table 7-10 Setting a Fixed-time On Timer

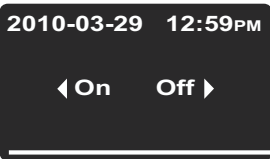

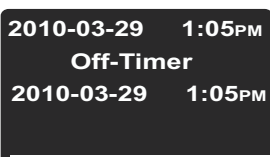







	<p>Press  to activate the menu bar, then use  to select the Timer icon and press  to confirm.</p>
	<p>Press  to select the on timer option On, then  to confirm.</p>

Table 7-10 Setting a Fixed-time On Timer

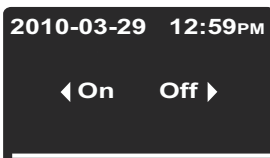
	<p>Set year, month, day, hours and minutes using  or , followed by  to confirm.</p>
	<p>The incubator switches off. The display goes out, the Timer icon is illuminated in the menu bar with a hand rotating on its face. Additionally, the readiness indicator icon is illuminated.</p>

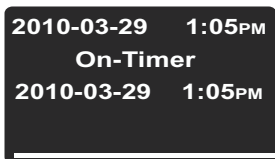
Setting a Weekly Timer

Table 7-11 Presetting the Weekly Timer Mode of Operation











	<p>Press  to activate the menu bar, then use  to select the Settings icon and press  to confirm.</p>
	<p>Press  to switch to the Timer menu item and confirm the selection with .</p>
	<p>Press  or  to preselect the Weekly timer as the mode of your choice, then  to confirm the selection.</p>
	<p>The display returns to its default mode.</p>

Table 7-12 Setting a Weekly Timer



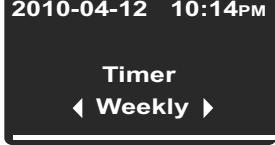











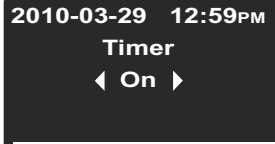

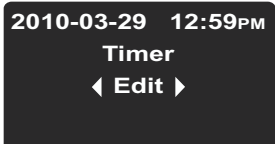

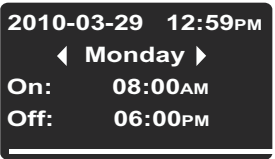





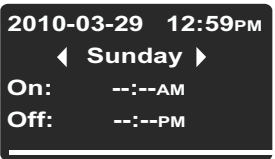

	<p>Press  to activate the menu bar, then use  to select the Timer icon and press  to confirm.</p>
	<p>In the selection screen shown at left, press  to switch from On to the Edit option.</p>
	<p>Select the Edit option by pressing .</p>

Table 7-12 Setting a Weekly Timer

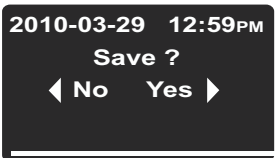
	<p>Press  to select the On time for Monday, which should start flashing when selected (or continue to the desired weekday by pressing ; which will cause the on time of that day to start flashing;</p> <p>Press  or  to set the hours, then continue to minutes by pressing .</p> <p>Use  or  to set the minutes. Then continue to Tuesday or any other desired weekday by pressing .</p> <p>To prevent the incubator from turning on and back off on a specific day, set both hours and minutes to --:--.</p>
	<p>Set the scheduled turn-on and turn-off times for each single day of the week all the way to Sunday and press . (The turn-on and turn-off times for Saturday and Sunday are disabled by default.)</p> <p>If there is no need to set or change the turn-on and/or turn-off times for a specific weekday, press  and  or  to go back and forth to the previous and next day, respectively.</p>
	<p>When prompted to save your changes, press  to confirm.</p> <p>Note This prompt for saving also appears when you press the button Esc while working on the weekly timer's settings.</p>
	<p>To enable the weekly timer press .</p> <p>Alternatively, press  and  to select the Off option if the weekly timer you have just saved should be activated at a later date.</p>
	<p>In the menu bar, the Timer icon is illuminated and an arrow is rotating on the icon's face.</p>

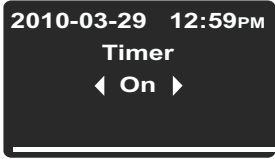
Stopping a Timer

Table 7-13 Stopping an Off Timer Before It Expires







	<p>Press  to activate the menu bar, then use  to select the Timer icon and press  to confirm.</p>
	<p>Press  to confirm the Yes default selection.</p>
	<p>In the menu bar, the Timer icon will go out.</p>

Table 7-14 Stopping an On Timer Before It Expires



	<p>To cancel a pre-programmed on timer while the incubator is switched off, hold the On/Off button depressed for a few seconds.</p>
	<p>In the Stop Timer? prompt that appears, confirm the default selection Yes by pressing .</p>
	<p>The display will return to the selection between off timer (Off, flashing) and on timer (On) table 7-6. In the menu bar, the Timer icon will go out.</p>

Table 7-15 Stopping a Weekly Timer Before It Expires









	<p>Press  to activate the menu bar, then use  to select the Timer icon and press  to confirm.</p>
	<p>The flashing word On appears in the multifunctional display pane.</p> <p>Press  to switch to Off state, then press .</p>

Table 7-15 Stopping a Weekly Timer Before It Expires

 A screenshot of a black notification box with white text. The text reads: "2010-03-29 4:05PM" followed by "Timer stopped!" on the next line.	The message Timer stopped! appears as a confirmation!
 A square icon with a dark background and a white circle in the center. Inside the circle is a white plus sign (+).	In the menu bar, the Timer icon will go out.

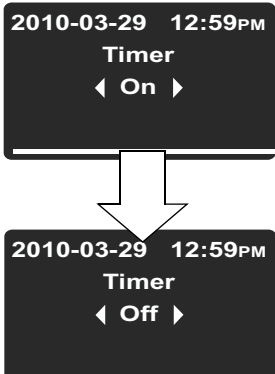
NOTE	Stopping a Timer
When you cancel a programmed timer you do not return to the main menu but rather to the appropriate level required for the timer restart.	

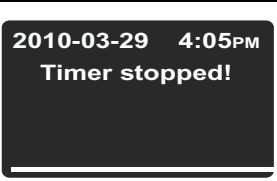

Light

This menu item toggles the interior light in the work space of the device on and off (requires optional inspection package). While the light is switched on the **Light** icon is illuminated in the menu bar.

Table 7-16 Turning the Light On















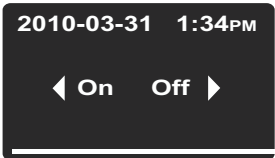

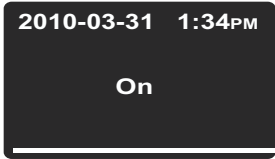
	<p>Press  to activate the menu bar, then use  to select the Light icon and press  to confirm.</p>
	<p>In the selection screen that appears confirm the selection by pressing .</p>
	<p>The selected option On remains in the multifunctional display pane for two seconds to let you track your action.</p>
	<p>The display returns to its default mode. The Light icon in the menu bar is illuminated to indicate that the light is on inside the incubator.</p>

Table 7-17 Turning the light off

	<p>Press  to activate the menu bar, then use  to select the Light icon and press  to confirm.</p>
	<p>In the selection screen that appears confirm the selection by pressing .</p>
	<p>The selected option Off remains in the multifunctional display pane for two seconds to let you track your action.</p>
	<p>The display returns to its default mode. The Light icon in the menu bar is extinguished to indicate that the light is off inside the incubator.</p>

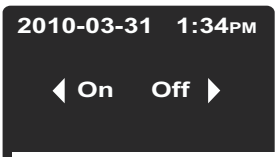

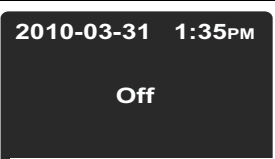
Decontamination

This menu item (available on IMH-S Series devices only) launches the built-in decontamination routine of the incubator. The decontamination routine consists of a factory-preprogrammed, multi-phase workflow (heating, holding, cooling). It works with a temperature set value of 140 °C (284 °F), which is held over a period of six hours. The overall duration of the process depends on the set temperature that is in place before decontamination is started, on the initial temperature of the work space and miscellaneous other factors. The incubator will be unavailable during that period of time. Before launching the decontamination routine seal the access port with the supplied plug.

Table 7-18 Launching Decontamination









	<p>Press  to activate the menu bar, then use  to select the Decontamination icon and press  to confirm.</p>
	<p>In the selection screen that appears confirm the selection by pressing .</p>
	<p>If a Stop Timer prompt appears while decontamination is launching: When a timer is running, an additional Stop Timer (see “Stopping an On Timer Before It Expires” on page 13) prompt appears at this point. When you answer that prompt with Yes, the timer will be aborted and decontamination be launched instead. Choosing No allows the timer to continue. However, if decontamination and a timer overlap, decontamination has priority over the timer, that is, the timer will be put on hold and start later after the decontamination routine has finished.</p>
	<p>After pressing  to launch decontamination, you will be prompted to open the door and perform a safety check to make sure that all cultures or other temperature-sensitive items have been removed from the work space. Perform the check as requested, close the door and finally launch decontamination.</p>

Table 7-18 Launching Decontamination



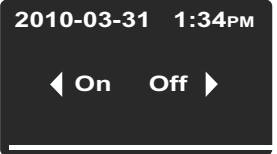

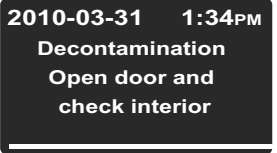
	<p>A progress bar and a residual time readout for the decontamination process appear in the multifunctional display pane.</p>
	<p>Opening the door while decontamination is running Opening the front door during the heating and holding phases causes the decontamination routine to stop and wait for the door to be closed. At the same time, the Door Open icon is lit in the display window. As soon as the door is closed, decontamination starts over, cycling through the entire process from the start. This may extend the overall duration of the decontamination routine substantially.</p> <p>Power Outage during a Decontamination Run A power outage relaunches the decontamination routine automatically. The Alarm icon (leftmost item of the group “D4” on page 7-1) is illuminated in the display window, and a E007 Power Down Error message appears at the end of the process. The alarm may be acknowledged by pressing the button .</p>
	<p>Bio-hazard</p> <p>Be sure to determine the current operating condition of the incubator before you open the door!</p> <p>Under specific circumstances, there is a risk that bacteria, viruses, fungi, prions, and other biological substances survive when the decontamination routine is aborted due to a power outage. Normally, the incubator starts over with the decontamination cycle without any need for user intervention upon return of power. Users who fail to notice the power outage, may open the door and/or load the incubator with samples, thus exposing themselves or their samples to bio-hazards without being aware of that risk.</p>
	<p>The Decontamination icon in the menu bar is illuminated to indicate that the decontamination process is running.</p>

Table 7-18 Launching Decontamination

	<p>When decontamination is completed, the message Decontamination finished! appears in the multifunctional display pane. Press the button to acknowledge that message.</p>
	<p>The Decontamination icon in the menu bar will go out. The settings that were in place before the decontamination routine was started - for example, fan speed, will be restored.</p>

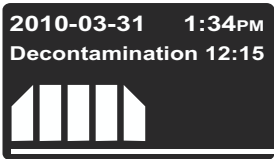
Table 7-19 Stopping Decontamination Prematurely

	<p>Press to activate the menu bar, then use to select the Decontamination icon and press to confirm.</p>
	<p>In the selection screen that appears, press to switch to Yes and confirm the selection with .</p>
	<p>The display returns to its default mode. The Decontamination icon in the menu bar will go out. The settings that were in place before the decontamination routine was started - for example, fan speed, will be restored.</p>



Fan

This menu item allows for turning on the fan inside the work space and gradually adjusting its speed in one go. The current setting of the fan is indicated by the illuminated **Fan** icon in the menu bar and the five-level bar graph (see item D6 in [figure 7-1](#) on [page 7-1](#)) for the fan speed setting located directly above the icon.

Table-top units













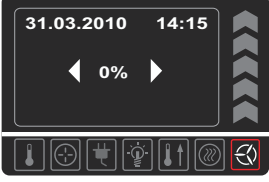

The fan can be adjusted in 6 levels:

- 0% (all chevrons extinguished)
- 20% (1 chevron illuminated)
- 40% (2 chevrons illuminated)
- 60% (3 chevrons illuminated)
- 80% (4 chevrons illuminated)
- 100% (5 chevrons illuminated)

Table 7-20 Turning on the Fan

	<p>Press to activate the menu bar, then use or to select the Fan icon and press to confirm.</p>
	<p>The settings dialog shown at left appears in the multifunctional display pane now, with the value 0% flashing already.</p>
	<p>Press as often as needed to reach the desired fan speed level, then confirm with .</p> <p>The multifunctional display pane will show the current fan speed level as a percentage (20%, 40%, 60%, 80% or 100%). Additionally, the matching number of chevrons will be illuminated in the bar graph to the right.</p>
	<p>The display returns to its default mode. The Fan icon in the menu bar is illuminated now to indicate that the fan is running.</p>

Table 7-21 Adjusting Fan Speed or Turning the Fan Off

	<p>Press  to activate the menu bar, then use  or  to select the Fan icon and press  to confirm.</p>
	<p>The settings dialog shown at left appears in the multifunctional display pane now, with the current fan speed setting flashing already.</p>
 	<p>Change the fan speed with  or , then press  to confirm.</p> <p>To turn off the fan, use  to reset its speed to 0%, then press  to confirm.</p>
 / 	<p>The display returns to its default mode.</p> <p>If you have just changed the fan speed level, the Fan will remain illuminated in the menu bar.</p> <p>If you choose to turn off the fan altogether, the Fan icon in the menu bar will be extinguished.</p>

Floor stand units

The unit contains a regulated fan; fan speed can be lowered (adjusted) in 2 stages:

Minimum fan speed level (chevrons 1 through 3 illuminated)

Maximum fan speed level (chevrons 1 through 5 illuminated)

Table 7-22 Turning on the Fan (only table-top units)







	<p>Press  to activate the menu bar, then use  or  to select the Fan icon and press  to confirm.</p>
	<p>The settings dialog shown at left appears in the multifunctional display pane now, with the value 0% flashing already.</p>

Table 7-22 Turning on the Fan (only table-top units)

	<p>Press as often as needed to reach the second fan speed level, then confirm with .</p> <p>The multifunctional display pane will show the current fan speed level as a percentage (60% or 100%). Additionally, the matching number of chevrons will be illuminated in the bar graph to the right.</p>
	<p>The display returns to its default mode.</p> <p>The Fan icon in the menu bar is illuminated now to indicate that the fan is running.</p>

Table 7-23 Adjusting Fan Speed or Turning the Fan Off (only table-top units)

	<p>Press to activate the menu bar, then use or to select the Fan icon and press to confirm.</p>
	<p>The settings dialog shown at left appears in the multifunctional display pane now, with the current fan speed setting flashing already.</p>
	<p>Change the fan speed with or , then press to confirm.</p>
	<p>The display returns to its default mode.</p> <p>The fan continues to run until the unit is switched off.</p>



Settings

The **Settings** menu item opens a submenu populated with various commands for viewing general status information on the Heratherm unit and setting for the operation of the incubator or its display window:

- Read access to error log
- Calibrating the incubator
- Setting date and time
- Toggling the temperature display unit between °C and °F
- Entering a configuration control code

Instructions for using these features are given in the following. Also supported is an option for presetting the timer mode of operation, as explained previously in the section “[Timer](#)” on [page 7-8](#).

Error Log

Users calling customer service for support may be asked by the Thermo Fisher Scientific agent to supply information from the error log of the incubator. This internal memory may be accessed by choosing the **Settings** -> **Error** menu item. It enables the user to browse through the most recent 22 alarm messages that were caused by hardware or control loop errors. Each error is displayed with the date and time of its occurrence, a brief clear text description and an internal error code.

Error codes and instructions for clearing alarm conditions appear in the section “[Error Codes](#)” on [page 12-1](#).

Table 7-24 Reading the Error Log











	<p>Press  to activate the menu bar, then use  or  to select the Settings icon and press  to confirm.</p>
	<p>Press  to select the Error item from the Settings submenu.</p>
	<p>The first entry of the error log is displayed, numbered “0”.</p>

Table 7-24 Reading the Error Log

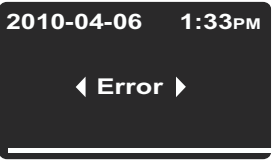
	<p>Press  to go to the next entry (or ). to go back to the previous one). After the entry numbered 21 the display wraps and returns to the beginning of the error log, displaying entry “Error 0.”</p>
	<p>To exit from the error log and return to normal display mode press  . The Settings icon in the menu bar will go out.</p>

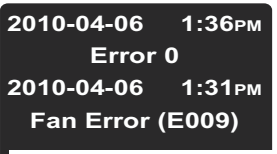
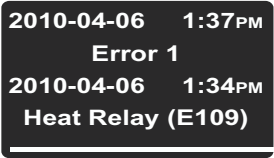
Calibration

The **Settings** -> **Calibration** menu item enables the user to initiate a temperature calibration routine for the built-in temperature sensors and choose whether calibration should be accomplished manually or automatically:

- The **Manual** option allows for entering an absolute temperature directly, as measured - for example, using an external reference sensor.

	<div style="border: 1px solid black; padding: 5px;"> <p style="text-align: center;">NOTE</p> <p>Calibration Prerequisites</p> <p>Maintain the ambient conditions within the specified limits of the incubator before launching calibration.</p> <p>Varying ambient conditions and/or an open damper may impact the result of the calibration routine, which may lead to misadjustment of the controller and unreliable temperature control operation.</p> </div>
--	--

Table 7-25 Entering the Calibration Reference Temperature Manually











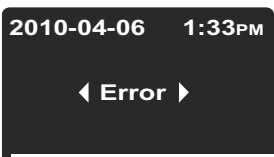
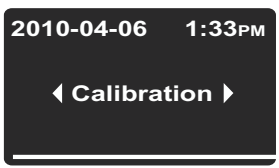

	<p>Prepare for temperature calibration (see “Preparing Temperature Calibration” and “Comparison Measurement Procedure” on page 10-3).</p>
	<p>Press  to activate the menu bar, then use  or  to select the Settings icon and press  to confirm.</p>
	<p>The Error menu item from the Settings submenu appears in the multifunctional display pane.</p>

Table 7-25 Entering the Calibration Reference Temperature Manually

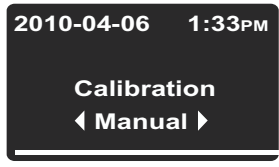
	<p>Press  to switch to the Calibration menu item and confirm the selection with .</p>
	<p>In the Calibration selection screen, press  to choose the preselected option Manual.</p>
	<p>In the settings dialog that appears, set the temperature measured with the external reference sensor by using  or  and confirm the settings with .</p>
	<p>The newly entered value will be stored and used to calibrate the internal temperature sensors with the value measured by the reference sensor. The display returns to its default mode. The Settings icon in the menu bar will go out.</p>

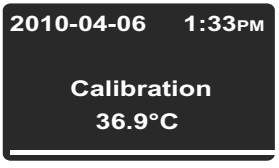
Date and Time

The **Settings** -> **Time / Date** option allows for switching between the international time and date display formats and for setting the time and date of the internal clock. There are two display formats to choose from:

- European date format *DD.MM.YYYY* and 24-hours time format. Example: *07.04.2010* and *15:05*.
- US standard date format *YYYY-MM-DD* and 12-hour time format with *AM/PM* suffix. Example: *2010-04-07* and *3:05 PM*.

Table 7-26 Setting the Date Format





	<p>Press  to activate the menu bar, then use  or  to select the Settings icon and press  to confirm.</p>
	<p>The Error menu item from the Settings submenu appears in the multifunctional display pane.</p>

Table 7-26 Setting the Date Format







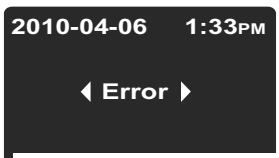

	<p>Press  to switch to the Time / Date menu item and confirm the selection with .</p>
	<p>The Date menu item is flashing in the multifunctional display pane.</p> <p>Choose the preselected option Date by pressing . The date field will start flashing in the upper left corner of the multifunctional display pane.</p>
	<p>Press  or  to switch to the desired date format DD.MM.YYYY or YYYY-MM-DD and confirm the selection with .</p> <p>The date field in the upper left corner will change its appearance according to your selection (and stop flashing).</p>
	<p>The display returns to its default mode. The Settings icon in the menu bar will go out.</p>

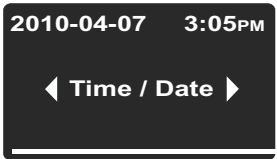
Table 7-27 Setting the Time Format

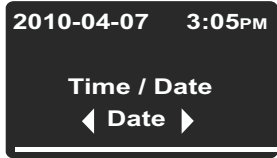

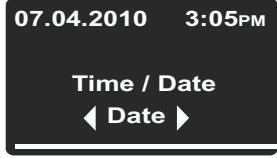



	<p>Press  to activate the menu bar, then use  or  to select the Settings icon and press  to confirm.</p>
	<p>The Error menu item from the Settings submenu appears in the multifunctional display pane.</p>
	<p>Press  to switch to the Time / Date menu item and confirm the selection with .</p>
	<p>The Date menu item is flashing in the multifunctional display pane.</p>

Table 7-27 Setting the Time Format





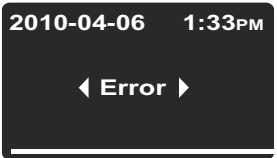
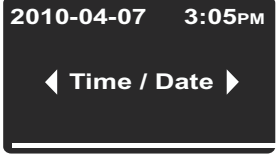

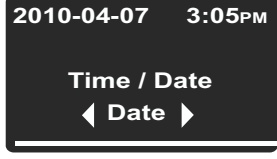
	<p>In the flashing Date menu item, press  to switch to the Time option and confirm the selection with . The Time menu item is flashing in the multifunctional display pane, along with the time field in the upper right corner.</p>
	<p>Press  or  to switch to the desired time format hh:mm or hh:mm AM/PM and confirm the selection with . The time field in the upper right corner will change its appearance according to your selection (and stop flashing).</p>
	<p>The display returns to its default mode. The Settings icon in the menu bar will go out.</p>

Table 7-28 Setting Date and Time

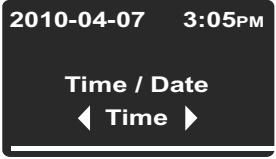

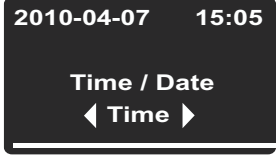











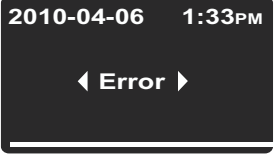
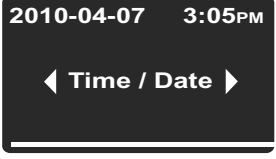

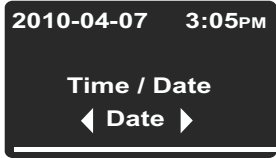
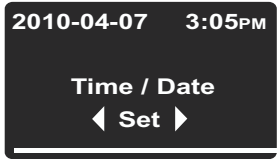
	<p>Press  to activate the menu bar, then use  or  to select the Settings icon and press  to confirm.</p>
	<p>The Error menu item from the Settings submenu appears in the multifunctional display pane.</p>
	<p>Press  to switch to the Time / Date menu item and confirm the selection with .</p>
	<p>The Date menu item is flashing in the multifunctional display pane.</p>

Table 7-28 Setting Date and Time

	<p>From the flashing Date menu item, press  to switch to the Set option and confirm the selection with . The Set menu item is flashing in the multifunctional display pane now, along with the day or year section (depending on the selected date format) of the date field in the upper left corner.</p>
	<p>Press  or  to set the year and confirm your settings with . The flashing selection moves on to the month section of the date field.</p> <p>Set months, days, hours and minutes using  or  and confirm each setting with .</p>
	<p>When you confirm with the button  after setting the minutes, the date and time field in the upper left or right corner will be updated according to your settings (and stop flashing). The display returns to its default mode. The Settings icon in the menu bar will go out.</p>

Temperature Display Unit

The **Settings** -> °C / °F menu item allows for toggling the incubator used for displaying temperatures between degrees Centigrade and Fahrenheit.

Table 7-29 Toggling the Temperature Display Unit











	<p>Press  to activate the menu bar, then use  or  to select the Settings icon and press  to confirm.</p>
	<p>The Error menu item from the Settings submenu appears in the multifunctional display pane.</p>

Table 7-29 Toggling the Temperature Display Unit

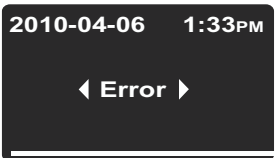
	<p>Press  to switch to the °C / °F menu item and confirm the selection with .</p>
	<p>The multifunctional display pane changes to the following selection screen, with the currently unused temperature display unit (factory setting is °C) flashing. Confirm the selection with .</p>
	<p>The temperatures in the display pane (item D1 in figure 7-1 on page 7-1) and settings pane Set (item D5 in the same figure) will be displayed with the newly selected unit. The display returns to its default mode. The Settings icon in the menu bar will go out.</p>

Shut-down

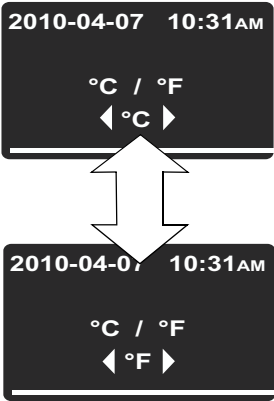
Shutting the Incubator Down

This chapter provides instructions for shutting the incubator down for prolonged periods of time, that is, at least for several days in a row.



	<div style="border: 1px solid black; padding: 5px;"> WARNING Contamination hazard</div> <p>If the work space surfaces are contaminated, harmful biological material may spread to the environment of the incubator.</p> <p>To rule out any risk for subsequent users, perform a full cleaning, disinfection and decontamination cycle to the standards set out in the section “Cleaning and Disinfection” on page 9-1 if you suspect (or if you are positive) that harmful biological material has been processed with the incubator.</p>
--	---

1. Remove the containers with the cultures, all accessories, and other objects from the work space.
2. Clean and disinfect the work space, as explained in the section “[Cleaning and Disinfection](#)” on [page 9-1](#) or - if the above warning note applies - run the dry decontamination routine at 140 °C / 284 °F (see “[Decontamination](#)” on [page 7-16](#)).
3. When cleaning and disinfection and/or decontamination are done, turn the incubator off using the control panel.
4. Unplug the power cord and secure it against accidental reconnection.
5. Until the incubator is shut down, the work space must be continuously ventilated. Leave the door open and secure it against accidental closure.

**Außerbetriebnahme
Inkubator außer Betrieb nehmen**

Cleaning and Disinfection

Cleaning

		Incompatible cleaners
	<p>Some incubator components are made of plastics. Solvents may attack plastics. Strong acids or alkaline solutions may cause embrittlement of plastics.</p>	
		Moisture-sensitive components
	<p>Do not spray cleaning agent onto the control panel and the control box at the rear of the incubator. When wiping the incubator clean, always make sure that no moisture enters into these components.</p>	
	<p>Wipe the display window down with a slightly dampened cloth, then wipe dry with a rag made of 100% microfiber.</p>	

Cleaning Exterior Surfaces

Remove dirt residues and depositions thoroughly using a solution of lukewarm water and commercial detergent.





Wipe the surfaces clean using a clean cloth and clear water.

Then, wipe the surfaces dry using a clean cloth.





Wipe / Spray Disinfection

The manual wipe and spray disinfection is a three-stage process:

- predisinfection
- cleaning
- final disinfection



		Alcoholic disinfectants!
		<p>Disinfectants having an alcohol content of more than 10% may form, in combination with air, easily combustible and explosive gas mixtures.</p>
		<p>When using such disinfectants, avoid open flames or exposure to excessive heat during the entire disinfection process!</p>
		<p>Use such disinfectants only in adequately ventilated rooms.</p>
		<p>After the disinfectant has been allowed to react, wipe the cleaned incubator components thoroughly dry.</p>
		<p>Observe safety regulations to avoid fire and/or explosion hazard caused by alcohol-containing disinfectants.</p>
		Chloride-containing disinfectants!
		<p>Chloride-containing disinfectants can corrode stainless steel.</p>
		<p>Use only disinfectants that do not affect stainless steel!</p>

Preparing the manual wipe/spray disinfection

		Health hazard
		<p>The surfaces of the work space may be contaminated. Contact with contaminated cleaning liquids may cause infections. Disinfectants may contain harmful substances.</p>
		<p>When cleaning and disinfecting, always observe the safety instructions and hygiene guidelines!</p>
		<p>Wear safety gloves.</p>
		<p>Wear safety goggles.</p>
		<p>Wear mouth and respiratory system protection gear to protect your mucous membranes.</p>
		<p>Observe the safety instructions of the disinfectant's manufacturer and the hygiene supervisor.</p>

Predisinfection

1. Remove all samples from the work space and store them in a safe place.
2. Spray disinfectant onto the surfaces of the work space and of the accessories or wipe the surfaces clean using disinfectant.

	<table border="1"><tr><td data-bbox="531 443 896 539"> CAUTION</td><td data-bbox="922 465 1394 539">Risk of injury caused by breaking of glass panel</td></tr><tr><td colspan="2" data-bbox="517 568 1331 674">The glass panel may only be removed by properly trained and authorized specialists. The glass panel must be held by two persons.</td></tr></table>	 CAUTION	Risk of injury caused by breaking of glass panel	The glass panel may only be removed by properly trained and authorized specialists. The glass panel must be held by two persons.	
 CAUTION	Risk of injury caused by breaking of glass panel				
The glass panel may only be removed by properly trained and authorized specialists. The glass panel must be held by two persons.					

3. Allow time for the disinfectant to act as specified by the manufacturer.

	<table border="1"><tr><td data-bbox="531 833 896 929">NOTE</td><td data-bbox="922 855 1433 893">Disinfecting hard-to-reach components</td></tr><tr><td colspan="2" data-bbox="517 945 1291 1016">Spray the sensor and other hard-to-reach components with disinfectant!</td></tr></table>	NOTE	Disinfecting hard-to-reach components	Spray the sensor and other hard-to-reach components with disinfectant!	
NOTE	Disinfecting hard-to-reach components				
Spray the sensor and other hard-to-reach components with disinfectant!					

Cleaning

1. Remove all internals from the specimen chamber.
2. Wipe off the specimen chamber surfaces and the internals that have been removed from the chamber using lukewarm water mixed with standard rinsing agents. Also remove all stubborn stains with warm water and washing-up liquid without residues.
3. Re-rinse the cleansed surfaces 3 to 5 times with autoclaved water to completely remove and cleaning agent residues.
4. After this, wipe the cleansed surfaces and internals dry with a soft, sterile cloth.

Final disinfection



1. Spray the specimen chamber surfaces and the internals removed from this chamber again with disinfectant, or wipe them down.
2. Allow time for the disinfectant to act as specified by the manufacturer.
3. Re-install the internals in the specimen chamber.

Starting the Decontamination Routine

For detailed instructions, please refer to “[Decontamination](#)” on [page 7-16](#) (only applicable for IMH-S Series). Before launching the decontamination routine seal the access port with the supplied plug.

	<div style="background-color: #0056b3; color: white; padding: 5px; text-align: center; font-weight: bold; font-size: 1.2em;">NOTE</div> <p>Recommendations for decontamination</p> <p>The user should be familiar with the internationally recognized “Laboratory Biosafety Manual” (from the World Health Organization (WHO)) and with national, pertinent recommendations. These manuals/recommendations provide information about decontaminants, their use, dilution, properties and possible applications.</p>
--	--

	<div style="background-color: #0056b3; color: white; padding: 5px; text-align: center; font-weight: bold; font-size: 1.2em;">NOTE</div> <p>Opening the door during the decontamination routine</p> <p>If the door will be opened and closed again whilst decontamination is running, the routine returns to a phase which will ensure a continuation without faults.</p>
--	---

	 DANGER Bio-hazard Be sure to determine the current operating condition of the incubator before you open the door! Under specific circumstances, there is a risk that bacteria, viruses, fungi, prions, and other biological substances survive when the decontamination routine is aborted due to a power outage. Normally, the incubator starts over with the decontamination cycle without any need for user intervention upon return of power. Users who fail to notice the power outage, may open the door and/or load the incubator with samples, thus exposing themselves or their samples to bio-hazards without being aware of that risk. Decontamination must be performed immediately if any biohazardous material is spilled in or on the incubator.
---	--

Maintenance

Maintenance and inspection at regular intervals of the features and components listed below are mission-critical to maintain the product in a fully operative and safe condition and avoid malfunctions due to ageing and wear. Failure to perform maintenance on a regular basis may result in:

- deviations in heating performance
- loss of control over temperature distribution throughout the work space
- damage to samples

Inspections and checks

To ensure the operational performance and safety of the incubator and its functions, the components listed below must be checked at regular intervals.

Regular Checks

- Check the incubator for overall cleanliness and remove any residues from previous processes.
- To avoid incubator operation without an appropriate fresh air supply, check the air filter (optional) in the air inlet path for contamination.

Semi-annual Inspection

- Check integrity and proper seating of the door seal.
- Swap the fresh-air filter (accessory) in air inlet.
- Perform functional check of the control panel and of the incubator's built-in controller.
- Perform electrical safety check in accordance with the relevant national regulations.
- Check the locking screw for the glass panel

	<div style="border: 1px solid black; padding: 5px;"><div style="background-color: #0056b3; color: white; padding: 5px; display: inline-block;">NOTE</div> Functional check</div> <p>If safety devices were removed or disabled for inspections, the incubator must not be operated before the safety devices have been reinstalled and checked for their correct function.</p>
--	--

	<div style="border: 1px solid black; padding: 5px;"><div style="background-color: #ffc000; color: black; padding: 5px; display: inline-block;"> WARNING</div> Spare Parts and User Modifications</div> <p>To avoid major malfunctions of the incubator and associated safety hazards that may result in death, serious injuries, or damage to the incubator and other equipment, use spare parts approved by Thermo Scientific only. Third-party spares without approval void the limited warranty.</p> <p>Do not modify the incubator in any way without obtaining the prior written authorization from Thermo Scientific. Unauthorized modifications may compromise operational safety and give rise to hazards that may result in death, serious injuries, or damage to the incubator and other equipment.</p>
--	--

Service Intervals

During ongoing operation, the following service work must be performed:

3-monthly service

Perform the comparative temperature measurement outlined in the following section.

Annual service

Have the incubator inspected and serviced by an authorized Technical Service agent.

	<div style="border: 1px solid black; padding: 5px;"><div style="background-color: #0056b3; color: white; padding: 5px; display: inline-block;">NOTE</div> Service contract</div> <p>Thermo Electron LED GmbH offer a product-specific service contract comprising all necessary tests and service work.</p>
--	---

Preparing Temperature Calibration

To determine the exact measured value of the incubator's integral temperature sensor, a temperature comparison measurement must be performed every three months. If a major temperature deviation is found during this check, temperature calibration is required. During this process, the temperature controller of the incubator is set to the value measured during the temperature comparison measurement.

Use a calibrated measuring instrument with an accuracy of $< \pm 0.1 \text{ }^\circ\text{C}$ ($0.18 \text{ }^\circ\text{F}$) for this test.

To minimize temperature variations during the measurement, put the measuring sensor in an isothermal container (such as a bowl filled with glycerol) before placing it in the work space. Use the center of the work space as the reference location for the comparison measurement.

NOTE	Isothermal Container
Do not use a container filled with water as an isothermal container because the evaporation of water will result in a lower temperature reading.	
NOTE	Excessive Work Space Temperatures
Excessive work space temperatures subsequent to a calibration run can be reduced by leaving the door open for approx. 30 seconds.	

Comparison Measurement Procedure

1. Turn the incubator on using the power switch.
2. Set the temperature set value and allow the incubator to stabilize. This may take several hours.
3. Place the measuring device in the center area of the work space. Alternatively, a temperature sensor may be positioned in this location. Route the connecting cable between the glass panel and the interior tank.
4. Close the doors.
5. Wait until the temperature value displayed on the measuring instrument has stabilized.
6. Use the temperature reading from the measuring device to calibrate temperature control manually, as explained [“Entering the Calibration Reference Temperature Manually”](#) on [page 7-23](#).

Temperature Calibration Procedure

For detailed instructions on how to perform a manual temperature calibration, please refer to the instructions in the section “[Calibration](#)” on [page 7-23](#).

	NOTE	Excessive Work Space Temperatures
	Excessive work space temperatures subsequent to a calibration run can be reduced by leaving the door open for approx. 30 seconds.	

Replacing the Door Seal

The door seal of the outer door is located in the retaining slot.

The door seal should be inspected for any signs of embrittlement at half-yearly intervals.

No tools are required to replace the seal.

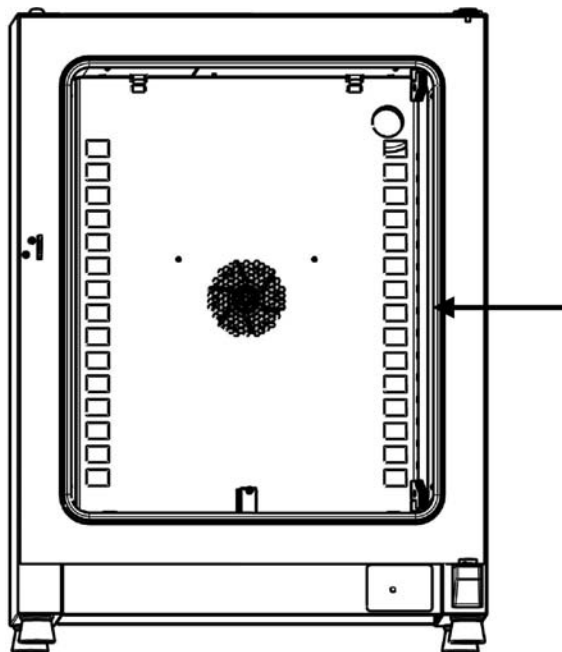

Figure 10-1 Door Seal Replacement

1. Pull the seal out of the guide slot.
2. Starting on the hinge side of the door, position the end of the new seal at the location indicated by the arrow in [figure 10-1](#) above.
3. Gently press the seal into the slot, working around the circumference of the door. In corner areas in particular ensure that the seal lip is installed without any wrinkles and that the seal is not stretched or compressed.
4. Make sure that the retaining rail taper is positioned correctly in the slot and that the seal is flush with the door frame.

Replacing the Power Cord

When the device's power cord is damaged, it must be replaced with an original spare part. Using a standard power cord with a lower temperature withstand class is prohibited.

Returns for Repair

Prior to returning any materials, please contact our Customer Service Department for a "Return Materials Authorization" number (RMA).

Material returned without an RMA number will be refused.

	<div data-bbox="528 689 903 786"> WARNING</div> <p data-bbox="927 712 1238 745">Contamination hazard</p> <p data-bbox="518 801 1407 904">The incubator may have been used for treating and processing infectious substances, which may have caused contamination of the incubator and its components.</p> <p data-bbox="518 909 1390 976">Prior to return shipment, it is therefore mandatory that all incubator components be properly decontaminated.</p> <ul data-bbox="539 999 1390 1193" style="list-style-type: none">• Clean the incubator components thoroughly, then disinfect or decontaminate them (depending on application).• Fill in and attach a safety declaration with details on decontamination activities performed to the items that are to be repaired.
--	---

**Maintenance
Returns for Repair**

Disposal

	 WARNING	Contamination hazard
	<p>The incubator may have been used for treating and processing infectious substances, which may have caused contamination of the incubator and its components. Prior to disposal, it is therefore mandatory that all incubator components be properly decontaminated.</p> <ul style="list-style-type: none"> • Clean the incubator components thoroughly, then disinfect or decontaminate them (depending on application). • Attach a declaration of decontamination with details on decontamination activities performed to the items that are to be disposed of. 	

Overview of Materials Used

Component	Material
Thermal insulation components	Glass wool
Printed circuit boards	Coated electrical components contain various plastics materials. Components mounted on circuit boards containing epoxy resin bonder.
Plastic components, general	see material labelling
Exterior housing	Galvanized steel sheet, painted
Device rear panel	Galvanized steel sheet
Outer door	Galvanized steel sheet, painted, + stainless steel (optional)
Door inner panel	Stainless steel 1.4301
Control panel and display window protective foil	Polyethylene
Heater	IMH-S: Silicone-sheathed resistance heater wires

Disposal
Overview of Materials Used

Component	Material
Interior containers, installed components and shelves	Stainless steel 1.4301
Door frame seal	Silicone
Glass screen	Sodium silicate glass
Fan wheel	Stainless steel 1.4301
Cables	Plastic-sheathed stranded copper wire
Packaging	Corrugated board, polyethylene film, and styrofoam, chemically untreated wood

Error Codes

The [table 12-1](#) below lists the error messages that may appear in the control panel display window (see “[Error Log](#)” on [page 7-22](#)) and provides instructions for clearing such alarms.

Table 12-1 Heratherm Incubator Error Codes

Error Message & Code	Root Cause	Alarm Response	Alarm Clearing Instructions
Door Open Error (E001)	The door switch (IMH-S Series only) has triggered an alarm because the door has been open for more than 10 minutes.	Audible alarm activated, alarm relay energized, message shown on display.	Close the door.
Display Error (E002)	Display communication error. The built-in controller was unable to restore communication with the control panel.	Audible alarm activated, alarm relay energized, message shown on display. Reset after 30 s.	Power cycle the device by unplugging, then reconnecting the power cord. If this doesn't solve the problem, call service.
Mirrored Parameter Loaded (E003)	The controller was unable to read the user-specific settings and had to resort to an emergency parameter set held in mirrored storage.	Alarm relay energized, message shown on display. Fallback to mirrored parameter storage. Device continues to run without loss of functionality, including user-specific settings.	Check the latest settings, for example the set value.
Factory Parameter Loaded (E004)	The controller was unable to read the mirrored parameter set and had to resort to factory-preset parameters.	Audible alarm activated, alarm relay energized, message shown on display. Fallback to factory-preset parameters. User-specific settings may be lost - for example, the temperature display unit preference, or user programs.	Acknowledge by pressing  . Re-enter customer-specific settings.
Default Parameter Loaded (E005)	The controller was unable to read the factory-preset parameters and had to resort to default settings	Fallback to default parameters. Audible alarm activated, alarm relay energized, message shown on display. The device is completely inoperative.	Call service.

Table 12-1 Heratherm Incubator Error Codes

Error Message & Code	Root Cause	Alarm Response	Alarm Clearing Instructions
Disinfection Routine Error (E006)	Process error in decontamination routine. Controller, heater, or fan error, etc.	Abort decontamination. Audible alarm activated, alarm relay energized, message shown on display.	Acknowledge by pressing  . Relaunch decontamination. If this doesn't solve the problem, call service.
Power Down Error (E007)	Power has been cut off (power outage) while the device was running.	Audible alarm activated, alarm relay energized, message shown on display.	Check the power supply. Power up then device, then acknowledge the alarm by pressing  .
Fan Error (E009)	Fan speed out of range	Audible alarm activated, alarm relay energized, message shown on display.	Acknowledge by pressing  . Readjust using the control panel. If error does not go away, call service.
Config Error (E012)	General device configuration error.	Audible alarm activated, alarm relay energized, message shown on display. The device is completely inoperative.	Call service.
OTP Error (E013)	Klixon contact not closed.	Overtemperature Protection fault. Audible alarm activated, alarm relay energized, message shown on display. Bridging across Klixon contact has failed	Restart the incubator. If this doesn't solve the problem, call service.
Incorrect voltage (E014)	The applied voltage is too high or too low.	Audible alarm activated, error message shown on display.	Apply the correct voltage as indicated on the nameplate and acknowledge the error.
Sensor Error (E100)	The actual measured value is out of range.	Audible alarm activated, alarm relay energized, message shown on display. Control transferred to reference sensor. If both sensors are defective, all control circuits will be disabled.	Call service.
Temperature too high (E101)	Actual value exceeds setpoint (heater defective). Actual measured value exceeds permissible range. The Triac is defective.	Audible alarm activated, alarm relay energized, message shown on display. Process protection activated, control continues on set value.	If the error occurs repeatedly, call service.

Table 12-1 Heratherm Incubator Error Codes

Error Message & Code	Root Cause	Alarm Response	Alarm Clearing Instructions
Temperature Too Low (E102) (Actual value too low) (only on devices equipped with a door switch)	Actual measured value falls short of permissible range. Only on devices equipped with a door switch.	Audible alarm activated, alarm relay energized, message shown on display. Temperature control continued.	Check the AC mains supply for an undervoltage condition and have the problem remedied, if necessary. Check whether the incubator has been overloaded with samples. If this doesn't solve the problem, call service.
Temperature not plausible (E103)	The difference between the control and reference sensors exceeds the maximum permissible deviation, rendering the measurement implausible.	Device uses the sensor that indicates the higher temperature for servo control. Audible alarm activated, alarm relay energized, message shown on display. Error can be acknowledged and doesn't reset.	If the error occurs repeatedly, call service.
Calibration value too high (E104)	The calibration reference value calculated on the basis of the user input falls short of the upper limit for calibration references.	Audible alarm activated, alarm relay energized, message shown on display. Fall back to previous calibration reference.	Check the external reference sensor for proper function and replace, if necessary. If this doesn't solve the problem, call service.
Calibration Value Too Low (E105)	The calibration reference value calculated on the basis of the user input exceeds the lower limit for calibration references.	Audible alarm activated, alarm relay energized, message shown on display. Fall back to previous calibration reference.	Check the external reference sensor for proper function and replace, if necessary. If this doesn't solve the problem, call service.
Constant sensor signal (E106)	None of the decimal places of the A/D-converter output for the process sensor has changed over a specific time period.	Audible alarm activated, alarm relay energized, message shown on display. Use reference sensor. If both sensors are defective, all control circuits will be disabled.	Call service.
Constant Reference Sensor Signal (E107)	None of the decimal places of the A/D-converter output for the process sensor has changed over a specific time period.	Audible alarm activated, alarm relay energized, message shown on display. Control continues on process sensor, text message on display. If both sensors are defective, all control circuits will be disabled.	Call service.
Constant Sample Sensor signal (E108)	None of the decimal places of the A/D-converter output for the process sensor has changed over a specific time period.	Audible alarm activated, alarm relay energized, message shown on display.	Call service.

Table 12-1 Heratherm Incubator Error Codes

Error Message & Code	Root Cause	Alarm Response	Alarm Clearing Instructions
Heating relay error (E109)	The voltage measurement has indicated a defect in the heater circuit relay.	The device is completely inoperative. Audible alarm activated, alarm relay energized, message shown on display.	Be sure to pull the power plug and disconnect the device from the AC mains. Call service.
Heating triac error (E110)	The voltage measurement has indicated a defect in the triac.	Audible alarm activated, alarm relay energized, message shown on display. Overheat protection activated to prevent destruction of the samples. Audible alarm returns upon acknowledgement.	Call service and switch the device off.
Temperature too high (E111)	Actual measured value exceeds permissible range.	Audible alarm activated, alarm relay energized, message shown on display. Heater turned off until upper limit of hysteresis is recovered. Temperature control continued. Alarm can be acknowledged, and goes away when the difference between the actual and set values ceases to exist. Note: This error does not indicate a defective triac!	Open the door and cool-down. Check whether the device was loaded with a hot object, if so, remove. Ensure that the equipment was operated with at least one perforated shelve and with the door not opened longer than 10 min. If this doesn't solve the problem, call service.
Sensor error (E112)	The measured actual value is out of range.	Audible alarm activated, alarm relay energized, message shown on display. Control continues on process sensor. If both sensors are defective, all control circuits will be disabled.	Call service.
Sensor error (E113)	The measured actual value is out of range,	Audible alarm activated, alarm relay energized, message shown on display.	Call service.
ADC error (E114)	A/D converter does not supply a plausible output. Measurement across reference resistor has failed.	Audible alarm activated, alarm relay energized, message shown on display. All control circuits disabled.	Call service.
Watchdog error (E115)	Watchdog test failed on power-up.	Audible alarm activated, alarm relay energized, message shown on display.	Call service.

*.The rectification of an error is deemed to have been successful when the audible alarm stops sounding, the alarm relay drops out and the message disappears from the control panel display.

Technical Data

The technical data are valid only for an empty device equipped with three shelves, a spray-painted outer enclosure and a power line voltage 230 V / 50 Hz. Options may have an impact on the specified performance.

Table 13-1 Technical Data - Series IMH 60/100/180 and IMH 60-S/100-S/180-S

Parameter	Unit	IMH 60	IMH 100	IMH 180	IMH 60-S	IMH 100-S	IMH 180-S
Process (First value is with fan off, second with fan running)							
Temperature deviation from set value at 37 °C (99 °F), spatial. Typical value	K	±0.6/±0.2	±0.6/±0.3	±0.6/±0.4	±0.6/±0.2	±0.6/±0.3	±0.6/±0.4
Max. value	K	±0.6/±0.3	±0.6/±0.4	±0.6/±0.5	±0.6/±0.3	±0.6/±0.4	±0.6/±0.5
Temperature deviation from set value at 37 °C (99 °F), over time	K	±0.1	±0.1	±0.1	±0.1	±0.1	±0.1
Work space atmosphere, Min.	°C/°F	Amb. temp. plus 5 °C/41 °F	Amb. temp. plus 5 °C/41 °F	Amb. temp. plus 5 °C/41 °F	Amb. temp. plus 5 °C/41 °F	Amb. temp. plus 5 °C/41 °F	Amb. temp. plus 5 °C/41 °F
Max.	°C/°F	105°C/221°F	105°C/221°F	105°C/221°F	105°C/221°F	105°C/221°F	105°C/221°F
Heat-up time (work space unoccupied, from 25 °C (77 °F) to 98% of set temperature of 37 °C/99 °F) Max. value/Typical value	min	25 / 22	35 / 42	35 / 42	25 / 22	35 / 42	35 / 42
Recovery time (work space unoccupied, door open for 30 s, to set temperature of 37 °C (99 °F)). Max. value/Typical value	min	6 / 4 5 / 2.5	5 / 4 4 / 2.5	5 / 4 4 / 2.5	6 / 4 5 / 2.5	5 / 4 4 / 2.5	5 / 4 4 / 2.5
Heat dissipation to environment (at set temperature of 37 °C (99 °F) and room temperature of 25 °C/77 °F). Typical value	W	23/65 ±10%	30/68 ±10%	36/78 ±10%	23/65 ±10%	30/68 ±10%	36/78 ±10%
Overall dimensions							
Height	mm/in	720/ 28.3	820/ 32.3	920/ 36.2	720/ 28.3	820/ 32.3	920/ 36.2
Width	mm/in	530/ 20.8	640/ 25.2	640/ 25.2	530/ 20.8	640/ 25.2	640/ 25.2
Depth	mm/in	565/ 22.2	565/ 22.2	738/ 29.1	565/ 22.2	565/ 22.2	738/ 29.1

Table 13-1 Technical Data - Series IMH 60/100/180 and IMH 60-S/100-S/180-S

Parameter	Unit	IMH 60	IMH 100	IMH 180	IMH 60-S	IMH 100-S	IMH 180-S
Overall weight	kg/lbs	45/99	56/123	70/154	45/99	56/123	70/154
Loading capacity	kg/lbs	25/55			25/55		
Max. overall loading capacity per device	kg/lbs	50/110	50/110	75/165	50/110	50/110	75/165
Electrical data							
	W	850	1100	1300	1390	1390	1390
	A	3.7	4.8	5.7	6.1	6.1	6.1
Earthing system (e.g. 1/N/PE)		1/N/PE	1/N/PE	1/N/PE	1/N/PE	1/N/PE	1/N/PE
Power line frequency	Hz	50/60			50/60		
Power line voltage +/- 10 %	V	230			230		
IP protection system		IP 20			IP 20		
Protection class		I			I		
Overvoltage category as per IEC 60364-4-443		II			II		
Device fusing, building side	A	16			16		
Device fusing, on PCB	A	2 x 16			2 x 16		
Environmental conditions							
Min. ambient temperature	°C/°F	18/65			18/65		
Max. ambient temperature	°C/°F	32/90			32/90		
Max. humidity in service, non condensing	% r.F./ % r.H.	80, non condensing			80, non condensing		
Min. storage temperature	°C/°F	20/68			20/68		
Max. storage temperature	°C/°F	60/140			60/140		
Max. humidity in storage, non condensing	% r.F./ % r.H.	90, non condensing			90, non condensing		
Post-transport acclimation time	h	2			2		
Noise level	dB(A)	45			45		
Degree of pollution as per IEC EN 61010-1		2			2		
Site conditions							
Maximum altitude above sea level	m/y ASL	2000/2187			2000/2187		
Minimum side clearance	mm/in	50/2			50/2		
Minimum front clearance	mm/in	590 / 23.2	690 / 27.2	814 / 32	590 / 23.2	690 / 27.2	814 / 32
Minimum back wall clearance	mm/in	80/3.2			80/3.2		

Table 13-1 Technical Data - Series IMH 60/100/180 and IMH 60-S/100-S/180-S

Parameter	Unit	IMH 60	IMH 100	IMH 180	IMH 60-S	IMH 100-S	IMH 180-S
Minimum bottom clearance	mm/in		200/8			200/8	
Minimum top clearance	mm/in		300/12			300/12	

Table 13-2 Technical Data - Series IMH 400-S / IMH 750-S

Parameter	Unit	IMH 400-S	IMH 750-S
Process			
Work space atmosphere, Min.	°C/°F	Amb. temp. plus 5 °C/41 °F	Amb. temp. plus 5 °C/41 °F
Max.	°C/°F	105 °C/221 °F	105 °C/221 °F
Temperature deviation from set value at 37 °C (99 °F), spatial. Max. value/typical value	K	±0.3/±0.2	±0.4/±0.3
Temperature deviation from set value at 37 °C (99 °F), over time	K	±0.2	±0.2
Heat-up time (work space unoccupied, from 25 °C (77 °F) to 98% of set temperature of 37 °C/99 °F)	min	35	30
Recovery time (work space unoccupied, door open for 30 s. Max. value/Typical value	min	< 3 / < 2	< 3 / < 2
Heat dissipation to environment (at set temperature of 37 °C (99 °F) and room temperature of 25 °C/77 °F).	W	87 ±10%	149 ±10%
Overall dimensions			
Height (with casters)	mm/in	1655/ 65.2	1655/ 65.2
Width	mm/in	755/ 29.7	1215/ 47.8
Depth	mm/in	770/ 30.3	770/ 30.3
Overall weight	kg/lbs	145/320	205/452
Loading capacity	kg/lbs	30/66	30/88
Max. overall loading capacity per device	kg/lbs	75/165	150/330
Electrical data			
Power rating	W	1400	1600
Max. Current	A	6.0	7.0
Earthing system (e. g. 1/N/PE)		1/N/PE	1/N/PE
Power line frequency	Hz	50/60	
Power line voltage +/- 10 %	V	230	

Table 13-2 Technical Data - Series IMH 400-S / IMH 750-S

Parameter	Unit	IMH 400-S	IMH 750-S
IP protection system			IP 20
Protection class			I
Overvoltage category as per IEC 60364-4-443			II
Device fusing, building side	A		16
Device fusing, on PCB	A		2 x 16
Environmental conditions			
Min. ambient temperature	°C/°F		18/65
Max. ambient temperature	°C/°F		32/90
Max. humidity in service, non condensing	% r.F./ % r.H.		80, nicht kondensierend
Min. storage temperature	°C/°F		20/68
Max. storage temperature	°C/°F		60/140
Max. humidity in storage, non condensing	% r.F./ % r.H.		90, nicht kondensierend
Post-transport acclimation time	h		2
Noise level	dB(A)		36 dB
Degree of pollution as per IEC EN 61010-1			2
Site conditions			
Maximum altitude above sea level	m/y ASL		2000/2187
Minimum side clearance	mm/in		50/2
Minimum front clearance	mm/in	810 / 31.9	670 / 26.4
Minimum back wall clearance	mm/in		120/4.7
Minimum top clearance	mm/in		200/7.9

Spare Parts and Accessories

Material No.	Description
50126665	Stacking adapter Heratherm 60L
50126666	Stacking adapter Heratherm 100L
50126667	Stacking adapter Heratherm 180L
50127146	Fresh air filter IMH / IMH-S
50127431	Outer door for Heratherm IGS 60, IMH 60, IMH 60-S, OMS 60, OMH 60, OMH 60-S, OGS 60, OGH 60 and OGH 60-S with a door stop on the left side
50127432	Outer door for Heratherm IGS 100, IMH 100, IMH 100-S, OMS 100, OMH 100, OMH 100-S, OGS 100, OGH 100 and OGH 100-S with a door stop on the left side
50127433	Outer door for Heratherm IGS 180, IMH 180, IMH 180-S, OMS 180, OMH 180, OMH 180-S, OGS 180, OGH 180 and OGH 180-S with a door stop on the left side
50127434	Outer door for Heratherm IGS 60, IMH 60, IMH 60-S, OMS 60, OMH 60, OMH 60-S, OGS 60, OGH 60 and OGH 60-S with a door stop on the right side
50127435	Staple feet Heratherm incubators and heating & drying ovens
50127436	Kit door seal for Heratherm 60L
50127437	Kit door seal for Heratherm 100L
50127438	Kit door seal for Heratherm 180L
50127439	Kit door clips for Heratherm 60L / 100L / 180 L
50127440	Door inner panel seal for Heratherm IMH 60 and IMH 60-S
50127441	Door inner panel seal for Heratherm IMH 100 and IMH 100-S
50127442	Door inner panel seal for Heratherm IMH 180 and IMH 180-S
50127443	Levelling feet for Heratherm incubators and heating & drying ovens
50127444	Kit door handle right Heratherm incubators and heating & drying ovens
50127445	Kit door handle left Heratherm incubators and heating & drying ovens
50127446	Kit door handle with lock right Heratherm incubators and heating & drying ovens
50127447	Kit door handle with lock left Heratherm incubators and heating & drying ovens
50127449	Temperature sensor for Heratherm incubators

Material No.	Description
50127450	Upper door hinge for Heratherm incubators and heating & drying ovens
50127451	Lower door hinge for Heratherm incubators and heating & drying ovens
50127455	Outer door for Heratherm IGS 100, IMH 100, IMH 100-S, OMS 100, OMH 100, OMH 100-S, OGS 100, OGH 100 and OGH 100-S with a door stop on the right side
50127456	Outer door for Heratherm IGS 180, IMH 180, IMH 180-S, OMS 180, OMH 180, OMH 180-S, OGS 180, OGH 180 and OGH 180-S with a door stop on the right side
50127457	Kit operating panel Heratherm General Protocol incubators and heating & drying ovens
50127458	Kit operating panel Heratherm Advanced Protocol and Advanced Protocol Security incubators and heating & drying ovens
50127461	Kit electronic insert Heratherm General Protocol incubators and heating & drying ovens
50127462	Kit electronic insert Heratherm Advanced Protocol and Advanced Protocol Security incubators and heating & drying ovens without main board fan.
50127463	Mainboard cable for Heratherm incubators and heating & drying ovens
50127468	Glass door hinges for Heratherm incubators
50127469	Door switch for the right side of Heratherm incubators and heating & drying ovens
50127470	Door switch for the left side of Heratherm incubators and heating & drying oven
50127472	Kit glass door IGS 60, IMH 60, IMH 60-S
50127473	Kit glass door IGS 100, IMH 100, IMH 100-S
50127474	Kit glass door IGS 180, IMH 180, IMH 180-S
50127478	Temperatur limiter for IMH-S
50127480	Door hook catch for Heratherm incubators and heating & drying ovens with a door stop on the right side
50127481	Door hook catch for Heratherm incubators and heating & drying ovens with a door stop on the left side
50127482	Magnetic door hook catch for Heratherm incubators and heating & drying ovens with a door stop on the right side
50127483	Magnetic door hook catch for Heratherm incubators and heating & drying ovens with a door stop on the left sid
50127497	Heating coils for Heratherm IMH-S at a voltage of 120 V
50127498	Heating coils for Heratherm IMH-S at a voltage of 230 V
50127504	Kit Heating coils IMH 120 V
50127511	Kit fan system Heratherm IMH 60 IMH 60-S, OMH 60 and OMH 60-S, IMH 100, IMH 100-S, IMH 180 and OMH 180-S, 120 V.
50127515	Kit Heating coils IMH 230 V
50127531	Circulation fan IMH / IMH-S D = 160 mm (6.3 inch), H = 28 mm (1.1 inch)

Material No.	Description
50127555	Kit fan system Heratherm IMH 60 IMH 60-S, OMH 60 and OMH 60-S, IMH 100, IMH 100-S, IMH 180 and OMH 180-S, 230 V
50127567	Fresh air filter for IMH, IMH-S
50127741	Support stand with castors for Heratherm 60L
50127742	Support stand with castors for Heratherm 100L
50127743	Support stand with castors for Heratherm 180L
50127764	Wire mesh shelf IGS 60/100/180, IMH 60/100/180, IMH 60/100/180-S, including 2 shelf supports
50127768	Sample sensor for IMH 60-S / IMH 100-S / IMH 180-S
50127770	Stainless steel perforated shelf IGS 60, including 2 shelf supports
50127771	Stainless steel perforated shelf IGS 100, including 2 shelf supports
50127772	Stainless steel perforated shelf IGS 180, including 2 shelf supports
50127773	Stainless steel perforated shelf IMH 60/IMH 60-S/OMH 60/OMH 60-S/OMS 60/100/180, including 2 shelf supports
50127774	Stainless steel perforated shelf IMH 100 / IMH 100-S / OMH 100 / OMH 100-S/OMS 60/100/180, including 2 shelf supports
50127777	Stainless steel perforated shelf IMH 180 / IMH 180-S / OMH 180 / OMH 180-S/OMS 60/100/180, including 2 shelf supports
50127861	Retaining springs for Heratherm incubators and heating & drying ovens
50127862	Support rail for Heratherm IGS 60, IMH 60, IMH 60-S, OMS 60, OMH 60, OMH 60-S
50127863	Support rail for Heratherm IGS 100, IMH 100, IMH 100-S, OMS 100, OMH 100, OMH 100-S
50127864	Support rail for Heratherm IGS 180, IMH 180, IMH 180-S, OMS 180, OMH 180, OMH 180-S
50128179	Kit Fuses T2A Incubators 120 V
50128184	Sample sensor connection for Heratherm incubators and heating & drying ovens
50128197	Power socket for Heratherm IMH
50128203	Kit Fuses T2A Incubators 230 V
50128212	Fuse holder for Heratherm IMH
50128237	Kit Key for door handle with lock Heratherm
50128265	Lowenstein holder IGS 100 / IMH 10 / IMH 100-S / IGS 180 / IMH 180 / IMH 180-S
50128683	Drip tray IGS / IMH / IMH-S 60L
50128704	Kit Anti-tilt anchor
50128791	Drip tray IGS / IMH / IMH-S 100L
50128792	Drip tray IGS / IMH / IMH-S 180L

Spare Parts and Accessories

Material No.	Description
50128793	Petri dish holder 50 mm (2 inch) IGS 60 / IMH 60 / IMH 60-S
50128794	Petri dish holder 50 mm (2 inch) IGS 100 / IMH 100 / IMH 100-S
50128815	Petri dish holder 50 mm (2 inch) IGS 180 / IMH 180 / IMH 180-S
50128816	Petri dish holder 90 mm (3.54 inch) IGS 60 / IMH 60 / IMH 60-S
50128818	Petri dish holder 90 mm (3.54 inch) IGS 100 / IMH 100 / IMH 100-S
50128819	Petri dish holder 90 mm (3.54 inch) IGS 180 / IMH 180 / IMH 180-S
50128960	Kit Shelving system with glass door lock IGS 60, IMH 60, IMH 60-S
50128961	Kit Shelving system with glass door lock IGS 100, IMH 100, IMH 100-S
50128962	Kit Shelving system with glass door lock IGS 180, IMH 180, IMH 180-S
50130657	Kit Viton door seal 60 L Heratherm
50130658	Kit Viton door seal 100 L Heratherm
50130659	Kit Viton door seal 180 L Heratherm
50134116	Kit Heating coil IGS 400, 750 120 V, centre
50134117	Kit Heating coil IGS 400, 750 230 V, centre
50134120	Kit Heating coil IGS 750 120 V, outside
50134121	Kit Heating coil IGS 750 230 V, outside
50134122	Kit Heating coil IMH 750 120 V, ring heater
50134123	Kit heating coil IMH 750 230 V, ring heater
50134315	Kit DS bus cable cpl 400 / 750
50134322	Kit glass door cpl 400 HTM
50134323	Kit glass door ri / le cpl 750 HTM
50134326	Door gasket 400 L HTM
50134327	Door gasket 750 L HTM
50134328	Kit profile gasket 750 L HTM
50134329	Kit door conn. clips 400 / 750 HTM
50134333	Kit castors 400 / 750 HTM
50134334	Kit shelf rack set cpl HTM 400 / 750
50135043	Kit electric insert cpl HTM H floorstand
50135044	Kit electric insert cpl HTM S floorstand
50135055	Kit electric insert cpl HTM 3 PH floor
50135056	Kit glass door hinges cpl 400/750 L HTM
50135058	Kit door lock 750 left cpl HTM
50135059	Kit door lock 750 right cpl HTM

Material No.	Description
50135060	Door outer casing left HTM 400
50135061	Door outer casing right HTM 400
50135062	Door outer casing left HTM 750
50135063	Door outer casing right HTM 750
50135150	Kit temp sensor cpl HTM incubator floor
50135153	Kit door lock 400 right cpl HTM
50135154	Kit door lock 400 left cpl HTM

Contact

Overview of Thermo Fisher International Sales Organization

Postal address in Germany

Thermo Electron LED GmbH
Robert-Bosch-Straße 1
D - 63505 Langenselbold

Enquiries from Germany:

Phone

Sales 0800 1 536376

Service 0800 1 112110

Fax

Sales/Service 0800 1 112114

Email info.labequipment.de@thermofisher.com

Enquiries from Europe, Middle East and Africa:

Phone. + 49 (0) 6184 / 90-6940

Fax + 49 (0) 6184 / 90-6772

E-Mail info.labequipment.de@thermofisher.com

Postal address USA:

Thermo Scientific
275 Aiken Road
Asheville, NC 28804
USA

Enquiries from North America:

Phone +1 800-879 7767

Fax +1 828-658 0363

E-Mail info.labequipment@thermofisher.com

Enquiries from Latin America:

Phone +1 828-658 2711

Fax +1 828-645 9466

E-Mail info.labequipment@thermofisher.com

Enquiries from Asia Pacific:

Phone +852-2711 3910

Fax +852-2711 3858

E-Mail info.labequipment@thermofisher.com

Thermo Fisher Scientific, Inc.
81 Wyman Street
P.O. Box 9046
Waltham, MA 02454-9046
United States

www.thermo.com