

Thermo Scientific Heratherm General Protocol Heating and Drying Ovens

OGS 60/100/180/400/750
OMS 60/100/180

Operating Instructions

50125556 B

14.06.12



© 2012 Thermo Fisher Scientific Inc. All rights reserved.

This Instruction Manual is copyright protected. Rights resulting thereof, particularly reprint, photomechanical or digital postprocessing or reproduction, even in part, are only allowed with the written consent of Thermo Electron LED GmbH. This regulation does not apply to reproductions for in-plant use.

The contents of this operating instructions manual may change at any time and without any prior notice. Concerning translations into foreign languages, the German version of these operating instructions is binding.

Trademarks

Heratherm[®] is a registered trademark of Thermo Scientific.

Thermo Scientific is a brand owned by Thermo Fisher Scientific Inc.

All other trademarks mentioned in the operating instructions are the exclusive property of the respective manufacturers.

Thermo Electron LED GmbH

Robert-Bosch-Straße 1

D - 63505 Langenselbold

Germany

Thermo Electron LED GmbH is an affiliate to:

Thermo Fisher Scientific Inc.

81 Wyman Street

Waltham, MA 02454

USA

Thermo Fisher Scientific Inc. provides this document to its customers with a product purchase to use in the product operation. This document is copyright protected and any reproduction of the whole or any part of this document is strictly prohibited, except with the written authorization of Thermo Fisher Scientific Inc.

The contents of this document are subject to change without notice.

All technical information in this document is for reference purposes only. System configurations and specifications in this document supersede all previous information received by the purchaser.

Thermo Fisher Scientific Inc. makes no representations that this document is complete, accurate or error-free and assumes no responsibility and will not be liable for any errors, omissions, damage or loss that might result from any use of this document, even if the information in the document is followed properly.

This document is not part of any sales contract between Thermo Fisher Scientific Inc. and a purchaser. This document shall in no way govern or modify any Terms and Conditions of Sale, which Terms and Conditions of Sale shall govern all conflicting information between the two documents.

Contents

Chapter 1	Safety Notes	1-1
	Basic operating precautions	1-1
	Operational Safety Rules	1-2
	Warranty	1-2
	Explanation of Safety Information and Symbols	1-3
	Safety Notes and Symbols Used Throughout These Operating Instructions	1-3
	Additional symbols for safety information	1-4
	Symbols on the Oven	1-5
	Intended use of the device	1-5
	Correct use	1-5
	Incorrect Use	1-5
	Standards and Directives	1-6
Chapter 2	Delivery of the Oven	2-1
	Packaging	2-1
	Acceptance Inspection	2-1
	Scope of Supply	2-2
Chapter 3	Installation	3-1
	Ambient conditions	3-1
	Location Requirements	3-1
	Use with Air Exhaust Systems	3-1
	Intermediate Storage	3-2
	Room Ventilation	3-3
	Use with Air Exhaust Systems	3-3
	Space Requirement	3-4
	Installation Built-in Units	3-4
	Table-top units	3-5
	Floor stand units	3-6
	Transport	3-8
	Stacking Kit	3-10
	Installing the Stacking Feet	3-10
	Installing the Stacking Adapter	3-11
	Installing the Anti-tilt Anchor	3-12
	Floor stand unit spacers	3-14
Chapter 4	Product Description	4-1
	Heratherm OGS Series Oven Overview	4-1
	Heratherm OMS Series Oven Overview	4-8
	Safety Devices	4-10
	Work Space Atmosphere	4-10

Sensing and Control System	4-10
Data Communications & Alarm Interface	4-11
RS 232 Interface	4-11
AC Power Socket	4-11
Fuses	4-12
Work Space Components	4-12
Inner Chamber	4-12
Tube Access Ports	4-14
Chapter 5 Start-up	5-1
Installing the Shelf System of the table-top units	5-1
Initial installation	5-1
Installing the Shelving	5-2
Preparing the Work Space	5-3
Table-top units	5-3
Installing and Uninstalling the Support Rails (OMS Series only)	5-3
Installing and Uninstalling the Rear Air baffle (OMS Series only)	5-4
Installing and Uninstalling the Lateral Air Baffles (OGS Series only)	5-5
Commissioning of floor-mounted units	5-7
Installing/Removing air baffles (OGS Series)	5-7
Commissioning, general	5-8
Installing the Shelf Support Brackets	5-8
Installing the Wire-mesh Shelves	5-9
Leveling the Table-top units	5-9
Mains Connection	5-9
Connection to the power supply source	5-10
Connecting the RS-232 Interface	5-11
Interconnecting the Oven with a Computer	5-11
Chapter 6 Operation	6-1
Preparing the Oven	6-1
Starting Operation	6-1
Chapter 7 Handling and Control	7-1
Powering Up	7-5
Switching the Oven Off / Powering Down	7-5
Temperature Set Value	7-6
Timer	7-7
Stopping a Timer	7-8
Settings	7-9
Error Log	7-9
Calibration	7-10
Temperature Display Unit	7-11
Configuration	7-12
Chapter 8 Shut-down	8-1
Shutting the Oven Down	8-1
Chapter 9 Cleaning and Disinfection	9-1
Cleaning	9-1

Cleaning Exterior Surfaces.....	9-1
Wipe / Spray Disinfection	9-1
Preparing the manual wipe/spray disinfection.....	9-2
Predisinfection	9-3
Chapter 10 Maintenance.....	10-1
Inspections and Checks.....	10-1
Service Intervals.....	10-2
Preparing Temperature Calibration	10-2
Comparison Measurement Procedure.....	10-3
Temperature Calibration Procedure	10-3
Replacing the Door Seal.....	10-4
Replacing the Power Cord.....	10-4
Returns for Repair	10-4
Chapter 11 Disposal.....	11-1
Overview of Materials Used	11-1
Chapter 12 Error Codes.....	12-1
Chapter 13 Technical Data	13-1
Chapter 14 Spare Parts and Accessories	14-1
Chapter 15 Device Log	15-1
Chapter 16 Contact	16-1

List of Figures

Figure 3-1 Table-top oven units OGS 60 / OGS 100 / OGS 180, dimensions and required clearances	3-5
Figure 3-2 Floor stand ovens OGS 400, dimensions and required clearances	3-6
Figure 3-3 Floor stand ovens OGS 750, dimensions and required clearances	3-7
Figure 3-4 Lift Points.....	3-8
Figure 4-1 Heratherm OGS 60 / OGS 100 / OGS 180 Series Front View	4-2
Figure 4-2 Heratherm OGS 60 / OGS 100 / OGS 180 Series Rear View	4-3
Figure 4-3 Heratherm OGS 400 Series Front View	4-4
Figure 4-4 Heratherm OGS 400 Series Rear View.....	4-5
Figure 4-5 Heratherm OGS 750 Series Front View	4-6
Figure 4-6 Heratherm OGS 750 Series Rear View.....	4-7
Figure 4-7 Heratherm OMS Series Front View.....	4-8
Figure 4-8 Heratherm OMS Series Rear View	4-9
Figure 4-9 Sensor Mounting Location - OGS Series and OMS Series - Table-top units	4-10
Figure 4-10 Sensor Mounting Location - OGS Series and OMS Series - Floor stand units	4-10
Figure 4-11 Signal Interfaces and Power Socket.....	4-11
Figure 4-12 Shelf System - OGS Series Oven - Table-top units	4-13
Figure 4-13 Shelf System - OMS Series Oven - Table-top units.....	4-13
Figure 4-14 Tube Access Ports.....	4-14
Figure 5-1 Sliding the Retaining Spring into the Support Rail.....	5-1
Figure 5-2 OGS Series - Installing the Shelving	5-2
Figure 5-3 OMS Series - Installing the Shelving.....	5-2
Figure 5-4 Support Rail Installation.....	5-3
Figure 5-5 Installing the Rear Air Baffle.....	5-4
Figure 5-6 Removing the Bottom Panel.....	5-5
Figure 5-7 Bottom Panel Removed.....	5-5
Figure 5-8 Removing the Lateral Air Baffle.....	5-6
Figure 5-9 Removing the bottom plate	5-7
Figure 5-10 Removing the left and right support profiles.....	5-7
Figure 5-11 Removing the rear air baffle OGS 400/750	5-7
Figure 5-12 Shelf Support Bracket Installation	5-8
Figure 5-13 Wire-mesh shelf.....	5-9
Figure 5-14 AC Power Supply Socket.....	5-10
Figure 7-1 Control panel for Heratherm OGS Series and OMS Series Ovens.....	7-1
Figure 10-1 Door seal replacement (example showing OMH Series oven)	10-4

List of Figures

Safety Notes

Basic operating precautions

These operating instructions describe Heratherm ovens.

Heratherm ovens have been manufactured to the latest state of the art and been tested thoroughly for flawless functioning prior to shipping. However, the oven may present potential hazards, particularly if it is operated by inadequately trained personnel or if it is not used in accordance with the intended purpose. Therefore, the following must be observed for the sake of accident prevention:

- Heratherm ovens must be operated by adequately trained and authorized professional personnel.
- Heratherm ovens must not be operated unless these operating instructions have been fully read and understood.
- The present operating instructions, applicable safety data sheets, plant hygiene guidelines and the corresponding technical rules issued by the operator shall be used to create written procedures targeted at personnel working with the subject matter device, detailing:
 - the safety precautions to be taken when processing specific agents,
 - the measures to be taken in case of accidents.
- Repair work on the oven must be carried out only by trained and authorized expert personnel.
- The contents of these operating instructions are subject to change at any time without further notice.
- Concerning translations into foreign languages, the German version of these operating instructions is binding.
- Keep these operating instructions close to the oven so that safety instructions and important information are always accessible.
- Should you encounter problems that are not detailed adequately in these operating instructions, please contact Thermo Electron LED GmbH immediately for your own safety.

Operational Safety Rules

The following rules must be heeded when working with Heratherm ovens:

- Observe the sample weight limits specified for your Heratherm oven as a whole and its shelving in particular; see “[Technical Data](#)” on [page 13-1](#)).
- Do not load the bottom of the interior workspace to avoid the risk of overheating any samples placed there.
- Arrange the samples evenly throughout the work space, making sure not to place them too closely to the interior walls to ensure a uniform temperature distribution.
- Do not load your Heratherm oven with substances that exceed the capabilities of the available lab apparatus and Personal Protection Equipment to provide sufficient degrees of protection to users and third parties.
- Check the door seal once a week for proper sealing performance and possible damage.
- Do not process any samples containing hazardous chemical substances that may be released into the ambient air through defective seals or may cause corrosion or other defects on parts of the Heratherm oven.

Warranty





Thermo Electron LED GmbH warrants the operational safety and functions of the Heratherm ovens only under the condition that:

- the oven is operated and serviced exclusively in accordance with its intended purpose and as described in these operating instructions,
- the oven is not modified,
- only original spare parts and accessories that have been approved by Thermo Electron LED GmbH are used (third-party spares without Thermo Electron LED GmbH approval void the limited warranty),
- inspections and maintenance are performed at the specified intervals,
- an installation verification test is performed on commissioning the oven for the first time and repeated after each inspection and repair activity.









The warranty is valid from the date of delivery of the oven to the customer.

Explanation of Safety Information and Symbols

Safety Notes and Symbols Used Throughout These Operating Instructions

	 <p>Indicates a hazardous situation which, if not avoided, will result in death or serious injuries.</p>
	 <p>Indicates a hazardous situation which, if not avoided, could result in death or serious injuries.</p>
	 <p>Indicates a situation which, if not avoided, could result in damage to equipment or property.</p>
	 <p>Is used for useful hints and information regarding the application.</p>

Additional symbols for safety information

	Wear safety gloves!
	Wear safety goggles!
	Harmful liquids!
	Electric shock!
	Hot surfaces!
	Fire hazard!
	Explosion hazard!
	Suffocation hazard!
	Danger of tipping!

Symbols on the Oven



Observe operating instructions



VDE test mark



CE-conformity mark: confirms conformity according to EU Guidelines

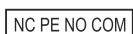

Alarm contact (for Advanced Protocol (Security) only)

Intended use of the device

Correct use

Heratherm ovens are laboratory devices for heating applications, equipped with precision temperature control for the work space.

They are designed for heat treating samples or materials at operating temperatures between 50 °C (122 °F) and 250 °C (482 °F), including - for example, drying, ageing, analyzing, decomposing, burn-in, oxidizing, reducing, and preheating.

Heratherm ovens have been designed for installation and operation in the following environments:

- heat treatment;
- drying of material.

Incorrect Use

To avoid the risk of explosion do not load the oven with tissue, material, or liquids that:

- are easily flammable or explosive,
- release vapor or dust that forms combustible or explosive mixtures when exposed to air;
- release poisons,
- create a humid atmosphere,

Safety Notes
Standards and Directives

- release dust,
- exhibit exothermic reactions;
- are pyrotechnical substances;
- exceed the specified hurdle load.

Standards and Directives

The oven complies with the following standards and guidelines:

- IEC EN 61010 - 1, IEC EN 61010 - 2 - 010
- Low Voltage Directive 2006/95/EC
- EMC Directive 2004/108/EC

Additionally, the oven is in compliance with many other international standards, regulations and directives not listed here. Should you have any questions regarding compliance with national standards, regulations and directives applicable for your country, please contact your Thermo Fisher Scientific sales organization.

Delivery of the Oven

Packaging

Heratherm ovens are delivered in a rugged packaging box. All packaging materials can be separated and are reusable:

Packaging materials

Packaging carton: Recycled paper

Foam elements: Styrofoam (CFC-free)

Pallet: Chemically untreated wood

Packaging film: Polyethylene

Packaging ribbons: Polypropylene

Acceptance Inspection

After the oven has been delivered, check the delivery immediately for:

- completeness,
- possible damage.

If components are missing or damage is found on the oven or the packaging, in particular damage caused by humidity and/or water, please notify the carrier as well as Technical Support immediately.

	 WARNING Risk of injury
	Should sharp edges have formed in damaged areas or elsewhere on the device, take all necessary precautions to protect personnel handling the oven. For example, have them wear protective gloves and other personal protection equipment.

Scope of Supply

Ovens

Quantity of components supplied (pieces)	OGS Series	OMS Series
Wire-mesh shelf	2	2
Support rail for shelf (for table-top units only)	0	2
Shelf support	4	4
Power cord	1	1
Clip springs (for table-top units only)	0	2
Operating manual	1	1
Short reference guide	1	1

Installation

Ambient conditions

Location Requirements

Built-in units of incubators can, heating and drying ovens must be operated with an air exhaust system and exhaust hose (only original Thermo accessory should be used).

For safety reasons, the installation space should be made of non-combustible materials, according to DIN 4102.

NOTE

During installation of built-in units, ensure that the escaping air will be safely discharged out of the installation space.

Use with Air Exhaust Systems

For built-in units, a temperature-resistant and corrosion-proof exhaust hose (only original Thermo accessory) should be used, which can be connected to the air exhaust port with a draft interrupter.

If several built-in units in a row are connected to a central air exhaust system (see illustration), a draft interrupter should be installed.

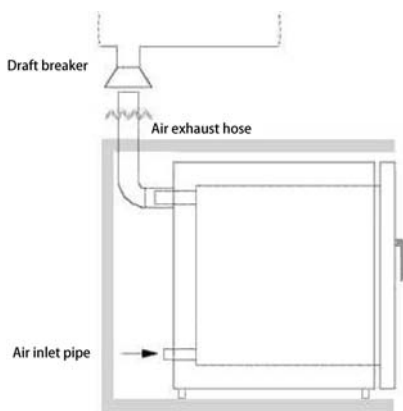

Fig. 1

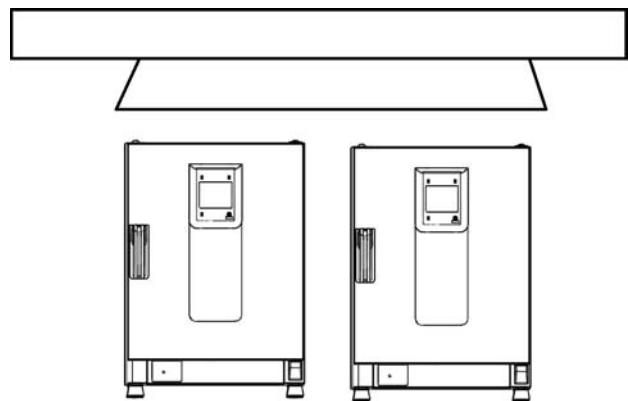

Fig. 2

The oven must only be operated in a location that meets all of the ambient condition requirements listed below:

- Draft-free and dry indoor location.
- The dust burden may not exceed the contamination category 2 based on EN 61010-1. Using the oven in an atmosphere with electrically conductive dust is prohibited.
- The minimal distance to adjacent surfaces must be observed on all sides (see section “Space Requirement” on page 3-4).
- The operating room must be equipped with appropriate ventilation.
- Solid, level, fire-proof surface and no flammable materials opposite to the rear panel of the oven.
- Vibration-proof substructure (floor stand, lab table) capable of bearing the dead weight of the device and its accessories (particularly if two devices are stacked).
- The ovens have been designed for an operating height of up to 2000 m above sea level.
- Ambient temperature range from 18 °C to 32 °C / 64.4 °F to 89.6 °F.
- Relative humidity up to 80% (maximum; preferably 60-70%), non condensing.
- Condensation must be avoided - for example, after moving or transporting the device. Should condensation exist, wait until the moisture has evaporated completely before connecting the oven to a power source and powering up.
- Avoid direct exposure to sunlight.
- Devices that produce excessive amounts of heat must not be placed near the device.
- To avoid drying operation without an appropriate fresh air supply make sure that the air inlet (which may be equipped with an optional fresh air filter) is not obstructed or blocked by any adjacent objects.
- Power line voltage variations must not exceed $\pm 10\%$ of the nominal voltage.
- Transient overvoltages must not exceed the values usually encountered throughout the power supply network. The nominal transient overvoltage level shall be the surge withstand voltage according to overvoltage category II of IEC 60364-4-443.
- Consider installing one dedicated upstream circuit breaker per oven to avoid multiple device failures in case of an electrical fault.

Intermediate Storage

When the oven is placed in intermediate storage, which is permissible for a maximum of four weeks, make sure that the ambient temperature is between 20 °C to 60 °C (68 °F to 140 °F) and the maximum relative humidity does not exceed 90%, non-condensing.

Room Ventilation

Heat dissipating from the oven during continuous operation may cause a change in the room climate.

- Therefore, the oven must only be installed in rooms with sufficient ventilation.
- Do not install the oven in room recesses without ventilation.
- When several devices are to be placed in the same room, additional ventilation may have to be provided as necessary.
- To avoid any impact of the heat dissipated by the oven on the ambient climate the room must be vented by means of a laboratory-grade ventilation system that complies with applicable local and national health and safety regulations and has sufficient capacity.
- If excessive temperatures tend to occur in the operating room, be sure to provide a thermal protection means that cuts out the power supply to mitigate the impact of overtemperature scenarios.

Use with Air Exhaust Systems

When the oven is connected to an air exhaust system be sure to adjust its air flow so the temperature distribution pattern throughout the oven's workspace remains unchanged and precision temperature control is maintained.

Before using existing piping in the building to exhaust hot air from the oven, be sure that such exhaust piping is made of heat-resistant material, so it will not overheat, melt and/or cause a fire.

The oven's outer surfaces and its air exhaust piping may become hot, so be sure to maintain the proper spacing from walls and ceilings specified by local building codes and/or fire protection regulations.

- Mark hot exhaust air piping with appropriate hot surface warning signs or restrict access to such piping altogether to avoid the risk of injury through contact with hot surfaces.

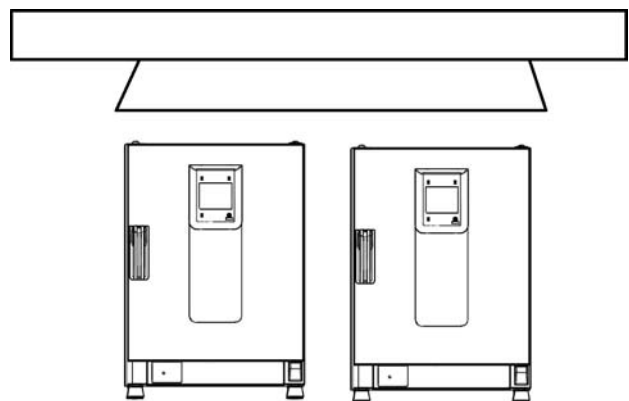
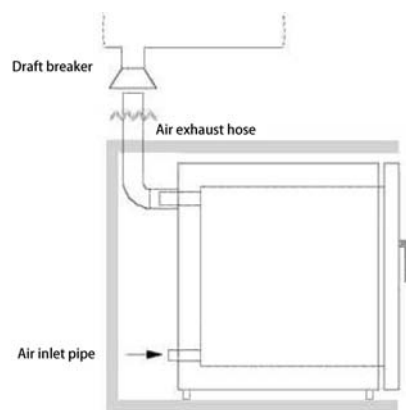

Space Requirement

For built-in units following clearances should be kept:

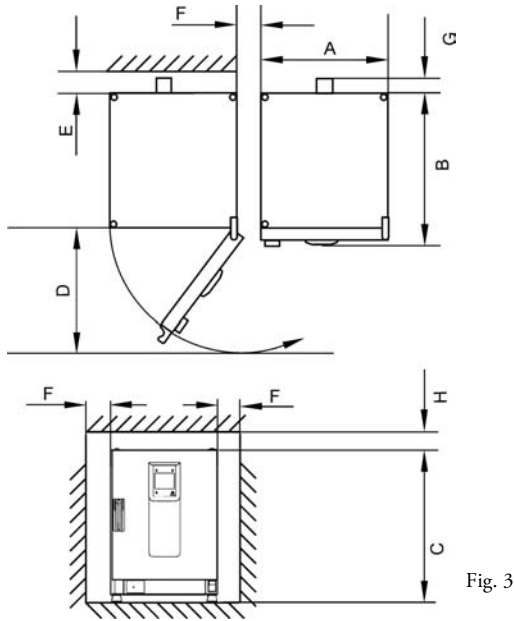

Fig. 3

A, B, C and D see Operating Instructions of the unit.

E (mm/inch)	F (mm/inch)	G (mm/inch)	H (mm/inch)
100 / 4	50 / 2	80 / 3.2	30 / 1.2

Installation Built-in Units

IGS	Clearances, as fig. 3, without exhaust hose.
IMH/IMH-S	Clearances, as fig. 3, close air port with plug, supplied with the unit.
OGS/OMS	Clearances, as fig. 3, with additional space to operate to air slide, with air exhaust system and exhaust hose Ø 40 mm (1.58 in)/1.5 m (59 in) (original Thermo accessory), shortened to required length, installed according to fig. 1 and 2.
OGH/OGH-S OMH/OMH-S	Clearances, as fig. 3, with air exhaust system and exhaust hose Ø 40 mm (1.58 in)/1.5 m (59 in) (original Thermo accessory), shortened to required length, installed according to fig. 1 and 2, Operating temperature up to max. 250 °C (482 °F).



After connecting the built-in unit to the electrical power supply, avoid damaging the power cord, then sliding into the installation position.

When installing the oven, make sure that the installation and supply connections remain freely accessible.

The specified side clearances represent minimum distances.

Table-top units

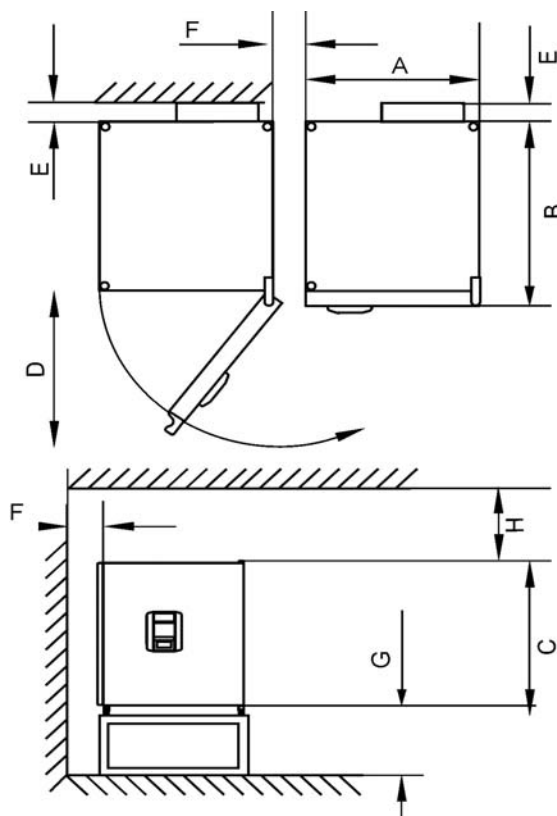

Figure 3-1 Table-top oven units OGS 60 / OGS 100 / OGS 180, dimensions and required clearances

Table 3-1 Heratherm Oven Dimensions

Type	A (mm/inch)*	B (mm/inch)	C (mm/inch)	D (mm/inch)
OGS 60 / OMS 60	530 / 20.8	565 / 25.2	720 / 28.3	540 / 21.3
OGS 100 / OMS 100	640 / 25.2	565 / 25.2	820 / 32.3	650 / 25.6
OGS 180 / OMS 180	640 / 25.2	738 / 29.1	920 / 36.2	650 / 25.6

* Dimensions in inches are rounded equivalents specified for information only. Depth of handle/display (66 mm/2.6 in) not included in overall depth specified; height of adjustable feet (36 mm/1.4 in) not included in overall height specified.

Table 3-2 Required Clearances

E (mm/inch)	F (mm/inch)	G (mm/inch)	H (mm/inch)
80 / 3.2	50 / 2	300 / 12	300 / 12

Floor stand units

400 liter units

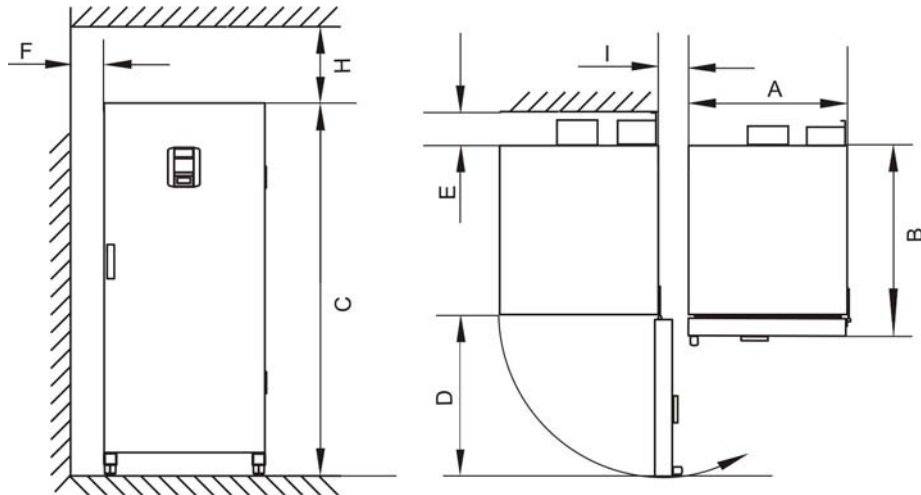

Figure 3-2 Floor stand ovens OGS 400, dimensions and required clearances

Table 3-3 Oven Dimensions

Model	A (mm/inch)	B (mm/inch)	C (mm/inch)	D (mm/inch)
OGS 400	755 / 29.7	770 / 30.3	1655 / 65.2	810 / 31.9

* Depth of handle /display (66 mm/2.6 in) not included in overall depth specified. The width of the hinge (23 mm) is not included in the overall width.

Table 3-4 Required Clearances

E (mm/inch)	F (mm/inch)	H (mm/inch)	I (mm/inch)
120 / 4.7	50 / 2.0	200 / 7.9	200 / 7.9

750 liter units

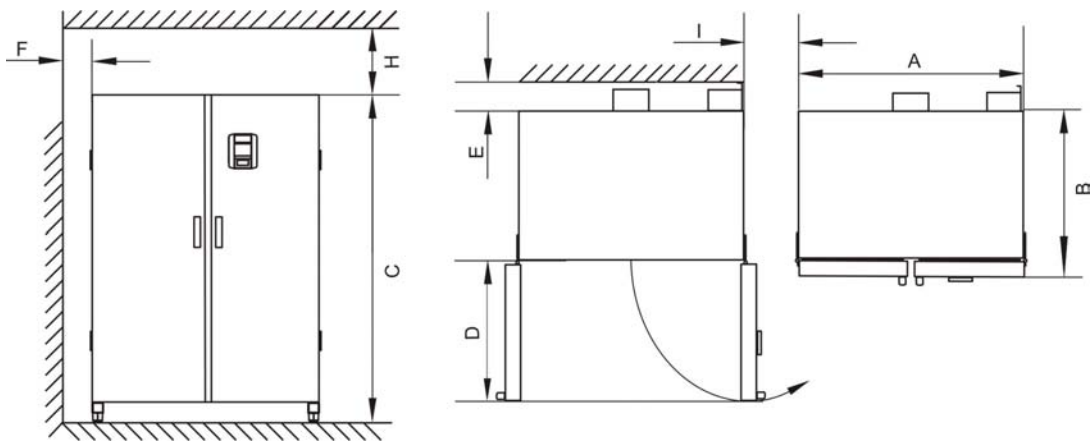

Figure 3-3 Floor stand ovens OGS 750, dimensions and required clearances

Table 3-5 Oven Dimensions

Model	A (mm/inch)	B (mm/inch)	C (mm/inch)	D (mm/inch)
OGS 750	1215 / 47.8	770 / 30.3	1655 / 65.2	670 / 26.4

* Depth of handle /display (66 mm/2.6 in) not included in overall depth specified. The width of the hinge (23 mm) is not included in the overall width.

Table 3-6 Required Clearances

E (mm/inch)	F (mm/inch)	H (mm/inch)	I (mm/inch)
120 / 4.7	50 / 2.0	200 / 7.9	350 / 13.8

Transport

Table-top units

For transport, do not lift the oven using the doors or components attached to the oven as lift points.

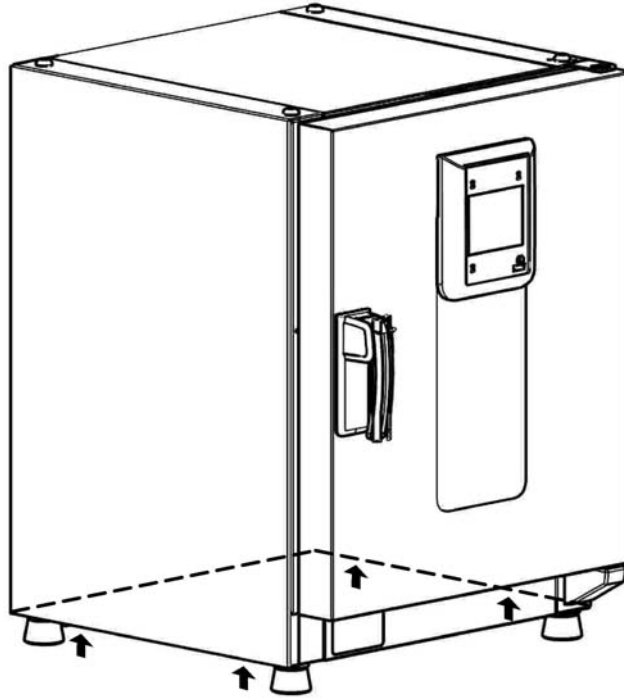

Figure 3-4 Lift Points



	<div data-bbox="534 1272 896 1361" data-label="Image"></div> <div data-bbox="917 1288 1316 1326" data-label="Text"><p>Heavy loads! Lift with care!</p></div> <div data-bbox="518 1355 1460 1460" data-label="Text"><p>To avoid injury through physical strain, such as strain traumata and slipped discs, do not attempt to lift the oven alone!</p></div> <div data-bbox="518 1460 1460 1534" data-label="Text"><p>To avoid injury through dropped loads, be sure to wear Personal Protection Equipment, such as safety shoes, when lifting the oven.</p></div> <div data-bbox="518 1534 1460 1635" data-label="Text"><p>To avoid crushing your fingers or hands (particularly in a closing door) or damaging the oven, do not use any other lift points than those indicated in the illustration above.</p></div>
--	--

Floor stand units



The floor stand units come equipped with four (4) casters. The lever for releasing the caster is located above the locking lever. After positioning the unit in its installation location ensure that the locking levers are pressed down on the casters.

To ensure the degree of stability specified by safety requirements the front casters must be turned so that they are facing forward after the unit has been positioned in its installation location and the locking levers pressed down on these casters.

	<div style="border: 1px solid black; padding: 5px; margin-bottom: 10px;">  CAUTION </div> <p>Danger of tipping when moving!</p> <p>Before moving the unit, ensure that it has been unplugged.</p> <p>Move the Heratherm floor stand units with caution.</p> <p>Quick starts and stops can result in tipping!</p> <p>Always ensure that the doors are closed when moving the unit.</p>
---	--

Stacking Kit

The stacking adapter is available only for table-top units.

Material Number	Description
50126665	Stacking adapter Heratherm 60L
50126666	Stacking adapter Heratherm 100L
50126667	Stacking adapter Heratherm 180L

Scope of Delivery:

1 stacking adapter

1 anti-tilt anchor

1 plastic bag with 2 stacking feet and 2 M4x16 Torx screws.

Required Tools:

Slotted screwdriver 5,5x100 or Torx screwdriver 20x100.

Installing the Stacking Feet

Remove the left and right blank plugs at the top blank.

Install the stacking feet with the enclosed screws using a slotted or Torx screwdriver.

Installing the Stacking Adapter

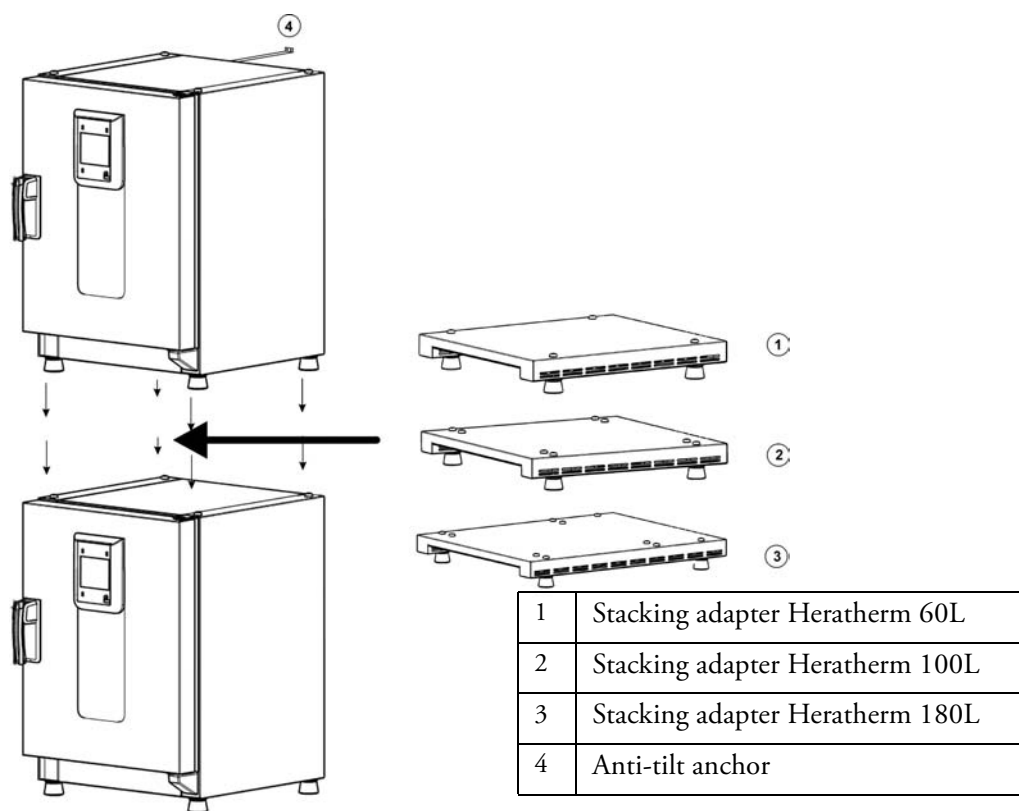

Stack as follows when using a stacking adapter (numbers denote oven volumes in liters):

- for 60/100/180 on 180 use stacking adapter Heratherm 180L,
- for 60/100/100 on 180 use stacking adapter Heratherm 100L,
- for 60/60/100 on 180 use stacking adapter Heratherm 60L,

To prevent the top oven from slipping and dropping down, the following requirements must be fulfilled before devices may be stacked:

- Only two units may be stacked together. When stacking devices with the same type of enclosure, yet with a different footprint the device with the smaller footprint must be placed on top of the one with the larger footprint at all times.
- The bottom device must be correctly levelled.
- Be sure to use the appropriate stacking adapter.
- The levelling feet on the top device must be screwed in all the way.
- The levelling feet of the top device must be aligned with and placed exactly on the stacking pads of the stacking adapter.
- The anti-tilt anchor must be installed on the top device.

Installing the Anti-tilt Anchor

Table-top units

The anti-tilt anchor secures the top device in a stack to a solid part of a building. The anti-tilt anchor is to be mounted on the side opposite of the door hinges.

Bend the fixing tabs of the anti-tilt anchor up on one side and down on the other by an angle of approx. 90°.

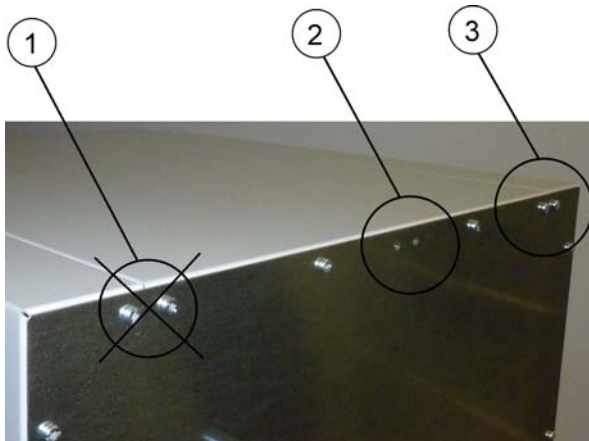

1. Do not use this position if the door is hinged on this side. Right-hand hinges represent the standard configuration.
2. Preferred position.
3. Alternative position. Do not use if the door is hinged on this side.

Remove the bracket screws. Use the preferred position, if possible.

Fix the anti-tilt anchor with the bracket side down to the unit (see figure).

Position the unit with the anti-tilt anchor to in an angle of approx. 90° +/- 20%.

Take care that the stacking feet of the unit are still in correct place on the lower unit or on the stacking adapter.

Fix the anti-tilt anchor to a solid part of the building.

Floor stand units

NOTE

Anti-tilt anchors

Heratherm floor stand units must always be attached to the wall using two (2) retaining brackets on the outer left and right side on the back of the unit.



Remove the screws.

Attach the end of the retaining bracket that is facing downward to the unit.

Align the device at roughly 90°, +/-20° to the retaining bracket.

Affix the retaining bracket to the wall.



Unsafe part of the building!

Install the anti-tilt anchor to a solid part of the building, which is able for shoring loads.

The installation has to be carried out by qualified personnel only.

The connection to the building must be carried out with appropriate screws and dowels according to the consistence of the building part.

Additionally, the following caution notes must be heeded at all times:



Risk of overheating with stacked devices

To avoid the risk of electrical components and the outer enclosure overheating or temperature control failing due to insufficient ventilation, do not exceed the specified stacking height!

	<div data-bbox="534 241 896 338" data-label="Image"></div> <div data-bbox="917 259 1374 329" data-label="Text"><p>Risk of tipping and dropping of stacked devices</p></div> <div data-bbox="515 365 1469 575" data-label="Text"><p>You should be aware at all times that stacked devices do not form a stable unit, even when the stacking pads and frames are used correctly. The top device may tip over and drop down when being transported in a stack. To avoid injury to persons and damage to equipment, do not attempt to move stacked devices as a unit! Separate and move each device one by one, then restack them.</p></div> <div data-bbox="515 607 1469 707" data-label="Text"><p>Thermo Scientific accepts no responsibility or liability whatsoever with regard to stacked third party devices; this is at the user's own risk.</p></div>
--	--

Floor stand unit spacers

The spacer on the electrical module must be pulled out and fixed in place before installing the floor stand unit at its installation location.



- 1 Loosen the 2 screws
- 2 Pull out the spacer and slide the screws into the recesses
- 3 Tighten the two screws

Product Description

This section describes Heratherm general protocol ovens for standard laboratory applications, which are available in two versions distinguished by convection method:

- Heratherm OGS Series natural convection ovens (see “[Heratherm OGS Series Oven Overview](#)” on [page 4-1](#)).
- Heratherm OMS Series mechanical convection ovens (see “[Heratherm OMS Series Oven Overview](#)” on [page 4-8](#)).

Heratherm OGS Series Oven Overview

Heratherm OGS Series (OGS is brief for Oven with Gravity convection for Standard laboratory applications) general protocol natural convection ovens come equipped with the following features:

- high-precision work space temperature control, adjustable in steps of one degree up to 250 °C/626 °F;
- a mechanically-operated damper for venting the work space, equipped with an external slider;
- a countdown timer for timed process control;
- an On/Off-timer;
- two wire-mesh shelves;

Product Description
Heratherm OGS Series Oven Overview

The individual features of OGS Series ovens are shown in the figures below.

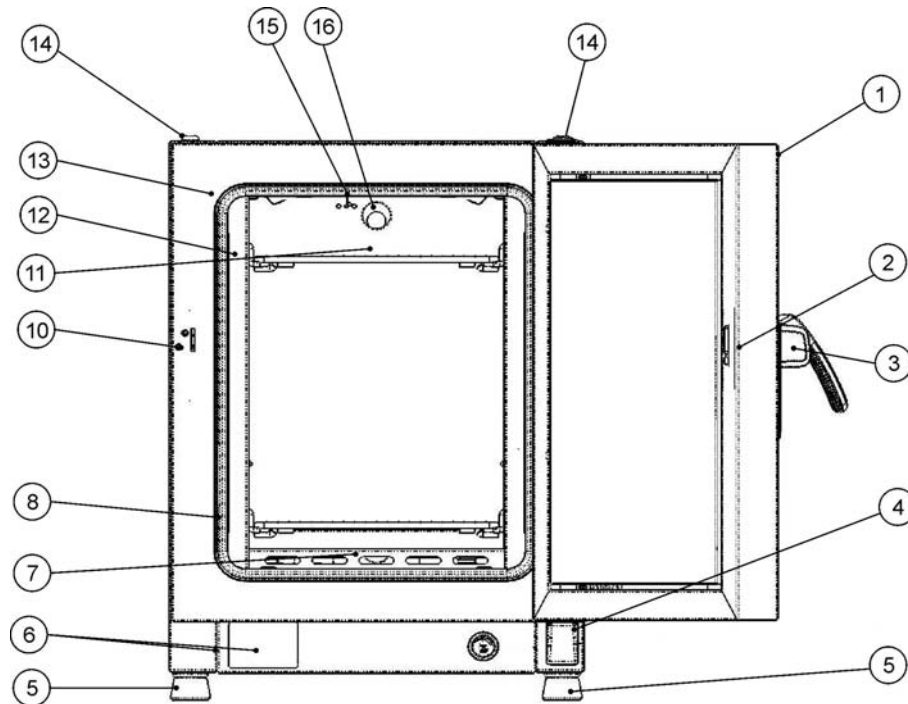

Figure 4-1 Heratherm OGS 60 / OGS 100 / OGS 180 Series Front View

- [1] Outer door
- [2] Door latch cutout
- [3] Door latch and handle
- [4] Door hinge, lower
- [5] Levelling foot
- [6] Nameplate
- [7] Air baffle, bottom
- [8] Air baffle, side
- [9] -
- [10] Door hook catch
- [11] Wire-mesh shelf
- [12] Support rail for wire mesh shelf
- [13] Door seal
- [14] Stacking pad
- [15] Temperature sensor
- [16] Exhaust air tube

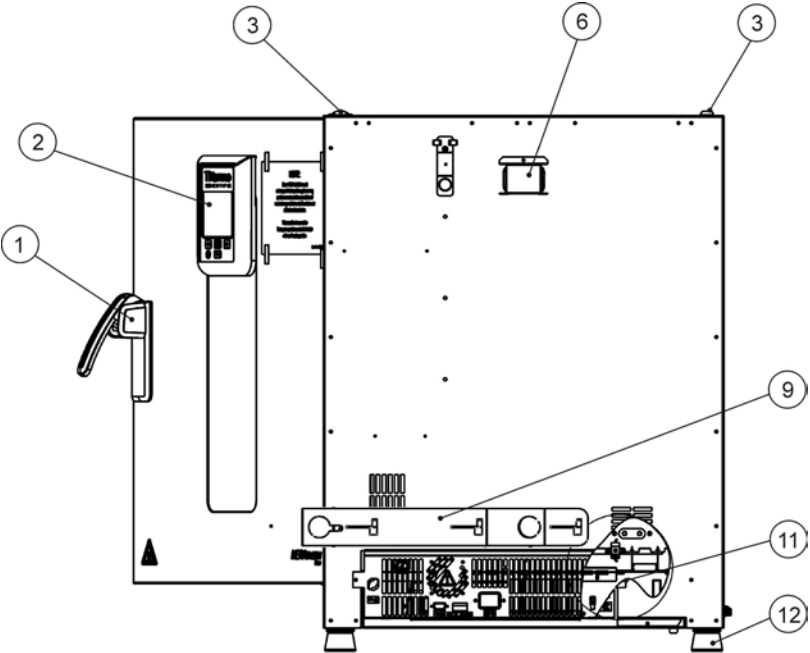

Figure 4-2 Heratherm OGS 60 / OGS 100 / OGS 180 Series Rear View

- [1] Door latch and handle
- [2] Control panel
- [3] Stacking pad
- [4] -
- [5] -
- [6] Spacer
- [7] -
- [8] -
- [9] Mechanical air inlet slider
- [10] -
- [11] Electronics compartment
- [12] Levelling foot

Product Description
Heratherm OGS Series Oven Overview

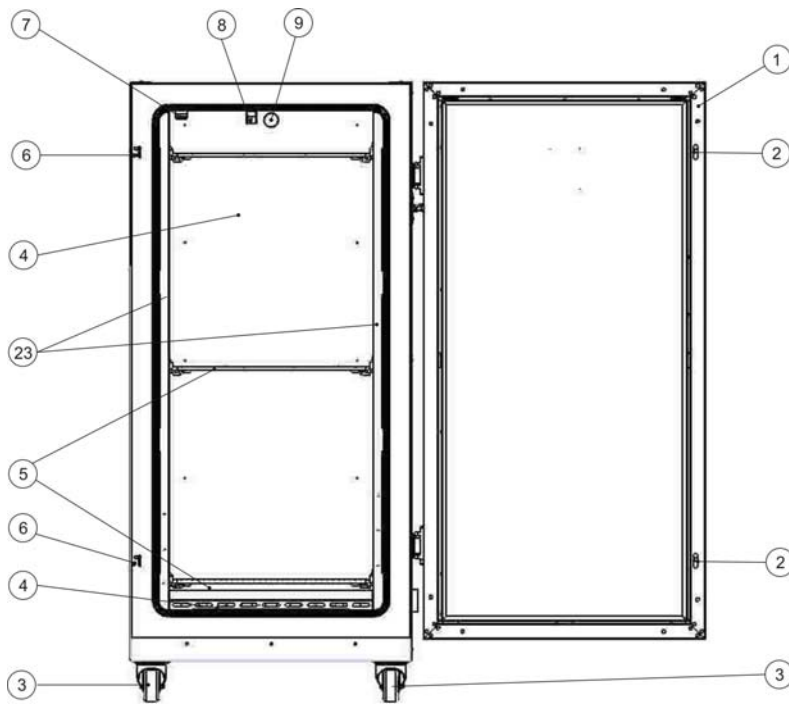

Figure 4-3 Heratherm OGS 400 Series Front View

- [1] Outer door
- [2] Door latch
- [3] Unit caster
- [4] Air baffle, bottom
- [5] Wire-mesh shelf
- [6] Door hook catch
- [7] -
- [8] Temperature sensor
- [9] Exhaust air tube
- [10] -
- [11] -
- [12] -
- [13] -
- [14] -
- [15] -
- [16] -
- [17] -
- [18] -
- [19] -
- [20] -
- [21] -
- [22] -
- [23] Air baffle, side

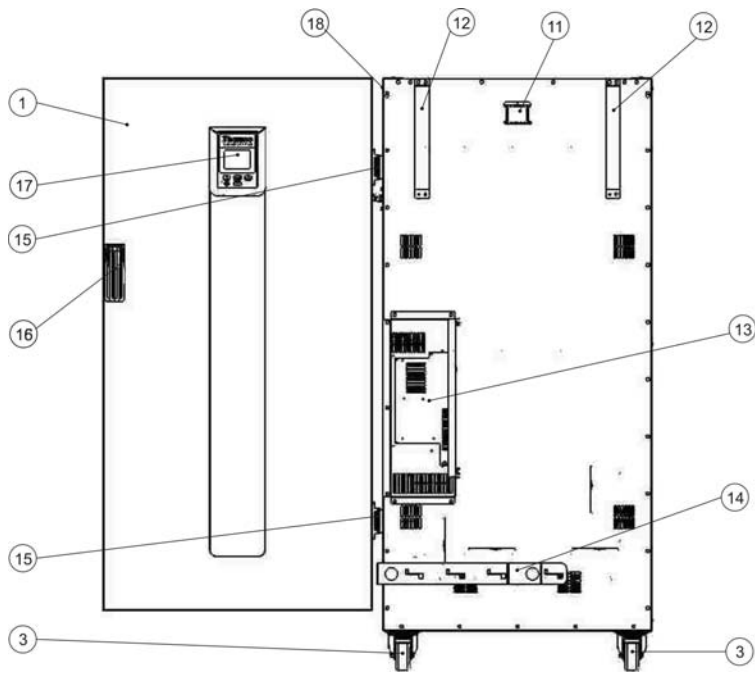

Figure 4-4 Heratherm OGS 400 Series Rear View

- [1] Outer door
- [2] -
- [3] Unit caster
- [4] -
- [5] -
- [6] -
- [7] -
- [8] -
- [9] -
- [10] -
- [11] Exhaust air tube
- [12] Anti-tilt anchor
- [13] Electronics compartment
- [14] Inlet air tube
- [15] Hinge
- [16] Handle
- [17] Display
- [18] Nameplate on sidewall

Product Description
Heratherm OGS Series Oven Overview

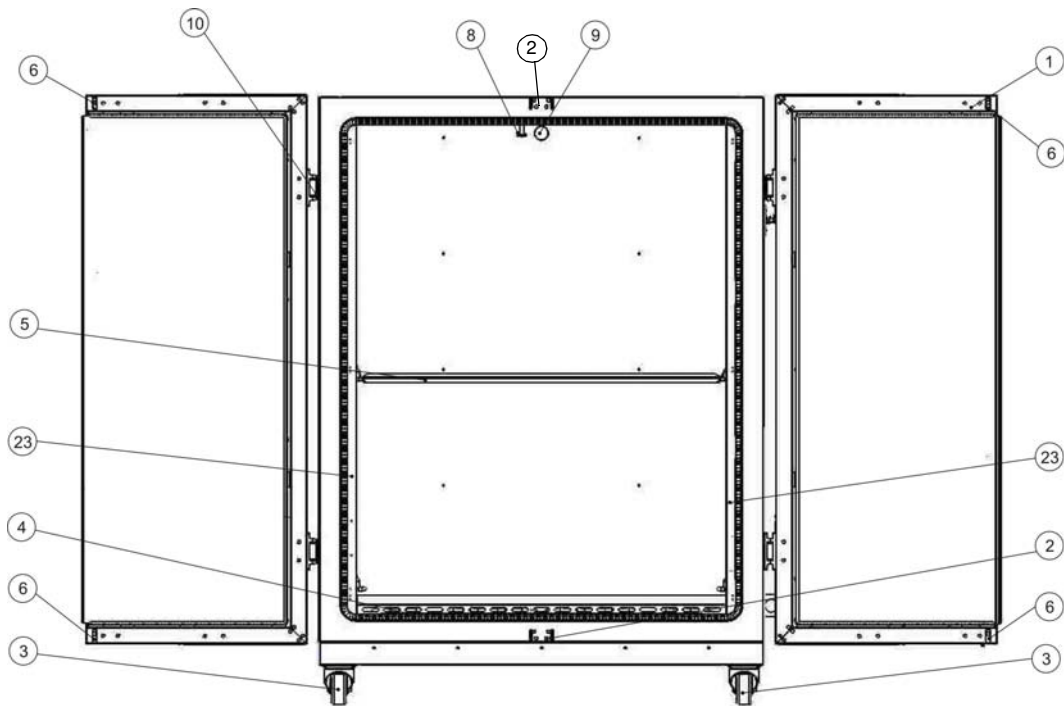

Figure 4-5 Heratherm OGS 750 Series Front View

- [1] Outer door
- [2] Door hook catch
- [3] Unit caster
- [4] Air baffle, bottom
- [5] Wire-mesh shelf
- [6] Door latch
- [7] -
- [8] Temperature sensor
- [9] Exhaust air tube
- [10] Door hinge
- [11] -
- [12] -
- [13] -
- [14] -
- [15] -
- [16] -
- [17] -
- [18] -
- [19] -
- [20] -
- [21] -
- [22] -
- [23] Air baffle, side

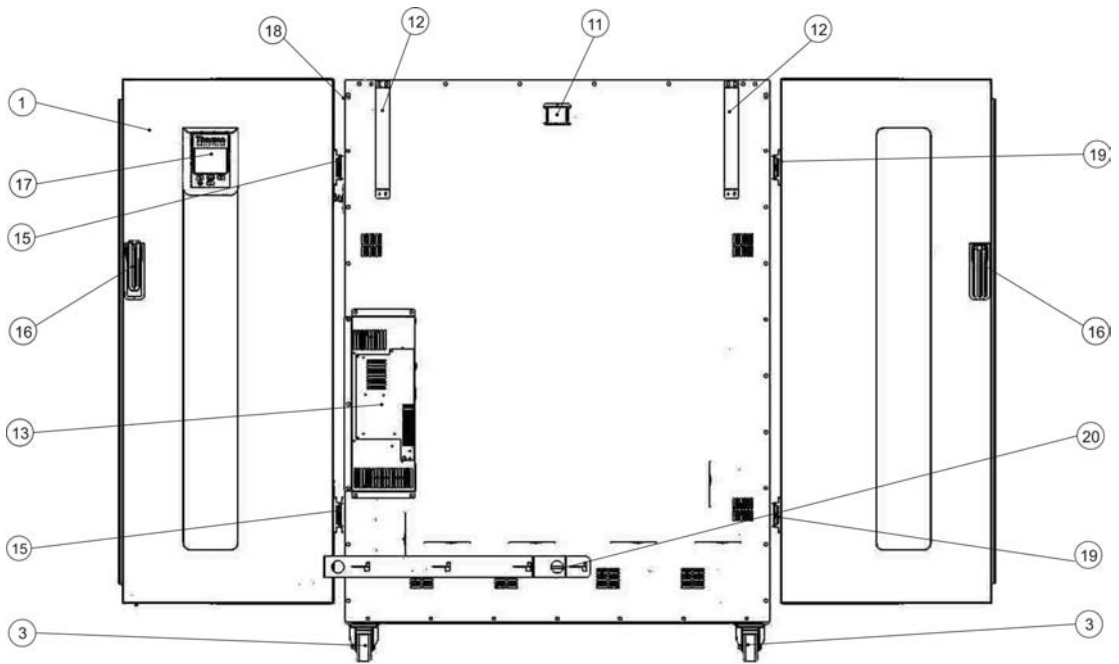

Figure 4-6 Heratherm OGS 750 Series Rear View

- [1] Outer door
- [2] -
- [3] Unit caster
- [4] -
- [5] -
- [6] -
- [7] -
- [8] -
- [9] -
- [10] -
- [11] Exhaust air tube
- [12] Anti-tilt anchor
- [13] Electronics compartment
- [14] Inlet air tube
- [15] Hinge
- [16] Handle
- [17] Display
- [18] Nameplate on sidewall
- [19] Hinge

Heratherm OMS Series Oven Overview

Heratherm OMS Series (OMS is brief for Oven with Mechanical convection for Standard laboratory applications) general protocol fan convection ovens come equipped with the following features:

- high-precision work space temperature control, adjustable in steps of one degree up to 250 °C/482 °F;
- a fixed-speed fan for optimizing temperature uniformity throughout the work space;
- a mechanically-operated damper for venting the work space, equipped with an external slider;
- a countdown timer for timed process control;
- rotary button front control;
- two wire-mesh shelves;

The individual features of the oven are shown in [figure 4-7](#) and [figure 4-8](#) below.

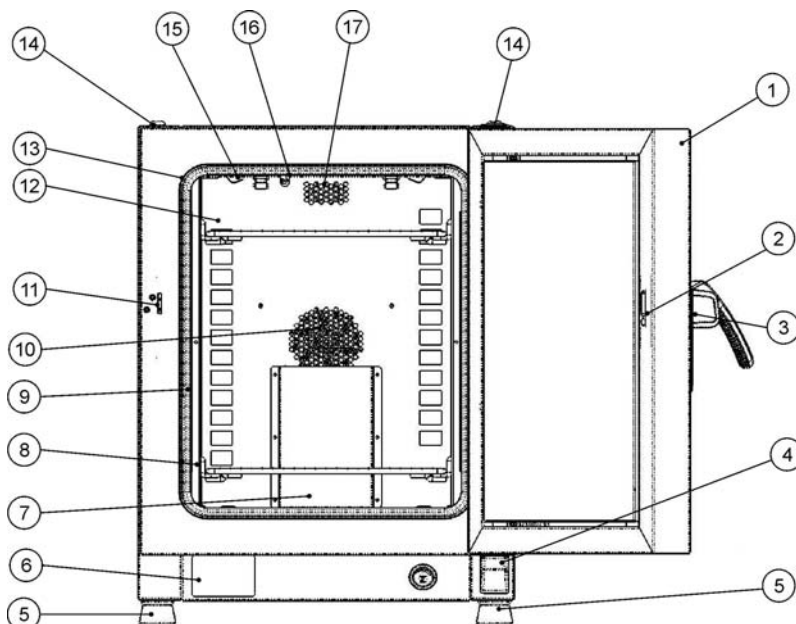

Figure 4-7 Heratherm OMS Series Front View

- [1] Outer door
- [2] Door latch cutout
- [3] Door latch and handle
- [4] Door hinge, lower
- [5] Levelling foot
- [6] Nameplate
- [7] Air baffle, top piece
- [8] Support rail for wire mesh shelf
- [9] Shelf support
- [10] Fan cover, integrated into air baffle
- [11] Door hook catch
- [12] Air baffle
- [13] Door seal
- [14] Stacking pad
- [15] Spring for air baffle
- [16] Temperature sensor
- [17] Exhaust air tube

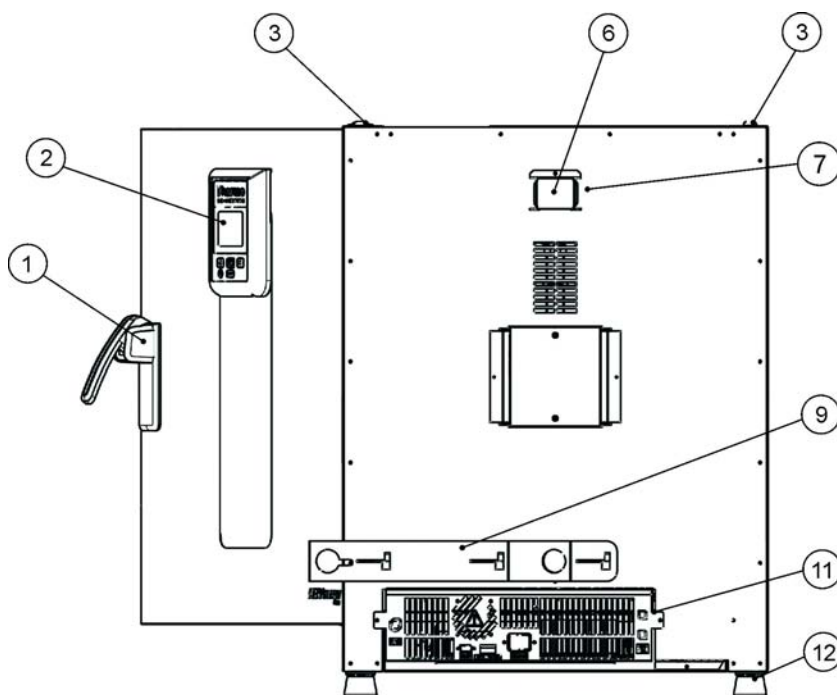

Figure 4-8 Heratherm OMS Series Rear View

- [1] Door latch and handle
- [2] Control panel
- [3] Stacking pad
- [4] -
- [5] -
- [6] Spacer
- [7] Exhaust air tube
- [8] -
- [9] Mechanical air inlet slider
- [10] -
- [11] Electronics compartment
- [12] Levelling foot

Safety Devices

The oven is equipped with the following safety features:

- a sample protection feature that safeguards the samples against destruction through overheating in case of controller failure;
- an overheat protection cut-out feature that shuts down the oven completely when excessive temperatures occur in the workspace;
- dual fuses rated at 16 amperes.

Work Space Atmosphere

To ensure undisturbed operation, the ambient temperature in the operating room must be at least 18 °C (64.4 °F). The heating system controls the temperature in the oven's workspace of 50 °C/122 °F up to the maximum of 250 °C/482 °F).

Sensing and Control System

The PT 100-type sensor for the control of the work space temperature and for the thermal protection [1] is mounted in the top panel of the work space compartment.

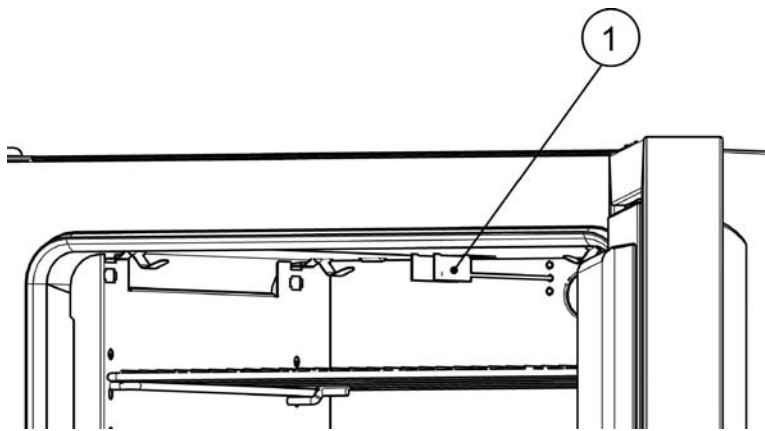

Figure 4-9 Sensor Mounting Location - OGS Series and OMS Series - Table-top units

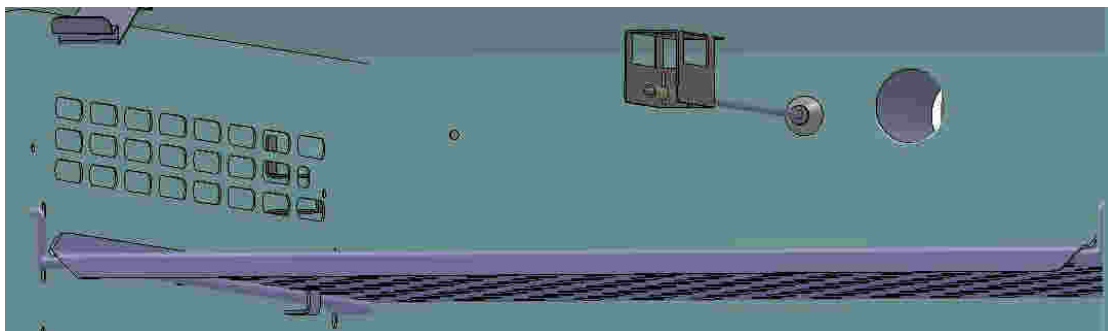

Figure 4-10 Sensor Mounting Location - OGS Series and OMS Series - Floor stand units

The work space temperature sensor provides the inputs to the oven's built-in controller, which continuously compares the measured values to the user-specified set value and adjusts the heaters according to the result.

	<div data-bbox="523 360 903 459" data-label="Section-Header"><h2>NOTE</h2></div> <div data-bbox="513 486 1246 557" data-label="Text"><p>Do not remove the protective hose from the sensor. Protect the sensor from mechanical damage.</p></div>
--	--

The unit features a thermal protection function that is factory-preprogrammed and not adjustable. It protects the samples in the work space from overheating: Thermal protection kicks in on a brief violation of the upper limit, based on the user-selected temperature set value, automatically reducing the work space temperature to the user-specified set value and allowing the heating process to continue even in case of a controller malfunction. If the thermal protection is activated, the error message (E111) "Temperature too high" appears in the display window and an audible alarm is sounded.

When the user acknowledges the error message, the red alarm icon (D3 in [figure 7-1](#) on [page 7-1](#)) is illuminated and the Temperature Set Value icon (see [table 7-3](#) on [page 7-3](#)) is highlighted by a red border to indicate that thermal protection has kicked in.

Data Communications & Alarm Interface

All signal connections are installed in the electrical interface panel at the rear of the oven.

RS 232 Interface

The RS-232 interface (see [figure 4-11](#)) may be used to connect ovens to the serial interface port of a computer to allow for the computer-aided acquisition and documentation of major operating parameters (temperature, error codes, etc.).



Figure 4-11 Signal Interfaces and Power Socket

AC Power Socket

The oven is connected to the AC supply mains via an IEC socket, which accepts a power cord with an IEC standard plug (see [figure 4-11](#)).

Fuses

Two 16 A slow-blow fuses mounted on the oven's main electronic circuit board protect internal circuitry from the impact of excessive power consumption.

	<p>NOTE</p> <p>Replacement should only be carried out by skilled and authorized qualified personnel of electrotechnology/signal engineering!</p>
--	--

	<p>NOTE</p> <p>Fuse replacement</p> <p>The device fuses are not user-serviceable. When the oven exhibits the typical signs of a blown fuse (no response to pressing the On/Off button, control panel remains extinguished, no heating operation), call Customer Service to have the fuses replaced.</p>
--	---

Work Space Components

Inner Chamber

All components of the work space are made of corrosion-resistant stainless steel and have an absolutely smooth and easy-to-clean surface. Any embossings have a large radius.

Shelf System

The oven is supplied with two wire-mesh shelves. The shelf support rails have an alternating pattern of oblong and round perforations spaced evenly at 30 mm, allowing the shelf support brackets to be inserted without any room for error, yet in a very flexible way to accommodate different heights of sample containers. The shelves have an integrated tilt protection and withdrawal stop. For details on using the shelf system, see the section “Start-up” on [page 5-1](#).

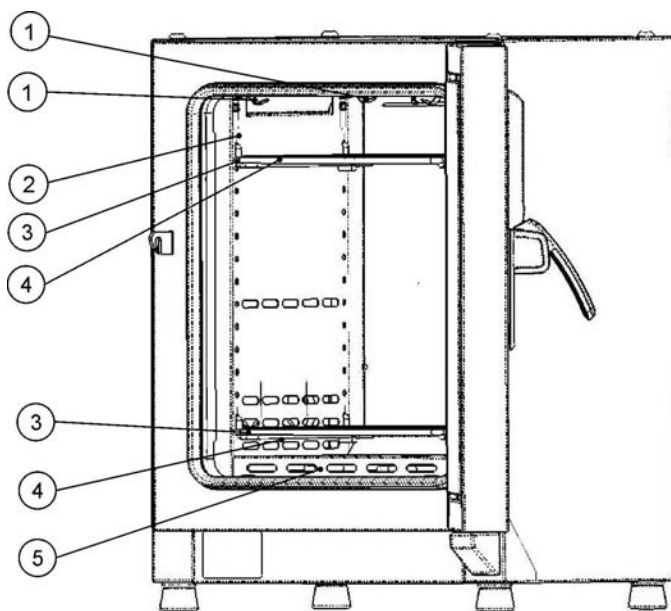

- [1] Spring
- [2] Air baffle, side
- [3] Support rails
- [4] Wire-mesh shelf
- [5] Air baffle, bottom

Figure 4-12 Shelf System - OGS Series Oven - Table-top units

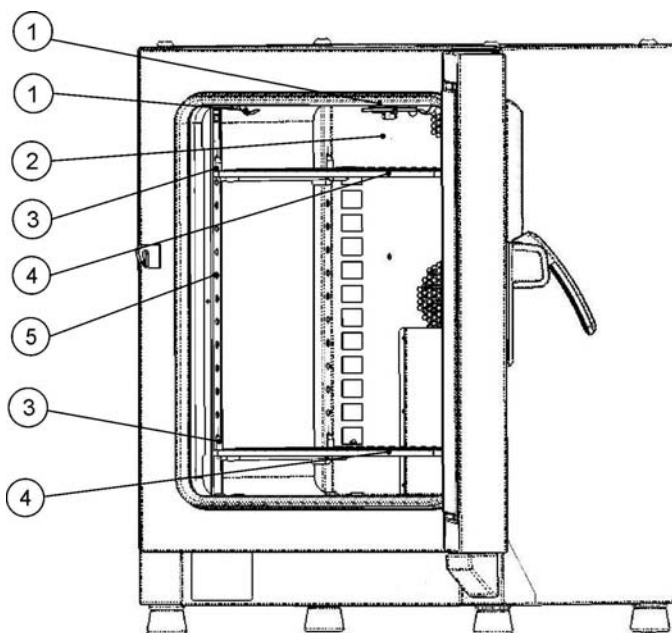

- [1] Spring
- [2] Air baffle, rear
- [3] Support rail for shelf
- [4] Wire-mesh shelves,
- [5] Support rail for shelf

Figure 4-13 Shelf System - OMS Series Oven - Table-top units

Tube Access Ports

Heratherm heating and drying ovens may be equipped with additional tube access ports in the side and top panels.

Available tube access port options are listed in [table 4-1](#) below.

Table 4-1 Tube Access Ports for Heratherm Heating and Drying Ovens (Option)

Model	Side Panel Mounted Port, dia. in mm/inch	Top Panel Mounted Port, dia. in mm/inch
OGS	19/0.75 or 53/2.09	24/0.95 or 58/2.28
OMS	24/0.95 or 58/2.28	24/0.95 or 58/2.28

The tube access ports are mounted in fixed locations in the side and top panels (see [figure 4-14](#)).

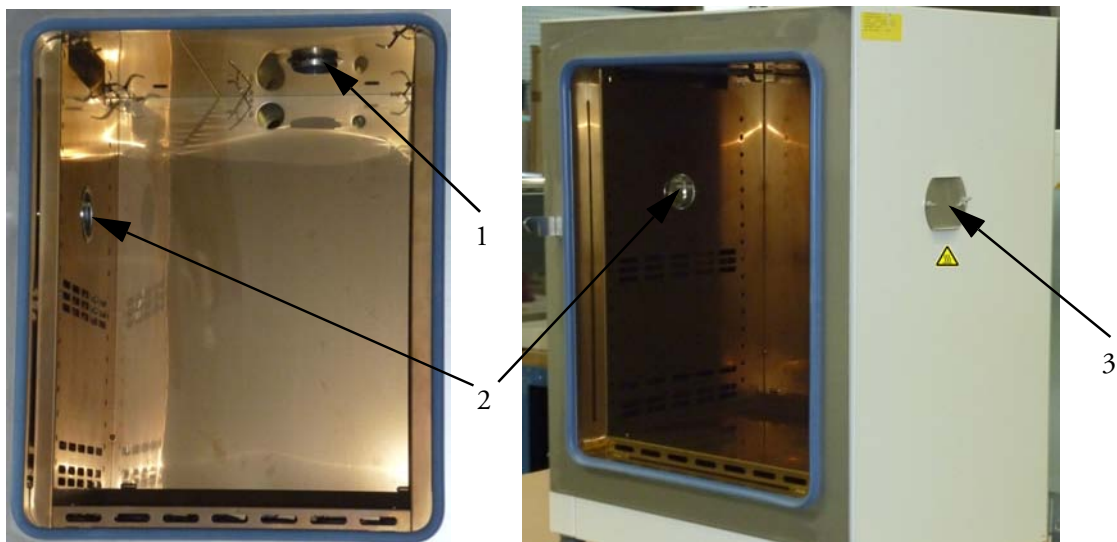

Figure 4-14 Tube Access Ports

- [1] Top panel mounted tube access port
- [2] Side panel mounted tube access port
- [3] Sealing cap for side panel mounted tube access port

Once the cables, tubes or other conduits have been inserted, the tube access ports must be padded with the heat-resistant fiber pads shipped with the device and the cap must be mounted to seal the port as far as possible.

		Risk of Burning on Hot Surface
The surface around the tube access ports may become extremely hot.		

Start-up

Installing the Shelf System of the table-top units

The installation of the shelf system does not require any tools. The support rails are secured in place by spring action. Once the shelf support brackets have been inserted into the rails, the wire-mesh shelves can be simply pushed onto their support hooks to complete the installation.

NOTE

The support rails of the floor stand units cannot be removed.

Initial installation

Heratherm OGS Series ovens have the shelving support rails integrated with the air baffles, which are readily pre-installed when the devices are shipped from the factory.

Heratherm OMS Series ovens come with separate support rails, which need to be installed as follows:

- Peel off the protective foil from the support rails.
- Push the retaining spring [1] into the guide on the support rail [2], making sure that the locking nub [3] on the retaining spring safely engages with the matching hole in the support rail.

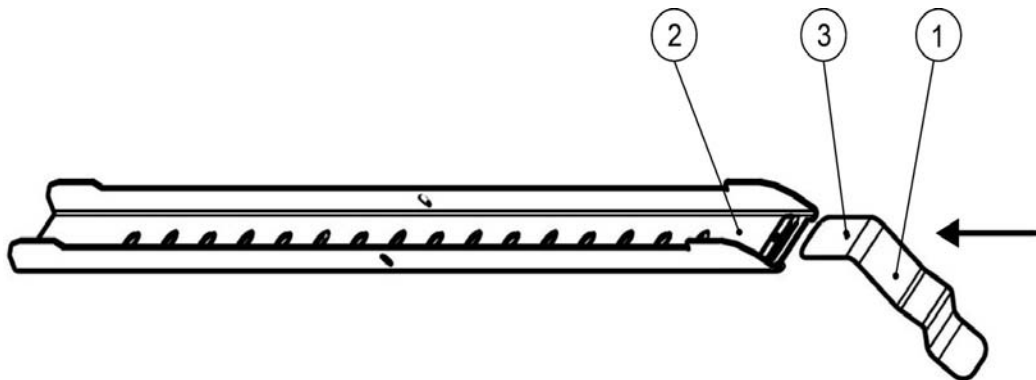
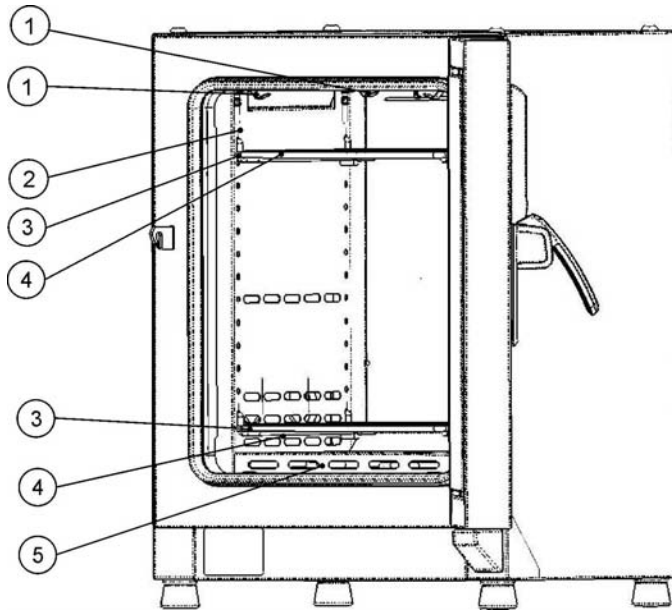

Figure 5-1 Sliding the Retaining Spring into the Support Rail

Installing the Shelving

The illustrations below show the placement of the shelf system elements.



- [1] Retaining spring
- [2] Air baffle, lateral
- [3] Shelf support
- [4] Wire-mesh shelf
- [5] Air baffle, bottom

Figure 5-2 OGS Series - Installing the Shelving

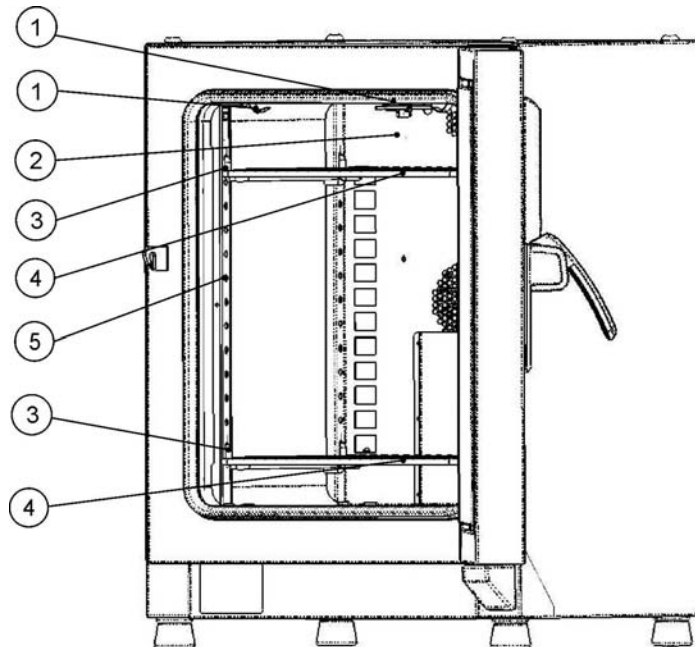

- [1] Retaining spring
- [2] Air baffle, rear
- [3] Shelf support
- [4] Wire-mesh shelf
- [5] Support rail

Figure 5-3 OMS Series - Installing the Shelving

Preparing the Work Space

The following work space components should be checked for cleanliness and cleaned prior to use:

- Shelf support
- wire-mesh shelves,
- work space surfaces,
- work space seals and gaskets,

NOTE	<p>Cleaning and disinfection</p> <p>For details about the cleaning of the oven, please refer to the section “Cleaning and Disinfection” on page 9-1.</p>
-------------	---

Table-top units

Installing and Uninstalling the Support Rails (OMS Series only)

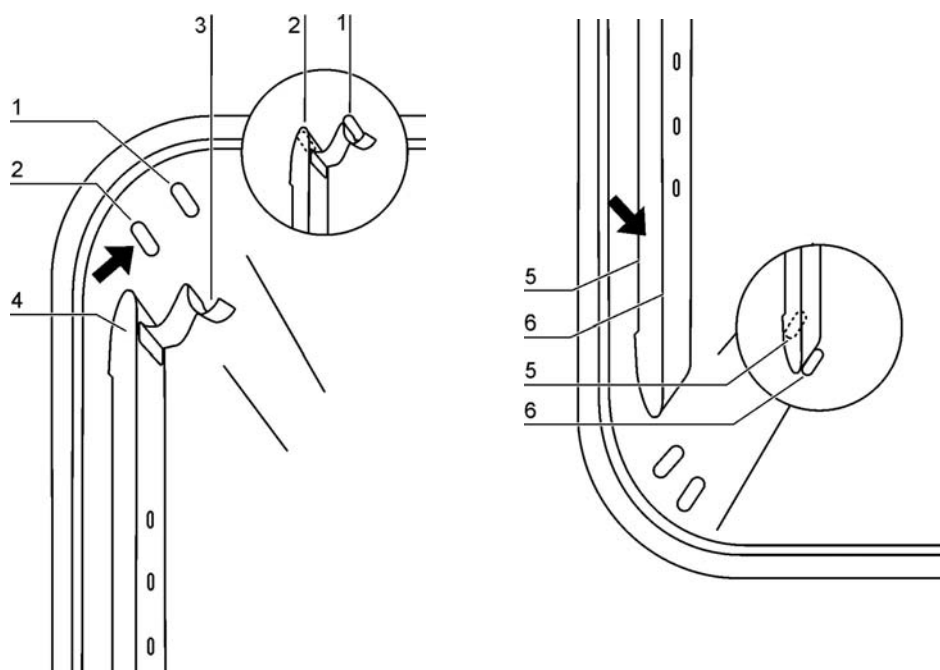

Figure 5-4 Support Rail Installation

The embossings at [2] and [7] act as lateral guides for the support rails, while the embossings at [1] and [6] secure the support rails in place. For the support rails to install correctly on the oven's rear panel, the retaining springs [3] must be facing upwards.

1. Place the support rail [4] on the lower embossing [6] and tilt it upwards against the work space side wall so that the rail is positioned over the two embossings at [5] and [2].

2. Clamp the retaining spring [3] behind the upper embossing [1].
3. To remove the support rails, pull the retaining spring tab down out of the embossing and remove the support rail assembly.

Installing an Uninstalling the Rear Air baffle (OMS Series only)

Heratherm OMS Series ovens are shipped from the factory with an air baffle readily pre-installed at the back wall of the work space (while OGS Series ovens do not have this feature). Before the air baffle can be removed from the back wall, the support rails need to be uninstalled as explained further above.

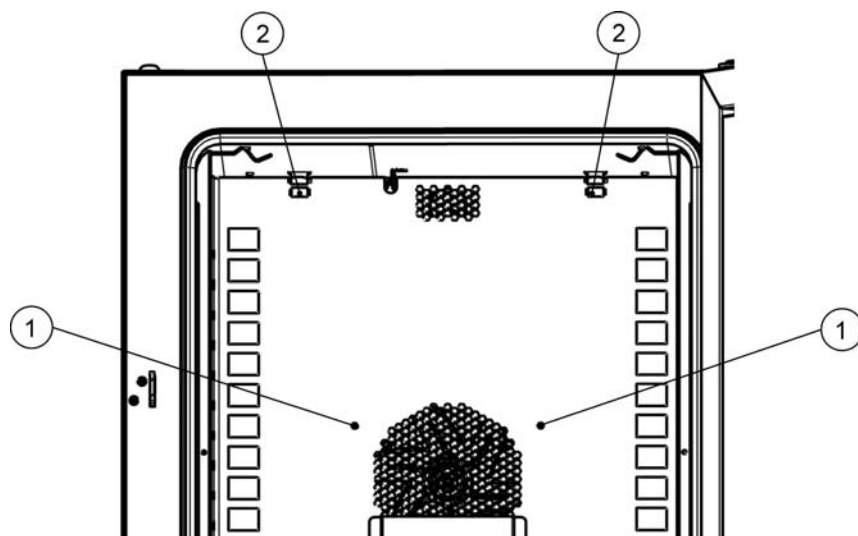



Figure 5-5 Installing the Rear Air Baffle

1. Loosen the two screws [1] that hold the air baffle to the back wall of the work space.

	<p>WARNING Risk of damage to sensor!</p> <p>To prevent accidental damage, be sure to avoid collision with the sensor when installing or uninstalling panels in the oven's workspace.</p>
---	---

2. Grab the two retaining springs [2] at their tabs and pull them downwards out of the embossings, then pull off the rear air baffle.
3. For the rear air baffle to install correctly, the two retaining springs [2] must be facing upwards. Place the air baffle on the lower embossings and tilt it upwards against the back wall of the work space.
4. Clamp the two retaining springs [2] into the upper embossings.
5. Secure the air baffle to the work space back wall by fastening the two screws at [1].

Installing and Uninstalling the Lateral Air Baffles (OGS Series only)

The following section describes the installation and removal of the bottom panel.

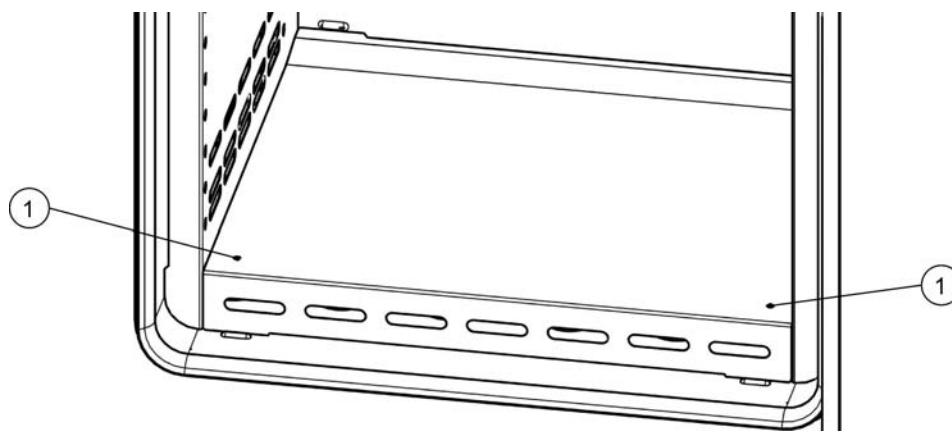

Figure 5-6 Removing the Bottom Panel

1. Loosen the two screws [1] in the bottom panel, then remove the entire bottom panel by lifting it out of its two embossings.

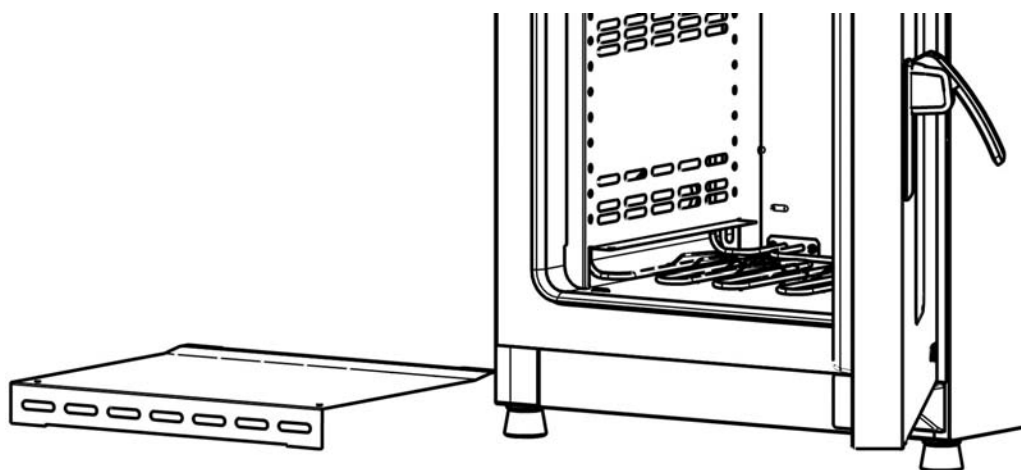



Figure 5-7 Bottom Panel Removed

2. Grab the two retaining springs [1] at their tabs and pull them downwards out of the embossings, then pull off the lateral air baffle.

	WARNING	Risk of damage to sensor!
To prevent accidental damage, be sure to avoid collision with the sensor when installing or uninstalling panels in the oven's workspace.		

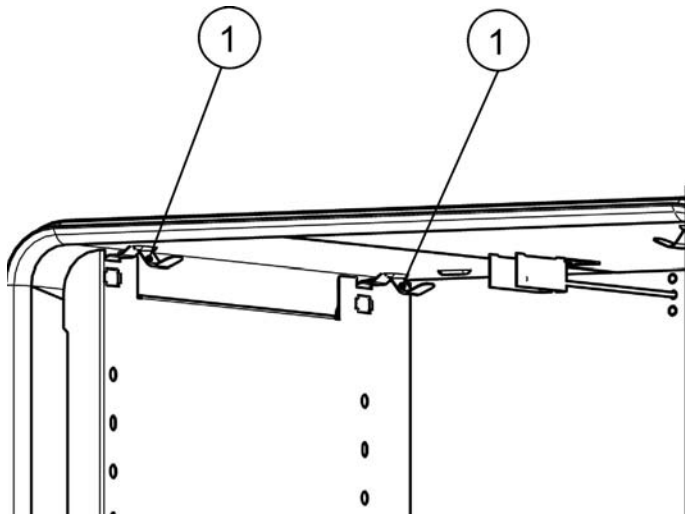

Figure 5-8 Removing the Lateral Air Baffle

3. For the lateral air baffles to install correctly, the two retaining springs [1] must be facing upwards. Place the lateral air baffle on the lower embossings and tilt it upwards against the side wall of the work space.
4. Clamp the two retaining springs [1] into the upper embossings.
5. Replace the bottom panel into the embossings and secure it by fastening the two screws at [1].

Commissioning of floor-mounted units

Installing/Removing air baffles (OGS Series)

The section below describes how to install/remove the bottom plate.

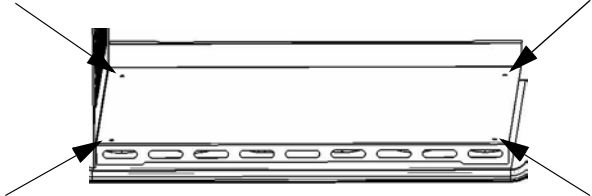

Figure 5-9 Removing the bottom plate

1. Loosen and remove the four (4) screws in the bottom plate and then remove the bottom plate completely.

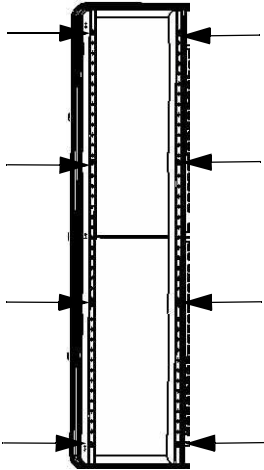

Figure 5-10 Removing the left and right support profiles

Loosen and remove the eight (8) screws for the left and right support profiles and then take out the lateral air baffles.

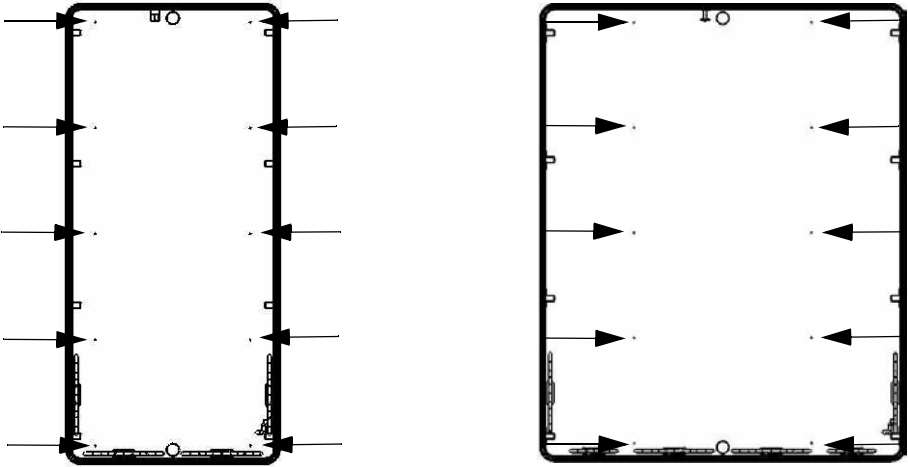

Figure 5-11 Removing the rear air baffle OGS 400/750

On the OGS 400/750 model remove the ten (10) screws for the rear air baffle and then remove the air baffle.

Commissioning, general

Installing the Shelf Support Brackets

1. Insert the shelf support brackets [3] into the perforations [1] of the support rail and air baffle and tilt them downwards.
2. Make sure that the two vertical elements [2] of the shelf support bracket butt against the support rail and air baffle.

NOTE	Horizontal position of support rails Please note the alternating sequence of round and oblong holes. Be sure to use the correct pair of opposite holes, so the support rails are truly horizontal.
-------------	---

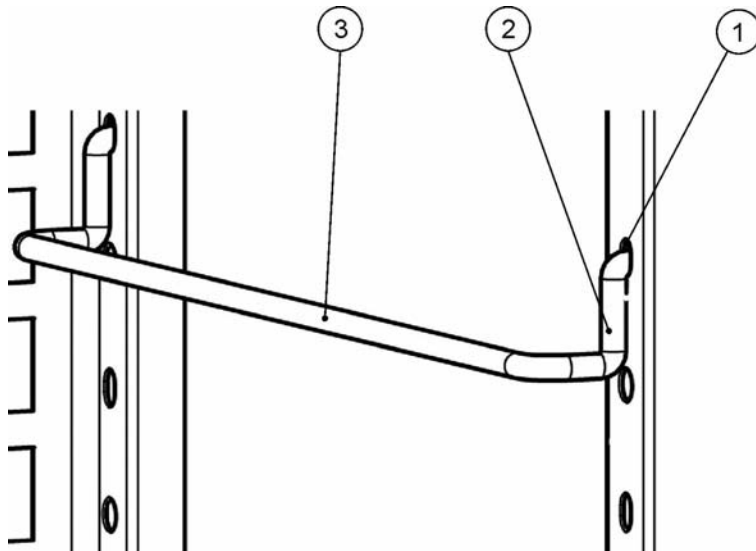

Figure 5-12 Shelf Support Bracket Installation

Installing the Wire-mesh Shelves

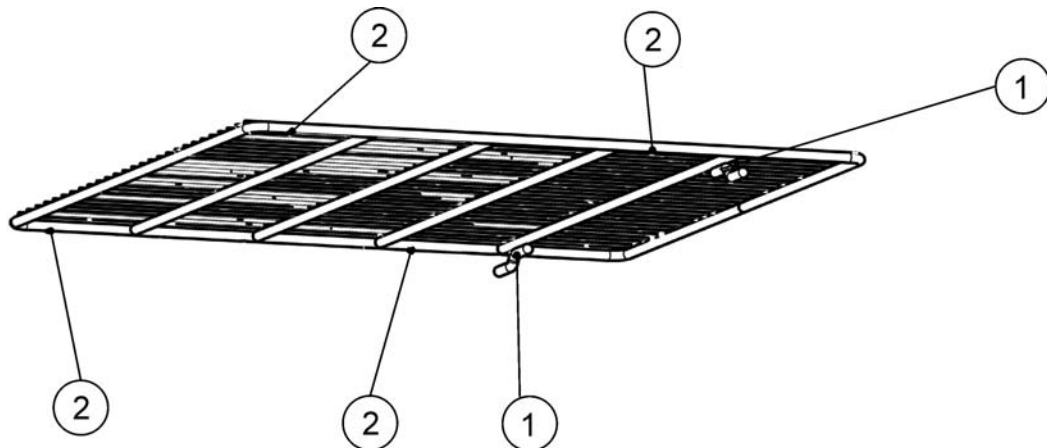

Figure 5-13 Wire-mesh shelf

1. Push the wire-mesh shelf onto the shelf support brackets with the tilt protection devices [1] facing the rear panel of the oven. The tilt protection devices [1] also serve as guides for the wire-mesh shelves.
2. Slightly raise the wire-mesh shelf so that the pull-out stops [2] can slide over the shelf support brackets.
3. Make sure that the shelves and both of their tilt protection devices are free to move over the shelf support brackets.

Leveling the Table-top units

1. Position a bubble level onto the center shelf.
2. Manually adjust the levelling feet until the wire-mesh shelf is horizontally aligned in all directions. Perform the adjustment of the levelling feet from left to right and from rear to front.

Mains Connection

	 DANGER	Electric shock
<p>Contact with live electrical components may cause a lethal electric shock. Before connecting the oven to the power supply, check the power cord and the plug for damage. Do not use damaged cables for connecting the oven to the power supply!</p>		

The oven has a class I, protection-earthed enclosure. To minimize the risk of electrical shock, use the AC power cord supplied to connect the oven to a correctly installed and protection-earthed power supply source, with the following features in place for each oven:

- T 16 A slow-blow fusing

- B 16 circuit breaker

NOTE	Benefits of using separate electrical feeders Although several devices may be operated on the same electrical feeder if the rated current is not exceeded, we strongly recommended to provide one feeder with a dedicated upstream circuit breaker per oven to avoid the failure of multiple devices in case of an electrical fault.
-------------	--

Connection to the power supply source

1. Before connecting the oven to the power source, check to see if the power supply voltage corresponds with the specifications on the nameplate on the front of the oven. If the voltage (V) and current (A) ratings given are not as required, do not connect the device to the power source!
2. Connect the IEC connector to the socket at the rear of the oven.
3. Route the power cord along a path that does not cross exhaust air piping or passageways and aisles. With stacked devices, keep the power cord away from hot spots on the other oven in the stack.
4. Connect the protection-earthed plug of the power cord to a correctly protection-earthed and earth leakage circuit breaker fused power socket.
5. Make sure the power cord is not subjected to tensile or compressive force.

NOTE	Make sure that power outlets remain freely accessible at all times! In an emergency the power connection must be rapidly disconnectable; so be sure to have the power outlets freely accessible at all times!
-------------	---

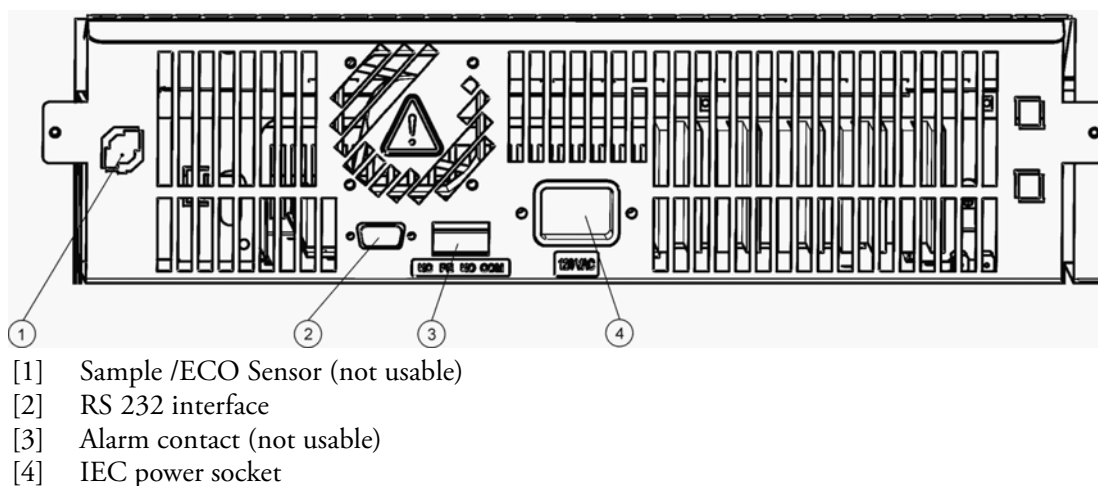

Figure 5-14 AC Power Supply Socket

	NOTE	Condensation When taking the oven into operation for the first time allow some time for stabilization before switching on to avoid condensation forming on live parts.
--	-------------	--

Connecting the RS-232 Interface

	NOTE	Replacement should only be carried out by skilled and authorized qualified personnel of electrotechnology/signal engineering!
--	-------------	--

The RS-232 data communication interface supports the querying of status information and temperature data from the oven by entering basic commands in a standard terminal window provided by your computer's operating system. The interconnection requires a standard RS-232 cable with 9-pin connectors and a straight "1:1" pinout without any crossed wires, which is not supplied with the oven.

Interconnecting the Oven with a Computer

1. Turn the computer off.
2. Route the serial interface cable along a path that does not cross hot exhaust air piping, tables, aisles or passageways. With stacked devices, keep the serial interface cable away from hot spots on the other oven in the stack.
3. Connect one connector of the serial interface cable (cable length, 5 to max. 10 m, not supplied as a standard item) to the socket labeled **RS 232** in the electrical interfaces section at the rear of the oven (see "[RS 232 Interface](#)" on [page 4-11](#)).
4. Connect the second connector to an unused COM 1 /COM 2 or other serial port on the computer.
5. Boot the computer.
6. Launch your standard terminal program and set up the connection with the following parameters:
 - 57600 bits per second
 - 8 Data bits
 - 1 stop bit
 - No Parity

7. Once your terminal indicates that serial communication has been established successfully, enter any of the commands listed in [table 5-1](#) below, depending on what type of information you want to query.
8. Use the following generic command syntax:

?:aaaa:bb::cc<CR>, where:

- **?:** identifies the command line as a query;
- **aaaa:** is the parameter address;
- **bb::** is a query, that must be left at „00” for technical reasons;
- **cc** is for a command - specific checksum listed in the table below.
- **<CR>** is for carriage return.

You will receive a response of the following general format:

!:aaaa:bb:XXXXX:cc<CR>, where:

- **!:** identifies the line as a response to a query;
- **aaaa:** is the parameter address entered with the query;
- **bb:** is the number of payload bytes in hexadecimal code - for example, **1F** for the decimal value **31**;
- **XXXXXX:** is the significant status information queried;
- **cc:** is a check sum (technically an inverted XOR of all bytes returned, excluding the check sum bytes and the **<CR>** character);
- **<CR>** is for carriage return.

Table 5-1 Terminal Commands for Querying Data

Command Syntax	Response Example
Combined Date and Time	
?:0010:00::c1	!:0010:11: 31.07.10;01:02:23 :e2 Date Time
Date only	
?:0011:00::c0	!:0011:08: 31.07.10 :d2 Date
Time only	
?:0012:00::c3	!:0012:08: 01:02:23 :dc Time
Temperature Set Value (T1); Current Work Space Temperature (T2); Reference Temperature (T3); Sample Sensor Temperature (T4)	
?:3010:00::c2	!:3010:1f:+125.00;+124.96;+000.000;+000.00:b0 T1 T2 T3 T4

Operation

Preparing the Oven

The oven must not be released for operation before all major start-up activities have been completed (see “Start-up” on page 5-1).

Device Check

Prior to starting operation, the following oven components must be checked for their correct function:

- The door seal in the front frame must not be damaged.
- The shelving components must be installed safely.

Starting Operation

1. Turn the oven on using the control panel.
2. Adjust the temperature set value on the control panel.
3. The temperature controller starts adjusting the work space to the user-specified temperature set value now.

NOTE

Upon initial installation and subsequent heat-up, this oven may produce an odor and trace evolution of non-toxic vapor that results from brake-out of the insulation binder. This condition is normal for factory-new products and will diminish with continued operation.





DANGER

To avoid any risk of explosion or fire

• refrain from loading the oven with any of the substances listed in the section “Incorrect Use” on page 1-5

- make sure that the ambient air is free of any solvents
- do not operate the oven in areas with an explosion hazard

4. Load the work space with samples.

		Hot surfaces
After opening the door, this may swing back automatically.		
The interior panel of the outer door as well as the surfaces of the outer housing, the shelving and the work space become extremely hot while the oven runs through its heating cycles.		
When removing samples from a running or recently completed heating cycle, always wear safety gloves and other appropriate personal protection equipment to avoid burns on hot surfaces!		

	Risk of overloading
Overloading may damage the wire-mesh shelves or cause the shelves and/or the oven to tilt when the shelves are being drawn out, ultimately destroying the samples. To avoid overloading the oven or its wire-mesh shelving be sure to observe the sample weight limits specified in section “Technical Data” on page 13-1.	

	Proper loading
To ensure sufficient air circulation and uniform heating of the samples, do not use more than 70% of the maximum surface area of the work space. Bulky objects in the work space that dissipate heat may impair heat distribution.	

Handling and Control

Heratherm OGS Series and OMS Series ovens come with a front panel mounted control unit consisting of a multifunctional display, four control buttons, and an on/off button. The four control buttons interact with the display window to let users access all of the user control functions and adjustments of the oven, including - for example, the temperature set value, timer, as well as a variety of other functions.

Under normal operating conditions the display presents user with the work space temperature. The display returns to its default mode upon completion of adjustments or whenever no entries have been made for a period of 30 seconds.



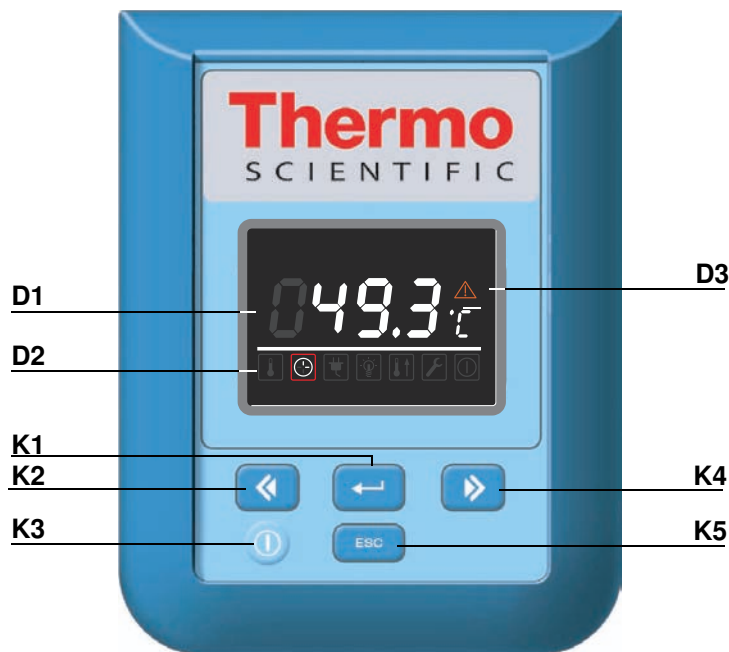

The graphic below shows the Heratherm OGS 60/100/180/400/750 and Heratherm OMS 60/100/180 control panel with all of its visualization elements and controls.

Figure 7-1 Control panel for Heratherm OGS Series and OMS Series Ovens







The table below contains brief descriptions of the buttons on the control panel (items K2 through K5 in [figure 7-1](#)).

Table 7-1 Control Buttons

Icon	Item	Function
	K1	<p>Menu/Enter button</p> <p>First key press: Activates the menu, highlighting the first menu item with a red border.</p> <p>Second key press: Selects the currently activated menu item (as highlighted by the red border); at the same time, pressing this button enables entries with item D1.</p> <p>Third key press (once a setting has been changed): Confirms a previous entry or selection.</p>
	K2	<p>Left button</p> <p>After the first press of Menu/Enter button:</p> <ul style="list-style-type: none"> - Moves the selection in the menu (see item D2) to the next icon on the left. <p>Once a menu item has been selected:</p> <ul style="list-style-type: none"> - Decreases an adjustable parameter value - for example, the temperature set value in D1. Holding this button depressed for a few seconds changes the selected value in quick run mode. -
	K3	<p>On/Off Button</p> <p>Holding this button depressed for 2 seconds switches the oven off. The display window goes out, except for the readiness indicator icon in the status display area at item D3.</p> <p>The temperature display pane D1 provides as dimmed readout of the work space temperature, provided that the temperature exceeds 50 °C (122 °F).</p>
	K4	<p>Right button</p> <p>After the first press of Menu/Enter button:</p> <ul style="list-style-type: none"> - Moves the selection in the menu (see item D2) to the next icon on the right. <p>Once a menu item has been selected:</p> <ul style="list-style-type: none"> - Increases an adjustable parameter value - for example, the temperature set value in D1. Holding this button depressed for a few seconds changes the selected value in quick run mode.
	K5	<p>Escape button</p> <p>Returns to the previous level of the menu or standard display. Upon exiting from the current menu item the user may be prompted to save any previously made settings.</p>

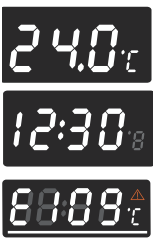
The table below contains brief descriptions of the display features of the control panel (items D1 through D3 in [figure 7-1](#); the identifiers K1 through K5 refer to the buttons shown in that figure).

Table 7-2 Display Features

Feature	Item	Function
	D1	<p>Display pane showing a permanent readout of the actual temperature in the work space either in °C or °F (depending on the user's preferences, see "Toggling the Temperature Display Unit" on page 7-11.).</p> <p>A flashing time entry prompt of the general format hh:mm (hours:minutes, both with two digits) appears in this place while the user is setting up a timer.</p> <p>Upon occurrence of an error condition, the current error code flashes in this area. Additionally, the red alarm icon at D3 flashes.</p>
	D2	<p>Menu bar with iconized representations of adjustable parameters. A red border is used to highlight the current Menu item, as selected using the Menu (K1) and arrow buttons Left (K2) and Right (K4). Brief descriptions of the individual menu items are given in table 7-3.</p> <p>Note If a menu item cannot be selected, then the function it represents is not part of the equipment configuration of your unit.</p>
	D3	<p>Alarm icon: Upon occurrence of an error condition, the red alarm icon will be illuminated. At the same time the current error code will flash in the display pane D1. The alarm may be acknowledged by pressing the  button.</p>

The table below contains brief descriptions of the menu bar icons (item D2 in [figure 7-1](#))

Table 7-3 Menu Bar Icons





Icon	Function
	<p>Temperature Set Value</p> <p>Allows for changing the temperature set value within the permissible temperature range. The set value can be changed by pressing the Left and Right (item K2 or K4) and you can, after confirming your changes with the Menu/Enter button (item K1), track the impact on the actual temperature in the display pane at D1.</p> <p>Instructions: "Temperature Set Value" on page 7-6.</p>
	<p>Timer</p> <p>Allows for having the oven turn on and/or off upon expiry of a user-specified countdown period. When the user enables an "on timer" the oven goes out. A rotating arrow in the Timer icon and the illuminated readiness indicator icon in the status display area indicate that the timer is running.</p> <p>Instructions: "Timer" on page 7-7.</p>
	<p>Settings</p> <p>Invokes a submenu with the following functions:</p> <ul style="list-style-type: none"> - Read access to error log - Calibrating the oven - Toggling the temperature display unit between °C and °F - Entering a configuration control code <p>(Instructions: "Settings" on page 7-9)</p>

Table 7-3 Menu Bar Icons

Icon	Function
	<p>Readiness Indicator: Illuminated when the oven has been switched off using the On/Off button (item K3 in figure 7-1). Unlike other menu items, this icon cannot be selected.</p>

	<div style="border: 1px solid black; padding: 5px; margin-bottom: 10px;"> <p style="text-align: center; font-size: 1.2em; color: white; background-color: #0056b3; display: inline-block;">NOTE</p> </div> <p>Button Inactivity Monitoring</p> <p>When no button is pressed for more than 30 seconds in any selected menu item, the display exits from the selected screen and returns to default display mode.</p>
--	---

Powering Up

1. Plug the power plug of the oven into a suitable protection-earthed AC power outlet.



In the display window on the front panel the readiness indicator icon (top right item at D3 in [figure 7-1](#) on [page 7-1](#)) is illuminated.



2. Keep the **On/Off** button depressed for two seconds.

An initialization routine will be run after the oven has been powered up. Once initialization has been completed, the display will light up and the current work space temperature will appear in the temperature display pane (item D1 in [figure 7-1](#) on [page 7-1](#)). The oven is ready for use now.

Switching the Oven Off / Powering Down



1. Keep the **On/Off** button depressed for two seconds.



The display window goes out, except for the readiness indicator icon (rightmost icon in the top right item at D3 in [figure 7-1](#) on [page 7-1](#)) and a residual heat temperature readout in case the work space temperature is still ≥ 50 °C/122 °F. The oven is switched off now.

2. If required, unplug the AC power plug to power down the oven completely.

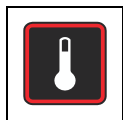

Temperature Set Value

Heratherm ovens allow for setting the desired work space temperature directly using only a few button presses. After confirming the new temperature set value, you may trace the resulting temperature change in the temperature display pane (item D1 in [figure 7-1](#) on [page 7-1](#)).

You can also use the temperature set value to speed up cool-down subsequent to a drying or heating process. Temperatures as low as ambient +10 °C can be selected, this requires open damper and no additional heat in unit. You can set the oven to a set temperature of 0 °C (32 °F), though, to speed up cool-down. This is achieved in one single step, as described further below.

Table 7-4 Adjusting the Temperature Set Value













	<p>Press  to activate the menu bar, then use  to select the Temperature icon and press  to confirm.</p>
	<p>In the temperature display pane, press  or  to adjust a new temperature set value, then press  to confirm your settings.</p>
	<p>The display returns to its default mode. The actual temperature measured in the work space and shown in the temperature display area starts to change until it reaches the newly adjusted set value.</p>

Table 7-5 Using the Temperature Set Value to Speed Up Cool-Down

	<p>At the end of the drying or heating process, press  to activate the menu bar, then use  to select the Temperature icon and press  to confirm.</p>
	<p>In the temperature display pane, press  to lower the temperature set value to 50 °C/122 °F, then on  to 0 °C (32 °F) in one additional step. When the display reads 0 °C (32 °F), press  to confirm your settings.</p>
	<p>The display returns to its default mode. The actual temperature measured in the work space and shown in the temperature display area starts to drop, showing the progress of the cool-down process.</p>



Timer

The **Timer** feature from the menu bar enables the user to set a “countdown-type” on or off timer that switches the oven on or off after a preset period of time. Instructions for setting an off timer are given in [table 7-7](#) (see below), while its use as an on timer is described in [table 7-8](#) on page 7-8.

Programming a turn-on time causes the oven to shut down until it is scheduled to restart, while a turn-off time keeps it running before it shuts down at the user-specified time. The timer starts running immediately as soon as the user confirms his or her entries.



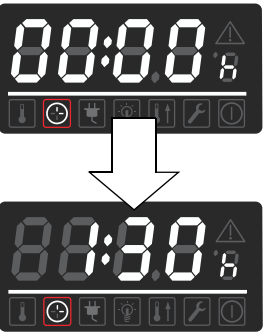





Table 7-6 Setting a Countdown-type Off Timer

	<p>Press to activate the menu bar, then use to select the Timer icon and press to confirm.</p>
	<p>The word OFF appears in the multifunctional display pane. Choose the off timer with .</p>
	<p>Set the hours and minutes until the oven is supposed to shut down by pressing or , then press to confirm.</p>
	<p>The display returns to its default mode. In the menu bar, the Timer icon is illuminated and an arrow is rotating on the icon's face.</p>

Table 7-7 Setting a Countdown-type On Timer

	<p>Press to activate the menu bar, then use to select the Timer icon and press to confirm.</p>
	<p>The word OFF appears in the multifunctional display pane.</p>

Table 7-7 Setting a Countdown-type On Timer

	<p>Press  to select the On timer option and confirm the selection with .</p>
	<p>Set the hours and minutes until the oven is supposed to turn on by pressing  or , then press  to confirm.</p>
 	<p>The oven switches off. The display goes out, the Timer icon is illuminated in the menu bar with a hand rotating on its face. Additionally, the readiness indicator icon is illuminated.</p>

Stopping a Timer

Table 7-8 Stopping an Off Timer Before It Expires











	<p>Press  to activate the menu bar, then use  to select the Timer icon and press  to confirm.</p>
	<p>Confirm the OFF by pressing , then press  to return to the main menu.</p>
	<p>In the menu bar, the Timer icon will go out. The display returns to its default mode.</p>

Table 7-9 Stopping an On Timer Before It Expires

	<p>To cancel a pre-programmed on timer while the oven is switched off, hold the On/Off button depressed for a few seconds.</p>
	<p>In the menu bar, the Timer icon will go out. The display returns to its default mode.</p>



Settings

The **Settings** menu item opens a submenu populated with various commands for viewing general status information on the unit and setting preferences for the operation of the oven or its display window:

- Read access to error log
- Calibrating the oven
- Toggling the temperature display unit between °C and °F
- Entering a configuration control code

Instructions for using these features are given in the following.

Error Log

Users calling customer service for support may be asked by the agent to supply information from the error log of the oven. It enables the user to browse through the most recent 22 alarm messages that were caused by hardware or control loop errors. Each error is displayed with an internal error code.

Error codes and instructions for clearing alarm conditions appear in the section [“Error Codes”](#) on [page 12-1](#).

Table 7-10 Reading the Error Log

	<p>Press to activate the menu bar, then use or to select the Settings icon and press to confirm.</p>
	<p>The word Err appears in the display pane to indicate that the error log has been selected.</p>
	<p>Use the button to select the first entry in the error log, numbered E01 (Error 01). This entry represents the most recently registered error.</p> <p>After a few seconds, the display pane automatically switches to the internal error code - for example, 109. E01 shows the latest fault, E22 shows the oldest fault.</p>

Table 7-10 Reading the Error Log

	<p>Press to go to the next entry (or to go back to the previous one). After reaching the entry numbered 22 the display wraps and returns to the beginning of the error log, that is, to entry “number E01”.</p>
	<p>To exit from the error log and return to normal display mode press . The Settings icon in the menu bar will go out.</p>

Calibration

The **Settings** -> **Calibration** menu item enables the user to initiate a temperature calibration routine for the built-in temperature sensors and choose whether calibration should be accomplished manually or automatically:







- The **Manual** option allows for entering an absolute temperature directly, as measured - for example, using an external reference sensor.

<h1 style="margin: 0;">NOTE</h1>	<p>Calibration Prerequisites</p> <p>Maintain the ambient conditions within the specified limits of the oven and make sure that the damper is fully closed before launching calibration.</p> <p>Varying ambient conditions and/or an open damper may impact the result of the calibration routine, which may lead to misadjustment of the controller and unreliable temperature control operation.</p>
----------------------------------	--

Table 7-11 Entering the Calibration Reference Temperature Manually

	<p>Press to activate the menu bar, then use or to select the Settings icon and press to confirm.</p>
	<p>Press to switch to the CAL(ibration) menu item and press to confirm.</p>

Table 7-11 Entering the Calibration Reference Temperature Manually

	<p>The word USER appears in the display pane. Press  to confirm the selection.</p>
	<p>In the settings dialog that appears, set the temperature measured with the external reference sensor by using  or  and confirm the settings with .</p>
	<p>The newly entered value will be stored and used to calibrate the internal temperature sensors with the value supplied by the reference sensor. The display returns to its default mode. The Settings icon in the menu bar will go out.</p>

Temperature Display Unit

The **Settings** -> °C / °F menu item allows for toggling the unit used for displaying temperatures between degrees Centigrade and Fahrenheit.

Note This setting does not have any impact on data logging via the RS-232 interface. Any temperature data that is logged to a computer for operational parameter documentation purposes is handed over in °C.

Table 7-12 Toggling the Temperature Display Unit











	<p>Press  to activate the menu bar, then use  or  to select the Settings icon and press  to confirm.</p>
	<p>Press  to switch to the C - F menu item. The text C - F is flashing in the display pane.</p>

Table 7-12 Toggling the Temperature Display Unit

	<p>Press the  button.</p> <p>The currently unused temperature unit °C or °F is flashing in the display pane (the factory default setting is °F.)</p> <p>Confirm the selection with .</p>
	<p>The temperature unit to the right of the temperature display field (item D1 in figure 7-1 on page 7-1) has changed according to your selection.</p> <p>The display returns to its default mode.</p> <p>The Settings icon in the menu bar will go out.</p>

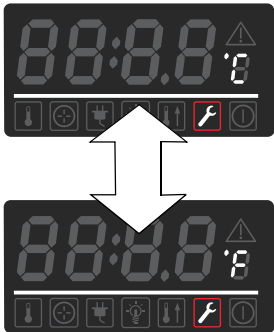
Configuration

The **Settings** -> **Configuration** menu item enables the user to enter a four-digit code that loads a specific set of operating parameters for the oven - for example, in order to make the voltage selection described in the section “[Connecting the RS-232 Interface](#)” on [page 5-11](#).

Table 7-13 Entering the Four-digit Code















	<p>Press  to activate the menu bar, then use  or  to select the Settings icon and press  to confirm.</p>
	<p>Press  to switch to the ConF(iguration) menu item. The word ConF will be flashing in the multifunctional display pane.</p> <p>Press the  button.</p>

Table 7-13 Entering the Four-digit Code

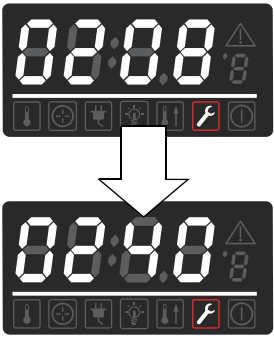
	<p>The multifunctional display pane will present a prompt similar to the example shown at left, with the first digit of the four-digit configuration code flashing.</p> <p>Set the first digit of the configuration code using  (or ) and confirm your setting with .</p> <p>Set the remaining three digits exactly as described above. Enter code "1234" to reset the user calibration.</p> <p>By confirming your entry for the last digit with , the new configuration is activated immediately.</p>
	<p>The display returns to its default mode.</p> <p>The Settings icon in the menu bar will go out.</p> <p>Enter the four-digit code '1234' to reset the user calibration.</p> <p>Enter the four-digit code '4321' to reset the sensor sample calibration.</p>

Handling and Control
Switching the Oven Off / Powering Down

Shut-down

This chapter provides instructions for shutting the oven down for prolonged periods of time, that is, at least for several days in a row.



Shutting the Oven Down

1. Remove the containers with the samples and all accessories from the work space.
2. Turn the oven off using the control panel.
3. Unplug the power connector and secure it against accidental reconnection.
4. Until the oven is shut down, the work space must be continuously ventilated. Leave the door open and secure it against accidental closure.

**Shut-down
Shutting the Oven Down**

Cleaning and Disinfection

Cleaning

		Incompatible cleaners
	<p>Some oven components are made of plastics. Solvents may attack plastics. Strong acids or alkaline solutions may cause embrittlement of plastics.</p>	
		Moisture-sensitive components
	<p>Do not spray cleaning agent onto the control panel and the control box at the rear of the oven. When wiping the oven clean, always make sure that no moisture enters into these components. Wipe the display window down with a slightly dampened cloth, then wipe dry with a rag made of 100% microfiber.</p>	

Cleaning Exterior Surfaces

Remove dirt residues and depositions thoroughly using a solution of lukewarm water and commercial detergent.





Wipe the surfaces clean using a clean cloth and clear water.

Then, wipe the surfaces dry using a clean cloth.



Wipe / Spray Disinfection



The manual wipe and spray disinfection is the following process:

- predisinfection
- cleaning as appropriate for the current application.

		Alcoholic disinfectants!
		<p>Disinfectants having an alcohol content of more than 10% may form, in combination with air, easily combustible and explosive gas mixtures.</p>
		<p>When using such disinfectants, avoid open flames or exposure to excessive heat during the entire disinfection process!</p>
		<p>Use such disinfectants only in adequately ventilated rooms.</p>
		<p>After the disinfectant has been allowed to react, wipe the cleaned oven components thoroughly dry.</p>
		<p>Observe safety regulations to avoid fire and/or explosion hazard caused by alcohol-containing disinfectants.</p>
		Chloride-containing disinfectants!
		<p>Chloride-containing disinfectants can corrode stainless steel and galvanized metal surfaces.</p>
		<p>Use only disinfectants that do not affect stainless steel and galvanized metal surfaces!</p>

Preparing the manual wipe/spray disinfection

		Electrical shock
		<p>Contact with live electrical components may cause a lethal electric shock.</p>
		<p>Before connecting the oven to the power supply, check the power cord and the plug for damage. Do not use damaged cables for connecting the oven to the power source!</p>

	 WARNING	Health hazard
	<p>The surfaces of the work space may be contaminated. Contact with contaminated cleaning liquids may cause infections. Disinfectants may contain harmful substances.</p> <p>When cleaning and disinfecting, always observe the safety instructions and hygiene guidelines!</p> <p>Wear safety gloves.</p> <p>Wear safety goggles.</p> <p>Wear mouth and respiratory system protection gear to protect your mucous membranes.</p> <p>Observe the safety instructions of the disinfectant's manufacturer and the hygiene supervisor.</p>	

Predisinfection

1. Remove all samples from the work space and store them in a safe place.
2. Spray disinfectant onto the surfaces of the work space and of the accessories or wipe the surfaces clean using disinfectant.
3. Allow time for the disinfectant to act as specified by the manufacturer.

	Moisture-sensitive components
Spray the sensor with disinfectant.	

Maintenance

Regular maintenance is mission-critical to avoid malfunctions due to ageing and wear. Failure to perform maintenance on a regular basis may result in:

- deviations in heating performance
- loss of control over temperature distribution throughout the work space
- damage to samples

Inspections and Checks

To ensure the operational performance and safety of the oven, their functions and the components listed below must be checked at regular intervals.

Regular Checks

- Check the oven for overall cleanliness and remove any debris from previous processes.
- To avoid operation without an appropriate fresh air supply, check the air filter (accessory to be ordered separately) in the air inlet for contamination.

Monthly Inspection

- Check integrity and proper seating of the door seal.
- Swap air filter cartridge (optional) in air inlet.
- Perform functional check of the control panel and of the oven's built-in controller.
- Perform electrical safety check in accordance with the relevant national regulations.

NOTE

Functional check

If safety devices were removed or disabled for inspections, the oven must not be operated before the safety devices have been reinstalled and checked for their correct function.

	<div style="border: 1px solid black; padding: 5px;"> WARNING</div> <p>Spare Parts and User Modifications</p> <p>To avoid major malfunctions of the oven and associated safety hazards that may result in death, serious injuries, or damage to the oven and other equipment, use spare parts approved by Thermo Electron LED GmbH only. Third-party spares without approval void the limited warranty.</p> <p>Do not modify the oven in any way without obtaining the prior written authorization from Thermo Electron LED GmbH. Unauthorized modifications may compromise operational safety and give rise to hazards that may result in death, serious injuries, or damage to the oven and other equipment.</p>
--	--

Service Intervals

During ongoing operation, the following service work must be performed:

Annual service

Have the oven inspected and serviced by an authorized Technical Service agent.

	<div style="border: 1px solid black; padding: 5px;"><div style="background-color: #0056b3; color: white; padding: 5px; text-align: center; font-weight: bold; font-size: 1.2em;">NOTE</div><p>Service contract</p><p>Thermo Electron LED GmbH offer a product-specific service contract comprising all necessary tests and service work.</p></div>
--	---

Preparing Temperature Calibration

To determine the exact measured value of the oven's integral temperature sensor, a temperature comparison measurement must be performed every three months. If a major temperature deviation is found during this check, temperature calibration is required. During this process, the temperature controller of the oven is set to the value measured during the temperature comparison measurement.

Use a calibrated measuring instrument with an accuracy of $< \pm 1 \text{ }^\circ\text{C}$ ($1.7 \text{ }^\circ\text{F}$) for this test.

To minimize temperature variations during the measurement, put the measuring sensor in an isothermal container (such as a bowl filled with glycerol) before placing it in the work space. Use the center of the work space as the reference location for the comparison measurement.

	<table border="0"><tr><td data-bbox="533 365 895 456">NOTE</td><td data-bbox="922 387 1220 418">Isothermal Container</td></tr><tr><td colspan="2" data-bbox="518 477 1433 544">Do not use a container filled with water as an isothermal container because the evaporation of water will result in a lower temperature reading.</td></tr><tr><td data-bbox="533 591 895 683">NOTE</td><td data-bbox="922 613 1428 645">Excessive Work Space Temperatures</td></tr><tr><td colspan="2" data-bbox="518 703 1406 770">Excessive work space temperatures subsequent to a calibration run can be reduced by leaving the door open for approx. 30 seconds.</td></tr></table>	NOTE	Isothermal Container	Do not use a container filled with water as an isothermal container because the evaporation of water will result in a lower temperature reading.		NOTE	Excessive Work Space Temperatures	Excessive work space temperatures subsequent to a calibration run can be reduced by leaving the door open for approx. 30 seconds.	
NOTE	Isothermal Container								
Do not use a container filled with water as an isothermal container because the evaporation of water will result in a lower temperature reading.									
NOTE	Excessive Work Space Temperatures								
Excessive work space temperatures subsequent to a calibration run can be reduced by leaving the door open for approx. 30 seconds.									

Comparison Measurement Procedure

1. Turn the oven on using the power switch.
2. Set the temperature set value and allow the oven to stabilize. This may take several hours.
3. Place the measuring device in the center area of the work space. Alternatively, a temperature sensor may be positioned in this location. Route the connecting cable between the glass panel and the interior tank.
4. Close the doors.
5. Wait until the temperature value displayed on the measuring instrument has stabilized.
6. Use the temperature reading from the measuring device to calibrate temperature control manually, as explained [“Entering the Calibration Reference Temperature Manually”](#) on [page 7-11](#).

Temperature Calibration Procedure

For detailed instructions on how to perform a manual temperature calibration, please refer to the instructions in the section [“Calibration”](#) on [page 7-11](#).

	<table border="0"><tr><td data-bbox="533 1610 895 1702">NOTE</td><td data-bbox="922 1632 1428 1664">Excessive Work Space Temperatures</td></tr><tr><td colspan="2" data-bbox="518 1722 1406 1789">Excessive work space temperatures subsequent to a calibration run can be reduced by leaving the door open for approx. 30 seconds.</td></tr></table>	NOTE	Excessive Work Space Temperatures	Excessive work space temperatures subsequent to a calibration run can be reduced by leaving the door open for approx. 30 seconds.	
NOTE	Excessive Work Space Temperatures				
Excessive work space temperatures subsequent to a calibration run can be reduced by leaving the door open for approx. 30 seconds.					

Replacing the Door Seal

The door seal of the outer door is located in the retaining slot. The door seal should be inspected for any signs embrittlement every six months when the oven has been used at maximum temperatures of up to 250 °C / 482 °F.

No tools are required to replace the seal.

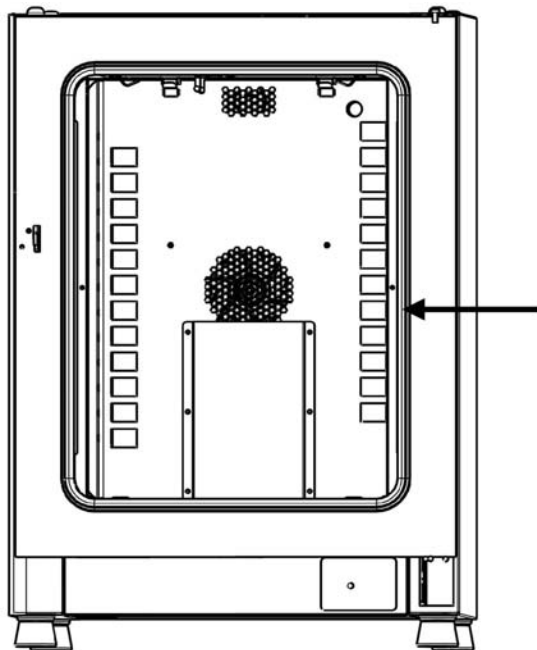

Figure 10-1 Door seal replacement (example showing OMH Series oven)

1. Pull the seal out of the guide slot.
2. Starting on the hinge side of the door, position the seam of the new seal at the location indicated by the arrow in [figure 10-1](#).
3. Gently press the seal into the slot, working around the circumference of the door. In doing so, be careful not to stretch the seal.
4. Make sure that the retaining rail taper is positioned correctly in the slot and that the seal is flush with the door frame.



Replacing the Power Cord

When the device's power cord is damaged, it must be replaced with an original spare part. Using a standard power cord with a lower temperature withstand class is prohibited.

Returns for Repair

Prior to returning any materials, please contact our Technical Services Department for a "Return Materials Authorization" number (RMA).

Material returned without an RGA number will be returned.

	<div data-bbox="528 259 903 356"> WARNING</div> <p data-bbox="927 282 1238 315">Contamination hazard</p> <p data-bbox="520 376 1430 477">The oven may have been used for treating and processing infectious substances, which may have caused contamination of the oven and its components.</p> <p data-bbox="520 479 1331 546">Prior to return shipment, it is therefore mandatory that all oven components be properly decontaminated.</p> <ul data-bbox="539 568 1390 763" style="list-style-type: none">• Clean the oven components thoroughly, then disinfect or decontaminate them (depending on application).• Fill in and attach a safety declaration with details on decontamination activities performed to the items that are to be repaired.
---	--

**Maintenance
Returns for Repair**

Disposal

	<div style="border: 1px solid black; padding: 5px;">  WARNING </div> <p>Contamination hazard</p> <p>The oven may have been used for treating and processing infectious substances, which may have caused contamination of the oven and its components. Prior to disposal, it is therefore mandatory that all oven components be properly decontaminated.</p> <ul style="list-style-type: none"> • Clean the oven components thoroughly, then disinfect or decontaminate them (depending on application). • Attach a declaration of decontamination with details on decontamination activities performed to the items that are to be disposed of.
--	---

Overview of Materials Used

Component	Material
Thermal insulation components	Glass wool
Printed circuit boards	Coated electrical components contain various plastics materials. Components mounted on circuit boards containing epoxy resin bonder.
Plastic components, general	see material labelling
Exterior housing	Galvanized steel sheet, painted
Oven rear panel	Galvanized steel sheet
Outer door	Galvanized steel sheet, painted
Door inner panel	OMS and OGS Series: Stainless steel 1.4301
Control panel and display window protective foil	Polyethylene
Heater	Stainless steel-sheathed resistance heater wires

**Disposal
Overview of Materials Used**

Component	Material
Interior containers, installed components and shelves	Stainless steel 1.4301; shelves are chrome-plated
Door frame seal	Silicone
Fan impeller	Stainless steel 1.4016 (OMS Series only)
Cables	Plastic-sheathed stranded copper wire
Packaging	Corrugated board, polyethylene film, and styrofoam, chemically untreated wood

Error Codes

Table 12-1 below lists the error messages that may appear in the control panel display window (see “Error Log” on page 7-9) and provides instructions for clearing such alarms.

Table 12-1 Heratherm Oven Error Codes



Error Message & Code	Root Cause	Alarm Response	Alarm Clearing Instructions
Display Error (E002)	Display communication error. The built-in controller was unable to restore communication with the control panel.	Audible alarm activated, alarm relay energized, message shown on display. Reset after 30 s.	Power cycle the device by unplugging, then reconnecting the power cord. If this doesn't solve the problem, call service.
Mirrored Parameter Loaded (E003)	The controller was unable to read the user-specific settings and had to resort to an emergency parameter set held in mirrored storage.	Audible alarm activated, alarm relay energized. Fallback to mirrored parameter storage. Device continues to run without loss of functionality, including user-specific settings.	Check the latest settings, for example the set value.
Factory Parameter Loaded (E004)	The controller was unable to read the mirrored parameter set and had to resort to factory-preset parameters.	Fallback to factory-preset parameters. Audible alarm activated, alarm relay energized, message shown on display. User-specific settings may be lost - for example, the temperature display unit preference, or user programs.	Acknowledge by pressing  . Re-enter customer-specific settings.
Default Parameter Loaded (E005)	The controller was unable to read the factory-preset parameters and had to resort to default settings	Fallback to default parameters. Audible alarm activated, alarm relay energized, message shown on display. The device is completely inoperative.	Call service.
Power Down Error (E007)	Power has been cut off (power outage) while the device was running.	Audible alarm activated, alarm relay energized, message shown on display.	Check the power supply. Power up then device, then acknowledge the alarm by pressing  .

Table 12-1 Heratherm Oven Error Codes

Error Message & Code	Root Cause	Alarm Response	Alarm Clearing Instructions
Fan Error (E009) (OMS Series only)	Fan speed out of range.	Audible alarm activated, alarm relay energized, message shown on display. Heater disabled by controller.	Acknowledge by pressing  . If this doesn't solve the problem, call service.
Config Error (E012)	General device configuration error.	Audible alarm activated, alarm relay energized, message shown on display. The device is completely inoperative.	Call service.
OTP Error (E013)	Klixon contact has tripped.	Overtemperature Protection fault. Audible alarm activated, alarm relay energized, message shown on display. Bridging across Klixon contact has failed.	Call service. Restart the oven. If this doesn't solve the problem, call service.
Incorrect voltage (E014)	The applied voltage is too high or too low.	Audible alarm activated, error message shown on display.	Apply the correct voltage as indicated on the nameplate and acknowledge the error.
Sensor Error (E100)	Process sensor damaged. The actual measured value is out of range.	Audible alarm activated, alarm relay energized, message shown on display. Control transferred to reference sensor. If both sensors are defective, disable all control circuits.	Call service.
Temperature too high (E101)	Actual measured value exceeds permissible range. The Triac is defective.	Process protection activated, control continues on set value. Audible alarm activated, alarm relay energized, message shown on display.	Call service.
Temperature not plausible (E103)	The difference between the control and reference sensors exceeds the maximum permissible deviation, rendering the measurement implausible.	Device uses the sensor that indicates the higher temperature for servo control. Audible alarm activated, alarm relay energized, message shown on display. Error can be acknowledged and doesn't reset.	If the problem does not go away, call service.
Calibration value too high (E104)	The calibration reference value calculated on the basis of the user input falls short of the upper limit for calibration references.	Fallback to previous calibration reference. Audible alarm activated, alarm relay energized, message shown on display.	Check the external reference sensor for proper function and replace, if necessary. If this doesn't solve the problem, call service.

Table 12-1 Heratherm Oven Error Codes

Error Message & Code	Root Cause	Alarm Response	Alarm Clearing Instructions [†]
Calibration value too low (E105)	The calibration reference value calculated on the basis of the user input exceeds the lower limit for calibration references.	Fall back to previous calibration reference. Audible alarm activated, alarm relay energized, message shown on display.	Check the external reference sensor for proper function and replace, if necessary. If this doesn't solve the problem, call service.
Constant sensor signal (E106)	None of the decimal places of the A/D-converter output for the process sensor has changed over a specific time period.	Control transferred to reference sensor. Audible alarm activated, alarm relay energized, message shown on display. If both sensors are defective, all control circuits will be disabled.	Call service.
Constant reference sensor signal (E107)	None of the decimal places of the A/D-converter output for the process sensor has changed over a specific time period.	Process control continues on set value. Audible alarm activated, alarm relay energized, message shown on display. If both sensors are defective, all control circuits will be disabled.	Call service.
Heating relay error (E109)	The voltage measurement has indicated a defect in the heater circuit relay.	Device completely inoperative, audible alarm activated, alarm relay energized, message shown on display.	Call service.
Heating triac error (E110)	The voltage measurement has indicated a defect in the triac.	Audible alarm activated, alarm relay energized, message shown on display. Audible alarm returns upon acknowledgement.	Switch off the oven and call service.
Temperature too high (E111)	Actual measured value exceeds permissible range. May occur when the user lowers the set point temperature on a hot device whose door is closed.	Audible alarm activated, alarm relay energized, message shown on display. Heater turned off until upper limit of hysteresis is recovered. Servo control operations continue. Alarm can be acknowledged, and goes away when the difference between the actual and set values ceases to exist. Note: This error does not indicate a defective triac.	Open the door to speed up cool-down. Check whether the device was loaded with a hot object, if so, remove. Ensure that the equipment was operated with at least one perforated shelf and with the door not opened longer than 10 min. If this doesn't solve the problem, call service.

Table 12-1 Heratherm Oven Error Codes

Error Message & Code	Root Cause	Alarm Response	Alarm Clearing Instructions ¹
Sensor error (E112)	Unsuitable sample load or possible damage to reference sensor. The measured actual value is out of range.	Audible alarm activated, alarm relay energized, message shown on display. Control continues on process sensor. If both sensors are defective, all control circuits will be disabled.	Call service.
Sensor error (E113)	The measured actual value is out of range.	Audible alarm activated, alarm relay energized, message shown on display.	Call service.
ADC error (E114)	Measurement across reference resistor R403 has failed. A/D converter does not supply a plausible output.	Audible alarm activated, alarm relay energized, message shown on display.	Call service.
Watchdog error (E115)	Watchdog does not trigger a reset after power-up.	Audible alarm activated, alarm relay energized, message shown on display.	Call service.

1. The rectification of an error is deemed to have been successful when the audible alarm stops sounding, the alarm relay drops out and the message disappears from the control panel display.

Technical Data

The technical data are valid only for an empty device equipped with three shelves, a spray-painted outer enclosure and a power line voltage 230 V/50 Hz. Options may have an impact on the specified performance.

Table 13-1 Technical Data - OGS and OMS Series - Table-top units

Parameter	Unit	OGS 60	OGS 100	OGS 180	OMS 60	OMS 100	OMS 180
Process							
Work Space Atmosphere Min. ¹	°C/°F	50/122	50/122	50/122	50/122	50/122	50/122
Max.	°C/°F	250/482	250/482	250/482	250/482	250/482	250/482
Temperature deviation from set value at 150 °C (302 °F), spatial. Max. value/Typical value	K	±4.5 / ±4.4	±4.5 / ±4.0	±4.5 / ±4.0	±3.5 / ±2.8	±3 / ±2.5	±3.5 / ±2.8
Temperature deviation from set value at 150 °C (302 °F), over time.	K	±0.4	±0.4	±0.5	±0.3	±0.3	±0.3
Heat-up time (work space unoccupied, from 25 °C (77 °F) to 98% of set temperature of 150 °C/302 °F) Max. value/Typical value	min	25	25	25	18	16/14	18
Recovery time (work space unoccupied, door open for 30 s, to set temperature). Max. value/Typical value	min	9/8	9/8	9/8	5/3	5/3	5/4
Heat dissipation to environment (at set temperature of 150 °C (302 °F) and room temperature of 25 °C/77 °F)	W	194±10%	261±10%	320±10%	291±10%	426±10%	473±10%
Max. air changes at 150 °C/302 °F	h ⁻¹	19	16	18	33	61	31
Overall dimensions							
Height	mm/in	720/ 28.3	820/ 32.3	920/ 36.2	720/ 28.3	820/ 32.3	920/ 36.2
Width	mm/in	530/ 20.8	640/ 25.2	640/ 25.2	530/ 20.8	640/ 25.2	640/ 25.2
Depth	mm/in	565/ 25.2	565/ 25.2	738/ 29.1	565/ 25.2	565/ 25.2	738/ 29.1
Overall weight	kg/lbs	42/93	53/117	66/146	42/93	53/117	66/146

Table 13-1 Technical Data - OGS and OMS Series - Table-top units

Parameter	Unit	OGS 60	OGS 100	OGS180	OMS 60	OMS 100	OMS 180
Loading capacity							
Loading capacity per shelf	kg/lbs	25/55			25/55		
Max. overall loading capacity per device	kg/lbs	50/110	50/110	75/165	50/110	50/110	75/165
Electrical data							
Power rating	W	1800	3100	3100	1400	3060	3060
Maximum current	A	7.9	13.5	13.5	6.1	13.3	13.3
Earthing system (e.g. 1/N/PE)		1/N/PE	1/N/PE	1/N/PE	1/N/PE	1/N/PE	1/N/PE
Power line frequency	Hz	50/60	50/60	50/60	50/60	50/60	50/60
Power line voltage +/- 10 %	V	230	230		230	230	
IP protection system		IP 20			IP 20		
Protection class		I			I		
Overvoltage category as per IEC 60364-4-443		II			II		
Device fusing, building side	A	16			16		
Device fusing, on PCB	A	2 x 16			2 x 16		
Environmental conditions							
Min. ambient temperature	°C/°F	18/65			18/65		
Max. ambient temperature	°C/°F	32/90			32/90		
Max. humidity in service, non condensing	% r.F./% r.H.	80, non condensing			80, non condensing		
Min. storage temperature	°C/°F	20/68			20/68		
Max. storage temperature	°C/°F	60/140			60/140		
Max. humidity in storage, non condensing	% r.F./% r.H.	90, non condensing			90, non condensing		
Post-transport acclimation time	h	2			2		
Noise level	dB(A)	no inherent noise			45	52	52
Pollution degree as per IEC EN 61010-1		2			2		
Site conditions							
Maximum altitude above sea level	m/y ASL	2000/2187			2000/2187		
Minimum side clearance	mm/in	50/2			50/2		
Minimum front clearance	mm/in	590 / 23.2	690 / 27.2	814 / 32	590 / 23.2	690 / 27.2	814 / 32
Minimum back wall clearance	mm/in	80/3.2			80/3.2		

Table 13-1 Technical Data - OGS and OMS Series - Table-top units

Parameter	Unit	OGS 60	OGS 100	OGS 180	OMS 60	OMS 100	OMS 180
Minimum bottom clearance	mm/in	200/8			200/8		
Minimum top clearance	mm/in	300/12			300/12		

¹ Temperatures as low as ambient +10 °C can be selected, this requires open damper and no additional heat in unit.

Table 13-2 Technical Data - OGS Series - Floor stand units

Parameter	Unit	OGS 400	OGS 750	OGS 750-3P
Process				
Work Space Atmosphere Min. ¹	°C/°F		50 °C/122 °F	up to 300/572
Max.	°C/°F		250 °C/482 °F	
Temperature deviation from set value at 150 °C (302 °F), spatial. Max. value/Typical value	K	±3.0 / ±3.0	±4.0/±3.0	±4.0/±3.7
Temperature deviation from set value at 150 °C (302 °F), over time	K	±0.5		
Heat-up time (work space unoccupied, from 25 °C (77 °F) to 98% of set temperature of 150 °C (302 °F))	min	35/31	60/53	60/53
Recovery time (work space unoccupied, door open for 30 s, to set temperature) Max. value/Typical value	min	< 8 / < 6	< 9 / < 7	< 9 / < 7
Heat dissipation to environment (at set temperature of 150 °C (302 °F) and room temperature of 25 °C/77 °F)	W	520 ±10%	795 ±10%	795 ±10%
Max. air changes at 150 °C (302 °F)	h ⁻¹	20	8	8
Overall dimensions				
Height (with casters)	mm/in	1655/ 65.2		
Width	mm/in	755/ 29.7	1215/ 47.8	
Depth	mm/in	770/ 30.3		
Overall weight	kg/lbs	136/300	182/401	182/401
Loading capacity per shelf	kg/lbs	40/88		
Max. overall loading capacity per device	kg/lbs	75/165	150/330	
Electrical data				
Power rating	W	2400	3000	6350

Table 13-2 Technical Data - OGS Series - Floor stand units

Parameter	Unit	OGS 400	OGS 750	OGS 750-3P
Max. Current	A	10.5	13.0	11.0
Earthing system (e.g. 1/N/PE)		1/N/PE	1/N/PE	3/N/PE
Power line frequency	Hz	50/60		
Power line voltage +/- 10 %	V	230		400
IP protection system		IP 20		
Protection class		I		
Overvoltage category as per IEC 60364-4-443		II		
Device fusing, building side	A	16		3 x 16
Device fusing, on PCB	A	2 x 16		3 x 16
Environmental conditions				
Min. ambient temperature	°C/°F	18/65		
Max. ambient temperature	°C/°F	32/90		
Max. humidity in service, non condensing	% r.F./ % r.H.	80, non condensing		
Min. storage temperature	°C/°F	20/68		
Max. storage temperature	°C/°F	60/140		
Max. humidity in storage, non condensing	% r.F./ % r.H.	90, non condensing		
Post-transport acclimation time	h	2		
Noise level	dB(A)	no inherent noise		
Degree of pollution as per IEC EN 61010-1		2		
Site conditions				
Maximum altitude above sea level	m/y ASL	2000/2187		
Minimum side clearance	mm/in	120/4.7		
Minimum front clearance	mm/in	810 /31.9	670 / 26.4	670 / 26.4
Minimum back wall clearance	mm/in	120/5.9		
Minimum top clearance	mm/in	200/8		

¹ Temperatures as low as ambient +10 °C can be selected, this requires open damper and no additional heat in unit.

Spare Parts and Accessories

Material No.	Description
50027662	Fresh air filter for Heratherm ovens
50073715	Fuses 5,0 A 250V T 6, 3 x 32 mm
50126665	Stacking adapter Heratherm 60L
50126666	Stacking adapter heratherm 100L
50126667	Stacking adapter heratherm 180L
50127102	Kit fresh air filter for Heratherm ovens
50127431	Outer door for Heratherm IGS 60, IMH 60, IMH 60-S, OMS 60, OMH 60, OMH 60-S, OGS 60, OGH 60 and OGH 60-S with a door stop on the left side
50127432	Outer door for Heratherm IGS 100, IMH 100, IMH 100-S, OMS 100, OMH 100, OMH 100-S, OGS 100, OGH 100 and OGH 100-S with a door stop on the left side
50127433	Outer door for Heratherm IGS 180, IMH 180, IMH 180-S, OMS 180, OMH 180, OMH 180-S, OGS 180, OGH 180 and OGH 180-S with a door stop on the left side
50127434	Outer door for Heratherm IGS 60, IMH 60, IMH 60-S, OMS 60, OMH 60, OMH 60-S, OGS 60, OGH 60 and OGH 60-S with a door stop on the right side
50127435	Staple feet Heratherm incubators and heating & drying ovens
50127436	Kit door seal for Heratherm 60L
50127437	Kit door seal for Heratherm 100L
50127438	Kit door seal for Heratherm 180L
50127439	Kit door clips for Heratherm 60L / 100L / 180 L
50127443	Levelling feet for Heratherm incubators and heating & drying ovens
50127444	Kit door handle right Heratherm incubators and heating & drying ovens
50127445	Kit door handle left Heratherm incubators and heating & drying ovens
50127446	Kit door handle right Heratherm incubators and heating & drying ovens
50127447	Kit door handle left Heratherm incubators and heating & drying ovens
50127448	Temperature sensor for Heratherm heating & drying ovens

Material No.	Description
50127450	Upper door hinge for Heratherm incubators and heating & drying ovens
50127451	Lower door hinge for Heratherm incubators and heating & drying ovens
50127455	Outer door for Heratherm IGS 100, IMH 100, IMH 100-S, OMS 100, OMH 100, OMH 100-S, OGS 100, OGH 100 and OGH 100-S with a door stop on the right side
50127456	Outer door for Heratherm IGS 180, IMH 180, IMH 180-S, OMS 180, OMH 180, OMH 180-S, OGS 180, OGH 180 and OGH 180-S with a door stop on the right side
50127457	Control panel for Heratherm Incubators and General Protocol ovens
50127461	Electronics compartment for Heratherm Incubators and General Protocol Ovens without fan
50127463	Mainboard cable for Heratherm incubators and heating & drying ovens
50127469	Door switch for the right side of Heratherm incubators and heating & drying ovens
50127470	Door switch for the left side of Heratherm incubators and heating & drying oven
50127477	Temperatur limiter for OMH, OMH-S, OGH, OGH-S
50127480	Door hook catch for Heratherm incubators and heating & drying ovens with a door stop on the right side
50127481	Door hook catch for Heratherm incubators and heating & drying ovens with a door stop on the left side
50127482	Magnetic door hook catch for Heratherm incubators and heating & drying ovens with a door stop on the right side
50127483	Magnetic door hook catch for Heratherm incubators and heating & drying ovens with a door stop on the left side
50127499	Heating coils for Heratherm OGS 60, OGH 60, OGH 60-S at a voltage of 120 V
50127500	Heating coils for Heratherm OGS 60, OGH 60, OGH 60-S at a voltage of 230 V
50127502	Heating coils for Heratherm OGS 100, OGH 100, OGH 100-S at a voltage between 208 and 240 V
50127503	Heating coils for Heratherm OGS 180, OGH 180, OGH 180-S at a voltage between 208 and 240 V
50127504	Heating coils for Heratherm OMS 60, OMH 60, OMH 60-S at a voltage of 120 V
50127509	Kit fan system Heratherm OMS 60, 120 V
50127510	Kit fan system Heratherm OMS 100 and OMS 180, 208-240 V
50127511	Kit fan system Heratherm IMH 60 IMH 60-S, OMH 60 and OMH 60-S, IMH 100, IMH 100-S, IMH 180 and OMH 180-S, 120 V

Material No.	Description
50127512	Kit fan system Heratherm OMH 100, OMH 100-S, IMH 180, IMH 100-S and OMH 180, 208-240 V
50127513	Kit fan system Heratherm OMS 60, 230 V
50127514	Kit fan system Heratherm OMS 100 and OMS 180, 230 V
50127515	Heating coils for Heratherm OMS 60, OMH 60, OMH 60-S at a voltage of 230 V
50127519	Heating coils for Heratherm OMS 100, OMH 100, OMH 100-S, OMS 180, OMH 180, OMH 180-S at a voltage between 208 and 240 V
50127532	Fan impeller OMH / OMH-S D = 180 mm (7.1 inch), H = 28 mm (1.1 inch)
50127544	Door window seal for Heratherm heating and drying ovens
50127555	Kit fan system Heratherm IMH 60 IMH 60-S, OMH 60 and OMH 60-S, IMH 100, IMH 100-S, IMH 180 and OMH 180-S, 230 V
50127556	Kit fan system Heratherm OMH 100, OMH 100-S, IMH 180, IMH 100-S and OMH 180, 230 V
50127557	Mechanical air inlet slider for Heratherm OMS 60 and OGS 60
50127558	Mechanical air inlet slider for Heratherm OMS 100, OGS 100, OMS 180 and OGS 180
50127566	Fresh air filter for OMH, OGH, OMH-S, OGH-S
50127662	Fresh air filter OGH / OGH-S / OMH / OMH-S
50127741	Support stand with castors for Heratherm 60L
50127742	Support stand with castors for Heratherm 100L
50127743	Support stand with castors for Heratherm 180L
50127761	Wire mesh shelf OGS 60 / OGH 60 / OGH 60-S, including 2 shelf supports
50127762	Wire mesh shelf OGS 100 / OGH 100 / OGH 100-S, including 2 shelf supports
50127763	Wire mesh shelf OGS 180 / OGH 180 / OGH 180-S, including 2 shelf supports
50127764	Wire mesh shelf OMS 60/100/180, OMH 60/100/180, OMH 60/100/180-S, including 2 shelf supports
50127767	Sample sensor for OGH 60-S, OGH 100-S, OGH 180-S, OMH 60-S, OMH 100-S, OMH 180-S
50127773	Stainless steel perforated shelf IMH 60 / IMH 60-S / OMH 60 / OMH 60-S/OMS 60/100/180, including 2 shelf supports
50127774	Stainless steel perforated shelf IMH 100 / IMH 100-S / OMH 100 / OMH 100-S/OMS 60/100/180, including 2 shelf supports
50127777	Stainless steel perforated shelf IMH 180 / IMH 180-S / OMH 180 / OMH 180-S/OMS 60/100/180, including 2 shelf supports

Spare Parts and Accessories

Material No.	Description
50127861	Retaining spring for Heratherm incubators and ovens
50127862	Support rail for Heratherm IGS 60, IMH 60, IMH 60-S, OMS 60, OMH 60, OMH 60-S
50127863	Support rail for Heratherm IGS 100, IMH 100, IMH 100-S, OMS 100, OMH 100, OMH 100-S
50127864	Support rail for Heratherm IGS 180, IMH 180, IMH 180-S, OMS 180, OMH 180, OMH 180-S
50127914	Stainless steel perforated shelf for OGS 60 / OGH 60 / OGH 60-S, including 2 shelf supports
50127925	Stainless steel perforated shelf for OGS 100 / OGH 100 / OGH 100-S, including 2 shelf supports
50127926	Stainless steel perforated shelf for OGS 180 / OGH 180 / OGH 180-S, including 2 shelf supports
50128184	Sample sensor connection for Heratherm incubators and heating & drying ovens
50128186	Kit window bulbs Heratherm heating & drying ovens
50128237	Kit Key for door handle with lock Heratherm
50128880	Reinforced wire mesh shelf OGS 180 / OGH 180 / OGH 180-S
50128881	Reinforced wire mesh shelf OMS 180 / OMH 180 / OMH 180-S
50128887	Kit hot air flexible tube for Heratherm built-in units
50130347	Fibre glass pads Ø 20 mm (0.8 inch)
50130348	Fibre glass pads Ø 50 mm (2 inch)
50130657	Kit Viton door seal 60 L Heratherm
50130658	Kit Viton door seal 100 L Heratherm
50130659	Kit Viton door seal 180 L Heratherm
50134094	Kit heating coil OGS 750, 230 V
50134115	Kit heating coil OGS 400, 750, 230 V
50134118	Kit heating coil OMH 750, 230 V
50134119	Kit heating coil OMH 750, 3 Ph,N
50134124	Kit heating coil OGS 750, 3 Ph
50134125	Kit heating coil OGS 750, 3 Ph
50134315	Kit DS bus cable cpl 400 / 750
50134326	Door gasket 400 L HTM
50134327	Door gasket 750 L HTM
50134328	Kit profile gasket 750 L HTM
50134329	Kit door conn. clips 400 / 750 HTM
50134333	Kit castors 400 / 750 HTM

Material No.	Description
50134334	Kit shelf rack set cpl HTM 400 / 750
50135043	Kit electric insert cpl HTM H floorstand
50135044	Kit electric insert cpl HTM S floorstand
50135055	Kit electric insert cpl HTM 3 PH floor
50135058	Kit door lock 750 left cpl HTM
50135059	Kit door lock 750 right cpl HTM
50135060	Door outer casing left HTM 400
50135061	Door outer casing right HTM 400
50135062	Door outer casing left HTM 750
50135063	Door outer casing right HTM 750
50135151	Kit temperature sensor cpl HTM ovens floor
50135152	Kit overtemperature cut-off HTM ovens 350 floor
50135153	Kit door lock 400 right cpl HTM
50135154	Kit door lock 400 left cpl HTM

Contact

Overview of Thermo Fisher International Sales Organization

Postal address in Germany

Thermo Electron LED GmbH
Robert-Bosch-Straße 1
D - 63505 Langenselbold

Enquiries from Germany:

Phone

Sales 0800 1 536376

Service 0800 1 112110

Fax

Sales/Service 0800 1 112114

Email info.labequipment.de@thermofisher.com

Enquiries from Europe, Middle East and Africa:

Phone. + 49 (0) 6184 / 90-6940

Fax + 49 (0) 6184 / 90-6772

E-Mail info.labequipment.de@thermofisher.com

Postal address USA:

Thermo Scientific
275 Aiken Road
Asheville, NC 28804
USA

Enquiries from North America:

Phone +1 800-879 7767

Fax +1 828-658 0363

Email info.labequipment@thermofisher.com

Enquiries from Latin America:

Phone +1 828-658 2711

Fax +1 828-645 9466

Email info.labequipment@thermofisher.com

Enquiries from Asia Pacific:

Phone +852-2711 3910

Fax +852-2711 3858

Email iinfo.labequipment@thermofisher.com

Thermo Fisher Scientific, Inc.
81 Wyman Street
P.O. Box 9046
Waltham, MA 02454-9046
United States

www.thermo.com