



Thermo Scientific TX-1000 Rotor

for Thermo Scientific General Purpose Centrifuges

Instruction Manual

50142047-b • 07 / 2020

Health Protection Agency
Microbiology Services
Porton Down
Salisbury
Wiltshire
SP4 0JG



Certificate of Containment Testing

Containment Testing of Thermo Scientific TX-1000 Rotor in a Thermo Scientific Centrifuge

Report No. 170-12 G1

Report Prepared For: Thermo Fisher Scientific
Issue Date: 10th October 2012 re-issued 21st August 2013

Test Summary

Thermo Scientific TX-1000 Rotor is identical to the rotor tested according to report 170-12 G. We consider that this rotor will match the performance of that previously containment tested in a Thermo Scientific centrifuge at 5,500 rpm, using Annex AA of IEC 61010-2-020:2006 (2nd Ed.). The sealed rotor was shown to contain all contents.

Report Written By  Name: Ms Anna Moy Title: Biosafety Scientist	Report Authorised By  Name: Mr Simon Parks Title: Senior Biosafety Scientist
--	--

Table of Contents

Preface	5
Scope of Supply	5
Intended Use	5
Symbols used in the Manual	5
Precautions	6
1. Rotor Specifications	7
1. 1. General Purpose Centrifuges	7
1. 2. Sorvall General Purpose Centrifuge	9
1. 3. Thermo Scientific General Purpose Centrifuges	12
2. Thermo Scientific Auto-Lock Rotor Exchange	15
2. 1. Rotor installation	15
2. 2. Removing the Rotor	16
3. Rotor Loading	17
3. 1. Before a Run	17
3. 2. Proper Loading	17
3. 3. Improper Loading	17
3. 4. Maximum Loading	17
3. 5. Lifetime	18
4. Aerosol-tight Applications	19
4. 1. Basic Principles	19
4. 2. Fill Level	19
4. 3. Checking the Aerosol-Tightness	19
5. Maintenance and Care	21
5. 1. Cleaning Intervals	21
5. 2. Cleaning	22
5. 3. Disinfection	24
5. 4. Decontamination	25
5. 5. Autoclaving	26
5. 6. Service of Thermo Fisher Scientific	26
6. RCF-Values	27
7. Rotor Care Guide	29
7. 1. Routine Evaluation and Care of Your Rotor	29
7. 2. Stress Corrosion	29
7. 3. Missing Paint and Anodization	30
7. 4. Dropped Rotors	30

7.5.	Overheating	30
7.6.	Rotor Maintenance	30
7.7.	Maintenance and Care	32
7.8.	Storage	32
7.9.	Decontamination	32

8. Chemical Compatibility Chart33

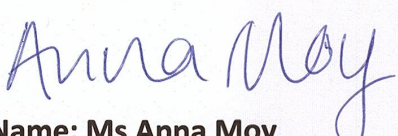
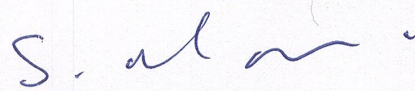
Preface

Before starting to use the rotor, read through this instruction manual carefully and follow the instructions.

The information contained in this instruction manual is the property of Thermo Fisher Scientific; it is forbidden to copy or pass on this information without explicit approval.

Failure to follow the instructions and safety information in this instruction manual will result in the expiration of the sellers warranty.

Scope of Supply

Article Number	Article	Quantity	Check
75003000	TX-1000 Rotor	1	<input type="checkbox"/>
75003789	Lubricant for metal parts	1	<input type="checkbox"/>
50136234	CD with Manual	1	<input type="checkbox"/>

If any parts are missing, please contact your nearest Thermo Fisher Scientific representative.

Intended Use

This rotor is used in combination with the according centrifuge as a laboratory product designed to separate components by generation of Relative Centrifugal Force. It separates human samples (e.g. blood, urine and other body fluids) collected in appropriate containers, either alone or after addition of reagents or other additives.

The rotor in the centrifuge is designed to run other containers filled with chemicals, environmental samples and other non-human body samples.

If the rotor is used in a manner not specified by the manufacturer, the protection provided by the equipment may be impaired.

This rotor should be operated by trained specialists only.

Symbols used in the Manual



This symbol refers to general hazards.
CAUTION means that material damage could occur.
WARNING means that injuries or material damage or contamination could occur.



This symbol refers to biological hazards.
Observe the information contained in the instruction manual to keep yourself and your environment safe.



This symbol means that the rotor and centrifuge manual contain additional important information.
Observe the information contained in the instruction manual to keep yourself and your environment safe.

Precautions

WARNING

In order to ensure safe operation of the Thermo Scientific™ TX-1000 rotor, the following general safety regulations must be followed:

- Do not remove the magnet at the rotor bottom.
- Do not use rotors which show any signs of corrosion and/or cracks.
- Use only with rotors which have been loaded properly.
- Never overload the rotor.
- Use only accessories which have been approved by Thermo Fisher Scientific. Exceptions to this rule are commercially available glass or plastic centrifuge tubes, provided they have been approved for the speed or the RCF value of the rotor.
- Please observe the safety instructions.

Please pay particular attention to the following aspects:

- The rotor may be carried by the handle.
- Rotor installation: Check that the rotor is locked properly into place before operating the centrifuge.
- Always balance the samples. Maximum sample density at maximum speed: $1.2 \frac{g}{cm^3}$

1. Rotor Specifications

1.1. General Purpose Centrifuges

230 V, 50 / 60 Hz, ventilated

Centrifuge	Multifuge X3	Multifuge X3F	Megafuge 40
Weight of Empty Rotor	4.92 kg	4.92 kg	4.92 kg
Max. Cycle Number	55000	55000	55000
Maximum Permissible Load	4 x 1500 g	4 x 1500 g	4 x 1500 g
Maximum Speed n_{\max}	3800 Rpm	3800 Rpm	3800 Rpm
Maximum RCF-Value at n_{\max}	3374	3374	3374
K-Factor	11567	11567	11567
Radius max. / min.	20.9 cm / 10.8 cm	20.9 cm / 10.8 cm	20.9 cm / 10.8 cm
Angle	90°	90°	90°
Accel. / Braking Time	147 s / 85 s	147 s / 85 s	147 s / 85 s
Sample Heating at n_{\max} (Ambient Temperature of 23 °C, Run Time 90 min)	7 °C	7 °C	7 °C
Aerosol-tight (Tested and approved by HPA, Porton-Down, UK)	Yes	Yes	Yes
Maximum Autoclave Temperature	121 °C	121 °C	121 °C

230 V, 50 / 60 Hz, refrigerated

Centrifuge	Multifuge X3R	Multifuge X3FR	Megafuge 40R
Weight of Empty Rotor	4.92 kg	4.92 kg	4.92 kg
Max. Cycle Number	55000	55000	55000
Maximum Permissible Load	4 x 1500 g	4 x 1500 g	4 x 1500 g
Maximum Speed n_{\max}	4200 Rpm	4200 Rpm	4200 Rpm
Maximum RCF-Value at n_{\max}	4122	4122	4122
K-Factor	9469	9469	9469
Radius max. / min.	20.9 cm / 10.8 cm	20.9 cm / 10.8 cm	20.9 cm / 10.8 cm
Angle	90°	90°	90°
Accel. / Braking Time	96 s / 94 s	96 s / 94 s	96 s / 94 s
Maximum Speed at 4 °C	4200 Rpm	4200 Rpm	4200 Rpm
Sample Heating at n_{\max} (Ambient Temperature of 23 °C, Run Time 90 min)	< 0 °C	< 0 °C	< 0 °C
Aerosol-tight (Tested and approved by HPA, Porton-Down, UK)	Yes	Yes	Yes
Maximum Autoclave Temperature	121 °C	121 °C	121 °C

120 V, 60 Hz, ventilated

Centrifuge	Multifuge X3	Multifuge X3F	Megafuge 40
Weight of Empty Rotor	4.92 kg	4.92 kg	4.92 kg
Max. Cycle Number	55000	55000	55000
Maximum Permissible Load	4 x 1500 g	4 x 1500 g	4 x 1500 g
Maximum Speed n_{max}	3800 Rpm	3800 Rpm	3800 Rpm
Maximum RCF-Value at n_{max}	3374	3374	3374
K-Factor	11567	11567	11567
Radius max. / min.	20.9 cm / 10.8 cm	20.9 cm / 10.8 cm	20.9 cm / 10.8 cm
Angle	90°	90°	90°
Accel. / Braking Time	75 s / 60 s	75 s / 60 s	75 s / 60 s
Sample Heating at n_{max} <small>(Ambient Temperature of 23 °C, Run Time 90 min)</small>	7 °C	7 °C	7 °C
Aerosol-tight (Tested and approved by HPA, Porton-Down, UK)	Yes	Yes	Yes
Maximum Autoclave Temperature	121 °C	121 °C	121 °C

120 V, 60 Hz, refrigerated

Centrifuge	Multifuge X3R	Multifuge X3FR	Megafuge 40R
Weight of Empty Rotor	4.92 kg	4.92 kg	4.92 kg
Max. Cycle Number	55000	55000	55000
Maximum Permissible Load	4 x 1500 g	4 x 1500 g	4 x 1500 g
Maximum Speed n_{max}	4200 Rpm	4200 Rpm	4200 Rpm
Maximum RCF-Value at n_{max}	4122	4122	4122
K-Factor	9469	9469	9469
Radius max. / min.	20.9 cm / 10.8 cm	20.9 cm / 10.8 cm	20.9 cm / 10.8 cm
Angle	90°	90°	90°
Accel. / Braking Time	70 s / 60 s	70 s / 60 s	70 s / 60 s
Maximum Speed at 4 °C	3900 Rpm	3900 Rpm	3900 Rpm
Sample Heating at n_{max} <small>(Ambient Temperature of 23 °C, Run Time 90 min)</small>	8 °C	8 °C	8 °C
Aerosol-tight (Tested and approved by HPA, Porton-Down, UK)	Yes	Yes	Yes
Maximum Autoclave Temperature	121 °C	121 °C	121 °C

1.2. Sorvall General Purpose Centrifuge

230 V, 50 / 60 Hz, ventilated

Centrifuge	Legend XT	Legend XF	ST 40
Weight of Empty Rotor	4.92 kg	4.92 kg	4.92 kg
Max. Cycle Number	55000	55000	55000
Maximum Permissible Load	4 x 1500 g	4 x 1500 g	4 x 1500 g
Maximum Speed n_{max}	3800 Rpm	3800 Rpm	3800 Rpm
Maximum RCF-Value at n_{max}	3374	3374	3374
K-Factor	11567	11567	11567
Radius max. / min.	20.9 cm / 10.8 cm	20.9 cm / 10.8 cm	20.9 cm / 10.8 cm
Angle	90°	90°	90°
Accel. / Braking Time	147 s / 85 s	147 s / 85 s	147 s / 85 s
Sample Heating at n_{max} <small>(Ambient Temperature of 23 °C, Run Time 90 min)</small>	7 °C	7 °C	7 °C
Aerosol-tight (Tested and approved by HPA, Porton-Down, UK)	Yes	Yes	Yes
Maximum Autoclave Temperature	121 °C	121 °C	121 °C

230 V, 50 / 60 Hz, refrigerated

Centrifuge	Legend XTR	Legend XFR	ST 40R
Weight of Empty Rotor	4.92 kg	4.92 kg	4.92 kg
Max. Cycle Number	55000	55000	55000
Maximum Permissible Load	4 x 1500 g	4 x 1500 g	4 x 1500 g
Maximum Speed n_{max}	4200 Rpm	4200 Rpm	4200 Rpm
Maximum RCF-Value at n_{max}	4122	4122	4122
K-Factor	9469	9469	9469
Radius max. / min.	20.9 cm / 10.8 cm	20.9 cm / 10.8 cm	20.9 cm / 10.8 cm
Angle	90°	90°	90°
Accel. / Braking Time	96 s / 94 s	96 s / 94 s	96 s / 94 s
Maximum Speed at 4 °C	4200 Rpm	4200 Rpm	4200 Rpm
Sample Heating at n_{max} <small>(Ambient Temperature of 23 °C, Run Time 90 min)</small>	< 0 °C	< 0 °C	< 0 °C
Aerosol-tight (Tested and approved by HPA, Porton-Down, UK)	Yes	Yes	Yes
Maximum Autoclave Temperature	121 °C	121 °C	121 °C

120 V, 60 Hz, ventilated

Centrifuge	Legend XT	Legend XF	ST 40
Weight of Empty Rotor	4.92 kg	4.92 kg	4.92 kg
Max. Cycle Number	55000	55000	55000
Maximum Permissible Load	4 x 1500 g	4 x 1500 g	4 x 1500 g
Maximum Speed n_{max}	3800 Rpm	3800 Rpm	3800 Rpm
Maximum RCF-Value at n_{max}	3374	3374	3374
K-Factor	11567	11567	11567
Radius max. / min.	20.9 cm / 10.8 cm	20.9 cm / 10.8 cm	20.9 cm / 10.8 cm
Angle	90°	90°	90°
Accel. / Braking Time	75 s / 60 s	75 s / 60 s	75 s / 60 s
Sample Heating at n_{max} <small>(Ambient Temperature of 23 °C, Run Time 90 min)</small>	7 °C	7 °C	7 °C
Aerosol-tight (Tested and approved by HPA, Porton-Down, UK)	Yes	Yes	Yes
Maximum Autoclave Temperature	121 °C	121 °C	121 °C

120 V, 60 Hz, refrigerated

Centrifuge	Legend XTR	Legend XFR	ST 40R
Weight of Empty Rotor	4.92 kg	4.92 kg	4.92 kg
Max. Cycle Number	55000	55000	55000
Maximum Permissible Load	4 x 1500 g	4 x 1500 g	4 x 1500 g
Maximum Speed n_{max}	4200 Rpm	4200 Rpm	4200 Rpm
Maximum RCF-Value at n_{max}	4122	4122	4122
K-Factor	9469	9469	9469
Radius max. / min.	20.9 cm / 10.8 cm	20.9 cm / 10.8 cm	20.9 cm / 10.8 cm
Angle	90°	90°	90°
Accel. / Braking Time	70 s / 60 s	70 s / 60 s	70 s / 60 s
Maximum Speed at 4 °C	3900 Rpm	3900 Rpm	3900 Rpm
Sample Heating at n_{max} <small>(Ambient Temperature of 23 °C, Run Time 90 min)</small>	8 °C	8 °C	8 °C
Aerosol-tight (Tested and approved by HPA, Porton-Down, UK)	Yes	Yes	Yes
Maximum Autoclave Temperature	121 °C	121 °C	121 °C

100 V, 50 / 60 Hz, ventilated

Centrifuge	Legend XT	Legend XF	ST 40
Weight of Empty Rotor	4.92 kg	4.92 kg	4.92 kg
Max. Cycle Number	55000	55000	55000
Maximum Permissible Load	4 x 1500 g	4 x 1500 g	4 x 1500 g
Maximum Speed n_{max}	3800 Rpm	3800 Rpm	3800 Rpm
Maximum RCF-Value at n_{max}	3374	3374	3374
K-Factor	11567	11567	11567
Radius max. / min.	20.9 cm / 10.8 cm	20.9 cm / 10.8 cm	20.9 cm / 10.8 cm
Angle	90°	90°	90°
Accel. / Braking Time	75 s / 60 s	75 s / 60 s	75 s / 60 s
Sample Heating at n_{max} <small>(Ambient Temperature of 23 °C, Run Time 90 min)</small>	7 °C	7 °C	7 °C
Aerosol-tight (Tested and approved by HPA, Porton-Down, UK)	Yes	Yes	Yes
Maximum Autoclave Temperature	121 °C	121 °C	121 °C

100 V, 50 / 60 Hz, refrigerated

Centrifuge	Legend XTR	Legend XFR	ST 40R
Weight of Empty Rotor	4.92 kg	4.92 kg	4.92 kg
Max. Cycle Number	55000	55000	55000
Maximum Permissible Load	4 x 1500 g	4 x 1500 g	4 x 1500 g
Maximum Speed n_{max}	4200 Rpm	4200 Rpm	4200 Rpm
Maximum RCF-Value at n_{max}	4122	4122	4122
K-Factor	9469	9469	9469
Radius max. / min.	20.9 cm / 10.8 cm	20.9 cm / 10.8 cm	20.9 cm / 10.8 cm
Angle	90°	90°	90°
Accel. / Braking Time	70 s / 60 s	70 s / 60 s	70 s / 60 s
Maximum Speed at 4 °C	3900 Rpm	3900 Rpm	3900 Rpm
Sample Heating at n_{max} <small>(Ambient Temperature of 23 °C, Run Time 90 min)</small>	8 °C	8 °C	8 °C
Aerosol-tight (Tested and approved by HPA, Porton-Down, UK)	Yes	Yes	Yes
Maximum Autoclave Temperature	121 °C	121 °C	121 °C

1.3. Thermo Scientific General Purpose Centrifuges

230 V, 50 / 60 Hz, ventilated

Centrifuge	SL 40	SL 40 F
Weight of Empty Rotor	4.92 kg	4.92 kg
Max. Cycle Number	55000	55000
Maximum Permissible Load	4 x 1500 g	4 x 1500 g
Maximum Speed n_{\max}	3800 Rpm	3800 Rpm
Maximum RCF-Value at n_{\max}	3374	3374
K-Factor	11567	11567
Radius max. / min.	20.9 cm / 10.8 cm	20.9 cm / 10.8 cm
Angle	90°	90°
Accel. / Braking Time	147 s / 85 s	147 s / 85 s
Sample Heating at n_{\max} (Ambient Temperature of 23 °C, Run Time 90 min)	7 °C	7 °C
Aerosol-tight (Tested and approved by HPA, Porton-Down, UK)	Yes	Yes
Maximum Autoclave Temperature	121 °C	121 °C

230 V, 50 / 60 Hz, refrigerated

Centrifuge	SL 40 R	SL 40 FR
Weight of Empty Rotor	4.92 kg	4.92 kg
Max. Cycle Number	55000	55000
Maximum Permissible Load	4 x 1500 g	4 x 1500 g
Maximum Speed n_{\max}	4200 Rpm	4200 Rpm
Maximum RCF-Value at n_{\max}	4122	4122
K-Factor	9469	9469
Radius max. / min.	20.9 cm / 10.8 cm	20.9 cm / 10.8 cm
Angle	90°	90°
Accel. / Braking Time	96 s / 94 s	96 s / 94 s
Maximum Speed at 4 °C	4200 Rpm	4200 Rpm
Sample Heating at n_{\max} (Ambient Temperature of 23 °C, Run Time 90 min)	< 0 °C	< 0 °C
Aerosol-tight (Tested and approved by HPA, Porton-Down, UK)	Yes	Yes
Maximum Autoclave Temperature	121 °C	121 °C

120 V, 60 Hz, ventilated

Zentrifuge	Multifuge X3	Multifuge X3F
Gewicht (leer)	4.92 kg	4.92 kg
Maximale Zykluszahl	55000	55000
Maximal zulässige Beladung	4 x 1500 g	4 x 1500 g
Maximale Drehzahl n_{\max}	3800 Rpm	3800 Rpm
Maximaler RZB-Wert bei n_{\max}	3374	3374
K-Faktor	11567	11567
Radius max. / min.	20.9 cm / 10.8 cm	20.9 cm / 10.8 cm
Anstellwinkel	90°	90°
Beschleunigungs- / Bremszeit	75 s / 60 s	75 s / 60 s
Probentemperatur bei n_{\max} (Umgebungstemperatur 23 °C, Laufzeit 90 Minuten)	7 °C	7 °C
Aerosoldicht	Yes	Yes
Zulässige Temperatur zum Autoklavieren	121 °C	121 °C

120 V, 60 Hz, refrigerated

Zentrifuge	Multifuge X3	Multifuge X3F
Weight of Empty Rotor	4.92 kg	4.92 kg
Max. Cycle Number	55000	55000
Maximum Permissible Load	4 x 1500 g	4 x 1500 g
Maximum Speed n_{\max}	4200 Rpm	4200 Rpm
Maximum RCF-Value at n_{\max}	4122	4122
K-Factor	9469	9469
Radius max. / min.	20.9 cm / 10.8 cm	20.9 cm / 10.8 cm
Angle	90°	90°
Accel. / Braking Time	70 s / 60 s	70 s / 60 s
Maximum Speed at 4 °C	3900 Rpm	3900 Rpm
Sample Heating at n_{\max} (Ambient Temperature of 23 °C, Run Time 90 min)	8 °C	8 °C
Aerosol-tight (Tested and approved by HPA, Porton-Down, UK)	Yes	Yes
Maximum Autoclave Temperature	121 °C	121 °C

2. Thermo Scientific Auto-Lock Rotor Exchange

2.1. Rotor installation



CAUTION

Unapproved or incorrectly combined accessories can cause serious damage to the centrifuge.

This rotor is equipped with a Thermo Scientific™ Auto-Lock™ rotor exchange.

This system is used to automatically lock the rotor to the centrifuge spindle, eliminating the need to manually bolt the rotor to the centrifuge spindle.

Proceed as follows:

1. Open the door of the centrifuge and if necessary remove any dust, foreign objects or residue from the chamber.

Auto-Lock and O-ring must be clean and undamaged.

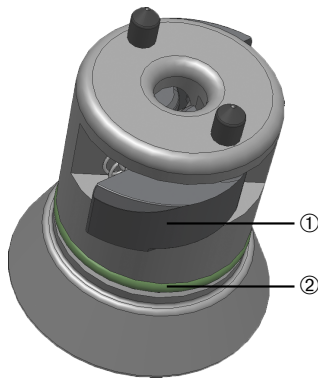

Figure 1 Auto-Lock Adapter

- ① Auto-Lock
- ② O-Ring

2. Place the rotor over the centrifuge spindle and let it slide slowly down the centrifuge spindle.

The rotor clicks automatically into place.

CAUTION Donot force the rotor on to the centrifuge spindle. If the rotor is very light, then it may be necessary to press it on to the centrifugr spindle with a bit of pressure.

3. 3. Check if the rotor is properly installed by lifting it slightly on the handle. If the rotor has not been locked, place the rotor over the centrifuge spindle again.

WARNING If the rotor cannot be properly locked in the place after several attempts, then the Auto-Lock may be damaged and you are not permitted to operate the rotor. Check for any damage to the rotor: Damaged rotors must not be used. Keep the centrifuge spindle area of the rotor clear of the objects. Operate the rotor always with the lid closed.

CAUTION Check the rotor is properly locked on the centrifuge spindle before each use by pulling it at its handle.

CAUTION Be sure to check all sealings before starting any aerosol-tight applications.

4. Close the centrifuge door.

2.2. Removing the Rotor

To remove the rotor, proceed as follows:

1. Open the centrifuge door.
2. Grab the rotor handle with one or both hands and push down on against the Auto-Lock button. At the same time, pull the rotor directly upwards and remove it from the centrifuge spindle. Make sure not to tilt the rotor while doing this.



Figure 2 Removing the Rotor

3. Rotor Loading

3.1. Before a Run

1. Please read and observe the safety instructions contained in these operating instructions and in the instructions for use.
2. Check the rotor and all accessory parts for damages such as cracks, scratches or traces of corrosion.
3. Check the rotor chamber, the centrifuge spindle and the Auto-Lock of the rotor.
4. Check the rotor's suitability using the chemical compatibility chart on [Page 33](#)

3.2. Proper Loading

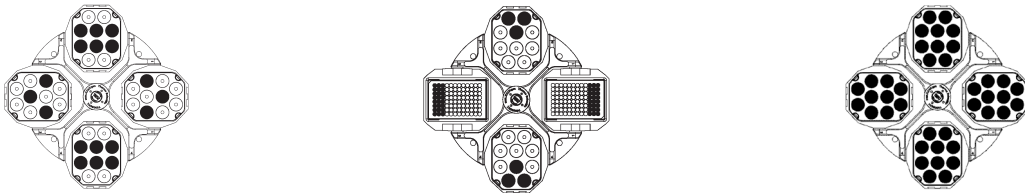

3.3. Improper Loading

	WARNING
<p>Oposing buckets must be equally loaded.</p> <p>The maximum difference between two buckets next to each other is <200g.</p> <p>When you operate only two buckets fill the other two with water.</p>	



3.4. Maximum Loading

The rotor can run at high speeds. The rotor design has sufficient reserve stability even when spinning at top speed.

The safety system of the centrifuge requires that you do not overload the rotor.

There are two options available for centrifuging samples whose weight, including adapter, exceeds the maximum permissible load:

- Reduce the fill level.
- Reduce the speed.

Calculate the maximum speed with this formula and set the centrifuge at the calculated maximum speed:

$$n_{adm} = n_{max} \sqrt{\frac{\text{Maximum permissible Load}}{\text{Effective Load}}}$$

n_{adm} = Permissible Speed

n_{max} = Maximum Speed

3.5. Lifetime



WARNING

Replace the rotor when the specified number of cycles is reached. Due to the mechanical load a rotor can break and thus damage the centrifuge.

The lifetime of rotors and buckets is dependent on the amount of mechanical load. Do not exceed the number of cycles recommended for rotors and buckets.

The maximum number of cycles for the rotor is given in the rotor table in section [Rotor Loading](#) on [Page 8](#).

The maximum number of cycles for buckets is marked on the buckets themselves.

Service Life Examples

Usage profile	Maximum lifetime at 55 000 cycles
25 runs / day, 200 days / year	11 years

Lifetime until coating is worn off depends on speed and load, that means it will be different for every user.

4. Aerosol-tight Applications

4.1. Basic Principles

	CAUTION
Aerosol-tight rotors and tubes may only be opened in an approved safety work-bench when centrifuging dangerous samples. Mind the maximum permissible load.	

	CAUTION
Be sure to check all sealings before starting any aerosol-tight applications.	

Check that the sample containers are well suited for the desired centrifugation process.

4.2. Fill Level

Open top tubes are only to be filled to a level which ensures that the sample is unable to reach the top of the tube during centrifugation.

4.3. Checking the Aerosol-Tightness

The aerosol tightness testing of the rotors and buckets depend on the microbiological test process in accordance with the EN 61010-2-020 Appendix AA.

Whether or not a rotor is aerosol-tight depends primarily on proper handling.

Check as needed to make sure your rotor is aerosol-tight.

The careful inspection of the seals and seal surfaces for signs of wear and damage such as cracks, scratches and embrittlement is extremely important.

Aerosol-tight applications are not possible if the rotor is run without the lid.

Aerosol-tightness requires the correct operation when filling the sample vessels and closing the rotor lid.

Quick Test

As a quick test, it is possible to test the aerosol-tightness using the following process:

1. Lubricate all seals lightly.
Always use the special grease (76003500) when lubricating the seals.
2. Fill the bucket with approx. 10 ml of carbonated mineral water.
3. Close the bucket as explained in the handling instructions.
4. Shake the bucket vigorously using your hands.

This releases the carbonic acid gas which is bound in the water, resulting in excess pressure. Do not apply pressure to the lid when doing so.

Leaks can be detected by escaping water or the sound of escaping gas. Treten Wasser oder Kohlensäure aus, müssen Replace the seals if you detect any leaks. Then repeat the test.

5. Dry the rotor, rotor lid and the cover seal.

	CAUTION
<p>Prior to each use, the seals in the rotor are to be inspected in order to assure that they are correctly seated and are not worn or damaged.</p> <p>Damaged seals are to be replaced immediately.</p> <p>Replacement seals are not supplied with the rotors and can also be re-ordered as a spare part (75007001).</p> <p>When loading the rotor, ensure that the rotor lid closes securely.</p> <p>Damaged or clouded rotor covers are to be replaced immediately.</p>	

Aerosol-tight Closure with ClickSeal

1. If necessary, grease the lid joint before closing the lid. Use grease (76003500) for this.
2. Raise the latch.

The cap can now be easily placed on the bucket.



Figure 1 Bucket with open lid

3. Lower the latch to close the bucket aerosol-tight; be sure the latch clicks into place.



Figure 2 Bucket with closed lid

	CAUTION
<p>If the latch is not flipped down, the caps could be damaged during centrifuging.</p> <p>If the latch has not clicked into place, the bucket is not aerosol-tight.</p> <p>Never raise the bucket at its latch.</p>	

5. Maintenance and Care

5.1. Cleaning Intervals

For the sake of personal, environmental, and material protection, it is your duty to clean and if necessary disinfect the centrifuge on a regular basis.

Maintenance	Recommended interval
Clean rotor chamber	Daily, when soiled, or after using corrosive buffers
Clean rotor	Daily, when soiled, or after using corrosive buffers
Accessories	Daily, when soiled, or after using corrosive buffers
Cabinet	Once per month
Ventilation holes	Every six months



CAUTION

Refrain from using any other cleaning or decontamination procedure than those recommended here, if you are not entirely sure that the intended procedure is safe for the equipment.
Use only approved cleansers.
If in doubt, contact Thermo Fisher Scientific.

Coated rotors

Following procedure is for TX-1000 rotors with Advanced Lubricating and Protective coating. For previous version of black paint rotor please refer to previous version of rotor manual

- Regular cleaning of contact area between the rotor and buckets (rotor cross trunnions and bucket grooves) is recommended with a mild detergent (every 300-500 cycles)
- The rotor cross is coated with a special grey Advanced Lubricating and Protective coating, therefore no grease is necessary.
- Contaminating particles (dirt, dust or debris) in the rotor cross and bucket grooves may lead to imbalance and cleaning will be required
- The lubricating grey coating may over extended period or heavy loads become worn, if this occurs small amount of greasing of the rotor cross trunnions will be required with bolt grease (75003786).

5.2. Cleaning



CAUTION

Bevor ein anderes als das vom Hersteller empfohlene Reinigungs- oder Dekontaminierungsverfahren angewandt wird, sollte sich der Anwender beim Hersteller vergewissern, dass das vorgesehene Verfahren die Materialien nicht schädigt.

Clean rotor and accessories as follows:

- Use warm water with a neutral solvent.
- Never use caustic cleaning agents such as soap suds, phosphoric acid, bleaching solutions or scrubbing powder.
- Rinse the cavities out thoroughly.
- Use a soft brush without metal bristles to remove stubborn residue.
- Afterwards rinse with distilled water.
- Place the rotors on a plastic grate with their cavities pointing down.
- If drying boxes are used, the temperature must never exceed 50 °C, since higher temperatures could damage the material and shorten the lifetime of the parts.
- Use only disinfectants with a pH of 6-8.
- Dry aluminum parts off with a soft cloth.
- After cleaning, treat the entire surface of aluminum parts with corrosion protection oil (70009824). Also treat the cavities with oil.
- Store the aluminum parts at room temperature or in a cold-storage room with the cavities pointing down.

Clean centrifuge and accessories as follows:

1. Open the centrifuge.
2. Turn off the centrifuge.
3. Pull out the power supply plug.
4. Grasp the rotor with both hands and lift it vertically off the centrifuge spindle.
5. Remove the centrifuge tubes and adaptors.
6. Use a neutral cleaning agent with a pH value between 6 and 8 for cleaning.
7. Dry all of the rotors and accessories after cleaning with a cloth or in a warm air cabinet at a maximum temperature of 50 °C.
8. Clean the housing of the centrifuge as needed.

After cleaning, treat the entire surface of aluminum parts with corrosion protection oil (70009824). Also treat the cavities with oil.

Treat the bolt of the swing out rotor with bolt grease (75003786).





CAUTION

When cleaning, do not allow liquids, especially organic solvents, to get on the drive shaft, the bearings, the Auto-Lock or the locks.
Organic solvents break down the grease in the motor bearing. The drive shaft could freeze up.

After some applications there might be ice in the rotor chamber. Let the ice melt and drain it off. Clean the rotor chamber as described above.

5.3. Disinfection

	WARNING
<p>Infectious material can get into the centrifuge when a tube breaks or as a result of spills. Keep in mind the risk of infection when touching the rotor and take all necessary precautions. In case of contamination, make sure that others are not put at risk. Decontaminate the affected parts immediately. Take other precautions if need be.</p>	

	CAUTION
<p>Before using any cleaning or decontamination methods except those recommended by the manufacturer, users should check with the manufacturer that the proposed method will not damage the equipment. Observe the safety precautions and handling instructions for the cleaning agents used.</p>	

Disinfect the centrifuge immediately whenever infectious material has spilled during centrifugation.

Use a sprayer whenever possible so that all surfaces are covered evenly.

The rotor chamber and the rotor should be treated preferably with a neutral disinfectant. A disinfectant spray would be most suitable for this purpose so that the rotor and accessory surfaces are covered evenly.

Contact the Service Department of Thermo Fisher Scientific for questions regarding the use of other disinfectants.

Disinfect the rotor and accessories as follows:

1. Open the centrifuge.
2. Turn off the centrifuge.
3. Pull out the power supply plug.
4. Grasp the rotor with both hands and lift it vertically off the centrifuge spindle.
5. Remove the centrifuge tubes and adaptors and dispose of them or disinfect them.
6. Treat the rotor and accessories according to the instructions for the disinfectant (spray or soak in solution). Adhere strictly to the given application times.
7. Be sure the disinfectant can drain off the rotor.
8. Rinse the rotor and rotor lid thoroughly with water and then rub down.
9. Dispose of the disinfectant according to the applicable guidelines.
10. Dry all of the rotors and accessories after cleaning with a cloth or in a warm air cabinet at a maximum temperature of 50 °C.

After cleaning, treat the entire surface of aluminum parts with corrosion protection oil (70009824). Also treat the cavities with oil.

Tread the bolt of the swing out rotor with bolt grease (75003786).

5.4. Decontamination

	WARNING
<p>Radioactive material can get into the centrifuge when a tube breaks or as a result of spills. Keep in mind the risk of infection when touching the rotor and take all necessary precautions. In case of contamination, make sure that others are not put at risk. Decontaminate the affected parts immediately. Take other precautions if need be.</p>	

	CAUTION
<p>Before using any cleaning or decontamination methods except those recommended by the manufacturer, users should check with the manufacturer that the proposed method will not damage the equipment.</p>	

Decontaminate the centrifuge immediately whenever radioactive material has spilled during centrifugation.

For general radioactive decontamination use a solution of equal parts of 70 % ethanol, 10 % SDS and water.

Disinfect the rotor and accessories as follows:

1. Open the centrifuge.
2. Turn off the centrifuge.
3. Pull out the power supply plug.
4. Grasp the rotor with both hands and lift it vertically off the centrifuge spindle.
5. Remove the centrifuge tubes and adaptors and dispose of them or disinfect them.
6. Rinse the rotor first with ethanol and then with de-ionized water.
Adhere strictly to the given application times.
7. Be sure the decontamination solution can drain off the rotor.
8. Rinse the rotor and accessories thoroughly with water.
9. Dispose of the decontamination solution according to the applicable guidelines.
10. Dry all of the rotors and accessories after cleaning with a cloth or in a warm air cabinet at a maximum temperature of 50 °C.
11. After cleaning, treat the entire surface of aluminum parts with corrosion protection oil (70009824). Also treat the cavities with oil.
12. Treat the bolt of the swing out rotor with bolt grease (75003786).

5.5. Autoclaving

1. Before autoclaving clean rotor and accessories and described above.
2. Place the rotor on a flat surface. Rotor und Adapter sind bei 121 °C autoklavierbar.
 - Rotors and adapter can be autoclaved at 121 °C.
 - The maximum permissible autoclave cycle is 20 minutes at 121 °C.

Clean the rotor before autoclaving and rinse it with distilled water. Remove all accessories (tubes, adapters) from the rotor.

Place the rotor on a flat surface..

NOTE

No chemical additives are permitted in the steam.



CAUTION

Never exceed the permitted temperature and duration when autoclaving. If the rotor shows signs of corrosion or wear, it must be replaced.

5.6. Service of Thermo Fisher Scientific

Thermo Fisher Scientific recommends having the centrifuge and accessories serviced once a year by an authorized service technician. The service technicians check the following:

- the electrical equipment
- the suitability of the set-up site
- the door lock and the safety system
- the rotor
- the fixation of the rotor and the drive shaft

Thermo Fisher Scientific offers inspection and service contracts for this work.

Shipping and Deposing of Centrifuge and Accessories

Contact the Thermo Scientific customer service before returning anything. You will receive a RMA (Returned Material Authorization) that must be used for the shipping. When you have questions regarding the deposing the customer service will help you as well.



WARNING

Before shipping or deposing centrifuges and accessories you have to clean and if necessary disinfect or decontaminate everything. Before storing the centrifuge and the accessories it must be cleaned and if necessary disinfected and decontaminated.

6. RCF-Values

Speed (rpm)	R _{min}	R _{max}	RCF R _{min}	RCF R _{max}
300	108	209	11	21
400	108	209	19	37
500	108	209	30	58
600	108	209	43	84
700	108	209	59	114
800	108	209	77	150
900	108	209	98	189
1000	108	209	121	234
1100	108	209	146	283
1200	108	209	174	336
1300	108	209	204	395
1400	108	209	237	458
1500	108	209	272	526
1600	108	209	309	598
1700	108	209	349	675
1800	108	209	391	757
1900	108	209	436	844
2000	108	209	483	935
2100	108	209	532	1030
2200	108	209	584	1131
2300	108	209	639	1236
2400	108	209	695	1346
2500	108	209	755	1460
2600	108	209	816	1580
2700	108	209	880	1703
2800	108	209	947	1832
2900	108	209	1015	1965
3000	108	209	1087	2103
3100	108	209	1160	2245
3200	108	209	1236	2393
3300	108	209	1315	2545
3400	108	209	1396	2701
3500	108	209	1479	2862
3600	108	209	1565	3028
3700	108	209	1653	3199
3800	108	209	1744	3374
3900	108	209	1837	3554
4000	108	209	1932	3739
4100	108	209	2030	3928
4200	108	209	2130	4122

7. Rotor Care Guide

Each time you use a rotor, visually inspect its condition for signs of physical wear or damage:

- Corrosion in the rotor cavities or exterior surfaces.
- Scratches or gouges to the base metal.
- Missing or worn anodizing.
- Damage to contact points, such as thread, hubs and screws.

Over time, stress observed in a typical fixed angle rotor will cause metal fatigue.

Heavy corrosion can result in premature rotor failure.

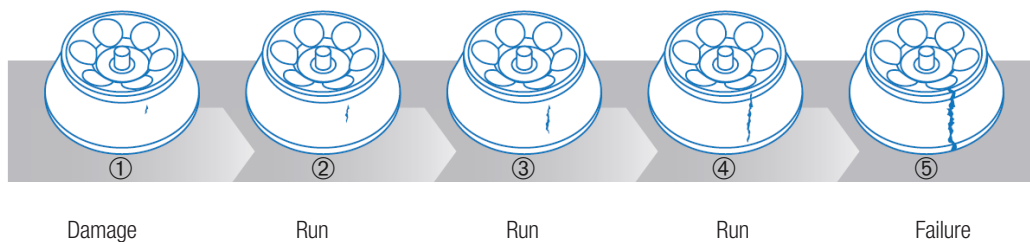

7.1. Routine Evaluation and Care of Your Rotor

Rotors are frequently damaged in use and this damage may be exacerbated under centrifugal forces. As a result, even a tiny flaw in a critical part of the rotor may generate stresses greater than the rotor was designed to withstand. Rotors are also subject to high levels of stress due to the centrifugal force created by high rotational speeds, and repeated cycles can cause metal rotors to stretch and change in size.

The following chart shows the useful lifetime of the rotor in reliance to the loading (kg) and cycles it runs. The different colors show, when the coating is worn off regarding to the speed (rpm) the rotor runs.

Proper Handling

Improper installation can lead to failure so it is imperative to:

- Always lock rotors to the spindle, if applicable.
- Ensure buckets are properly seated on their pins.
- Always use the tightening tool for locking and closing the rotor, if applicable.
- Use the proper rotor extractor tool to remove a rotor, if applicable.
- Avoid dropping or striking the rotor against a hard surface.
- Avoid putting anything inside the rotor that could scratch or nick the surface.

In addition, ensure that all tubes, bottles and adapters are being used within their specified limits and according to the manufacturer's directions. Tube or bottle failures during centrifugation can result in minor to severe damage to rotors and centrifuges.

7.2. Stress Corrosion

Stress distribution is an important consideration when evaluating the extent of rotor damage. Ultraspeed rotors experience the highest level of stress of all rotors; if it is run above its rated speed, it probably has exceeded its yield point. In this event, the

metal is permanently deformed and rotor life is severely compromised. Lower speed metal rotors will also become fatigued, depending on the rotor type, number of runs and the speed of those runs. However, corrosion, improper handling and misuse will often require that you retire your rotor long before normal fatigue becomes a danger.

7.3. Missing Paint and Anodization

While missing paint will not affect the life of a titanium or carbon fiber rotor, missing anodization on an aluminum rotor may signal that it is time to retire the rotor.

7.4. Dropped Rotors

Deformation caused by dropping a metal rotor cannot be repaired, requiring that the rotor be replaced. In some cases, carbon fiber rotors are repairable if damaged.

7.5. Overheating

Melted bottles or other plastic or a rotor that is too hot to touch are indications that a rotor has overheated. Aluminum and carbon fiber rotors can be autoclaved up to 121 °C, while titanium and stainless steel rotors can withstand higher temperatures and are not likely to be damaged by heat generated in the centrifuge.

7.6. Rotor Maintenance

Protect your rotor against damage or failure with preventive measures and maintain maximum centrifuge performance. However, if rotor damage is observed, ensure the safety of your lab by taking recommended action or contacting your sales representative for an inspection.

Potential Damage	Preventive Measures	Recommended Action
Damage to lid assembly	Lubricate periodically with a light film of o-ring or vacuum grease. Keep lid assembly lubricated with galling grease Avoid banging or dropping Use care when removing o-rings. Clean with non-abrasive cloth and mild detergent.	Return lid assembly parts to manufacturer for repair or replacement.
Damage to biocontainment sealing lid	Use care when removing o-rings. Inspect and replace o-rings regularly.	Replace sealing lid to ensure proper containment
Scoring to the bottom of the rotor (outside of cone area)	Gently place rotor on the centrifuge spindle. Clean with non-abrasive cloth and mild detergent. Inspect centrifuge mated parts for burrs and ensure no debris in centrifuge chamber. Store rotor on rotor stand or soft surface.	Return rotor to manufacturer for evaluation or replacement.

Potential Damage	Preventive Measures	Recommended Action
Damage to the rotor drive pins	Gently place rotor on the centrifuge spindle. Ensure rotor is securely locked to centrifuge drive.	Return rotor to manufacturer for replacement of rotor hub adapter or replace rotor depending on degree of damage/corrosion.
Pitting from corrosion in the bottom of tube cavity (metal rotors)	Ensure rotor is dried thoroughly between runs. Clean rotor immediately after use and when exposed to chemicals with approved solvent. Remove adapters after use, rinse and dry.	Return rotor to manufacturer for evaluation.
Cracked or de-laminated rotor	Avoid sharp impact. Avoid harsh chemicals Clean the surface of rotor and coat with a thin layer of oil to prevent corrosion.	Return rotor to manufacturer for evaluation.
Damage to rotor tie-down threads	Avoid cross threading of parts. Never use metallic or abrasive objects to clean. Clean and lubricate regularly.	Replace rotor tie-down assembly.
Damage to bucket seats	Lubricate buckets regularly. Slide buckets into place carefully to avoid dropping or forcing into position.	Replace rotor bucket set.
Windshield damage	Avoid banging or dropping. Do not exceed rotor's maximum compartment mass. Ensure windshield area is free of debris.	Replace rotor to avoid vibration that will wear the drive.
Rotor bucket cap damage	Avoid cross threading of parts. Never use metallic objects to clean. Clean and lubricate regularly.	Replace rotor bucket caps and return set for rebalancing (if applicable).
Rotor bucket damage	Avoid banging or dropping Do not exceed rotor's maximum compartment mass. Ensure buckets are free of debris.	Replace rotor buckets or return bucket set for rebalancing.
Gouges or corrosion on surface of rotor	Inspect before every use.	Return rotor to manufacturer for evaluation or replacement.
Septa damage in continuous flow or zonal rotor	Avoid sharp impact. Avoid harsh chemicals Clean the surface of rotor and coat with a thin layer of oil to prevent corrosion.	Return rotor to manufacturer for evaluation.
Light scratches on surface	Avoid banging or dropping. Never use metallic objects to remove debris.	Monitor to ensure no corrosion has occurred.
Bent centrifuge spindle	Remove rotor in a straight up motion. Ensure samples are properly balanced	Call service for replacement of centrifuge spindle

Corrosion, pitting and even minor surface imperfections affect metal rotor life by increasing stress and, as a result, make it difficult to predict at what point the rotor material could fail.

7.7. Maintenance and Care

- Clean rotors, lids, adapters and any associated parts with a neutral cleaning agent with a pH value between 6 and 8. Rinse with distilled water and dry thoroughly with a soft cloth.
- Do not use strong alkaline laboratory detergent on aluminum rotors; if encrusted material is present, remove it with a soft, twisted-bristle brush and the 1 % non-alkaline soap solution.
- For benchtop, lowspeed and superspeed swinging bucket rotors, keep the bucket trunnion pins clean. Lubricate non-coated trunnion pins. Coated pins do not need to be lubricated.
Cleaning is recommended every 300-500 cycles.
Lubrication on trunnion pins is needed when the coating is worn off. When it is worn off, first start cleaning the bucket groove and trunnion pins. Remove any abraded particles.
- Lubricate o-rings with vacuum grease and metal rotor threads with anti-galling grease (75003786) weekly, when specified in rotor manual.
- Apply an additional coating of anti-corrosion oil (70009824) to prolong the life of an anodized coating.
- Refer to the Maintenance and Care chapter in this rotor manual.

NOTE

If an imbalance error occurs: clean bucket groove and trunnion pins. Remove any abraded particles.

7.8. Storage

Any moisture left on a metal rotor can initiate corrosion, so after cleaning ensure proper storage:

- Remove all adapters from rotor cavities when not in use.
- Dry and store upside-down. Use a PTFE-coated or plastic matting to allow for airflow or a ventilated shelf to avoid gathering condensation in the cavity or bucket bottom.

7.9. Decontamination

Given the nature of samples processed in a rotor, biological or radioactive contamination is possible. For biological contamination of rotors, a 2 % glutaraldehyde solution, ethylene oxide or ultraviolet radiation are the recommended methods of sterilization, While for a rotor that may be contaminated by a radioactive sample, use a solution of equal parts of 70 % ethanol, 10 % SDS and water. In addition:

- Do not use chlorine bleach on aluminum rotors.
- When autoclaving, rotor components should be separated.
- If sterilization is not necessary, a 70 % solution of ethanol can be used.
- Most commercially available detergents for radioisotopic contamination are not compatible with aluminum or anodized coatings and shall not be used.
- Rinse with ethanol, followed by water and dry with a soft cloth.
- Do not immerse Thermo Scientific Fiberlite rotors; spin rotor to remove liquid.
- Fiberlite composite rotors are not compatible with ethylene oxide.

8. Chemical Compatibility Chart

CHEMICAL	MATERIAL																										
	ALUMINUM	ANODIC COATING FOR ALUMINIUM	BUNA N	CELLULOSE ACETATE BUTYRATE	POLYURETHANE ROTOR PAINT	COMPOSITE CARBON FIBER/EROXY	DELFRIN™	ETHYLENE PROPYLENE	GLASS	NEOPRENE	NOVEL™	NYLON	PET™, POLYCLEAR™, CLEARGRIP™	POLYALLOMER	POLYCARBONATE	POYESTER, GLASS THERMOSET	POLYETHERIMIDE	POLYETHYLENE	POLYPROPYLENE	POLYSILOXONE	POLYVINYL CHLORIDE	RULON A™, TEFLON™	SILICONRUBBER	STAINLESS STEEL	TITANIUM	Tygon™	Viton™
2-Mercaptoethanol	S	S	U	-	S	M	S	-	S	U	S	S	U	S	S	-	S	S	S	S	U	S	S	S	S	S	S
Acetaldehyde	S	-	U	U	-	-	-	M	-	U	-	-	-	M	U	U	U	M	M	-	M	S	U	-	S	-	U
Acetone	M	S	U	U	S	U	M	S	U	U	S	U	S	U	U	U	S	S	U	U	S	M	M	S	U	U	
Acetonitrile	S	S	U	-	S	M	S	-	S	U	S	U	S	M	U	U	-	S	M	U	U	S	S	S	S	U	U
Alconox™	U	U	S	-	S	S	S	-	S	S	S	S	S	M	S	S	S	S	S	S	S	S	S	S	S	S	U
Allyl Alcohol	-	-	-	U	-	-	S	-	-	-	-	S	-	S	S	M	S	S	S	-	M	S	-	-	S	-	-
Aluminum Chloride	U	U	S	S	S	S	U	S	S	S	S	M	S	S	S	S	-	S	S	S	S	S	M	U	U	S	S
Formic Acid (100 %)	-	S	M	U	-	-	U	-	-	-	-	U	-	S	M	U	U	S	S	-	U	S	-	U	S	-	U
Ammonium Acetate	S	S	U	-	S	S	S	-	S	S	S	S	S	S	U	-	S	S	S	S	S	S	S	S	S	S	S
Ammonium Carbonate	M	S	U	S	S	S	S	S	S	S	S	S	S	S	U	U	-	S	S	S	S	S	M	S	S	S	S
Ammonium Hydroxide (10 %)	U	U	S	U	S	S	M	S	S	S	S	S	-	S	U	M	S	S	S	S	S	S	S	S	S	M	S
Ammonium Hydroxide (28 %)	U	U	S	U	S	U	M	S	S	S	S	S	U	S	U	M	S	S	S	S	S	S	S	S	S	M	S
Ammonium Hydroxide (conc.)	U	U	U	U	S	U	M	S	-	S	-	S	U	S	U	S	S	S	-	M	S	S	S	S	-	U	
Ammonium Phosphate	U	-	S	-	S	S	S	S	S	S	S	S	-	S	S	M	-	S	S	S	S	S	M	S	S	S	S
Ammonium Sulfate	U	M	S	-	S	S	U	S	S	S	S	S	S	S	S	-	S	S	S	S	S	S	U	S	S	U	
Amyl Alcohol	S	-	M	U	-	-	S	S	-	M	-	S	-	M	S	S	S	S	M	-	-	-	U	-	S	-	M
Aniline	S	S	U	U	S	U	S	M	S	U	U	U	U	U	U	-	S	M	U	U	U	S	S	S	U	S	
Sodium Hydroxide (<1 %)	U	-	M	S	S	S	-	-	S	M	S	S	-	S	M	M	S	S	S	S	S	S	M	S	S	-	U
Sodium Hydroxide (10 %)	U	-	M	U	-	-	U	-	M	M	S	S	U	S	U	U	S	S	S	S	S	S	M	S	S	-	U
Barium Salts	M	U	S	-	S	S	S	S	S	S	S	S	S	S	M	-	S	S	S	S	S	S	M	S	S	S	S
Benzene	S	S	U	U	S	U	M	U	S	U	U	S	U	U	U	M	U	M	U	U	U	S	U	U	S	U	S
Benzyl Alcohol	S	-	U	U	-	-	M	M	-	M	-	S	U	U	U	U	U	U	-	M	S	M	-	S	-	S	
Boric Acid	U	S	S	M	S	S	U	S	S	S	S	S	S	S	S	S	U	S	S	S	S	S	S	S	S	S	S
Cesium Acetate	M	-	S	-	S	S	S	-	S	S	S	S	-	S	S	-	-	S	S	S	S	S	M	S	S	S	S
Cesium Bromide	M	S	S	-	S	S	S	-	S	S	S	S	S	S	-	-	S	S	S	S	S	S	M	S	S	S	S
Cesium Chloride	M	S	S	U	S	S	S	-	S	S	S	S	S	S	-	-	S	S	S	S	S	S	M	S	S	S	S
Cesium Formate	M	S	S	-	S	S	S	-	S	S	S	S	S	S	-	-	S	S	S	S	S	S	M	S	S	S	S
Cesium Iodide	M	S	S	-	S	S	S	-	S	S	S	S	S	S	-	-	S	S	S	S	S	S	M	S	S	S	S
Cesium Sulfate	M	S	S	-	S	S	S	-	S	S	S	S	S	S	-	-	S	S	S	S	S	S	M	S	S	S	S
Chloroform	U	U	U	U	S	S	M	U	S	U	U	M	U	M	U	U	U	M	M	U	U	S	U	U	M	S	S
Chromic Acid (10 %)	U	-	U	U	S	U	U	-	S	S	S	U	S	S	M	U	M	S	S	U	M	S	M	U	S	S	S
Chromic Acid (50 %)	U	-	U	U	-	U	U	-	-	S	U	U	S	M	U	M	S	S	U	M	S	-	U	M	-	S	
Cresol Mixture	S	S	U	-	-	-	S	-	S	U	U	U	U	U	-	-	U	U	-	U	S	S	S	S	U	S	
Cyclohexane	S	S	S	-	S	S	S	U	S	U	S	S	U	U	M	S	M	U	M	M	S	U	M	M	U	S	S
Deoxycholate	S	S	S	-	S	S	S	-	S	S	S	S	U	S	S	S	-	-	S	S	S	S	S	S	S	S	S
Distilled Water	S	S	S	S	S	S	S	S	S	S	S	S	S	S	S	S	S	S	S	S	S	S	S	S	S	S	S
Dextran	M	S	S	S	S	S	S	-	S	S	S	S	S	S	S	S	S	S	S	S	S	S	M	S	S	S	S
Diethyl Ether	S	S	U	U	S	S	S	U	S	U	U	S	U	U	U	U	U	U	U	U	U	S	S	S	S	M	U
Diethyl Ketone	S	-	U	U	-	-	M	-	S	U	-	S	-	M	U	U	M	M	-	U	S	-	-	S	U	U	
Diethylpyrocarbonate	S	S	U	-	S	S	S	-	S	U	S	U	S	U	U	-	-	S	S	M	S	S	S	S	S	S	S
Dimethylsulfoxide	S	S	U	U	S	S	S	-	S	U	S	S	U	U	U	-	S	U	U	-	S	U	S	S	S	S	U
Dioxane	M	S	U	U	S	S	M	M	S	U	U	S	U	M	U	U	-	M	M	M	U	S	S	S	S	U	U
Ferric Chloride	U	U	S	-	-	-	M	S	-	M	-	S	-	S	-	-	-	S	S	-	-	-	M	U	S	-	S
Acetic Acid (Glacial)	S	S	U	U	S	S	U	M	S	U	S	U	U	U	U	U	M	S	U	M	U	S	U	S	-	U	
Acetic Acid (5 %)	S	S	M	S	S	S	M	S	S	S	S	S	M	S	S	S	S	S	S	S	M	S	S	M	S	S	M
Acetic Acid (60 %)	S	S	U	U	S	S	U	-	S	M	S	U	U	U	M	S	M	S	M	S	M	U	S	M	U	U	
Ethyl Acetate	M	M	U	U	S	S	M	M	S	S	S	U	U	M	U	U	-	S	U	U	U	S	M	M	S	U	U
Ethyl Alcohol (50 %)	S	S	S	S	S	S	M	S	S	S	S	S	U	S	U	S	S	S	S	S	S	S	M	S	M	U	U
Ethyl Alcohol (95 %)	S	S	S	U	S	S	M	S	S	S	S	S	U	S	U	-	S	S	S	M	S	S	S	U	S	M	U
Ethylene Dichloride	S	-	U	U	-	-	S	M	-	U	U	S	U	U	U	U	U	U	-	U	S	U	-	S	-	S	S
Ethylene Glycol	S	S	S	S	S	S	S	S	S	S	S	S	-	S	U	S	S	S	S	S	S	S	M	S	M	S	S
Ethylene Oxide Vapor	S	-	U	-	-	U	-	-	S	U	-	S	-	S	M	-	-	S	S	U	S	U	S	S	S	S	U
Ficoll-Hypaque™	M	S	S	-	S	S	S	-	S	S	S	S	-	S	S	-	S	S	S	S	S	S	M	S	S	S	S
Hydrofluoric Acid (10 %)	U	U	U	M	-	-	U	-	-	U	U	S	-	S	M	U	S	S	S	S	M	S	U	U	U	-	-
Hydrofluoric Acid (50 %)	U	U	U	U	-	-	U	-	-	U	U	U	U	S	U	U	U	S	S	M	M	S	U	U	U	-	M
Hydrochloric Acid (conc.)	U	U	U	U	-	U	U	M	-	U	M	U	U	M	U	U	U	-	S	-	U	S	U	U	U	-	-

CHEMICAL	MATERIAL																										
	ALUMINUM	ANODIC COATING FOR ALUMINUM	BUNA N	CELLULOSE ACETATE BUTYRATE	POLYURETHANE ROTOR PAINT	COMPOSITE CARBON FIBER/ EPOXY	DELRIN™	ETHYLENE PROPYLENE	GLASS	NEOPRENE	NORYL™	NYLON	PET™, POLYCLEAR™, CLEARGRIP™	POLYALLUMER	POLYCARBONATE	POLYESTER, GLASS THERMOSET	POLYIMIDE	POLYETHYLENE	POLYPROPYLENE	POLYSULFONE	POLYVINYL CHLORIDE	FULON A™, TEFLON™	SILICON/RUBBER	STAINLESS STEEL	TITANIUM	Tygon™	Viton™
Formaldehyde (40 %)	M	M	M	S	S	S	S	M	S	S	S	S	M	S	S	S	U	S	S	M	S	S	M	S	M	U	
Glutaraldehyde	S	S	S	S	-	-	S	-	S	S	S	S	S	S	S	-	-	S	S	S	-	-	S	S	S	-	-
Glycerol	M	S	S	-	S	S	S	S	S	S	S	S	S	S	S	S	-	S	S	S	S	S	S	S	S	S	S
Guanidine Hydrochloride	U	U	S	-	S	S	S	-	S	S	S	S	S	S	S	-	-	S	S	S	S	S	S	U	S	S	S
Haemo-Sol™	S	S	S	-	-	-	S	-	S	S	S	S	S	S	S	-	-	S	S	S	S	S	S	S	S	S	S
Hexane	S	S	S	-	S	S	S	-	S	S	U	S	U	M	U	S	S	U	S	S	M	S	S	S	S	U	S
Isobutyl Alcohol	-	-	M	U	-	-	S	S	-	U	-	S	U	S	S	M	S	S	S	-	S	S	-	S	-	S	-
Isopropyl Alcohol	M	M	M	U	S	S	S	S	S	U	S	S	U	S	U	M	S	S	S	S	S	S	S	M	M	M	S
Iodoacetic Acid	S	S	M	-	S	S	S	-	S	M	S	S	M	S	S	-	M	S	S	S	S	S	M	S	S	M	M
Potassium Bromide	U	S	S	-	S	S	S	-	S	S	S	S	S	S	S	S	S	S	S	-	S	S	M	S	S	S	S
Potassium Carbonate	M	U	S	S	S	S	S	-	S	S	S	S	S	U	S	S	S	S	S	S	S	S	S	S	S	S	S
Potassium Chloride	U	S	S	-	S	S	S	S	S	S	S	S	S	S	S	-	S	S	S	S	S	S	S	U	S	S	S
Potassium Hydroxide (5 %)	U	U	S	S	S	S	M	-	S	S	S	S	-	S	U	S	S	S	S	S	S	M	U	M	S	U	
Potassium Hydroxide (conc.)	U	U	M	U	-	-	M	-	M	S	S	-	U	M	U	U	U	S	M	-	M	U	-	U	U	-	U
Potassium Permanganate	S	S	S	-	S	S	S	-	S	S	S	U	S	S	S	M	-	S	M	S	U	S	M	S	U	S	S
Calcium Chloride	M	U	S	S	S	S	S	S	S	S	S	S	S	M	S	-	S	S	S	S	S	S	M	S	S	S	S
Calcium Hypochlorite	M	-	U	-	S	M	M	S	-	M	-	S	-	S	M	S	-	S	S	M	S	M	U	S	-	S	-
Kerosene	S	S	S	-	S	S	S	U	S	M	U	S	U	M	M	S	-	M	M	M	S	S	U	S	U	S	U
Sodium Chloride (10 %)	S	-	S	S	S	S	S	-	-	-	S	S	S	S	S	-	S	S	S	S	-	S	S	M	-	S	-
Sodium Chloride (sat'd)	U	-	S	U	S	S	S	-	-	-	-	S	S	S	S	S	-	S	S	-	S	-	S	M	-	S	-
Carbon Tetrachloride	U	U	M	S	S	U	M	U	S	U	U	S	U	M	U	S	S	M	M	S	M	M	M	U	S	S	S
Aqua Regia	U	-	U	U	-	-	U	-	-	-	-	-	U	U	U	U	U	U	U	-	-	-	-	-	S	-	M
Solution 555 (20 %)	S	S	S	-	-	-	S	-	S	S	S	S	S	S	S	-	-	S	S	S	-	S	S	S	S	S	S
Magnesium Chloride	M	S	S	-	S	S	S	S	S	S	S	S	S	S	S	S	S	S	S	S	S	S	M	S	S	S	S
Mercaptoacetic Acid	U	S	U	-	S	M	S	-	S	M	S	U	U	U	U	-	S	U	U	S	M	S	U	S	S	S	S
Methyl Alcohol	S	S	S	U	S	S	M	S	S	S	S	S	U	S	U	M	S	S	S	S	S	S	M	S	M	U	U
Methylene Chloride	U	U	U	U	M	S	S	U	S	U	U	S	U	U	U	U	U	M	U	U	U	S	M	U	S	U	U
Methyl Ethyl Ketone	S	S	U	U	S	S	M	S	S	U	U	S	U	U	U	S	S	U	U	S	U	S	S	S	U	U	U
Metrizamide™	M	S	S	-	S	S	S	-	S	S	S	S	-	S	S	-	-	S	S	S	S	S	M	S	S	S	S
Lactic Acid (100 %)	-	-	S	-	-	-	-	-	M	S	U	-	S	S	S	M	S	S	-	M	S	M	S	S	-	S	-
Lactic Acid (20 %)	-	-	S	S	-	-	-	-	M	S	M	-	S	S	S	S	S	S	S	M	S	M	S	S	-	S	-
N-Butyl Alcohol	S	-	S	U	-	-	S	-	-	S	M	-	U	S	M	S	S	S	S	M	M	S	M	-	S	-	S
N-Butyl Phthalate	S	S	U	-	S	S	S	-	S	U	U	S	U	U	U	M	-	U	U	S	U	S	M	M	S	U	S
N, N-Dimethylformamide	Sx	S	S	U	S	M	S	-	S	S	U	S	U	U	U	-	S	S	U	U	S	M	S	S	S	U	U
Sodium Borate	M	S	S	S	S	S	S	S	S	S	U	S	S	S	S	S	-	S	S	S	S	S	M	S	S	S	S
Sodium Bromide	U	S	S	-	S	S	S	-	S	S	S	S	S	S	S	-	S	S	S	S	S	S	M	S	S	S	S
Sodium Carbonate (2 %)	M	U	S	S	S	S	S	S	S	S	S	S	S	U	S	S	S	S	S	S	S	S	S	S	S	S	S
Sodium Dodecyl Sulfate	S	S	S	-	S	S	S	-	S	S	S	S	S	S	S	-	S	S	S	S	S	S	S	S	S	S	S
Sodium Hypochlorite (5 %)	U	U	M	S	S	M	U	S	S	M	S	S	S	M	S	S	S	S	M	S	S	M	U	S	M	S	S
Sodium Iodide	M	S	S	-	S	S	S	-	S	S	S	S	S	S	S	-	-	S	S	S	S	S	M	S	S	S	S
Sodium Nitrate	S	S	S	-	S	S	S	S	S	S	S	S	S	S	S	S	-	S	S	S	S	S	U	S	S	S	S
Sodium Sulfate	U	S	S	-	S	S	S	S	S	S	S	S	S	S	S	S	S	S	S	S	S	S	M	S	S	S	S
Sodium Sulfide	S	-	S	S	-	-	-	S	-	-	-	S	S	S	U	U	-	-	S	-	-	-	S	M	-	S	-
Sodium Sulfite	S	S	S	-	S	S	S	M	S	S	S	S	S	S	M	-	S	S	S	S	S	S	S	S	S	S	S
Nickel Salts	U	S	S	S	S	-	S	S	S	-	-	S	S	S	S	-	S	S	S	S	S	S	M	S	S	S	S
Oils (Petroleum)	S	S	S	-	-	-	S	U	S	S	S	U	U	M	S	M	U	U	S	S	U	S	S	U	S	S	S
Oils (Other)	S	-	S	-	-	-	S	M	S	S	S	S	U	S	S	S	S	S	S	S	S	S	-	S	M	S	S
Oleic Acid	S	-	U	S	S	S	U	U	S	U	S	S	M	S	S	S	S	S	S	S	S	M	U	S	M	M	M
Oxalic Acid	U	U	M	S	S	S	U	S	S	S	S	S	U	S	U	S	S	S	S	S	S	S	U	M	S	S	S
Perchloric Acid (10 %)	U	-	U	-	S	U	U	-	S	M	M	-	-	M	U	M	S	M	M	-	M	S	U	-	S	-	S
Perchloric Acid (70 %)	U	U	U	-	-	U	U	-	S	U	M	U	U	M	U	U	U	M	M	U	M	S	U	U	S	U	S
Phenol (5 %)	U	S	U	-	S	M	M	-	S	U	M	U	U	S	U	M	S	M	S	U	U	S	U	M	M	M	S
Phenol (50 %)	U	S	U	-	S	U	M	-	S	U	M	U	U	U	U	S	U	M	U	U	U	S	U	U	M	S	S
Phosphoric Acid (10 %)	U	U	M	S	S	S	U	S	S	S	S	U	-	S	S	S	S	S	S	S	S	U	M	U	S	S	S
Phosphoric Acid (conc.)	U	U	M	M	-	-	U	S	-	M	S	U	U	M	M	S	S	S	M	S	M	S	U	M	U	-	S
Physiologic Media (Serum, Urine)	M	S	S	S	-	-	S	-	S	S	S	S	S	S	S	S	S	S	S	S	S	S	S	S	S	S	S
Picric Acid	S	S	U	-	S	M	S	S	S	M	S	U	S	S	S	U	S	S	S	S	U	S	U	M	S	M	S
Pyridine (50 %)	U	S	U	U	S	U	U	-	U	S	S	U	U	M	U	U	-	U	S	M	U	S	S	U	U	U	U
Rubidium Bromide	M	S	S	-	S	S	S	-	S	S	S	S	S	S	S	-	-	S	S	S	S	S	M	S	S	S	S
Rubidium Chloride	M	S	S	-	S	S	S	-	S	S	S	S	S	S	S	-	-	S	S	S	S	S	M	S	S	S	S
Sucrose	M	S	S	-	S	S	S	S	S	S	S	S	S	S	S	S	S	S	S	S	S	S	S	S	S	S	S

CHEMICAL	MATERIAL																										
	ALUMINUM	ANODIC COATING FOR ALUMINUM	BUNA N	CELLULOSE ACETATE BUTYRATE	POLYURETHANE ROTOR PAINT	COMPOSITE CARBON FIBER/ EPOXY	DELIRIN™	ETHYLENE PROPYLENE	GLASS	NEOPRENE	NORYL™	NYLON	PET ¹ , POLYCLEAR™, CLEARCRIMP™	POLYALLOMER	POLYCARBONATE	POLYESTER, GLASS THERMOSET	POLYIMIDE	POLYETHYLENE	POLYPROPYLENE	POLYSULFONE	POLYVINYL CHLORIDE	FULON A™, TEFLO™	SILICON RUBBER	STAINLESS STEEL	TITANIUM	Tycon™	Viton™
Sucrose, Alkaline	M	S	S	-	S	S	S	-	S	S	S	S	S	S	U	S	S	S	S	S	S	S	S	M	S	S	S
Sulfosalicylic Acid	U	U	S	S	S	S	S	-	S	S	S	U	S	S	S	-	S	S	S	-	S	S	S	U	S	S	S
Nitric Acid (10 %)	U	S	U	S	S	U	U	-	S	U	S	U	-	S	S	S	S	S	S	S	S	S	M	S	S	S	S
Nitric Acid (50 %)	U	S	U	M	S	U	U	-	S	U	S	U	U	M	M	U	M	M	M	S	S	S	U	S	S	M	S
Nitric Acid (95 %)	U	-	U	U	-	U	U	-	-	U	U	U	U	M	U	U	U	U	M	U	U	S	U	S	S	-	S
Hydrochloric Acid (10 %)	U	U	M	S	S	S	U	-	S	S	S	U	U	S	U	S	S	S	S	S	S	S	U	M	S	S	S
Hydrochloric Acid (50 %)	U	U	U	S	U	U	-	S	M	S	U	U	U	M	U	S	S	S	S	S	M	S	M	U	U	M	M
Sulfuric Acid (10 %)	M	U	U	S	S	U	U	-	S	S	M	U	S	S	S	S	S	S	S	S	S	U	U	U	U	S	S
Sulfuric Acid (50 %)	M	U	U	U	S	U	U	-	S	S	M	U	U	S	U	U	M	S	S	S	S	U	U	U	M	S	S
Sulfuric Acid (conc.)	M	U	U	U	-	U	U	M	-	-	M	U	U	S	U	U	U	M	S	U	M	S	U	U	U	-	S
Stearic Acid	S	-	S	-	-	-	S	M	S	S	S	S	-	S	S	S	S	S	S	S	S	S	M	M	S	S	S
Tetrahydrofuran	S	S	U	U	S	U	U	M	S	U	U	U	U	U	-	M	U	U	U	U	S	U	S	U	U	U	U
Toluene	S	S	U	U	S	S	M	U	S	U	U	S	U	U	S	U	M	U	U	S	U	U	U	U	U	M	M
Trichloroacetic Acid	U	U	U	-	S	S	U	M	S	U	S	U	U	S	M	-	M	S	S	U	U	S	U	U	U	M	U
Trichloroethane	S	-	U	-	-	-	M	U	-	U	-	S	U	U	U	U	U	U	U	U	U	U	-	S	-	S	
Trichloroethylene	-	-	U	U	-	-	-	U	-	U	-	S	U	U	U	U	U	U	U	U	U	S	U	-	U	-	S
Trisodium Phosphate	-	-	-	S	-	-	M	-	-	-	-	-	-	S	-	-	S	S	S	-	-	S	-	-	S	-	S
Tris Buffer (neutral pH)	U	S	S	S	S	S	S	-	S	S	S	S	S	S	S	S	S	S	S	S	S	S	S	S	S	S	S
Triton X-100™	S	S	S	-	S	S	S	-	S	S	S	S	S	S	S	S	S	S	S	S	S	S	S	S	S	S	S
Urea	S	-	U	S	S	S	S	-	-	-	-	S	S	S	M	S	S	S	S	-	S	S	S	M	S	-	S
Hydrogen Peroxide (10 %)	U	U	M	S	S	U	U	-	S	S	S	U	S	S	S	M	U	S	S	S	S	S	M	S	U	S	S
Hydrogen Peroxide (3 %)	S	M	S	S	S	-	S	-	S	S	S	S	S	S	S	S	M	S	S	S	S	S	S	S	S	S	S
Xylene	S	S	U	S	S	S	M	U	S	U	U	U	U	U	M	U	M	U	U	U	U	S	U	M	S	U	S
Zinc Chloride	U	U	S	S	S	U	S	S	S	S	S	S	S	S	S	S	S	S	S	S	S	S	S	U	S	S	S
Zinc Sulfate	U	S	S	-	S	S	S	S	S	S	S	S	S	S	S	S	S	S	S	S	S	S	S	S	S	S	S
Citric Acid (10 %)	M	S	S	M	S	S	M	S	S	S	S	S	S	S	S	M	S	S	S	S	S	S	S	S	S	S	S

¹ POLYETHYLENETEREPHTHALATE

Key

S – Satisfactory

M – M = Moderate attack, may be satisfactory for use in centrifuge depending on length of exposure, speed involved, etc.; suggest testing under actual conditions of use.

U – U = Unsatisfactory, not recommended.

/ – No data available. Because no organized chemical resistance data exists for materials under the stress of centrifugation, when in doubt we recommend pretesting sample lots. suggest testing, using sample to avoid loss of valuable material.

NOTE
Chemical resistance data is included only as a guide to product use.

Index

A

Aerosol-tight Applications 19
Aerosol-tight Closure with ClickSeal 20
Autoclaving 26

B

Basic Principles 19
Before a Run 17

C

Checking the Aerosol-Tightness 19
Cleaning 22
Cleaning Intervals 21
Coated rotors 21

D

Decontamination 25
Disinfection 24
Dropped Rotors 29

F

Fill Level 19

I

Improper Loading 17
Intended Use 6

L

Lifetime 18

M

Maintenance and Care 31
Maximum Loading 17
Missing Paint and Anodization 29

O

Overheating 29

P

Precautions 7
Preface 6
Proper Loading 17

Q

Quick Test 19

R

RCF-Values 27
Removing the Rotor 16
Rotor Care Guide 28
Rotor installation 15

Rotorloading 17
Rotor Maintenance 29
Rotor Specifications 8
Routine Evaluation and Care of Your Rotor 28

S

Scope of Supply 6
Service of Thermo Fisher Scientific 26
Shipping and Depositing of Centrifuge and Accessories 26
Storage 31
Stress Corrosion 28
Symbols used in the Manual 6

W

WEEE Compliance 2



Thermo Electron LED GmbH
Zweigniederlassung Osterode
Am Kalkberg, 37520 Osterode am Harz
Germany

thermofisher.com/rotors

© 2013-2020 Thermo Fisher Scientific Inc. All rights reserved.
All trademarks are the property of Thermo Fisher Scientific Inc. and its subsidiaries unless otherwise indicated.

Delrin, TEFLON, and Viton are registered trademarks of DuPont. Noryl is a registered trademark of SABIC. POLYCLEAR is a registered trademark of Hongye CO., Ltd. Hypaque is a registered trademark of Amersham Health As. RULON A and Tygon are registered trademarks of Saint-Gobain Performance Plastics. Alconox is a registered trademark of Alconox. Ficoll is a registered trademark of GE Healthcare. Haemo-Sol is a registered trademark of Haemo-Sol. Triton is a registered trademark of Union Carbide Corporation. Valox is a registered trademark of General Electric Co.

Specifications, terms and pricing are subject to change. Not all products are available in all countries. Please consult your local sales representative for details.

Shown pictures within the manual are examples and may differ considering the set parameters and language. Pictures of the user interface within the manual are showing the English version as example.

Australia +61 39757 4300

Austria +43 1 801 40 0

Belgium +32 9 272 54 82

China +800 810 5118, +400 650 5118

France +33 2 2803 2180

Germany national toll free
0800 1 536 376

Germany international +49 6184 90 6000

India toll free +1800 22 8374

India +91 22 6716 2200

Italy +39 02 95059 552

Japan +81 3 5826 1616

Korea +82 2 2023 0600

Netherlands +31 76 579 55 55

New Zealand +64 9 980 6700

Nordic/Baltic/CIS countries
+358 10 329 2200

Russia +7 812 703 42 15, +7 495 739 76 41

Singapore +82 2 3420 8700

Spain/Portugal +34 93 223 09 18

Switzerland +41 44 454 12 12

UK/Ireland +44 870 609 9203

USA/Canada +1 866 984 3766

Other Asian Countries +852 3107 7600

Countries not listed +49 6184 90 6000

en

