



Thermo Scientific Barnstead MicroPure Ultrapure water system

Operating Instructions

50148630 Revision B June 2016

© 2016 Thermo Fisher Scientific Inc. All rights reserved.

Thermo Fisher Scientific Inc. provides this document to its customers with a product purchase to use in the product operation. This document is copyright protected and any reproduction of the whole or any part of this document is strictly prohibited, except with the written authorization of Thermo Fisher Scientific Inc.

The contents of this document are subject to change without notice. All technical information in this document is for reference purposes only. System configurations and specifications in this document supersede all previous information received by the purchaser.

This document is not part of any sales contract between Thermo Fisher Scientific Inc. and a purchaser. This document shall in no way govern or modify any Terms and Conditions of Sale, which Terms and Conditions of Sale shall govern all conflicting information between the two documents.

Release history:

For Research Use Only. Not for use in diagnostic procedures.

Preface

© 2016 Thermo Fisher Scientific Inc. All rights reserved.

These operating instructions are protected by copyright. Rights resulting thereof, particularly reprint, photomechanical or digital postprocessing or reproduction, even in part, are only allowed with the written consent of Thermo Electron LED GmbH. This regulation does not apply to reproductions for in-plant use. The contents of this operating instructions manual may change at any time and without any prior notice. In case of conflicting translations into foreign languages the German-language version of these operating instructions shall be binding.

Please read through the information given in these operating instructions on installing and operating the system before you begin installation and use of your water purification system. This is of particular importance, as we, the manufacturer, do not assume any liability for damage due to incorrect operation or use of the system other than the intended use.

Thermo Fisher Scientific Inc. provides this document to its customers with a product purchase to use in the product operation. This document is copyright protected. Any reproduction of the whole or any part of this document is strictly prohibited, except with the written authorization of Thermo Fisher Scientific Inc. The contents of this document are subject to change without notice. All technical information in this document is for reference purposes only. System configurations and specifications in this document supersede all previous information received by the purchaser.

Thermo Fisher Scientific Inc. makes no representations that this document is complete, accurate or error-free and assumes no responsibility and will not be liable for any errors, omissions, damage or loss that might result from any use of this document, even if the information in the document is followed properly.

This document is not part of any sales contract between Thermo Fisher Scientific Inc. and a purchaser. This document shall in no way govern or modify any Terms and Conditions of Sale, which Terms and Conditions of Sale shall govern all conflicting information between the two documents.

Legal Information

NOTICE

Specifications, terms and pricing are subject to change. Not all products are available in all countries. Please consult your local sales representative for details.

Warranty

Thermo Electron LED GmbH warrants the operational safety and functions of the Thermo Scientific Barnstead Ultrapure Water Systems only under the condition that:

- The system is installed and operated as per the operation manual. Do not use this product for anything other than its intended use.
- the system is not modified,

- only original spare parts and accessories that have been approved by Thermo Electron LED GmbH are used (third-party spares without Thermo Electron LED GmbH approval void the limited warranty),
- inspections and maintenance are performed at the specified intervals,
- an installation verification test is performed on commissioning the system for the first time and repeated after each preventative maintenance and repair activity. The warranty is valid from the date of delivery of the system to the customer.
- The above mentioned warranty conditions are subject to the general terms and conditions of sale, in effect at the time of purchase, which apply as well.

Explanatory notes on the operating instructions



EU Mark of Conformity



CSA - admission



Indicates a situation which, if not avoided, could result in damage to equipment or property.



Indicates a hazardous situation which, if not avoided, could result in death or serious injuries.



Indicates a hazardous situation which, if not avoided, will result in death or serious injuries.



Is used for applicational hints and useful information.



Risk of electric shock. Electrical work on the system is only to be carried out by qualified personnel.



Protective conductor connection

Connect the power supply to an electrical socket with a protective connection.



Indicates a situation in which protective gloves or clothing must be worn.



Indicates a situation in which protective goggles must be worn.



Indicates a situation in which breathing protection must be used.

This information is valid for the system that is received. For quick and correct service, please include the following information on all inquiries and replacement parts orders which relate to your system:

- the serial number (located on the back of the system on the nameplate)
- the catalog number

Standards and directives

The Thermo Scientific Barnstead Ultrapure water Systems complies with the following standards and directives:

- Low Voltage Directive 2014/35/EC
- EMC Directive 2014/30/EU
- ASTM D1193-6
- RoHs 2011/65/EU

Additionally, the ultrapure water system is in compliance with many other international standards, regulations and directives not listed here. Should you have any questions regarding compliance with national standards, regulations and directives applicable for your country, please contact your Thermo Fisher Scientific sales organization.

Contents

Preface	i
Legal Information	ii
Warranty	ii
Explanatory notes on the operating instructions	iii
Standards and directives	iv
Chapter 1 Transport and packaging	1
Examination on receipt	2
Complaints	2
Packaging for return shipment	2
Chapter 2 Safety precautions	3
Chapter 3 Extend of delivery	7
Extent of delivery MicroPure	8
Extend of delivery MicroPure with tank	8
Available MicroPure systems	9
Available MicroPure with tank systems	9
Chapter 4 Intended Use of the device	11
Intended Use	11
Unintended use	11
Chapter 5 Technical Specification	13
Chapter 6 The Installation area	17
Chapter 7 Installation	19
Connections of the MicroPure system	20
Connections of the MicroPure with tank system	21
Start your MicroPure system into operation	22
Illustration of drain	25
Wall Mounting	26
Mounting the power pack (voltage supply)	27

Chapter 8	Flow chart	29
Chapter 9	How the MicroPure system functions	31
Chapter 10	Initial start up	33
	Putting system into operation	34
	Dispensing water from Dispensing valve	35
	Venting the sterile filter	35
Chapter 11	Operating Elements	37
	Description of control display	38
	Control menu flow diagram	39
Chapter 12	System control	41
	General information	42
	Operating modes	42
	Interval operating mode after switching on	42
	Non-stop mode	43
	Interval operation	43
	UV-Lamp	44
	OFF mode	44
	User menu	45
	Feedwater limiting value	45
	Ultrapure water limiting value	46
	UV-Lamp operating time	47
	Ultrapure cartridge operating hours counter	47
	Rinsing Procedure	47
	Disinfection Procedure	49
	Error history	50
	Print out of Data	50
	Entering a code number	51
	Code lock	51
	OEM Menu	52
	Set the limiting value for temperature	52
	Set the rinsing time	53
	Change the disinfection time	53
	Set the interval pump time	53
	Set the interval rinse time	54
	Set the real-time clock	54
	Set the sending interval	54
	Language selection	55
	Switch units, conductivity/resistance	55
	Switch temperature compensation on/off	55
	Printer output	55

Chapter 13	Maintenance	57
	Maintenance intervals	58
	Replacing the ultrapure cartridge	59
	Disinfection of MicroPure system	61
	Disinfection of MicroPure with tank system	64
	Replacing the ultrafilter	65
	UV-reactor assembly	68
	Replacing the UV-lamp	69
	Replacing the final end filter (0.2µm)	72
	Autoclaving the final end filter	72
Chapter 14	Waste disposal	73
Chapter 15	Trouble shooting	75
Chapter 16	Replacement parts	79
	Replacement parts MicroPure	80
	Replacement parts MicroPure with tank	82
Chapter 17	Consumables	85
	Accessories	85
Chapter 18	Terminal assignment	87
Chapter 19	Maintenance record	89
Chapter 20	Contact information Thermo Fisher Scientific	91

Contents

Transport and packaging

Content

- “Examination on receipt” on page 2
- “Complaints” on page 2
- “Packaging for return shipment” on page 2



Do not pull the plastic foil over your head. Risk of suffocation.
Use the plastic foil only for packaging.

1 Transport and packaging

Ultrapure water systems are carefully inspected and packed prior to shipping, but damage could still possibly occur during transport. Lifting and carrying the Thermo Scientific Barnstead Ultrapure Water System, e.g. to the installation location, should be carried out by two people.

Examination on receipt

Check the completeness of the goods received against the packing list.

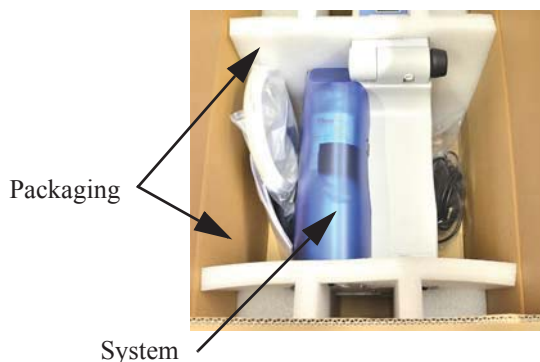

NOTICE

Does the packaging show signs of damage? Inspect the system for damage.

Complaints

Should damage have occurred to the goods during transport:

- Immediately contact your delivery transport agency.
- Save the complete packaging, including the cardboard box, for a possible inspection of them and/or return shipment of the system.

Packaging for return shipment

If possible, use the original box and packaging material.

When these are no longer available, then:

Protect the system from shock by packing it in bubble wrap and/or packaging foam and a strong cardboard box.

NOTICE

The time limit for claims is 6 days from the time of receipt of the goods. The right to claim for damages ceases when this time has elapsed.

NOTICE

- Only a trained person should take the system out of operation.
- Prior to send back a operated device, empty the water and dry the system and take out the cartridges.
- pack the ultrapure cartridges into a bubble wrap and/or packaging foam and take it with in into the package of the ultrapure water system.

Safety precautions

NOTICE

Observe these safety precautions for your own safety!

CAUTION

The Thermo Scientific Barnstead Ultrapure Water Systems are modern water purification systems intended solely for the treatment of potable water. The water it produces is not fit for drinking.

DANGER

Work may only be performed on the system electronics when the system has been switched off and when ESD protection is in place. Only specially trained personnel may work on the system's electronics.



- Do not install or operate the system until you have carefully read through these operating instructions and the notes and notices contained therein.
- Lifting and carrying the ultrapure water system, e.g. to the installation location, should be carried out by two people. To do this, lift the system in tandem at the two corner points beneath the bottom plate.
- The CE mark is nullified if you make any structural changes to the system or install products from other manufacturers in/on the system.
- Protect the system from frost. The temperature at the installation area must be between +2 °C and +40 °C.
- Always observe the applicable, pertinent codes and regulations valid at the installation location of the system and follow all applicable accident prevention regulations.
- The feedwater pressure must be at least 0.1 bar and at max. 6 bar or 1.45 to 87 PSI. When the feedwater pressure is higher, install an external pressure reducer.
- A low pressure check valve is recommended to prevent back flow of feedwater from water system.
- A grounded 100-240V, 50/60Hz electrical outlet must be available (see [“Electrical connections”](#) on page 15).
- Access to the power supply cord and plug may never be restricted or obstructed.
- Unplug the system from the power outlet for all maintenance work on the system.

2 Safety precautions

- An atmospherically vented floor drain with a nominal outer diameter of at least 63 mm (2.48 inch) (DN50 tube) must be present at the installation location. If no drain is provided it is recommended to install for safety reasons a water watcher (for European specifications only). Failure to provide this will release the manufacturer from liability for any water-induced damage that may result.
- Proceed as follows if the system is not to be operated for an extended period, e.g., over extended weekend, or during a vacation period:
 - Switch the system off (unplug the mains plug).
 - Close the feedwater inlet (close the feedwater tap).The pump would be damaged if the system were to run without any supply of feedwater. The manufacturer will not accept any liability should this occur.
- The system must be disinfected or rinsed after an extended down time. The disinfection procedure is described under “[Disinfection of MicroPure system](#)” on [page 61](#).
- The surface or wall on which the system is to be installed or mounted must have an adequate load-carrying capacity (check the capacity and stability of the wall). The dry weight of the system is given under “[Dimensions and weight of MicroPure](#)” on [page 15](#) and “[Dimensions and weight MicroPure with tank](#)” on [page 13](#). When the internal tank is filled, the system has a weight during operation of approx. 32 kg / 70.55 lbs.
- The surface on which the system is installed must be level and stable-not to exceed a maximum of 2% deviation from evenness is recommended.
- When installing the water purification system, always ensure that there is adequate space all around the system (see “[Accessibility to MicroPure system](#)” on [page 16](#)) to ensure that ease of use or easy replacement of materials (e.g., filter change, connection) is possible at all times.

Visually inspect the system at regular intervals. Clean up any water or spills found around the system immediately.



Never look directly into a switched-on UV-lamp, as UV-light endangers eyesight!



To avoid the risk of pinching, crushing, cutting or electrical shock, never perform maintenance on the system without its protective housing, or while it is in operation. Maintenance work on the system may only be performed by trained, authorized specialists.



- Wear safety gloves when working with disinfectant solutions.
- If your skin should come into contact with a chlorine product, rinse it immediately with ample, fresh water.
- The system, or system components, may heat up as a result of a defect. It is recommended to always wear appropriate safety gloves to prevent skin damage or burns.
- Wear safety gloves when changing the UV-lamp, in order to prevent that your skin comes in contact with the UV-lamp glass.



- Wear safety glasses when working with disinfectant solutions.
- If your eyes come into contact with a chlorine product, rinse them immediately with ample, fresh water and immediately contact a physician.



- Check the UV-lamp before initial start.
 - If the UV-lamp is broken
 - wear a breathing protector, filter category FFP3 and replace the UV-lamp. For disposal the UV-lamp refer to “Waste disposal” on page 73.
 - ventilate the room well.

NOTICE

The Hg content in the UV-lamp is so low so that no damage to the environment can arise.

- To avoid tripping, ensure that the tubings do not lay over the floor.
- Apply the general rules of hygiene for laboratories when working with the system.
- Do not use any oxidative cleaning agents for cleaning the system. These can damage the system.
- Proceed as follows when the system has a defect:
 - Switch the system off and unplug the system from power outlet.
 - Shut off the feedwater supply.
 - Contact your local service organization.

2 Safety precautions

Extend of delivery

Contents

- “Extend of delivery MicroPure” on page 8
- “Extend of delivery MicroPure with tank” on page 8
- “Available MicroPure systems” on page 9
- “Available MicroPure with tank systems” on page 9

Extent of delivery MicroPure

The following items are included with the MicroPure ultrapure water system.

1x MicroPure ultrapure water system	Item No.: 5013xxxx
1x Ultrapure cartridge	Item No.: 09.1006
including 1 x assembly kit	
consisting of:	
1x Final end filter (sterile filter 0.2µm)	Item No.: 09.1003
1x Feedwater connecting kit	Item No.: 25.0075
1x Rinse water tube, o.d 8 mm/0.31inch, 3m	Item No.: 18.0036
1x Table top power pack	Item No.: 50149597
1x Universal holder	Item No.: 21.1007
1x Universal adapter	Item No.: 21.1006
1x Rubber connector to nema plug connector	Item No.: 50132200
1x Rubber connector to british ST plug connector	Item No.: 50132203
1x Rubber connector to euro plug connector	Item No.: 50132215

Extend of delivery MicroPure with tank

The following items are included with the MicroPure ultrapure water system.

1x MicroPure with tank	Item No.:5013xxxx
1x Ultrapure cartridge	Item No.: 09.1006
including 1x assembly kit	
consisting of:	
1x Final end filter (sterile filter 0.2µm)	Item No.: 09.1003
1x Rinse water tube, o.d 8 mm/0.31inch, 3m	Item No.: 18.0036
1x Table top power pack	Item No.: 50149597
1x Universal holder	Item No.: 21.1007
1x Universal adapter	Item No.: 21.1006
1x Rubber connector to nema plug connector	Item No.: 50132200
1x Rubber connector to british ST plug connector	Item No.: 50132203
1x Rubber connector to euro plug connector	Item No.: 50132215

Available MicroPure systems

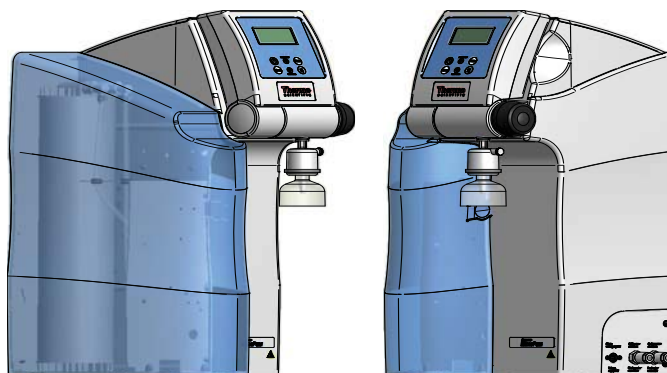

Item No.:	System	Equipment
50132366	MicroPure	standard
50132368	MicroPure	UF
50132370	MicroPure	UV/UF
50132373	MicroPure	UV

Available MicroPure with tank systems

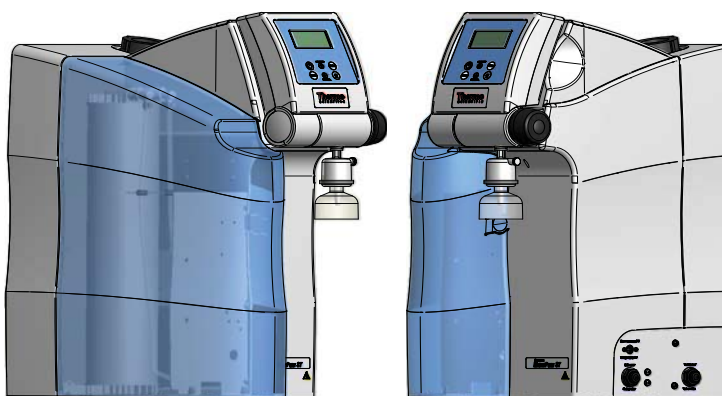

Item No.:	System	Equipment
50132367	MicroPure with tank	standard
50132369	MicroPure with tank	UF
50132372	MicroPure with tank	UV/UF
50132374	MicroPure with tank	UV

3 Extend of delivery

Intended Use of the device

Intended Use

The Thermo Scientific Barnstead Ultrapure Water Systems are laboratory systems and is used for treatment of water. The system allows the purification of water into the water categories mentioned in the standards of ASTM 11.01 and ASTM 11.02.

The Thermo Scientific Barnstead Ultrapure Water Systems are designed to be installed and used in the following application areas:

- Laboratories for cell biological and biotechnological work with the safety levels L1, L2 and L3.
- Medical and microbiological laboratories according to DIN EN 12128.
- Laboratories in the central area of clinics and hospitals.

Unintended use

The system must not be operated outside of the specifications as described in the operating manual. In particular, the system may not be used for production of drinking water and drug manufacturing. The system must not be used as a medical device and outside of laboratories.

4 Intended Use of the device

Technical Specification

NOTICE

Check at regular intervals the quality of your feedwater.

Feedwater requirements

Source	Potable tap water pretreated by reverse osmosis, ion exchange or distillation.
Feedwater conductivity	< 5µS/cm (0.2 MΩ·cm)
Free chlorine	max. 0.05 ppb
TOC	max. 50 ppb
Bacteria count	< 100CFU/ml
Turbidity	< 1.0 NTU
Carbon dioxide (CO ₂)	max. 30 ppm
Silicate	max. 2 ppm
Particles	Filtration to 0.2µm is recommended for protection of the internal filter/final filter
Temperature	+2°C - +35°C
Pressure (only for MicroPure without tank)	0.1 - 6 bar / 1.45 - 87 PSI (at a pressure > 6 bar / 87 PSI a pressure reducer must be installed upstream of the system.

Product water quality ASTM Type I

		Standard	UV	UF	UV/UF
Conductivity (reference temperature +25 °C)	µS/cm	0.055	0.055	0.055	0.055
Resistance (reference temperature +25°C)	MΩ·cm	18.2	18.2	18.2	18.2
TOC value	ppb	5-10	1-5	5-10	1-5
RNase	ng/ml	--	--	--	< 0.003
DNase	pg/ul	--	--	--	< 0.4
Bacteria	CFU/ml	< 0.1	< 0.1	< 0.1	< 0.1
Bacterial endotoxins	EU/ml	--	--	< 0.01	< 0.01
Particles	µm	< 0.2	< 0.2	< 0.2	< 0.2
Performance	l/min	1.0	1.0	1.0	1.0

Dimensions and weight MicroPure with tank

Height	550 mm / 21.65 inch
Width	300 mm / 11.81 inch
Depth	390 mm / 15.35 inch
Base area	277 x 372 mm / 10.91 x 14.65 inch
Weight including ultrapure cartridge and full tank	33 kg / 72.77 lbs

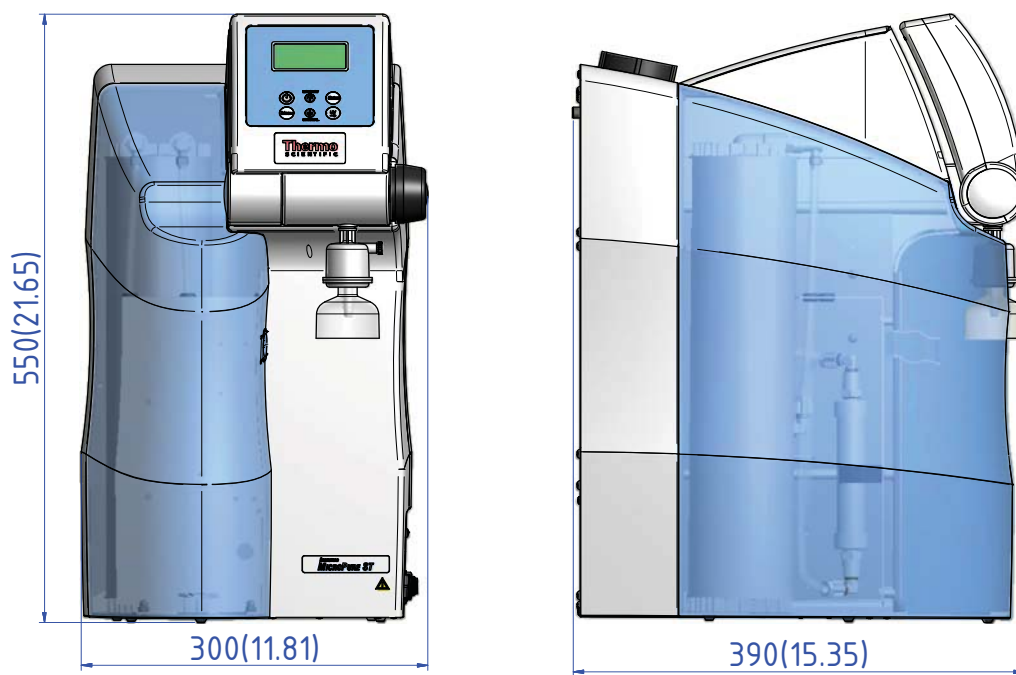

Dimensions and weight of MicroPure

Height	550 mm / 21.65 inch
Width	300 mm / 11.81 inch
Depth	300 mm / 11.81 inch
Base area	277 x 372 mm / 10.91 x 14.65 inch
Weight including ultrapure cartridge	28 kg / 61.74 lbs

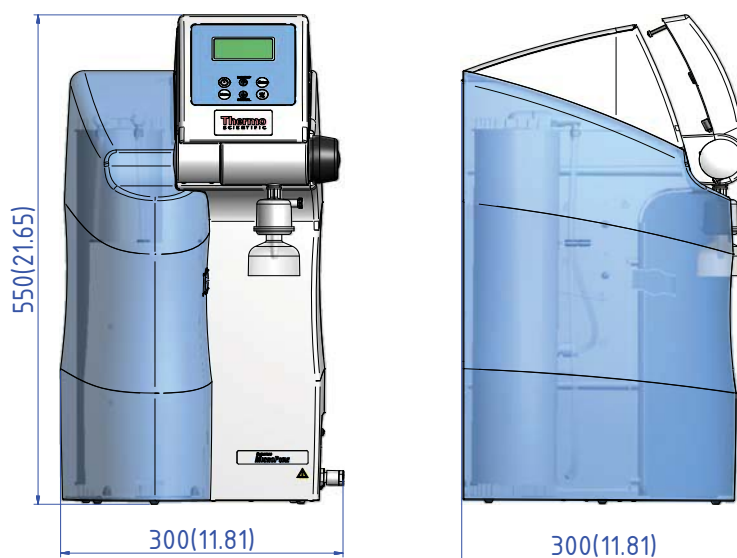
**Water connections**

Feedwater tubing	Tube outer diameter 8mm/0.31 inch
Rinse water tubing	Tube outer diameter 8mm/0.31 inch
Tank overflow tubing (only MicroPure with tank)	Tube outer diameter 8mm/0.31 inch

Electrical connections

Input voltage	AC 100 – 240 VAC, 50 – 60 Hz, 2.0 A max
Output voltage	DC 24 V, 5.0 A max
System connection	DC 24 V, 80 W
Serial Interface	RS232
Potential free contact	maximum 30V, 2A
Protection class	Class II (external SMPS certified as Class I)

Materials of parts which contact water

Adjustable pressure retaining valve	NBR = Acrylnitril Butadien Rubber
Pump head	Nylon with glass fibre
UV lamp	High-purity synthetic quartz

Materials of parts which contact water

UV housing	Stainless steel
Ultrapure cartridge	PP = Polypropylene
UF housing	PC = Polycarbonate
Rinsing solenoid valve	PA = Polyamide
Dispensing valve	PET = Polyethyleneterephthalate
Conductivity measuring cell	POM = Polyoxymethylen, stainless steel
Distributor block	POM = Polyoxymethylen
Connections	POM = Polyoxymethylen
Tubings	PE = Polyethylene
O-Rings	EPDM = Ethylene propylene diene rubber

Accessibility to MicroPure system

Space on left and right from the side of the system	at least 300 mm / 11.81 inch
Space to the back of the system	at least 200 mm / 7.87 inch
Top space	at least 400 mm / 15.75 inch
Space to front of system	Free accessibility

Ambient conditions

	During operation	Storage
Operation area	Indoor rooms	Indoor rooms
Maximum altitude about sea level	up to 2000 m	up to 2000 m
Temperature range	min. +2°C, max +40°C, 80% rel. rH, non-condensing	min. +2 °C, max. +60 °C, 90% rel. rH, non condensing
Line-voltage variation	Not more than +/- 10 % of the line voltage	-- (not applicable)
Transient overvoltages	As usually occur in the supply network (overvoltage category II acc. to IEC 60364-4-443) Note: The rated level of transient overvoltage is the withstand impulse voltage acc. to overvoltage category II of IEC 60364-4-443.	-- (not applicable)
Ventilation requirements	no special requirements	no special requirements
Degree of pollution	2	2

Airborne sound emission

Sound pressure level	49 db(A)
----------------------	----------

The Installation area

NOTICE

The operator is obliged to ensure, that the installation of the water purification unit and its operation are carried out in compliance with all national and international guidelines, applicable and valid for the place of installation. If necessary, measures to protect the drinking water have to be taken by installing appropriate components.

Take the following criteria into consideration when selecting the installation area:

Feedwater pressure (potable tap water) not less than 0.1 bar (1.45 PSI) and not greater than 6 bar (87 PSI).

CAUTION

The feedwater pressure must not be allowed to go above 6 bar. Install an additional pressure reducer when the feedwater pressure is higher.

- Minimum air temperature +2 °C
- The surface on which the system is installed must be level and stable-not to exceed a maximum of 2% deviation from evenness is recommended.
- A smooth wall is required when the system is to be wall-mounted. Check the statics of the wall or standing surface. The standing or wall surface must be strong enough to hold the system. (for system weight, see [“Accessibility to MicroPure system”](#) on page 16).

CAUTION

Free gravity flow to drain must be ensured.

- An atmospherically floor drain with an outer diameter of 63 mm or 2.48 inch (DN 50 tube) shall be provided.
- Unobstructed draining of the rinsing water to the drain must be ensured. When no floor drain is available, install a water watcher to protect against water damage (available only for Europe).
- A check valve is recommended in the feedwater line to prevent back flow of feedwater from the water system.
- An electric socket with protective connection must be available for connection of the system to the voltage supply.(see [“Electrical connections”](#) on page 15)
- Ample working space must be provided around the system for easy and pleasant replacement of consumable and replacement parts and for ease of operation (see [“Accessibility to MicroPure system”](#) on page 16).
- Easy access for operation and control of the system.

6 The Installation area

Installation

Contents

- “Connections of the MicroPure system” on page 20
- “Connections of the MicroPure with tank system” on page 21
- “Start your MicroPure system into operation” on page 22
- “Illustration of drain” on page 25
- “Wall Mounting” on page 26
- “Mounting the power pack (voltage supply)” on page 27

Connections of the MicroPure system

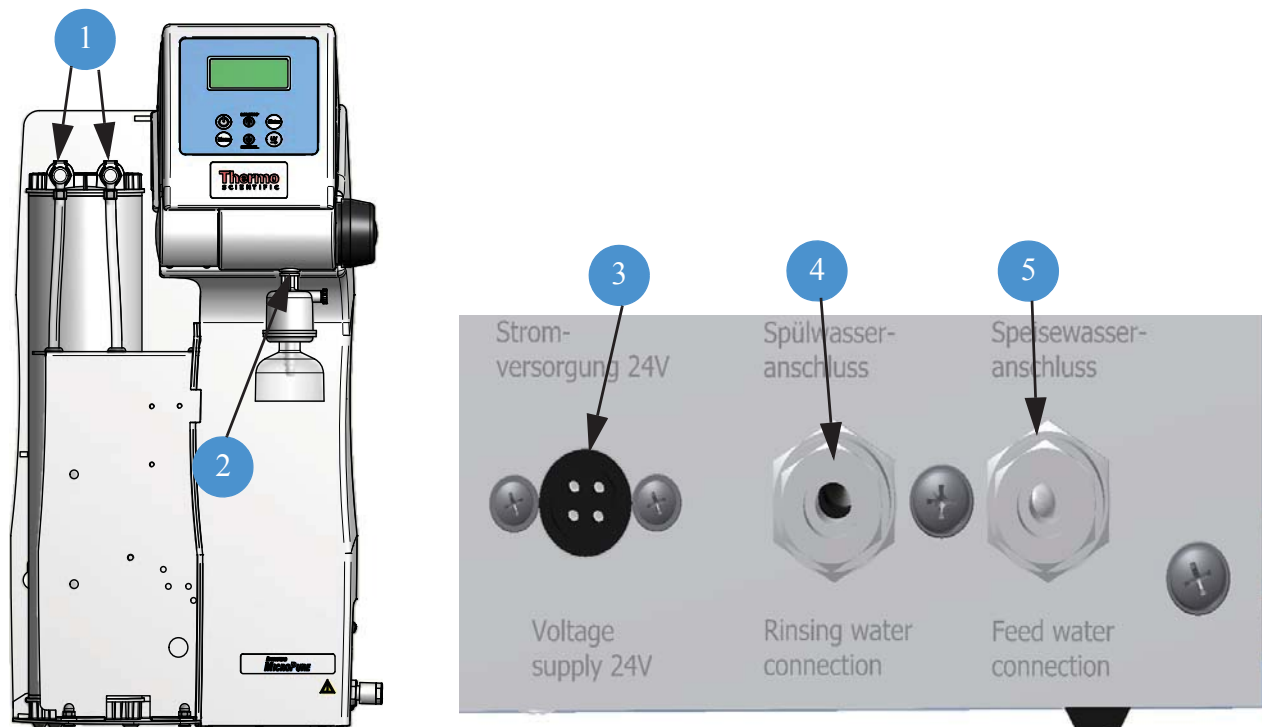

1. Quick connectors for ultrapure cartridge
2. 1/4" threaded fitting connector for sterile filter
3. Voltage supply connector for 24V DC
4. Rinse water connection for o.d 8mm/0.31 inch tube
5. Feedwater connection for o.d 8mm/0.31 inch tube

Connections of the MicroPure with tank system

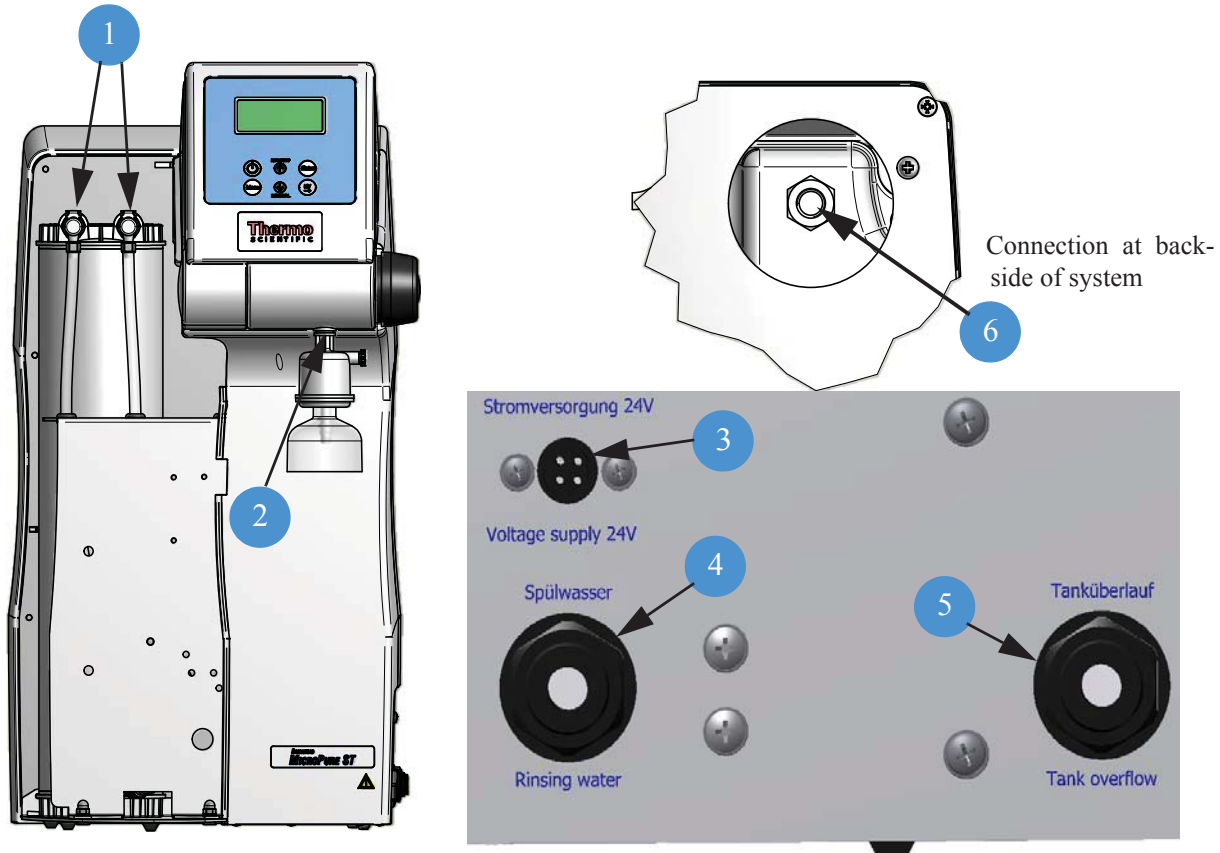

1. Quick connectors for ultrapure cartridge
2. 1/4" threaded fitting connector for sterile filter
3. Voltage supply connector for 24V DC
4. Rinse water connection for o.d 8mm/0.31 inch tube
5. Tank overflow connection for o.d 8mm/0.31 inch tube
6. 1/4" threaded connector for sterile vent filter

Start your MicroPure system into operation

NOTICE

- After complete installation all tubings have to be checked for their correct position on the systems panel and there is no leakage after open the feedwater supply. (Feedwater supply only MicroPure)
- To avoid tripping, ensure that the tubings and wires do not lay over the floor.

Step	Action	Figure
1	Place the MicroPure system at the desired location (on the workbench, under the workbench, or wall-mount). A wall attachment kit is available for wall-mounting.	See Section “Wall Mounting” on page 26.

- 2 Remove the cover from the ultrapure cartridge by pressing the snapper and pull the cover off towards the front.

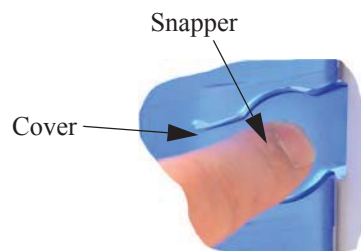

- 3
- Locate the ultrapure cartridge.
 - Place the ultrapure cartridge in the rear section of the unit, insert the two quick connectors into the ultrapure cartridge. When you hear an audible click you can be sure that the quick connectors have been inserted correctly.

NOTICE

The quick connectors are attached to the unit in such a manner so as to prevent installing the ultrapure cartridge incorrectly.

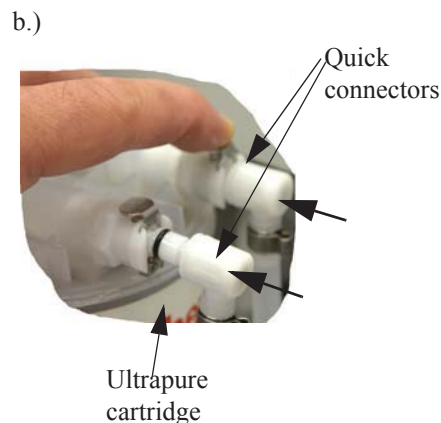

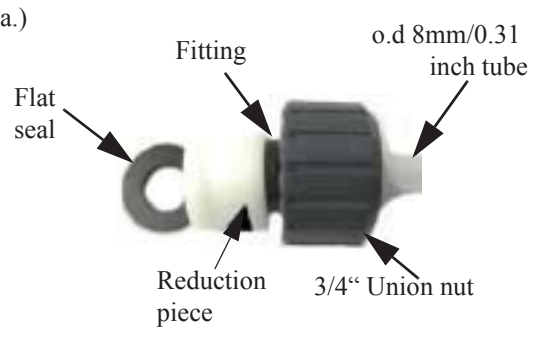
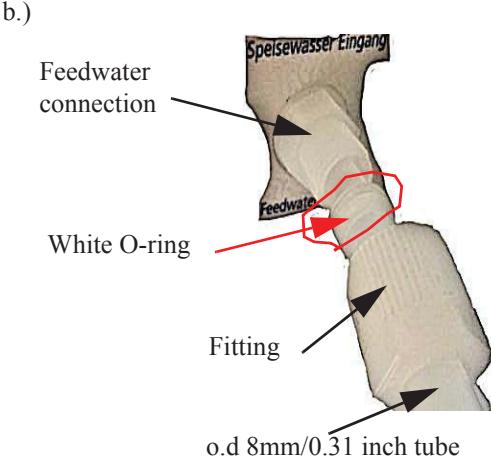
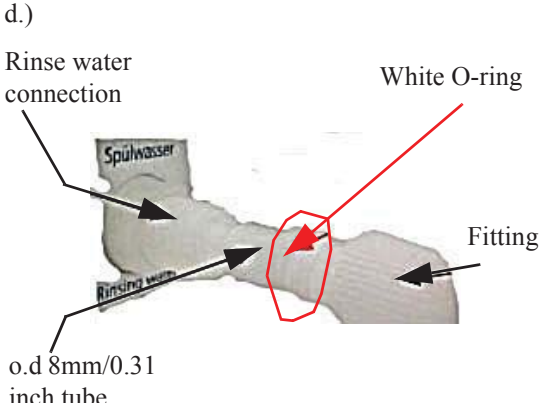
Step	Action	Figure
4	<p>a. Mount the feedwater connecting kit together and connect it with the o.d 8mm/ 0.31 inch tube to the external ion exchanger or feedwater inlet line. The other end of the tube connect to the feedwater connection by unscrewing the fitting on the system.</p> <p>b. After unscrewing the fitting put the o.d 8mm/0.31 inch tube through the fitting and mount the white O-ring on it.</p> <p>c. Screw the fitting back to the system.</p> <p>d. Unscrew the fitting on the connection for rinse water of the system and connect the o.d 8mm/0.31inch tube as describe at step 4b and route the tube with a free gravity fall to the drain (see “Illustration of drain” on page 25).</p> <p>e. Open the feedwater tap..</p>	<p>a.) </p> <p>b.) </p> <p>d.) </p>

NOTICE

If you are using a MicroPure system with tank proceed as follows the next coming steps.

Step	Action	Figure
------	--------	--------

5	Put in the o.d 8mm/0.31 inch tube into the rinse water connection of the system on the systems panel and route the tube with a free gravity fall to the drain (see “Illustration of drain” on page 25).	
---	---------------------------------------------------------------------------------------------------------------------------------------------------------------------------------------------------------	--

6	Put in the o.d 8mm/0.31 inch tube into the tank overflow connection of the system on the systems panel and route the tube with a free gravity fall to the drain (see “Illustration of drain” on page 25).	
---	-----------------------------------------------------------------------------------------------------------------------------------------------------------------------------------------------------------	--

7	<p>Unscrew the lid for the internal 5L feedwater tank and fill the tank with pretreated water.</p> <p>CAUTION</p> <p>Only feedwater that has been pretreated by reverse osmosis, ion exchange or distillation is to be used.</p>	
---	-----------------------------------------------------------------------------------------------------------------------------------------------------------------------------------------------------------------------------------------	--

8	Screw the sterile filter supplied with the unit into the 1/4“ thread of the sampling tap. Open the feedwater tap (only MicroPure) and check that there is no leakage on the connectors and tubes.	
---	---------------------------------------------------------------------------------------------------------------------------------------------------------------------------------------------------	--

Illustration of drain

Illustration of drain siphon for inserting the rinsing water and overflow tubing (only MicroPure with tank).

NOTICE

Shorten the rinsing water and overflow tubing (only MicroPure with tank) to the required length and route it to an atmospherically vented drain.

The tubes that run from the MicroPure system to the drain must be routed with a downward slope and without any kinks or restrictions, as this would result in backing up of the draining water.

If a standard drain siphon is in place, the ends of the tubes must be located at least 20 mm/ 0.75 inch above the drain. Attach the tubes in such a manner that they remain in their position.

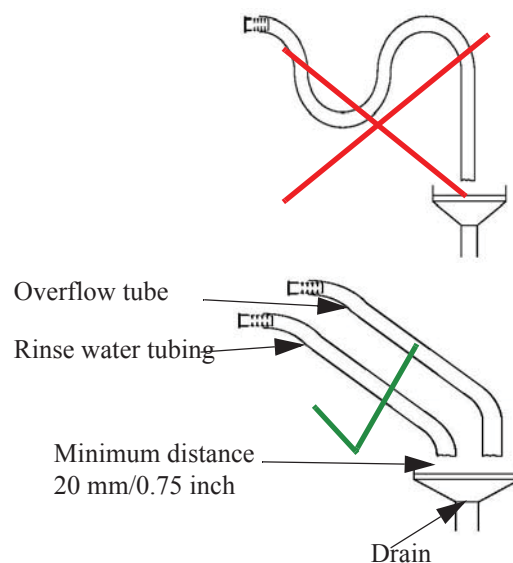

Wall Mounting

NOTICE

You can also mount your MicroPure system on the wall. To do this, use the wall-mounting fixture included in the accessories (purchased separately [Item No.: 09.2212](#)). Before you begin mounting the unit on the wall you must check the strength of the wall to ensure that it is suitable for supporting the unit (see “Dimensions and weight MicroPure with tank” on [page 13](#) and “Dimensions and weight of MicroPure” on [page 15](#) for the unit).

CAUTION

The screws and anchors supplied with the wall-mounting brackets are only suitable for attaching the wall-mounting brackets to a concrete wall or a solid (masonry) wall.

Step	Action	Figure
1	Use the wall-mounting brackets to mark the anchoring points with a pen on the wall at the location where the holes are to be drilled for the wall-mounting bracket. Use an 8 mm/ 0.31 inch drill bit to drill the holes.	See figure below.
2	Insert the three S8 Nylon anchors into the holes and then use the three wood screws to firmly screw the wall-mounting brackets into place.	
3	Lift the unit and hang the back of it on the wall-mounting brackets.	

CAUTION

Always lift and carry the unit in tandem (two people), never alone. Lift the unit at the two bottom corners.

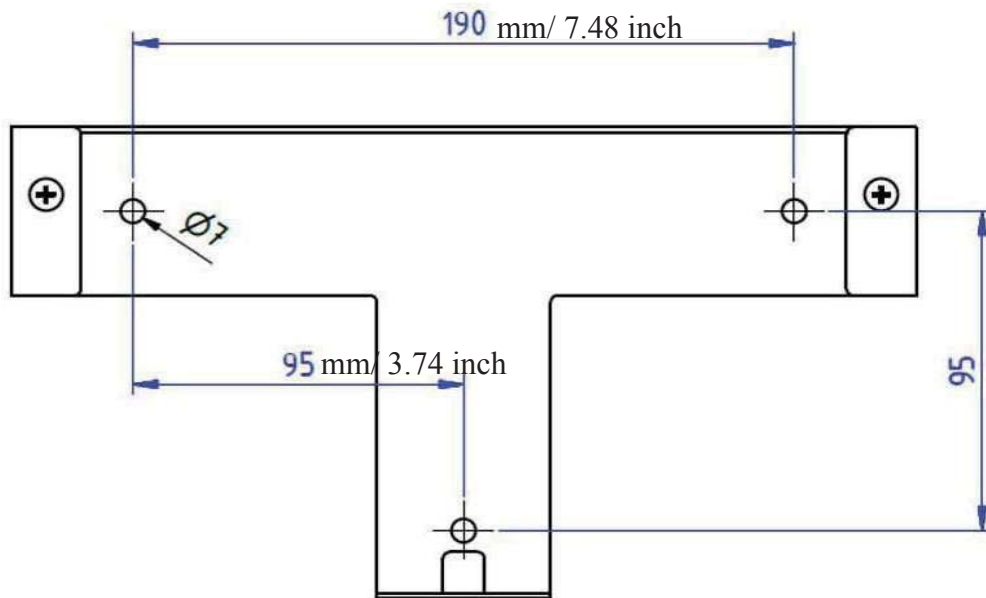

Mounting the power pack (voltage supply)

NOTICE

Whenever possible, mount the power pack on the wall to the left or right of the ultrapure water system where it is freely accessible and does not come in contact with water for get wet.

⚠ DANGER

Take caution to ensure that the suitable plug and the power cable do not get wet. Mount the power pack with dry hands. Risk of an electrical shock.

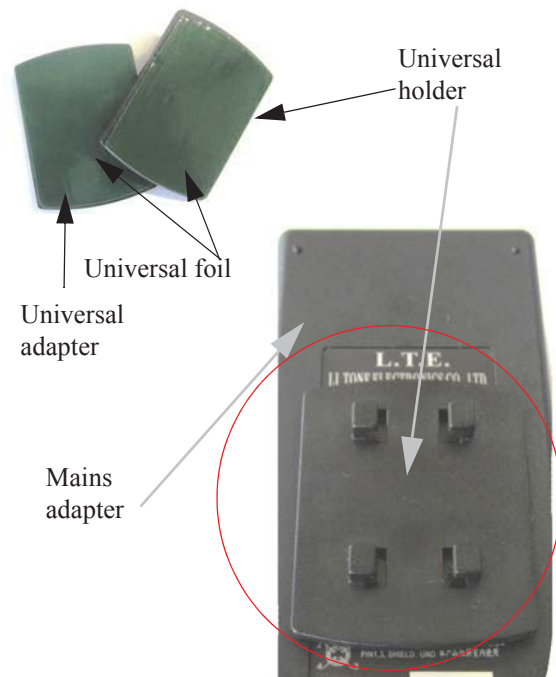
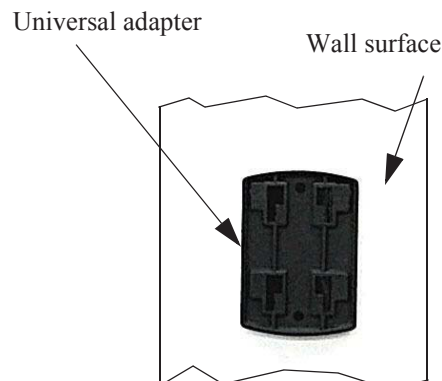
Step	Action	Figure
1	Remove the protective foil on the back of the universal holder and from the universal adapter and attach the universal holder to the center of the back of the main adapter.	 <p>Universal holder</p> <p>Universal foil</p> <p>Universal adapter</p> <p>Mains adapter</p>
2	Attach universal adapter to a smooth wall surface with supplied screws or with glue (not provided).	 <p>Universal adapter</p> <p>Wall surface</p>

Step	Action	Figure
------	--------	--------

- 3
- Take the power supply unit and press it with the attached universal holder onto the wall and then slide it down (see red arrows).
 - Plug the power cable into the power supply unit.

⚠ DANGER

Do not bring the power pack in contact with water. Risk of an electrical shock..

NOTICE

The removable power cable must always face downward when the power supply unit has been mounted.

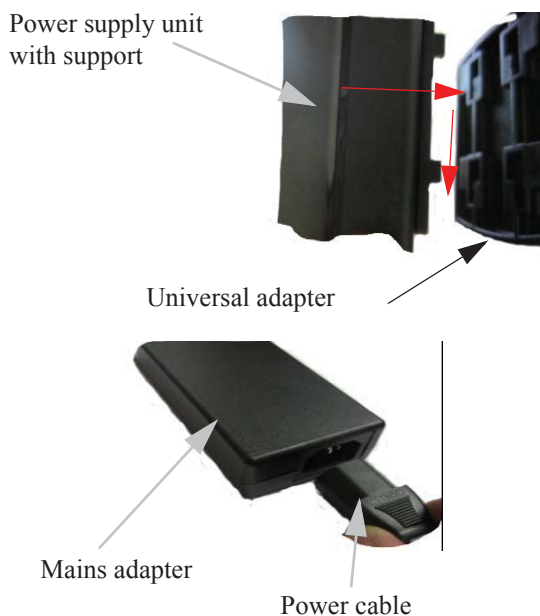

- 5
- Now, connect the power supply unit to the “Power supply” connection on the right side of the MicroPure system. Next plug the power supply to a grounded 100 - 240V, 50/60 Hz power outlet.

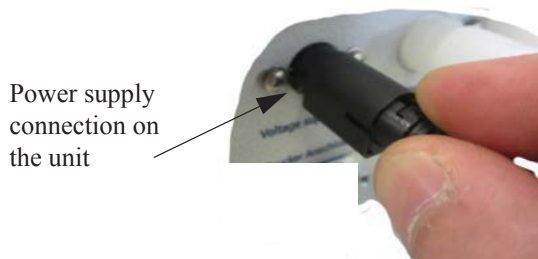

- 6
- Switch the unit on and enter the serial number of the ultrapure cartridge in the control menu (“Replacing the ultrapure cartridge” on page 59). The unit is ready for use now.



Flow chart

NOTICE

The following flow chart describes the MicroPure/ MicroPure with tank system with full equipment (ultrafilter, UV-lamp included). Depending on your MicroPure system configuration the UV-lamp or ultrafilter are inapplicable. The flow direction remains as described in the flow diagram.

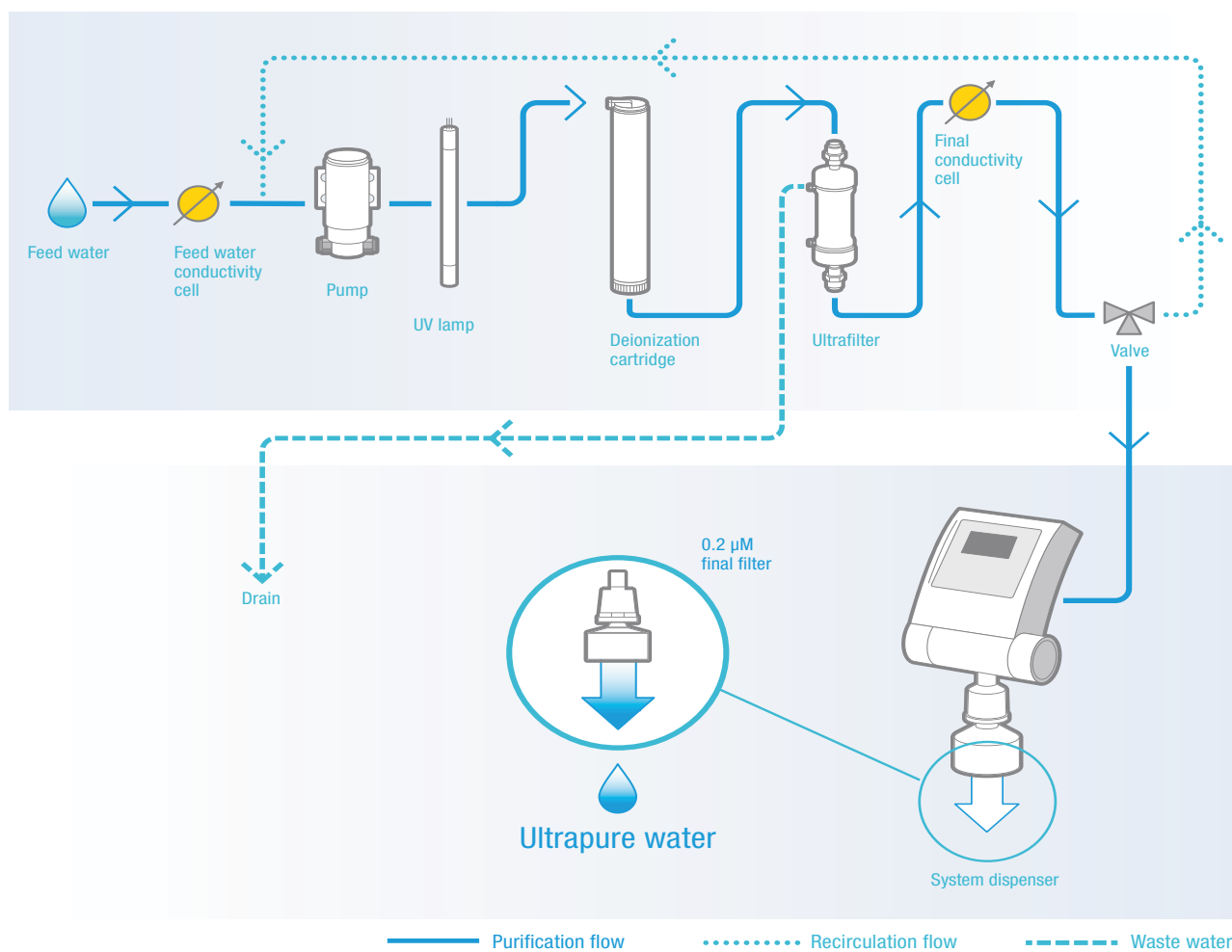

8 Flow chart

How the MicroPure system functions

Tap water coming from the central line or the storage reservoir (storage reservoir only MicroPure with tank) that has been pretreated by reverse osmosis, ion exchange or distillation flows through a pressure reducer and into the ultrapure water system, where the conductivity is monitored. A pressure pump directs this feedwater through UV-photooxidation (only systems with UV, UV/UF) and then through the ultrapure cartridge. From there the water flows through an ultrafilter (only systems with UF, UV/UF). Then follows a permanent definition of conductivity measured by a special conductivity measuring cell equipped with temperature compensation. When ultrapure water is dispensed from the system, it flows through an end filter before reaching the point of use. During Interval operation, the water in the system is circulated in an internal circuit at regular intervals.

9 How the MicroPure system functions

Initial start up

Contents

- “Putting system into operation” on page 34
- “Dispensing water from Dispensing valve” on page 35
- “Venting the sterile filter” on page 35

Putting system into operation

NOTICE

The system must be warmed up or cooled down to room temperature before being put into operation.

CAUTION

Check that all tubing connections have been made as described in Chapter “Connections of the MicroPure system” on page 20 and “Connections of the MicroPure with tank system” on page 21s.



Switch the system on by pressing the “On/Off” button. After a compulsory rinse the system switches to the last operating mode (Interval or Nonstop mode with ion chromatograph in Analyzer mode).

NOTICE

To vent air from the system, switch the system 3 times successively to “Rinsing” in the menu and discard approx. 5 litres of water each time with the manual dispenser. The ultra pure water limiting value may come on during this process.

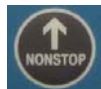

Use this 'NONSTOP'-key to switch the system to the “Nonstop” operating mode.



When the unit has successfully reached the pure water value that you have specified, you can return the unit to the “Interval” mode by pressing the “INTERVAL” button while the unit is in the “Nonstop” mode.

Dispensing water from Dispensing valve

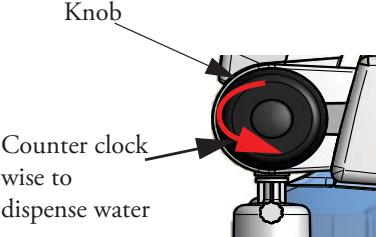
Step	Action	Figure
1	<p>Turn knob counter clock wise to dispense water.</p> <p>Water flow out of unit and can be adjusted with turning the knob. Turn the knob clockwise to slow down or stop water flow.</p> <div style="border: 1px solid black; padding: 5px; margin-top: 10px;"> <p>CAUTION Do not over tighten knob once flow stops, doing so could damage dispensing valve.</p> </div>	

Venting the sterile filter

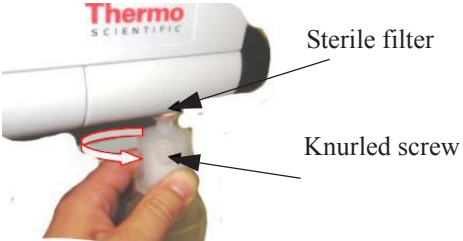
Step	Action	Figure
1	The first time you dispense pure water at the main dispenser through the 0.2 micron final filter, open the white knurled screw.	
2	Do not close the knurled screw until pure water runs out of the opening at the knurled screw continuously.	

Operating Elements

Contents

- “Description of control display” on page 38
- “Control menu flow diagram” on page 39

Description of control display

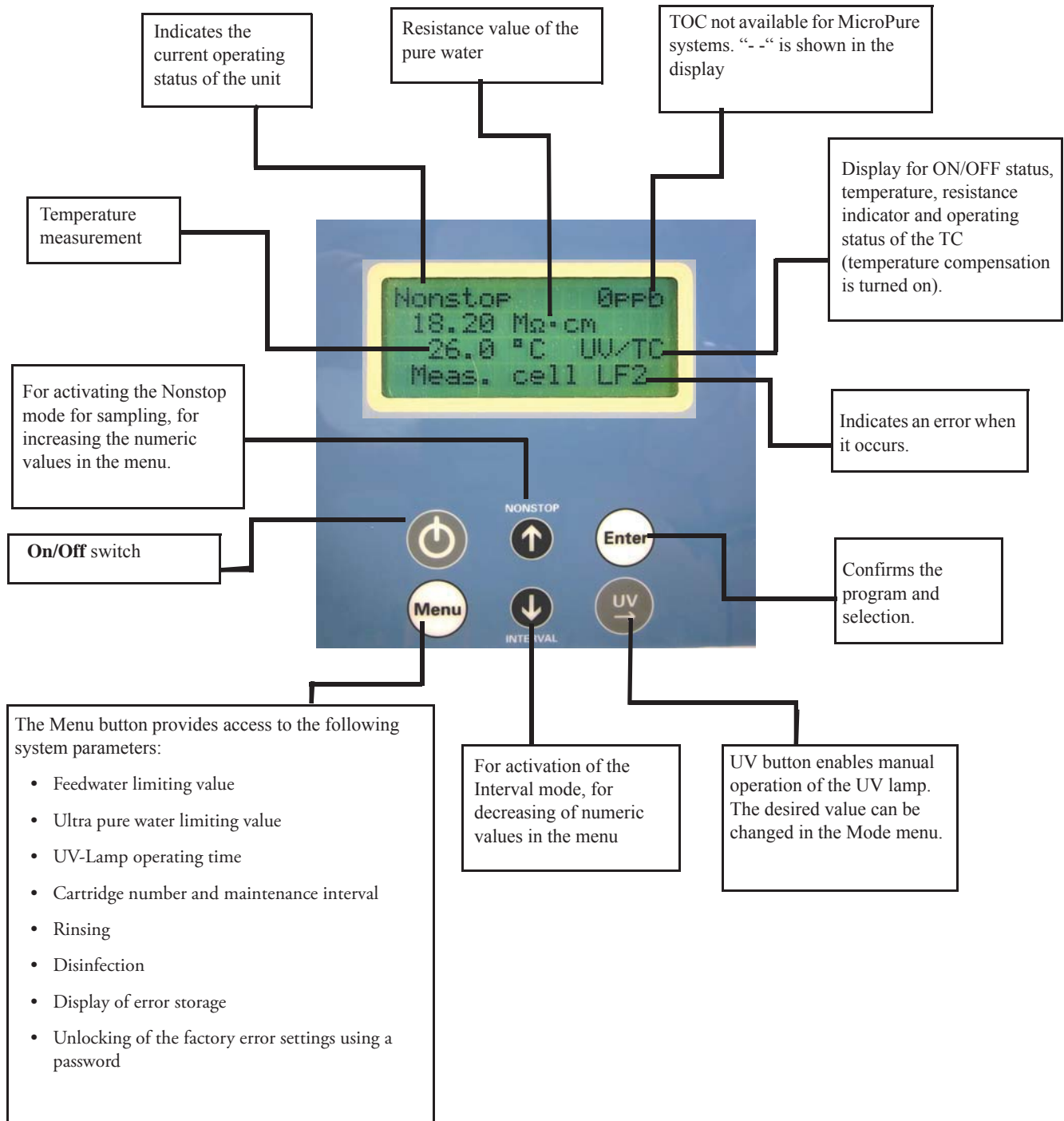

Control menu flow diagram

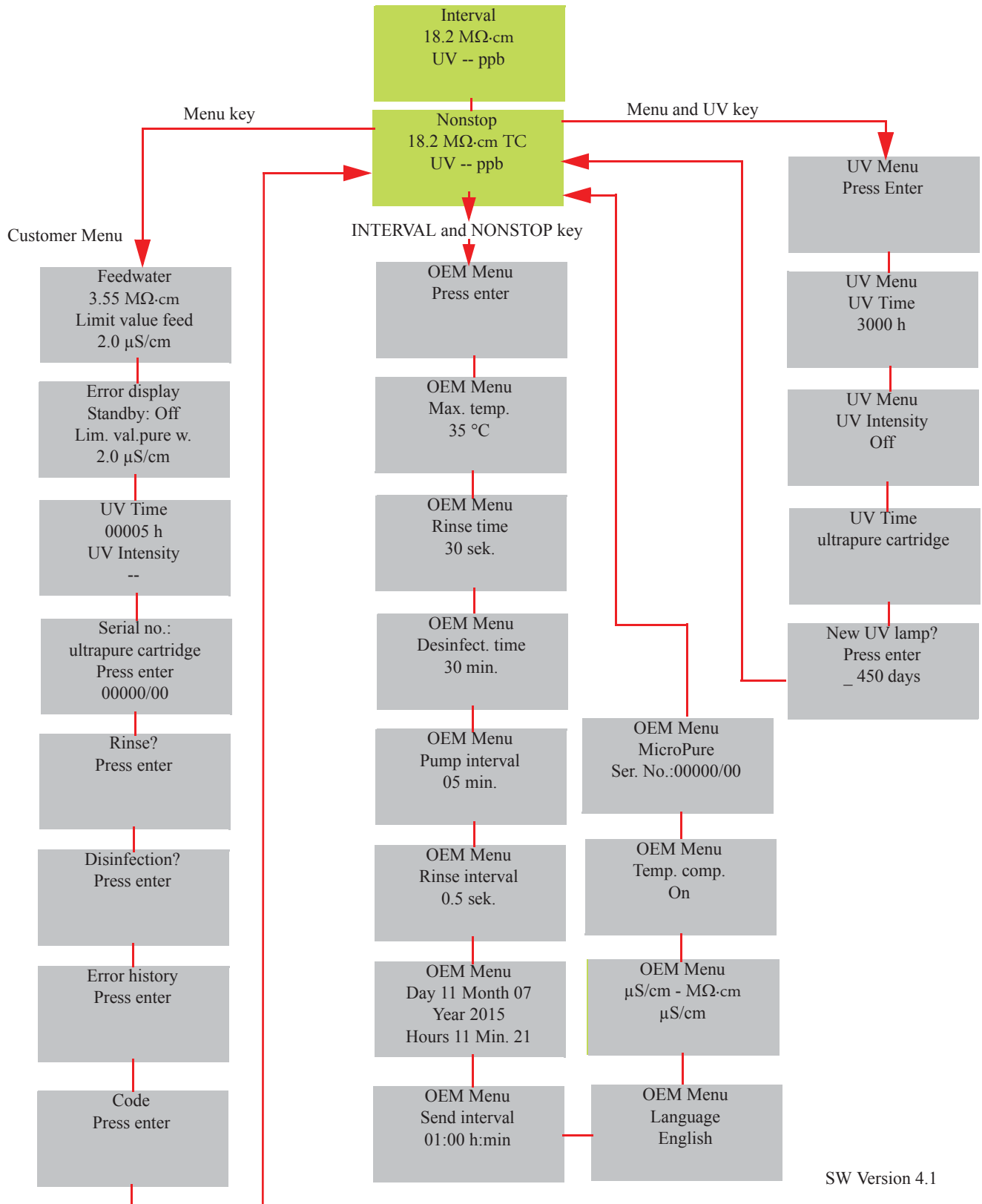

SW Version 4.1

11 Operating Elements

System control

Contents

- “General information” on page 42
- “Operating modes” on page 40
- “User menu” on page 45
- “OEM Menu” on page 52

General information

The software structure consists of five operating modes and four menus, which will be described in more detail in the following sections. Measured values are continually shown in the display and/or in the menus.

Should an error occur, the corresponding fault message is transmitted via the potential-free output and is shown in clear text in the 4th line of the display. In the case of several errors occurring at one time, they are alternately shown in the display.

Shows the error

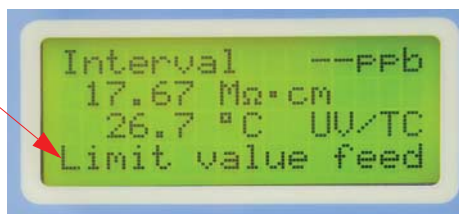

Operating modes

Interval operating mode after switching on

Initially press the ON/OFF button. Then the display will show at first the system version, the system serial number and the software version number to display for 3 seconds. The system then automatically switches to the Interval operating mode (see [“Interval operation”](#) on [page 43](#)), whereby the green backlighting of the display is switched on and remains on until system control is switched off via the ON/OFF-button. The “UV” text message is displayed when the UV-lamp is switched on. The “TC” message is displayed when measured values are subject to temperature compensation. Further to these, the measured values for ultrapure water (measuring cell LF1) and temperature are also displayed. The display of messages and measured values are independent of the operating mode.

The display shows:



Non-stop mode

A press on the “nonstop” button switches the system to the non-stop mode. The non stop mode is the only mode in which water can be dispensed from the system. It is also the mode in which the system will continuously recirculate water with the system to keep the water ready for use. The circulation pump starts to run, the (UF) rinsing solenoid valve (V4) opens for the set “Intv.rinse time”. Non-stop operation is stopped automatically latest after 2 hours. Then the system operates in the “Interval”-Mode. The message UV is shown in the display when the UV-lamp is switched on. The UV lamp can only be switched on and off in this non-stop mode (see UV lamp).

The display shows:



Interval operation

The system is in the Interval mode when the system is switched on with the ON/OFF button. The Interval mode is used when the water system is not needed to be in non-stop mode. This mode helps protect the system against bacteria growth as it will periodically recirculate water. Water can not be dispensed in this mode. The pump runs for the set interval pump time and the rinsing solenoid valve (V4) opens for the set “Interval rinse time”. When the interval pump time has expired, the pump is switched off until the end of the standstill time. The standstill time is given by the difference between half an hour and the interval pump time, so that the pump and the solenoid valve are actuated in a half-hourly rhythm.

The display shows:



UV-Lamp

A press on the UV-button results in showing the letters “UV”. However the UV-lamp is only switched on when the system is in Nonstop operation. The UV-lamp is switched off at the end of Nonstop operation (settable). When Nonstop operation is manually ended by a press on the “Non stop” button, the UV-lamp is switched off after glowing for 0.5 hours.

The operating time of the UV-lamp is recorded and the “UV time” error message is shown in the display when the limiting value set for this time is exceeded. (TOC measuring not available for MicroPure systems.)

The display shows:



Display shows for
MicroPure systems
“- - ppb“

OFF mode

A second press on the ON/Off-button causes the display to go dark and all text output on the display to be extinguished. No outputs are now switched.

User menu

All measured values, operating times and limiting values which are relevant for the user can be set and read in this menu.

A press on the menu-button brings you to this menu. Each further press on the menu-button moves you further from one menu prompt to the next.

Settings can be changed with the arrow buttons. When you confirm a value by pressing on the Enter-button, you are taken to the next menu prompt. Settings can only be made when system control has been previously unlocked by entering a valid code number. (see “Code lock” on page 51)

To simplify changing settings, a press on the UV-button allows you to select a certain individual digit in the numerical value that you want to change. The arrow buttons can now be used to enter the new number from 0 to 9 at that position.

Feedwater limiting value

A single press on the menu-button allows the feedwater conductivity to be read or the limiting value of it to be changed. The fault message “Limit value feed” flashes in the 4th line of the display when the limiting conductivity value is exceeded.

Feedwater measuring range:	10 – 0.01 MΩ·cm
Limiting value setting range:	0.1- 50.0 μS/cm
Basic setting:	2.0 μS/cm

Set the limiting value using the arrow buttons.

With settings above 50 μS/cm / 0.02 MΩ·cm, the limiting value is switched off and the word off appears in the display.

Press the Menu-button once then the display shows:

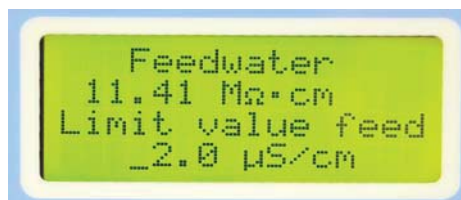

Ultrapure water limiting value

Two presses on the menu-key in this menu allow the fault display for the pure water limiting value and the pure water limiting value to be set. As soon as the fault display is switched on, the fault will be displayed both in Stand-by mode and in Production mode. When the fault display is switched off, the fault is only displayed in Production mode. The “Lim. val.pure w.” message is displayed when the limiting value is exceeded.

Ultrapure water measuring range:	0.1 MΩ·cm
Limiting value setting range:	0.055- 5.000 μS/cm
Basic setting:	0.200 μS/cm
Basic setting, fault suppression:	On

When a setting above 5.0 μS/cm is entered for the limiting value, the limiting value is switched off and the word “Off” appears in the display.

Press the Menu-button twice then the display shows:



UV-Lamp operating time

NOTICE

- The UV-intensity is not available for the MicroPure system.
- For more details see under section “Replacing the UV-lamp” on page 69.

In this menu the operation hours of the UV-lamp are indicated the display under “UV time”. The fault message "UV duration" is displayed when the maximum operating time has been reached.

Press the menu-button 3 times then the display shows:

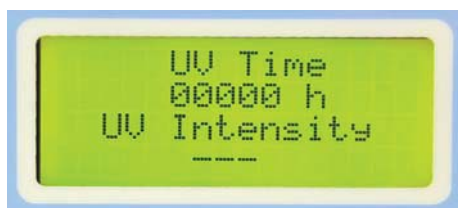

Ultrapure cartridge operating hours counter

After fourth press on the menu-button the operating hours counter for the ultrapure cartridge is set by input of a valid serial number.

Press the menu-button 4 times then the display shows:



NOTICE

For more details see under section “Replacing the ultrapure cartridge” on page 59.

Rinsing Procedure



A fifth press on the menu-button calls the question asking if rinsing is to be carried out. A press on the enter-button confirms this and triggers the rinsing procedure. The pump starts and the rinsing solenoid valve V4 opens for the rinsing time set in the OEM-menu.

The remaining rinsing time is shown in the display during rinsing.

Neither fault messages nor measured values are displayed during rinsing.

When the rinsing procedure is finished, the system returns to the last operating state (Interval or Nonstop).



12 System control

Step	Action	Figure
1	Press the menu-button 5 times then the display shows:	 An LCD display with a green background and black text. The text reads "Rinse?" on the first line and "Press enter" on the second line.
2	Confirm rinse by pushing the enter button. The rinse cycle is carried out for 30 sec.	 An LCD display with a green background and black text. The text reads "Rinse" on the first line and "27 sec" on the second line.

Disinfection Procedure

A sixth press on the menu-button calls the question asking if a disinfection is to be carried out. A press on the enter-button confirms that a disinfection should be carried out, followed by the demand "Disinfection cartridge must be fitted". When this has been fitted, a confirming press on the enter-button triggers the disinfection procedure. The pump starts for the full time set in the OEM-menu and, when the half of this time has elapsed, the rinsing solenoid valve opens and stays open until the disinfection procedure has finished. The demand "New Filterset" is then displayed. When this has fitted, confirmation with the enter-button causes the system to return to the last operating state.

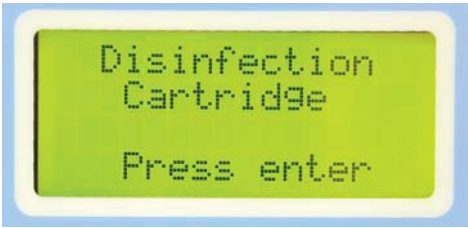
The remaining disinfection time is counted down and displayed during disinfection.

Step	Action	Figure
1	Press the menu-button 6 times then the display shows:	
2	Confirm disinfection by pushing the enter button. Change the ultrapure cartridge with the disinfection cartridge (see under chapter "Disinfection of MicroPure system" on page 61).	
3	Confirm with enter. The disinfection is carried out for 30 min, indicating the remaining time.	

NOTICE

The complete process is described under section "Disinfection of MicroPure system" on page 61.

Error history

Confirmation of this prompt with Enter allows the error storage to be looked through. Two errors, each with date and time, are shown as an example in the display. Pressing the arrow buttons takes you successively through preceding or following errors. Press the menu-button to end the error display. This takes you to the next menu prompt.

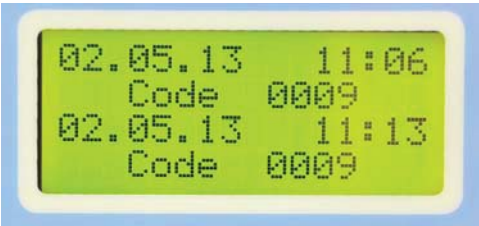
Step	Action	Figure
1	Press the menu-button 7 times then the display shows:	
2	Confirm error history by putting the enter button. Now you can see two last saved errors with date and time. The error code can be requested at the local service organization.	

Print out of Data

NOTICE

Printing is not a feature in the MicroPure systems



Entering a code number

To prevent unauthorized access to system control, settings can only be changed when a valid code number is entered and confirmed with Enter in this menu. Valid codes are found in this manual in section “Code lock” on page 51.

Press the menu-button 9 times then the display shows:



NOTICE

You can assign the permissible code numbers listed in the table on the following page to appropriate members of the staff etc. When names have been entered, tear the page out and file it where it is safe from unauthorized viewing.

NOTICE

Press the menu-button 10 times to leave the User menu and the system is back to the last System system operation that you have choose.

Code lock

To prevent unauthorized access to system control settings, changes to these settings can only be carried out when a correct code number has been entered and confirmed with Enter. In deviation to existing programs, control release can be given at three levels. Only the menu is released for changes at the first level. Both the menu and the OEM menu are released at the second level. All menus are released at the third level.

Code numbers:

No.	Menu	No.	Menu + OEM menu	No.	All levels
1	0150	4	0450	7	0750
2	0250	5	0550	8	0850
3	0350	6	0650	9	0950

OEM Menu

Basic settings and limiting values can be changed in this menu. To make such changes in the OEM-menu, the system must be unlocked first.

NOTICE

You need the right code to do this transaction. You can find the code under section “Code lock” on page 51.

Accessing the OEM menu.

Once the code is entered, simultaneous presses on the INTERVAL-button and the NONSTOP-button to enter the OEM-menu. The display shows “OEM-Menu Press enter!”. On confirming this by pressing the enter-button, the first menu point is called to be worked on. To simplify making changes, a press on the UV-button allows the position that is to be changed in a number to be selected, so that the arrow buttons can be used to replace it with any digit from 0 – 9.

A press on the menu-button takes you to the next menu prompt.

The display shows:



Set the limiting value for temperature

The maximum operating temperature limit for the system is set here. Should this temperature be exceeded, the fault message “Max. temperature” is triggered. This is shown in the 3rd line of the display.

Basic setting: 35 °C

Setting range: 1 - 50 °C

After enter the OEM menu press the menu-button once then the display shows:



Set the rinsing time

In this Menu point you can set the manually rinsing time.

Basic setting: 30 sec.

Setting range: 10 - 60 sec.

After entering the OEM menu press the menu-button twice then the display shows:



Change the disinfection time

The disinfection time can be set in this menu.

Basic setting: 30 min.

Setting range: 15- 90 min.

After entering the OEM menu press the menu-button 3 times then the display shows:



Set the interval pump time

The interval pump time is the amount of time the pump is working to recirculate water in the system. The standard setting is 5 minutes of pump recirculation for every 30 minutes that the system stands still during Interval mode. The majority of systems do not need this setting to be changed.

Basic setting: 5 min.

Setting range: 1- 30 min.

After entering the OEM menu press the menu-button 4 times then the display shows:



Set the interval rinse time

In this point you can set the rinse interval time. When the system operates in the Interval mode the system is going to be rinsing the hoses for 0.5 sec every 30 min.

Basic setting: 0.5 sec.

Setting range: 0.1- 2 sec.

After entering the OEM menu press the menu-button 5 times then the display shows:



Set the real-time clock

The real time clock can be set in this menu.

Basic setting: The actual date

Setting range: 1-12 Month, 1-31 Day, 0-24 h, 0-60 min.

After entering the OEM menu press the menu-button 6 times then the display shows:



Set the sending interval

NOTICE

Not possible for the MicroPure systems



Language selection

Basic setting: English

Setting range: German, English, French

After entering the OEM menu press the menu-button 8 times then the display shows:



Switch units, conductivity/resistance

Basic setting: Resistance $M\Omega \cdot cm$

Setting range: Resistance $M\Omega \cdot cm$, Conductivity $\mu S/cm$

After entering the OEM menu press the menu-button 9 times then the display shows:



Switch temperature compensation on/off

Basic setting: On

Setting range: On, Off

After entering the OEM menu press the menu-button 10 times then the display shows:



Printer output

NOTICE

Not possible for the MicroPure systems because the system does not have a RS232 Printer connector on the systems panel.

Maintenance

Contents

- “Maintenance intervals” on page 58
- “Replacing the ultrapure cartridge” on page 59
- “Disinfection of MicroPure system” on page 61
- “Disinfection of MicroPure with tank system” on page 64
- “Replacing the ultrafilter” on page 65
- “UV-reactor assembly” on page 68
- “Replacing the UV-lamp” on page 69
- “Replacing the final end filter (0.2µm)” on page 72
- “Autoclaving the final end filter” on page 72

Regular servicing of the unit ensures that the quality of the treated water will remain constant. To ensure that your unit is serviced properly we recommend that you obtain a maintenance contract with a service company authorized by the manufacturer. You can then be certain that your unit will have a high degree of operational reliability and dependability.

To ensure that your unit functions without any errors it must be checked, maintained and serviced at regular intervals as described in these operating instructions. The operating instructions must therefore be kept in an easily accessible location for anyone who is using or servicing the unit and its contents followed.

Calibration of the conductivity may only be performed by a service technician authorized by the manufacturer. Cleaning and disinfection of the unit should be performed annually.

Disinfection must also be performed in the event of a high bacteria content or impurities in the product water and when changing the ultrapure cartridge.



Checks or maintenance work on electrical equipment are only to be carried out by qualified electricians.

Unplug the system from the power outlet for all Maintenance work on the system.

Maintenance intervals

Consumables must be replaced in accordance with the following table. The intervals have been established for the user and depend on the actual, exact water quality and the volume of water that is used daily.

Material	Flow chart no.	Item No..	Interval	Other problems
Ultrapure cartridge	F1	09.1006	up to 12 months	Or when the pure water limit value is exceeded, whichever occurs first. Bacteria growth may occur in the resin when the unit has been in use over an extended period.
Sterile filter 0.2 µm	F2	09.1003	up to 12 months	Or the flow rate is markedly slower
Ultrafiltration membrane (UF)	F3	50133981	up to 24 months	Or if there is endotoxin breakthrough in product water or when the water flow rate is markedly slower.
UV lamp	UV1	09.2002	up to 24 months	Or the unit indicates that the UV lamp must be replaced.

Please note that the lifetime of the consumables is a direct function of the quality of the feedwater and the daily volume of water that is used.

Replacing the ultrapure cartridge

NOTICE

Replace the ultrapure cartridge when the “Lim. val.pure w.” message is displayed indicating the purity dropped below acceptable levels or when the “change cartridge” message is shown in the display.

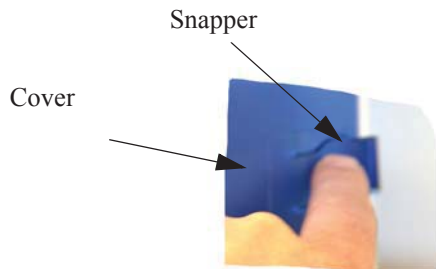
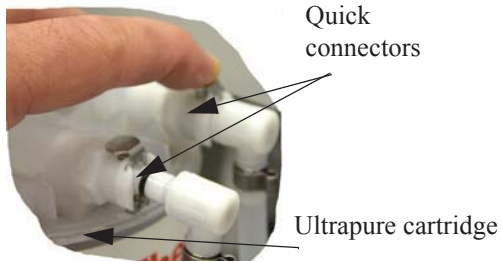
Step	Action	Figure
1	Switch the system off.	
2	Remove the cover in front of the ultrapure cartridge and press the snapper and pull the cover towards the front to remove it.	 <p>The diagram shows a close-up of a hand wearing a yellow glove. The hand is pressing a blue plastic snapper on a white plastic cover. Arrows point from the labels 'Snapper' and 'Cover' to their respective parts in the image.</p>
3	Press on the two quick connectors at the inlet and outlet of the ultrapure cartridge and remove the used cartridge.	 <p>The diagram shows a hand wearing a yellow glove. The hand is pressing two white quick connectors on a white ultrapure cartridge. Arrows point from the labels 'Quick connectors' and 'Ultrapure cartridge' to their respective parts in the image.</p>
4	We recommend performing a disinfection when an existing ultrapure cartridge is replaced.	<h3>NOTICE</h3> <p>Refer to section “Disinfection of MicroPure system” on page 61 for an explanation of how to perform disinfection.</p>
5	Locate the new ultrapure cartridge.	

Step	Action	Figure
------	--------	--------

6 Place the ultrapure cartridge in the rear section of the unit insert the two quick connectors into the ultrapure cartridge. When you hear an audible click you can be sure that the quick-action coupling have been inserted correctly..

NOTICE

The quick connectors are attached to the unit in such a manner so as to prevent any confusion (switching).

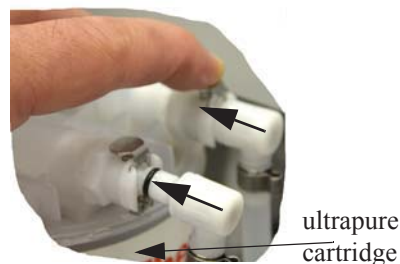

7 Put the cover for the ultrapure cartridge back in place and switch the unit on.

8

NOTICE

For this action you must have a Level 1 code. Refer to section “Entering a code number” on page 51 to read where to find this code and how to enter it.

- Keep pressing the “Menu“ button until you see “Ser. No.: Cartridge“ in the display.
- Enter the new serial number. Use the “NONSTOP and INTERVAL“ button to change the numeric values and the “UV“ button to move to the next value.
- After you have entered the serial number, confirm your entry by pressing “Enter“. The new serial number for the ultrapure cartridge is then stored. You can only use a ultrapure cartridge serial number one time.

a.)



b.)



c.)



9

NOTICE

Discard the first 5 liters.

Disinfection of MicroPure system

NOTICE

- The MicroPure system can only be disinfected as a 'stand-alone' process.
- If the system was not in operation for an extended time, a disinfection must be performed prior to continuing with routine laboratory work.

NOTICE

- Disinfection should be performed at regular intervals, such as when the ultrapure cartridge is exhausted and must be changed, or when there is bacteria contamination in the pure water.
- Depending on the model of your unit (with or without tank), a complete disinfection will take 1 to 2 hours.

Required for disinfection is a disinfection cartridge (item no: 09.1102) purchase separately. Use the following disinfecting agents for disinfection:
Cleaning Solution, 1 syringe, item no.: CMX 25

NOTICE

- To ensure effective disinfection of your system the internal 5L tank (only MicroPure with tank) must be filled completely with water.
- There is no need to worry should you notice a chlorine smell during the entire disinfection process, as there is no risk of the limit for chlorine gas in closed rooms being exceeded.



Always wear protective gloves when handling cleaning solution.



Always wear safety goggles when handling cleaning solution.

CAUTION



If your skin should come into contact with a chlorine product, rinse it immediately with ample, fresh water. If your eyes come into contact with the disinfecting agent, rinse them immediately with ample, fresh water and contact immediately a physician.

WARNING

Observe the information provided on the data sheet supplied with the CLEANING solution to avoid any health hazards.

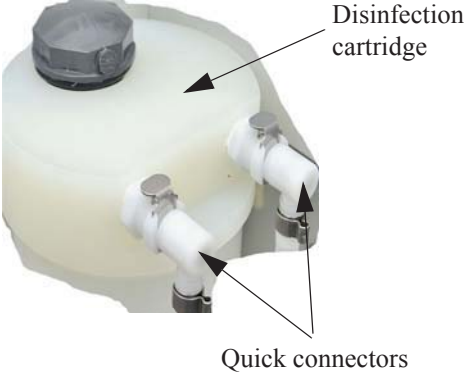
Step	Action	Figure
1	<ul style="list-style-type: none"> a. Switch the system off. b. Remove the ultrapure cartridge. (see “Replacing the ultrapure cartridge” on page 59) 	

2	<p>Place the disinfection cartridge onto the place of the ultrapure cartridge and plug in the quick connectors from the ultrapure cartridge connection. When you hear an audible click you can be sure that the quick-action coupling fasteners have been inserted correctly.</p> <p>NOTICE</p> <p>The quick connectors are attached to the unit in such a manner so as to prevent installing the ultrapure cartridge incorrectly.</p>	 <p>Disinfection cartridge</p> <p>Quick connectors</p>
---	-----------------------------------------------------------------------------------------------------------------------------------------------------------------------------------------------------------------------------------------------------------------------------------------------------------------------------------------------------------------------------------------------------------------------------------------------	------------------------------------------------------------------------------------------------------------------------------------------

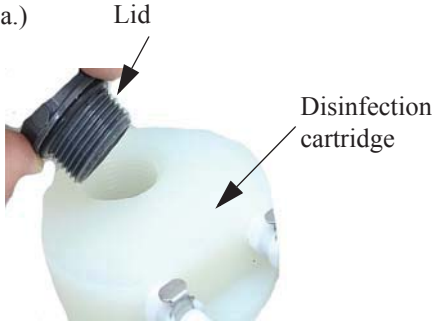
3	<div style="display: flex; justify-content: space-around; align-items: center;">   </div> <p>Always wear protective gloves and goggles when handling cleaning solution.</p> <ul style="list-style-type: none"> a. Open the Lid of the disinfection cartridge and fill the disinfection cartridge with water and pour the contents of one syringe of cleaning solution into it. b. Switch on the system, open the sampling tap, extract 1L of water and then close the sampling tap. 	<p>a.)</p>  <p>Lid</p> <p>Disinfection cartridge</p>
---	-----------------------------------------------------------------------------------------------------------------------------------------------------------------------------------------------------------------------------------------------------------------------------------------------------------------------------------------------------------------------------------------------------------------------------------------------------------------------------------------------------------------------------------------------------------------------------------------------------------------------------------------------------------------------------------	------------------------------------------------------------------------------------------------------------------------------------------

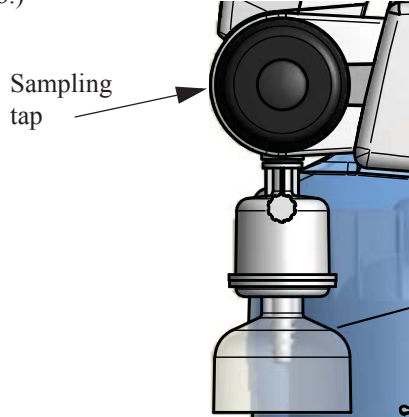
	<p>NOTICE</p> <p>There is no need to worry should you notice a chlorine smell during the entire disinfection process, as there is no risk of exceeding the limit for chlorine gas in closed rooms.</p>	<p>b.)</p>  <p>Sampling tap</p>
--	---------------------------------------------------------------------------------------------------------------------------------------------------------------------------------------------------------------	---------------------------------------------------------------------------------------------------------------------

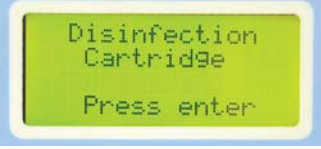
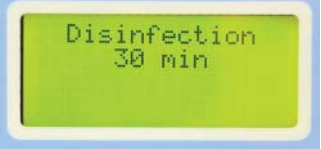
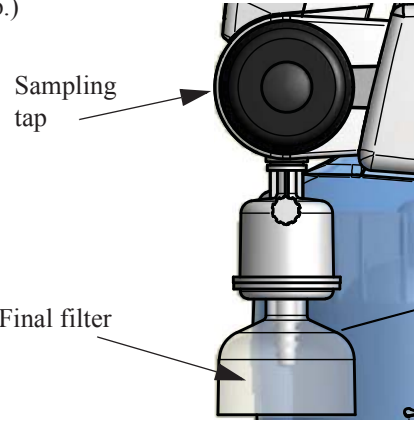
Step	Action	Figure
4	Keep pressing the “Menu” button until “Code” appears in the display and then press “Enter”.	a.) 
	<p>NOTICE</p> <p>For this action you must have a Level 1 code. Refer to section “Entering a code number” on page 51 for the code to be used for this and how to enter the code.</p>	
	<ol style="list-style-type: none"> In the user menu, press the “Menu” button to scroll to “Disinfection”. Press “Enter”. The display shows “Disinfection cartridge”. Press “Enter” to confirm that Disinfection cartridge has been installed. The disinfection process is then started. 	b.) 
	<p>NOTICE</p> <p>Disinfection is completed after 30 minutes. The remaining time is displayed.</p>	c.) 
5	<ol style="list-style-type: none"> Once the disinfection is completed switch the system off and replace the disinfection cartridge with a new ultrapure cartridge. (see “Replacing the ultrapure cartridge” on page 59) 	b.) 
	<p>NOTICE</p> <p>Empty the rest content of water from the disinfection cartridge into the drain after use.</p> <ol style="list-style-type: none"> Switch the system on again and open the sampling tap on the system and let water run out for approx 15 minutes through the final filter. Close the sampling tap after 15 minutes. Then the system is ready for new use. 	

Disinfection of MicroPure with tank system

Step	Action	Figure
1	Switch the system off.	

2



Always wear protective gloves and goggles when handling cleaning solution.

- a. Open the Lid of the internal 5 L tank and fill the tank with water and pour the contents of one syringe of cleaning solution into it.
- b. Switch on the unit, open the sampling tap, dispense 1L of water and then close the sampling tap.

NOTICE

There is no need to worry should you notice a chlorine smell during the entire disinfection process, as there is no risk of exceeding the limit for chlorine gas in closed rooms.

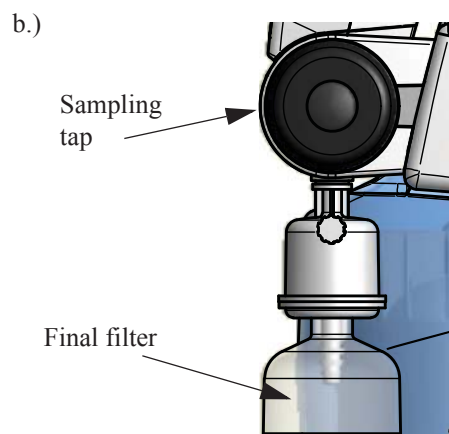
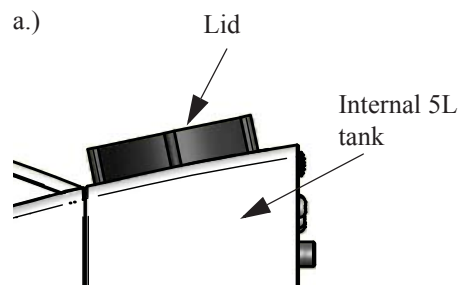

Keep pressing the “Menu” button until “Code” appears in the display and then press “Enter”.

NOTICE

For this action you must have a Level 1 code. Refer to section “[Entering a code number](#)” on [page 51](#) for the code to be used for this and how to enter the code.

- a. In the user menu, press the “Menu” button to scroll to “Disinfection”. Press “Enter”.
- b. The display shows “Disinfection cartridge”. Press “Enter” to confirm that Disinfection cartridge or Disinfection adapter has been installed.
- c. The disinfection process is then started.

NOTICE

Disinfection is completed after 30 minutes. The remaining time is displayed.

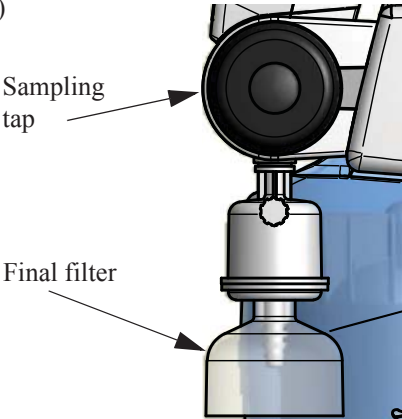

Step	Action	Figure
4	Once the disinfection is completed switch the system off and replace the old ultrapure cartridge with a new one. (see “Replacing the ultrapure cartridge” on page 59)	
5	<ol style="list-style-type: none"> Switch the system on again and open the sampling tap and drain 2 tank fillings through the final filter Close the sampling tap after draining the 2 tank contents. The system is now ready for new use. 	<p>a.)</p> 

Replacing the ultrafilter

NOTICE

You will need the following tools for replacing the ultra-filter:
Open-end wrench, size 17, Phillips screwdriver and Teflon strip.

Step	Action	Figure
1	Switch the system off and unplug from power supply.	

Step	Action	Figure
------	--------	--------

- 2
- Remove the cover from the unit.
 - Take out the ultrapure cartridge. (see “Replacing the ultrapure cartridge” on page 59)
 - Use the Phillips screwdriver to unscrew the screws from the bracket for the UV lamp and pull the UV assembly out toward the front.
 - Unscrew the threaded connection screws by hand on the d8mm/ 0.31inch fittings of the ultra-filter and pull the tubes out.

NOTICE

Ensure that the white O-rings on the d8 mm/ 0.31 inch tubes are not lost in the process. You will need these again for re-attaching the tubes.

- Pull the ultra-filter out of the mounting bracket.
- Hold the tube still attached to it with one hand while rotating the ultra-filter in a counter-clockwise direction with the other hand until the Luerlock is loosened and you can pull the ultra-filter out of the unit.
- Mark the position of the fittings before you remove them. Use the open-end wrench size 17mm/ 0.67 inch to unscrew the top and bottom fittings on the ultra-filter.

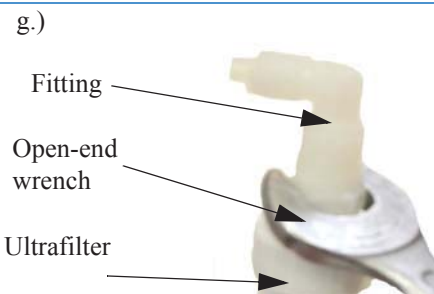
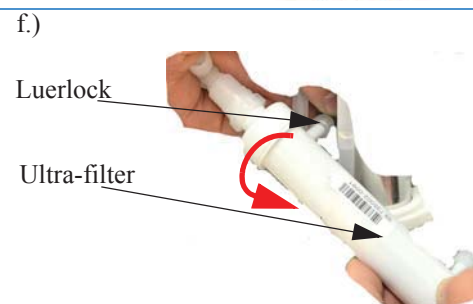
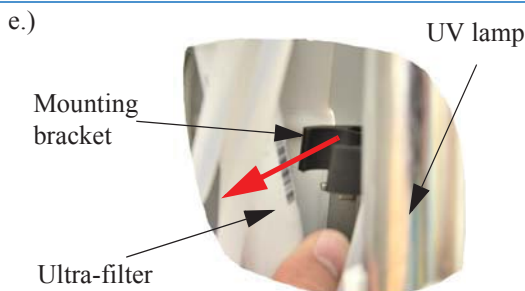
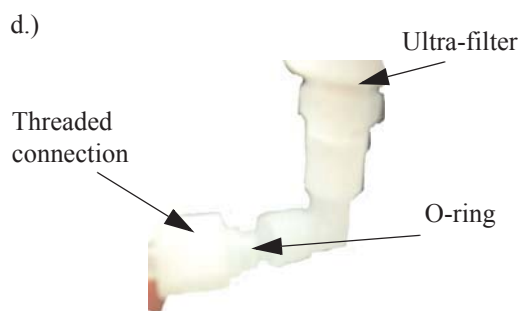
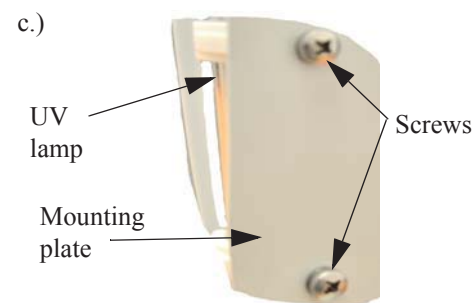

Step	Action	Figure
------	--------	--------

3

NOTICE

When you install a new ultra-filter ensure that the arrow on the filter corresponds to the direction of flow through the filter (it must point upward).

- a. Take the new ultra-filter and wrap the top and bottom threads with Teflon strip (roughly 3 times with Teflon strip around).
- b. Take the fittings that you unscrewed in step 2 g and screw them into the same position that they were in the old ultra-filter. Use the 17mm/0.67 inch open-end wrench for this.
- c. After this, rotate the Luerlock into the ultra-filter in the reverse order that you removed it (see Step 2f).
- d. Insert the tubes into the top and bottom connection for the ultra-filter and screw the fittings securely into place.
- e. Insert the ultra-filter back into the mounting bracket.
- f. Screw the UV assembly back into place (see Step 2c)

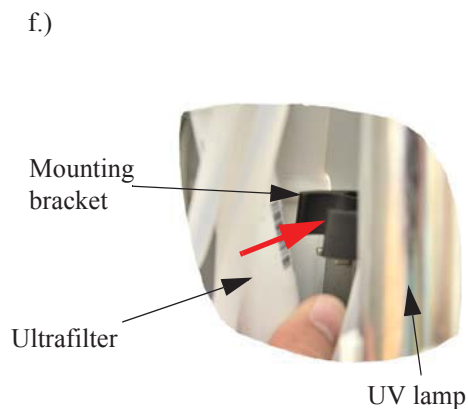
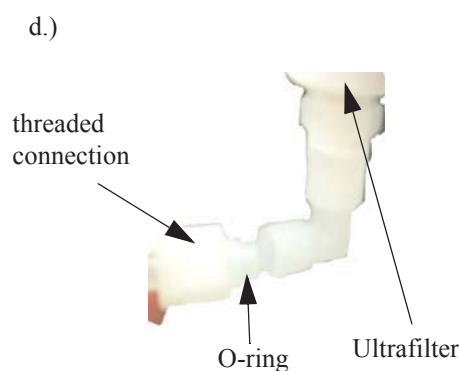
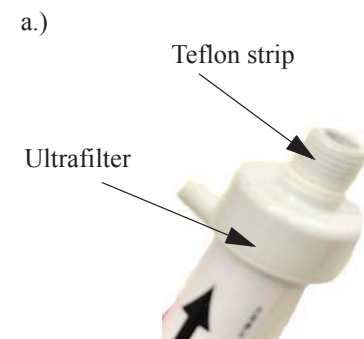

- | | |
|---|----------------------------------------------------------------------------------------------------------------------------------------------------------------------------------------------|
| 4 | Place back the ultrapure cartridge, replace the cover on the unit and switch the system on. Dispense 5 L of water and activate three rinses for the UF. (see “Rinsing Procedure” on page 47) |
|---|----------------------------------------------------------------------------------------------------------------------------------------------------------------------------------------------|

UV-reactor assembly

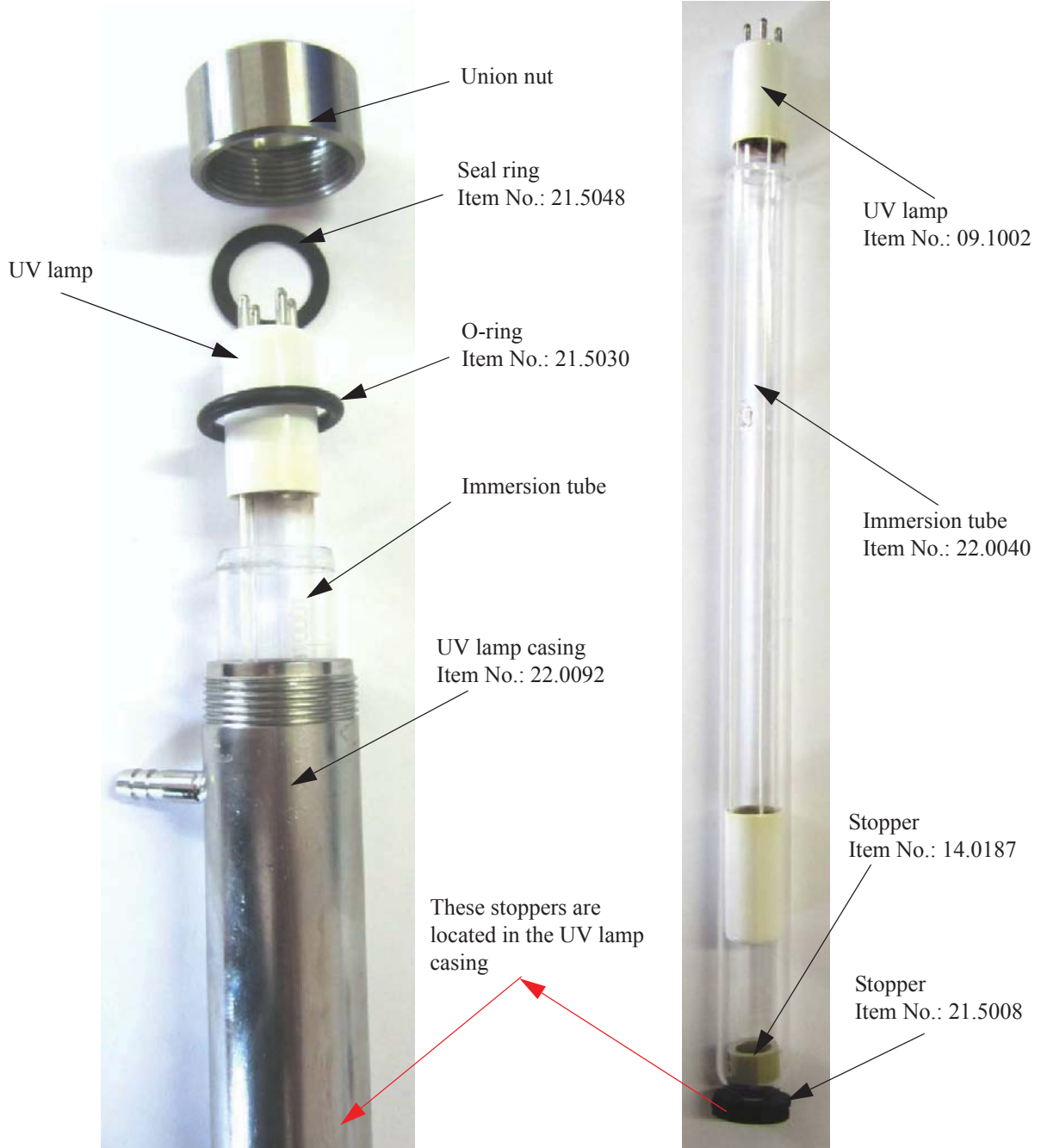

Replacing the UV-lamp

WARNING



NOTICE

Never look directly into a UV lamp when it is on. It could damage your sight.

Always wear safety gloves when changing the UV-lamp, in order to prevent that your skin comes in contact with the UV-lamp glass.

Immediately use a breathing protector, filter category FFP3, when you note that the glass of the UV-lamp is broken and ventilate the room well.

The Hg content in the UV-lamp is so low so that no damage to the environment can arise.

Contact your local service organization for proper disposal of the broken or used UV-lamp.

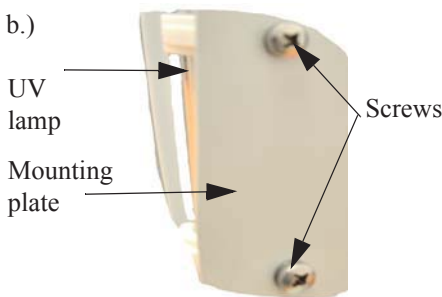
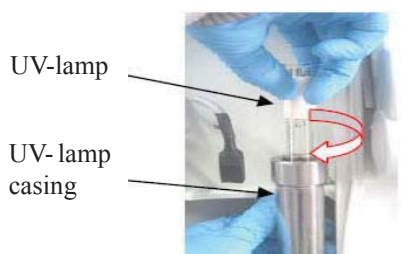
Step	Action	Figure
1	Switch the MicroPure system off.	
2	Remove the cover for the ultrapure cartridge.	
3	a. Take the ultrapure cartridge out of the unit. (see “Replacing the ultrapure cartridge” on page 59) b. Use the Phillips screwdriver to unscrew the two screws from the bracket for the UV assembly.	b.) 
4	<div style="background-color: #0056b3; color: white; padding: 5px; text-align: center; font-weight: bold; font-size: 1.2em;">NOTICE</div> To more easily remove the UV lamp in the next step, pull the UV lamp out by about 1cm while still plugged in.	
5	a. Carefully unplug the plug for the UV lamp. b. Now, carefully pull the UV lamp up while turning it slightly in a clockwise direction at the same time.	

Step	Action	Figure
------	--------	--------

6

⚠ CAUTION

When you are removing the UV lamp you must ensure that the glass of the UV lamp is not soiled or that you do not touch it with your fingers. This could impair proper functioning of the lamp. We therefore recommend that you wear clean, disposable gloves when performing this work.

⚠ CAUTION

When installing a new UV lamp ensure that the flat seal ring and the O-ring are at the correct position. The flat seal ring must fit exactly in the groove provided for it on the top of the union nut (figure 1 and 2). The O-ring fits in the bottom groove in the union nut (figure 1). If these items do not fit exactly in the grooves and you restart the unit, the UV assembly will not be leak-tight at these locations.

- a. Now, carefully rotate a new UV lamp into place by turning it in a counter-clockwise direction into the UV assembly (figure 3).
- b. You can then reattach the plug to the UV lamp and retighten the UV assembly on the mounting plate using the two retaining brackets and the two screws that you removed previously.

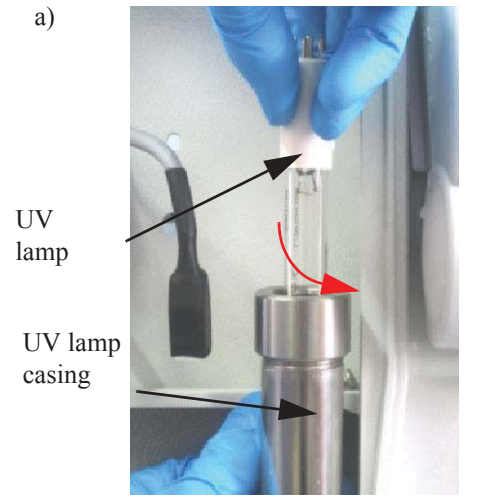
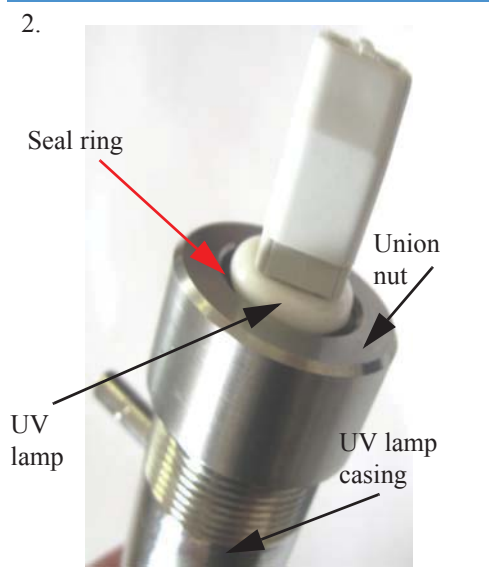
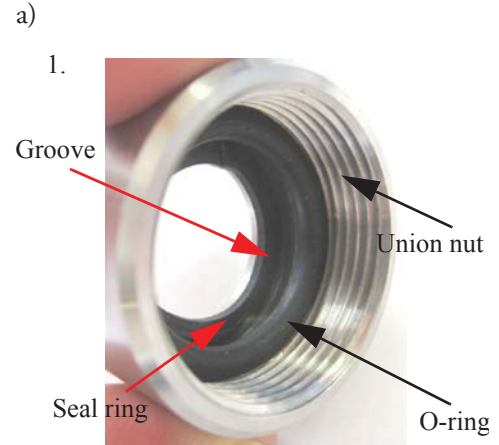

Step	Action	Figure
7	Insert the ultrapure cartridge back into the unit (see “Replacing the ultrapure cartridge” on page 59).	
8	Switch the system on.	
9		

NOTICE

For this action you must have a Level 3 code. Refer to section “Entering a code number” on page 51 to read where to find this code and how to enter it.

- c. After entering the code push the “Menu and UV” button simultaneously. The display shows “UV Menu”.
- d. Push the “Menu” button repeatedly until new UV-lamp appears and press enter to confirm. The Display shows then “Please wait”.

NOTICE

The system resets the operating hours counter of the UV-lamp.

a.)



b.)

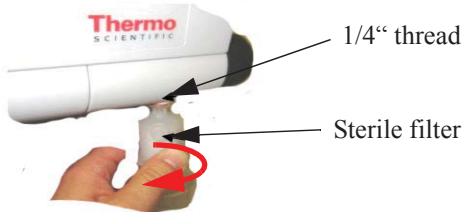

Replacing the final end filter (0.2 μ m)

Step	Action	Figure
1	Rotate the exhausted or clogged sterile filter in a clockwise position to remove it.	
2	Unpack the new sterile filter and screw it into the bottom 1/4" thread on the sampling tap.	

Autoclaving the final end filter

NOTICE

The lifetime of the sterile filter can be prolonged by sterilizing it. Proceed as follows to autoclave the sterile filter.

Step	Action	Figure
1	Rotate the used sterile filter in a clockwise direction to remove it.	
2	<p>Use an autoclave to sterilize the sterile filter in a steam autoclave at 121C° for 30 minutes. You can repeat the sterilization process for the sterile filter up to 5 times.</p> <p>When sterilization is completed, screw the sterile filter back into the 1/4" thread on the sampling tap (see “Replacing the final end filter (0.2μm)” on page 72).</p>	<h3>NOTICE</h3> <p>If you wish to remove purified water and the flow rate is too low, this is an indication that the sterile filter is clogged. In this case, read the description in section “Trouble shooting” on page 75, or replace the sterile filter with a new one.</p>

Waste disposal

NOTICE

Before returning your Thermo Scientific Barnstead Ultrapure water system for waste disposal, contact your local service organization or waste disposal company for proper disposal of the system and its components. Only specially trained personal can take the system out of operation and dispose it properly.

If you have a used or broken UV-lamp, contact your local Thermo Scientific service organization or waste disposal company.

When the packaging is no longer needed it can be disposed of as household waste.

Systems are in conformity with EEC Guideline 2011/65/EC.

The system is not to be thrown away as household waste but must be properly disposed of. It can be returned to the manufacturer for safe disposal according to EEC Guideline 2011/65/EC. We therefore request our customers in Germany and other member States in the European Economic Area to contact our local service center or our headquarters.

weee.recycle@thermofisher.com

WEEE-Reg.-no.: DE 12471402

In countries outside of the European Economic Area, please contact your local authorities or waste disposal company.

Trouble shooting

NOTICE

Contact the service department if you cannot rectify this error.

Error	Cause	Remedy
The system does not start	<ul style="list-style-type: none"> No supply of power 	<ul style="list-style-type: none"> Provide power
Dispensing not possible	<ul style="list-style-type: none"> Feedwater supply line closed or tank is empty Feedwater and rinse water connections are mixed up Feedwater pressure < 1 bar Sterile filter blocked 	<ul style="list-style-type: none"> Open the feedwater supply line or add water to tank Replace connections Increase feedwater pressure Replace the sterile filter (see “Replacing the final end filter (0.2µm)” on page 72)
Resistance < 18.0 MΩ·cm	<ul style="list-style-type: none"> Cartridge is exhausted Temperature compensation deactivated, recalibration required 	<ul style="list-style-type: none"> Check feedwater quality Activating temperature compensation ('TC' should appear in the display) Contact the service organization for calibration
Control panel non responsive	<ul style="list-style-type: none"> Microprocessor locked up PCB error 	<ul style="list-style-type: none"> Unplug the mains plug for 5 seconds. Contact the Thermo Fisher Scientific service department
Water leak	<ul style="list-style-type: none"> Leaky tubing connection Feedwater pressure > 6 bar (external tank filling station only) 	<ul style="list-style-type: none"> Check and seal the tubing connection Install a pressure reducer Contact the Thermo Fisher Scientific service department
Dispensed water flow rate is too low	<ul style="list-style-type: none"> UF-Module blocked Internal pressure too low 0.2 micron final filter is blocked Air trapped in unit 	<ul style="list-style-type: none"> Replace UF-module (see “Replacing the ultrafilter” on page 65) Readjust pressure reducer Replace the 0.2 micron final filter Dispense water at POU or rinse to purge air from the system.

Error	Cause	Remedy
Wrong time or date	<ul style="list-style-type: none"> • Time zone • Summer/winter time 	<ul style="list-style-type: none"> • Reset time and date
Wrong language	<ul style="list-style-type: none"> • Wrong language set 	<ul style="list-style-type: none"> • Correct language setting
Error message: “Limit value feed“	<ul style="list-style-type: none"> • Feedwater conductivity too high • Limiting value set too low 	<ul style="list-style-type: none"> • Check the feedwater measuring cell and deactivate in the menu • Check and reset the limiting value
Display indicates +IN	<ul style="list-style-type: none"> • Measuring cell cable break 	<ul style="list-style-type: none"> • Replace measuring cell
Error message: “Pur.limit“	<ul style="list-style-type: none"> • Ultrapure cartridge exhausted • Limiting value set too low 	<ul style="list-style-type: none"> • Replace ultrapure cartridge (see “Replacing the ultrapure cartridge” on page 59) • Check and reset the limiting value
Error message: “UV duration“	<ul style="list-style-type: none"> • UV lamp operating time has been exceeded 	<ul style="list-style-type: none"> • Replace the UV lamp (see “Replacing the UV-lamp” on page 69) • Reset the operating time counter
Error message: “max.Temperature“	<ul style="list-style-type: none"> • The temperature in the system is too high • Interval pump time too long • Limiting value set too low • Feedwater temperature too high 	<ul style="list-style-type: none"> • Switch the unit off and let it cool down • Reduce interval pump time • Check and suit the limiting value • Reduce feedwater temperature
Error message: “Measuring cell LF1“	<ul style="list-style-type: none"> • Measuring cell cable break • System control defect • Conductivity of ultra pure water outside measuring range 	<ul style="list-style-type: none"> • Replace measuring cell • Replace system control • see “Ultrapure water limiting value” on page 46
Error message: “Measuring cell LF2“	<ul style="list-style-type: none"> • Measuring cell cable break • System control defect • Feedwater conductivity outside measuring range 	<ul style="list-style-type: none"> • Replace measuring cell • Replace system control • see “Feedwater limiting value” on page 45
Error message: “Measuring cell LF3“	<ul style="list-style-type: none"> • Measuring cell cable break • System control defect 	<ul style="list-style-type: none"> • Replace measuring cell • Replace system control

Error	Cause	Remedy
Error message: “Measuring cell Temp.”	<ul style="list-style-type: none">• Measuring cell cable break• System control defect	<ul style="list-style-type: none">• Replace measuring cell• Replace system control
Error message: “change cartridge“	<ul style="list-style-type: none">• ultrapure cartridge operating time has expired	<ul style="list-style-type: none">• Replace with new ultrapure cartridge

Replacement parts

Contents

- “Replacement parts MicroPure” on page 80
- “Replacement parts MicroPure with tank” on page 82

Replacement parts MicroPure

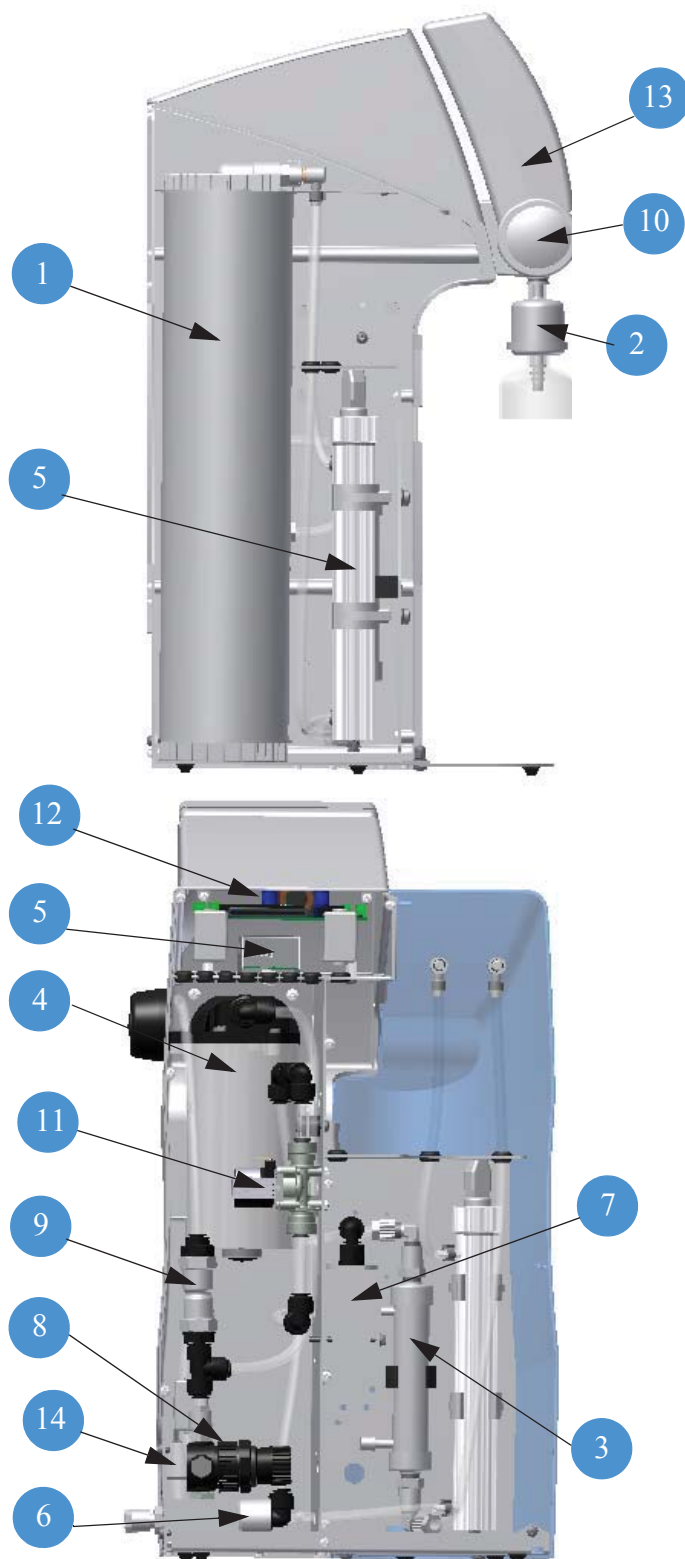

Pos.	Designation	Article number
1	Ultrapure cartridge	09.1006
2	Final end filter (sterile filter 0.2µm)	09.1003
3	Ultrafilter	50133981
4	Pressure booster pump	50149264
5	Replacement UV-lamp	09.1002
	UV-booster	50143195
6	Feedwater measuring cell	16.0126
7	Ultrapure water measuring cell with temperature sensor	50133992
8	Pressure reducer	50133985
9	Check valve	50150598
10	Dispensing valve	50133988
11	Rinsing solenoid valve	50131190
12	Control interface	50131346
13	Control CPU with LCD display	26.0025
14	Fuse holder for glass tube fuse	50143154
	Glass tube fuse, 5x20 mm, 3.15A, slow	50150714
15	Table top power pack 24V DC (not shown)	50149597

Replacement parts MicroPure with tank

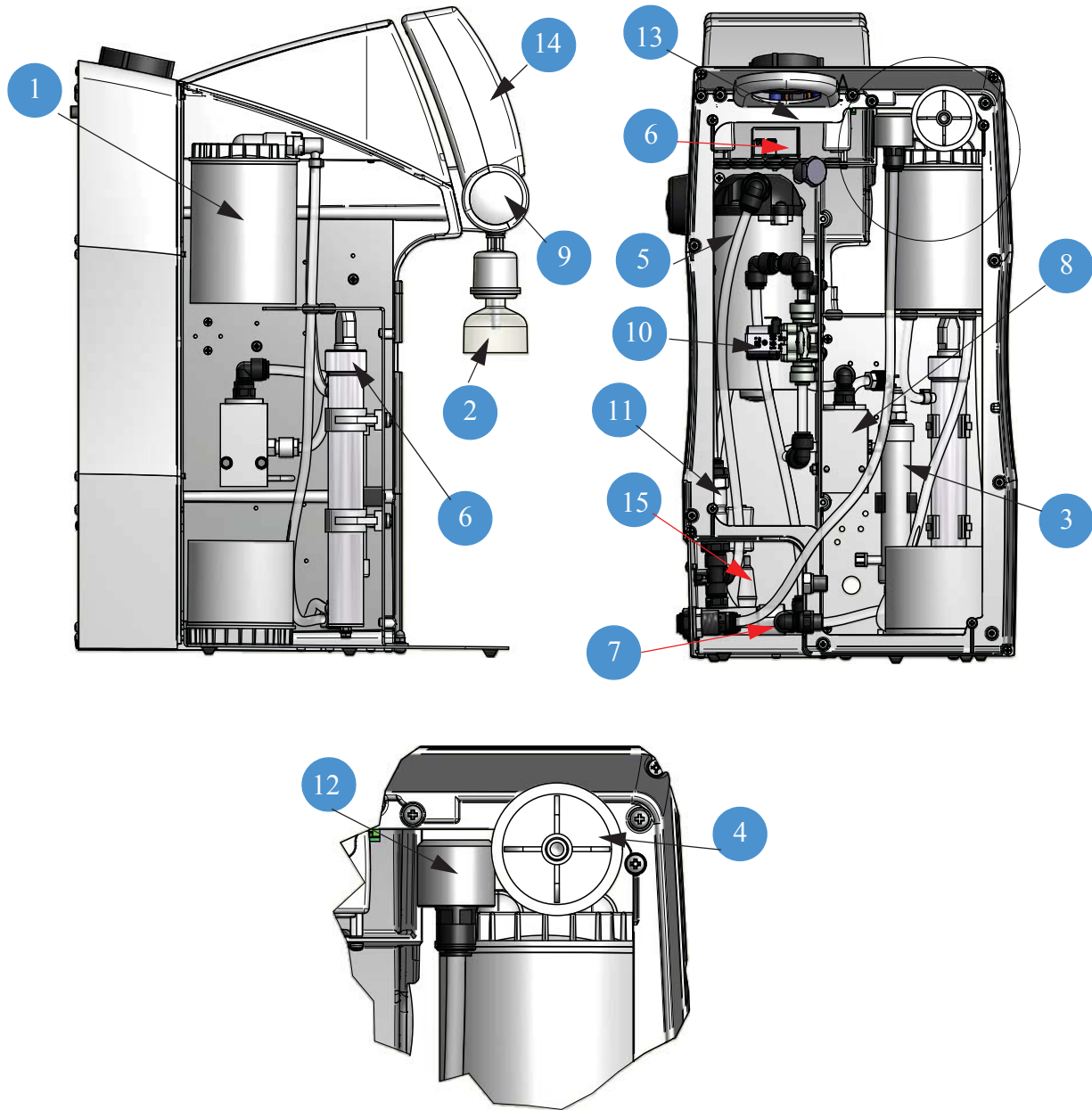

Pos.	Designation	Article number
1	Ultrapure cartridge	09.1006
2	Final end filter (sterile filter 0.2µm)	09.1003
3	Ultrafilter	50133981
4	Sterile vent filter	22.0089
5	Pressure booster pump	50149264
6	Replacement UV-lamp	09.1002
	UV-booster	50143195
7	Feedwater measuring cell	16.0126
8	Ultrapure water measuring cell with temperature sensor	50133992
9	Dispensing valve	50133988
10	Rinsing solenoid valve	50131190
11	Check valve	50150598
12	Sterile tank overflow	50148548
13	Control interface	50131346
14	Control CPU with LCD display	26.0025
15	Fuse holder for glass tube fuse	50143154
	Glass tube fuse, 5x20 mm, 3.15A, slow	50150714
16	Table top power pack 24V DC (not shown)	50149597

Consumables

Designation	Item No.
Ultrapure cartridge	09.1006
UV lamp	09.1002
Ultrafiltration module	50133981
Sterile filter 0.2 µm	09.1003
Sterile vent filter (only MicroPure with tank)	22.0091

Accessories

Designation	Item No.
Wall-mounting bracket	09.2212
Disinfection cartridge (only for MicroPure)	09.1102
Cleaning Solution, 1 syringe	CMX25

Terminal assignment

18 Terminal assignment

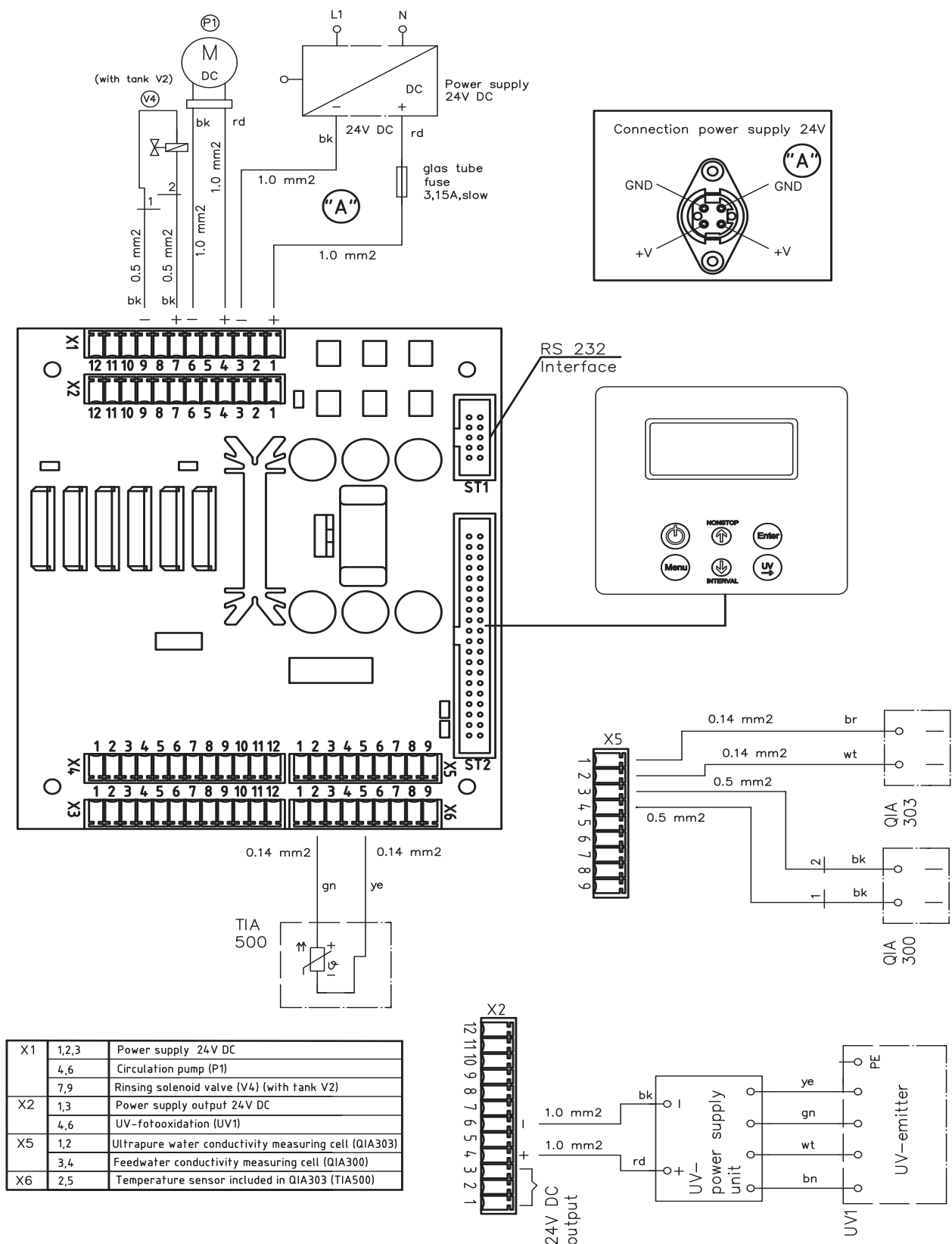

Maintenance record

Customer address:

Location:

System type:

Serial no.:

Year made:

Date	Feedwater resistance [MΩxcm]	Ultrapure water resistance [MΩxcm]	Temperature [°C]	UV-lamp operating time [h]

Ultra pure water volume flow [l/h]	Last change of ultrapure cartridge	Last cleaning / disinfection	Notes	Signature

The following points must be observed in order to ensure the quality of the system.

1x / Weekly, enter measured values.

Contact information Thermo Fisher Scientific

Contact address for service:

Overview of Thermo Scientific international sales organization

Postal address in USA:

Thermo Scientific
275 Aiken Road
Asheville, NC 28804
USA

Inquiries from USA/Canada

Sales: +1 866 984 3766

Service: +1 800 438 4851

Enquiries from Latin America

Sales: +1 866 984 3766

Service: +1 866 984 3766

Enquiries from Asia:

China

Sales: +86 10 8419 3588

Service: toll-free 1-8008105118

Support Mobile 4006505118 or +86 10 8419 3588

India

Sales: +91 22 6716 2200

Service: toll-free 1-800 22 8374 or +91 22 6716 2200

Japan

Sales: +81 45 453 9220

Service: +81 45 453 9224

Inquiries from other countries Asia/ Australia/ New Zealand

Sales: +852 2885 4613

Service: +65 6872 9720

Inquiries from countries not listed here/ other EMEA countries

Sales: +49 6184 90 6940 or +33 2 2803 2000

Service: +49 6184 90 6940

Enquiries from Europe:

Austria

Sales: +43 1 801 40 0

Service : +43 1 801 40 0

Belgium

Sales: +32 53 73 4241

Service: +32 53 73 4241

Finland/Nordic/Baltic Countries

Sales: +358 9 329 100

Service: +358 9 329 100

France

Sales: +33 2 2803 2180

Service : +33 825 800 119

Germany

Postal Address Germany:

Thermo Electron LED GmbH

Robert-Bosch-Straße 1

D - 63505 Langenselbold

Phone

Sales: toll-free 0800 1 536 376

or +49 6184 90 6940

Service: toll-free 0800 1 112110

or +49 6184 90 6940

E-mail: info.labequipment.de@thermofisher.com

Italy

Sales: +39 02 95059 341

Service: +39 02 95059 250

Netherlands

Sales: +31 76 579 5555

Service: +31 76 579 5639

Russia/CIS

Sales: +7 812 703 4215

Service: +7 812 703 4215

Spain / Portugal

Sales: +34 93 223 0918

Service: +34 93 223 0918

Switzerland

Sales: +41 44 454 1212

Service: +41 44 454 1212

UK/Ireland

Sales: +44 870 609 9203

Service: +44 870 609 9203

© 2015 Thermo Fisher Scientific Inc. All rights reserved. All trademarks are the property of Thermo Fisher Scientific Inc. and its subsidiaries. Specifications, terms and pricing are subject to change. Not all products are available in all countries. Please consult your local sales representative for details.



Index

A

- Accessibility to MicroPure system 16
- Accessories 85
- Airborne sound emission 16
- Ambient conditions 16
- Autoclave
 - Final filter 72
- Autoclaving the final end filter 72
- Available MicroPure systems 9
- Available MicroPure with tank systems 9

C

- Change the disinfection time 53
- Code lock 51
- Complaints 2
- Connections of the MicroPure system 20
- Consumables 85
- Contact information Thermo Fisher Scientific 91
- Control menu flow diagram 39

D

- Description of control display 38
- Dimensions and weight MicroPure with tank 13
- Dimensions and weight of MicroPure 15
- Disinfection of MicroPure system 61
- Disinfection of MicroPure with tank system 64
- Disinfection Procedure 49
- Dispensing water from Dispensing valve 35

E

- Electrical connections 15
- Entering a code number 51
- Error history 50
- Examination on receipt 2
- Explanatory notes on the operating instructions iii
- Extend of delivery 7
- Extend of delivery MicroPure with tank 8
- Extent of delivery MicroPure 8

F

- Feedwater limiting value 45
- Feedwater requirements 13
- Final
 - Autoclave 72
- Flow chart 29

G

- General information 42

H

- How the MicroPure system functions 31

I

- Illustration of drain 25
- Initial start up 33
- Installation 19
- Intended Use 11
- Interval operating mode after switching on 42
- Interval operation 43

L

- Language selection 55
- Legal Information i

M

- Maintenance 57
- Maintenance record 89
- Materials of parts which contact water 15
- Mounting the power pack (voltage supply) 27

N

- Non-stop mode 43

Index: O

O

- OEM Menu 52
- OFF mode 44
- Operating Elements 37
- Operating modes 42

P

- Packaging for return shipment 2
- Preface i
- Print out of Data 50
- Printer output 55
- Product water quality ASTM Type I 13
- Putting system into operation 34

R

- Replacement parts 79
- Replacement parts MicroPure 80
- Replacement parts MicroPure with tank 82
- Replacing the final end filter (0.2µm) 72
- Replacing the ultrafilter 65
- Replacing the ultrapure cartridge 59
- Replacing the UV-lamp 69
- Rinsing Procedure 47

S

- Safety precautions 3
- Set the interval pump time 53
- Set the interval rinse time 54
- Set the limiting value for temperature 52
- Set the real-time clock 54
- Set the rinsing time 53
- Set the sending interval 54
- Standards and directives iv
- Start your MicroPure system into operation 22
- Switch temperature compensation on/off 55
- Switch units, conductivity/resistance 55
- System control 41

T

- Technical Specification 13
- Terminal assignment 87
- The Installation area 17
- Transport and packaging 1
- Trouble shooting 75

U

- Ultrapure cartridge operating hours counter 47
- Ultrapure water limiting value 46
- Unintended use 11
- User menu 45

- UV-Lamp 44
- UV-Lamp operating time and intensity 47
- UV-reactor assembly 68

V

- Venting the sterile filter 35

W

- Wall Mounting 26
- Warranty i
- Waste disposal 73
- Water connections 15



Index

Index:



thermoscientific.com

© 2016 Thermo Fisher Scientific Inc. All rights reserved. All trademarks are the property of Thermo Fisher Scientific Inc. and its subsidiaries. Specifications, terms and pricing are subject to change. Not all products are available in all countries. Please consult your local sales representative for details.

Thermo Fisher Scientific
1214 Oakmead Parkway
Building 10
Sunnyvale, CA 94085
BRXXXXX_E 01/14W

Thermo
SCIENTIFIC
A Thermo Fisher Scientific Brand