



Ultra-Low Temperature Freezers Revco™ RDE Series, Forma™ FDE Series, HERAfreeze™ HDE Series and Thermo Scientific™ TDE Series

Installation and Operation

329712H01 • Revision B • October 2019

IMPORTANT Read this instruction manual. Failure to follow the instructions in this manual can result in damage to the unit, injury to operating personnel, and poor equipment performance.

CAUTION All internal adjustments and maintenance must be performed by qualified service personnel.

Material in this manual is for informational purposes only. The contents and the product it describes are subject to change without notice. Thermo Fisher Scientific makes no representations or warranties with respect to this manual. In no event shall Thermo be held liable for any damages, direct or incidental, arising from or related to the use of this manual.

© 2019 Thermo Fisher Scientific Inc. All rights reserved.

Contents

Models.....	1
Safety Considerations	2
Unpacking	3
Packing List	3
General Recommendations.....	4
Temperature Monitoring	4
General Usage	4
Initial Loading	4
Battery Door Opening/Closing.....	4
Operating Standards.....	5
Electrical Specifications	5
Installation.....	6
Location	6
Leveling.....	6
Backup System (Optional)	6
Super Insulated Cabinet Construction	6
Door Operation	6
Pressure Equalization Port.....	7
Installing the Remote Alarm Connector.....	7
Intended Use.....	7
Operation.....	8
Initial Start Up.....	8
Operation Overview	8
Display	8
Settings.....	9

Power Down	10
Backup System (Optional).....	11
CO2 and LN2 Precautions	11
Installation	11
Start Up	12
Operation.....	12
Chart Recorders (Optional).....	13
Set Up and Operation	13
Changing Chart Paper.....	13
Calibration Adjustment	13
Maintenance	14
Cleaning the Condenser.....	14
Cleaning the Condenser Filter.....	14
Gasket Maintenance	14
Defrosting the Freezer	14
Battery Maintenance	14
Maintenance Schedule.....	15
Troubleshooting Guide.....	16
Error Codes	19
Warranty	20
Warranty (International)	21
Appendix A: Alarm Summary	22
WEEE Compliance	24
Contact Information	25

Models

Table 1. Applicable Models

Brand - Model	Size (xxx)	Voltage (*)
Forma - FDExxx86F*	300/400/500/600	A/D/V
Thermo Scientific –TDExxx86F*	300/400/500/600	A/D/V
HERAfreeze – HDExxx86F*	300/400/500/600	A/D/V
Revco - RDExxx86F*	300/400/500/600	A/D/V

Safety Considerations

In this manual, the following symbols and conventions are used:



This symbol used alone indicates important operating instructions which reduce the risk of injury or poor performance of the unit.



CAUTION: This symbol, in the context of a CAUTION, indicates a potentially hazardous situation which if not avoided could result in minor to moderate injury or damage to the equipment.



WARNING: This symbol indicates potentially hazardous situations which, if not avoided, could result in serious injury or death.



WARNING: This symbol indicates situations where dangerous voltages exist and potential for electrical shock is present.



The snowflake symbol indicates extreme low temperatures and high risk of frostbite. Do not touch bare metal or samples with unprotected body parts.



This symbol indicates a need to use gloves during the indicated procedures. If performing decontamination procedures, use chemically resistant gloves. Use insulated gloves for handling samples and when using liquid nitrogen.



Before installing, using or maintaining this product, please be sure to read this manual and product warning labels carefully. Failure to follow these instructions may cause this product to malfunction, which could result in injury or damage.

Below are important safety precautions that apply to this product:



Use this product only in the way described in the product literature and in this manual. Before using it, verify that this product is suitable for its intended use. If this equipment is used in a manner not specified by the manufacturer, the protection provided by the equipment may be impaired.



Do not modify system components, especially the controller. Use OEM exact replacement equipment or parts. Before use, confirm that the product has not been altered in any way.



WARNING: Your unit must be properly grounded in conformity with national and local electrical codes. Never connect the unit to overloaded power sources.



WARNING: Disconnect the unit from all power sources before cleaning, troubleshooting, or performing other maintenance on the product or its controls.



WARNING: "Caution, risk of fire". This unit is charged with hydrocarbon refrigerants.

EMC

EMC Registration is done on this equipment for business use only. It may cause interference when the product would be used in home.

사용자 안내문 이 기기는 업무용 환경에서 사용할 목적으로 적합성평가를 받은 기기로서 가정용 환경에서 사용하는 경우 전파간섭의 우려가 있습니다.

This equipment has been tested and found to comply with the limits for a Class A digital device. Class A covers devices for usage in all establishments other than domestic and that are not directly connected to a low voltage power supply network, which supplies domestic environment.

This ISM device complies with Canadian ICES-001.

FCC

This equipment has been tested and found to comply with the limits for a Class A digital device, pursuant to part 15 of the FCC Rules. These limits are designed to provide reasonable protection against harmful interference when the

equipment is operated in a commercial environment. This equipment generates, uses, and can radiate radio frequency energy and, if not installed and used in accordance with the instruction manual, may cause harmful interference to radio communications. Operation of this equipment in a residential area is likely to cause harmful interference in which case the user will be required to correct the interference at his own expense.

Unpacking

At delivery, examine the exterior for physical damage while the carrier's representative is present. If exterior damage is present, carefully unpack and inspect the unit and all accessories for damage.

If there is no exterior damage, unpack and inspect the equipment within five days of delivery. If you find any damage, keep the packing materials and immediately report the damage to the carrier. Do not return goods to the manufacturer without written authorization. When submitting a claim for shipping damage, request that the carrier inspect the shipping container and equipment.

The packaging can be stored and re-used.

Packing List

Inside the freezer cabinet is a bag containing:

- A handle lock key
- A USB drive with user manual, including translated versions
- Certificates of conformance and calibration
- A remote alarm contact connector
- Posts for rear spacing

If you have ordered a chart recorder, the bag will also contain:

- Recorder installation instructions
- Extra paper

If you have ordered a backup system, the cabinet will also contain:

- A hose assembly
- English and metric connectors

If specified on the order, the bag may also include:

- A QC temperature graph and test log
- Calibration information

General Recommendations

Temperature Monitoring



IMPORTANT NOTE: Thermo Fisher Scientific recommends the use of a redundant and independent temperature monitoring system so that the freezer can be monitored continuously for performance commensurate with the value of product stored.

General Usage

This refrigeration system is designed to maintain ultra-low temperatures with safety in an ambient environment within 15°C to 32°C (59°F to 90°F), only when the freezer is used for storage.



WARNING: This unit is not a “rapid-freeze” device. Freezing large quantities of liquid, or high-water content items, will temporarily increase the chamber temperature and will cause the compressors to operate for a prolonged time period.

Avoid opening the door for extended time periods since chamber temperature air will escape rapidly. Also, keep the inner doors closed as much as possible. When room air, which is higher in humidity, replaces chamber air, frost may develop in the chamber more rapidly.

Initial Loading

Allow the freezer to operate at the desired temperature for a minimum of 12 hours before loading.

Load the freezer one shelf at a time, beginning with the top shelf. After loading each shelf, allow the freezer to recover to the desired set point before loading the next shelf. Repeat this process until the freezer is fully loaded.



CAUTION: Failure to follow these procedures or overloading the unit may cause undue stress on the compressors or jeopardize user product safety.

Battery Door Opening/Closing

To open the grille door, pull the door from the top right corner as shown in the figure below.

To close the grille door, push the door against frame to hold latch in position.



Figure 1. Door Opening

Operating Standards

The freezers described in this manual are classified for use as stationary equipment in a Pollution Degree 2 and Over voltage Category II environment.

These units are designed to operate under the following environmental conditions:

- Indoor use
- Altitude up to 2000 m
- Maximum relative humidity 60% for temperatures within 15°C to 32°C (59°F to 90°F)
- Main supply voltage fluctuations not to exceed $\pm 10\%$ of the nominal voltage for 115 V/60 Hz & 230 V/50 Hz.
- Main supply voltage fluctuations not to exceed -10% or +6% of the nominal voltage for 208-230 V/60 Hz.

Table 2. Electrical Specifications by Size and Voltage

600D	208-230 V	60 Hz	6.2 A
600V	230 V	50 Hz	6.1 A

*Values subject to change

Electrical Specifications

The last character in the model number listed on the data-plate identifies the electrical specifications for your unit. Specific unit current rating is listed on the data-plate.

The voltage types are A, D and V as specified in the following table:

Table 2. Electrical Specifications by Size and Voltage

Size/ Voltage	Voltage	Frequency	Current*
300A	115 V	60 Hz	12.6 A
300D	208-230 V	60 Hz	5.6 A
300V	230 V	50 Hz	5.9 A
400A	115 V	60 Hz	13.0 A
400D	208-230 V	60 Hz	5.9 A
400V	230 V	50 Hz	5.3 A
500A	115 V	60 Hz	12.5 A
500D	208-230 V	60 Hz	5.0 A
500V	230 V	50 Hz	5.9 A
600A	115 V	60 Hz	12.7 A

Installation



WARNING: Do not exceed the electrical rating printed on the data plate located on the lower left side of the unit.

Location

Install the unit in a level area free from vibration with a minimum of 8" (20 cm) of space on the top and sides, 6" (15 cm) in back. Refer to **Leveling** for further instructions on leveling cabinets. Allow enough clearance so that door can swing open at least 85°.

The rear spacing posts provided with the freezer can be used to ensure proper clearance. To install the spacing posts, screw them into the back side of the unit, in the rear deck area.

Do not position the equipment in direct sunlight or near heating diffusers, radiators, or other sources of heat. The ambient temperature range at the location must be 15°C to 32°C (59°F to 90°F).

Wiring



CAUTION: Connect the equipment to the correct power source. Incorrect voltage can result in severe damage to the equipment.



CAUTION: For personal safety and trouble-free operation, this unit must be properly grounded before it is used. Failure to ground the equipment may cause personal injury or damage to the equipment. Always conform to the National Electrical Code and local codes. Do not connect the unit to overloaded power lines.



CAUTION: Do not position the unit in a way that impedes access to the disconnecting device or circuit breaker in the back of the unit.



CAUTION: Always connect the freezer to a dedicated (separate) circuit. Each freezer is equipped with a service cord and plug designed to connect it to a power outlet which delivers the correct voltage. Supply voltage must be within $\pm 10\%$ of the freezer rated voltage for 115 V/60 Hz & 230 V/50 Hz. Supply voltage must be within -10% to $+6\%$ of the freezer rated voltage for 208-230 V/60 Hz. If cord becomes damaged, replace with a properly rated power supply cord.

Table 3. Power Cord Specification

Model	Power Cord Specification
A	3-G 12 AWG, NEMA 5-20P, 20A/125V
D	3-G 12 AWG, NEMA 6-15P, 15A/250V
V	3-G 1.5 mm ² , CEE 7/7, 16A/250V



CAUTION: Never remove or disable the grounding prong from the service cord plug. If the prong is removed, the warranty is invalidated.

Leveling

Make sure that the floor is level. The unit must be level both front to back and side to side.

The 300 and 400 box capacity models are equipped with one or two leveling legs on the right hand side. Leveling legs on 300 size must be used as a safety precaution.

Ensure to lock the brakes for units equipped with casters.

Backup System (Optional)

If you are using a CO₂ or LN₂ backup system, refer to **Backup System (Optional)** for installation and operation instructions.

Super Insulated Cabinet Construction

In all models, the cabinet walls have a vacuum insulation core encapsulated by a sealed film laminate.



CAUTION: Never drill holes in or near the cabinet walls. Drilling could damage the insulation and make the unit inoperable.

Door Operation

Upright freezer models are equipped with an advanced assembly specifically designed for ultra-low temperature freezers.

Features include:

- One-hand operation
- A front-accessible lock

- Hasps for a standard padlock to provide additional security. Length of the shackle must be between 3/4" (1.9 cm) and 1 1/2" (3.8 cm)
- Durable construction for reliable operation and safe product storage
- Door ramp alignment feature



CAUTION: When moving the freezer, always grasp cabinet surfaces; never pull the freezer by the latch handle.

Opening the Door

1. Remove the padlock if installed.
2. Grasp the latch handle and pull it toward yourself until the latch disengages.
3. Keep pulling by the latch handle to open the main door.

Closing the Door

Note: The latch does not self-engage automatically when you close the door. You must rotate the latch into the open position first.

1. Grasp the latch handle and pull it toward yourself, rotating the latch into the open position.
2. Move the freezer door into the closed position and gently push the handle away from you, making sure that the latch engages fully with the cabinet strike.
3. Keep applying gentle pressure to the latch handle until the latch is securely in closed position.
4. Insert the key and rotate counterclockwise to lock.
5. Replace the padlock as required.

Pressure Equalization Port

When an upright ultra-low temperature freezer door is opened, room temperature air rushes into the storage compartment. When the door is closed, the fixed volume of air is cooled rapidly. Pressure drops below atmospheric pressure, resulting in a substantial vacuum. Re-entry into the cabinet is impossible until internal pressures are returned to atmospheric pressure. Without a pressure equalization mechanism, it can take, in extreme cases, several hours before the door can easily be reopened.

All upright models feature a port that provides vacuum relief after door openings. The pressure equalization port is located in the door behind the eye-level panel on the front of the freezer. Although the port is heated and designed to self-defrost, excessive frost accumulation on the inner door could

eventually restrict air flow. Therefore, you should periodically inspect the inner door and brush away any loose frost using a stiff nylon brush.

Installing the Remote Alarm Connector

The remote alarm contacts are located on the back of the freezer above and to the left of the power switch. After installing the wiring from the remote alarm to the connector, install the connector to the freezer micro-board.

The pin configuration is shown in Figure 2 below.

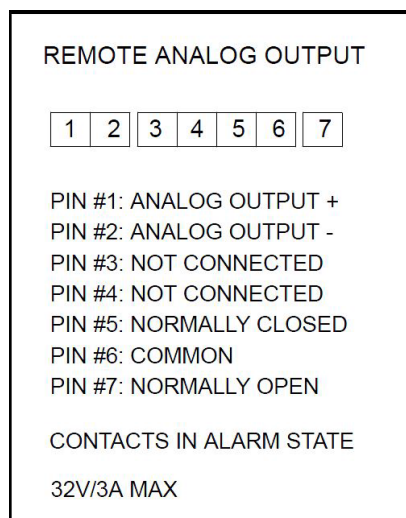

Figure 2. Remote Alarm Pin Configuration

For systems that alarm in closed state, connect to pins 5 & 6.

For systems that alarm in open state, connect to pins 6 & 7.

The contacts will trip in the event of a power outage, high temperature alarm, low temperature alarm or door ajar alarm.

Intended Use

The -86°C freezer (refer to **Models** for the specific model series) described in this manual are high performance units for professional use. These products are intended for use as cold storage in research use and as a general purpose laboratory freezer, storing samples or inventory at operating temperatures between -50°C and -80°C .

It is not considered a medical device and has therefore not been registered with a medical device regulatory body (e.g., FDA): that is, it has not been evaluated for the storage of samples for diagnostic use or for samples to be re-introduced to the body.

This unit is not intended for use in classified hazardous locations, nor to be used for the storage of flammable inventory.

Operation

Initial Start Up

To start the freezer, complete the following steps:

1. Plug the freezer into the power outlet.
2. Turn the power switch ON. You can find the switch in back of the freezer, on the bottom right.
3. Once the freezer is turned ON, the user interface will begin a start up procedure. Once ready for operation, the temperature is displayed on the screen.

Operation Overview

Once you have successfully completed the initial start up procedures, the freezer starts operating normally and the only actions required are:

- Setting the operating and alarm set points.
- Activating the CO₂ or LN₂ backup system if installed. For instructions on backup settings and activating the system, refer to **Backup System (Optional)**.

Display

The display screen below is the default screen.

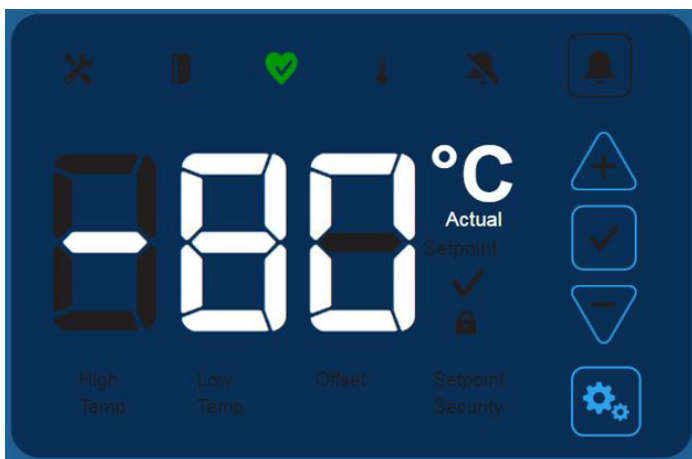











Figure 3. Display

The control panel consists of the 5 touch-point buttons located on the right side of the display.

1.  **Alarm Bell** – This icon indicates visual and audible alarm that accompanies various alarm states. Pressing the alarm bell while in an alarm state will snooze the audible alarm for 10 minutes.
2.  **Plus** – Increases the value of the selected setting.
3.  **Check Mark** – Saves a change to the selected value.
4.  **Minus** – Decreases the value of the selected setting.
5.  **Settings** – The settings icon represents the various settings including:

- Warm Alarm value - The range of the warm alarm temperature is -40°C to within 5°C of setpoint.
Note : The warm alarm will be disabled for 12 hours from a warm start condition.
- Cold Alarm value - The range is -99°C to within 5°C of setpoint.
Note : A setpoint change may automatically change the warm/cold alarm setpoints as well to maintain a minimum 5°C separation from the control setpoint.
- **Offset value** - This is used for calibration. Range is -10°C to $+10^{\circ}\text{C}$. Default is 0.
Entering a positive offset value will yield a colder cabinet temperature.
Entering a negative offset value will yield a warmer cabinet temperature.
- **Setpoint security code** – This code is a 3-digit numeric code. Refer to **Setpoint Security**.
- **Backup system type** (if backup system is installed) – Set the type to either LN₂ or CO₂ corresponding to the backup system that is installed.
- **Backup system setpoint** (if backup system is installed) - This setpoint indicates the temperature at which the backup system will begin cooling the cabinet. It is recommended to set the backup system setpoint at a minimum of 10°C warmer than the control setpoint. For more information, refer to **Backup System (Optional)**.

The message panel on the top indicates freezer health status and the various alarm or warning states.

1.  **Wrench** – This is a generic service warning which corresponds to an intermittent flashing error code displayed on the screen. Refer to **Error Codes** for a list of error codes.
2.  **Door** – This icon will illuminate during a door ajar alarm. A door open for more than 3 minutes will result in an audible door ajar alarm.
3.  **Heart** – The heart is the health status for the freezer. A green heart indicates normal freezer operation. In an alarm state, this icon is not illuminated.
4.  **Thermometer** – This indicates when the cabinet temperature exceeds either warm alarm or cold alarm setpoints and the audible alarm will occur.
5.  **Snooze Bell** – This is only illuminated during an active alarm that has been silenced by the user.

Settings

If setpoint security is enabled, you must first enter the security code to make any setpoint changes. Refer to **Setpoint Security** to adjust setpoint security.

Control Setpoint

To modify the control temperature setpoint:

- Press the plus or minus button while displaying unit temperature (“Actual” is illuminated). The control setpoint is displayed
- Adjust setpoint to desired temperature
- Select the checkmark button to save the new control setpoint.

Other Setpoints and Settings

- Press the settings button to enter Settings menu
- Continue pressing the settings button until the desired setting is illuminated on lower horizontal panel. (If backup system is installed, CO₂ or LN₂ is displayed after pressing the settings button 5 times.)
- Adjust the setting to desired temperature or value using the plus or minus buttons

- Press the checkmark button to save the new temperature or value
- After the value is saved, display will show the next option in the settings menu.

To return to the unit temperature display:

- Press the settings button until unit temperature is displayed (“Actual” is illuminated)
- If there is no activity after 5 minutes, the unit will automatically return to the temperature display.

Warm Alarm Test

Press the plus and checkmark buttons at the same time to initiate the warm alarm test. During the warm alarm test, the actual cabinet temperature will not be displayed. The display temperature will increase. Once the display temperature reaches the warm alarm setpoint, the alarm is activated. After 5 seconds, the test will automatically end and the display will return to the actual cabinet temperature.

Setpoint Security

- To adjust setpoint security in the settings menu, press the settings button 4 times
- The setpoint security code consists of 3 digits, each of which must be set in sequence from left to right
- Use the plus or minus button to adjust each value, and the checkmark button to save each value of the 3-digit security code



- If you forget the setpoint security code, contact customer support.

Power Down

To power down the ULT, first turn the breaker switch, located at the rear of the freezer, to the off position. Once the switch is in the off position, the display will show “OFF” followed by “YES” and then “NO” in 2 second intervals. The checkmark will also be illuminated while “YES” and “NO” are showing. Press the checkmark while “YES” is showing. With a flashing “YES”, you are required to confirm by pressing the checkmark button a second time. Power down will then be complete.

If the checkmark button is pressed while “NO” is illuminated or if no action is taken for 5 minutes, this is interpreted as a power failure. In this case, the user interface will stay on (using battery power only) and an audible alarm will sound to indicate power failure. If installed, the backup system will remain active and inject per the backup system settings.

Backup System (Optional)

For all ultra-low temperature cold storage products, we recommend the use of a backup system (BUS) for the security of your samples.

When you purchase a built-in CO₂ or LN₂ optional backup system for the freezer, backup control is integrated into the main user interface.

Note: For stand-alone backup systems, refer to installation instructions provided with the backup system kit.



Note: Always purchase the cylinders which are equipped with siphon tubes for withdrawing liquid from the bottom of the cylinder. CO₂ cylinders must be kept at room temperature to function properly. LN₂ bottles are functional at any reasonable temperature.



CAUTION: When closing the cylinder valve, make sure that the injection solenoid is energized to allow all the liquid to bleed off instead of being trapped in the supply hose. Failure to do this results in activation of the pressure relief device, which could damage the freezer and requires replacing if it is activated.



CAUTION: For models ordered with factory installed built-in backup systems, the flow of liquid CO₂ or LN₂ will be discontinued if the door is opened during operation of the backup system. For units operated with free-standing, field installed type backup system, the flow of liquid CO₂ or LN₂ will be discontinued upon door opening only if the switch provided with the free-standing package is installed on the freezer.

CO₂ and LN₂ Precautions

The following are precautions for using liquid CO₂ and LN₂ backup systems.



WARNING: If a CO₂ or LN₂ cylinder falls and a valve is knocked off, the cylinder becomes a deadly and completely unguided missile. Transport the cylinders in a hand-truck or cart with secure chain ties for the cylinder. After cylinders are connected to the equipment, securely attach them with chains to a solid stationary object such as a building column.



WARNING: CO₂ and LN₂ liquids are non-poisonous but are very cold and will burn unprotected skin. Always wear protective eye wear and clothing when changing cylinders or working on the piping systems attached to an active source of liquid refrigerant.



WARNING: The gases produced by evaporation of CO₂ or LN₂ are non-poisonous but displace the oxygen in a confined space and can cause asphyxiation. Do not store the cylinders in subsurface or enclosed areas.

Installation

Field installed systems are supplied with complete installation and operating instructions. If your system is factory installed, the freezer is shipped with a coiled length of hose to connect the freezer to the bottles:

- 1/4" Flexible Hose with fittings for connection to the CO₂ supply.
- 1/2" Flexible Hose with fittings for connection to the LN₂ supply.

To install,

1. Straighten the coiled hose.
2. Connect one end to the labeled connection on the freezer.
- Tighten the nut two flats past finger tight, approximately 120 degrees.

Note: For CO₂, remove the threaded fitting from the nut on the end of the copper tubing to access nut for connection to the freezer. Discard the threaded fitting.

3. Attach the other end to the supply bottle or building supply fitting.
- For CO₂:
 - Remove Nipple from adapter (NPT Connection). Remove cable tie to release alternative nut and washer. Ensure the correct nut fitting is supplied over the nipple (US or European).

- Add 2 wraps of Teflon tape clockwise to the 1/4" NPT fitting (on the nipple) when viewed from the threads. Tighten the NPT fittings approximately 2 turns from finger tight (approximately 720°).

Note : The top of the nipple has a hex configuration, allowing for use of a wrench when the nut is pulled down.

- Add washer to nipple inside of nut (unless CO₂ supply has a built in washer).

Note : Small raised area of washer fits into groove of nipple. The washer will feel snug when trying to shift side-to-side on nipple. The washers are designed for a limited number of attachments/disconnections from the supply and may wear over time. If washer appears worn and causes CO₂ leakage, replace washer (Part Number 45705H03).

- Wrench tighten the supply nut to the supply.
- For LN₂:
 - Attach the fitting to the supply and wrench tighten.

Note: Do not twist, torque, or subject the flexible hose to sharp bends. Doing so may shorten the life of the hose.

Operation

The backup system can run for a minimum of 24 hours on battery power.

On average, a backup system in operation uses 8 to 10 lbs. per hour of CO₂ (3.6 to 4.5 L/hr) or LN₂ (4.5 to 5.6 L/hr) at an ambient temperature of 25°C.

This rate will vary depending on set point, load, ambient temperature and freezer size.

Start Up

When the unit is started, it will recognize if a backup system is installed.

1. Follow the instructions in **Backup System (Optional)** to set the backup system type and setpoint.
2. It is recommended to test backup system operation prior to sample storage.

Test BUS Operation

After the freezer has stabilized and both batteries are fully charged, the BUS can be tested to verify proper operation.

1. Disconnect the AC power to the freezer by turning the power switch off.
2. As the freezer warms up, verify the BUS injects at the desired temperature. Displayed temperature may vary by a few degrees from injection temperature due to the differences in probe locations.

Note: On a monthly basis, it is recommended to test your backup system, check the supply tank system levels, and check the backup battery voltage.

Chart Recorders (Optional)

Panel-mounted six-inch seven-day recorders are available as options for all freezer models except for the smaller (300 and 400 box capacity) models.



CAUTION: Do not use sharp or pointed objects to depress the chart buttons. This may cause permanent damage to the recorder.

Set Up and Operation

To prepare the recorder to function properly, complete the following steps:

1. Open the grille door to access the recorder.
2. Install clean chart paper (refer to **Changing Chart Paper**).
3. Remove the plastic cap from the pen stylus or ink pen and close the recorder door.

Recorder operation begins when the system is powered on. The recorder may not respond until the system reaches temperatures within the recorder's range.

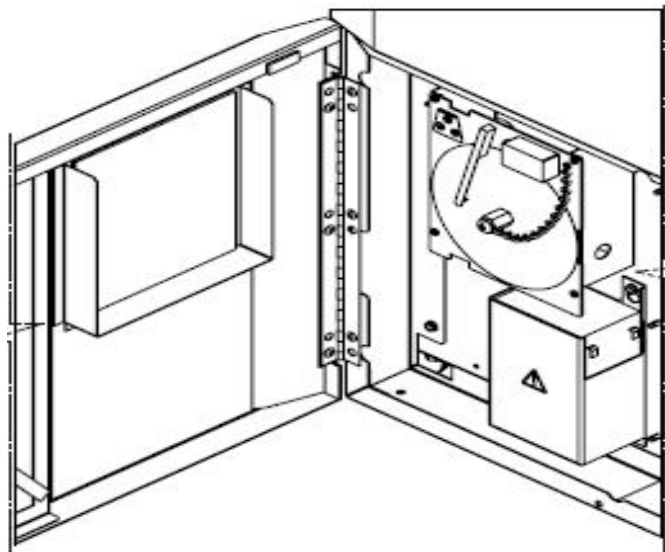

Figure 4. Chart Recorder

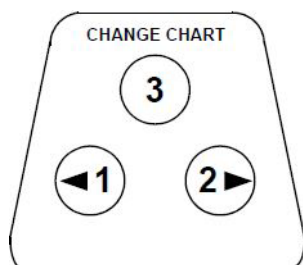

Figure 5. Chart Buttons

Changing Chart Paper

To change the chart paper, complete the following steps:

1. Locate the pressure sensitive buttons at the front, upper left of the recorder panel.
2. Press and hold the Change Chart button (#3) for one second. The pen will move off the scale.
3. Unscrew the center nut, remove the old chart paper, and install new chart paper. Carefully align the day and time with the reference mark (a small groove on the left side of the recorder panel).
4. Replace the center nut and hand tighten. Press the Change Chart button again to resume temperature recording.

Calibration Adjustment

This recorder has been accurately calibrated at the factory and retains calibration even during power interruptions. If required, however, adjustments can be made as follows:

1. Run the unit continuously at the control set point temperature. Continue steady operation for at least two hours to provide adequate time for recorder response.
2. Measure cabinet center temperature with a calibrated temperature monitor.
3. Compare the recorder temperature to the measured cabinet temperature. If necessary, adjust recorder by pressing the left (#1) and right (#2) chart buttons.

Note: The stylus does not begin to move until the top center button (#3) is held for five seconds.

Maintenance



WARNING: Unauthorized repair of your freezer will invalidate your warranty. Contact Technical Service. See **Contact Information** for phone numbers.



CAUTION: Maintenance should only be performed by trained personnel.

Cleaning the Condenser

Clean the condenser at least every six months; more often if the laboratory area is dusty.

To clean the condenser, complete the following steps:

1. Pull the grille door open.
2. Vacuum the condenser.
3. Inspect the filter cleanliness and clean as required.
4. Close the grille door.

Cleaning the Condenser Filter

Clean the condenser filters every two or three months.

1. Pull the grille door open.
2. Remove the filter.
3. Shake the filter to remove loose dust, rinse the filters in clean water, shake the excess water from the filter, and replace the filter.
4. Close the grille door.

Gasket Maintenance

Periodically check the gaskets around the door for punctures or tears. Leaks are indicated by a streak of frost which forms at the point of gasket failure. Make sure that the cabinet is level (refer **Leveling** for leveling information).

Keep the door gaskets clean and frost free by wiping gently with a soft cloth.

Defrosting the Freezer

Defrost the freezer once per year or whenever the ice buildup exceeds 3/8". To defrost, complete the following steps:

1. Remove all products and place in another ULT freezer.
2. Turn off the freezer.
3. Open the outer door and all inner doors.
4. Let the freezer stand with doors open for at least 24 hours. This allows both the interior and foamed refrigeration system to warm to room temperature.
5. Dispose of the ice and wipe out any water standing in the bottom of the cabinet.
6. If there is freezer odor, wash the interior with a solution of baking soda and warm water.
7. Clean the exterior with any common household cleaner.
8. Close the doors, restart the freezer and reload. Refer **Initial Loading** to follow the instructions.

Battery Maintenance

The freezer monitors the voltage status of the battery daily and indicates the battery's voltage via visual and auditory alarm. Replace the battery as indicated by system alarms or as necessary per individual status evaluation. Check the battery connections regularly. Although not required, annual battery replacement is recommended to ensure proper battery status in the event of power failure.

For safety, it is recommended to power off the unit and disconnect it from the power source before replacing the battery. Battery terminals are color coded in red and black. Ensure the corresponding colored wires are connected to the matching color terminals on the battery. The battery is installed with terminals oriented toward the condenser compartment or hinge side of the freezer's outer door (refer **Battery Specification**). With proper installation, the red wire should be connected to the rear battery (positive) terminal and the black wire to the front (common) terminal.

Failure to properly connect the battery can damage electrical components and potentially hinder normal operation of the freezer. Consult a certified service technician if there are any questions or concerns about battery maintenance.

Battery Specification:

Rechargeable sealed lead-acid battery, 12 V, 7.0 Amp Hr.

Replacement batteries can be purchased directly from Thermo Fisher Scientific.

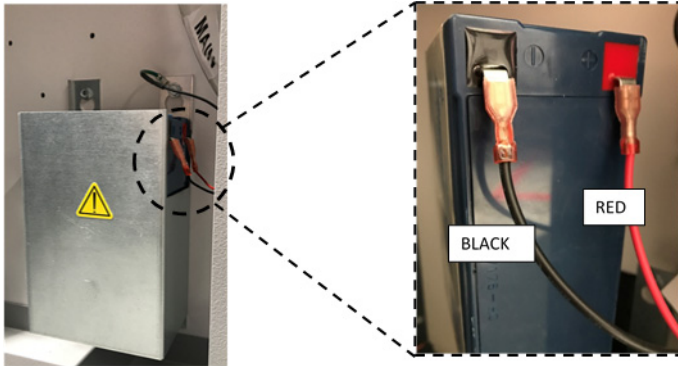

Figure 6. Battery Specification

Maintenance Schedule

Regular maintenance is important to keep the unit working properly. Inspect/clean as directed in the manual.

Item	Interval
Ice/Frost build up	To maintain proper closure of inner doors, remove any ice or frost build up around the gasket, inner doors, and breakers as necessary.
Gasket	Periodically check the gaskets around the door for punctures or tears. Periodically clean the ice-build up around the gasket.
Filter	Clean the condenser filter(s) every two to three months.
Condenser	Clean every six months, more often if the laboratory area is dusty.
Battery	Replace the battery as indicated by system alarms or as necessary per individual status evaluation. Check the battery connections regularly. Although not required, annual battery replacement is recommended to ensure proper battery status in the event of power failure.
Defrost	Defrost the freezer once a year or when the ice build exceeds 3/8" (0.95 cm)

Troubleshooting Guide

This section is a guide to troubleshoot general operational problems.

Problem	Cause	Solution
Unit warming. Not reaching set point. Unit recovers slowly to set point.	Warm load/Over load.	Allow ample time to recover from loading warm product. Do not overload cabinet. Refer Initial Loading in user manual for loading procedures.
	Hot environment.	Check, if the location meets ambient requirements (within 15°C to 32°C or 59°F to 90°F) and away from hot objects.
	Dirty condenser and condenser filter.	Clean condenser and filter. Refer Cleaning the Condenser and Cleaning the Condenser Filter in user manual.
	Not enough space for air circulation.	Install the unit in a level area free from vibration with a minimum of 8" (20 cm) of space on the top and sides, 6" (15 cm) in back.
	Icing/Frost due to high relative humidity.	Check if the location meets requirements. Maximum relative humidity 60% for temperatures within 15°C to 32°C (59°F to 90°F).
	Excess frost build-up in chamber.	Defrost the unit. Refer Defrosting the Freezer in user manual.
	Frost build-up on outer door gasket.	Occasionally scrape the ice on the gasket. Do not use a sharp tool. Be careful not to puncture the rubber gasket.
	Gasket damage.	Check for punctures or tears on gasket. Replace if necessary. Refer Gasket Maintenance in user manual.
	Prolonged door openings.	Avoid opening of door for a prolonged time. Allow ample time for recovery after door opening.
User interface (Display) failure.	Inadequate power supply.	Check for proper voltage to the unit.
	Either of the compressors are not working.	Call service.
	Breaker switch off.	Check circuit breaker and reset to on position. Always use a dedicated, properly grounded circuit.
Power failure to the unit.		Confirm that the cord is securely plugged in.
	Power supply stopped / Breaker switch off.	Plug another appliance into the outlet to see if power is present. Always use a dedicated, properly grounded circuit.

Problem	Cause	Solution
Unit tripping the circuit breaker.	Shared power source.	Never connect unit to overloaded power source. Always use a dedicated (separate) circuit.
	Unit plugged into wrong power outlet.	Plug the unit into proper power source to deliver correct voltage.
	Unit not grounded.	Your unit must be properly grounded in conformity with national and local electrical codes. Troubleshooting procedures involving live voltage is dangerous and if done improperly can result in injury and/or death. This troubleshooting should be performed by trained personnel only.
	Use of extended cords.	Do not use an extension cord. Make sure the unit supplied power cord is plugged directly into power outlet.
Excessive frost build-up around perimeter of door.	Icing/Frost due to high relative humidity.	Check if the location meets requirements. Maximum relative humidity 60% for temperatures within 15°C to 32°C (59°F to 90°F). Occasionally scrape the ice on the outer door. Be careful not to puncture the rubber gasket.
	Excessive and prolonged door openings.	Avoid opening door for a prolonged time.
	Gasket damage.	Check for punctures or tears on gasket. If replacement is necessary, call service. Refer Gasket Maintenance in user manual.
Unit is over cooling.	Set points may have changed.	Adjust the setpoint to run at desired setpoint under settings.
	Temperature offset may have changed.	Try adjusting the offset. Temperature offset can be set by accessing the settings menu via the settings button.
	Unknown.	Try re-starting the unit. If this doesn't help call service.
Unit compressors run continuously.	Freezer set point is low.	Check whether the setpoint is in operating range. Change the setpoint if necessary.
	Frost build up.	Defrost the unit. Refer Defrosting the Freezer in user manual.
	Dirty condenser.	Clean the condenser and condenser filter.
	Gasket damage.	Check for punctures or tears on gasket. If replacement is necessary, call service. Refer Gasket Maintenance in user manual.
Cabinet temperature reached an alarm condition, but suitable alarm is not activated.	Alarm setpoints may be changed.	Check the present setpoints for temperature alarm conditions. Change the setpoints if required.

Problem	Cause	Solution
Problem with temperature validation/calibration.	Cabinet temperature displayed doesn't match with actual temperature.	Customers performing on-site temperature calibration may observe as much as a 2°C variation when an external probe is placed next to the freezer control probe. This variation is normal due to optimisation of the control system to ensure temperature uniformity throughout the cabinet.
Unit is constantly alarming.	Exterior door is closed but not sealed completely.	Clean any ice build-up on gasket and/or cabinet surface. Check for punctures or tears on gasket.
	Door open alarm, exterior door not closing completely.	Open door completely and immediately close and latch it.
	Door open alarm, exterior door is closed but not sealed completely.	Defrost exterior door gasket and make sure the door is completely sealed.
Unit cycle on-percentage is increasing (Compressors are running more often than before).	Alarm set points may have changed.	Change the set points as required.
	Ambient conditions.	Unit performance is directly impacted by these causes mentioned. Try maintaining ambient conditions, reducing load, reducing door openings.
	Warm load (or) over load.	
	Frequent and prolonged door openings.	Once temperature is stable, cycle dynamics should return to normal range. If not call service.
Difficult to close/open the outer door.	Unit is not level.	Make sure the unit is level. Refer Leveling in the user manual for levelling procedure.
	Frost accumulated on outer door gasket.	Scrape the ice occasionally on outer gasket. Do not puncture gasket.
Outer door alignment issues.	Door latch problem.	Ensure door latch is securing. If issue persists, call service.
Difficult to close/open the inner door.	Frost accumulated around inner door.	Remove frost or ice build-up from inner door assembly.
	Inner door latches damaged.	Call service.
Vibration noise. Rattling noise/Loud noise.	Unit is not level.	Check if the unit is installed in a level area free from vibration. (Refer Leveling in user manual)
	Loose side panels.	Check side panel screws, tighten them if necessary.
	Rubber tubing separators and/or compressor dampeners may have loosened.	Call service.

Error Codes

Error Code	Description
E00	Undefined model
E01	Firmware Build Incompatible
E02	Control Probe Failure
E03	Heat Exchanger Probe Failure
E04	Power Failure
E05	Failure to Reach Setpoint
E06	BUS Battery - Low Voltage
E07	System Battery - Low Voltage
E08	Lost Communication Failure (Main to UI)
E09	Lost Communication Failure (BUS)
E10	Stuck Button
E11	Ambient Probe Failure
E12	System Battery Disconnected
E13	BUS Probe Failure

Warranty

Be sure to register your warranty online:

www.thermofisher.com/labwarranty

THERMO FISHER SCIENTIFIC USA FREEZER WARRANTY
FOR Revco RDE series, Forma FDE series, HERAFreeze HDE
series and Thermo Scientific TDE series

The Warranty Period starts two weeks from the date your equipment is shipped from our facility. This allows for shipping time so the warranty will go into effect at approximately the same time your equipment is delivered. The warranty protection extends to any subsequent owner during the warranty period.

Component parts proven to be non-conforming in materials or workmanship will be repaired or replaced at Thermo Fisher Scientific's expense, labor included, for a period of five years. Installation and calibration is not covered by this warranty agreement. The Technical Services Department must be contacted for warranty determination and direction prior to any work being performed. Expendable items, i.e., glass, filters, pilot lights, light bulbs, batteries and door gaskets are excluded from this warranty.

Replacement or repair of component parts or equipment under this warranty shall not extend the warranty to either the equipment or to the component part beyond the original five year warranty period. The Technical Services Department must give prior approval for the return of any components or equipment.

THIS WARRANTY IS EXCLUSIVE AND IN LIEU OF ALL OTHER WARRANTIES, WHETHER WRITTEN, ORAL, OR IMPLIED. NO WARRANTIES OF MERCHANTABILITY OR FITNESS FOR A PARTICULAR PURPOSE SHALL APPLY. Thermo shall not be liable for any indirect or consequential damages including, without limitation, damages relating to lost profits or loss of products.

Your local Thermo Fisher Scientific Sales Office is ready to help with comprehensive site preparation information before your equipment arrives. Printed instruction manuals carefully detail equipment installation, operation, and preventive maintenance.

If equipment service is required, please call your Technical Services Department at 1-866-984-3766 (USA and Canada). We're ready to answer your questions on equipment warranty, operation, maintenance, service, and special applications. Outside the USA, contact your local Thermo Fisher Scientific office or distributor for warranty information.

Warranty (International)

THERMO FISHER SCIENTIFIC FREEZER INTERNATIONAL
WARRANTY FOR Revco RDE series, Forma FDE series,
HERAFreeze HDE series and Thermo Scientific TDE series

The Warranty Period starts two months from the date your equipment is shipped from our facility. This allows for shipping time so the warranty will go into effect at approximately the same time your equipment is delivered. The warranty protection extends to any subsequent owner during the warranty period. Dealers who stock our equipment are allowed an additional four months for delivery and installation, providing the warranty card is completed and returned to the Technical Services Department.

Component parts proven to be non-conforming in materials or workmanship will be repaired or replaced at Thermo Fisher Scientific's expense, labor excluded, for a period of five years. Installation and calibration is not covered by this warranty agreement. The Technical Services Department must be contacted for warranty determination and direction prior to any work being performed. Expendable items, i.e., glass, filters, pilot lights, light bulbs, batteries and door gaskets are excluded from this warranty.

Replacement or repair of component parts or equipment under this warranty shall not extend the warranty to either the equipment or to the component part beyond the original five year warranty period. The Technical Services Department must give prior approval for the return of any components or equipment.

THIS WARRANTY IS EXCLUSIVE AND IN LIEU OF ALL OTHER WARRANTIES, WHETHER WRITTEN, ORAL, OR IMPLIED. NO WARRANTIES OF MERCHANTABILITY OR FITNESS FOR A PARTICULAR PURPOSE SHALL APPLY. Thermo shall not be liable for any indirect or consequential damages including, without limitation, damages relating to lost profits or loss of products.

Your local Thermo Fisher Scientific Sales Office is ready to help with comprehensive site preparation information before your equipment arrives. Printed instruction manuals carefully detail equipment installation, operation, and preventive maintenance.

If equipment service is required, please contact your local Thermo Fisher Scientific office or local distributor.

We're ready to answer your questions on equipment warranty, operation, maintenance, service, and special applications. Outside the USA, contact your local Thermo Fisher Scientific office or distributor for warranty information.

Appendix A: Alarm Summary

Alarm Summary			
Alarm Message	Warning Icon	Remote Alarm Event	Description
Warm Alarm	Thermometer	Yes	The freezer temperature has exceeded the warm alarm set point. Prolonged door openings and warm product loading may cause warm alarms.
Cold Alarm	Thermometer	Yes	The freezer temperature has exceeded the cold alarm set point.
Door Open Ajar	Door	Yes	Door open for greater than 3 minutes will cause door open alarm.
Control Probe Failure	Wrench	Yes	Cannot display cabinet temperature. The freezer will continue to operate in full run mode. Contact customer service. Display will intermittently show "E02".
Heat Exchange Probe Failure	Wrench	Yes	The freezer will continue to operate with current freezer setpoints, but cabinet temperature variation will increase. Contact customer service. Display will intermittently show "E03".
Ambient Probe Failure	Wrench	Yes	Ambient Probe TC has malfunctioned. This doesn't affect the performance of the unit. Contact service for further assistance. Display will intermittently show "E11".
Main to UI Lost Communication	Wrench	Yes	A communication error has occurred within the system. Contact customer service. Display will intermittently show "E08".
BUS Lost Communication	Wrench	Yes	A communication error has occurred within the backup system. Contact customer service. Display will intermittently show "E09".
Failure to Reach Set point	Wrench	Yes	Door openings or product loading may cause this notification. Allow unit to stabilize. If condition persists, contact customer service. Display will intermittently show "E05".
Power Failure Alarm	Wrench	Yes	Unit in power failure mode. Display operating on battery power. Check unit plug, unit circuit breaker in the ON position, and supply voltage. Display will intermittently show "E04".

Alarm Summary			
Alarm Message	Warning Icon	Remote Alarm Event	Description
Wrong Model Alarm	Wrench	Yes	Invalid Control Model Alarm. Contact service to ensure the correct model is selected for the system to avoid cargo loss. Display will intermittently show “E00”.
Firmware Build Incompatible	Wrench	Yes	Firmware build indicates incompatibility that can result in modules to be non-coherent. Display will intermittently show “E01”.
System Battery Low Voltage Alarm	Wrench	Yes	System Battery voltage is too low. If error persists, the battery may need to be replaced. Display will intermittently show “E07”.
BUS Battery Low Voltage Alarm	Wrench	Yes	BUS Battery voltage is too low. If error persists, the battery may need to be replaced. Display will intermittently show “E06”.
Stuck Button Alarm	Wrench	Yes	A button has been pressed for more than 5 minutes. Display will intermittently show “E10”.
System Battery Failure Alarm	Wrench	Yes	System battery disconnected or failed. Display will intermittently show “E12”.
BUS Probe Failure Alarm	Wrench	Yes	BUS cannot detect temperature. BUS will continuously inject. Contact customer service. Display will intermittently show “E13”.

WEEE Compliance

WEEE Compliance. This product is required to comply with the European Union's Waste Electrical & Electronic Equipment (WEEE) Directive 2012/19/EU. It is marked with the following symbol. Thermo Fisher Scientific has contracted with one or more recycling/disposal companies in each EU Member State, and this product should be disposed of or recycled through them. Further information on our compliance with these Directives, the recyclers in your country, and information on Thermo Scientific products which may assist the detection of substances subject to the RoHS Directive are available at www.thermofisher.com/WEEERoHS.

Great Britain

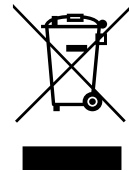

WEEE Konformität. Dieses Produkt muss die EU Waste Electrical & Electronic Equipment (WEEE) Richtlinie 2012/19/EU erfüllen. Das Produkt ist durch folgendes Symbol gekennzeichnet. Thermo Fisher Scientific hat Vereinbarungen getroffen mit Verwertungs-/Entsorgungsanlagen in allen EU-Mitgliederstaaten und dieses Produkt muss durch diese Firmen verwertet oder entsorgt werden. Mehr Informationen über die Einhaltung dieser Anweisungen durch Thermo Scientific, die Verwerter und Hinweise die Ihnen nützlich sein können, die Thermo Fisher Scientific Produkte zu identifizieren, die unter diese RoHS-Anweisungen fallen, finden Sie unter www.thermofisher.com/WEEERoHS.

Deutschland

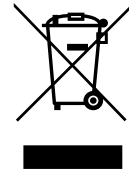

Conformità WEEE. Questo prodotto deve rispondere alla direttiva dell'Unione Europea 2012/19/EU in merito ai Rifiuti degli Apparecchi Elettrici ed Elettronici (WEEE). È marcato col seguente simbolo. Thermo Fisher Scientific ha stipulato contratti con una o diverse società di riciclaggio/smaltimento in ognuno degli Stati Membri Europei. Questo prodotto verrà smaltito o riciclato tramite queste medesime. Ulteriori informazioni sulla conformità di Thermo Fisher Scientific con queste Direttive, l'elenco delle ditte di riciclaggio nel Vostro paese e informazioni sui prodotti Thermo Scientific che possono essere utili alla rilevazione di sostanze soggette alla Direttiva RoHS sono disponibili sul sito www.thermofisher.com/WEEERoHS.

Italia



Conformité WEEE. Ce produit doit être conforme à la directive européenne (2012/19/EU) des Déchets d'Équipements Électriques et Électroniques (DEEE). Il est marqué par le symbole suivant. Thermo Fisher Scientific s'est associé avec une ou plusieurs compagnies de recyclage dans chaque état membre de l'union européenne et ce produit devrait être collecté ou recyclé par celles-ci. Davantage d'informations sur la conformité de Thermo Fisher Scientific à ces directives, les recycleurs dans votre pays et les informations sur les produits Thermo Fisher Scientific qui peuvent aider la détection des substances sujettes à la directive RoHS sont disponibles sur www.thermofisher.com/WEEERoHS.

France



This page is
intentionally
left blank.

This page is
intentionally
left blank.

This page is
intentionally
left blank.

Contact Information

Thermo Fisher Scientific products are backed by a global technical support team ready to support your applications. We offer cold storage accessories, including remote alarms, temperature recorders, and validation services.

Visit www.thermofisher.com/cold or call:

Countries	Sales
North America	+1 866 984 3766
India toll free	1800 22 8374
India	+91 22 6716 2200
China	+800 810 5118, +400 650 5118
Japan	+81 3 5826 1616
France	+33 2 2803 2180
Germany international	+49 6184 90 6000
Germany national toll free	0800 1 536 376
UK/Ireland	+44 870 609 9203

For countries not listed here, visit www.thermofisher.com and go to the Contact Us page under the Services menu to locate the contact information for your area.

Thermo Fisher Scientific Inc.
275 Aiken Road
Asheville, NC 28804
United States

Find out more at thermofisher.com/cold

ThermoFisher
S C I E N T I F I C