



**Thermo Scientific™  
Smart-Tracker™**

## **Smartphone-Tablet User Guide**

327243H01    Rev. A    April 2015

**Visit us online to register your warranty  
[www.thermoscientific.com/labwarranty](http://www.thermoscientific.com/labwarranty)**

**IMPORTANT** Read this instruction manual. Failure to follow the instructions in this manual can result in damage to the unit, injury to operating personnel, and poor equipment performance.

**CAUTION** All internal adjustments and maintenance must be performed by qualified service personnel.

Material in this manual is for informational purposes only. The contents and the product it describes are subject to change without notice. Thermo Fisher Scientific makes no representations or warranties with respect to this manual. In no event shall Thermo be held liable for any damages, direct or incidental, arising from or related to the use of this manual.

© 2015 Thermo Fisher Scientific Inc. All rights reserved.

# Table of Contents

<b>Notices</b> .....	<b>1</b>
Battery warning .....	1
FCC statements .....	1
IC Statements .....	1
CE .....	1
KCC (Korea) .....	2
<b>Getting started</b> .....	<b>5</b>
Introduction .....	5
About iOS® and Android® versions of this application .....	5
Main application features .....	6
Install Smart-Tracker on your smartphone or tablet .....	6
Using the magnet .....	8
<b>Using Smart-Tracker</b> .....	<b>11</b>
Smart-Tracker home screen .....	11
Scanning for nearby Smart-Tracker modules .....	12
<b>Configuring missions</b> .....	<b>14</b>
Setting up Cloud access .....	14
Starting a new mission .....	15
Selecting the start mode .....	16
Setting high and low limits .....	17
Password-protection .....	18
Viewing a currently-running mission .....	19
Saving and sending data from the current mission .....	21
Looking up data from previous missions .....	21
<b>Settings</b> .....	<b>22</b>
<b>Monitoring with Watch Mode (iOS only)</b> .....	<b>23</b>
Requirements for using Watch Mode with an iOS device .....	23
Watch Mode settings .....	23
<b>Appendix 1 – Battery considerations</b> .....	<b>25</b>
Smart-Tracker -200° to +200°C (Pt100) modules .....	25
Smart-Tracker -40°C to +85°C modules .....	26
<b>Appendix 2 – Advanced module settings</b> .....	<b>27</b>
<b>Appendix 3 – Supported devices, operating systems and versions</b> .....	<b>29</b>
iOS® .....	29
Android® .....	29

## Notices

### Battery warning

Thermo Scientific Smart-Tracker products contain a non-rechargeable lithium battery. Make sure you observe polarity (+/-) when inserting batteries into Smart-Tracker devices. Reversing polarity by inserting the batteries incorrectly can cause the product to heat up and may lead to a battery liquid leak. Use only batteries recommended by Thermo Scientific. Battery life depends on target temperatures. Removing the battery erases data contained in module memory. *See Section 6 - Appendix 1 for more details on battery life.*

### FCC statements

This device complies with Part 15 of the FCC Rules. Operation is subject to the following two conditions:

1. This device may not cause harmful interference.
2. This device must accept any interference received, including interference that may cause undesired operation.

FCC RF Radiation Exposure Statement:

This equipment complies with FCC radiation exposure limits set forth for an uncontrolled environment. End users must follow the specific operating instructions for satisfying RF exposure compliance. This transmitter must not be co-located or operating in conjunction with any other antenna or transmitter.

### IC Statements

This device complies with Industry Canada license-exempt RSS standard(s). Operation is subject to the following two conditions: (1) this device may not cause interference, and (2) this device must accept any interference, including interference that may cause undesired operation of the device.

Under Industry Canada regulations, this radio transmitter may only operate using an antenna of a type and maximum (or lesser) gain approved for the transmitter by Industry Canada. To reduce potential radio interference to other users, the antenna type and its gain should be so chosen that the equivalent isotropically radiated power (e.i.r.p.) is not more than that necessary for successful communication.

**CE** Thermo Scientific Smart-Tracker (Bluetooth component BLE112-A) is in conformity with the essential requirements and other relevant requirements of the R&TTE Directive (1999/5/EC). The product is conformity with the following standards and/or normative documents.

- EMC (immunity only) EN 301 489-17 V.1.3.3 in accordance with EN 301 489-1 V1.8.1
- Radiated emissions EN 300 328 V1.7.1
- Safety EN60950-1:2006+A11:2009+A1:2010+A12:2011

**KCC (Korea)** Thermo Scientific Smart-Tracker (Bluetooth component BLE112-A) is KCC certified with following certification number:

- KCC-CRM-BGT-BLE112-A

Welcome to the Thermo Scientific Smart-Tracker application. This guide shows you how to use the software to configure, read, and manage your Thermo Scientific Smart-Tracker temperature monitoring modules. To get started, insert the battery into your Smart-Tracker module.

-200°C / +200°C (Pt100) modules

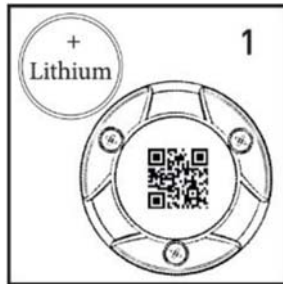

The Lithium battery is provided in the product box.

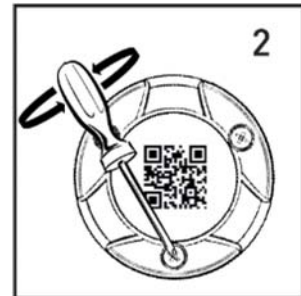

Unscrew the three screws on the back of the module (turn counter-clockwis).

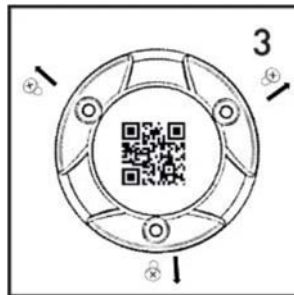

Remove the screws.

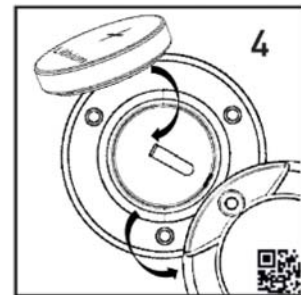

Place the battery in the slot, with the plus sign (+) facing up.

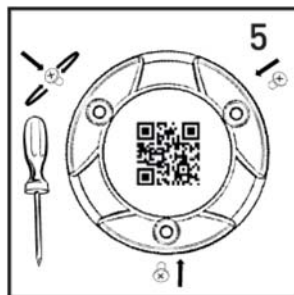

Replace the screws (turn clockwise). Ensure that the rubber gasket is properly seated.

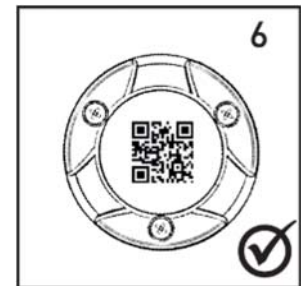

That's all. Your module is now ready to use.

**Inserting the battery in your Smart-Tracker -200°C / +200°C (Pt100) module**

-40°C / +85°C modules

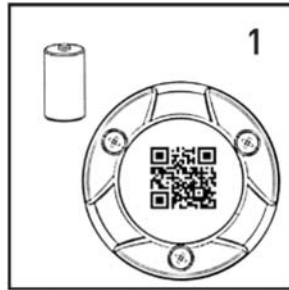

The Lithium battery is provided in the product box.

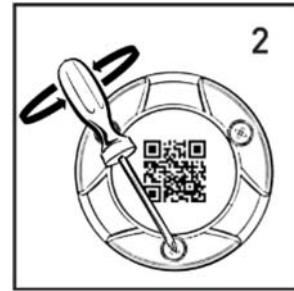

Unscrew the three screws on the back of the module (turn counter-clockwise).

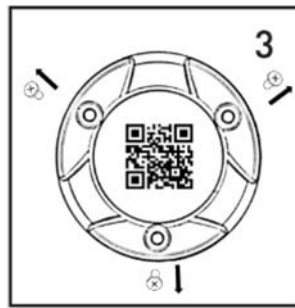

Remove the screws.

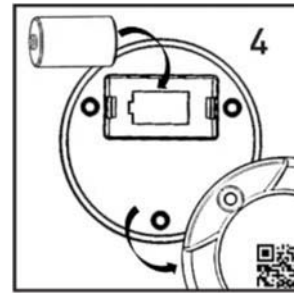

Place the battery in the slot, making sure to respect polarity.

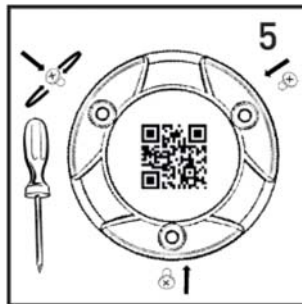

Replace the screws (turn clockwise). Ensure that the rubber gasket is properly seated.

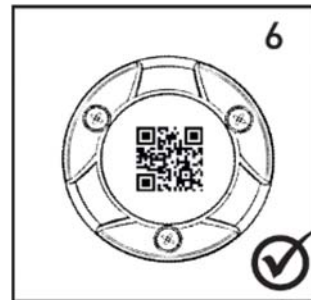

That's all. Your module is now ready to use.

**Inserting the battery in your Smart-Tracker -40°C / +85°C module**

# 1 Getting started

## 1.1 Introduction

Smart-Tracker is a Bluetooth® Smart enabled module that records ambient temperature at regular intervals and stores the information in its memory. This type of device is also known as a datalogger.

The Smart-Tracker application on your smartphone enables you to read the device wirelessly via Bluetooth at any time. You may also choose to upload the information to the Cloud\* where other people can access it.



**Figure 1.** Smart-Tracker temperature tracker

## 1.2 About iOS® and Android® versions of this application



**Caution** This User Guide describes the Smart-Tracker application for supported iOS® and Android® devices. All features are identical with the exception of **Watch Mode**, which is only supported on iOS devices at this time. You will see a note mentioning “**For iOS only**” where applicable.

*\* Requires Thermo Scientific Cloud subscription and Smart-Tracker desktop application for configuration.*



### 1.3 Main application features

- Monitor temperature-sensitive goods during shipment and view stored temperature readings on your Smart-Tracker modules
- Program high and low temperature limits
- Replicate data in secure Cloud storage\*, with mapping using your device's location services
- An easy solution for monitoring temperature in packages, refrigerated trucks, laboratories, storage facilities, and more
- Supports Bluetooth Smart, with a wireless range of approximately 30 meters (98 feet)

For iOS only:

- Monitor your modules continually using Watch Mode for timely alerts

\* Requires Thermo Scientific Cloud subscription and Smart-Tracker desktop application for configuration.

### 1.4 Install Smart-Tracker on your smartphone or tablet

You may download and upgrade Smart-Tracker directly using your mobile device. After installing the application, you will be notified automatically when upgrades are made available. There are two ways to proceed with installation.

#### 1.4.1 Option 1: use QR code to access the Thermo Scientific site

- To go to the Thermo Scientific website, you may use your mobile device to scan the QR code provided on the back of your Smart-Tracker module or on the product box.



**Figure 2.** Scan QR code links to open the Thermo Scientific application download page

- Scroll down to the Smart-Tracker application link and tap to proceed with the download via the appropriate online store.

**Note** *On the site, you will also find the MS Windows Smart-Tracker companion application for your mobile software. This application is needed to view data stored by your mobile device on the Cloud and to manage the vouchers needed for Cloud access.*

### 1.4.2 Option 2: access online stores directly

iOS	Android
For <b>iOS</b> devices, tap on the App Store icon on your device:	For <b>Android</b> devices, tap on the <b>Play Store</b> icon on your device:
	
Alternatively, you may open the Apple App Store web site directly and download the application via iTunes.	Alternatively, you may install the application via Google Play web site.

1. Search for “Smart-Tracker” on the appropriate store page.
2. Select the Thermo Scientific Smart-Tracker application to proceed with installation.
3. Login to your account (or create one) and follow the installation instructions.
4. When installation is complete, tap on the Smart-Tracker icon to open the application on your smartphone or tablet.

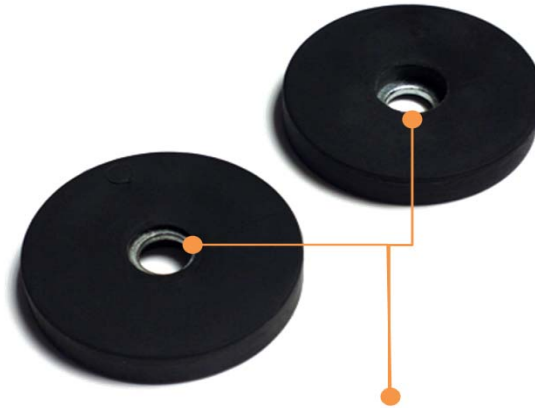

**Figure 3.** Smart-Tracker application icon

## 1.5 Using the magnet

Smart-Tracker includes a magnet that can be used both for mounting the module onto a magnetic surface, and to trigger selected actions.

The provided magnet has a “weak” and a “strong” side. The metal ring is close to the edge on the “weak” side of the magnet. The deeper recess on the other side indicates “stronger” side.



**Figure 4.** Metal ring close to the edge on magnet’s “weak” side. Deeper recess indicates “stronger” side.

### 1.5.1 Mounting Smart-Tracker with the magnet

You may fix the magnet to a metallic wall or insert a screw to fix it onto other types of surfaces. Simply place the module onto the magnet as shown below:



**Figure 5.** Mount Smart-Tracker on magnet

### **Starting a mission by mounting module on magnet**

You may trigger the start of a mission by mounting the module on the magnet (typically screwed into a wall or placed onto a magnetic surface). Enable this option in Smart-Tracker → **New Mission** → **Start mode** → **On contact with magnet**.

### 1.5.2 Use the magnet to check Smart-Tracker status

You may also hold the magnet over a Smart-Tracker module to check its status. Face the magnet's "strong" side towards the module to do this. The magnet's presence causes the LED on the front of the module to blink as follows (identically to the software button **Blink LED to identify module** in Smart-Tracker):

<b>Blue</b>	New, not programmed
<b>Blue / Red</b>	On a mission, datalogging not yet started
<b>Green</b>	On a mission, no alarm
<b>Red</b>	Currently in alarm state
<b>Green / Red</b>	Datalogging on, at least one alarm recorded



**Figure 6.** Check status by holding magnet over module

## 2 Using Smart-Tracker

### 2.1 Smart-Tracker home screen

The home screen shown here opens when you first start the application. The colored zones indicate where to tap to:

- Scan the area for nearby Smart-Tracker modules (Bluetooth must be activated on your smartphone). If Bluetooth is not activated, you will be prompted to turn it on.
- Run Smart-Tracker in demonstration mode without actually connecting to any modules.
- Enter your Cloud ID to use Cloud services

The four tabs, **Scan**, **History**, **Settings**, and **About**, are present throughout the application, and are described in detail in the following sections.





**Figure 7.** Smart-Tracker home screen (upon first start)

**Note** *The first time you launch Smart-Tracker, the application will request your authorization to access geolocation features. If you would like to include details location information with your readings, you must allow access.*

## 2.2 Scanning for nearby Smart-Tracker modules

On the **Scan** tab, tap the scan/refresh icon to discover and list the Smart-Tracker modules within range.

The icon colors are as follows in this mode (referred to as “Discovery mode”):

-  Indicates a programmed module that has not exceeded its limit values during the current mission(no alarms).
-  Indicates a programmed module on which one or more alarms have been detected during the current mission.
-  Indicates an idle module (not running, ready-to-use).

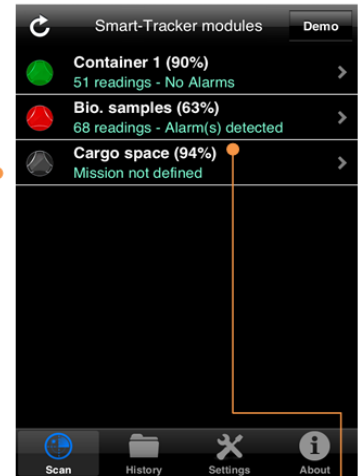

Module signal strength

Tap anywhere on one of these lines to manage the selected Smart-Tracker module and access module details.

**Figure 8.** List of Smart-Tracker modules after scanning

### Returning to the home screen

Press the **Back** button if you want to return to the previous screen in the application.

### Blink module LED

When several Smart-Tracker modules are present, you might not always know which one you are working with in Smart-Tracker. If you are unsure, simply tap on **Blink LED to identify module**, and a light on the front of the module will blink for a few seconds.

The LED blinks different colors depending on the module's status

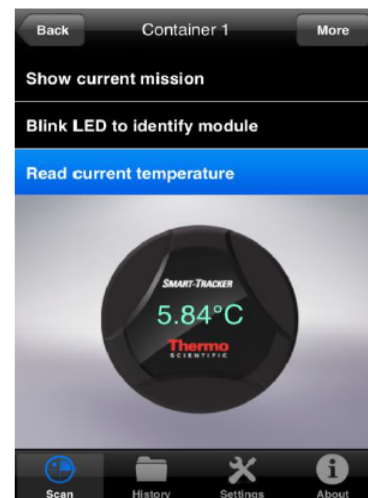

### On-demand reading

Click on **Read current temperature** to display the ambient temperature where the Smart-Tracker module is located.

**Figure 9.** Accessing and configuring your module



## 3 Configuring missions

One of the main features about Smart-Tracker is its ability to record temperature data intelligently (datalogging) during “missions.” To begin datalogging, you must create a mission for the module.

A mission is a set of configuration options that apply to a Smart-Tracker module. Mission parameters include:

- A name for the module and how often temperature is read
- How and when the module should begin tracking data
- High and low alarm limits
- Data storage on Cloud
- Password protection to stop a module currently on a mission

### 3.1 Setting up Cloud access

If you have an Thermo Scientific Cloud account, you may use your mobile device to push Smart-Tracker data to the Cloud so that other users may accessed it over the Internet from the Smart-Tracker PC application.

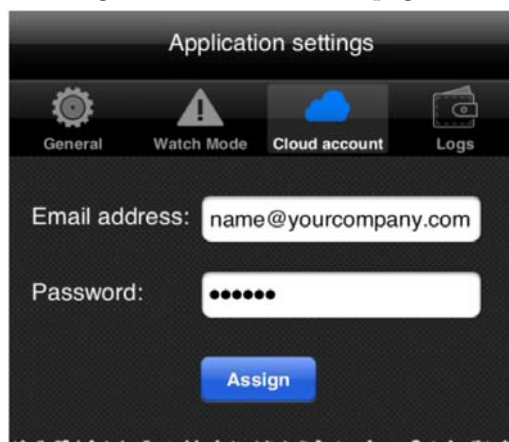

Assign the Cloud account to your mobile device (one account per device):

1. In **Settings** → **Cloud account**, enter the Email address and Password for your Cloud account
2. Tap on **Assign**
3. Proceed with Starting a new mission (next page).



**Figure 10.** Setting up Cloud access

## 3.2 Starting a new mission

1. In the Home screen, tap  to refresh the list of Smart-Tracker modules. You may define and start a mission for modules with a gray icon . Red or Green icons indicate that the module is already on a mission.

2. Tap to select the module you want to configure → **Set up new mission**

3. Fill in the information on the **General** tab (shown here).

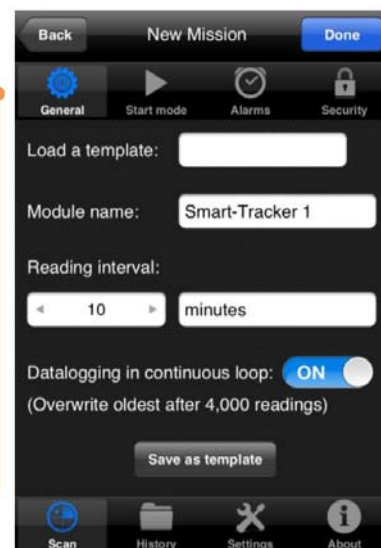

**Figure 11.** General mission settings

### 3.2.1 Load a template

You may load an existing mission template (if there are any) by tapping in the field and choosing a name from the pull-down list.

### 3.2.2 Module name

Enter a name to use for the module during this mission (up to 18 characters). This name is displayed throughout the application when referring to the module.

### 3.2.3 Reading interval

Specify the frequency with which the module reads and records temperature from its sensor. Choose values in minutes or seconds by tapping on the **minutes** field.

**Note** To activate *Low/High delays* in the *Alarms* tab, *Reading interval* must be set in minutes (see below).

### 3.2.4 Datalogging...

Up to 4,000 readings can be stored in module memory. To continue datalogging after this limit is reached, the oldest readings can be overwritten by new readings if you select **Datalogging in continuous loop**. Otherwise, datalogging stops when the limit of 4,000 readings has been reached.

### 3.2.5 Save as template

When you are done adjusting the settings, you may tap on **Save as template** at the bottom of the screen if you want to save the current mission as a template for future use.

### 3.3 Selecting the start mode

There are several ways to start datalogging on your Smart-Tracker module, depending on your needs.

Adjust the following options in the **Start mode** tab as necessary. All options other than **Immediately** may be combined for use together.

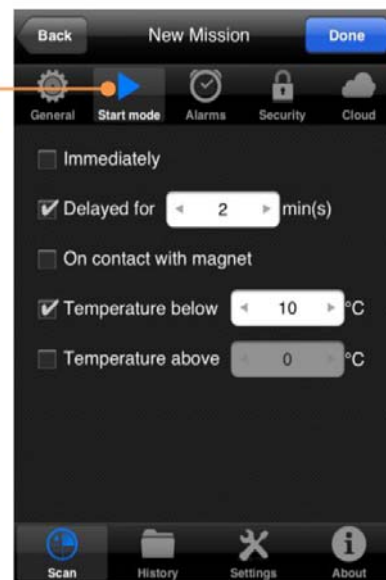

**Figure 12.** Mission start options

#### **Immediately**

Datalogging begins when the module receives its programming information.

#### **Delayed for...**

Datalogging begins after the specified number of minutes (after mission has started). Tap in the field to change the number.

#### **On contact with magnet**

Datalogging begins when the Smart-Tracker module comes into contact with its magnet. For example, you could start datalogging when you mount the Smart-Tracker on a magnet installed in a refrigerated truck.

#### **Temperature below / Temperature above**

Datalogging begins when Smart-Tracker module detects the specified temperature (one or the other). This is useful for automatically starting datalogging when the module is placed in the environment to be monitored, such as in a cooler when it is ready for transportation.

### 3.4 Setting high and low limits

If you would like to ensure that the temperature in the container or environment you are monitoring remains within a specific range, you may set high and low limits in the **Alarms** tab.

The default values in the fields show the module's available temperature range. Tap on checkboxes to enable options and in fields to adjust settings.

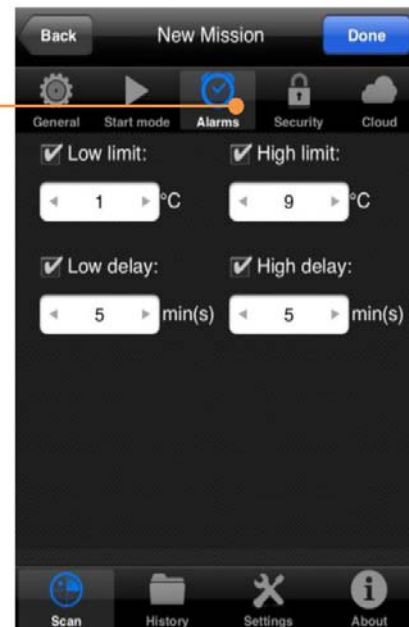

**Figure 13.** High and low temperature range limits

**Low limit:**

the lowest acceptable temperature reading.

**High limit:**

the highest acceptable temperature reading.

**Low delay:** how long the reading is lower than the Low limit (multiple of the reading interval, in minutes only).

**High delay:** How long the reading is higher than the High limit before triggering an alarm (multiple of the reading interval, in minutes only).

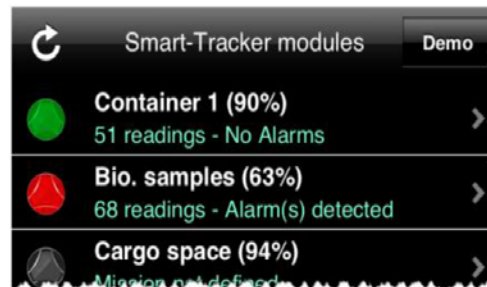

If an alarm condition arises at any point since the start of the mission, the module shows an alarm on the home screen (unless Watch Mode is activated. See Section 5 *Monitoring with Watch Mode (iOS) only*).

**Figure 14.** Alarm condition indicated by red icon

### 3.5 Password-protection

Smart-Tracker enables you to assign a password to prevent other users from stopping a Smart-Tracker module that is currently on a mission. To do this, tap on the **Security** tab.

**Password required to stop mission :**  
requires a user to enter the password configured here to stop this mission after it has been started.

**Important :**  
If you forget your password, please contact Thermo Scientific technical support.

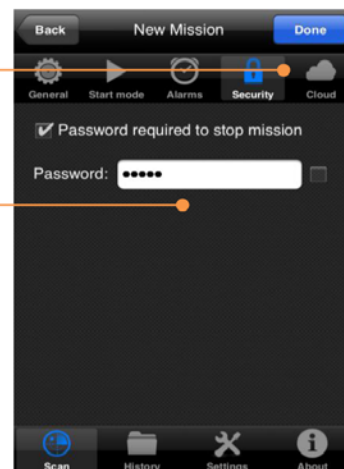

Tap in the **Password** field to enter the **password**. The checkbox to the right of this field shows or hides the password characters.

**Figure 15.** Protecting Smart-Tracker mission with a password

#### 3.5.1 Pushing mission readings to the Cloud

In the **Cloud tab**, select **Use Cloud for this mission** to push Smart-Tracker data to the Cloud (after having assigned your Cloud ID and password in **Settings**, as mentioned earlier). Data is pushed by your mobile device upon datalogging start, reading during the mission, and at the end of the mission.

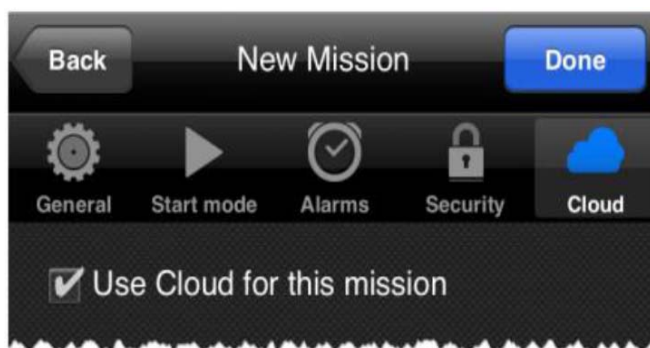

**Note** Use the Smart-Tracker desktop application for Windows to configure cloud access and to view module readings on your computer.



**Figure 16.** Pushing data to the Cloud upon start, read, and stop

### 3.5.2 Starting the mission

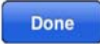
After you have finished defining the various settings in **General**, **Start mode**, **Alarms**, and **Security**, you may save this configuration as a template for future use if you want (return to the **General** tab).

Then tap on  to transmit your settings to the module. A confirmation message is displayed in Smart-Tracker and the module is displayed with a green  icon on the Home page (or red  if the module already has an alarm).

## 3.6 Viewing a currently-running mission

### General information

When a module is activated and configured for a mission, you may view, store, and email various details.

1. Tap on the module name in the home screen → **Show current mission**.
2. General information about the mission is displayed.
3. You may tap on **Stop** to terminate the mission if appropriate.

Access  
detailed information and maps

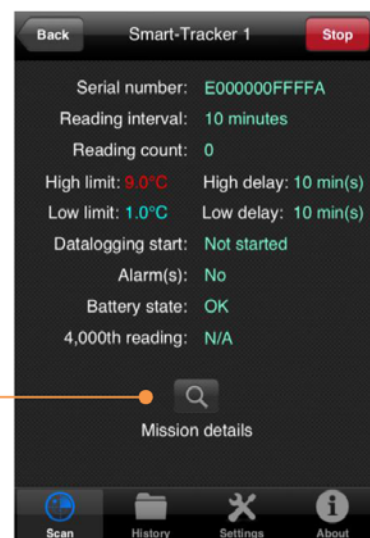

**Figure 17.** Summary of current mission

Tap on **Mission details** for more complete information regarding the Smart-Tracker module on its mission. If the Cloud option is activated for the mission:

- When you tap on **Mission details**, data is pushed to the Cloud before refreshing the screen. Data can be pushed to the Cloud even if no Cloud account is assigned in the user's Smart-Tracker application. This “anonymous” push enables people reading the module at remote locations to update the data on the Cloud without having to configure their application.
- When you tap on **Stop**, the module must be linked to your Cloud account, and the Cloud account configured in the application.

### Graph

Tap on the graph tab to see a summary graph of the readings in the current mission.

Zoom in by swiping diagonally (left to right) with your finger anywhere in the graph. Zoom out by swiping diagonally right to left.

### Data

For a list of all the readings, events, and alarms related to the current mission, tap on **Data**.

### Map

If the option **Location Services** is enabled on your mobile device (**Settings** → **Restrictions**), the location is stored when Smart-Tracker reads the Smart-Tracker module.

Tap on **Map** to view a Google Map showing the locations at which the Smart-Tracker module was programmed, read, and stopped.

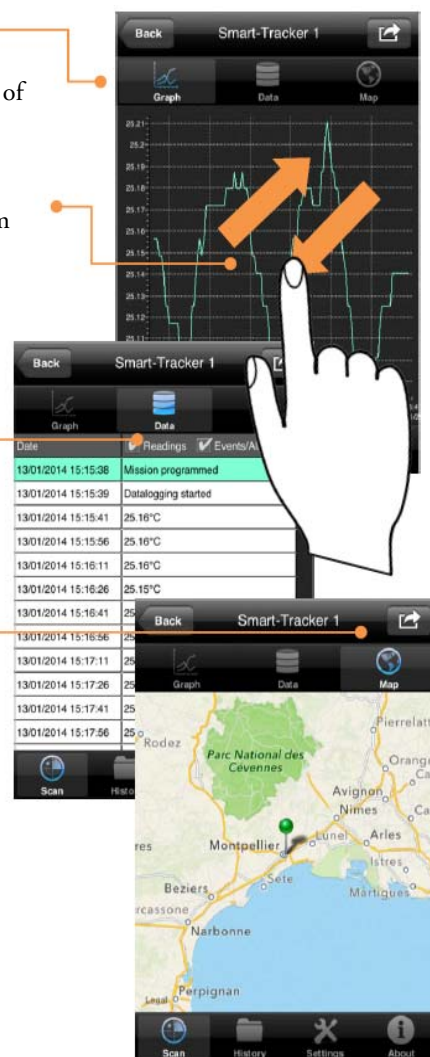

### 3.7 Saving and sending data from the current mission

You may save or store data at any time during a mission by tapping on the  icon.

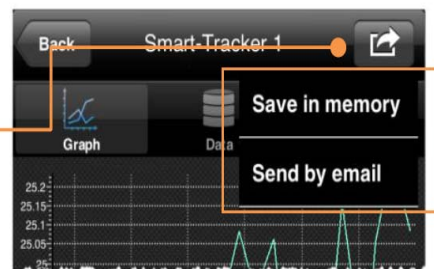

**Save in memory:** saves up to five missions in your smartphone’s memory. If you save the current mission more than once, an additional line is added to the list.

**Send by email:** sends all stored readings and the graph from the current mission to an email address that you specify. This action requires email functionality and Internet (or Wi-Fi) access to be operational on your mobile device.

### 3.8 Looking up data from previous missions

Tap on History to see stored information from Smart-Tracker missions.

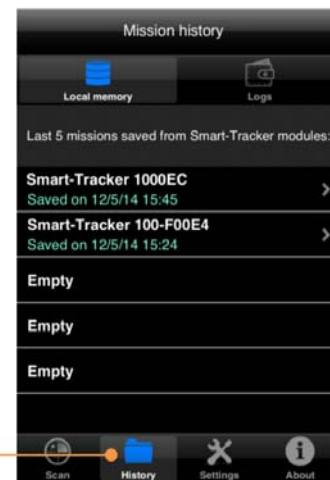



## 4 Settings

The Settings tab contains various options for configuring Smart-Tracker behavior.

**Temperature unit:** choose to display values in Celsius (°C) or Fahrenheit (°F).

**Show data with GMT time:** data is always stored using GMT time. This option lets you display the data with GMT time or the smartphone's current local time.

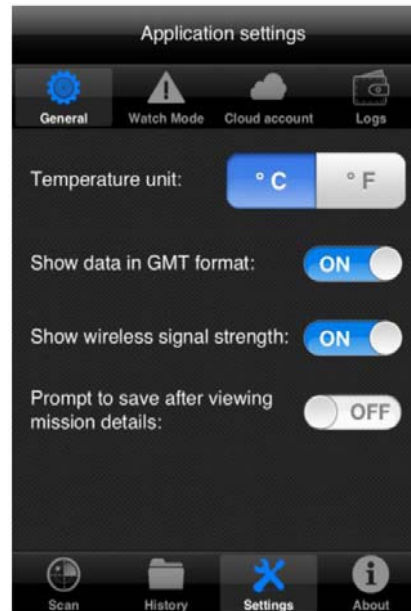

### Show wireless signal strength:

Enabling this option displays signal strength (in %) in the module list on the home screen.

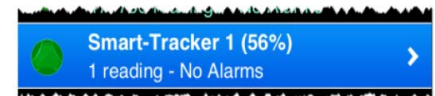

**Prompt to save after viewing mission details:** when viewing mission details (tap module in home screen → **Show current mission** → **Mission details**), current data is downloaded temporarily to your smartphone for display purposes. You may save it or send it by email if you want. This option simply serves to remind you at that time.

## 5 Monitoring with Watch Mode (iOS only)

With iOS devices, Smart-Tracker's Watch Mode enables you to monitor Smart-Tracker modules at on an ongoing basis. When activated, Watch Mode displays the latest reading for all modules within range.

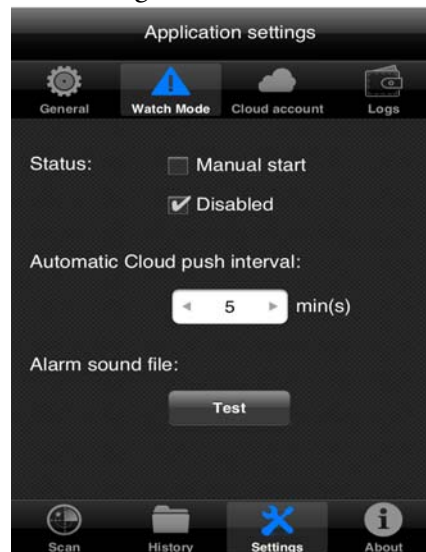

### 5.1 Requirements for using Watch Mode with an iOS device

- The Smart-Tracker module must be programmed, with datalogging active. Modules that are not on a mission do not monitor temperature and therefore are not applicable to Watch Mode
- The Smart-Tracker application must remain in the foreground on your iOS device (it must be the active application).
- Autolock must be turned off on your iPhone so that Smart-Tracker stays open in order to scan nearby Smart-Tracker devices.

### 5.2 Watch Mode settings

**Manual start:** enables you to activate Watch Mode from the **Scan** tab. With this option selected, an ON/OFF button is displayed on the **Scan** screen.

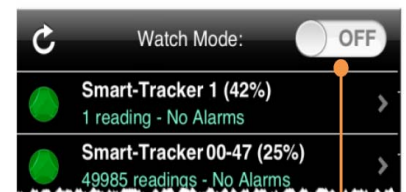

Slide the button to the right to activate Watch Mode ( **ON** )

**Disabled:** Watch Mode is disabled by default. Tap on Manual start to activate this function.

With Watch Mode activated, the latest temperature reading is updated once per minute and displayed in the list on the **Scan** tab.



When Watch Mode is activated, the colored icons on the Scan tab have a slightly different meaning than for “Discover mode.”



Indicates a programmed module whose last-read value has not exceeded its limit value (not currently in an alarm state).



Indicates a programmed module whose last-read value has exceeded its limit value (currently in an alarm state). Smart-Tracker plays an alarm sound once a minute, for several seconds, if the latest reading on one or more Smart-Tracker modules has exceeded a programmed limit.



Indicates either a non-programmed module or one on which there was an error reading the sensor (i.e. the current reading is not available). The text beneath the module name shows the status (“Not started” or “Lastreading N/A”).

### 5.2.1 Pushing readings to Cloud automatically with Watch Mode

If you selected Use Cloud for this mission in the module's, readings will be uploaded to the Cloud at the interval you specify in Automatic Cloud push interval.

If you selected **Use Cloud for this mission**, the latest reading in module memory is uploaded to the Cloud at the interval you specify in **Automatic Cloud push interval**.

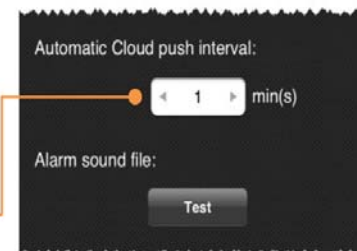

### 5.2.2 Testing the alarm sound

You may test the alarm sound by tapping on the Test button. The alarm sounds for approximately 8 seconds, enabling you to adjust the volume as necessary.

## 6 Appendix 1 – Battery considerations

Smart-Tracker module battery life varies with the ambient temperature, and thus varies with the different available models. Generally speaking, batteries last less long in colder environments. This information provides some general battery information.

### 6.1 Smart-Tracker -200° to +200°C (Pt100) modules

#### 6.1.1 Battery specifications:

Diameter (A):	min 0.95 in (24.2 mm) max 0.96 in (24.5 mm)
Height (B):	min 0.18 in (4.6 mm) max 0.2 in (5.0 mm)
Type Number:	6450
IEC designation:	CR2450
System:	Li-Manganese dioxide / Organic Electrolyte

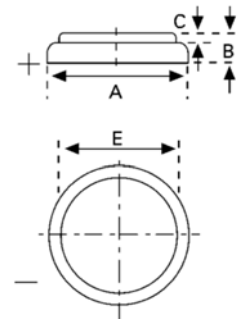

The chart below shows estimated battery life (in weeks) at various temperatures for this module, with the temperature representing the module’s operating (ambient) temperature.

This information is based on one data download per day (regardless of the number of sensor readings recorded during that day).

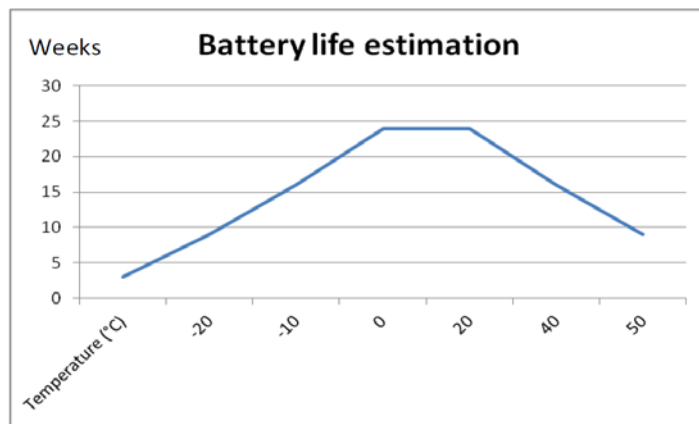
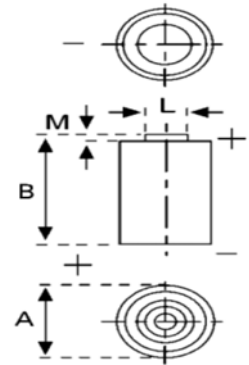

**Figure 18.** Battery life estimation for -200° to +200°C (Pt100) modules

## 6.2 Smart-Tracker -40°C to +85°C modules

### Battery specifications:

Diameter (A):	min 0.55 in (14 mm) max 0.55 in (14.6 mm)
Height (B):	min 0.95 in (24.1 mm) max 0.99 in (25.1 mm)
Shoulder Diameter [L]:	min 0.16 in (4.1 mm) max 0.18 in (4.5 mm)
Shoulder Height [M]:	min 0.03 in (0.8mm) max 0.05 in (1.2 mm)
Type Number:	ER 1/2 AA
CEI designation:	14250
System:	Primary Li-Thionyl Chloride / LiSOCI <sub>2</sub>



The chart below shows estimated battery life (in weeks) at various temperatures for this module, with the temperature representing the module's operating (ambient) temperature. This information is based on one data download per day (regardless of the number of sensor readings recorded during that day).

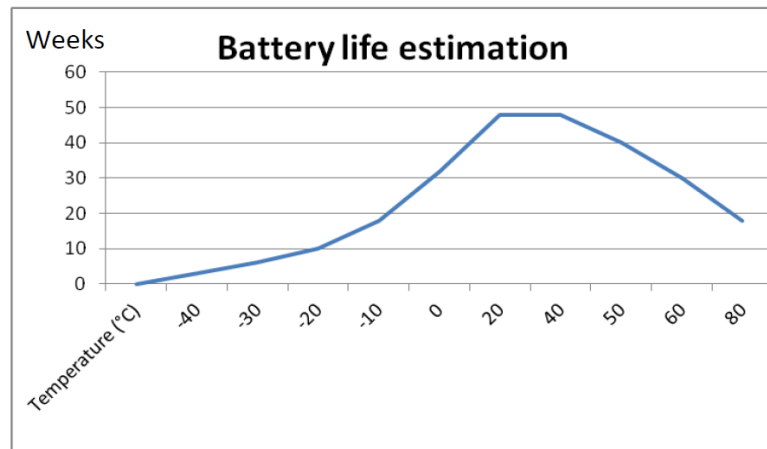

**Figure 19.** Battery life estimation for -40°C to +85°C module

## 7 Appendix 2 – Advanced module settings

Several advanced options are available from the Module details screen by tapping on the **More** button.



### 7.0.1 Radio tools

To see the Smart-Tracker module's battery level, tap on **Get Current**. To reset the counter to 100% (only after changing the battery), tap on **Reset**.

To see wireless signal strength or the module's firmware version, tap on the appropriate **Get Current** buttons.

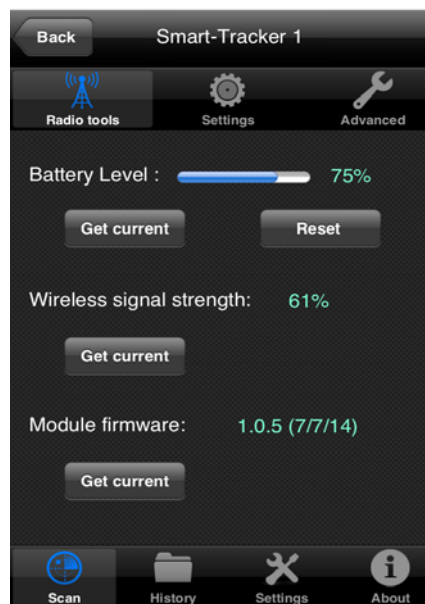

### 7.0.2 Settings

You may view the current A and B calibration parameters of your Smart-Tracker module by tapping on **Get current**.

To protect the Smart-Tracker module from unwanted programming, you may protect it with a password.

- Tap on **Enable** to enter a password.
- Tap on **Disable** to remove the password.

### 7.0.3 Advanced

You must contact technical support to use these options. They enable you to unblock and/or completely reset your Smart-Tracker module.

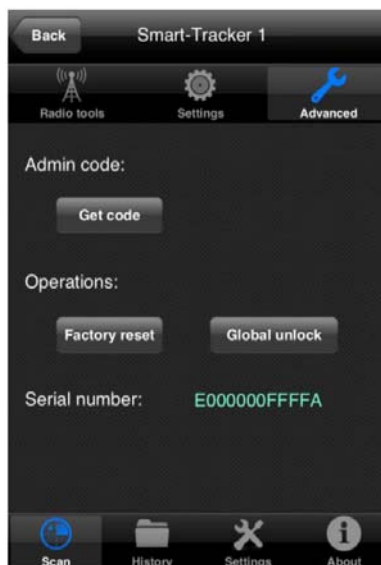

## 8 Appendix 3 – Supported devices, operating systems and versions

### 8.1 iOS® Supported iOS® versions:

- iOS® version 6 / 7 / 8

### Supported Apple® devices:

- iPhone : 4S / 5 / 5C\* / 5S\* / 6\* / 6Plus\*
- iPad: iPad 3\* / 4 / Air\* / mini

*\* Limited testing has been performed and no incompatibility has been found.*

### 8.2 Android® Supported Android® versions:

- Android® 4.3 and higher
- Android® 5\*

*\* Limited testing has been performed and no incompatibility has been found.*



### **Mobile devices compatibility:**

Only Android® mobile devices powered by an ARM v7 processor with NEON instructions set are supported.

Particularly, the following Android® devices are NOT supported (non-exhaustive list):

- Galaxy S (GT-I9000)
- Samsung Galaxy Mini (GT-S6500T)
- Samsung Galaxy Ace (GT-S5830D)
- Motorola Droid X2
- Galaxy Tab 7 (P1000)
- Samsung GT-S5690
- Samsung Galaxy Ace (GT-S5830i)
- Samsung Galaxy Tab 10.1 (P7500/7510)
- Samsung Galaxy S Duos (GT-S7562)
- Zenithink AML-MX REF (10 Inch Tablet)
- Samsung Galaxy Tab 3 7inch (SM-T211)
- Samsung Galaxy Pocket Neo
- Motorola Atrix 4G
- Samsung Galaxy Fame GT-S6810
- Samsung Galaxy Tab 3 10.1" 3G (GT-P5200)
- Samsung Galaxy Tab 3 10.1" WiFi (GT-P5210)
- Samsung Galaxy Tab 3 10.1" 3G (GT-P5220)
- Samsung Galaxy Tab 3 10.1" 4G (GT-P5220)
- Galaxy Tab 3 (GT-P5220)
- Huawei Ascend P6
- Galaxy tab 3 GT-P5210

## Important

For your future reference and when contacting the factory, please have the following information readily available:

License Number: \_\_\_\_\_

Date Purchased: \_\_\_\_\_

The above information can be found on the dataplate attached to the equipment. If available, please provide the date purchased, the source of purchase (manufacturer or specific agent/rep organization), and purchase order number.

---

### IF YOU NEED ASSISTANCE:

Thermo Scientific products are backed by a global technical support team ready to support your applications. We also offer cold storage accessories, including remote alarms, temperature recorders and validation services. Visit [www.thermoscientific.com](http://www.thermoscientific.com) or call:

#### **USA/Canada**

**Sales:** +1 866 984 3766

#### **India toll free**

**Sales:** 1800 22 8374

#### **India**

**Sales:** +91 22 6716 2200

#### **China**

**Sales:** +800 810 5118 (or)  
+400 650 5118

#### **Japan**

**Sales:** +81 3 5826 1616

#### **Australia**

**Sales:** +61 39757 4300

#### **Austria**

**Sales:** +43 1 801 40 0

#### **Belgium**

**Sales:** +32 53 73 42 41

#### **France**

**Sales:** +33 2 2803 2180

#### **New Zealand**

**Sales:** +64 9 980 6700

#### **Germany international**

**Sales:** +49 6184 90 6000

#### **Germany national toll free**

**Sales:** 0800 1 536 376

#### **Italy**

**Sales:** +32 02 95059 552

#### **Netherlands**

**Sales:** +31 76 579 55 55

#### **Nordic/Baltic/CIS countries**

**Sales:** +358 9 329 10200

#### **Russia**

**Sales:** +7 812 703 42 15

#### **Spain/Portugal**

**Sales:** +34 93 223 09 18

#### **Switzerland**

**Sales:** +41 44 454 12 22

#### **UK/Ireland**

**Sales:** +44 870 609 9203

#### **Other Asian countries**

**Sales:** +852 2885 4613

#### **Countries not listed**

**Sales:** +49 6184 90 6000

Thermo Fisher Scientific Inc.

275 Aiken Road  
Asheville, NC 28804  
United States

[www.thermofisher.com](http://www.thermofisher.com)

**Thermo**  
SCIENTIFIC