

Thermo Scientific Vacuum Oven

Operating Manual LT1495X2 (7006258) Rev. 4



Visit us online to register your warranty
www.thermoscientific.com/labwarranty

Thermo
SCIENTIFIC

Models covered in this manual:

Catalog Numbers	Model Numbers	Voltage	Feature	Size (cu ft)
3608	6258	120V	Dial thermometer	0.7
3608-5	6263	120V	LED temp display	0.7
3608-1CE	6264	220-240V	Dial thermometer	0.7
3608-6CE	6267	220-240V	LED temp display	0.7
3618	6270	120V	LED temp display	2.3
3618-1CE	6272	220-240V	LED temp display	2.3
3618-5	6273	120V	LED temp display	2.3
3618-6CE	6274	220-240V	LED temp display	2.3

MANUAL NUMBER LT1495X2 (7006258)

4	40982/OV-662	8/5/16	Updated amps in Specification from 12 to 13.5 for 3618, 3618-5	ccs
3	29551	2/21/13	Updated voltage specs of 240V units to say 220-240V	ccs
2	28472	4/4/12	Updated RH range in Specifications	ccs
1	27838/OV-380	10/5/11	Updated specs information - pg 3-2	ccs
0	--	3/31/10	Transfer to Marietta (was LT1495X2)	ccs
REV	ECR/ECN	DATE	DESCRIPTION	By



Important Read this instruction manual. Failure to read, understand and follow the instructions in this manual may result in damage to the unit, injury to operating personnel, and poor equipment performance. ▲

Caution All internal adjustments and maintenance must be performed by qualified service personnel. ▲

Material in this manual is for information purposes only. The contents and the product it describes are subject to change without notice. Thermo Fisher Scientific makes no representations or warranties with respect to this manual. In no event shall Thermo be held liable for any damages, direct or incidental, arising out of or related to the use of this manual.

©2010 Thermo Fisher Scientific. All rights reserved.



Important operating and/or maintenance instructions. Read the accompanying text carefully.



Potential electrical hazards. Only qualified persons should perform procedures associated with this symbol.



Equipment being maintained or serviced must be turned off and locked off to prevent possible injury.



Hot surface(s) present which may cause burns to unprotected skin, or to materials which may be damaged by elevated temperatures.



WEEE Compliance: Thermo Fisher Scientific has contracted with companies for recycling/disposal in each EU Member State. For further information, send an email to weee.recycle@thermofisher.com.



- ✓ Always use the proper protective equipment (clothing, gloves, goggles, etc.)
- ✓ Always dissipate extreme cold or heat and wear protective clothing.
- ✓ Always follow good hygiene practices.
- ✓ Each individual is responsible for his or her own safety.

Do You Need Information or Assistance on Thermo Scientific Products?

If you do, please contact us 8:00 a.m. to 6:00 p.m. (Eastern Time) at:

1-740-373-4763

1-800-438-4851

1-877-213-8051

<http://www.thermofisher.com>

service.led.marietta@thermofisher.com

www.unitylabservices.com

Direct

Toll Free, U.S. and Canada

FAX

Internet Worldwide Web Home Page

Tech Support Email Address

Certified Service Web Page

Our **Sales Support** staff can provide information on pricing and give you quotations. We can take your order and provide delivery information on major equipment items or make arrangements to have your local sales representative contact you. Our products are listed on the Internet and we can be contacted through our Internet home page.

Our **Service Support** staff can supply technical information about proper setup, operation or troubleshooting of your equipment. We can fill your needs for spare or replacement parts or provide you with on-site service. We can also provide you with a quotation on our Extended Warranty for your Thermo Scientific products.

Whatever Thermo Scientific products you need or use, we will be happy to discuss your applications. If you are experiencing technical problems, working together, we will help you locate the problem and, chances are, correct it yourself...over the telephone without a service call.

When more extensive service is necessary, we will assist you with direct factory trained technicians or a qualified service organization for on-the-spot repair. If your service need is covered by the warranty, we will arrange for the unit to be repaired at our expense and to your satisfaction.

Regardless of your needs, our professional telephone technicians are available to assist you Monday through Friday from 8:00 a.m. to 6:00 p.m. Eastern Time. Please contact us by telephone or fax. If you wish to write, our mailing address is:

Thermo Fisher Scientific (Asheville) LLC
401 Millcreek Road, Box 649
Marietta, OH 45750

International customers, please contact your local Thermo Scientific distributor.

Table of Contents

Section 1	Description	1-1
Section 2	Safety Information	2-1
Section 3	Specifications	3-1
Section 4	Unpacking and Installation	4-1
	Location	4-1
	Hose Connections	4-1
	Thermometer	4-2
	Electrical Requirements	4-2
Section 5	Features	5-1
	Control Panel-Models w/ Dial Thermometer	5-1
	Control Panel-Models w/ LED Readout	5-2
Section 6	Operation	6-1
	Loading the Oven	6-1
	Temperature Control	6-1
	Unloading the Oven	6-2
	Purging the Chamber with Inert Gas	6-2
	Releasing the Vacuum	6-2
	Maintaining Proper Vacuum Level	6-2

Section 7	Maintenance	7-1
	Routine Cleaning	7-1
	Care and Cleaning of Stainless Steel	7-2
	The pH Factor	7-2
	Guidelines	7-2
	Cleansing Agents	7-3
	Special Considerations	7-3
	Cleaning Methods	7-4
	Disinfection	7-5
	Door Gasket Lubrication	7-5
Section 8	Troubleshooting	8-1
Section 9	Servicing	9-1
	Heat Status Lamp Replacement	9-1
	Control Thermostat Replacement	9-1
	Vacuum/Vent Valve Replacement	9-2
	Back Panel Components	9-3
	Vacuum Gauge Replacement	9-3
	Door Gasket Repairs	9-4
	Replacement Parts	9-6
Section 10	Electrical Schematics	10-1
	Ordering Procedures	10-5

Section 1 Description

Thermo Scientific Vacuum Ovens are designed for drying media under carefully controlled conditions - in a normal atmosphere, a vacuum of up to 30 inches Hg, or an inert gas atmosphere.

The oven is primarily used for desiccating, vacuum embedding, plating and electronic component processing. Non-corrosive, nonflammable gases such as nitrogen and carbon dioxide can be used in the oven.

All controls and connections (except electrical power) are located on the front vertical panel - these include lighted power switch, vacuum gauge, temperature control, vacuum control valve and nickel-plated hose connectors.

Uniform radiant wall heat, with no internally exposed heaters, optimizes chamber space. 3" (76mm) of glass wool insulation throughout helps maintain temperature uniformity effectiveness. Temperature is controlled by a hydraulic thermostat and can be read on a dial thermometer or LED display.

The chamber of the unit is not designed for exposure to concentrated solvents, oils, concentrated acids or dilute sodium hydroxide.

Vacuum levels are precisely held between 0" and 30" of mercury.

The silicone door gasket assures a tight seal at all vacuum levels. A high strength tempered glass window allows full view of oven contents. Two aluminum shelves provide good heat conduction to samples. The shelf assembly removes for easy cleaning.

Note When operating in a vacuum, there is no transfer of heat from the evacuated chamber interior to objects within the chamber unless they are resting directly upon one of the shelves - do not put insulating material between a shelf and a vessel being heated. Also, be sure that a thermometer's sensor element is in direct contact with the surface of the center shelf when taking a reading. ▲

Section 2 **Safety Information**

Your Thermo Scientific Vacuum Oven has been designed with function, reliability, and safety in mind. It is your responsibility to install it in conformance with local electrical codes. It is most important that the user follow installation instructions exactly as written. Failure to do so is likely to lead to improper operation, erroneous calibrations and possible damage to the equipment. Use in the manner specified by the manufacturer. The protection provided by the equipment may be impaired. Do not attempt operation without this information.

Section 3 Specifications

Electrical Requirements

3608, 3608-5:

120 Volts, 50/60 Hz, 5.0 Amps, 600 Watts

3608-1CE, 3608-6CE:

220-240 Volts, 50/60 Hz, 2.5 Amps, 600 Watts

3618, 3618-5:

120 Volts, 50/60 Hz, 13.5 Amps, 1600 Watts

3618-1CE, 3618-6CE:

220-240 Volts, 50/60 Hz, 6.7 Amps, 1600 Watts

Temperature Range

All Models: Slightly above ambient to 220°C

Thermometer Type

3608, 3608-1, 3618, 3618-1:

Bimetallic dial type; range from 0°C to 300°C in 5°C increments

3608-5, 3608-6, 3618-5, 3618-6:

LED Display; range from 0°C to 300°C in 1°C increments

Chamber Dimensions

3608, 3608-1CE, 3608-5, 3608-6CE:

.....10"W x 12"D x 10"H (25 x 30 x 25 cm)

3618, 3618-1CE, 3618-5, 3618-6CE:

.....14"W x 20"D x 14"H (36 x 51 x 36 cm)

Overall Dimensions:

3608, 3608-1CE, 3608-5, 3608-6CE:

19-7/8"W x 16"D x 16-1/4"H (50 x 40 x 41 cm)

3618, 3618-1CE, 3618-5, 3618-6CE:

25"W x 25"D x 22"H (64 x 64 x 56 cm)

Volume

3608, 3608-1, 3608-5, 3608-6CE: . . . 0.7 cubic feet (19.8 liters)

3618, 3618-1CE, 3618-5, 3618-6CE: . . . 2.3 cubic feet (65.1 liters)

Net Weight

3608, 3608-1CE, 3608-5, 3608-6CE: . . . 83 lbs. (38 kg)

3618, 3618-1CE, 3618-5, 3618-6CE: . . . 150 lbs. (68 kg)

Environmental Conditions

Indoor use only

Operating: 15°C to 40°C

Humidity: 20% to 80%

Voltage Fluctuation: ±10% of nominal

Installation Category II (overvoltage) in accordance with IEC 664.

Pollution Degree 2 in accordance with IEC 664.

Altitude Limit: 2,000 meters.

Storage: -25°C to 65°C, 10% to 85% RH

Declaration of Conformity (for 220 to 240 volt, CE models only)

We hereby declare under our sole responsibility that this product conforms with the technical requirements of the following standards:

EMC:

EN 61000-3-2: Limits for harmonic current emissions

EN 61000-3-3: Limits for voltage fluctuations and flicker

EN 61326-1: Electrical equipment for measurement, control, and laboratory use; Part I: General Requirements

Safety: EN 61010-1: Safety requirements for electrical equipment for measurement, control, and laboratory use; Part I: General Requirements

EN 61010-2-010 Part II: Particular requirements for laboratory equipment for the heating of materials

per the provisions of the Electromagnetic Compatibility Directive 89/336/EEC, as amended by 92/31/EEC and 93/68/EEC, and per the provisions of the Low Voltage Directive 73/23/EEC, as amended by 93/68/EEC.

Copies of the Declaration of Conformity are available upon request.

Section 4 Unpacking and Installation

The shipping carton should be inspected upon delivery. When received, carefully examine for any shipping damage before unpacking. If damage is discovered, the delivering carrier should both specify and sign for the damage on your copy of the delivery receipt.

Open the carton carefully making certain that all parts are accounted for before packaging materials are discarded. After unpacking, if damage is found promptly report it to the carrier and request a damage inspection promptly.

Important Failure to request an inspection of damage within a few days after receipt of shipment absolves the carrier from any liability for damage. You must call for a damage inspection promptly. ▲

Location

Place the unit where it will be operated, away from drafts and wide variations in ambient temperature. It should be near a power source that matches the unit nameplate requirements. Allow clearance of a minimum of 2" around the unit for free air convection, hose/accessory attachment and user-access. DO NOT put the oven on top of or underneath another oven, or on a combustible surface.

Hose Connections

Connect a 1/4-inch ID vacuum hose to the left hose connector on the control panel that is marked "EVACUATE". Connect the other end of the hose to a vacuum pump.

If operation will include replacing the vacuum in the chamber with an inert gas such as carbon dioxide or nitrogen, connect a 1/4-inch ID flexible hose to the right hose connector that is marked "VENT" and to the regulator for the gas supply. DO NOT use combustible, flammable or corrosive gases.

Electrical Requirements

The unit is supplied with a 3-wire line cord. It should be plugged into an outlet supplying the correct voltage for the unit and designed for 3-prong plugs.

For an outlet designed to accept 2-prong (ungrounded) plugs, the best recommendation is to have a qualified electrician replace it with a new grounded outlet.

If a plug must be installed, use only the 3-prong grounded type, rated for the unit load requirements and matching the power outlet. Make sure the green ground wire is secured to the plug ground post.

Turn the power switch OFF and insert the plug into the outlet.

Note Disconnect unit from power source when not in use. ▲

Caution Disconnect plug from electrical outlet before attempting any maintenance or repair on this unit. ▲

Thermometer

For models using the dial thermometer - 3608, 3608-1CE, 3618 and 3618-1CE - place the thermometer so that the sensing element is in direct contact with the top shelf. The dial should be easily visible through the glass door.

Models with the LED display of temperature - 3608-5, 3608-6CE, 3618-5 and 3618-6CE - are easily identifiable with the LED positioned just below the power switch. Ensure that the RTD block is installed and making contact with the shelf.

Section 5 Features

Control Panel-Models w/ Dial Thermometer

1. **Power Switch:** Power is on to the unit when this switch lamp is lit. (To reset the circuit breaker, turn this switch to Off, then On.)
2. **Control Thermostat and Status Lamp:** Adjust manually to control oven temperature. A permanently-set bimetallic thermostat (not on the panel) limits oven temperature at 250°C should the control thermostat fail.
3. **Vacuum Gauge:** Displays chamber level to 30-inches of mercury.
4. **Vacuum/Vent Valve:** 3-way valve draws, holds or releases a vacuum.
5. **Hose Connectors:** Marked "EVACUATE" and "VENT" for 1/4" flexible tubing to connect to a gas source or vacuum pump.

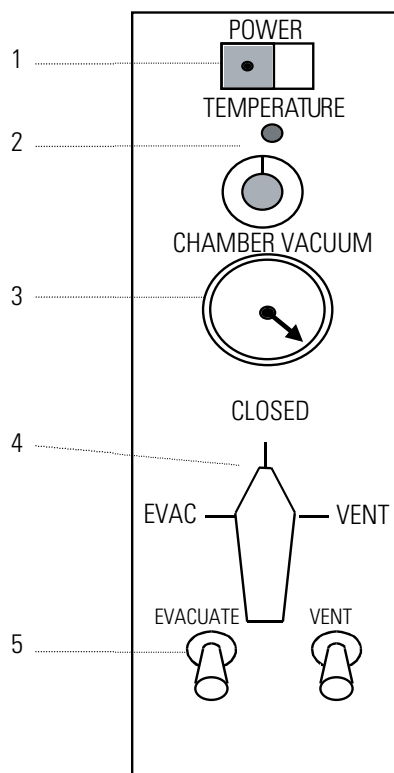

Control Panel-Models w/ LED Readout

1. **Power Switch:** Power is on to the unit when this switch lamp is lit. (To reset the circuit breaker, press this switch to off, then on.)
2. **LED Temperature Display:** Readout of temperature.
3. **Control Thermostat and Status Lamp:** Adjust manually to control oven temperature. A permanently-set bimetallic thermostat (not on the panel) limits oven temperature at 250°C should the control thermostat fail.
4. **Vacuum Gauge:** Displays chamber level to 30-inches of mercury.
5. **Vacuum/Vent Valve:** 3-way valve draws, holds or releases a vacuum.
6. **Hose Connectors:** Marked "EVACUATE" and "VENT" for ¼" flexible tubing to connect to a gas source or vacuum pump.

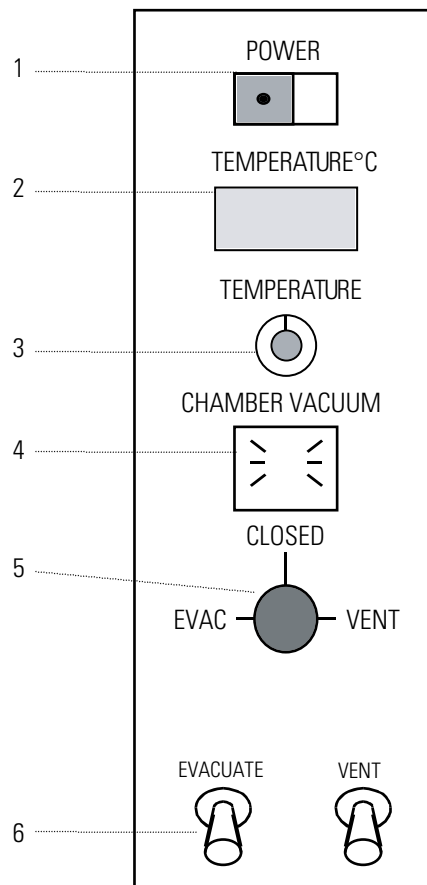

Section 6 Operation

Caution Do not use in the presence of flammable or combustible materials or explosive gases. Do not use in the presence of pressurized or sealed containers - fire or explosion may result, causing death or severe injury. ▲

Caution Do not heat any substance above a temperature which will cause it to emit toxic fumes - death or severe injury may result. ▲

Temperature Control

If it is necessary to set temperature before loading oven, push the power switch ON and note that the power switch light is lit. Rotate the thermostat knob to approximate the desired setting. The heater status lamp will be steadily lit until the chamber temperature approaches the thermostat setting. Wait several heat cycles until the temperature has stabilized.

Check the thermometer - dial or LED display - and rotate the thermostat knob clockwise to raise the set point or counterclockwise to lower it. After oven temperature has stabilized, check the temperature again and make further thermostat adjustments until the thermometer consistently shows the desired operating temperature. Push the power-switch OFF and allow the oven to cool down, or, if a batch is ready, the oven can be loaded immediately.

Loading the Oven

For units which utilize a dial thermometer, the thermometer can be removed and put back after loading if that is more convenient. Note that the thermometer sensing element must be in direct contact with a shelf for an accurate reading.

For best results, distribute the load evenly in the chamber, at least 1-inch away from chamber walls and resting directly on the shelves. **DO NOT PLACE FLAMMABLE SOLVENTS OR VAPORS** in the oven and avoid spilling acids. Be careful not to heat substances above their autoignition temperatures.

While the oven door is open, apply high temperature vacuum grease to the door gasket. Close the door and push the power switch ON. If oven temperature was not previously set, review above at “TEMPERATURE CONTROL” to set the desired operating temperature.

Maintaining Proper Vacuum Level

The vacuum level will decrease slightly over a period of time. To bring it back up, rotate the vacuum/vent valve to "EVACUATE" and start the vacuum pump.

When the vacuum gauge again shows the desired level, rotate the vacuum/vent valve to the setting marked "CLOSED" and shut off the vacuum pump.

Caution Do not pressurize the chamber above atmospheric pressure - the oven will not withstand a positive internal pressure. When the vacuum gauge reads zero, shut the gas off. ▲

Releasing the Vacuum

If the vacuum is to be replaced by ambient air, disconnect any tubing attached to the hose connector marked "VENT" and rotate the vacuum/vent valve to its "VENT" setting.

Purging the Chamber with Inert Gas

Use only a non-combustible, nonflammable, non-corrosive gas - such as nitrogen or carbon dioxide - if application requires replacing the vacuum with an inert gas.

Connect 1/4-inch ID tubing to the hose connector marked "VENT" and connect the other end of the tubing to the regulator at the inert gas source.

Start the gas flowing at no more than 5 psi. Rotate the vacuum/vent valve to the "VENT" position and shut off the regulator when the vacuum gauge reads zero (normal atmospheric pressure).

The oven does not require very much gas to fill the chamber:

3608 Series: Interior volume is 0.75 cubic feet.

3618 Series: Interior volume is 2.30 cubic feet.

Unloading the Oven

When the bake is completed and the vacuum has been released or replaced as described earlier, turn the power switch to OFF. Open the oven door and remove the dial thermometer. Take the contents from the chamber and reinsert the thermometer with the sensing element in direct contact with the center shelf.

Section 7 Maintenance

Note Make no attempt to service or repair a Thermo Scientific product under warranty before consulting your Thermo dealer. After the warranty period, such consultation is still advised, especially when the repair may be technically sophisticated or difficult. If assistance is needed beyond what the distributor can provide, please call Technical Services. No merchandise should be returned directly to the factory without obtaining a Return Materials Authorization (RMA) number from Customer Service. ▲

Caution Service must be performed by qualified service personnel only. ▲

Caution Disconnect plug from electrical outlet before attempting any maintenance or repair of this unit. ▲

Routine Cleaning

Wash the cabinet with a solution of water and mild soap or detergent to clean off surface dirt, marks or smudges.

Keep the vents clear of dust for free air circulation. This will add to the service life of components.

The aluminum shelf assembly should be washed with a mild soap and water. Do not use abrasive or halogen-based cleaners - they will damage the finish. Rinse thoroughly and dry completely.

Wipe interior glass with an ammonia-based glass cleaner and a soft, lint-free cloth.

Clean up spills inside the chamber as soon as possible to prevent them from being baked on. When the oven is cool, use hot soapy water and a soft cloth to clean the #304 stainless steel chamber. Do not use scouring pads with metallic content, chlorine bleach or halogen-based cleaners (special order units may come with stainless steel shelves, in addition to the stainless steel interior).

Care and Cleaning of Stainless Steel

Caution Electrolysis can damage stainless steel. This occurs when an object is allowed to rest directly on the surface of stainless steel, trapping moisture that becomes oxygen-starved, but is surrounded by water-containing oxygen. ▲

Warning Electrolysis can damage stainless steel. This occurs when an object is allowed to rest directly on the surface of stainless steel, trapping moisture that becomes oxygen-starved, but is surrounded by water containing oxygen. ▲

Stainless steel is an alloy of steel with chromium and nickel that increases the metal's resistance to rust and corrosion. Yet, if not properly cared for, stainless steel can rust and corrode.

Exposure to air provides the passivation, or oxide layer coating, for clean stainless by producing a thin, durable chromium-oxide film that forms rapidly on the alloy surface to give stainless its characteristic "stainless" quality. Also exposure of the surface to other oxidizing environments can produce a passivating film or coating.

However, if free oxygen is not available due to scale or contamination buildup, the metal surface may become vulnerable to rusting and corrosion as well as pitting. But by maintaining neutral pH and conducting frequent cleanings with detergent and water, years of trouble-free service from stainless steel products can be obtained.

Guidelines

Distilled water is recommended. Please note, if this water is very pure, it may be corrosive to stainless. When filling a bath or incubator, ALWAYS add 2 to 40 ppm (20 to 40mg/liter) disodium phosphate or sodium bicarbonate, adjusting dosage to provide a pH value of 7 to 9. If not available, use clean, aerated soft tap water provided the total solids concentration is < 500 PPM. We do NOT recommend using 18M ohm deionized water. If this is the only source of treated water available, mix with regular tap water at a 50/50 ratio.

The pH Factor

Check pH regularly. If pH is <6.0, add disodium phosphate to increase pH to a 7 to 9 value. Sodium carbonate or sodium bicarbonate may be used but they tend to form scale that must be rinsed out regularly. If pH is >10.0, add sodium bisulfate to decrease pH to a 7 to 9 value. Avoid adding harsh alkalines or acids since these may cause localized corrosion and result in unstable pH.

Special Considerations

Warning If it is necessary to use the following chemicals, limit exposure time to a maximum of 3 hours. ▲

Aluminum chloride	E.D.T.A.	Potassium permanganate
Barium chloride	Ferrous chloride	Potassium thiocyanate
Calcium chloride	Lysol	Sodium hypochlorite
Chlorinated Lime	Mercury salts	Stannous chloride
Citric acid (boiling)	Phenol	Tartaric acid
Dakin's solution		

Always clean surfaces immediately after use.

Caution Never use the following on stainless steel:

- Aqua regia
- Ferric chloride
- Iodine
- Sodium acid
- Sodium azide

Chemical spills, especially those agents listed here, should be removed as soon as possible and the stainless steel surface cleaned with mild soapy water followed by a clean water rinse.

Cleansing Agents

Anti-fungal and anti-bacterial additives are permissible to use as long as the pH of the aqueous solution is kept within the range of 7 to 9. These are available through laboratory distributors - but be sure to CONFIRM that they are not harmful to stainless steel.

Cleaning Methods

Do not use any metallic pads. Instead, for stubborn stains, use a plastic light-duty cleansing pad and rub GENTLY in the direction of the metal grain.

Caution Extreme care must be taken when handling the materials described below. Always work in an area with adequate ventilation. Use the precautions as outlined in the Material Safety Data Sheet (MSDS) and the manufacturer instructions for the product being utilized. Also, follow the personal protection index found in the Hazardous Materials Information System (HMIS) section of the MSDS. ▲

If stains continue to persist, use one of the following chemicals and methods:

- Any of a variety of “scale removers” available at local supermarkets or hardware stores used for the cleaning of coffee marks, humidifiers or vaporizers.
- A 15% to 35% phosphoric acid solution available from laboratory supply distributors for scale and rust removal. Allow solution to soak the surface affected until rust and scale is loosened. Immediately follow with a clean water rise.
- Citric acid based cleaners.
- Bathroom tub and tile cleaners.
- A mixture of 20% nitric acid and 1.5% hydrofluoric acid (or 1.5% hydrochloric acid). Swab solution on surface allowing it to remain until rust is loosened. Immediately follow with a clean water rise. (This method should ONLY be used if SEVERE rust and scale stains are present.)
- Oxalic acid 2% to 5% in warm water. Swab solution on surface allowing it to remain until rust is loosened. Immediately follow with a clean water rise. (This method should ONLY be used if SEVERE rust and scale stains are present.)

Regardless of the approach utilized, ALWAYS follow the manufacturer’s directions and allow the chemicals to do the cleaning with MINIMAL scrubbing.

Always follow cleanings with a clean water rinse. Air dry.

Note The use and disposal of these chemicals may be regulated by your local city codes; consult those regulations before of disposing of these materials. ▲

Disinfection

The materials listed below are effective when used for disinfection purposes.

- Glutaraldehyde
- Alcohol

Note This information is intended as guidelines only and we make no claim as to the suitability to any particular situation. Consult your staff chemist to determine what would be best for your stainless steel product and laboratory. ▲

Door Gasket Lubrication

Apply a high-quality vacuum grease to the door gasket frequently, especially before initiating a vacuum. Also apply high temperature vacuum grease to the gasket after shutdown, if the oven will not be used in the near future.

Section 8 Troubleshooting

There are few oven parts that will require repair. In case of a malfunction, the control thermostat, limit thermostat, heater status lamp, heaters, power switch, vacuum/vent valve and vacuum gauge are fairly easy to replace.

Use this troubleshooting guide to find a possible source of any problem, then test and/or make replacement as described.

Caution Before starting any repair, disconnect power cord from outlet. ▲

SYMPTOM	POSSIBLE CAUSES OF PROBLEM
Excessive vacuum leaks:	Check door gasket and door alignment.
	Check for loose connections/fittings.*
	Check the vacuum/vent valve—order a replacement if it is leaking.*
Won't vent or evacuate:	Check for open fittings, large leaks.*
	Check vacuum/vent valve; replace if bad.*
	Check tubing & fittings for obstruction.*
	Apply high quality vacuum grease to door gasket.
Vacuum gauge not at zero when oven door is open:	Replace the vacuum gauge.*
Power switch does not light:	Check power cord and outlet for power.
	Check main fuses inside back cover.
	Replace the power switch if necessary.
Heater status lamp is out when cold oven is heating up:	Replace the heater status lamp.
The thermostat is set at maximum and thermometer does not register or only registers partial heating:	Move thermometer in contact with shelf.
	Check both thermostats - replace if bad.
	Make ohmmeter check of heater resistance and replace faulty heater(s).

Section 9 Servicing

Caution Turn the power switch to Off and unplug the oven before attempting any service or repairs on the unit. ▲

Control Thermostat Replacement

Disconnect power and remove the control panel, back panel (edge screws) and insulation.

- Locate the thermostat bulb from the back of the oven attached to the right-side heater on the vacuum chamber. Slide the bulb from its bracket.
- Remove the thermostat knob by loosening the setscrew and take the old thermostat from the control panel. Move the 3 leads to new thermostat, referring to the wiring schematic if necessary.
- Install the new thermostat on the control panel and tighten the knob onto it. Uncurl enough sensor tubing to slide the new bulb into its bracket with several inches of slack. Route the sensor tubing to prevent electrical shorts to other components.
- Replace the insulation and the back panel. Replace the control panel, power up and test run the oven.

Heat Status Lamp Replacement

Disconnect power. Refer to the wiring schematic.

- Remove the status lamp lead at the terminal block and thermostat.
- Push the new lamp in place. Attach the new lamp leads to the thermostat and terminal block.
- Power up and test the new status lamp.

Vacuum/Vent Valve Replacement

Disconnect power. Referring to the piping diagram below, loosen the tubing from 3 compression fittings on the vacuum/vent valve on the control panel.

- Remove the control panel valve handle by loosening the hex setscrew. Then unscrew the valve retaining nut on front of the panel and take the old valve from the back of the panel.
- Remove the 2 elbows and the straight connector from the valve body and install on the new valve using a thread sealant.
- Remove the valve handle from the new valve body.
- Install the new valve in the panel and tighten the retaining nut. Replace the valve handle and tighten the setscrew.
- Connect the valve assembly to the vacuum gauge tubing and compression fittings.
- Pull a vacuum and check for leaks.

Note The valve body has an anti-rotation/stop tab. This needs to be located in the top right quadrant when facing the control panel. ▲

Note All tubing to be 1/4" stainless; all threaded connection to be sealed with thread sealer. ▲

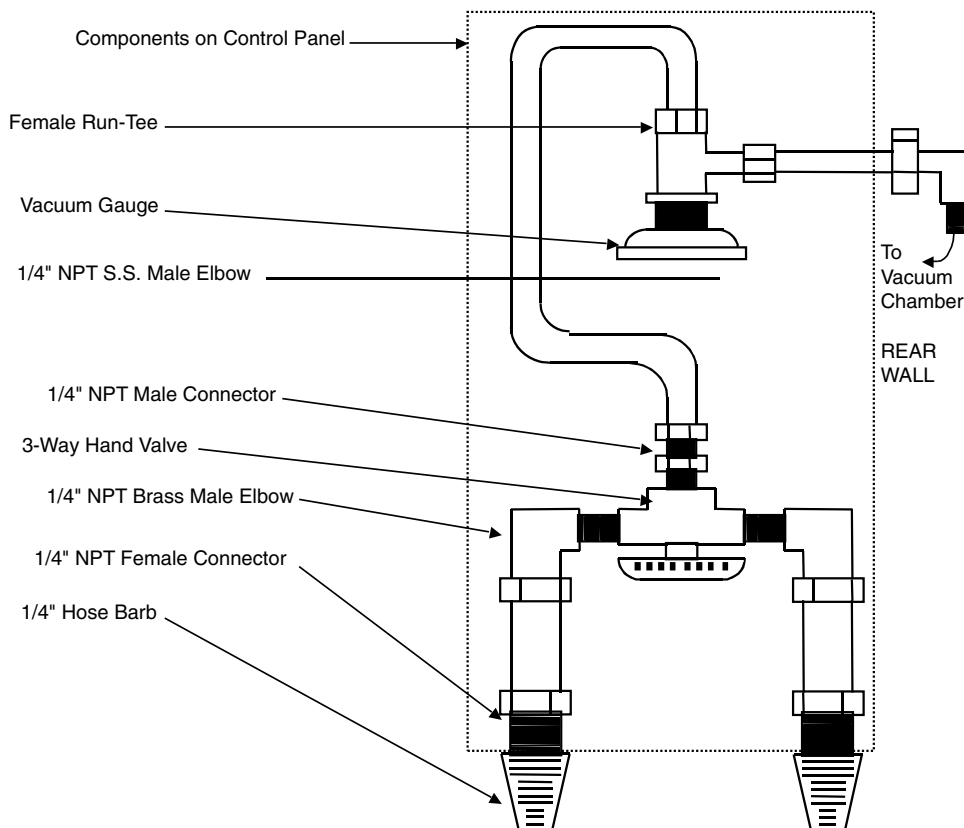

Vacuum Gauge Replacement

After disconnecting power and removing the control panel, remove copper tubing from both compression fittings on the vacuum gauge—refer to the piping diagram on previous page if necessary.

- Remove the T-fitting from the back of the gauge and take off the gauge retaining bracket by removing the two thumbnuts. Pull the old gauge out from the front of the control panel.
- Install the new gauge in the panel and replace the retaining bracket with thumbnuts.
- Clean old sealant from all male threads and apply new sealant. Install the T-fitting on the back of the new gauge and attach tubing with compression fittings to the gauge.
- Replace the control panel, draw a vacuum and check for leaks.

Back Panel Components

Hi-Limit Thermostat Replacement

Disconnect power and remove the back panel (edge screws) and insulation from around components. Locate the bimetallic limit thermostat on the back of the oven chamber.

- Remove the nut holding the thermostat in place. Disconnect the leads from it and attach them to the new thermostat.
- Secure the new thermostat onto the back of the oven chamber. Replace insulation and the back panel, then power up and test run the oven.

Fusible Link Replacement

Disconnect power and remove the back panel (edge screws) and back insulation. Locate the bimetallic limit thermostat on the back of the oven chamber.

- Disconnect the fusible link from the bimetallic thermostat and control thermostat/terminal block as connected. This is the wire assembly with the high temperature sleeving on it.
- Connect the new fusible link to the bimetallic thermostat and control thermostat/terminal block.
- Replace the insulation and back panel, then power up and test the oven.

Back Panel Components (cont.)

Heater Replacement

Disconnect power and remove the back panel (edge screws) and insulation from the back and sides. Note that oven models 6258-6267 have 2 heaters, one located on each side of the chamber; models 6270-6274 have 4 heaters, 2 located on each side.

- For models 6270-6274, the oven housing must be removed. The oven housing is held by screws around the bottom edges. Lift it off and remove the rest of the insulation.
- For all models, unscrew the heater brace nuts to remove heater braces. Pull the leads from heater terminals and test each heater for shorts or low resistance at the heating element sheath. An ohmmeter resistance reading that differs greatly from 48 ohms for Models 6258-6267, or 36 ohms for Models 6270-6274, indicates a faulty heater.
- Install a new or original heater with terminals facing down, using a new heater brace if a new heater is installed. Attach leads to the heater, so that wires do not touch any heated surfaces (see the upcoming wiring schematic). Tighten mounting nuts securely using a nickel based anti-seize on the threads.
- Replace the oven housing and front insulation. Repack side as well as back insulation, and replace the back panel.

Door Gasket Repairs

Door Gasket Replacement

After pulling the old gasket from its groove, remove all dirt and foreign matter from the groove and from the mating surface on the oven.

- Press the new gasket onto the mounting surface in the middle of the top section. Press top corners into place, then the sides. Next, fit the bottom corners, then the bottom section into place. Press and spread the gasket to set it solidly in the door groove.
- Close the door to help seat the gasket. Open the door and apply a high-quality vacuum grease to the gasket. Evacuate the oven while pressing on the door to seat the gasket firmly.

Door Gasket Repairs (continued)

Door Alignment

Inspect the door-to-gasket seal to find where the door is out of alignment. Note that there are 2 (inner and outer) sets of hinge bolts.

- Adjust vertical door position by loosening inner hinge-to-oven bolts. Tighten them securely when the door is straight.
- Adjust gasket compression tolerance (in/out movement) by the outer hinge-to-door bolts, then tighten them securely.
- After adjustment is made, check it by opening and closing the door several times. Re-grease the gasket and test the seal by evacuating the oven. (Make further adjustments if necessary.)

Note Do not let petroleum, silicone oil or grease contact the gasket or mounting groove. ▲

Replacement Parts

Description	Models 3608 Series	Models 3618 Series
	(6258 through 6267)	(6270 through 6274)
Cordset	CRX72 (120V) - 3608, 3608-5	CRX73 (120V) - 3618, 3618-5
	CRX70 (240V) - 3608-1CE, 3608-6CE, 3618-1CE, 3618-6CE	
Door Gasket	530-158-00	530-159-00
Glass Door	540-181-00	540-182-01
Heater	340-331-00 (2) - HR1, HR2	340-171-00 (4) - HR1, HR2, HR3, HR4
Heater Braces	014-247-00	583-657-00
Rubber Feet (4)	790-225-00	790-078-00
Shelf (2)	810-439-00	810-440-00
Status Lamp Base - DS1	PL1483X2	PL1496X2
Status Lamp Lens (amber) - F3	360-235-00	
Switch, Power (120V) - S1	440-359-00	
Switch, Power (240V) - S1	440-292-00	
Thermometer, Dial	910-017-00	
Thermostat, Bimetallic - S3	920-416-00 (LED display)	
Thermostat, Hydraulic - S2	CNX175	
Thermostat, Knob	560-223-00	
Vacuum Gauge	660-103-00 (Dial thermometer)	
Vacuum Gauge	660-097-00 (LED display)	
Transformer	TN1496X1 (3608-5)	TN1496X1 (3618-5)
	TN1495X2 (3608-6CE)	TN1496X2 (3618-6CE)
Vacuum/Vent Valve (2)	950-125-00	
Fuse, Main (2) - F1, F2	264306 (3608, 3608-5)	266058 (3618, 3618-5)
	710-002 (3608-1CE, 3608-6CE)	261575 (3618-1CE, 3618-6CE)
Thermal Fuse	WM1495X2	WM1496X18
RTD Sensor	410-667-00 (3608-5, 3608-6CE)	410-667-00 (3618-5, 3618-6CE)
Terminal Block (TB1)	TRX178	
Lexan Shield	659-041-00	659-020-00
Line Filter (FL1)	330-346-00 (240V)	
Power Entry Module	710-0019	--

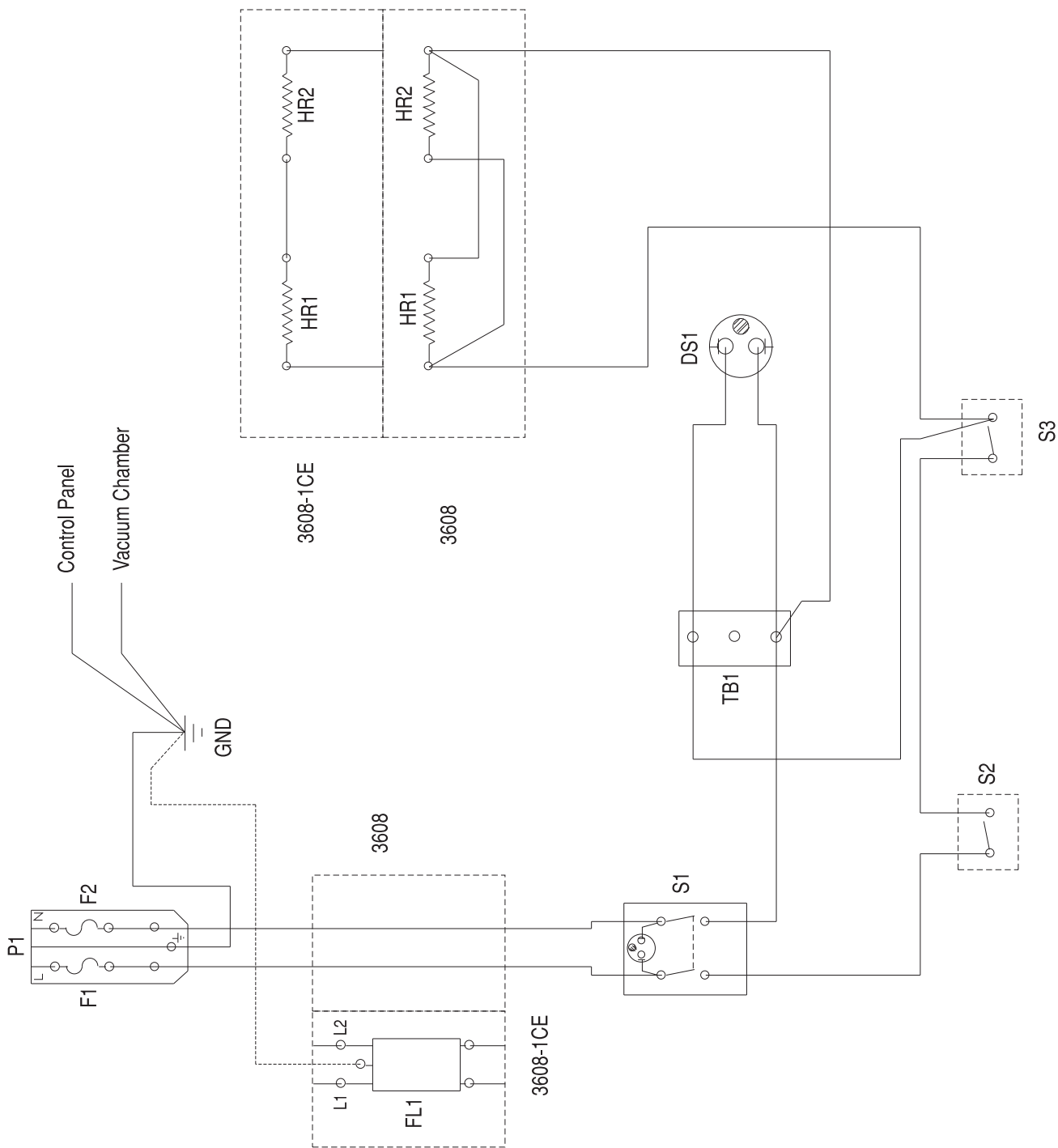

Section 10
Wiring Diagram

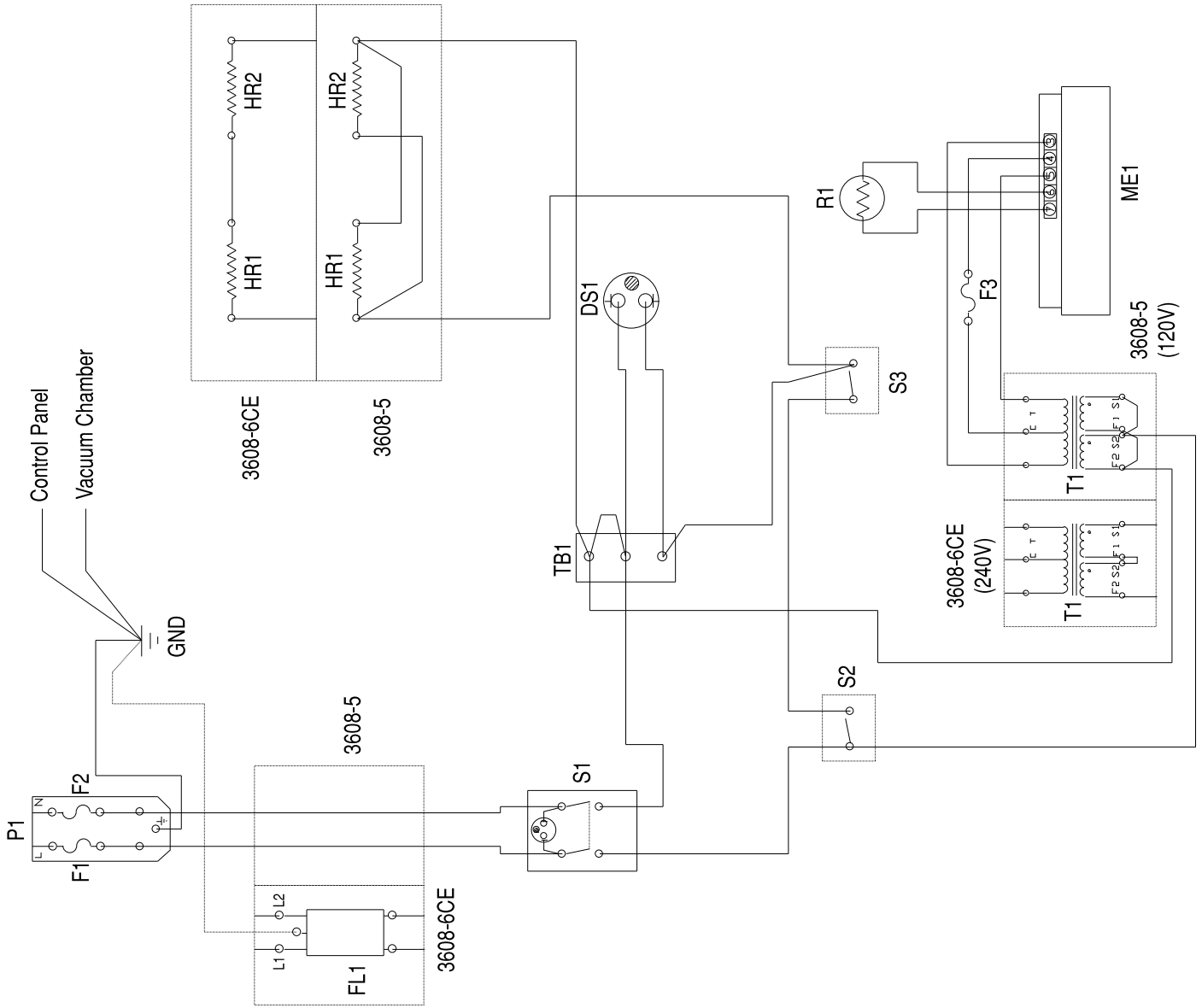

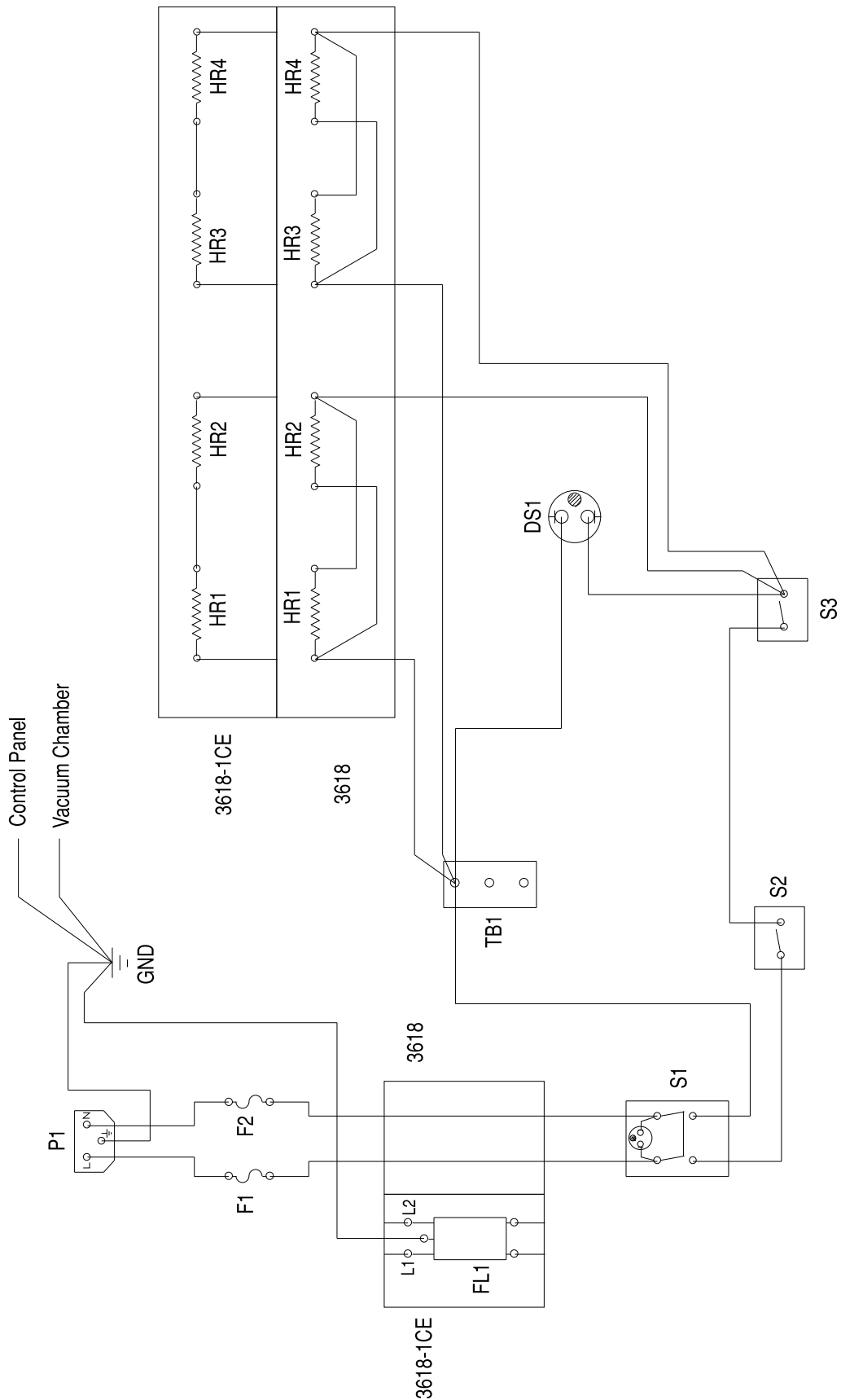

Section 10
Wiring Diagram

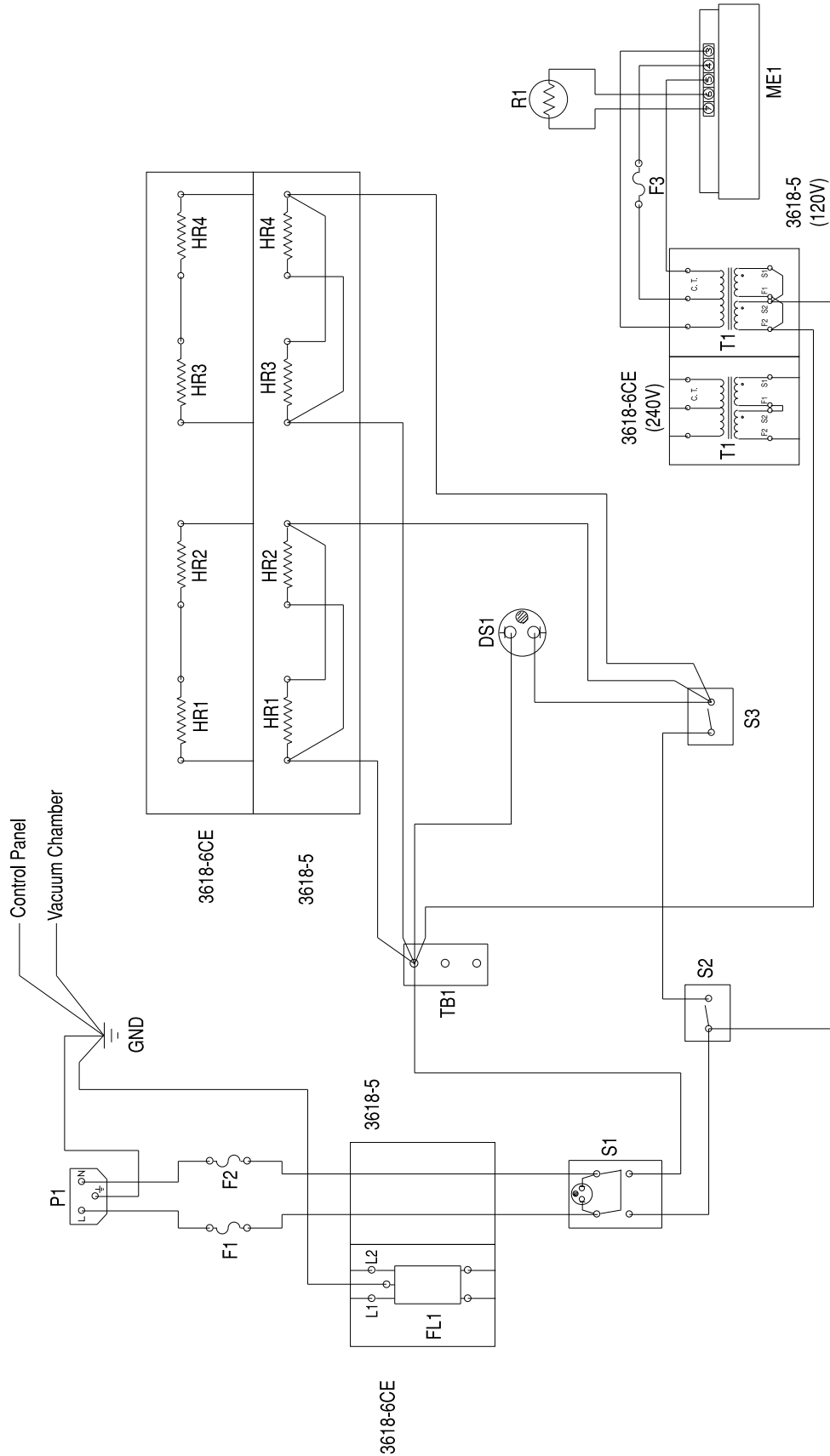

Ordering Procedures

Refer to the Specification Plate for the complete model number, serial number, and series number when requesting service, replacement parts or in any correspondence concerning this unit.

All parts listed herein may be ordered from the Thermo Scientific dealer from whom you purchased this unit, or can be obtained promptly from the factory. When service or replacement parts are needed, check first with your dealer. If the dealer cannot process your request, then contact the Technical Services Department.

Prior to returning any materials, please contact Technical Services for a "Return Materials Authorization" number (RMA). Material returned without an RMA number will be refused.

Thermo Fisher Scientific
401 Millcreek Road
Marietta, Ohio 45750
United States

www.thermofisher.com

ThermoFisher
S C I E N T I F I C