

Installing the Stand

INSTALLING THE STAND

The stand is included with the 32" TouchIT LED Duo, but a table top stand is available for all other sizes up to 82"



Installation

This stand is included for 32" and is optional for all other sizes.

1. Find the appropriate stand, take out the packaging and use the bolts included to install the back plate first.

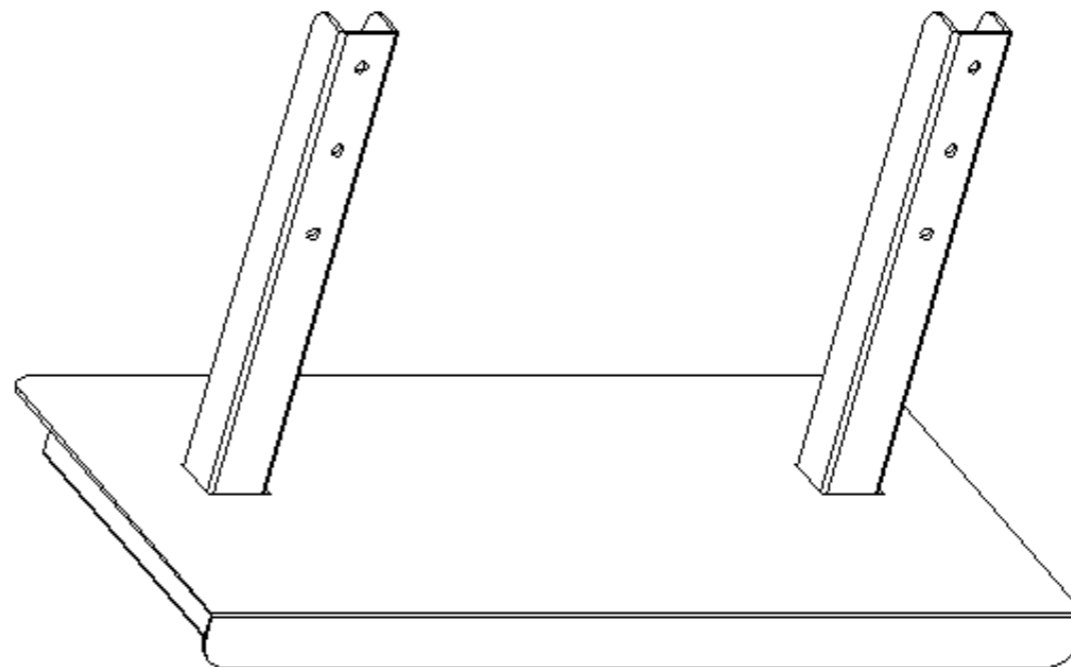

2. Assemble the stand and supporting upright. Align the sliding groove, and slide in the stand then tighten the securing bolts.

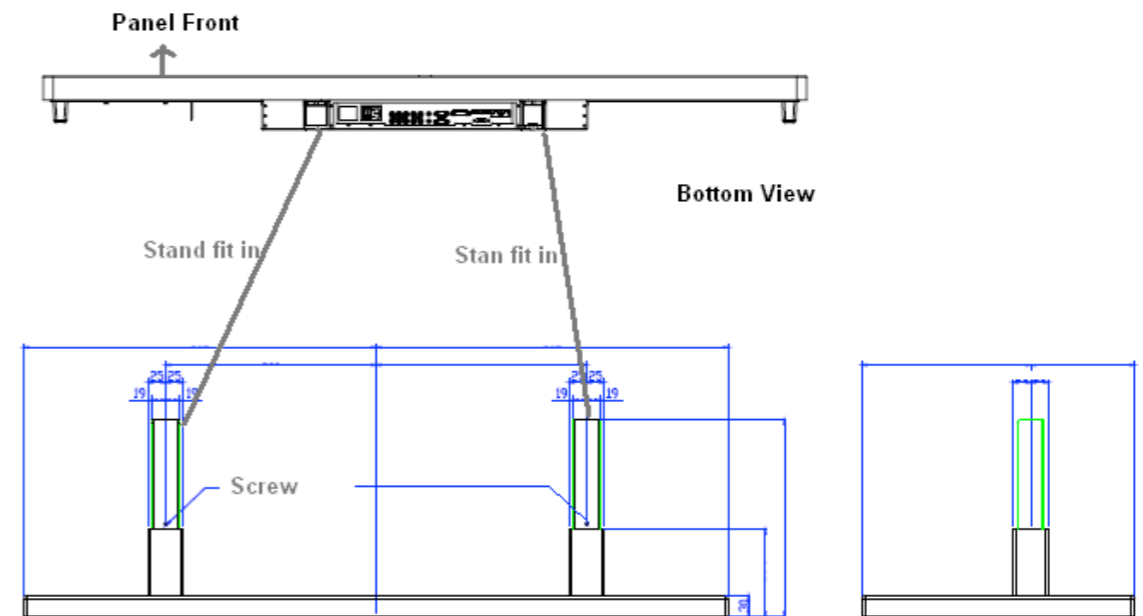
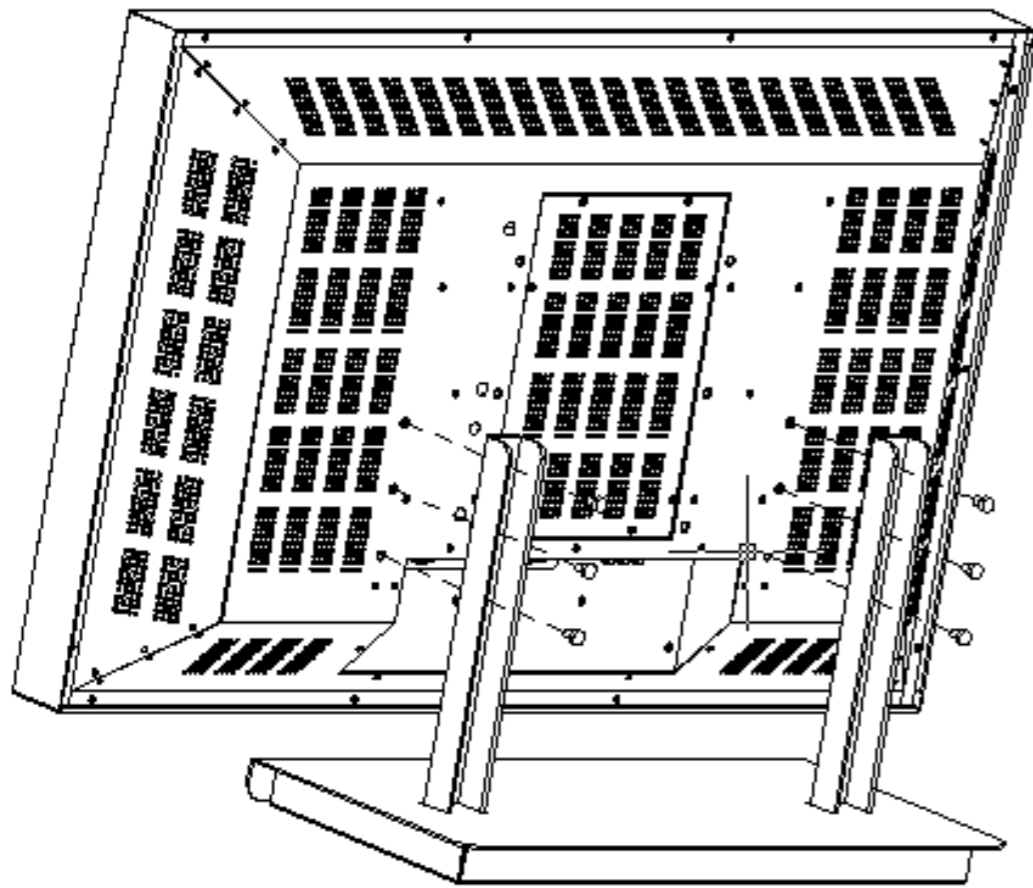

3. Stand the monitor upright, and place it to desirable position.

Wall Mount Kits

Due to the difference in weight of each model, please use only the wall mount kit that is designed for each model. If you are unsure, please check with your reseller.

32"

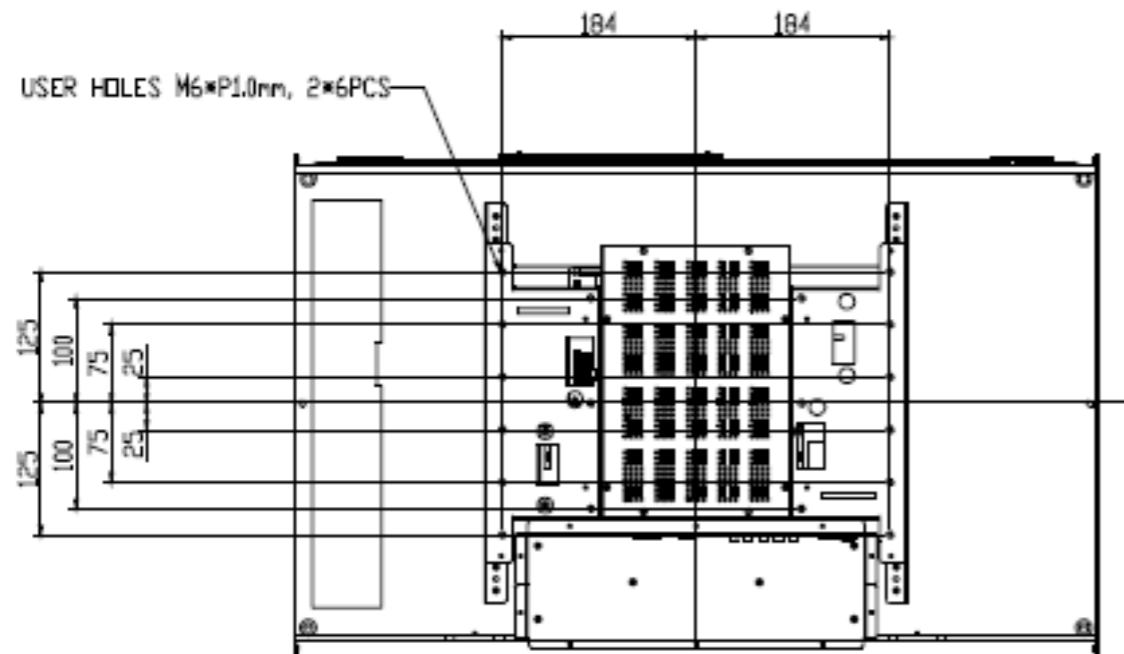

42"

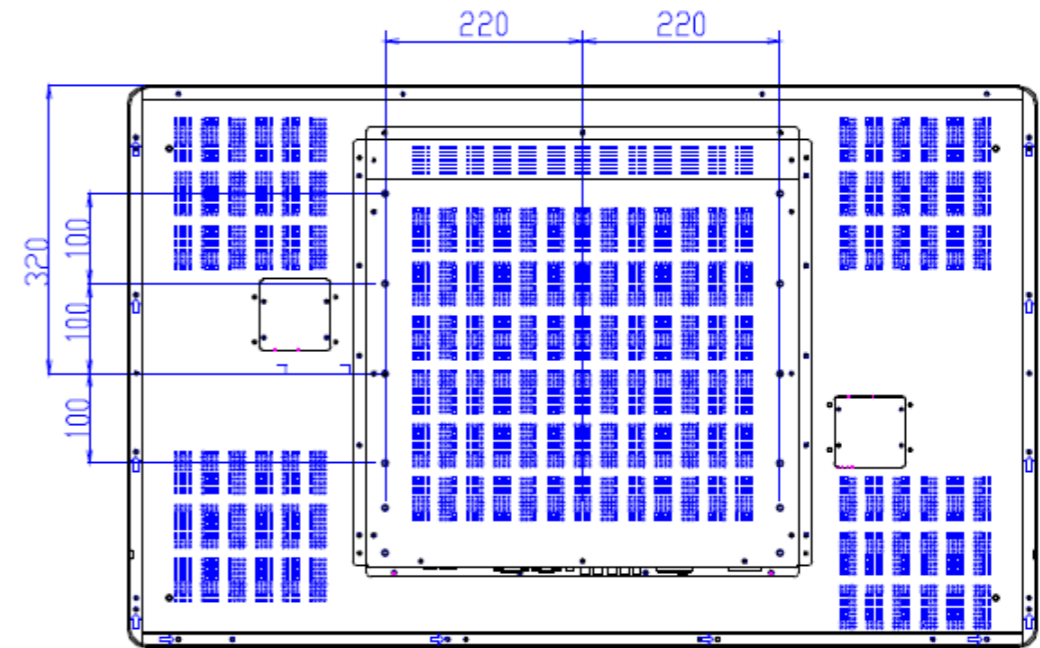

46"

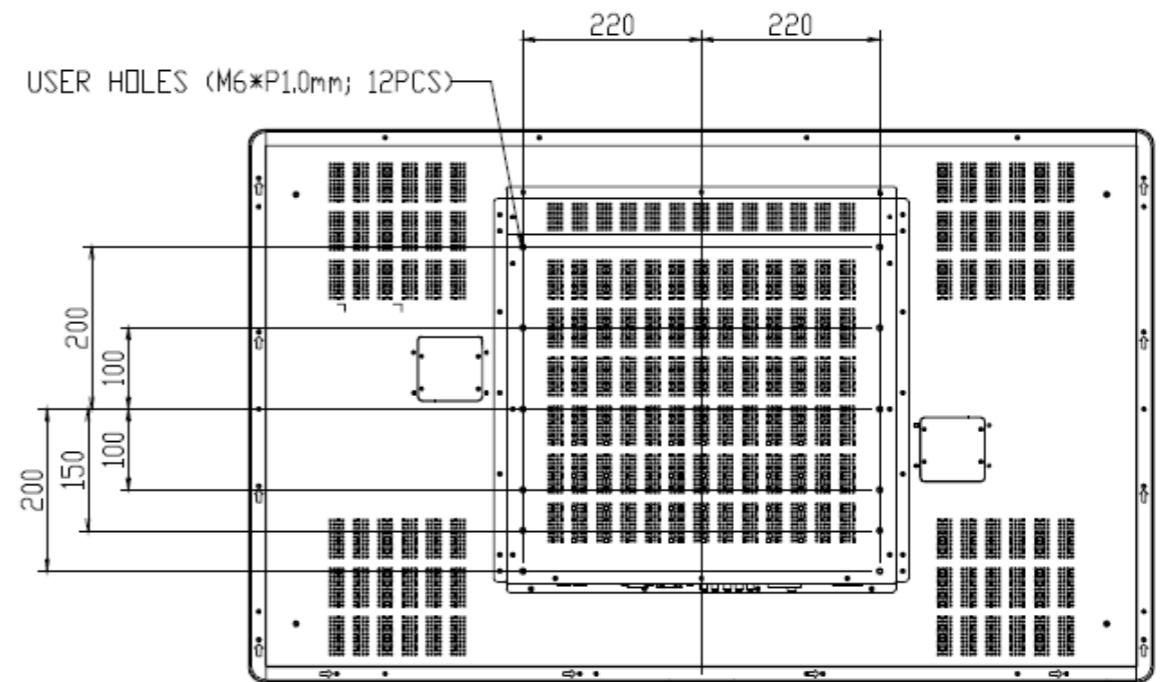

55"

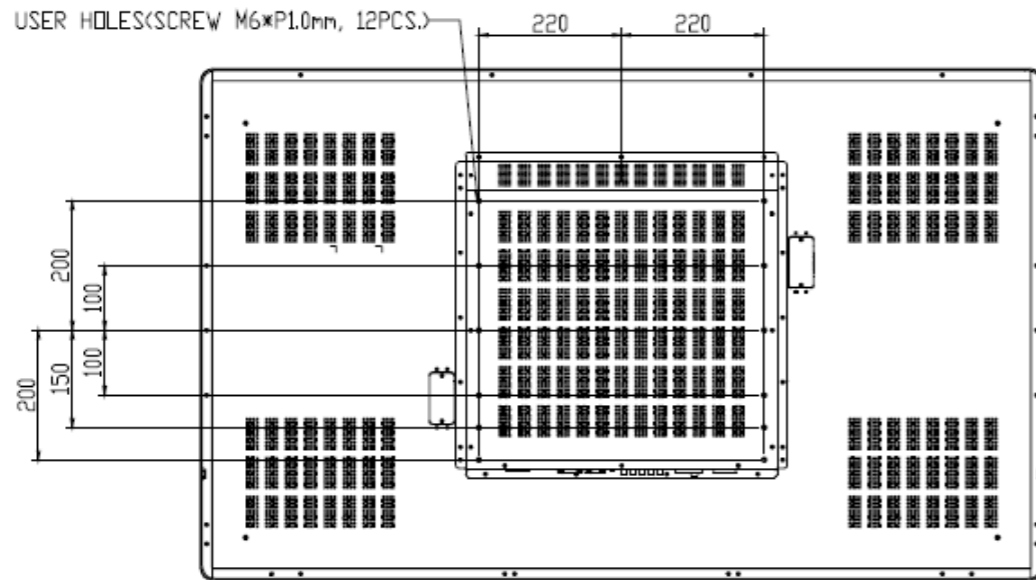

70"

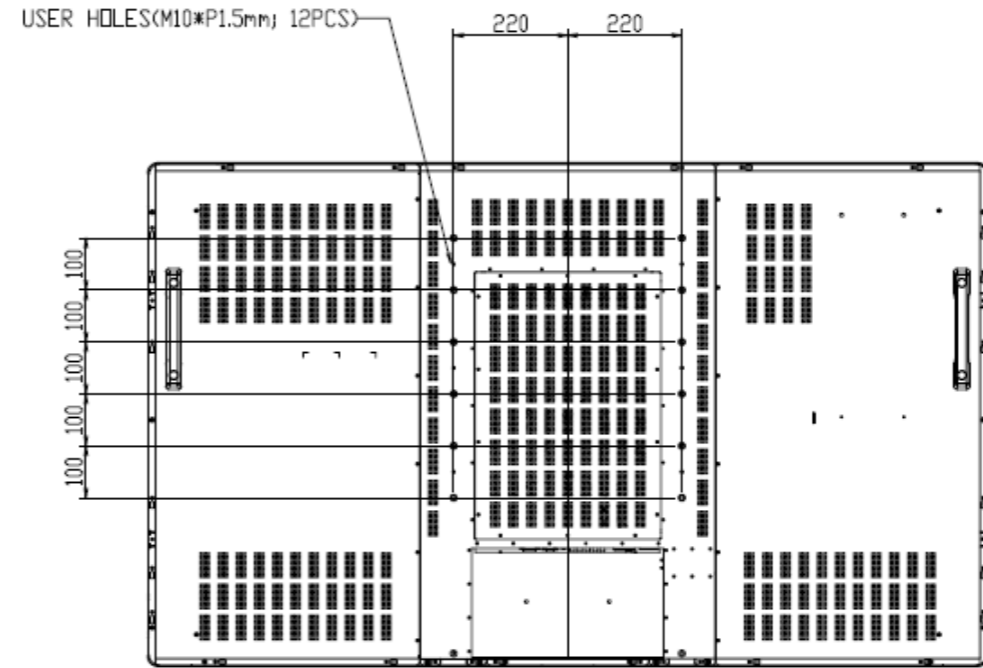

65"

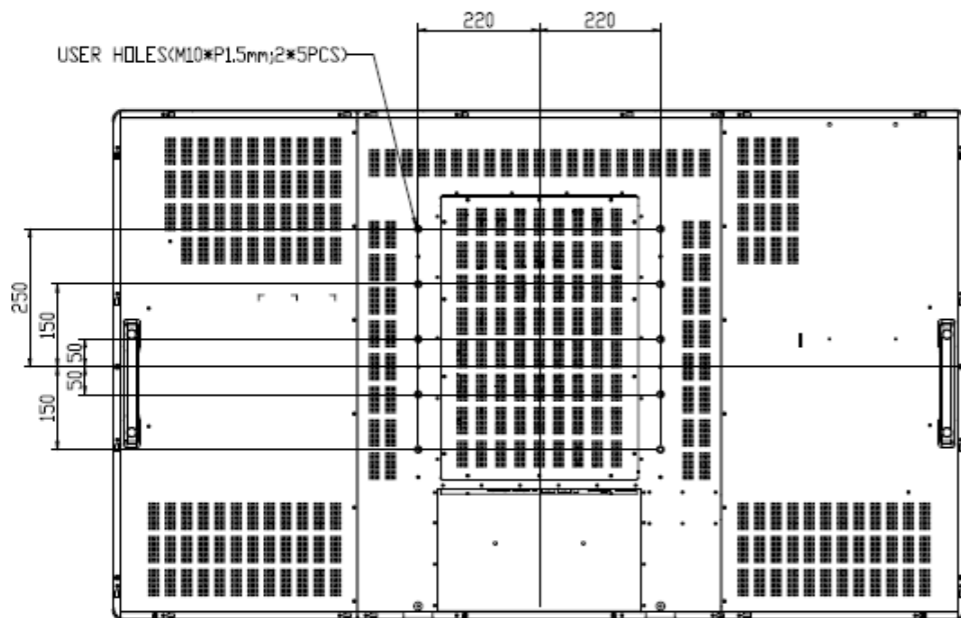

Touchboards

205 Westwood Ave, Long Branch, NJ 07740
 Phone: 866-94 BOARDS (26273) / (732)-222-1511
 Fax: (732)-222-7088 | E-mail: sales@touchboards.com