

Interact & Collaborate



**Hardware & Software for
the Classroom**

TECHNOLOGY FOR THE CLASSROOM

For 10 years, TouchIT Technologies has been designing hardware and software for the classroom. Today, our products are found in classrooms in over over 30 countries world wide.

Table of Contents

04	TouchIT Rapide
05	Why Rapide?
08	TouchIT App Store
09	School / District Accounts
10	Contribute Cloud
11	How It Works
12	Contribute Cloud
13	Cloud Overview
14	Wireless Wizard
15	Let's Ditch Those Cables
16	Contribute Signage
20	Stands & Mounts
22	TouchIT Fusion 2
24	Support & Professional Development
26	Rapide Specifications
28	Dimensional Drawings



TouchIT Rapide

The TouchIT Rapide is the ideal Interactive Flat Panel to replace your aged interactive whiteboards and projectors. It has a higher resolution, a brighter image, no shadow and costs you less in the long run. With different mounting options available, it fits your school's exact needs.



Available in 65", 75", 86" & 100"

Super Slim Bezel (32mm) 1.2"



Intuitive Controls



Front Facing Inputs

RAPIDE HIGHLIGHTS...



40pt

Up to 40 Point Multi-Touch



8.0

Powerful Android 8 OS



4K

4K Ultra High Definition



2 x 15W

Classroom Filling Audio

QUITE SIMPLY THE FASTEST INTERACTIVE LED ON THE MARKET

Why Rapide?

TouchIT Rapide, quite simply is the fastest Interactive LED on the market. For the first time, our onboard Android 8.0 offers the power to be a true computer replacement.

TouchIT Rapide brings your Apps to life in beautiful 4K ultra high definition. In the classroom, the sleek style coupled with powerful performance effortlessly handles your every day tasks.

Collaboration has never been easier with Contribute Cloud you can create,

collaborate and cast wirelessly directly to the TouchIT Rapide. With up to 40 point multi-touch, an anti-glare tempered glass finish, room filling front facing speakers and a 3 year on site warranty, what are you waiting for?

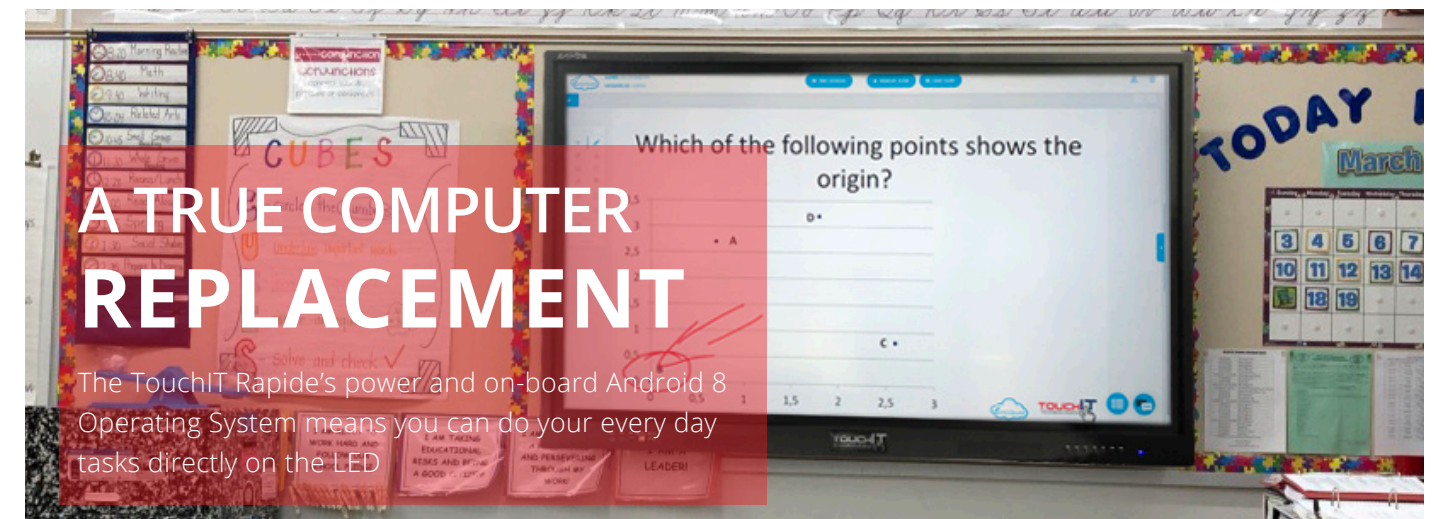

No drivers to download or install and no calibration needed



Support & Professional Development

We're here to support you every step of the way. Online, by Phone and In Person

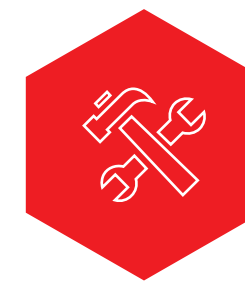

3 Year On Site Warranty

Total peace of mind that if there is a problem, we'll come to your location to fix it!



Lower Cost of Ownership

Unlike projectors, nothing to maintain. No bulbs, No filters, driver or calibration. Maintenance free.

Why Rapide?

Let's take a look at some of the features that make the TouchIT Rapide Interactive LED the best Interactive display for the classroom.

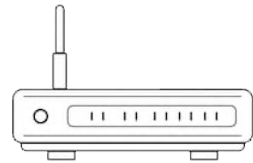

Built in Computer

Looking for an On Board PC? Our built in OPS Slot allows you to connect an OPS Computer.

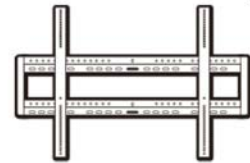

Wall Mount Included

Why pay extra to attach your TouchIT Rapide to the wall? We include a wall mount with every model.

CREATE DELIVER CAST COLLABORATE

AND MORE.....CONTRIBUTE CLOUD COMES WITH ALL TOUCHIT RAPIDE MODELS AS STANDARD. THERE ARE NO ANNUAL FEES, NO LIMITS ON TEACHERS OR STUDENTS. TRANSFORM YOUR CLASSROOM WITH OUR POWERFUL SOFTWARE



100s of Apps Included

Download 100s of Apps free of charge from the TouchIT App Store.



Let's Ditch Those Cables

Combine the TouchIT Rapide with Wireless Wizard and be cable-free in the classroom

It Just Makes Sense...



COLLABORATION SOFTWARE INCLUDED

There are no additional software costs for the TouchIT Rapide. Contribute Cloud is supplied as standard



FRONT FACING SPEAKERS

Deep and rich room filling audio from our front facing speakers. 2 x 15W



ANTI-GLARE TEMPERED GLASS

Designed for the classroom, a tough tempered glass finish with anti-glare coating for superior viewing



SUPERIOR CONNECTIVITY

There are so many inputs and outputs you can connect all your classroom tools such as the Document Camera or Visualizer



THE TOUCHIT RAPIDE IS THE 7TH GENERATION OF INTERACTIVE PANEL FROM TOUCHIT TECHNOLOGIES

We've taken everything we've learned about the needs and requirements of Schools and Districts over the last 10 years and put them into this product.

TouchIT App Store

Available with all TouchIT LEDs, the TouchIT App Store is designed to deliver Free content directly to your interactive LED.

If you would like to see the Apps that are currently in the store, why not visit our web store at www.touchitappstore.com

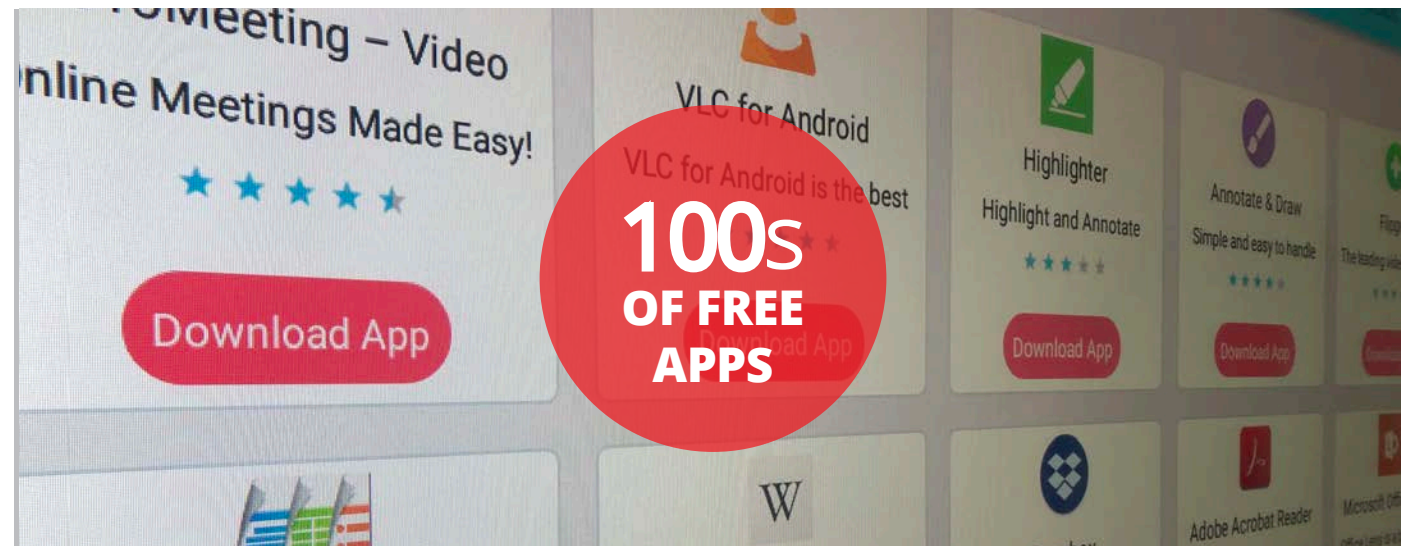

All Apps are Free of Charge

We don't want you to have to pay for additional content to use on your Interactive Flat Panel. That is why we have our own App Store where all the content is totally free to download.



Suitable For the Classroom

All Apps are suitable for the classroom. We know that all the Apps in the TouchIT App Store have been manually checked for suitability. You won't find any violent video games or inappropriate content in our App Store.



We Take Requests...

The TouchIT App Store is not designed to be a definitive list of Apps that you can use on your TouchIT LED. If there is an App that you would like to use, request it directly in the App Store. If it is free and it works well on the LED, we'll add it.

School Accounts

We understand that some Schools and Districts want to be able to control the Apps that are available to their teaching staff. That is why we have created School Accounts within the TouchIT App Store.

Select The Apps You Want

An Administrator is able to select that apps that they want to make available to their staff from the TouchIT App Store. They simply create the users and when the teachers log in, they only see the Apps the administrator has chosen for them. A Simple and Easy way to manage the content to your District or State requirements.

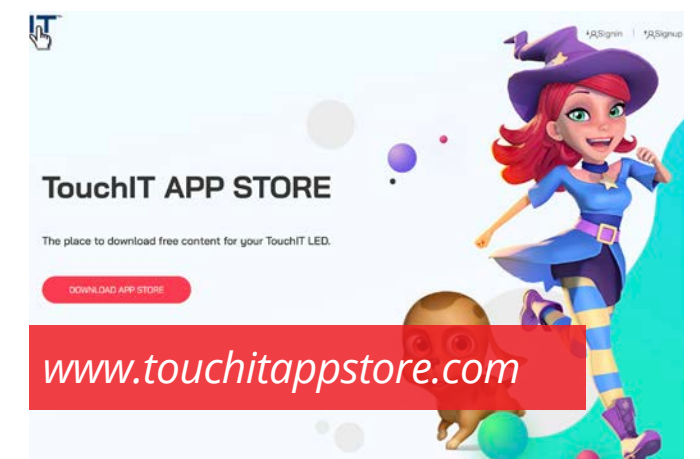
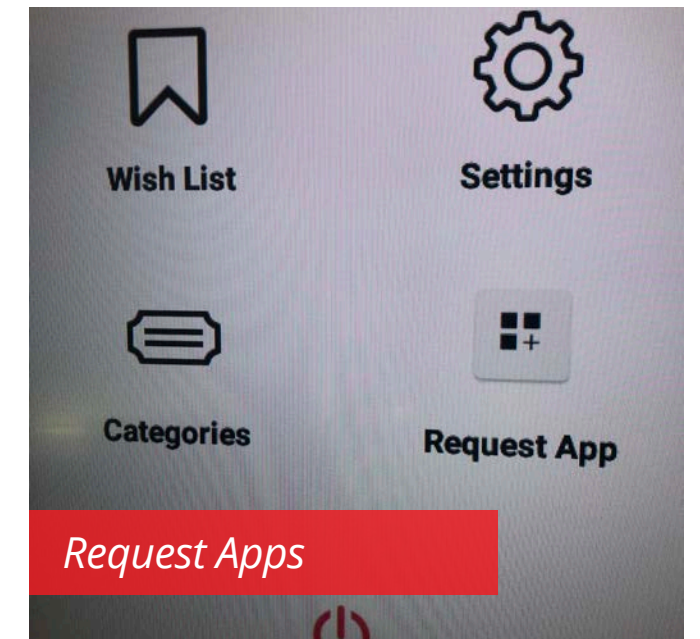
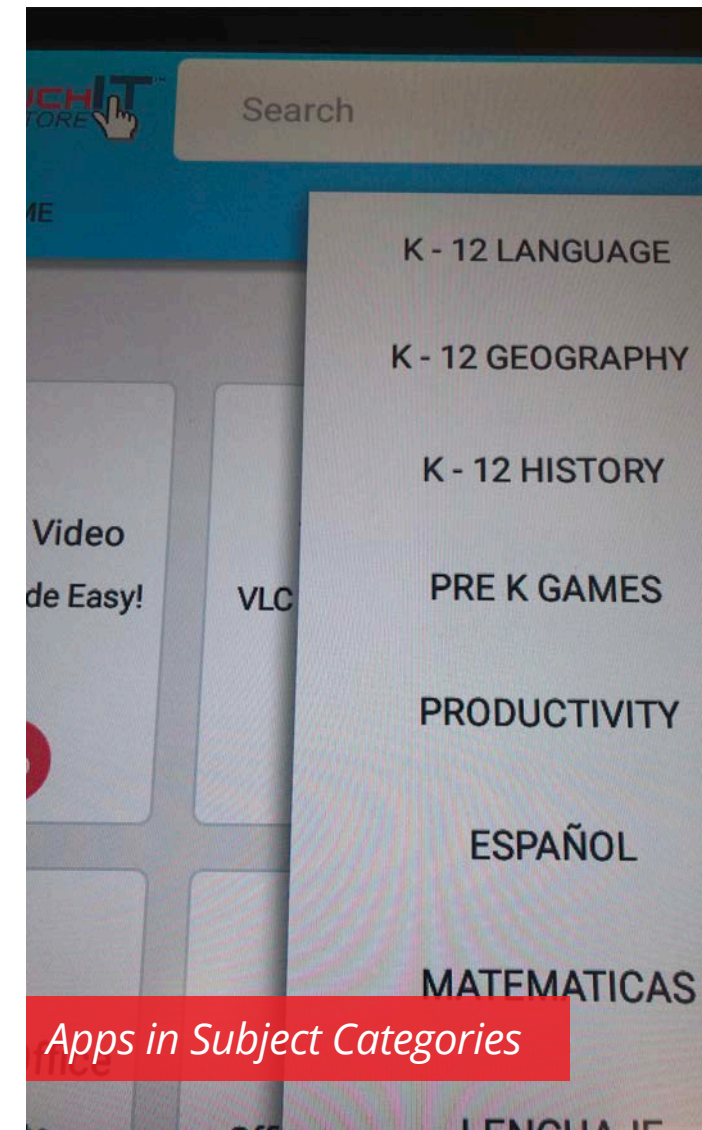

Contribute Cloud

Contribute Cloud is a cloud-based, operating system agnostic software designed specifically for the needs of teachers and students in the classroom.



CLOUD BASED
OS AGNOSTIC



Contribute Cloud Software enables Content Delivery, Collaboration, Casting and Multi-Casting all through a FREE cloud-based platform. Simply add your content, share it with your students or colleagues and they are able to collaborate with you – all through a browser. Import content from popular file formats and even other brands of interactive whiteboards and LEDs' software.

Its Simple...

01.

Create an Account

Creating an account for Contribute Cloud is as simple as choosing a password and entering your email address, or signing in with one of your social profiles.

02.

Access Your Content

You are able to access your content from a variety of sources. Dropbox, OneDrive, Google Drive as well as your local computer means accessing and adding your files is just a few clicks of the mouse.

03.

Create a Workbook

Add your files to "slides" in your Contribute Cloud Workbook. You can have multiple file types all in the same Workbook which makes creating the modern lesson quick and easy.

04.

Share, Collaborate & Cast

Start your session and have your students join via email or session ID. Once in the session they can share your content, collaborate with you and cast back to the LED from the comfort of their own seat on their own device.

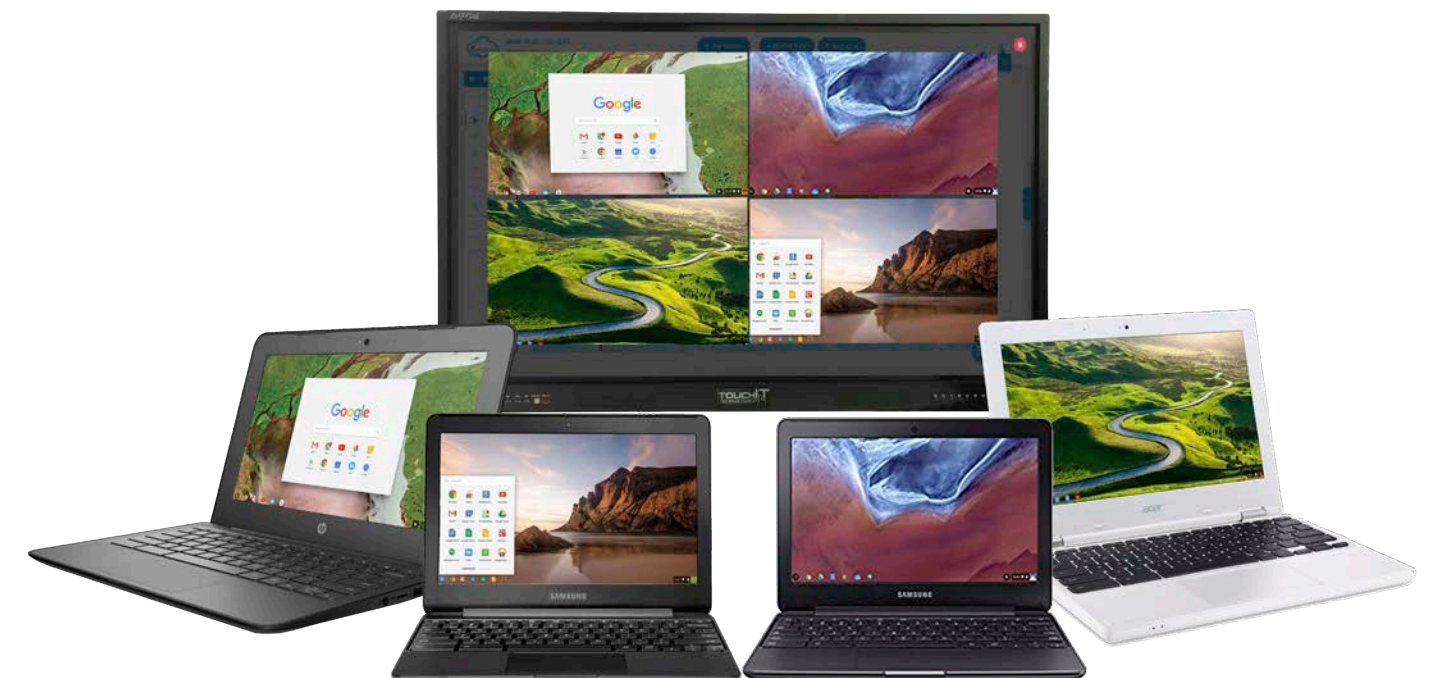

Contribute Cloud



Whether you are looking to do some quick whiteboarding or you want to deliver a full lesson, Contribute Cloud is the software of choice. We put the control back in the hands of the teacher. Not only is it the teacher who decides who is casting on the LED, the teacher can also pause the screens and remove the tools from the students.

15-Day Free Trial - <http://contribute.cloud>



Cloud Overview



Cloud Based

Cloud-based means there is nothing to install, update or maintain. We do it all!



OS Agnostic

Contribute Cloud will work with almost any device with a browser.



Free & Unlimited

For TouchIT Users, the software is Free and unlimited. As many users as you need.



Cast & Multi-Cast

Cast all of your class in real-time up to the LED with just a few clicks.



Google Classroom

Import your student lists and classes directly from Google Classroom.



Teacher Cast

Cast out from the LED any 3rd party applications or websites to the students.



Chat & File Transfer

Use the group chat and file transfer to deliver links and activities to the students.



Educational Tools

Subject specific education tools can be used on your Contribute Cloud workbooks.



Wireless Wizard enables you, the teacher, to connect to your Touchscreen without wires. You don't even need an Internet connection, just a Local Area Network (LAN) or WIFI connection.



Wireless Wizard enables you to display your computer screen on your touchscreen and control it without any trailing wires. Set yourself free in your classroom or meeting room, magic away those cables with Wireless Wizard, from TouchIT Technologies.

Simply install the Wireless Wizard host App on your Interactive LED and then install the Wireless Wizard App on your computer. Open the two on the same network, and voila! No Cables.



Let's Ditch Those Cables

Set yourself free in the classroom.

Try Wireless Wizard FREE for 15 days www.wirelesswizard.net



No Cables



Video and Touch to your LED without cables

No Internet



No Internet connection needed just WIFI or LAN

One Click Connection



Simply click on the computer to connect to your LED

Secure



Passcode protected connection to your computer

Network Scanning



Scan your Network to view all Wireless Wizard devices

No Subscription



One time purchase of a license.

Contribute Signage

We know that Digital Signage needs to be simple. Install our App on your device. Connect your device to your TV or Monitor. Add the device to your online web portal and you are good to go! Create, deploy and manage your signage from any device, anywhere.



DIGITAL SIGNAGE DOESN'T NEED TO BE DIFFICULT!

Digital Signage enables you to quickly and easily communicate with the students, staff and visitors at your school. The usage of Digital Signage in schools is increasing as are the ways in which it can be utilized. Welcome screens in foyers, digital notice boards in hallways and digital menus in the cafeteria are all uses of Digital Signage. All of these applications and more can quickly and easily be created, deployed and managed with Contribute Signage.

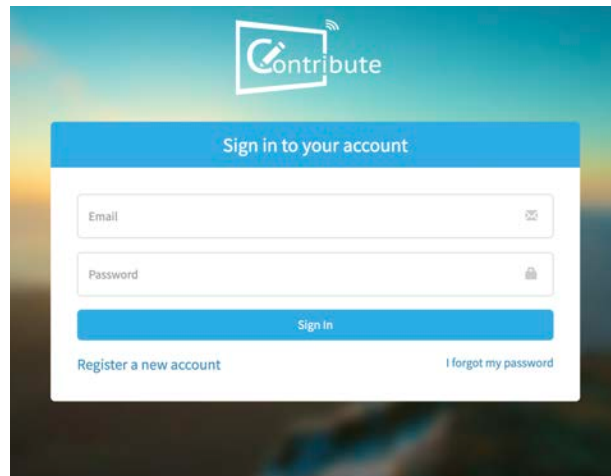

With Contribute Signage, we can cater for all your Digital Signage Requirements with one Application

- ✓ Foyer Welcome Screens
- ✓ Hallway Notice Boards
- ✓ Digital Wayfinders
- ✓ Info Kiosks
- ✓ Cafeteria Digital Menus
- ✓ Morning Video Briefings
- ✓ In Classroom Signage
- ✓ And more....



Contribute Signage

What is different about Contribute signage is that you are able to use your own TVs, monitors and computers to create Digital Signage players using our playback apps. Unlike a presentation or a video on loop (not real digital signage), Digital Signage can be updated remotely and with Contribute Signage you can do this from anywhere from any browser connected to the internet. Try the software and let Susie help you every step of the way!

There are no annual fees, maintenance charges or charges for updates.

Create as many users and roles as you wish to manage your signage screens at no extra charge.

All licenses are a one time cost and are perpetual.

**Susie is not a Graphic Designer
Susie is not a Programmer
But Susie can create Digital Signage**



15 Day FREE Trial Available at www.contributesignage.com

Signage Features

One time purchase

No Reoccurring Costs

Contribute Signage is a one time purchase of a perpetual license. We do not charge for updates or any reoccurring fees.

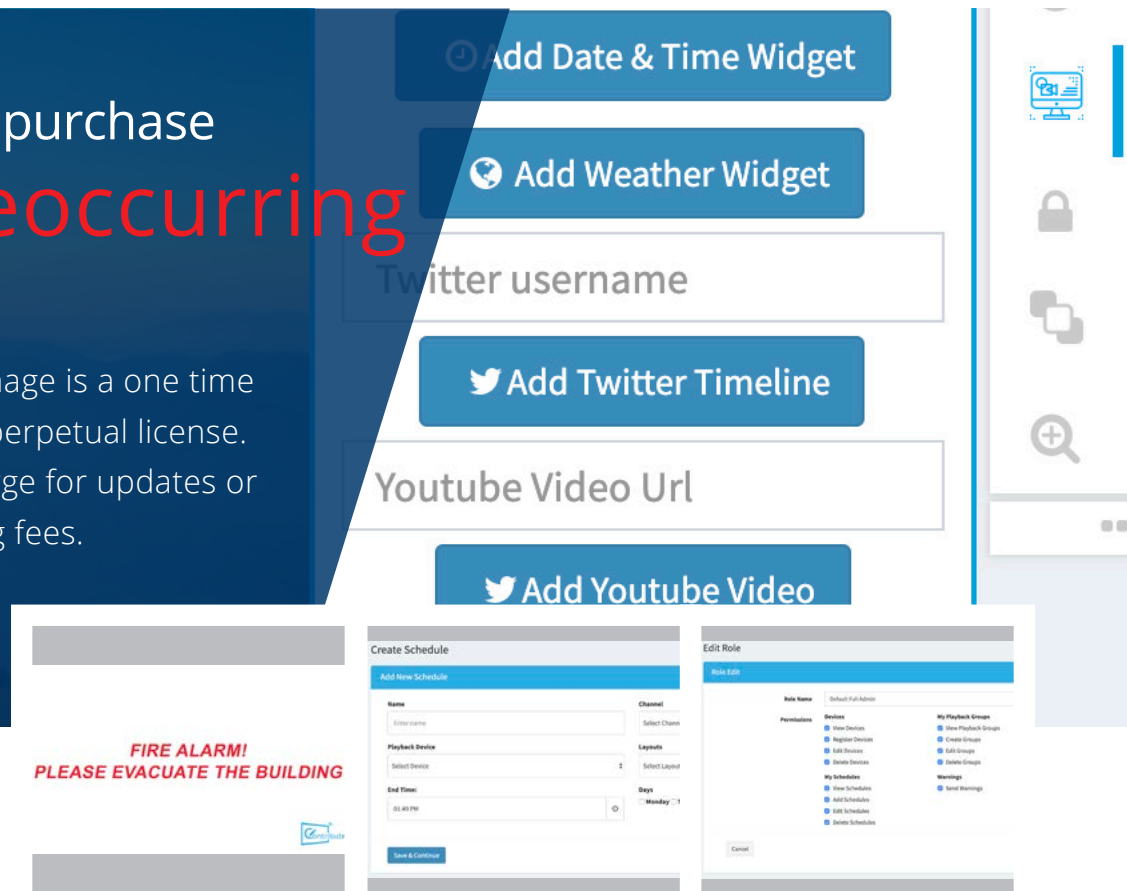

Manage Devices Online

Manage all your digital signs online from our control panel



Crisis Management

Send Crisis Management messages to your devices with a single click



Multiple File Formats

Import Video and Images into your media gallery



WYSIWYG Editor

Create your layouts in our drag and drop editor online



Scheduling

Schedule your playback layouts for exactly when you want them



2m+ Image Gallery

Over 2 Million searchable images in the gallery

The Editor

Creating your layout is often seen as the most difficult element of digital signage. How do you create something that is functional but also looks good?

With Contribute Signage the editor is at the heart of the signage. Building on our experience in Annotation software, we've created what we believe is a simple to use editor that can be used by anyone!

Our floating toolbar allows you to add images, videos, news feeds, scrollers and much, much more. The flexible canvas allows you to drag, drop and resize any of your digital signage elements.

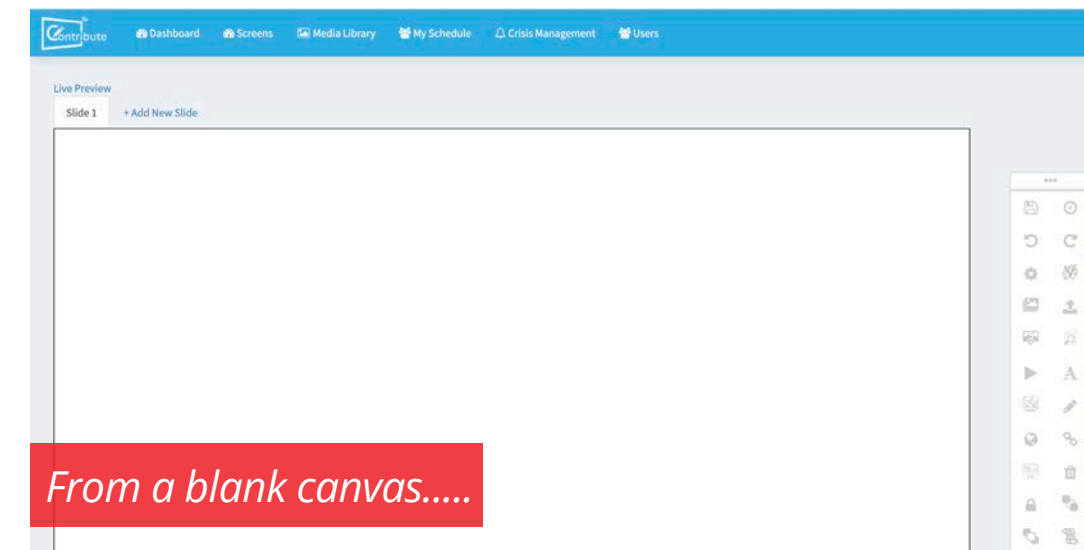

From a blank canvas....



...to Digital Signage in minutes

Using our tabbed layout or slides, we give you even more flexibility to create stunning digital signage. Select the amount of time and a transition between each slide and your signage will effortlessly change between slides. Whether you are playing a full screen video or a scrolling news feed, the tabbed layout gives you the flexibility to do both.

Stands and Mounts

We're not all the same height and neither are the students. We offer height adjustable mounts in all the configurations you may need in your school or district.

Manual BalanceBox

How do you choose the optimal height to mount your TouchIT LED?

This is always a difficult question so what the BalanceBox range does is that it allows you almost 16" or 40cm of height adjustment. With little to no effort, you can raise and lower even the largest of our touchscreens.

- ✓ Manual Adjust
- ✓ 16" or 40cm
- ✓ Wall Mounted
- ✓ Synthetic Motor

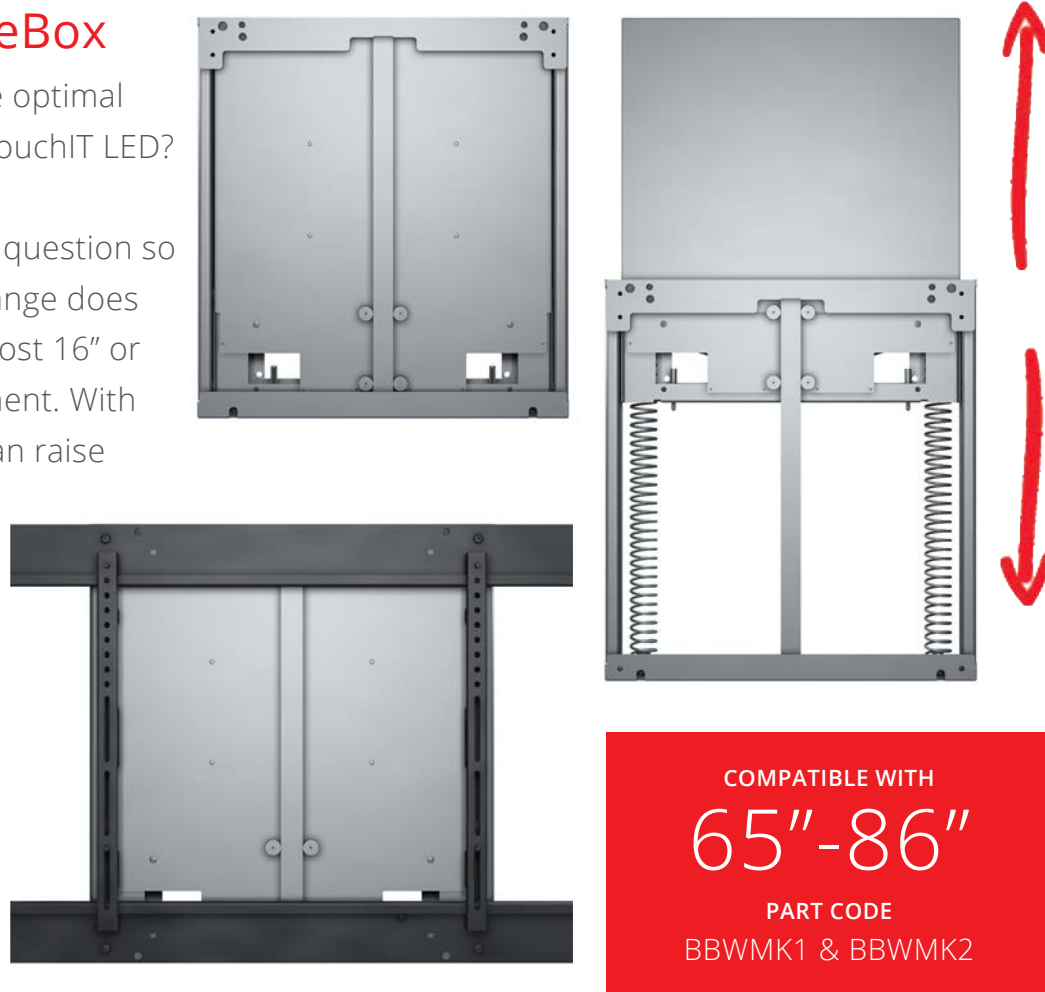

BBWMK1	0608641030655	TouchIT Balance Box 400-70 (480A12)	65" & 75"
BBWMK2	0608641030754	TouchIT Balance Box 650-130 (484A08)	86"
BBEBOX	0608641030679	Electric Motorized Mobile Stand	65" to 86"
BBMOB	0608641030723	TouchIT Balance Box Mobile Stand	65" to 86"
BBEBOXWALL	0608641030686	Electric Motorized Wall Stand	65" to 86"

Stands and Mounts

Whether you are looking for a wall mounted height adjustable mounting system or something a little more mobile, we have the options and configurations for you.

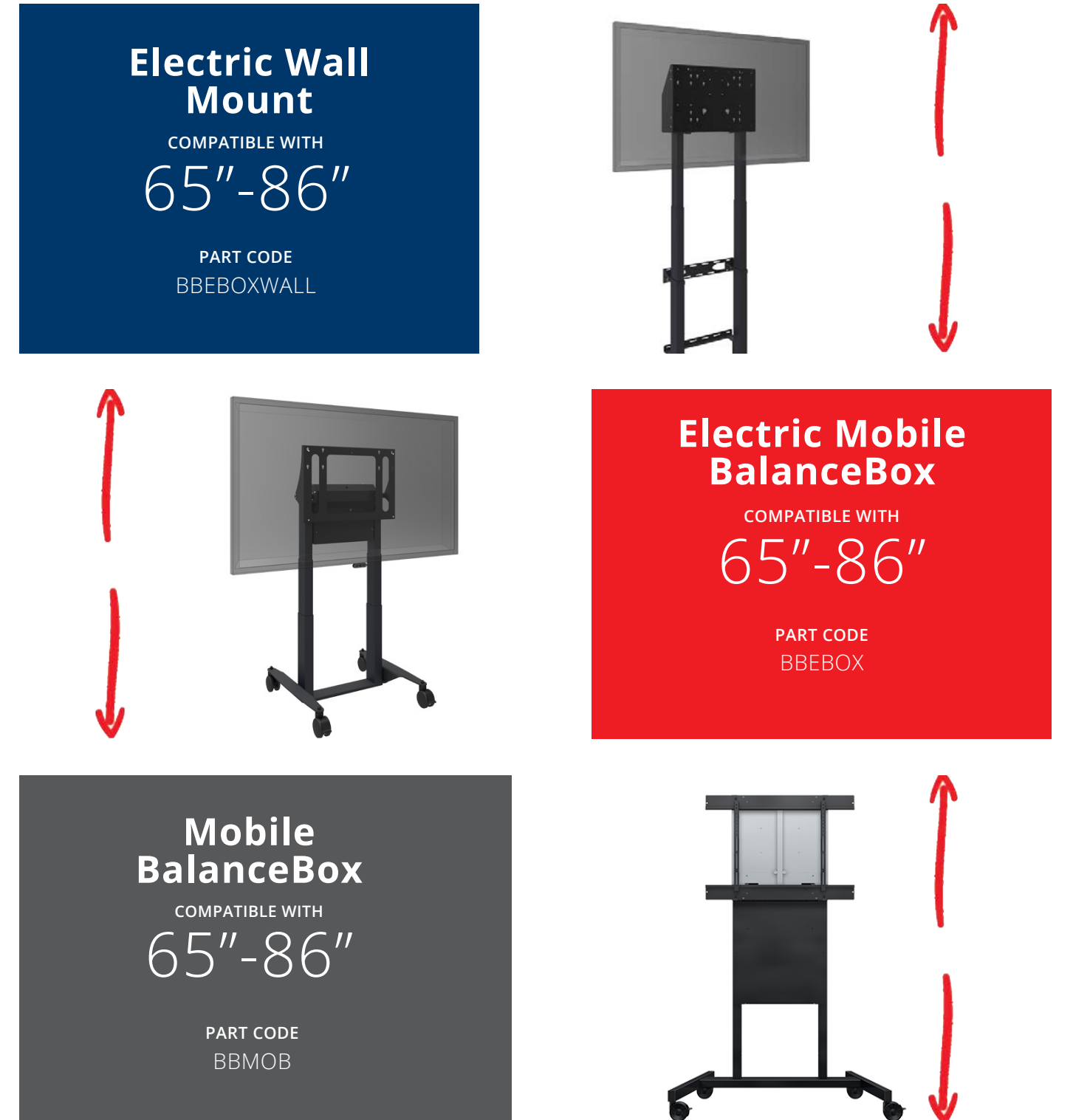

TouchIT Fusion 2

The TouchIT Fusion 2 is the future of K-12 interactivity. Available for TouchIT LED Y Series LED Displays in 65" and 75", the TouchIT Fusion 2 is three products in one! An Interactive Easel, an Interactive Table and an Interactive LED.

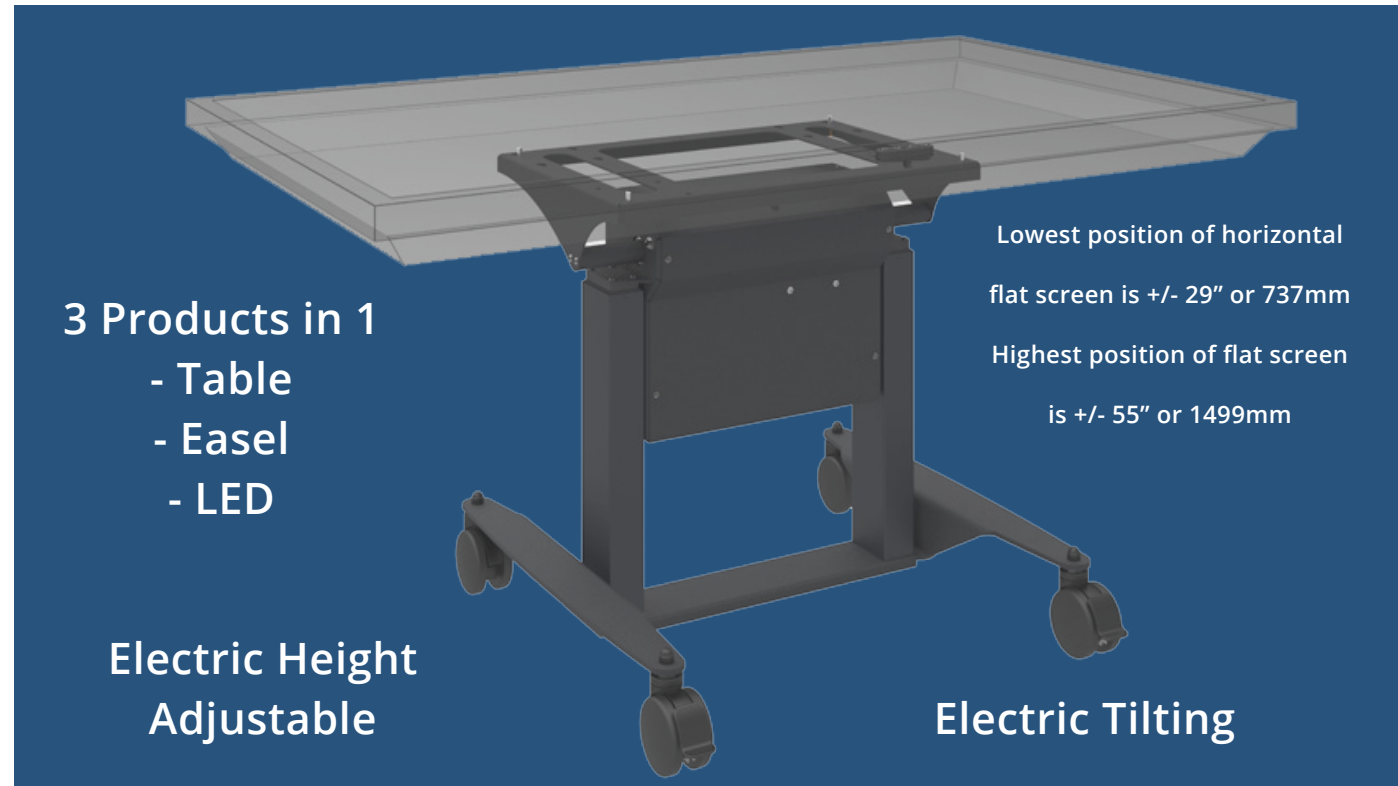

THIS REALLY IS THE FUTURE OF INTERACTIVITY IN THE CLASSROOM.

The flexibility this product provides is second to none. It is ideal for group interaction, cluster group learning as well as whole class teaching. All bases are covered!



Support & Professional Development

Support and Professional Development are very important at TouchIT Technologies. We offer a number of different ways that we can support you with our products from On Site Technical Support to Online Training. Here are a few key examples of what we offer.

3 Year On Site Support comes as standard for all Interactive LEDs. If there is a problem, we'll send out the parts and a technician to fix them at your school. (USA inc Hawaii, Canada & Australia)



TECH SUPPORT

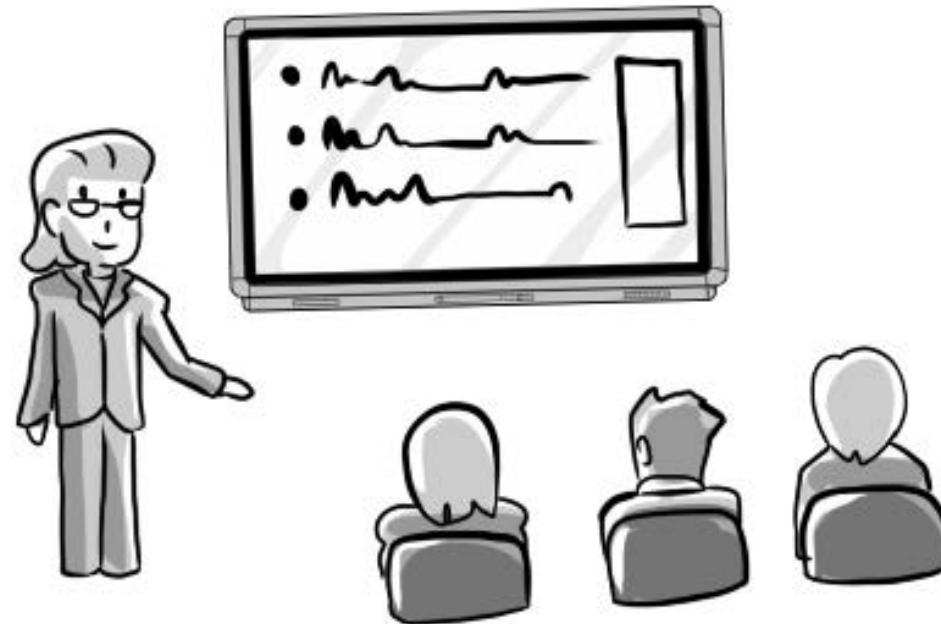

TRAINING



WEBINAR/ONLINE

www.touchittechnologies.com

We try to make our hardware and software as easy to use as possible. If you have a question or are stuck, please do reach out, we're always happy to help.



support@touchittechnologies.com

“ We are here to help EVERY step of the way

We have a vested interest in you getting the most out of your TouchIT Product. We know that if you are trained on the product, you will use it more and ultimately, purchase more product from us.



SUPPORT ON SITE TRAINING WARRANTY 3 TO 5 YEARS

If you have a problem with your hardware, we'll diagnose it with our support team, send out the parts and a technician will fit them at your location.

RAPIDE Specs



65" 4K

TOUCHIT65A8



75" 4K

TOUCHIT75A8



86" 4K

TOUCHIT86A8



100" 4K

TOUCHIT100A8

Screen Size (Diag.)	65"	75"	86"	100"
Resolution	3840 x 2160	3840 x 2160	3840 x 2160	3840 x 2160
Aspect Ratio	16:9	16:9	16:9	16:9
Brightness	350 cd/m2	350 cd/m2	350 cd/m2	500 cd/m2
Contrast Ratio	1200:1	1200:1	1200:1	4000:1
Viewing Angle(H/V)	178°/178°	178°/178°	178°/178°	178°/178°
Response Time(G to G)	9ms	9ms	9ms	9ms
Backlight Unit	Direct LED	Direct LED	Direct LED	Direct LED
Backlight Life	50,000 Hours	50,000 Hours	50,000 Hours	50,000 Hours
Touch Technology	Infrared 40pt	Infrared 40pt	Infrared 40pt	Infrared 40pt
Touch Resolution	32768 x 32768	32768 x 32768	32768 x 32768	32768 x 32768
Supported OS & Touch Points	Win 10/8/7: 40pt, Win XP: 1pt, Mac: 1pt, Android: 10pt, Chrome: 1pt			
Minimum Recognition Size	Φ3mm	Φ3mm	Φ3mm	Φ3mm
Tempered Glass	Anti-glare 4mm	Anti-glare 4mm	Anti-glare 4mm	Anti-glare 4mm
Video (analogue)	VGA x1, AV x1, YPbPr x1	VGA x1, AV x1, YPbPr x1	VGA x1, AV x1, YPbPr x1	VGA x1, AV x1, YPbPr x1
Video (digital)	HDMI 2.0 x3, DP 1.2 x1	HDMI 2.0 x3, DP 1.2 x1	HDMI 2.0 x3, DP 1.2 x1	HDMI 2.0 x3, DP 1.2 x1
Audio	Line in (3.5mm) x1	Line in (3.5mm) x1	Line in (3.5mm) x1	Line in (3.5mm) x1
Media (Android)	USB 3.0 A-type x1, USB-C x1, Micro SD card reader x1			
Media (Android/PC/OPS)	USB 3.0 A-type x3	USB 3.0 A-type x3	USB 3.0 A-type x3	USB 3.0 A-type x3
LAN	LAN		RJ45 x1	RJ45 x1
Screen Control	RS232C (In/Out) x1	RS232C (In/Out) x1	RS232C (In/Out) x1	RS232C (In/Out) x1
OPS Computer Slot	OPS Computer Slot		Support 4K at 60Hz	Support 4K at 60Hz
Video (analogue)	AV x1	AV x1	AV x1	AV x1
Video (digital)	HDMI 2.0 x1	HDMI 2.0 x1	HDMI 2.0 x1	HDMI 2.0 x1
Audio	SPDIF (Coaxial) x1, Line out (3.5mm) x1	SPDIF (Coaxial) x1, Line out (3.5mm) x1	SPDIF (Coaxial) x1, Line out (3.5mm) x1	SPDIF (Coaxial) x1, Line out (3.5mm) x1
Touch	USB 2.0 B-type x5	USB 2.0 B-type x5	USB 2.0 B-type x5	USB 2.0 B-type x5
LAN	RJ45 x1	RJ45 x1	RJ45 x1	RJ45 x1
Built-in Speakers	15W x2	15W x2	15W x2	15W x2
Input Voltage	AC100~240V 50/60Hz	AC100~240V 50/60Hz	AC100~240V 50/60Hz	AC100~240V 50/60Hz
Power Consumption (Typical)	220 Watts	330 Watts	410 Watts	720 Watts
Power Consumption (Standby)	0.5W	0.5W	0.5W	0.5W
Operating Temp.	0-40	0-40	0-40	0-40
Operating Humid.	20-80% RH	20-80% RH	20-80% RH	20-80% RH
Dimension (WxHxD)	1523x945x107mm (59.96" X 37.2" X 4.21")	1744x1070x107 mm (68.66" X 42.13" X 4.21")	1990x1208x107 mm (78.35" X 50.39" X 4.21")	2257x1293x107 mm (88.86" x 50.91" x 4.21")

Screen Size (Diag.)	65"	75"	86"	100"
VESA	600x400mm, 100x100mm(e.g. Intel NUC)	600x400mm, 100x100mm(e.g. Intel NUC)	600x400mm, 100x100mm(e.g. Intel NUC)	600x400mm, 100x100mm(e.g. Intel NUC)
Net Weight	43KG (95 lbs)	58KG (128 lbs)	75KG (165 lbs)	135KG (300 lbs)
System Version	Android 8.0	Android 8.0	Android 8.0	Android 8.0
Kernel	4.9	4.9	4.9	4.9
CPU	ARM Cortex-A73 Dual-core, ARM Cortex-A53 Dual-core	ARM Cortex-A73 Dual-core, ARM Cortex-A53 Dual-core	ARM Cortex-A73 Dual-core, ARM Cortex-A53 Dual-core	ARM Cortex-A73 Dual-core, ARM Cortex-A53 Dual-core
GPU	ARM Mali-G51 MP4 Quad-core	ARM Mali-G51 MP4 Quad-core	ARM Mali-G51 MP4 Quad-core	ARM Mali-G51 MP4 Quad-core
RAM	4GB DDR4	4GB DDR4	4GB DDR4	4GB DDR4
ROM	16GB	16GB	16GB	16GB
	Power cord 3m x1 (9.84')	Power cord 3m x1 (9.84')	Power cord 3m x1 (9.84')	Power cord 3m x1 (9.84')
	HDMI cable 3m x1 (9.84')	HDMI cable 3m x1 (9.84')	HDMI cable 3m x1 (9.84')	HDMI cable 3m x1 (9.84')
	Touch USB cable 3m x1 (9.84')	Touch USB cable 3m x1 (9.84')	Touch USB cable 3m x1 (9.84')	Touch USB cable 3m x1 (9.84')
	Remote control w/o batteries x1	Remote control w/o batteries x1	Remote control w/o batteries x1	Remote control w/o batteries x1
	Stylus x2	Stylus x2	Stylus x2	Stylus x2
	Wifi USB dongle x1	Wifi USB dongle x1	Wifi USB dongle x1	Wifi USB dongle x1
	Quick Start guide x1	Quick Start guide x1	Quick Start guide x1	Quick Start guide x1
	Installation guide x1	Installation guide x1	Installation guide x1	Installation guide x1
Package Dimensions	1720 x 1070 x 250mm (67.7" x 42.1" x 9.8")	1940 x 1180 x 280mm (76.4" x 46.5" x 11.0")	2180 x 1360 x 280mm (85.8" x 53.5" x 11.0")	2446 x 1428 x 235mm (96.3" x 56.22" x 9.25")
Packaged Weight	64KG (142 lbs)	80KG (177 lbs)	104KG (230 lbs)	165KG (365 lbs)

IN THE BOX

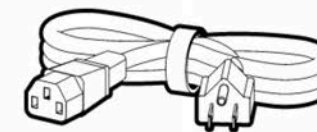

Power Cord (9.8' / 3M)

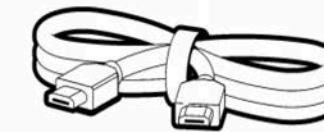

HDMI Cable (9.8' / 3M)

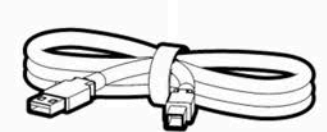

USB Cable (9.8' / 3M)



Remote Control & Batteries

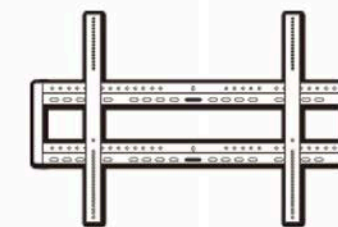

Wall Mount



Stylus x 2



Dimensions Rapide 65"

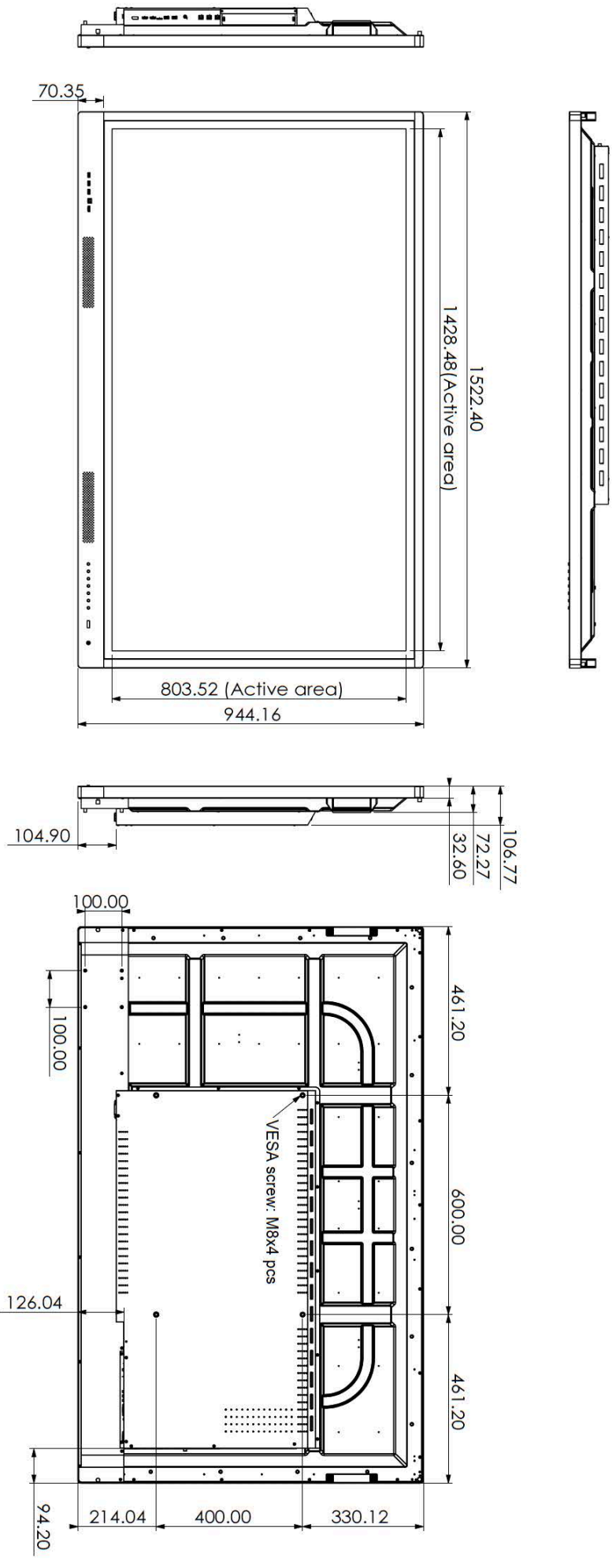

RAPIDE

Dimensions Rapide 75"

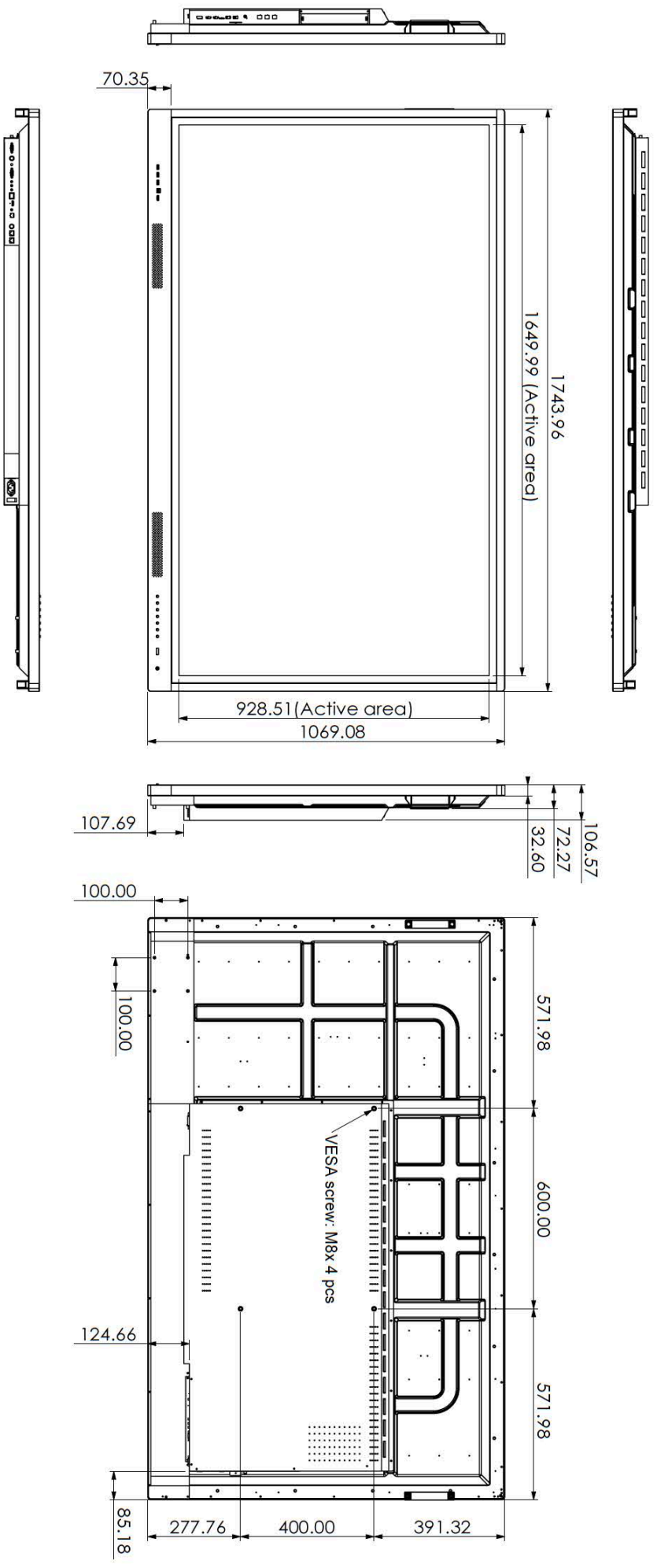

RAPIDE

Dimensions Rapide 86"

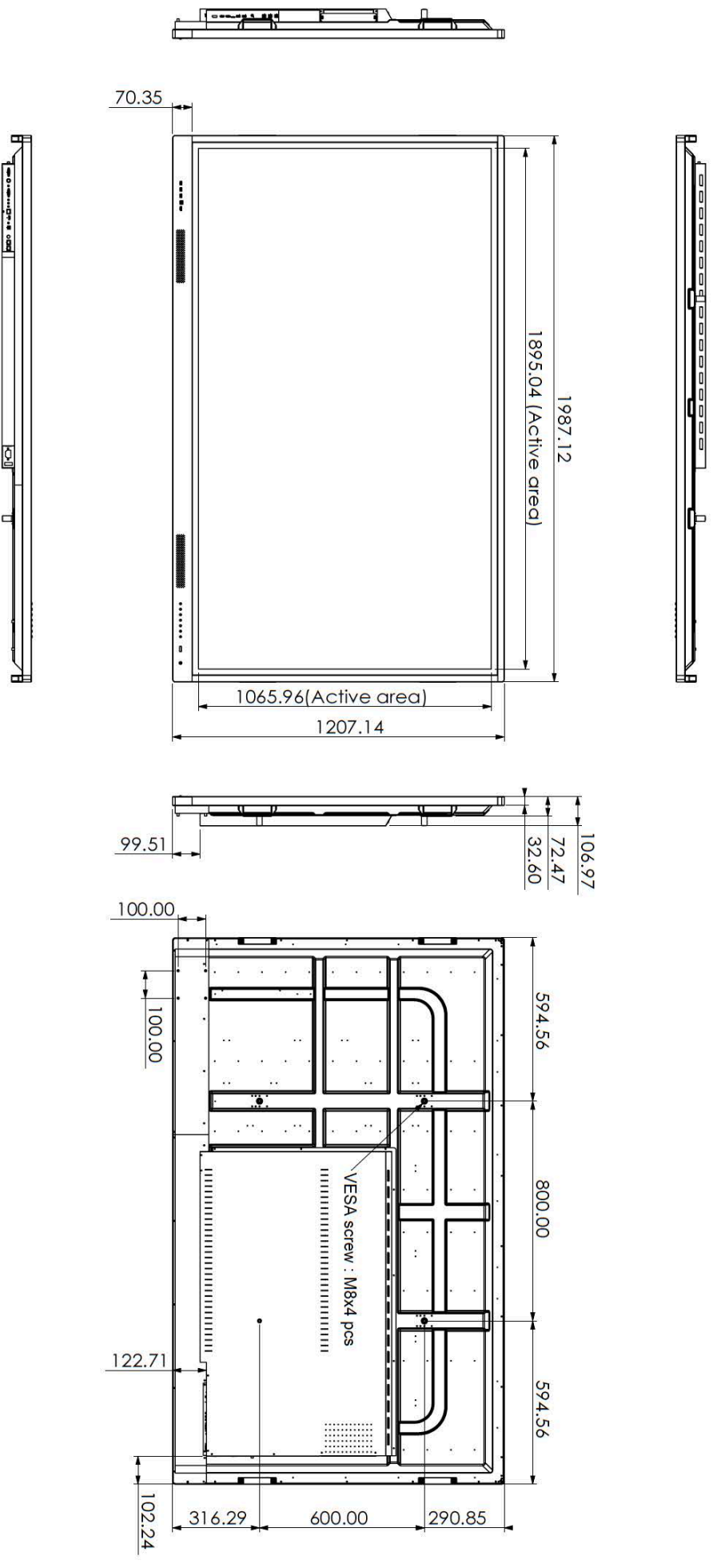

RAPIDE



Dimensions Rapide 100"

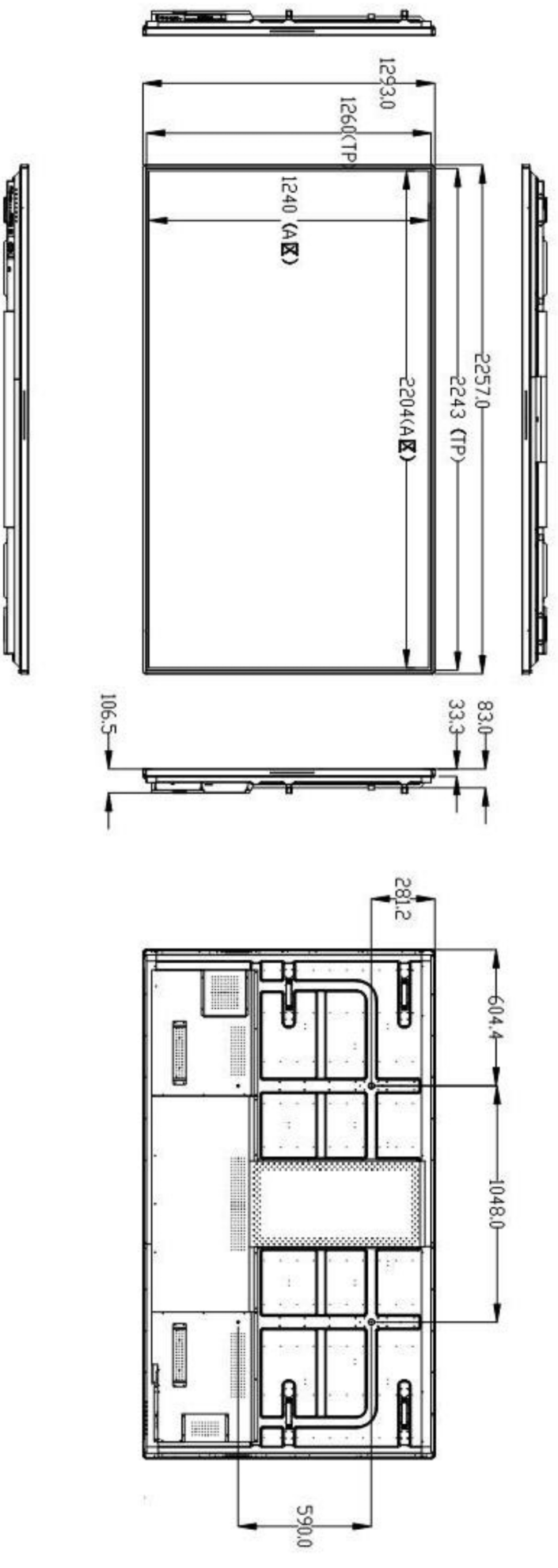

RAPIDE





Address

10222 Pecan Pk Blvd, Ste3
Austin TX, 78729

Contact Us

Phone: 248 764 1084
E-mail: sales@touchittechnologies.com
Web: www.touchittechnologies.com