

CamView™ IP Pro-X Series Testers



USER MANUAL

Contents

<i>Introduction</i>	3
<i>Safety Information</i>	3
<i>Descriptions</i>	4-8
<i>Function Overview</i>	9-12
<i>Basic Operation - Installing, Charging Battery and Power Up</i>	12-14
<i>IP Camera Testing</i>	15-28
<i>Analog Camera Testing</i>	29-33
<i>Network Tools</i>	34-38
<i>Wireless Test</i>	38-43
<i>Cable TDR Test</i>	43-45
<i>Record Playback</i>	45
<i>RS485 Data Monitor</i>	45
<i>Signal Generator</i>	46-47
<i>System Settings</i>	48-50
<i>Audio Test</i>	51
<i>Using PoE to Power Device</i>	51
<i>Using 12V/2A to Power Camera</i>	51
<i>Specifications</i>	52-54
<i>About Triplet</i>	55

Accessories (In the Box):

One each of the following items are included in the package: Camview IP Pro-X Tester, Lanyard ,Carrying Case, Network Cable ,BNC Cable RS485 Cable 12V/2A Power DC Charger ,(2) "Quick-Connect Power" Batteries, User Manual (UM-8075)

Introduction

Thank you for purchasing the *Triplett CamView™ IP Pro-X*. Please read the manual carefully before using the product.

To assure safe use of this product, please read the section on Safety carefully, and observe any Cautions or Warnings posted there and throughout this manual.

Please keep this manual for future reference.









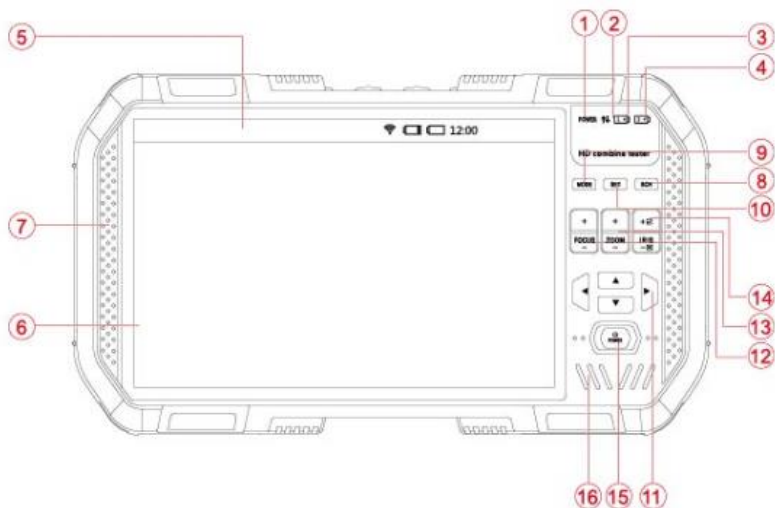



SAFETY INFORMATION

- Comply with all local electrical safety and electromagnetic compatibility rules and regulations when using this device.
- Use original accessories with this equipment to avoid possible damage caused from unapproved accessories.
- Accessories supplied are only intended for use with this product. Use with other products or for other purposes is not recommended.
- Do not expose the product to rain, liquids, or excessive moisture as product damage may occur.
- Do not expose or use the product in dusty or highly particulate environments.
- Avoid dropping the product or subjecting it to physical shock or high vibrations.
- Avoid leaving the product unattended while recharging it. Charging time should not exceed 8 hours. If the battery becomes hot, disconnect power immediately.
- Do not use the product in an environment containing flammable gases
- Do not attempt to disassemble the product. There are no user serviceable parts inside and product damage can occur. Contact Triplett customer service if the unit does not function properly.
- Do not use the product in environments with strong electromagnetic fields.
- Do not handle or operate the product with wet hands.
- Do not use strong detergents or solvents for cleaning the product. Wipe off dirt with a soft dry cloth, or a soft cloth slightly moistened with water or mild cleaner

Descriptions

Front – Faceplate and Keypad



①	POWER	Power indicator light: It is ON when the tester starts up.
②		Data sending / receiving indicator light: When RS485/COAXION sending / receiving the data, it flashes (red).
③		Battery 1 (left) light: It is ON (red) when charging. The indicator light will be automatically OFF When the battery is fully charged.
④		Battery 2 (right) light: It is ON (red) when charging. The indicator light will be automatically OFF When the battery is fully charged.
⑤	Title bar	Display current mode of function, current time and battery level.
⑥	Display area	Display various functional screens and video images.
⑦	Soft rubber protective layer	Improve the feeling of hand, which can play a protective role at the time of collision and fall. It is not replaceable.
⑧		Switch ON/OFF full screen display of video image.
⑨		"Function menu" key: Return to main menu. Use   arrow keys for function selection.
⑩		"Setting" button: Enter the parameter settings of the device under each mode of function.
⑪		Arrow keys: Control the PTZ rotation in some functional modules.
⑫		Control the focus during PTZ control.
⑬		Control the zoom during PTZ control.
⑭		Control the iris during PTZ control.
⑮		Power switch: Press and hold it for 2 seconds to turn ON/OFF the tester. When the device is ON/OFF, click this key for two times quickly, which can turn ON/OFF the top LED lighting(flashlight).
⑯		Internal speaker

Top Side

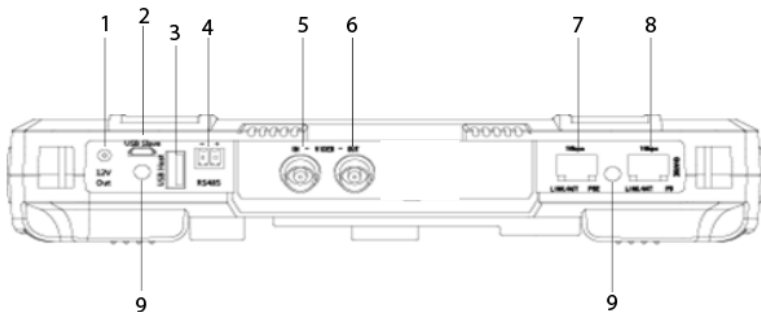

1	12V/2A Output Jack (4mm, Inner Pin 1.65mm)
2	Micro-USB Jack (PC connection)
3	USB Host Extension Interface
4	RS-485 Control Output (for PTZ Control)
5	Analog Video Input BNC Connector
6	Analog Video Output BNC Connector
7	Network Port 1 (Blue) with PoE Supply Output Function
8	Network Port 1 (Green) with PoE Supply Input Detection & Device Charging Input Port
9	LED Flash/Blink Indicator

Bottom Side



1	RESET Button
2	Audio Input Jack (3.5mm)
3	DC12V Charging Input Jack
4	HDMI Output
5	HDMI Input
6	Analog Video Output BNC Connector

Back Side

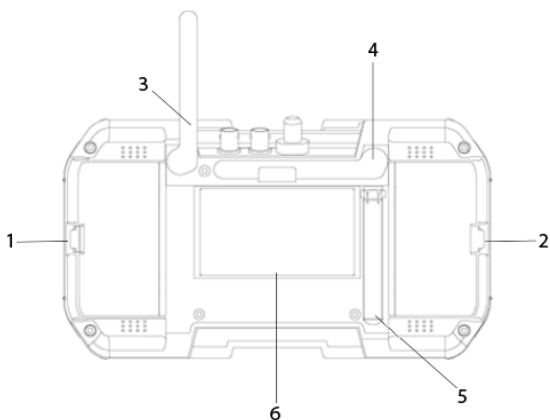

1	Right #2 Battery Cover Latch
2	Left #1 Battery Cover Latch
3	WiFi Antenna (Foldable)
4	Spectrum Antenna (Foldable)
5	Tester Tilt Stand
6	Circuit Heatsink

Function Overview

ONVIF IP Camera Test

The Tester will guide you through a step-by-step process to test the functionality of IP cameras, whether they are connected to an existing network or directly attached to the Tester. These steps include:

Step 1: Testing Ethernet connections, POE, IP settings, DHCP status/request, or providing DHCP service to a directly connected camera;

Step 2: Discovering camera(s), accessing camera settings, ONVIF report generation, showing a snapshot from the currently selected camera; and

Step 3: Displaying live video from the camera, profile/stream settings, and controlling the camera's PTZ functions (if camera is capable of PTZ).

You can adjust the camera's settings, and record still images or video from the selected camera. You can also check the audio signal from the camera if it is equipped with a microphone. If the camera is directly connected, the Tester will provide POE voltage to power the camera.

Standard Definition Analog Camera Test

The Tester can display the analog video signal input from an attached analog camera or video source with NTSC or PAL format video output. The Tester can provide 12VDC (not to exceed 2A) to power the camera. If the camera has an RS485 port for PTZ control, the Tester can be used to test that

functionality. The Tester provides support for more than 30 PTZ command formats.

RS485 PTZ Control (Pan, Tilt, Zoom)

The Tester supports RS485 PTZ Control and more than 30 kinds of PTZ Protocols which can be carried out through the RS485 interface for control.

Data Monitoring

The Tester supports receiving data over RS485 and displays on the screen for data analysis.

High Definition Analog Camera Test

The Tester will display the analog video signal input from an attached analog camera or video source with AHD 1.0 or TVI 2.0 format video output, HD-CVI 2.0 or AHD 2.0, CVI 3.0, or TVI 3.0. The Tester can provide 12VDC (not to exceed 2.0 Amps) to power the camera. If the camera has an RS485 port for PTZ control, the Tester can be used to test that functionality. The Tester provides support for more than 30 PTZ command formats.

Video Test Image Generator

This function mainly generates video signals, which can be used to test analog transmission lines, video recorders etc., It has the capability to display the input video simultaneously on the display for easy comparisons to the image being generated. The video formats supported include PAL and NTSC, HD-CVI, HD-TVI, AHD and HDMI.

POE and DC Output

The Tester will automatically detect if a camera needs to be supplied with POE when an IP camera is directly connected to Network Port 1 (i.e., the blue port). Network Port 2 accepts POE to test the POE output of installed PSE network devices. You may also use the Tester's 12VDC output jack to power analog cameras.

Audio Test

The Tester can be used to check audio signal functionality which is input on the Tester's audio input jack.

WIFI & RF Tools

The Tester supports RF Spectrum Testing, WIFI Testing and Signal monitoring @2.4G, 5G bandwidths. This can be effective in detection of WIFI signal interference and determining if the data channel is being blocked or has conflicts. Signal Strength Detection can help engineers find the most suitable location and direction for WIFI connections by quickly detecting the signal strength.

Network Test

The Tester may be used to perform several Ethernet network test functions, including:

Network Sniff: Monitors and displays Ethernet MAC IDs and IP addresses broadcast on the network

Subnet List: Monitors and displays Ethernet MAC IDs and IP addresses broadcast on the selected subnet according to IP and mask settings

Ping Test: Performs the standard ping messaging response test on the specified destination IP address

TDR & RJ45 Cable Test

The Tester may be used to check the condition of the RJ45 cable pairs (normal, open, short) and perform a cable length measurement test using TDR. TDR (Time-Domain Reflection)

The Tester may be used to check the condition of the RJ45 cable pairs (normal, open, short) and perform a

cable length measurement test using TDR. TDR (Time-Domain Reflection)

Video Snapshot, Recording and Playback

The Tester supports allows video snapshot and recording under the conditions of video playback during the ONVIF test and analog video test (SD and HD) Allows for playback of any saved snapshot or video.

Basic Operation

Installing the Battery

The CamView IP series of testers use a rechargeable lithium-ion polymer battery. To ensure safety when transporting, always disconnect the battery from the tester. The device may leave the factory with one of the following two battery placements:

The battery is placed inside tester and insulated from the contacts with a thin, plastic sheet. In this case, the user should open the battery cover, take out the battery, remove the plastic sheet, then put the battery back in, and put the battery cover back on.

The battery is placed outside the tester. In this case, the user should open the battery cover, put the battery securely into the battery compartment, and put the battery cover back on.

Note — The tester will automatically turn on when the battery is properly placed in the device for the first time.

Charging the Battery

Be sure to fully charge the battery prior to first use. If the battery level is too low, the charge indicator will flash 3 times, and the device won't turn on.

You should use the POE injector and ethernet cable provided by the manufacturer to charge the battery. To charge the unit, connect one end of the ethernet cable to the **Data/Power-out Port** on the POE Injector, then connect the other end of the ethernet cable to the **Network Port 2 (Green outline)** on the tester. Once you have connected the ethernet cable on both ends, plug in the power cord for the POE Injector into a power outlet. **Network Port 2** will light up with an orange light when the internal battery is recharging.

Frequently Asked Questions About the Battery

The Tester uses a lithium-ion polymer battery, which does not have a memory effect. Users can recharge the battery whenever they want.

When recharging, the **Charge Indicator** on the tester will light up red. When the battery is fully charged, the light will turn off.

Due to calculation deviation or other reason, the battery level can be as low as 90% when the charge light turns off. Users can ensure their battery is fully charged by extending the charge time for up to 60 minutes.

Lanyard

Users can choose to install the lanyard. The lanyard can help when handling the device, prevent dropping the device, avoid damage to the device, and prevent loss.

To install the lanyard, put one end of the lanyard through the hole at the top of the device, turn back and go through the slip-lock (i.e., the plastic piece similar to a buckle). Tighten the lanyard and confirm that it is locked in position.

Powering the Device ON/OFF

To turn on the device, press and hold the **Power Button** for more than 2 seconds. The **Power Indicator** will light up green when the device is turned on.

To turn off the device, press and hold the **Power Button** for more than 2 seconds. When the device is turned off, the green **Power Indicator** light will turn off after the device is fully shut down. Users can also setup the idle auto power off feature.

LED Worklights

The tester LEDs at the top of the unit also double up as an LED Worklight. In the ON or OFF state simply quick press the Power button two times to toggle the worklight on or off. Great feature for working in low light conditions.

3.4 IP camera test

Please use ONVIF test function to test IP camera, ONVIF test is designed to be a three - step guided operation, which combines the functions of Ethernet test, IP setting, camera discovering, user authentication, image viewing, PTZ control, modification of camera parameter and so on.

Click to select "ONVIF test", and then enter Step 1 of ONVIF test,

3.4.1 : Step 1 — Power and network connection test

A. Interface content



On the interface, Blue bar represents the status of Network port 1, and Green bar represents the status of Network port 2.

Gray bar shows the information of WIFI network. On the right side, there is a function operation bar.

For the status of Network port:

①  : Indication of Ethernet connection rate, which represents the current status of Ethernet connection.

When the text is displayed as "Link down", it means there is no network connection.

When it is displayed 10M / 100M / 1000M represents the rate of connection used respectively. "FD" means the status of Full duplex; "HD" means the status of Half duplex. Meanwhile, the state of connection rate can be observed intuitively through the icon.

②  : Statistical display of Ethernet traffic

←represents the amount of outgoing data at this network port, which is in bps/kb/Mb.

→represents the amount of incoming data at this network port, which is in bps/kb/Mb.

③  : Display of Ethernet data packet loss

This icon shows the data packet loss at the corresponding network port, The displayed value is the success rate, which is 100% under normal circumstances,

The color of the icon is different at different success rates, so that it can prompt the user to pay attention to this content. The details are as follows:

RATE	No Link	100%	$\geq 99\%$	$\geq 95\%$	$< 95\%$
Color	gray	green	yellow	orange	red

④  : Display of POE power supply output state

This icon is for Network port 1, which displays the output state of POE power supply.

The first line represents the output state:

12V: Enable 12V output, meanwhile detect POE device.

PD.CLASS: Carry out the classification measurement on POE device.

PSE 48V: Supply the power to external POE device.

The second line represents the output power, which is in W. When supplying the power to external devices, its actual power is determined by these external devices. The tester has a maximum power limit. When the required power of the device exceeds the maximum power limit, the output will be automatically cut off.

⑤  : Display of POE power receiving state

This icon is for Network port 2, which displays both state and voltage of POE power receiving.

The text content is the input voltage of POE receiving.

⑥ WIFI connection status (gray bar)

Gray bar shows the connection status of WIFI network, including SSID, frequency band, connection rate and so on,

⑦ LAN information

Display the status information of LAN network port, including IP acquisition mode, address of the current IP and mask.

⑧ WIFI information

Display the status information of WIFI network port, including IP acquisition mode, address of the current IP and mask.

⑨ DHCP information

Display the status information of DHCP service for this device, including gateway of this device, address of DNS server, and how many devices acquire the address through DHCP service,

B. Operation methods

1. Connecting to network or camera. It is divided into the following cases:

① Connect to ordinary switch and 12V camera,

Use a standard RJ45 cable to connect to Network port 1 or Network port 2. At this time, the corresponding status information will be displayed on the screen. The network port of the tester supports automatic adapt with of MDI/MDIX connection.

The camera can be powered by the power adapter that the camera comes with, or by the tester. When using the tester to provide 12V output, please use the accompanied 12V output cable to connect 12V output port on the right side of the tester and the power input connector of the camera.

The tester supports a maximum output of 12V/2A. When the required current of the camera exceeds the maximum limit, the output will interrupt automatically.

▲ Attention: If Network port 1 is connected to POE receiving device, then 12V power supply is disabled, giving priority to POE power supply.

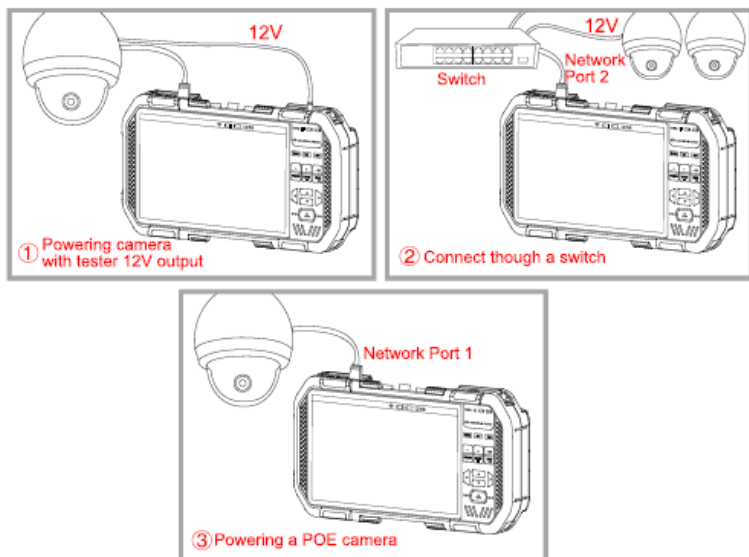

② Connecting to POE switch and charging the tester at the same time.

Use RJ45 cable to connect POE switch and the tester's Network port 2 (green), The orange indicator light of the tester's Network port 2 is ON, which indicates there is an incoming POE. If the battery level of the tester is less than 95%, the charging indicator light will be ON.

One switch can be connected to multiple ONVIF cameras, which may be powered by itself or POE.

③ Connecting to POE camera.

Use RJ45 cable to connect POE camera and the tester's Network port 1 (blue), The tester will first detect whether there is a POE device, and then power it,

When supplying the power to POE device, the tester's 12V output will be disabled.

When the power required by the POE device is greater than the maximum output power of the tester, the output will automatically interrupt.

! This tester's PSE power supply mode conforms to the standards of 822.3at / 802.3at, with the maximum power of 25.5W.



1. LAN IP mode

① LAN DHCP acquisition

This mode is for connecting to a video surveillance network at work.

When the tester enters the ONVIF state, it is DHCP acquisition mode by default.

In this mode, the tester will discover the DHCP service in the network, and attempt to acquire an IP.

After having acquired it successfully, the screen will display the acquired IP.

② LAN static IP

This mode is for connecting a network or camera with static IP.

Click "LAN static IP" on the screen, and then enter the IP setting interface.

Please enter relevant settings.

Setup static IP

IP address

Mask
255.255.255.0

24

Gateway

DNS

Recent IP: 192.168.200.89
Saved IP: 10.1.1.128

Cancel Confirm

2. WIFI IP mode

① WIFI DHCP acquisition

This mode is for connecting to a video surveillance network at work through WIFI.

When the tester enters the ONVIF state, it is DHCP acquisition mode by default.

In this mode, the tester will discover the DHCP service in the network, and attempt to acquire an IP.

After having acquired it successfully, the screen will display the acquired IP.

② WIFI static IP

This mode is for connecting a network or camera with static IP through WIFI.

Click "WIFI static IP" on the screen, and then enter the IP setting interface.

Please enter relevant settings.

3. Providing DHCP service

This mode is for connecting a single camera using DHCP.

On the screen, click "Providing DHCP service", and then switch to "DHCP service" mode.

In this mode, the tester will set this device to a static IP, and then enable the DHCP service to distribute IPs for other DHCP devices in the network,



Attention: If connecting the network in use, where there is a DHCP service in the network, it will cause part of devices to acquire incompatible IP addresses due to multiple DHCP services, which may interfere with the network operation.

4. Using this device as a WIFI hotspot

This mode can set this device as a WIFI hotspot, so as to facilitate other wireless devices to connect to this device for testing.

Click "Using this device as a WIFI hotspot" on the screen, and then enter the function settings (as shown in the figure)

"SSID": Set a name for this hotspot, which can be entered just by clicking the input box.

"Password": Set a password for this hotspot, which can be entered just by clicking the input box. If the authentication method is as "OPEN", the password is set to blank.

"Authentication method": Set an authentication method for this hotspot, which supports three modes : "OPEN", "WPA-PSK" and "WAP2-PSK".

"Channel": Set a working channel for this hotspot.

"Frequency band": Mode of frequency band for the hotspot, which supports two modes of "2.4G" and "5G".

"DHCP service": Whether the hotspot to enable the mode of DHCP service,

5. Connecting to WIFI

Click the button of "Connecting to WIFI" on the screen, and then enter the interface of WIFI connection, as shown in the figure.



Select the name of wireless network that needs to be connected to, and then enter the password. At this time, the designated WIFI network will be connected to just by clicking "Connecting to WIFI".

6. WIFI and LAN bridging

Through this function, both LAN network and WIFI network of this device can be bridged, so as to connect the devices in these two networks.

Click the button of "WIFI and LAN bridging" on the screen. If the device has been properly connected to LAN network / WIFI network, then the connection icon on the main page will light up, as shown in the figure.

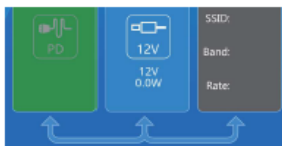

7. Entering the next test step

After it is confirmed that the tester's network connection information is normal, and the tester has acquired its IP, press the Next step key to enter the next test.

3.4.2 : Step 2 — Discovering the device

This step will discover and list the cameras in the network, meanwhile it will display the snapshots of the cameras for quick identification,



1. Camera list: It displays the camera that has been discovered, which can be selected by clicking on it.

2. Camera state and snapshot: When camera is selected, the status bar will display the snapshots and information of the camera directly. If need ONVIF authentication, the status bar will display "Camera needs to be authorized". Can the snapshots and information of the camera be displayed normally only after entering the correct user name and password.

3. Re-discovering: Clear the camera list and restart the operation of rediscovering.

4. Manually adding: Remote cameras can be added for further operation by manually adding their domain names or IP addresses.

3.4.2.1 Camera list

This step will discover and list the cameras in the network, meanwhile it will display the snapshots of the cameras for quick identification.

After entering this step, the software automatically broadcast the ONVIF Camera discovery data, and attempt to discover the cameras in the network, then add them to the list on the right side.

The number of discovered cameras will be displayed on the top of the list.

When the camera doesn't appear on the "Camera list", click the button of "Re-discovering" to clear the list, and then restart the operation of rediscovering.

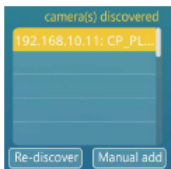

! Attention: When part of cameras cannot respond/appear on the "Camera list" due to they are located in different network segments, the user shall first return to Step 1, and then modify the IP of this device, so as to make it be in the same network segment of the camera (Please note that the IP can't conflict with other devices in the network after modification.); after that, enter Step 2, and attempt to discover the camera.

3.4.2.2 Viewing the snapshot and camera image parameters

In the "Camera list", click and select the camera; 1~3 seconds later, the video snapshots of the selected cameras will appear on the left side of the screen for the user to quickly identify.

The resolution, refresh rate and compression mode of camera video are displayed below the image.

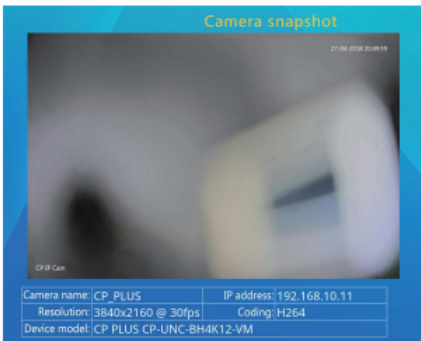

Some cameras need ONVIF authentication, That is, it prompts that the camera needs to be authorized on the position of information display (as shown below). Can the camera information be displayed only after carrying out the operation of user login, For its operation methods, see "Use of authentication and password".



3.4.2.3 Use of authentication and account book

Some cameras need ONVIF authentication, That is, it prompts that the camera needs to be authorized on the position of information display. At this time, click the user name and password, and then enter the corresponding information through virtual Keyboard on the screen; after that, click the key of "Login" for authentication.

If need to use the function of account book, click the button of " " on the screen, and then enter the interface of account book (as shown in the figure).



Select the preset account and password, then click the button of "Confirm" to log in.

If need to add, delete or modify the preset account and password, click the button of "Modify" to enter the modification interface (as shown below).



After having set the information content that needs to be added, then just click the button of "Save".

3.4.2.4 Manually adding a camera

Click the button of "Manually adding a camera", and then manually add a camera (as shown in the figure)



To manually add a camera, the user needs to know both IP address and ONVIF service path of the camera.

After having entered the designated address by clicking the middle input box on the screen (you can quickly select the frequently-used text of address format on the right selection box for shortcut input), press the button of "Confirm", and then log in.

3.4.3 : Step 3 — Video and PTZ

This step can display the real-time video of the camera, control PTZ rotation, and set the camera parameters.

3.4.3.1 Displaying the real-time image of the camera

Enter Step 3, and automatically display the camera image.



1. Click it to switch between UDP and TCP.

2. "Snapshot": Click it to snap shot the current camera screen,

3. "Recording": Click it to record the camera video.

4. "Full screen": Click it to display the camera image in full screen,

5. "Digital zoom": Click it to enter the interface of "Digital zoom" (as shown in the figure) Click the button of "+/-" to zoom the image for display; meanwhile, move the camera image by the green block directly.

6. Camera setting

Click the button of "Camera setting" to enter the camera parameter setting interface. (as shown in the figure)

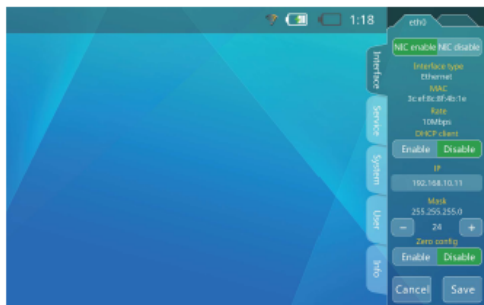

Its left side displays the setting classification, and its right side displays the specific setting content.

The setting classification is as follows:

Name	Description
Network interface	The settings of camera network interface include IP, gateway and so on. For the camera with multiple network interfaces, there may be multiple network interface settings.
Service	Gateway, DNS server and other information. The gateway or DNS server can be modified here.
System	Camera restarting, restoring the factory settings, whether the device can be discovered, HTTP port information and etc.
User	Display the user name and level. The user information can be deleted here.
Device information	Model, manufacturer and other information of the camera. These contents of the classification cannot be modified.

⑦ Camera Profile setting

Click the button of "Camera Profile setting" to enter the interface of Profile setting (as shown in the figure), and then set the image parameters such as camera resolution, quality, data rate, and frame number.

⑧ "PTZ speed"

Click the button of "PTZ speed", and then adjust the PTZ movement speed, where it supports Level 1-10 adjustment.

⑨ "Volume"



Click the button of "Volume", and then adjust the camera volume, where it support Level 1-10 adjustment.,



3.4.3.2 ONVIF PTZ control

Press the button of "Full-screen display", and then switch to the status of full screen video, At this time, the interface disappears, and the video image will occupy most of the screen.

Due to the difference of aspect ratio, part of the screen will be black, where no content is displayed.

In the state of full screen, you can use  and  to control the camera PTZ.

3.5 Analog camera test

This function can be used to test the analog video signals, and display the images, image formats, etc., as well as send PTZ control commands, test and control PTZ.

3.5.1 Connecting to analog camera

For analog camera, its video is connected by using a BNC connector. Use a BNC connecting line to connect the video of analog camera to VIDEO IN connector at the top of the tester.

The camera can be powered by its own power supply or 12V/2A output provided by the tester.

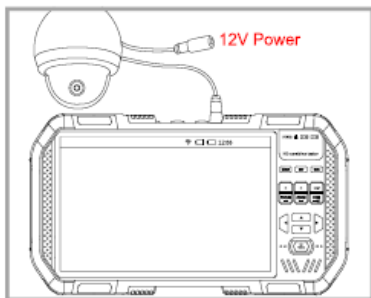

Attention:

The maximum output power of the tester is 12V/2A. When the power exceeds the maximum power, the output will cut off automatically. If connecting a camera with high-power IR lighting, it is necessary to pay attention to this limit.

While Network port 1 is connected to a POE device, 12V output will be disabled.

3.5.2 Analog camera test

Click / select the button of "Analog camera test" to enter the interface of analog video test.



1. Coaxial HD decoder

The system currently supports three formats of coaxial HD decoder: CVI, TVI and AHD. The default state of the system is to automatically identify the input signal format; meanwhile, the input signals can be decoded by a manually designated decoder.

2. PTZ setting

Click "PTZ setting" to enter the settings of RS485 / coaxion PTZ control (as shown in the figure).



Adjust the relevant contents /parameters according to the prompts,
Various settings are described as follows:

RS485 PTZ control

Protocol	Set the protocol used by the camera PTZ. The tester supports a variety of PTZ protocols.
Baud rate	Baud rate used by RS485 communication.
PTZ address	Address code of the controlled PTZ. Due to different understanding of each manufacturers, the address may deviate from +/-1, whose setting range will be determined according to various PTZ protocol.
Preset position	The current PTZ state can be saved in the PTZ controller of the camera. This function needs some support from PTZ controller (for details, please refer to Camera manual).
Call	PTZ can be quickly restored to the PTZ state saved before. This function needs some support from PTZ controller (for details, please refer to Camera manual).

After setting, press the key of "Return" to exit. Then, various settings are immediately effective.

Connect the matching RS485 wires to the controlled PTZ's RS485 communication line, and then just use  to control PTZ rotation

Coaxial HD PTZ control

The signals of coaxial HD PTZ control are directly communicated with the camera through video lines. Various settings are described as follows:

Protocol	Set the protocol used by the coaxial PTZ. CVI protocol (dahua coax), AHD protocol (Pelco c) and TVI protocol (Hikvision)
Baud rate	No use of baud rate in coaxial control
PTZ address	No need to set any address for coaxial control
Movement speed	Expected PTZ speed, with the setting range of 10%~100%.
Preset position	The current PTZ state can be saved in the PTZ controller of the camera. This function needs some support from the corresponding controller (for details, please refer to Camera manual).
Call	PTZ can be quickly restored to the PTZ state saved before. This function needs some support from the corresponding controller (for details, please refer to Camera manual).

3. Analog video snapshot / Analog video recording

In the interface of analog video, click the button of "Snapshot" to snapshot the current video. At this time, it will display "The snapshot is saved", file name and path.

In the interface of analog video, click the button of "Record video" to start recording the current video; press the button of "Record video" once again to end the recording. At the end of the video recording, it will display "The recording is saved", file name and path.



4. OSD menu

Call the OSD menu function of dome camera (for details, please refer to Camera manual).

Click on "OSD menu" button on screen or press "IRIS+" button (depend on camera) will turn on camera OSD menu, Use  arrow keys and "IRIS+" key to operate the menu. For protocol selection and OSD function detail, please refer to camera manual.



5. Digital zoom

In the interface of analog video, click the button of "Digital zoom" to enter the state of Digital zoom. (as shown in the figure)

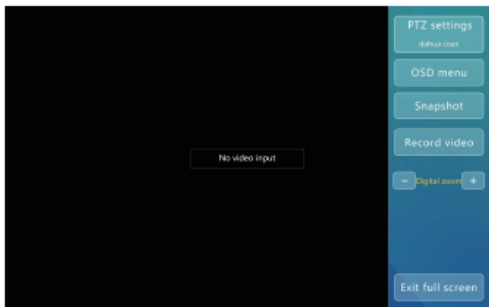

Press the button of "-" / "+", and then zoom out / in the image. At this time, Digitally zoomed image is displayed,

Move the display area by dragging the green box on the screen, so as to view the different parts/positions of the image.

6. Full-screen display

In the interface of analog video, click the button of "Full-screen display" to enter the mode of full-screen display (as shown in the figure).

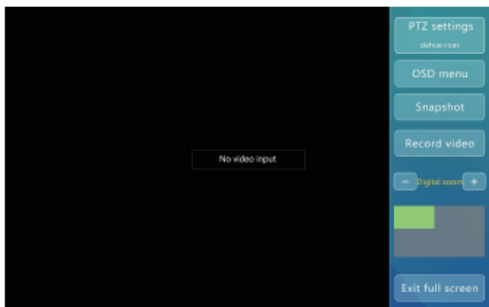

After 2 seconds without any operation, the right menu bar is automatically hidden, and then the camera image will be displayed in full screen.

Click on the screen, and then re-call out the right operation menu to carry out the corresponding operation.

3.6 Network tools

Click the button of "Network tools" to enter the interface of network tools (as shown in the figure).

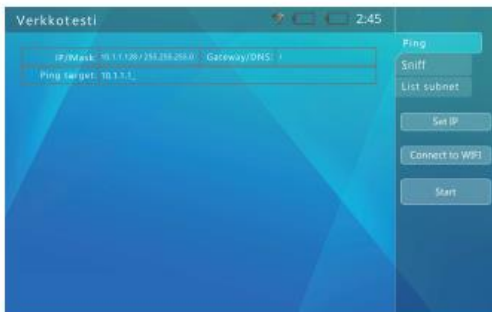

1. IP setting

In the interface of network tools, click the button of "IP setting" to enter the interface of IP setting (as shown in the figure).

If DHCP services are provided in the network, you can select the key of "DHCP" to automatically acquire IP, DNS and gateway address. Otherwise, you need to select "Manual setting", and then enter IP, DNS, gateway and other contents.

2. Connecting to WIFI

Click the button of "Connecting to WIFI" on the screen, and then enter the interface of WIFI connection, as shown in the figure.

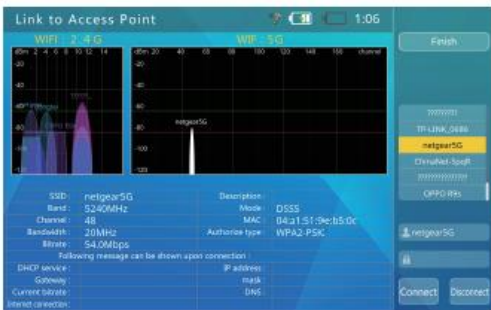

Select the name of wireless network that needs to be connected to, and then enter the password. At this time, the designated WIFI network will be connected to just by clicking "Connecting to WIFI".

3. PING

Ping is a frequently-used function in network testing. The function of "Ping" can be used to check whether the network is connected or not, and acquire the information such as channel delay, which may well help us to analyze and determine the network faults.

To use the function of Ping test, IP address, mask and target address need to be set. When the target is a name rather than an IP address, it is necessary to set DNS server and gateway. If need to modify IP, mask, DNS and gateway, click the address input box next to "Ping target", and then enter the designated IP address.

After setting, click the button of "Start" to start the Ping test.

The Ping test displays the results in the form of chart. The demonstration display contents are as follows:



Bar chart shows each time delay period and the percentage of packet loss for the Ping target.

Line chart shows the Ping target address delay within the recent 120 seconds. (Y-axis: Logarithmic scale, and X-axis: Ping packet sending-out time.)

The Ping function can save the test report. Click the button of "Save the report", and then generate a report. This report is saved in the built-in memory of the tester (/NetworkTest), which can be viewed by using a USB cable to connect with PC. You can also access the tester through FTP, and then acquire the report. FTP address is IP address of the tester, and its account and password are both "ftp".

The example of the report is as follows:

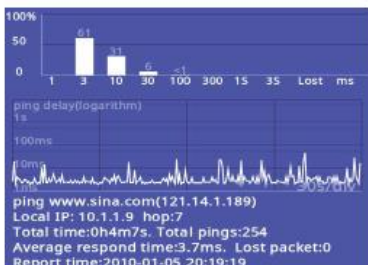

! Attention: This example is only for reference, and cannot be used as a test standard

Exit the PING function by clicking the button of "Stop".

4. Sniff

Click the button of "Sniff" on the screen to enter the interface of sniff, which does not need to set any network parameters and target addresses, which can be started directly just by clicking the button of "Start". (as shown in the figure)



After the sniff detection starts, it will monitor the network continuously, as well as detect both MAC and IP of the received broadcast packets. If any unlisted MAC or IP, they will be automatically added to the list.

The list format is: XX-XX-XX-XX-XX-XX |.I.I.I

XX: MAC address, displayed in hexadecimal, I: IP address, displayed in decimal.

Most network devices send out some broadcast packets periodically, indicating their own existence. By detecting these packets, the function of sniff detection can be used to discover some devices with unknown IP in the network.

When need to connect to a camera with unknown settings and unknown IP, it is necessary to first test the function of DHCP distribution; and if this camera does not actively acquire any IP, it may uses a static IP. At this time, you can use the function of sniff detection to discover the device.



Attention: The function of sniff detection does not detect any unicast (point-to-point) packets. According to its frequency of data transmission, it usually takes 3-60 seconds to discover the device by means of the function of sniff detection, or the device can't be discovered due to it always keeps silent.

The function of sniff detection only detects the broadcast packets, so it doesn't distinguish the network segments, which can discover not only the devices across the network segment, but also various Ethernet devices that do not have any IP address.

Exit the function of sniff detection by clicking the button of "Stop".

5. List subnet

To use the function of list subnet, both IP and mask of the tester need to be set. The mask must be of 24 bits, that is, the subnet size is of 256.

After setting the IP and mask, click the button of "Start" to start the function of subnet list.

The function of list subnet can be used to scan all devices in the subnet. The designated device must respond, so all the normally- working devices in the same subnet will be 100% scanned out. In addition, this function of subnet list can also be used to measure the speed of the network, which is in milliseconds. (as shown in the figure).

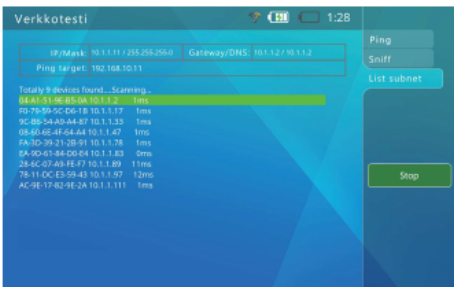

For subnet list, its display format is: XX-XX-XX-XX-XX-XX I.I.I.I N ms

XX : MAC address, displayed in hexadecimal. I: IP address, displayed in decimal.
N: Network delay.



Attention: This function cannot be used to detect the devices across the network segment, but the success rate on the same network segment is 100%.

It needs to take 1~10s to finish the subnet list.

Exit the function of subnet list by clicking the button of “Stop”.

3.7 Wireless test

This function can be used to scan both spatial signal and WIFI hotspot @ 2.4G/5G WIFI frequency band. It can display the usage of frequency band / channel in the current area, providing a powerful basis for the engineers to adjust and optimize the network.

The device adopts the hardware structure of external foldable dual antenna (dual-band Dipole omnidirectional antenna), which is as shown in the figure:

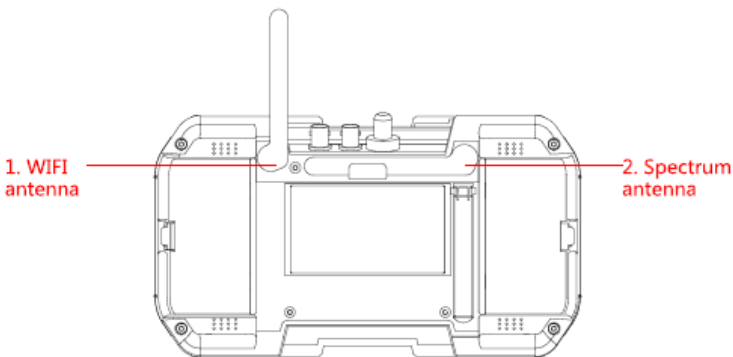

The external antenna is of release design, so as to prevent the antenna from breaking due to collision when opening it. If the antenna falls off due to collision, the user can align its rotating shaft to the original installation position, and then press it back with a little force. Attention: The antenna conductor shall be naturally bent. Never pull, fold, twist it by force or make it get stuck. If the antenna is damaged, please contact the after-sales service personnel for its replacement.

When using the function of wireless test or WIFI connection, please open the corresponding antenna. When not using the wireless function, the antenna shall be retracted, so as to avoid any collision,

Click the button of "WIFI / RF tools" to enter the interface of wireless test.

3.7.1. Spectrum test

This function supports 2.4G, 5G frequency band, which can be used to scan/detect both spatial spectrum signals and WIFI hotspots in the current environment. Among them, the spatial spectrum detection is used to detect and display all the spatial data's communication signals and noise (interference) signals; the WIFI spectrum test is used to display the scanned WIFI hot spots in the form of spectrum graph.

The interface of spectrum test is as shown in the figure:

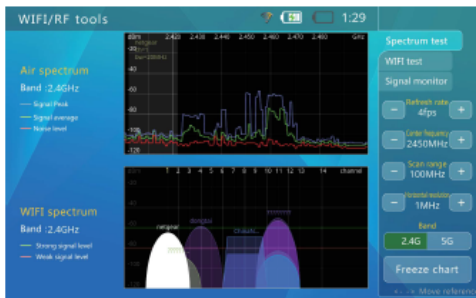

Selection of "frequency band"

Select the air signals and WIFI hotspots @ 2.4G or 5G frequency band for detection and display.

When select "2.4G" or "5G" frequency band by clicking, the interface will display the name of discovered WIFI hotspots @ the current band immediately.

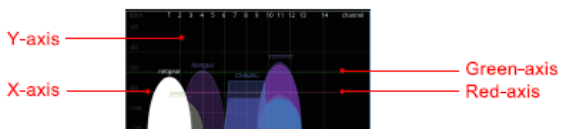

Y-axis (in dBm) represents the level of WIFI hotspot signal

Red line represents the reference line of weak signal level (-80dBm); if lower than this line, WIFI signal is at a weaker level.

Green line represents the reference line of strong signal level (-60dBm); if more than this line, WIFI signal is at a stronger level.

X-axis represents the channel of WIFI signal.

For the function of "WIFI spectrum", the channel No. will be identified according to the standards of 802.11a/b/g/h/j/n/ac/ax.

In the map of WIFI hotspots, Ellipse represents the hotspots of DSSS signal modulation (Fig. 1), and Trapezium represents the hotspots of OFDM signal modulation (Fig. 2). For the map of WIFI hotspot, its height indicates the level of hotspot signal received by this device; its width indicates the bandwidth usage for this hotspot, (the color of hot spots is selected randomly.)

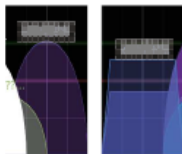

Fig. 1

Fig. 2

If there are multiple WIFI signals using an overlapping channel in the space, there will be some signal congestion, which may cause a communication delay, therefore this function can be used to discover a more idle channel in the space for use, so as to solve the problems of signal congestion / communication delay.

When need to select a certain hotspot signal for test, you can just click the hotspot directly on the screen, After selection, the hotspot will become white, If some hotspots can't be selected due to overlapped, select the hotspots to be tested by using the button of "Left" and "Right".

After selecting a hotspot, a white column will appear in the interface of "Air spectrum".

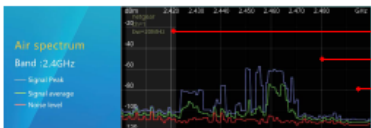

White podetium

Y-axis

X-axis

Y-axis (in dBm) represents the level of spatial air signals.

X-axis (in GHz) represents the signal frequency.

White column represents the frequency range of the currently-selected hotspot.

Red curve represents the test results of noise level.

Green curve represents the test results of average signal intensity.

Blue curve represents the test results of signal peak.

The function of "Air spectrum" supports the detection within the spectrum range of 2.40 ~ 2.50G and 5.0 to 5.8G, which covers the spectrum signal range (802.11a/b/g/h/j/n/ac/ax standards),

For spatial air spectrum function test, the signals include all the signals with the same frequency, such as WIFI, Bluetooth, ZigBee, non-standard signal, and radio noise.

Through this function, it is observed that Red line at a certain frequency point is at a higher level, which means that there is some strong signal interference at this frequency. If for the selected WIFI hotspot signal, there is some signal interference within the spectrum range of white column, which means that there may be some WIFI communication delay, packet loss and other abnormal problems,

For spatial air spectrum, the measurement results of Green line and Blue line indicate the usage of the corresponding frequency. When Green line is at a higher level, it indicates that the occupancy rate is higher at this frequency, which may cause some WIFI communication delay, packet loss and other abnormal problems.

In order to observe the spatial spectrum conveniently, you can also adjust the working parameters of spectrum test by using the following function buttons.

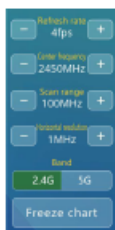

"Refresh rate" Click the button of "+/-", and then adjust the spectrum refresh rate. Lower refresh rate is convenient for discovering the statistics of signals; higher refresh rate makes it easier to detect the beating of signals in a timely manner,

"Center frequency" Click the button of "+/-", and then adjust the spectrum center,

"Scanning range" Click the button of "+/-", and then adjust the range of scanning/ displaying frequency.

"Horizontal resolution" Click the button of "+/-", and then adjust the resolution of scanning frequency.

"Freeze chart" Click it, and then keep the image of current spectrum at a standstill, so as to be convenient to observe.

3.7.2 Wifi test

Click the button of "Wifi test" to enter the function (as shown in the figure).



This function can be used display the received WIFI hotspots @ 2.4G and 5G frequency band in the form of spectrum, as well as list all SSID of visible hotspots on the right side. After clicking the selected hotspots in the list, the detailed parameters of this hotspot will be displayed in the middle of the image. This hotspot needs to be logged in before its network information can be displayed. If need to log in a hotspot, click the input box of "IP address", and then enter a correct password; after that, click it for connection. If the connection is successful, the specific network information of this hotspot can be displayed (as shown in the following figure).

3.7.3 Signal monitoring

Click the button of "Signal monitoring" to enter the function (as shown in the figure),

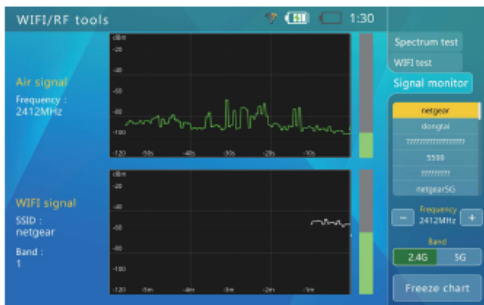

Click / select the hotspot in the right WIFI list, and then the “frequency” below will jump to the central frequency point of this hotspot channel; after that, start detecting the signal intensity at this frequency point, (as shown in the following figure)



Y-axis (in dBm) represents a signal level at the frequency.

X-axis is a time axis.

Green bar quickly display the signal change at the frequency point.

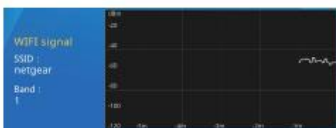

Y-axis (in dBm) represents a signal level of the channel.

X-axis is a time axis.

Green bar quickly display the signal change of the channel.

With the aid of the above two charts, the engineers can test and observe the signal intensity of this WIFI hotspot at different position, angle and direction, which can also display the channel occupancy at the corresponding frequency points, so as to assist engineers to select the proper installation position and direction when installing WIFI devices.

3.8 Cable TDR test

Click “Cable TDR test”, and then enter the interface of TDR test. (as shown in Fig. 1)



Fig. 1

When the icon of “Measuring tape” flashes on the interface, it indicates that the network port is being measured.

The measurement results of network port are as shown in Fig. 2, where 12, 36, 45 and 78 are 4 pairs of twisted-pair in the RJ45 cable respectively. The state includes Normal, Open-circuit and Short-circuit. The length or the position of breakpoint shows the length of measured cable or the length between the breakpoint and the test point. The cable attenuation value is used to measure the cable attenuation, and the quality of measured cable,

When entering this function, one measurement will be done automatically.

If need to measure it once again, click the button corresponding to the color of network port, and then start a new measurement. When need to carry out a continuous measurement, click the button of "Continuous measurement". When the prompt changes to "Stop continuous test", it indicates that it is in the state of continuous measurement currently.



Fig. 2

Example of measurement quality (as shown in Fig. 3):

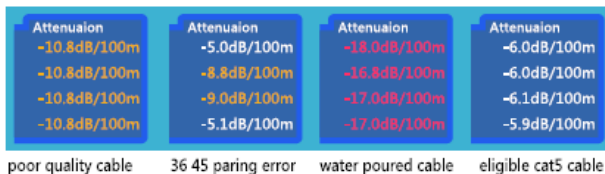

Attention:

These test results are affected by temperature, humidity, cable diameter, cable medium and other conditions, so the measurement results are for reference only, and cannot be used as official measurement results.

Continuous measurement is convenient for measuring multiple cables, which does not increase the accuracy of measurement.

When the cable is connected to a terminal device for measurement, the echo may very weak due to good termination of cable, or there is some impedance discontinuity caused by a damage or joint in the middle part / position of the cable. In this case, the measurement results may be significantly less than the actual length, so it is recommended to disconnect the terminal devices during the measurement.

3.9 Record playback

The tester can snapshot and record both analog and IP camera videos, and then save them in the built-in memory. This function can be used to list out the snapshots and videos saved before, as well as view these snapshots and playback the video contents.

"Delete": Delete folders, snapshot images, recording videos and other contents.

"Re-name": Re-name folders, snapshot images, and recording videos.

"New a directory": New a folder for saving.

"Set as default directory for today": When selecting this function, all snapshot images and recording videos will be saved in this folder on that day.

"Full-screen display": Playback the snapshot images and recording videos in full screen.

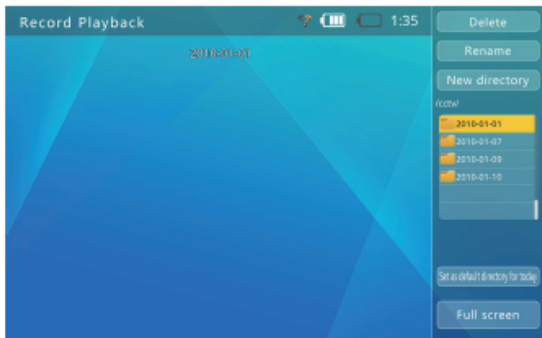

3.10 RS485 data monitor

When maintaining the front-end dome camera, this function can be used to receive and display the data on the RS485 bus. Use these data to analyze whether the protocols of PTZ controller are normal or not.

Connection methods: Use RS485 connecting cable accompanied with the tester to connect RS485 interface of the tester and the tested RS485 communication bus. Red alligator clip: To D+; Black alligator clip: To D-.

Click / select the button of "RS485 data monitor" to enter the interface of analog video test.



Click the button of "+ / -", below "Baud rate", and then set the baud rate, so as to make it be in line[it match] with that of the measured RS485 bus. When the tester receives some data, these data will be displayed on the screen. Press it match to pause / resume receiving the data.

The tester will carry out an automatic line break according to the received data. Click the button of "+ / -" below "Display line width" to set the line width.

Click the button of "Clear the data", and then clear the displayed data.

3.11 Signal generator

Click the button of "Signal generator", and then enter the function of signal generator.



“System select”: Test image format, which supports the format selection of SD (PAL and NTSC), HD-CVI, HD-TVI, AHD, HDMI.

“Resolution”: Switch the resolution of coaxial HD signal test image between 720P / 1080P.

“Refresh rate”: Select the resolution of the output video signal.

Application examples of signal generator

As shown in the figure :

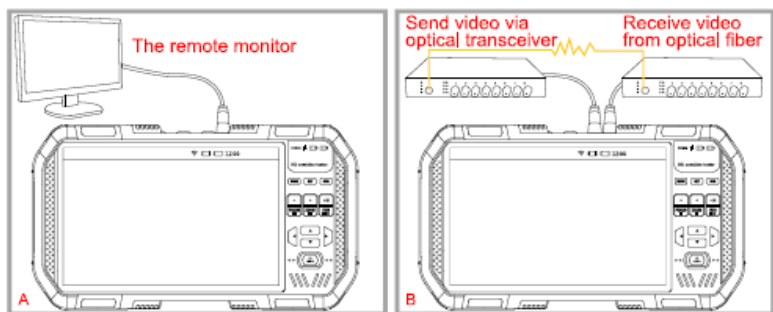

A. Transmit the test video to the remote monitor or video recorder, and then judge the transmission quality (good / bad) of the transmission line by viewing the image quality in the remote monitor.

B. Convert the video signals output from VIDEO OUT port to optical signals through the transmitting end of optical transmitter / receiver, and then convert them back to analog video signals through the receiving end of optical transmitter / receiver, which will be input via VIDEO IN port. The transmission quality (good / bad) of optical transmitter / receiver can be judged by comparing the two images in the interface.

3.14 System setting

The function of system setting can be used to set some operation parameters of the system, Which also includes USB storage function and system upgrade function.

Click the button "System setting" to select the function of system setting, and then enter the interface of system setting.

(as shown in the figure),



Setting the automatic shutdown time

Select the option of "Automatic shutdown", and then use the button of "+ / -" to adjust the options. The adjustment step is 5 minutes. The minimum time is 5 minutes, and the maximum is 60 minutes. When the time is 5 minutes, if continue to press the button of "-", it will be disabled. At this time, the function of automatic shutdown is disabled.

When it has lain idle till the set time, the tester will automatically shut down.

Setting the keyboard prompt tone

Click the option of "Keyboard tone", and then select/press the button to switch ON/OFF the tone.

Setting the screen language

The tester supports a variety of languages for display. Click/select the desired language on the screen, and then just save it.

Modifying the backlight brightness

For the display screen of the tester, its backlight brightness can be adjustable at 10 levels. In outdoor environment with strong light, a higher brightness is needed to improve the contrast of screen, while a lower brightness can reduce the power consumption of the tester.

Select the option of "Backlight brightness", and then use the button of "+ / -" to adjust the options; after that, the backlight brightness will change immediately.

Adjusting the system time / date

Click the button of "+ / -" corresponding to the date / time, and adjust them to a correct one respectively, then just click the button of "Save".

System upgrade

The tester supports the function of online upgrade.

First connect to a router that can access Internet by using RJ45 network cable or via WIFI, and then click the button of "IP settings" to enter the interface of network parameters (as shown in the figure).

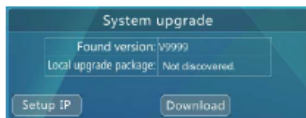

If DHCP services are provided in the network, you can select the key of "DHCP" to automatically acquire IP, DNS and gateway address. Otherwise, you need to select "Manual setting", and then enter IP, DNS, gateway and other contents. In addition, it also supports the online upgrade through WIFI connection.

After the setting is completed, click the button of "Check the new version", it will automatically connect to the software upgrade server on internet, and then searching for a new software version. When a new version is found, it will be displayed. Press the button of "Download" for downloading. The download process is automatic. After the download is completed, the integrity of file package will be checked automatically.

Depending on the network condition, the download process may take several seconds to dozens of minutes. Please try to use broadband connection for downloading, so as to save your valuable time.

After the download is successful, a prompt of "Starting the upgrade" will be displayed on the screen.

After the completion of the upgrade, the system will be restarted automatically. Enter the interface of "Upgrade", and then press the button of **SET** to start a formal upgrade according to the prompts on the screen.



! Before upgrading, please confirm that the battery level is more than 30%. It is better for the tester to use an external power supply and be charged at the same time during the upgrading process, so as to avoid any damages to the software system caused by halfway power outage.

In the process of upgrading, do not open the back cover, do not take off the battery, do not press the button of "Reset"; otherwise, it may cause some damages to the system, which will not be able to start up.

USB storage

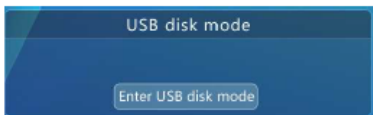

Due to data sharing, USB storage is disabled by default. When need to use the function of USB storage, enter the interface of system setting, and then select the function of USB storage to enter the interface of USB storage.

Use a USB cable to connect the tester and the host computer, whose operation method is consistent with that of other USB storage devices. When using the function of USB storage, please don't press the button of **MODE** or "Power" to shut down the tester. This operation will make the USB storage device be uninstalled from the host computer by force, which may cause some loss of storage data.

To disconnect USB from the host computer, please first safely eject the device, or uninstall the device from the host computer, and then disconnect the USB cable.

Viewing the serial number of the device

After entering the interface of system setting, the serial number of the device will be displayed at the last line.

3.15 Audio test

The function of audio test of the tester can be used to test the pickups (microphones) and other audio devices on the front end of video surveillance, so as to test whether the sound of the front end audio device is normal.

Use the matching 3.5MM connecting line to connect the audio signals, (Black clip: Ground wire; Red clip: Signal cable.) Please first connect the ground wire, and then connect the signal cable, so as not to input a larger noise.

3.16 Using POE to power the device

This tester supports POE power supply. After using an ordinary network cable to connect the tester's Network port 1 (blue) and the POE device, the tester can supply the power to the device immediately.

Please note that the POE devices connected must meet the standards of 802.3af or 802.3at, otherwise the tester will not supply the power to them. Therefore, it is safe to connect the non-POE devices via Network port 1 (blue).

When using POE power output, you can enter Step 1 of ONVIF test to view the actual power of POE output.



The maximum power of POE power output is 25.5W. When the power exceeds this limit, the tester will stop the output automatically.

It is forbidden to connect any non-standard POE power supply to Network port 1 (blue), otherwise it may damage the tester.

When using POE power output, due to the power consumption of external devices is large, it will greatly reduce the working time of built-in batteries.

Specifications

Model		HD Combine Tester
IPC test		
IPC protocol	ONVIF, RTSP, RTP	
Ethernet Test	10M/100M/1G Ethernet link detection; Ethernet loop detection; DHCP client and server; Ethernet traffic detection, data link quality detection.	
IPC Test	Discovering the device, real-time video, camera configuration, PTZ test, discovering ONVIF device cross the network segment	
IPC Image Test	H.264/H.265 decoding, support 4K@30FPS, local zoom preview (at 8 levels)	
Interface	Dual-port RJ45 Ethernet 1Gbps, support Series/bridge connection	
WI-FI test		
WIFI test	Support 2.4G and 5G frequency band, WIFI connection, WIFI list, WIFI information detection, delay detection, test of packet loss rate.	
Spectrum test	Support 2.4G and 5G frequency band, spatial frequency band signal scanning and detection, and spatial noise (interference) signal detection.	
Signal monitoring	Support 2.4G and 5G frequency band quick monitoring of signal change, refresh frequency: 1-10Hz,	
Antenna type	External foldable dual antenna. Dual band Dipole omnidirectional antenna	
POE test		
PD test	The tester receives the power. 802.3at; power supply voltage detection	
PSE test	The tester supplies the power, 802.3at; 25.5Wmax, PD actual power detection	
Analog video test		
Video format	NTSC/ PAL/ HD-CVI3,0 standard/ AHD3,0 standard/ HD-TVI3,0 standard	
Video signal	1Vpp	
Video input/ output	Video IN BNC input, Video OUT BNC output	
Video digital zoom	Support digital zoom at 8 levels	
Video signal generator	Sending PAL / NTSC video test signal, sending CVI, AHD and TVI video test signal (720P/1080P).	
HDMI signal test		
HDMI Input	Can receive 720P 25/30/50/60Fps,1080P 25/30Fps input signals for display	
HDMI Output	Can output various formats of test images(720P 25/30/50/60Fps,1080P 25/30Fps)	
12V power output		
Power output	12V/2A output Interface: Round, external diameter 4mm; Internal needle: 1.6mm	
Audio test		
Audio test	1 x Audio signal input	

Coaxial PTZ control test	
Communication interface	Video IN BNC interface
Communication protocol	CVI protocol (dahua coax), AHD protocol (Pelco c) and TVI protocol (Hikvision)
485 PTZ control test	
Communication interface	RS485
Communication protocol	More than 30 protocols, including Pelco-D/P, Samsung, Panasonic, Lilin and Yaan
Baud rate	150, 300, 600, 1,200, 2,400, 4,800, 9,600 and 19,200bps
LED lighting (flashlight)	
Head LED	2 x 35lm LED, wide angle
TDR cable test	
Cable test	Testing the length of network cable (4 pairs). Resolution: 0.1 meter; Accuracy: 1 meter. The maximum length of the measured cable is 130-200 meters (depending on the wire rod).
Power supply	
Charger	12V/1.5A 5.5mm round-plug power supply
Battery	Equipped with two battery compartments One special lithium battery pack can be placed in each battery compartment, with a single capacity of 18.5Wh. The combined working time is about 10 hours (it also can work with a single battery).
Charging	12V/1.5A charging, Power: 18W, max, Charging time: 3~4 hours,
Power saving	Can set the automatic switching of overtime and display the icon of battery level in real-time.
System parameters	
Display screen	7.0" TFT 1920*RGB*1200 (resolution),16.7M(color), Backlight brightness adjustable
Operation method	Power button, Master control keyboard with 13 keys, Full lamination technology capacitive Multi-touch screen (input)
Operation settings	Chinese / English interface, user optional
Automatic standby	Disabled / 5-60 minutes
Keyboard tone	Enabled / Disabled
Working environment and specifications	
Working temperature	-10℃~+55℃
Working humidity	30%-90%
Outline dimension	236.5x133.4x45.4mm

ABOUT TRIPLETT

Triplett Test Equipment and Tools has been designing specialized test equipment for over 100 years.

Triplett was acquired by Jewell Instruments in 2007. Jewell Instruments is a world leader in the manufacturing and distribution of advanced sensors, controls, panel meters, and avionics. Jewell provides custom solutions for the aerospace, medical, industrial, marine, telecommunications, and railroad industries.

Jewell's experienced engineering team works with customers and end-users to develop top-of-the-line products that meet or exceed all customer requirements.

The company has two manufacturing facilities—one in Manchester, New Hampshire, and the other in Barbados, West Indies. Both facilities maintain the most stringent manufacturing requirements. The Barbados facility also provides the cost-competitive advantage of offshore manufacturing

Jewell is committed to continuing the legacy started by Ray L. Triplett, producing only the high-est quality, most technologically advanced, rugged, and reliable test equipment products in the marketplace.



*Jewell Instruments Headquarters
Manchester, NH*

LIMITED WARRANTY

The manufacturer warrants to the original consumer that this product is in good working order for a period of one year from the date of manufacture or the date of purchase. During this period, the product will be repaired or replaced without charge for either parts or labor. Repair or replacement as provided under this warranty is the exclusive remedy of the purchaser.