



MODEL 9065

True RMS Data Logging MultiMeter



Instruction Manual



**84-910
10/15**

Contents

I. Introduction-----	1	12. Temperature-----	27
II. Included Items-----	1	13. LPF-----	28
III. Rules for Safe Operation-----	2	14. dBV-----	29
IV. Electrical Symbols-----	3	15. dBm-----	29
V. Meter Structure-----	4	16. Maximum Value and Minimum Value-----	29
VI. LCD Display-----	5	17. Relative Value Mode-----	30
VII. Keys, Rotary Switch and Input Terminals-----	6	18. Peak Detection Mode-----	30
VIII. Technical Index-----	8	19. Compare Mode-----	30
1. General Specifications-----	8	20. Recording Measurement Data-----	31
2. Electrical Specifications-----	9	21. Communication-----	33
IX. Measurement Operation-----	17	X. Maintenance and Repair-----	34
1. Meter Power Control-----	17	1. General Maintenance and Repair-----	34
2. Meter Settings-----	18	2. Testing Fuses-----	34
3. AC Voltage-----	20	3. Replacing Fuses-----	35
4. DC Voltage-----	20	4. Battery Charge-----	35
5. AC and DC Current-----	21	X. Warranty-----	36
6. Resistance-----	22	X. Notes-----	37
7. Conductance-----	24		
8. Capacitance-----	24		
9. Continuity-----	25		
10. Diode Test-----	25		
11. Frequency/Duty Cycle Measurement/Pulse Width-----	27		

I. Introduction

The Model 9065 is a 60000 count, or 4 5/6 digit, handheld auto-ranging true RMS Digital Multimeter (hereinafter referred to as “the meter”). The meter can be used to accurately measure AC and DC voltage, AC and DC current, resistance, conductance, capacitance, temperature, frequency and pulse width. It can also perform diode testing, continuity testing, and it provides useful test functions such as data hold, maximum/minimum/average measurements, comparison measurement, relative measurement, peak detection, trend capture and data record/readback of as many as 20,000 measurements.

This Operating Manual provides information on safe and recommended uses of this product. Please read the relevant information carefully and observe all the Warnings and Notes.



Warning:
Please read the “Rules for Safe Operation” before using the meter.

II. Included Items

Open the package and the carrying case and inspect the contents. Please check that all of the following items are included:

1. One operating manual
2. A pair of test leads
3. Two K type temperature probes
4. One temperature connector
5. One charging adapter
6. One charging connector
7. One USB cable
8. One CD
9. One cloth bag

If you discover any missing or damaged pieces, please contact Triplett at 1-800 Triplett or support@triplett.com.

III. Rules for Safe Operation

Please note the  Warning symbol. Warnings indicate the conditions and actions which pose hazards to users or may damage the meter or equipment under test.

This Meter is designed to comply with several safety standards, This meter conforms to UL STD. 61010-1, 61010-2-030, 61010-2-032, 61010-2-033, Certified to CSA SID. C22.2 NO. 61010-1, 61010-2-030, IEC STD 61010-2-032, 61010-2-033 in pollution degree 2, measurement category (CAT III 1000V, CAT IV 600V), double insulation as well as with IP65 standards for water resistance and dustproofing. Use of the meter without following the operating instructions can reduce or circumvent the protection provided by the meter.

Measurement Category III (CAT III) is intended for measurements performed in building installation. Examples may include measurements on distribution boards, circuit-breakers, wiring, including cables, bus-bars, junction boxes, switches, socket-outlets in fixed installations, and equipment for industrial use and some other equipment, for example, stationary motors with permanent connection to the fixed installation.

Measurement Category IV (CAT IV) is intended for measurements performed at the source of the low-voltage installation. Examples include electricity meters and measurements on primary overcurrent protection devices and ripple control units.

1. Never use a damaged meter. Before using the meter, check the meter case for visible cracks or any missing plastic parts. Pay special attention to the insulation areas around the connectors.
2. Before using the meter, ensure the battery cover is closed and secured. Before opening the battery cover, remove the test leads from the meter.
3. Inspect the test leads for damaged insulation or exposed metal. Check the test leads for continuity. If any test lead is damaged, replace it before using the meter.
4. Do not apply more than the rated voltage, as marked on the meter, between the terminals or between any terminal and ground.
5. Do not have the meter turned on when removing the cover or opening the case.
6. When working with a voltage >30V AC (RMS), >42VAC (peak), or over 60V DC, special care should be taken to avoid electric shock.
7. Replacement fuses must comply with the specifications in this Operating Manual.
8. Use the proper terminals, function and range for your measurement.
9. When measuring current, shut off the power to the circuit, then connect the meter to the circuit. Remember: the meter and the circuit must be connected in series.
10. When making electrical connections, connect the common test lead before connecting the main test lead; when disconnecting, disconnect the main test lead before disconnecting the common test lead.













11. If the meter works improperly, do not use it. The protection measures of the meter may have failed. If in doubt, contact your distributor or Triplet Customer Service.
12. Do not store or use the meter in an environment with high temperature, humidity, strong magnetic fields, or with inflammable or explosive materials.
13. When using the probes, keep your fingers behind the finger guards.
14. Do not use the low-pass filter to verify hazardous voltage, as there may be an AC voltage over the indicated value. First, measure the voltage without a filter to check whether it is hazardous, then select low-pass filtering.
15. Before testing resistance, continuity, conductance, diode or capacitance, shut off the power to the circuit and discharge all high-voltage capacitors.
17. Do not measure a voltage or current higher than the allowed input values. When the range of measured values cannot be determined, set the functional range switch at the maximum-range position.
18. When the symbol " " shows on the LCD display, the battery should be promptly charged to ensure measurement accuracy.
19. Do not change the wiring within the meter to avoid injury and damaging the meter.
20. A soft cloth and mild detergent should be used to clean the surface of the meter when servicing. No abrasive cleaners or solvents should be used on the product.
21. Test a known voltage before use to confirm the meter is functioning correctly.

22. If you want to replace the test lead, you need to replace it with a test lead of the same or higher grade of CAT III 1000V/CAT IV 600V.

Dangerous Voltage

When the meter detects voltage $\geq 30V$ or overload (OL), the symbol  will display as a warning for potential hazardous voltage.

IV. Electrical Symbols

	Double Insulated
	Grounding
	Warning
	AC (Alternating Current)
	DC (Direct Current)
	Continuity Buzzer
	Diode
	Capacitance
	AC or DC (Alternating Current or Direct Current)
	Danger High Voltage
	Conforms to Standards of European Union.
	This symbol signifies the product complies with both USA and Canadian electrical requirements.

V. Meter Structure (see Figure 1)

1	Case
2	LCD
3	Function Keys
4	Rotary Switch
5	Input Terminals

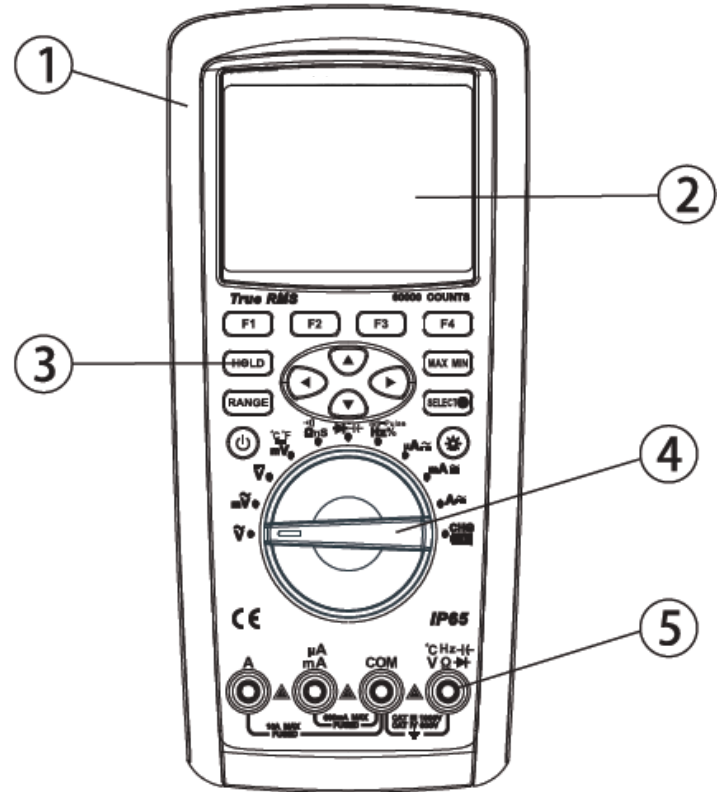

Figure 1

V. LCD Display (see Figure 2)

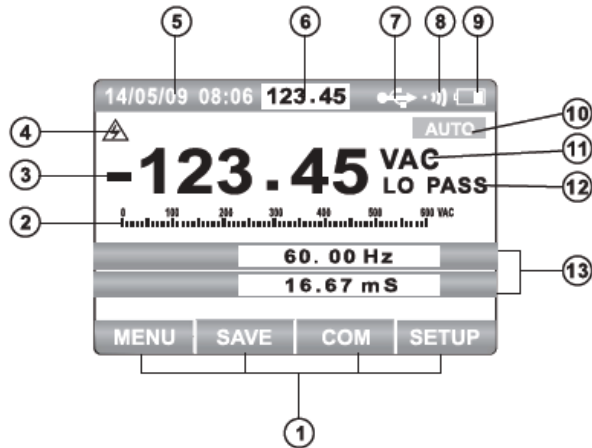

Figure 2



No.	Function	Description
1	Label of Function Keys	Indicates auxiliary functions under current measuring interface
2	Simulation Bar	Analog display of input signals
3	Minus Sign	Indicates negative reading
4	Lightning Symbol	Danger- High Voltage
5	Time and Date	Indicates the time and date set in internal clock
6	Small Measurements	Real-time input values are displayed when the primary and secondary displays are covered by menus or pop-up messages.
7	Communications	Indicates the USB communication is enabled.
8	Sound Setting	Indicates the button sound is enabled (beeps when a button is pressed)
9	Battery Level	Indicates the charge level of rechargeable battery
10	Range Indicator	Indicates the current range and range mode for the meter (auto or manual)
11	Unit	Indicates the measurement unit
12	Assisted Function Mode	Indicates the active assisted measuring function, such as Low Pass Filter
13	Assisted Function Display	Shows additional measuring information from the assisted function mode that is active.

VII. Keys, Rotary Switch and Input Terminals







(1) Keys

The 14 keys on the meter are used to activate the alternate functions of the rotary switch, browse menus or control the meter power.

The keys shown in **Figure 3** are described in the following table.

Key	Function
	Turn on or turn off the power to the meter
F1 F2 F3 F4	Select the sub-functions and modes indicated by the labels on the LCD screen.
	Cursor keys are used to select menu items, scroll through text and input data
HOLD	Keep the current reading held on the display
RANGE	Switch the range mode of the meter to Manual mode, then switch between all the available ranges. Long press the button to return to Automatic range mode.
MAX MIN	Starts to record Minimum & Maximum values.
SELECT	Press to select the alternate function. Long press to enter Help Menu.
	Press the key to switch the backlight brightness. Long press it to turn off backlight.

(2) Rotary Switch (see Figure 4)

Knob	Function
	Measurement of AC Voltage
	Measurement of mV in AC and mV in AC+DC
	Measurement of voltage in DC and AC+DC
	Measurement of mV in AC and temperature
	Measurement of resistance, continuity and specific conductance
	Diode test and capacitance measurement

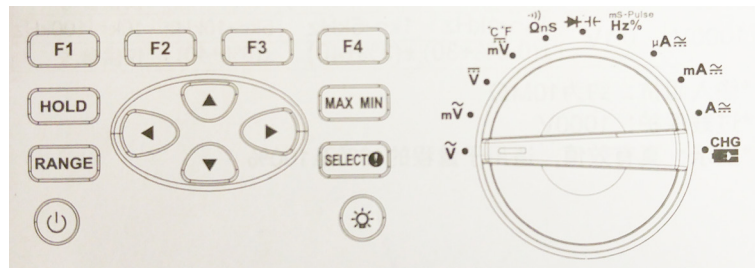

Figure 3 & 4

Knob	Function
Hz% mS-Pulse	Measurement of frequency, duty cycle and pulse width
μA \approx	Measurement of A in AC, DC and AC+DC
mA \approx	Measurement of mA in AC, DC and AC+DC
A \approx	Measurement of ampere in AC, DC and AC+DC
CHG	Battery is charging

(3) Input Terminals

Terminal	Description
A	Measurement of frequency, duty cycle and pulse width
mA μA	Measurement of A in AC, DC and AC+DC
COM	Measurement of mA in AC, DC and AC+DC
V Ω \rightarrow $^{\circ}\text{C}$ \leftarrow Hz	Measurement of ampere in AC, DC and AC+DC

In addition to the above, all four terminals are used for charging and temperature measurement through corresponding adapters. "Lead Error!" will show on the display to warn if the probes are inserted improperly.

VIII. Technical Index

1. General Specifications

The maximum voltage between any terminal and ground: 1000 V

The fuse protection of mA or μ A input terminals: 0.8A H 1000V Fuse Type 6X32mm

The fuse protection of the A input terminal: 10A H1V Fuse Type 10X38mm

Max. display: 60000

Range: Auto/Manual

Polarity: Auto

Operating temperature: $-20^{\circ}\text{C}\sim 50^{\circ}\text{C}$ Storage temperature: $-30^{\circ}\text{C}\sim 60^{\circ}\text{C}$

Relative humidity: $\leq 80\%$ ($0^{\circ}\text{C}\sim 30^{\circ}\text{C}$), $\leq 75\%$ ($30^{\circ}\text{C}\sim 40^{\circ}\text{C}$), $\leq 45\%$ ($40^{\circ}\text{C}\sim 50^{\circ}\text{C}$)

Electromagnetic compatibility: In an RF E-field of 1V/m: Overall accuracy= specified accuracy+ 5% of range. No specified accuracy guarantee for RF E-field strength $> 1\text{V/m}$.

Operating altitude: 0~2000m

Temperature coefficient: 0.1X (specified accuracy)/ $^{\circ}\text{C}$ ($< 18^{\circ}\text{C}$ or $> 28^{\circ}\text{C}$) Internal battery: Lithium battery of 7.4V 2200mAh

Power adapter: Input of 100V~240V,50/60Hz 0.2A max, Output of DC10V 500mA(short-circuit protection for output). External diameter of 5.5 mm and internal diameter of 2.5mm.

Low battery: The symbol "" shows on the LCD.

Dimension: About (225 X100 X 60) mm

Weight: About 608g (including battery)

Safety standards: IEC/EN61010-1, EN61010-2-030, EN 61010-2-033 in pollution degree 2, CAT III 1000V,CAT IV 600V IP65 standards for waterproof and dustproof rating

2. Electrical Specifications

Accuracy: $\pm(\% \text{ Reading} + \text{Digits})$, one-year calibration period.

Ambient temperature: $23^{\circ}\text{C} \pm 5^{\circ}\text{C}$;

Ambient humidity: 75%RH;

Temperature coefficient: $0.1 \times (\text{Accuracy}) / ^{\circ}\text{C}$ ($<18^{\circ}\text{C}$ or $>28^{\circ}\text{C}$)

2. Electrical Specifications

Range	Resolution	Accuracy Tolerance: $\pm (\% \text{ Reading} + \text{Digits})$			
60mV	0.001mV	45~1kHz	1k~10kHz	10k~20kHz	20k~100kHz
		$\pm(0.6\%+60)$	$\pm(1.2\%+60)$	$\pm(3\%+60)$	$\pm(4\%+60)$
600mV	0.01V	45~1kHz	1k~10kHz	10k~20kHz	20k~100kHz
		$\pm(0.3\%+30)$	$\pm(1.2\%+40)$	$\pm(3\%+40)$	$\pm(4\%+40)$
6V	0.0001V	45~1kHz	1k~10kHz	10k~20kHz	20k~100kHz
		$\pm(0.3\%+30)$	$\pm(1.2\%+40)$	$\pm(3\%+40)$	$\pm(4\%+40)$
60V	0.001V	45~1kHz	1k~10kHz	10k~20kHz	20k~100kHz
		$\pm(0.3\%+30)$	$\pm(1.2\%+40)$	$\pm(3\%+40)$	$\pm(4\%+40)$
600V	0.01V	45~1kHz	1k~10kHz	10k~20kHz	20k~100kHz
		$\pm(0.3\%+30)$	$\pm(1.2\%+40)$	$\pm(3\%+40)$	Only for reference
1000V	0.1V	45~1kHz	1k~5kHz	5k~10kHz	10k~100kHz
		$\pm(0.6\%+30)$	$\pm(3\%+40)$	$\pm(6\%+40)$	Only for reference

- Input impedance: About 10M Ω
- Overload protection: 1000V
- Display: True RMS value for 10% to 100% of the range.

(2) DC Voltage

Range	Resolution	Accuracy Tolerance: \pm (% Reading + Digits)
60mV	0.001mV	\pm (0.025%+20)
600mV	0.01mV	\pm (0.025%+5)
6V	0.0001V	
60V	0.001V	
600V	0.01V	\pm (0.03%+5)
1000V	0.1V	

- Input impedance: About 10M Ω
- Overload protection: 1000V
- Display: True RMS value for 10% to 100% of the range.

(3) AC Voltage + DC Voltage

Range	Resolution	Accuracy Tolerance: \pm (% Reading + Digits)		
60mV	0.001mV	50~1kHz	1k~10kHz	10k~35kHz
		+(1%+80)	+(3%+40)	+(6%+40)
600mV	0.01V	50~1kHz	1k~10kHz	10k~35kHz
		+(1%+80)	+(3%+40)	+(6%+40)
6V	0.0001V	50~1kHz	1k~10kHz	10k~35kHz
		+(1%+80)	+(3%+40)	+(6%+40)
60V	0.001V	50~1kHz	1k~10kHz	10k~35kHz
		+(1%+80)	+(3%+40)	+(6%+40)
600V	0.01V	50~1kHz	1k~10kHz	10k~35kHz
		+(1%+80)	Only for reference	Only for reference
1000V	0.1V	50~1kHz	1k~10kHz	10k~35kHz
		+(1.2%+80)	Only for reference	Only for reference

- Input impedance: About 10MΩ
- Overload protection: 1000V
- Display: True RMS value for 10% to 100% of the range.

(4) AC Current

Range	Resolution	Accuracy Tolerance: ± (% Reading + Digits)	
600μA	0.01μA	45~1kHz	1k~10kHz
		+(0.6%+40)	+(1.2%+40)
6000μA	0.1μA	45~1kHz	1k~10kHz
		+(0.6%+20)	+(1.2%+40)
60mA	0.001mA	45~1kHz	1k~10kHz
		+(0.6%+40)	+(1.2%+40)
600mA	0.01mA	45~1kHz	1k~10kHz
		+(0.6%+20)	+(1.2%+40)
10A	0.001A	45~1kHz	1k~10kHz
		+(1%+20)	+(3%+40)

- Display: True RMS value for 10% to 100% of the range.
- Overload protection: μA mA range: 0.8A H 1000V Fuse Type φ 6x32 mm
10 A range: 10A H 1000V Fuse Type φ 10x38mm
- Switch on for 30 seconds and suspend measurement for 10 minutes for 20A. Not specified for over 10A.

(5) DC Current

Range	Resolution	Accuracy Tolerance: \pm (% Reading + Digits)
600 μ A	0.01 μ A	+ (0.08%+20)
6000 μ A	0.1 μ A	+ (0.08%+10)
60mA	0.001 mA	+ (0.08%+20)
600mA	0.01 mA	+ (0.15%+10)
10A	0.001A	+ (0.5%+10)

- Overload protection: μ mA range: 0.8A H 1000V Fuse Type ϕ 6x32 mm
10 A range: 10A H 1000V Fuse Type ϕ 10x38mm
- Switch on for 30 seconds and suspend measurement for 10 minutes for 20A. Not specified for over 10A.

(6) AC Current + DC Current

Range	Resolution	Accuracy Tolerance: \pm (% Reading + Digits)	
600 μ A	0.01 μ A	50~1kHz	1k~10kHz
		+ (0.8%+40)	+ (2.0%+40)
6000 μ A	0.1 μ A	50~1kHz	1k~10kHz
		+ (0.8%+20)	+ (2.0%+40)
60mA	0.001mA	50~1kHz	1k~10kHz
		+ (0.8%+40)	+ (2.0%+40)
600mA	0.01mA	50~1kHz	1k~10kHz
		+ (0.8%+20)	+ (2.0%+40)
10A	0.001A	50~1kHz	1k~10kHz
		+ (1.2%+20)	+ (3%+40)

- Display: True RMS value for 10% to 100% of the range.
- Overload protection: μmA range: 0.8A H 1000V Fuse Type ϕ 6x32 mm
10 A range: 10A H 1000V Fuse Type ϕ 10x38mm
- Switch on for 30 seconds and suspend measurement for 10 minutes for 20A. Not specified for over 10A.

(7) Resistance

Range	Resolution	Accuracy Tolerance: \pm (% Reading + Digits)
600 Ω	0.01 Ω	In REL state: $\pm(0.05\%+10)$
6k Ω	0.0001k Ω	$+(0.05\%+2)$
60k Ω	0.001k Ω	
600k Ω	0.0k Ω	
6M Ω	0.0001M Ω	$+(0.3\%+10)$

- Overload protection: 1000V
- Humidity for 60 M Ω : <50%

(8) Conductance

Range	Resolution	Accuracy Tolerance: \pm (% Reading + Digits)
60ns	0.01nS	$+(2\%+10)$

- Overload protection: 1000V
- Humidity: <50%

(9) Capacitance

Range	Resolution	Accuracy Tolerance: \pm (% Reading + Digits)
6nF	0.001nF	+(3%+10)
60nF	0.01nF	+(2.5%+5)
600nF	0.1nF	+(2%+5)
6 μ F	0.001 μ F	
60 μ F	0.01 μ F	
600 μ F	0.1 μ F	
6mF	1 μ F	+(5%+5)
60mF	10 μ F	Not specified

- Overload protection: 1000V
- Display digits: 6000

(10) Temperature

Range	Resolution	Accuracy
-40°C~40°C	0.1°C	+(2.0%+30)
40°C~400°C		+(1.0%+30)
400°C ~1000°C		+2.5%
-40°F~104°F	0.2°F	\pm (2.5%+50)
104°F~752°F		+(1.5%+50)
752°F~1832°F		+2.5%

Overload protection: 1000V

- Two-channel temperature measurement can be performed via temperature connectors.
- Temperature sensor: Applicable to K type(chromel-silicel) thermocouple. Spare parts are point contact Ktype (chromel-silicel) thermocouple (only applicable to the measurement when temperature is below 230 °C)

(11) Frequency

Range	Resolution	Accuracy
60Hz	0.001 Hz	$+(0.02\%+8)$
600Hz	0.01 Hz	$+(0.01\%+5)$
6kHz	0.0001kHz	
60kHz	0.001kHz	
600kHz	0.01kHz	
6MHz	0.0001MHz	
60MHz	0.001MHz	

- Overload protection: 1000V
- Display digits: 6000

(12) Duty Cycle

Range	Resolution	Accuracy Tolerance: \pm (% Reading + Digits)
10%~90%(10Hz~2kHz)	0.01%	$+(1.2\%+30)$

- Overload protection: 1000V
- Humidity: <50%

(13) Pulse Width

Range	Resolution	Accuracy Tolerance: \pm (% Reading + Digits)
250mS	0.001mS~0.01mS	$+(1.2\%+30)$

- Overload protection: 1000V
- When the rise time is less than 1 μ s, the signals center on trigger level.
- The pulse width is greater than 2 μ s for 10Hz to 200kHz. The pulse width depends on signal frequency.

(14) Continuity Test

Range	Resolution	Remark
	0.01Ω	<p>Open circuit voltage is around 3V.</p> <p>When the buzzer is set for Short Circuit warning; If the impedance tested is less than 10Ω, the buzzer continuously sounds. If the impedance tested is greater than 50Ω, the buzzer does not sound.</p> <p>When the buzzer is set for Open Circuit warning; If the impedance tested is greater than 50Ω, the buzzer continuously sounds. If the impedance tested is less than 10Ω, the buzzer does not sound.</p>

- Overload protection: 1000V

(15) Diode Test



Range	Resolution	Remark
	0.0001V	<p>Open circuit voltage is around 3V. The forward voltage drop value of the measured PN junction is approximately $\leq 3V$.</p> <p>When the buzzer is selected in Diode Test Mode; it will beep briefly for the normal semiconductor junction. If the semiconductor junction shorts out (impedance $< 10\Omega$), the alarm will continuously sound. Typical silicon PN junction voltage drops vary between 0.5~0.8V.</p>

- Overload protection: 1000V

IX. Measurement Operation



1. Meter Power Control

1) To manually power up and power down the meter:

When the meter is off, long press  to start the meter. When the meter is on, long press  to shut it off. The meter cannot be powered off when charging.



2) Indicators for Battery Level:

The meter is powered by a rechargeable lithium battery. The indicators for battery level are in the upper right corner of the display. Some examples for battery capacity are shown in the following table.

Meaning	Battery Capacity
	Full capacity
	Half capacity
	Empty

When the battery capacity is lower than 3% of full capacity, the meter will automatically shut down.

3) Backlight Control

If the display is not visible in low-light situations, press the backlight  button to switch the backlight brightness. Long press the  button to turn off the backlight and enter power saving mode. When the backlight is off, the green light flashes to indicate that the meter is still collecting data. Press any key or turn the rotary switch to turn on the backlight again.

4) Auto Power-off

When the Auto Power Off is set, the meter will turn off if no button is pressed or the dial selector is not turned within the time set. To disable Auto Power Off, set the Power Off mode to “OFF” under the SETUP – Auto Power Save Menu.

5) Power Saving Mode

Set the control time for dimming the brightness and turning off the display, found in the SETUP – Auto Power Save Menu

2. Meter Settings

Press the function key labelled, SETUP to access the general settings for the meter. Press the cursor keys  to navigate through the settings menu.



1) Keypad Tone

This function enables or disables sound when a button is pressed. The beeper symbol  in the upper right corner indicates that sound is enabled.

2) Lead Alarm Buzzer

This function enables or disables the alarm sound for improper probe lead connection.

3) Communication

Set as ON to enable USB communication. A  symbol will appear in the upper right corner when active. When Communication Mode is OFF, the  symbol will disappear.

4) Date & Time

With “Date & Time” highlighted in the SETUP Menu, press the function key labelled, “SET” to set the date and time. Press **(LEFT)** or **(RIGHT)** to select the field to edit, and press **(UP)** or **(DOWN)** to enter different numbers, then press the function key “OK” to confirm. To cancel the settings, press the function key labelled, “CANCEL”.

5) Auto Power Save Options

With “Auto Power Save” highlighted in the SETUP Menu, press the function key labelled, “SET” to edit the time of inactivity to dim the brightness, turn off the display, and power down the meter. Press **(UP)** or **(DOWN)** to move the cursors to select different items. Press **(LEFT)** or **(RIGHT)** to enter the time, in minutes, to activate the power saving feature.

Menu Item	Description	Set Value
Brightness Down	Dim the display brightness after the elapsed time of inactivity.	ON: 1-60 Min OFF: This function is disabled
Display Off	Turn off the display after the elapsed time.	ON: 1-60 Min OFF: This function is disabled
Power Off	Turn off the power after the elapsed time.	ON: 1-60 Min OFF: This function is disabled

Press the function key “OK” to confirm the above settings. To cancel the settings, press the function key “CANCEL”.

6) More Settings

With “More Settings” highlighted in the SETUP Menu, press the function key “ENTER” to: Set the language of the Help Menu, Format Memory, Reset the meter settings, or check the model number, serial number and available memory space.

Press the cursor keys   to select between the following menu items.

- Help Menu Language

Press the function key labelled, “SET” to set the Help Menu language. Press **(UP)** or **(DOWN)** to select a different language. Then press the function key “OK” to confirm. To cancel the settings, press the function key “CANCEL”.

- Memory Format

With “Memory Format” highlighted, press the function key labelled, “FORMAT” to enter the memory format menu, then press the function key labelled “YES” to confirm. To cancel the format, press the function key labelled, “NO”.

- Reset All Setting

With “Reset All Setting highlighted, Press the function key “RESET” to reset the meter to default settings, then press the function key “YES” to confirm. To cancel the reset, press the function key “NO”.

- About

Press the function key “ABOUT” to check product model, serial number and available memory space.

3. AC Voltage

- 1) Insert the red test lead into the V terminal and the black test lead into the COM terminal.
- 2) Set the rotary switch to V or mV as shown in Figure 5. Connect the test leads to the power or load under test in parallel.
- 3) Directly read the measured voltage values on the display. True virtual values are displayed for AC measurement.
- 4) Press the function key labelled, "MENU" to access additional features for measuring AC voltage. Press the cursor keys  to select menu items. The red highlighting indicates the selected item. Press F1 to enter the corresponding measuring mode, press F2 to enter Relative value mode when available, and press F3 to set dBm impedance (AC V only), and press F4 to close the measurement features menu.

Attention:

After completing all the measuring operations, disconnect the test leads and the circuit under test. Do not input a voltage higher than 1000V. Higher voltage may be measured but it may damage the meter.

- When measuring high voltage, special care should be taken to avoid electric shock.
- After completing all the measuring operations, disconnect the connection between the test leads and the circuit under test.
- The meter's True RMS response is calibrated to an AC sinusoidal input signal. Measuring non-sinusoidal AC signals

will have decreased accuracy.

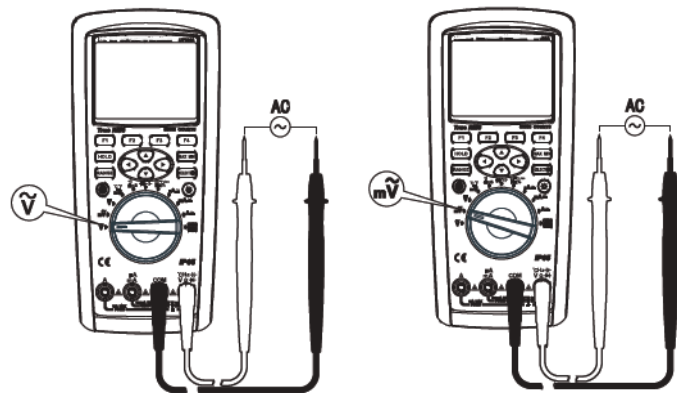

Figure 5

4. DC Voltage

- 1) Insert the red test lead into the V terminal and the black test lead into the COM terminal.
- 2) Set the rotary switch to DC V or DC mV as shown in Figure 6. Connect the test leads to the power or load under test in parallel.
- 3) Directly read the measured voltage values on the display.
- 4) Press the function key labelled, "MENU" to access additional features for measuring DC voltage. Press the cursor keys to select menu items. The red highlighting indicates the selected item. Press F1 to enter the corresponding measuring mode, press F2 to enter Relative value mode when available, and press F4 to close the measurement features menu.

⚠ Attention:

- Do not input a voltage higher than 1000V. Higher voltage may be measured but it may damage the meter.
- When measuring high voltage, special care should be taken to avoid electric shock.
- After completing all the measuring operations, disconnect the connection between the test leads and the circuit under test.

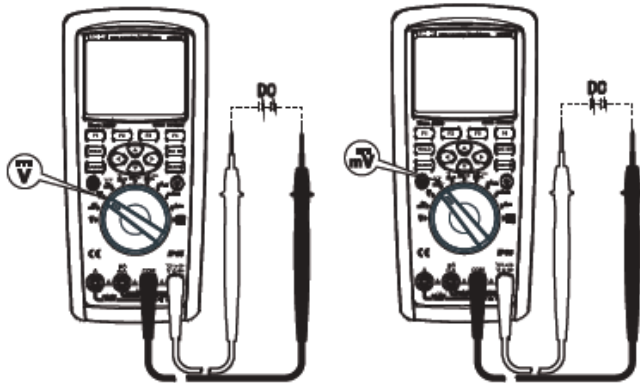

Figure 6

5. AC and DC Current

- 1) Insert the red test lead into the μmA or A terminal and the black test lead into the COM terminal.
- 2) Set the rotary switch to the position as shown in Figure 7. Press the key “SELECT” to measure either AC or DC. Connect the test leads to the test circuit in series.
- 3) Directly read the measured current values on the display.

- 4) Press the function key labelled, “MENU” to access additional features for measuring AC or DC current. Press the cursor keys $\leftarrow \rightarrow$ to select menu items. The red highlighting indicates the selected item. Press F1 to enter the corresponding measuring mode, press F2 to enter Relative value mode when available, and press F4 to close the measurement features menu.

⚠ Warning:

- Before connecting to the test circuit, turn off the power to the circuit first and discharge all the high-voltage capacitors.
- Use proper input terminals and functions for measurement. If the current amperage cannot be estimated, first measure using the largest range.
- When the test lead is inserted in a current terminal, do not connect its test probe to any circuit in parallel, it could blow the fuses within the meter and damage the meter.
- After completing all the measuring operations, disconnect the connection between the test leads and the circuit under test.

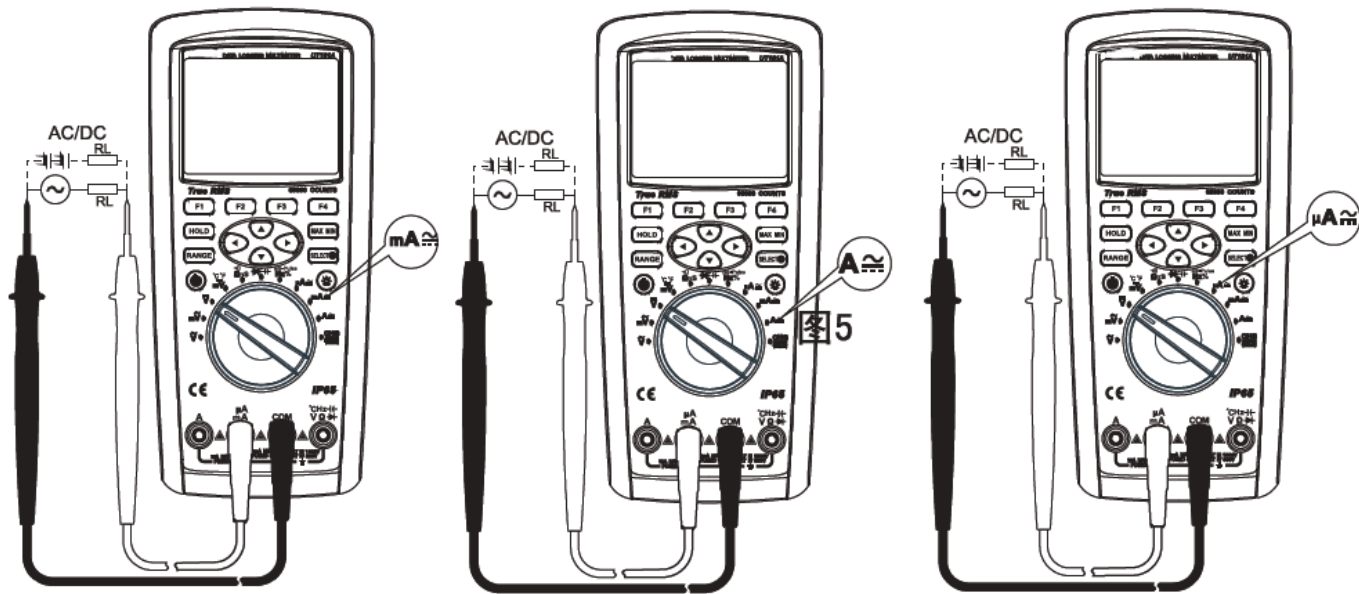



Figure 7

6. Resistance

- 1) Insert the red test lead into the Ω terminal and the black test lead into the COM terminal.
- 2) Set the rotary switch to the Ω nS  position. The meter will default to resistance measurement. Connect the test leads to both ends of the measured resistance as shown in Figure 8.
- 3) Directly read the measured resistance values on the display.

Attention:

- If measuring an open circuit or resistance value exceeds the maximum range of the meter, “OL” will show on the display.
- When measuring the in-circuit resistance, all the power within the measured circuit must be shut off before measurement and all the capacitors must be discharged to ensure a correct measurement, and to avoid damaging the meter.
- When measuring low resistance, the test leads may add additional resistance between 0.10 Ω to 0.20 Ω . To obtain accurate readings, Relative measurement can be used. First short the input test leads, then press the function key labelled, “MENU” and press F2 to enter Relative measurement mode. Perform the low resistance measurement and the meter will automatically subtract the resistance of the shorted test leads.
- If the resistance value is greater than 0.50 Ω with shorted test leads, the test leads should be checked for loose connections or other factors.

- When measuring a resistance $>1\text{M}\Omega$, the readings require a few seconds to stabilize. This is normal for high resistance measurements. In order to obtain stable readings, short test lines can be used for the measurement.
- Do not input a voltage in resistance measurement mode to avoid possible product damage or personal injury.
- After completing all the measuring operations, disconnect the connection between the test leads and the circuit under test

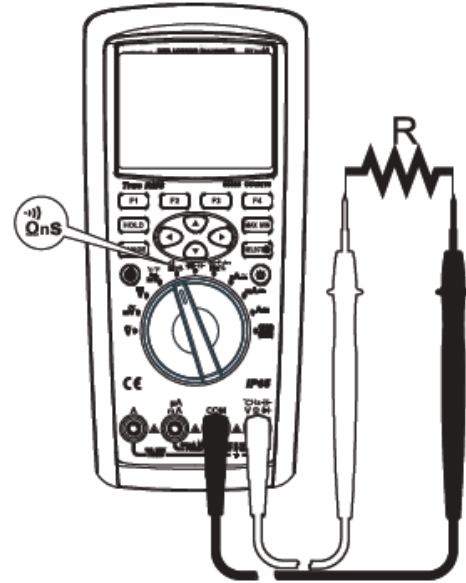



Figure 8



7. Conductance

- 1) Insert the red test lead into the Ω terminal and the black test lead into the COM terminal.
- 2) Set the rotary switch to the measurement Ω nS . Press the SELECT key twice to select Conductance measurement. Connect the test leads to both ends of the measured resistance as shown in Figure 8.
- 3) Directly read the measured conductance value on the display.

Attention:

- When measuring the in-circuit resistance, all the power within the measured circuit must be shut off before measurement and all the capacitors must be discharged to ensure a correct measurement, and to avoid damaging the meter.
- Do not input a voltage when in conductance measurement mode to avoid possible product damage or personal injury.
- After completing all the measuring operations, disconnect the connection between the test leads and the circuit under test.

8. Capacitance

- 1) Insert the red test lead into the  terminal and the black test lead into the COM terminal.
- 2) Set the rotary switch to the measurement  press the SELECT key to select Capacitance measurement. Connect the test leads to both ends of the measured capacitance as shown in Figure 9.

- 3) Directly read the measured capacitance value on the display.

Attention:

- If the measured capacitance shorts or capacitance value exceeds the maximum range of the meter, “OL” will show on the display.
- For the measurement of small capacitance within range, relative measurement REL should be used to avoid the influence of test lead capacitance for correct readings.
- For capacitance measurements > 600 μF , the readings require a few seconds to be stable.
- To ensure the measuring accuracy, the capacitor should be discharged completely then put onto the meter to measure, especially for a capacitor with high voltage to avoid damage to the meter and personal injury.
- Do not input a voltage when in capacitance measurement mode to avoid possible product damage or personal injury.
- After completing all the measuring operations, disconnect the connection between the test leads and the capacitor under test.

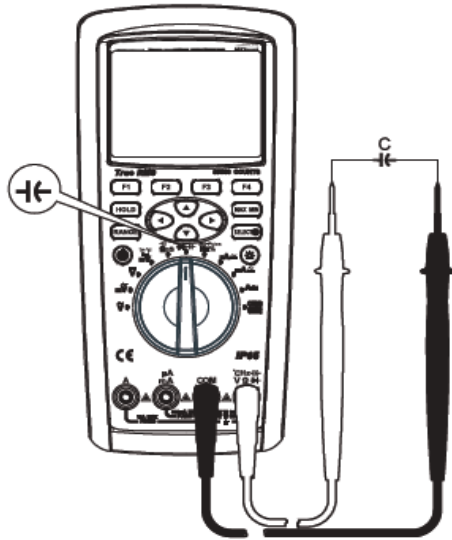



Figure 9

9. Continuity Test

- 1) Insert the red test lead into the Ω terminal and the black test lead into the COM terminal.
- 2) Set the rotary switch to the measurement Ω nS , press the SELECT key to select the Continuity test . Connect the test leads to both ends of the measured resistance as shown in Figure 8. Press the function key labelled, "MENU" to select measurement options. Pressing the function key labelled, "SHORT" will put the meter in Short Circuit Alarm mode. Pressing the function key labelled, "OPEN" will put the meter in Open Circuit Alarm mode.

When the buzzer is set for Short Circuit warning; If the impedance tested is less than 10Ω , the buzzer continuously sounds. If the impedance tested is greater than 50Ω , the buzzer does not sound.

When the buzzer is set for Open Circuit warning; If the impedance tested is greater than 50Ω , the buzzer continuously sounds. If the impedance tested is less than 10Ω , the buzzer does not sound.

- 3) Directly read the measured resistance value on the display.

Warning

- When measuring the in-circuit resistance, all the power within the measured circuit must be shut off before measurement and all the capacitors must be discharged to ensure a correct measurement.
- Do not input a voltage when in continuity test mode to avoid possible product damage or personal injury.
- After completing all the measurements, disconnect the connection between the test leads and the circuit under test.

10. Diode

- 1) Insert the red test lead into the  terminal and the black test lead into the COM terminal. The polarity of red test lead is "+" and "-" for black test lead.

2) Set the rotary switch to the  position. The meter will default to Diode measurement. Connect the test leads to both ends of the diode as shown in Figure 10. Directly read the approximate forward PN junction voltage of the measured diode on the display.

3) Press the function key labelled, “MENU” to choose measurement options. Pressing the function key labelled, “ALARM” will enable the beeper. It will beep briefly when connected to a normal semiconductor junction; If the measurement shorts out, it will beep continuously. Typical Silicon PN junction drops vary between 0.5V ~ 0.8V. Pressing the function key labelled, “NORMAL” will run the diode test without the beeper function.

⚠ Attention:

- If the measurement is an open circuit, or the diode polarity is reversed, “OL” will be displayed.
- When measuring an in-circuit diode, all the power within the measured circuit must be shut off before measurement and all the capacitors must be discharged.
- Open-circuit voltage of diode test is around 3V.
- Do not input a voltage when in diode test mode to avoid possible product damage or personal injury.
- After completing all measurements, disconnect the connection between the test leads and the circuit under test.

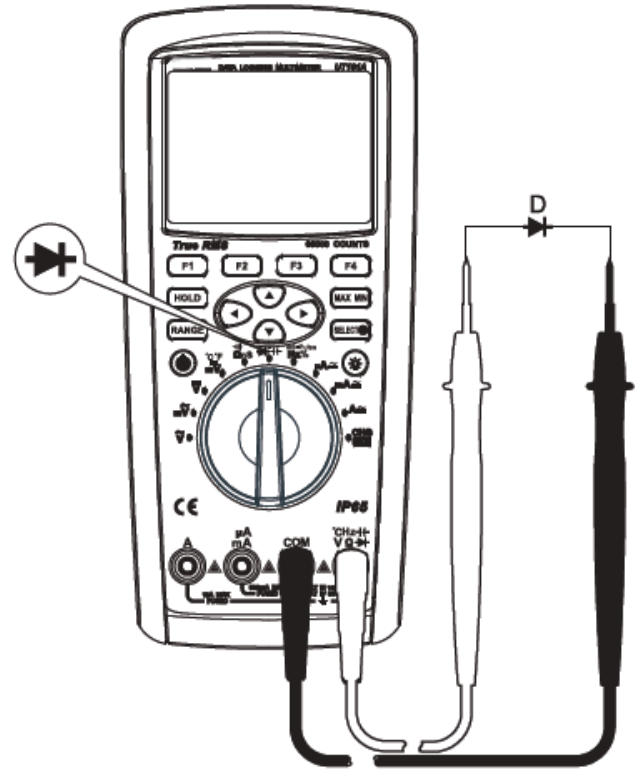

Figure 10

11. Frequency/Duty Cycle Measurement /Pulse Width

- 1) Insert the red test lead into the V terminal and the black test lead into the COM terminal.
- 2) Set the rotary switch to the measurement Hz% ms-Pulse position. Press the SELECT key to select Hz, Duty Cycle (%), or ms-Pulse. Connect the test leads to the signal source under test in parallel as shown in Figure 11.
- 3) Directly read the measured values of frequency, duty cycle or pulse width on the display.

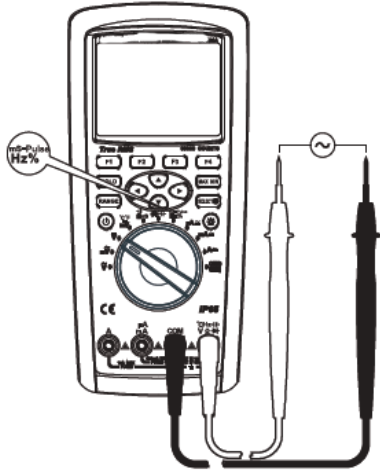



Figure 11

⚠ Attention:

- Simulation bar displays the frequency of the measured signal for duty cycle and pulse width.
- After completing all measurements, disconnect the connection between the test leads and the circuit under test.

12. Temperature

- 1) Set the rotary switch to the measurement mV °C °F then press the SELECT key to choose Celsius °C or Fahrenheit °F. Insert the temperature connector into the four input terminals and connect two temperature probes to the temperature connector as shown in Figure 12. The temperature probes detect the surface temperature of the object under test.
- 2) Directly read the temperature values of the two sensors on the display.
- 3) Press the function key labelled, "MENU" to choose measurement options. Scroll through the menu with  keys and press F1 to choose the highlighted option. Press F2 while in the Menu to enter Relative Mode. Press F4 to close the Menu.

⚠ Attention:

- If the ambient temperature for the meter is outside the range of 18 °C to 28 °C, it may cause measurement errors. The measurement effects are more obvious at low temperatures.
- Remove the temperature probes after completing all the measurements.
- Point contact K type (chromel-silicel) thermocouple accuracy specification is for temperature measurements below 230 °C.

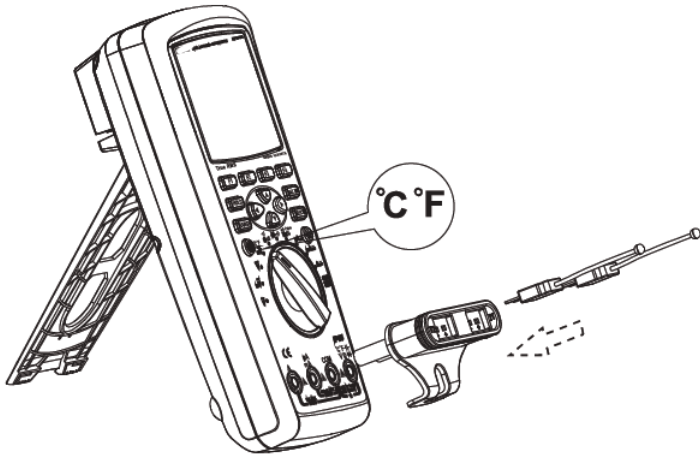

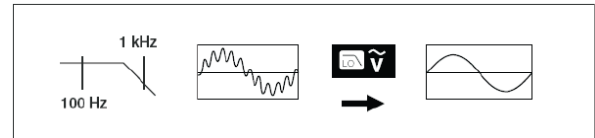

Figure 12

13. LPF Measurement

- 1) Insert the red test lead into the V terminal and the black test lead into the COM terminal.
- 2) Set the rotary switch to v. Connect the test leads to the power or load to be tested in parallel as shown in Figure 5.
- 3) Press the function key labelled, "MENU" to choose measurement options. Press the cursor keys  to highlight "Low Pass", then press the function key labelled, "Low Pass" to enter LPF measuring mode.
- 4) The meter performs the measurement in AC mode. The AC signals go through a filter which filters out voltage signals with frequencies higher than 1KHz. As shown in the following figure, the low-pass filter can measure the composite signals of sinusoidal waves generated by inverter and variable-frequency motor.





⚠ Attention:

- To avoid electric shock or personal injury, do not use the low-pass filter to verify hazardous voltage, there may be a voltage over the indicated value. First, measure the voltage without a filter to check whether it is hazardous, then select low-pass filtering.

- In the LFP measuring mode, the meter will turn to manual mode. Press the RANGE key to select a range. When the low-pass filter is enabled, automatic range is unavailable.
- Do not input a voltage above 1000V. Higher voltage may be measured but it poses the risk of damaging the meter.
- After completing all measurements, disconnect the connection between the test leads and the circuit under test.





14. dBV

- 1) Insert the red test lead into the V terminal and the black test lead into the COM terminal.
- 2) Set the rotary switch to v. Connect the test leads to the power or load to be tested in parallel as shown in Figure 5.
- 3) Press the function key labelled, “MENU” to choose measuring options. Press the cursor keys   to highlight “dBV”, then press the function key labelled, “dBV” to enter dBV measurement mode.
- 4) dBV is the primary measurement shown and AC voltage value is the secondary value shown on the display. AC voltage of the measured signal is also displayed on the simulation bar.

15. dBm

- 1) Insert the red test lead into the V terminal and the black test lead into the COM terminal.

- 2) Set the rotary switch to V. Connect the test leads to the power or load to be tested in parallel as shown in Figure 5.

- 3) Press the function key labelled, “MENU” to choose measurement options. Press the cursor keys   to highlight “dBm”. A reference impedance must be used to calculate the dBm measurement. Press the function key labelled, “RES” to select a reference impedance value. Press **(UP)** or **(DOWN)** to scroll between ten defined reference values: 4, 8, 16, 25, 32, 50, 75, 600, 1000Ω, and User Defined. While selecting a User defined reference impedance, press the function key labelled, “EDIT” and use the cursor keys   to input a reference impedance value between 4-1,200Ω. Press the function key labelled, “OK” to set reference values. Press the function key labelled, “dBm” to enter dBm measurement.

- 4) dBm is the primary measurement shown and AC voltage value is the secondary value shown on the display. AC voltage of the measured signal is also displayed on the simulation bar.

16. Maximum and Minimum Value

Press the “MAX MIN” key to activate Max Min Mode. Real-time measurements are the primary value displayed. Maximum, minimum, and average values, as well as elapsed time, start date and times corresponding to the three values are secondarily displayed.

Press the function key labelled, “EXIT” to exit Max Min Mode.

17. Relative Value Mode

Press the function key labelled, “MENU” to enter the measurement option menu. While in the menu, press the function key labelled, “REL” to enter Relative Value Mode*. The meter will store the value shown at the time that “REL” is pressed as the “Reference” measurement. Press the function key labelled, “REL” to store the present value as the “Reference”. The real-time measurement will be displayed as “Measurement”. The primary value displayed will be the Relative value (Measurement – Reference). Press the “MENU” function key to select other modes and exit Relative Value Mode. *NOTE: When applicable. Relative Value Mode is not available for all measurement types.

18. Peak Detection Mode

While in a Voltage or Current measuring mode, press the “MENU” function key to choose measurement options. While in the menu, press the function key labelled, “PEAK” to activate Peak Detection Mode. Response time is 1ms. Transient values can be more accurately measured by using Peak Mode while using the Record function.

19. Compare Mode



Press the F3 function key labelled, “COMP” to begin Compare Mode. Press **(UP)** or **(DOWN)** to scroll between the settings of Compare Mode. Press the “EDIT” function key to edit the highlighted Compare Mode setting.

1) Pass Mode

- INNER(Low Value \leq Input Value \leq High Value)
- OUTER (Input Value $<$ Low Value OR Input Value $>$ High Value)
- $<$ Value
- $>$ Value

Press the “OK” function key to confirm the above settings. To cancel the settings, press the “CANCEL” function key.

2) Beep Mode

While highlighting the “Beep Mode” setting, press the “EDIT” function key to edit the Beep settings. Press the   keys to select one of the three following options:

• PASS ON

The meter will beep when the Pass Mode criteria are met, and the meter displays, “PASS”.

• FAIL ON

The meter will beep when the Pass Mode criteria are NOT met, and the meter displays, “FAIL”.

• OFF

The meter will not beep in Compare Mode.

Press the function key OK to confirm the above settings. To cancel the settings, press the “CANCEL” function key.

3) Low Value or High Value or Value

This setting controls the value(s) for the Pass Mode criteria. After completing the settings, press the “START” function key to start the measurement in Compare Mode. Press the “EXIT” function key to exit Compare Mode.

20. Recording Measurement Data

Press the function key labelled, “SAVE” to enter the menu for saving, recording or viewing data. Press the cursor keys  to select the following options.

1) Save

While in the Save menu, press the “SAVE” function key to store the measurement currently displayed. Up to 20,000 measurements can be saved on the meter.

2) View Save

In the Save menu with “View Save” highlighted, press the “VIEW” function key to view stored save files. Press or hold the function keys labelled, “PREV” or “NEXT” to scroll through the saved data. Press the “DELETE” function key to delete the selected saved data. Press the “RETURN” function key to return to the last menu. In addition to displaying the saved data, the file save # and total number of saved files are displayed in the lower left corner. The date and time of the saved data are displayed in the lower right corner.

3) Delete All Save

In the Save menu with “Delete All Save” highlighted, press the function key labelled, “DELETE” to delete all saved data files. Press the function key labelled, “YES” to confirm. To cancel the operation, press the function key labelled, “NO”.

4) Record

In the Save menu with “Record” highlighted, press the function key labelled, “ENTER” to enter the continuous recording mode with a maximum of 10000 data points.

Press **(UP)** or **(DOWN)** to edit the three following settings.

• Edit Name

In the Record Menu with “Edit Name” highlighted, press the “EDIT” function key to edit the name of the recording. Press **(LEFT)** or **(RIGHT)** to move the cursor and select where to edit. Press the F1 key to switch the input to Uppercase mode, then press **(UP)** or **(DOWN)** to input uppercase letters. Press the F2 key to switch the input to Lowercase mode, then press **(UP)** or **(DOWN)** to input lowercase letters. Press the F3 key to switch the input to Digit mode, then press **(UP)** or **(DOWN)** to enter numbers or symbols. Press the F4 key to save the Record name and exit edit mode.

• Set Interval

With “Set Interval” highlighted, press the “EDIT” function key to set the time interval between recorded data points. Press or hold **(LEFT)** or **(RIGHT)** to move the cursors to select where to edit. Press or hold **(UP)** or **(DOWN)** to enter different numbers. The interval time can be set from 1 sec to 60 min between data points.

• Set Duration

With “Set Duration” highlighted, press the “EDIT” function key to set the duration of the recording. Press or hold **(LEFT)** or **(RIGHT)** to move the cursors to select where to edit. Press or hold **(UP)** or **(DOWN)** to enter different numbers. The duration time can be set in days, hours and minutes.

• Max Duration

Displays the maximum time for continuous recording with the current settings. When ready to Record, press the “START” function key to start a recording with the current settings.

When Recording, the characters “REC” show on the display with a flashing red dot, as shown in Figure 13. The relevant display information is shown in the following table.

Information	Description
Elapsed Time	Run time displayed in hours: minutes
Remaining Time	Time left displayed in hours: minutes: seconds
Samples	Total number of recorded data points for the active recording
Start	Time and date of the start of the recording.

To manually stop recording, press the “STOP” function key. After stopping the recording, the record data will be displayed. See the viewing options in the following “view Record” section.



Figure 13

5) View Record

In the Save Menu with “View Record” highlighted, press the “View” function key to view the information on recordings. The data will be displayed as shown in Figure 14. The basic display information is in the following table.

Information	Description
Name	Name of recording
Interval	Time between data points
Duration	Duration of recording from start to stop
Samples	Total number of data points recorded
Maximum	Maximum recorded value
Average	Average value of the recorded data
Minimum	Minimum recorded value
REC	Record file number and total number of recordings
Start	Time and date at beginning of recording

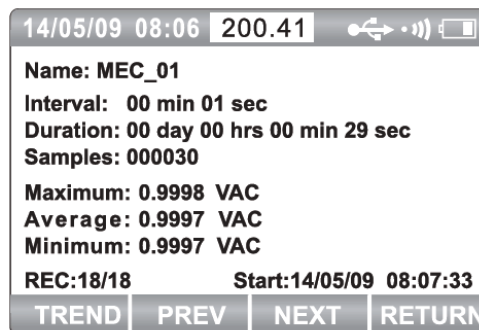

Figure 14

While viewing a Record, press the “PREV” function key to display the previous record. Press the “NEXT” function key to display the next record. Press the “RETURN” function key to return to the previous menu. Press the function key labelled, “TREND” to view the recording graphically, as shown in Figure 15. The display information of trend data is in the following table:

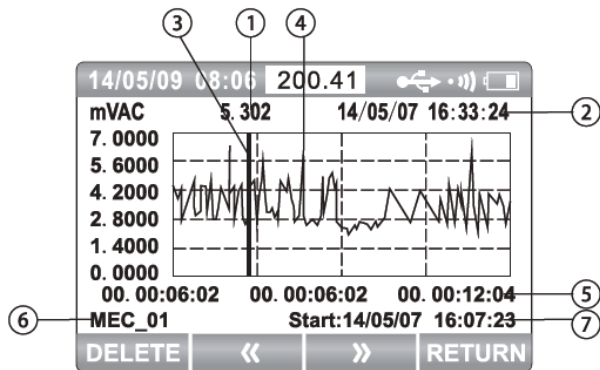

Figure 15

No.	Description
1	Measured value corresponding to cursor
2	Date and time of measurement at the cursor
3	Cursor
4	Trend line
5	Elapsed time labels on X-axis
6	Name of recording
7	Time and date at the start of the recording.

Viewing the trend chart: Press or hold the F2 key to move the cursor left. Press or hold the F3 key to move the cursor right. The cursor moves one data point for each press. Holding, or long pressing the keys will scroll through data points more quickly. Press (UP) or (DOWN) to scale the graph vertically. Press (LEFT) or (RIGHT) to scale the graph horizontally.

Press the F1 key to delete this record. Press the function key labelled, “YES” to confirm the deletion. To cancel the deletion, press the “NO” function key.

6) Delete All Record

In the Save menu with “Delete All Record” highlighted, press the function key labelled, “DELETE” to delete all recordings. Press the “YES” function key to confirm. To cancel the operation, press the “NO” function key.

21. Communication

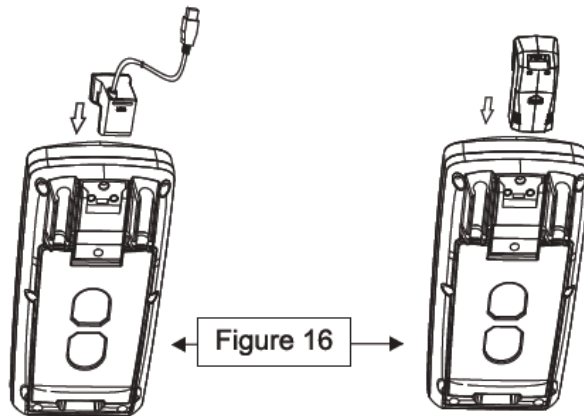

USB Communication

Turn on communication via settings (see detailed operations in the section 2. Meter Settings). The symbol  will appear in the upper right corner on the display as shown in Figure 15.

The meter performs USB communication with the supplied USB cable (standard accessory) connecting to the PC.

X. Maintenance and Repair

1. General Maintenance and Repair

Regularly clean the meter case with damp cloth and mild detergent. Do not use abrasives, isopropyl alcohol or solvents. Dirt or moisture on the terminals can affect readings but can also enable the “Lead Error” warning. Clean the terminals according to the following steps:

- 1) Turn off the meter and remove all test leads.
- 2) Clean up the dirt on the terminals.
- 3) Soak a clean cotton swab in mild detergent and water. Clean each terminal with the cotton swab. Dry each terminal with canned compressed air to force water and detergent to flow out of the terminals.
- 4) In the case of abnormal meter function, stop using it and send it for repair.

5) When the meter needs to be verified or repaired, qualified service personnel or a designated maintenance department are required to repair it.

2. Testing Fuses

As shown in Figure 17, put the meter in resistance mode. Insert a test lead into the terminal as shown in Figure 17 and contact the probe tip of the test lead with the metal in the of a current input terminal. If the message, “Lead Error!” (connection error for test leads) appears, it shows that the probe tip is inserted too deeply in the input current terminal. Draw out the test lead a little until the error message disappears and OL (overload) or resistance reading appears on the display. If the resistance reading for A terminal is less than 0.50Ω , it shows that the fuse F2 is normal. If the reading is “OL”, you need to replace F2; If the resistance reading of the μmA terminal is less than $1.2\text{M}\Omega$, it shows that the fuse F1 is normal. If the reading is OL, F1 needs to be replaced;

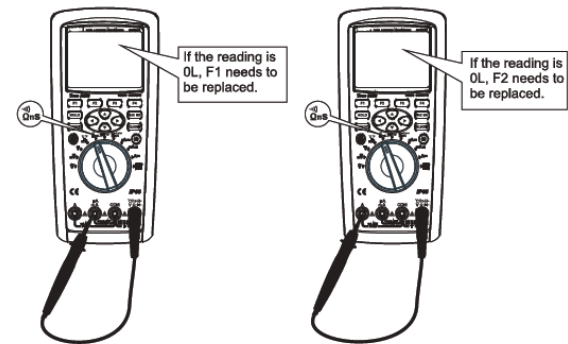

Figure 17

3. Replacing Fuses

Inspect or replace the meter fuse as shown in Figure 18 according to the following steps:

- 1) Turn off the meter and remove the test leads from the terminals.
- 2) Use a flat-head screwdriver to turn the screw on the battery cover counterclockwise, then remove the battery cover.
- 3) Gently pry one end of the fuse and then remove the fuse from the clip.
- 4) The required fuse installed for mA or μ A input terminal: 0.8A H 1000V Fuse Type 6X32mm (F1) The required fuse installed for A input terminal: 10A H 1000V Fuse Type 10X38 mm (F2)
- 5) Reinstall the battery cover and then turn the screw clockwise to tighten the battery cover.

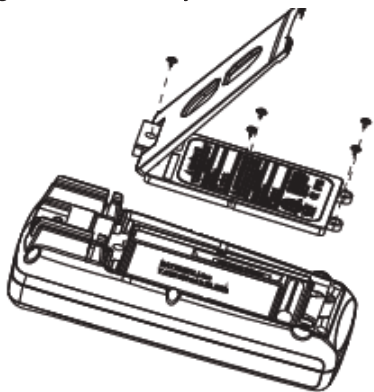



Figure 18

4. Battery Charge

When the indicator of battery level in upper right corner is less than 5% of full capacity, the meter should be immediately charged, otherwise it will affect the measurement accuracy. As shown in Figure 19, set the rotary switch to **CHG**. The message, "Please plug in AC adapter!" will prompt you to insert a power adapter for charging. Connect the power connector to the four terminals in the meter, then insert the power adapter into the power connector, as shown in Figure 19. The message, "Charging" on the display indicates it is in charging with a progress bar displaying battery charge to the nearest 5%. The power button  will light red. When the battery is fully charged, the red light will turn off and the charging process stops. A "Charge complete" message will display when fully charged.

Attention:

You must use the power adapter specified by Triplett.

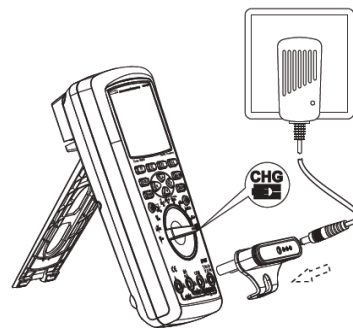

Figure 19

XI. Warranty

Triplett / Byte Brothers extends the following warranty to the original purchaser of these goods for use. Triplett warrants to the original purchaser for use that the products sold by it will be free from defects in workmanship and material for a period of (3) three years from the date of purchase.

This warranty does not apply to any of our products which have been repaired or altered by unauthorized persons in any way or purchased from unauthorized distributors so as, in our sole judgment, to injure their stability or reliability, or which have been subject to misuse, abuse, misapplication, negligence, accident or which have had the serial numbers altered, defaced, or removed. Accessories, including batteries and fuses, are not covered by this warranty.

To register a claim under the provisions of this warranty, please contact the distributor from which you purchased the product from for warranty consideration.

ALL WARRANTIES IMPLIED BY LAW ARE HEREBY LIMITED TO A PERIOD OF THREE YEARS FROM DATE OF PURCHASE, AND THE PROVISIONS OF THE WARRANTY ARE EXPRESSLY IN LIEU OF ANY OTHER WARRANTIES EXPRESSED OR IMPLIED.

The purchaser agrees to assume all liability for any damages and bodily injury which may result from the use or misuse of the product by the purchaser, his employees, or others, and the remedies provided for in this warranty are expressly

in lieu of any other liability Triplett may have, including incidental or consequential damages.

Some states (USA ONLY) do not allow the exclusion or limitation of incidental or consequential damages, so the above limitation or exclusion may not apply to you. No representative of Triplett / Byte Brothers or any other person is authorized to extend the liability of Triplett in connection with the sale of its products beyond the terms hereof.

Triplett / Byte Brothers reserves the right to discontinue models at any time, or change specifications, price or design, without notice and without incurring any obligation.

This warranty gives you specific legal rights, and you may have other rights which vary from state to state.



Manchester, NH USA

www.triplett.com

1-800-TRIPLETT

Model 9065
Part Number: 9065
Made in China

84-910
10/15