

## Troubleshooting power harmonics

### Basic troubleshooting using multimeters and current clamps

A mystery is occurring in today's office buildings and manufacturing plants. Transformers supplying seemingly average loads are overheating. Neutral conductors in balanced circuits are overheating from excessive loads. Circuit breakers are tripping for no apparent reason. Yet the standard troubleshooting procedures show everything to be normal. So what's the problem? In one word—harmonics.

#### New technology, new challenges

Harmonics are the byproducts of modern electronics. They are especially prevalent wherever there are large numbers of personal computers, adjustable speed drives, and other types of equipment that draw current in short pulses.

This equipment is designed to draw current only during a controlled portion of the incoming voltage waveform. While this dramatically improves efficiency, it causes harmonics in the load current. And that causes overheated transformers and neutrals, as well as tripped circuit breakers.

If you were to listen to an ordinary 60-cycle power line, you'd hear a monotone hum. When harmonics are present, you hear a different tune, rich with high

notes. The problem is even more evident when you look at the waveform. A normal 60-cycle power line voltage appears on the oscilloscope as a near sine wave (Figure 1). When harmonics are present, the waveform is distorted (Figure 2A and 2B). These waves are described as non-sinusoidal. The voltage and current waveforms are no longer simply related—hence the term “non-linear.”

#### Getting to the root of the problem

Finding the problem is relatively easy once you know what to look for and where to look. Harmonics symptoms are usually anything but subtle. This application note provides some basic pointers on how to find harmonics and some suggestions of ways to address the problems they create.

## Application Note

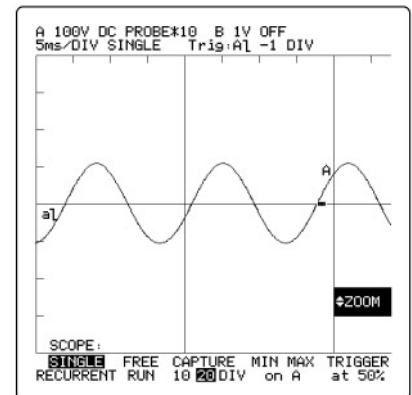

Figure 1. Near sine wave.

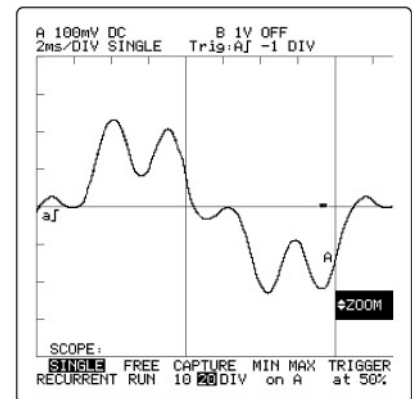

Figure 2A. Distorted current waveform.

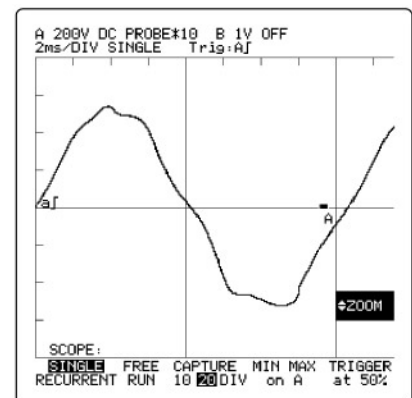

Figure 2B. Distorted voltage waveform.

## Sources of harmonics

### Defining the problem

Harmonics are currents or voltages with frequencies that are integer multiples of the fundamental power frequency. For example, if the fundamental frequency is 60 Hz, then the second harmonic is 120 Hz, the third is 180 Hz, etc.

Harmonics are created by non-linear loads that draw current in abrupt pulses rather than in a smooth sinusoidal manner. These pulses cause distorted current wave shapes which in turn cause harmonic currents to flow back into other parts of the power system.

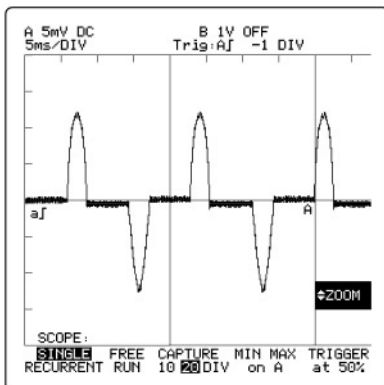

Figure 3A. Single-phase, non-linear load current waveform.

### The inside story

This phenomenon is especially prevalent with equipment that has diode-capacitor input power supplies; i.e., personal computers, printers and medical test equipment.

Electrically what happens is the incoming ac voltage is diode rectified and is then used to

charge a large capacitor. After a few cycles, the capacitor is charged to the peak voltage of the sine wave (e.g., 170 V for a 120 V ac line). The electronic equipment then draws current from this high dc voltage to power the rest of the circuit.

The equipment can draw the current down to a regulated lower limit. Typically, before reaching that limit, the capacitor is recharged to the peak in the next half cycle of the sine wave. This process is repeated over and over. The capacitor basically draws a pulse of current only during the peak of the wave. During the rest of the wave, when the voltage is below the capacitor residual, the capacitor draws no current.

The diode/capacitor power supplies found in office equipment are typically single-phase, non-linear loads (Figure 3A). In industrial plants, the most common causes of harmonic currents are three-phase, non-linear loads which include electronic motor drives, and uninterruptible power supplies (UPS) (Figure 3B).

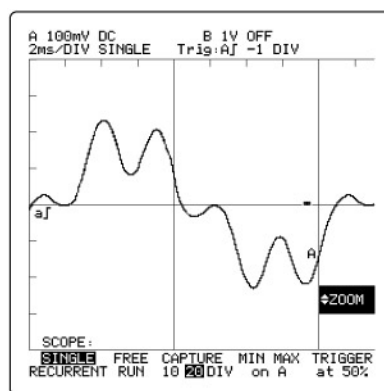

Figure 3B. Three-phase, non-linear load current waveform.

### Voltage harmonics

The power line itself can be an indirect source of voltage harmonics.

The harmonic current drawn by non-linear loads acts in an Ohm's law relationship with the source impedance of the supplying transformer to produce voltage harmonics. Source impedance includes the supplying transformer and branch circuit components. For example, a 10 A harmonic current being drawn from a source impedance of 0.1  $\Omega$  will generate a harmonic voltage of 1.0 V.

Any loads sharing a transformer or a branch circuit with a heavy harmonic load can be affected by the voltage harmonics generated.

The personal computer can be affected by voltage harmonics. The performance of the diode/capacitor power supply is critically dependent on the magnitude of the peak voltage. Voltage harmonics can cause "flat topping" of the voltage waveform lowering the peak voltage (see Figure 2B). In severe cases, the computer may reset due to insufficient peak voltage.

In the industrial environment, the induction motor and power factor correction capacitors can also be seriously affected by voltage harmonics.

Power correction capacitors can form a resonant circuit with the inductive parts of a power distribution system. If the resonant frequency is near that of the harmonic voltage, the resultant harmonic current can increase substantially, overloading the capacitors and blowing the capacitor fuses. Fortunately, the capacitor failure detunes the circuit and the resonance disappears.

## Effects of harmonic currents

Symptoms of harmonics usually show up in the power distribution equipment that supports the non-linear loads. There are two basic types of non-linear loads: single-phase and three-phase. Single-phase, non-linear loads are prevalent in offices, while three-phase loads are widespread in industrial plants.

Each component of the power distribution system manifests the effects of harmonics a little differently, yet all are subject to damage and inefficient performance if not designed to handle electronic loads.

### Neutral conductors

In a three-phase, four-wire system, neutral conductors can be severely affected by non-linear loads connected to the 120 V branch circuits. Under normal conditions for a balanced linear load, the fundamental 60 Hz portion of the phase currents will cancel in the neutral conductor.

In a four-wire system with single-phase, non-linear loads, certain odd-numbered harmonics called triplens—odd multiples of the third harmonic: 3rd, 9th, 15th, etc—do not cancel, but rather add together in the neutral conductor. In systems with many single-phase, non-linear loads, the neutral current can actually exceed the phase current. The danger here is excessive overheating because, unlike phase conductors, there are no circuit breakers in the neutral conductor to limit the current.

Excessive current in the neutral conductor can also cause higher-than-normal voltage drops between the neutral conductor and ground at the 120 V outlet.

### Circuit breakers

Common thermal-magnetic circuit breakers use a bi-metallic trip mechanism that responds to the heating effect of the circuit current. They are designed to respond to the true-rms value of the current waveform and will trip when the trip mechanism gets too hot. This type of breaker has a good chance of protecting against harmonic current overloads.

A peak-sensing, electronic trip circuit breaker responds to the peak of current waveform. As a result, it won't always respond properly to harmonic currents. Since the peak of the harmonic current is usually higher than normal, this type of circuit breaker may trip prematurely at a low current. If the peak is lower than normal, the breaker may fail to trip when it should.

### Bus bars and connecting lugs

Neutral bus bars and connecting lugs are sized to carry the full value of the rated phase current. They can become overloaded when the neutral conductors are overloaded with the additional sum of the triplen harmonics.

### Electrical panels

Panels that are designed to carry 60 Hz currents can become mechanically resonant to the magnetic fields generated by higher frequency harmonic currents. When this happens, the panel vibrates and emits a buzzing sound at the harmonic frequencies.

### Telecommunications

Telecommunications systems often give you the first clue to a harmonics problem because the cable can be run right next to power cables. To minimize the inductive interference from

phase currents, telecommunications cables are run closer to the neutral wire.

Triplens in the neutral conductor commonly cause inductive interference, which can be heard on a phone line. This is often the first indication of a harmonics problem and gives you a head start in detecting the problem before it causes major damage.

### Transformer

Commercial buildings commonly have a 208/120 V transformer in a delta-wye configuration. These transformers commonly feed receptacles in a commercial building. Single-phase, non-linear loads connected to the receptacles produce triplen harmonics, which add up in the neutral. When this neutral current reaches the transformer, it is reflected into the delta primary winding where it causes overheating and transformer failures.

Another transformer problem results from core loss and copper loss. Transformers are normally rated for a 60 Hz phase current load only. Higher frequency harmonic currents cause increased core loss due to eddy currents and hysteresis, resulting in more heating than would occur at the same 60 Hz current.

These heating effects demand that transformers be derated for harmonic loads or replaced with specially designed transformers.

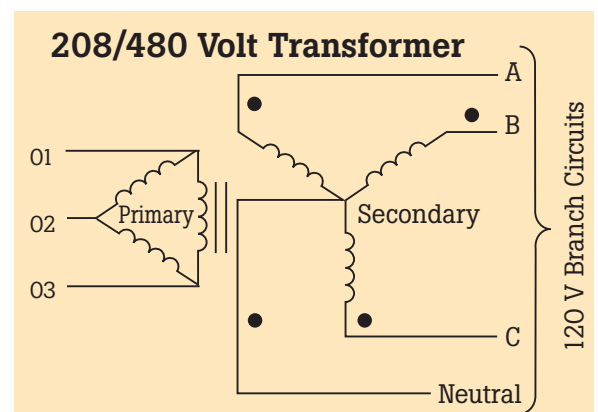

## Generators

Standby generators are subject to the same kind of overheating problems as transformers. Because they provide emergency backup for harmonic producing loads such as data processing equipment, they are often even more vulnerable. In addition to overheating, certain types of harmonics produce distortion at the zero crossing of the current waveform, which causes interference and instability for the generator's control circuits.

## Classification of harmonics

Each harmonic has a name, frequency and sequence. The sequence refers to phasor rotation with respect to the fundamental (F), i.e., in an induction motor, a positive sequence harmonic would generate a magnetic field that rotated in the same direction as the fundamental. A negative sequence harmonic would rotate in the reverse direction. The first nine harmonics along with their effects are listed below:

Name	F	2nd*	3rd	4th*	5th	6th*	7th	8th*	9th
Frequency	60	120	180	240	300	360	420	480	540
Sequence	+	-	0	+	-	0	+	-	0

\*Even harmonics disappear when waves are symmetrical (typical for electrical circuits)

Sequence	Rotation	Effects (from skin effect, eddy currents, etc.)
Positive	Forward	Heating of conductors, circuit breakers, etc.
Negative	Reverse	Heating as above plus motor problems
Zero**	None	Heating, plus add in neutral of 3-phase, 4-wire system

\*\*Zero sequence harmonics (odd multiples of the 3rd) are called "Triplens" (3rd, 9th, 15th, 21st, etc.)

## Finding harmonics

A harmonic survey will give you a good idea if you have a problem and where it is located. Here are a few guidelines to follow.

- 1. Load inventory.** Make a walking tour of the facility and take a look at the types of equipment in use. If you have a lot of personal computers and printers, adjustable speed motors, solid-state heater controls, and certain types of fluorescent lighting, there's a good chance that harmonics are present.
- 2. Transformer heat check.** Locate the transformers feeding those non-linear loads and check for excessive heating. Also make sure the cooling vents are unobstructed.
- 3. Transformer secondary current.** Use a three-phase true-rms power quality analyzer to check transformer currents.
  - Verify that the voltage ratings for the clamp meter are adequate for the transformer being tested.
  - Measure and record the transformer secondary currents in each phase and in the neutral (if used).

- Compare the kVA delivered to the load against the nameplate rating. (If harmonic currents are present, the transformer can overheat even if the kVA delivered is less than the nameplate rating.)
  - Use the k-factor measurement from a three-phase analyzer to determine de-rating or transformer replacement.
  - Measure the frequency of the neutral current. 180 Hz would be a typical reading for a neutral current consisting of mostly third harmonic.
- 4. Sub-Panel neutral current check.** Survey the sub-panels that feed harmonic loads. Measure the current in each branch neutral and compare the measured value to the rated capacity for the wire size used. Check the neutral bus bar and feeder connections for heating or discoloration. A non-contact infrared thermometer, like the Fluke 61, is useful for detecting excessive overheating on bus bars and connections.

- 5. Receptacle neutral-to-ground voltage check.** Neutral overloading in receptacle branch circuits can sometimes be detected by measuring the neutral-to-ground voltage at the receptacle.
  - Measure the voltage when the loads are on. Two volts or less is about normal. Higher voltages can indicate trouble depending on the length of the run, quality of connections, etc. Measure the frequency. A frequency of 180 Hz would suggest a strong presence of harmonics, while 60 Hz would suggest that the phases are out of balance. Pay special attention to under carpet wiring and mod-ular office panels with integrated wiring that uses a neutral shared by three-phase conductors.
  - Because the typical loads in these two areas are computer and office machines, they are often trouble spots for overloaded neutrals.

## Troubleshooting tools

To determine whether you have a harmonics problem you need to measure the true-rms value and the instantaneous peak value of the wave shape. For single applications, you need either a clamp meter like the Fluke 335, 336 or 337 or a multimeter like those in the Fluke 80, 170 and 180 Series that makes true-rms measurements. For three-phase applications, you'll need a power quality analyzer like the Fluke 430 Series.

"True-rms" refers to the root-mean-square, or equivalent heating value of a current or voltage wave shape. "True" distinguishes the measurement from those taken by "average responding" meters. The vast majority of low-cost, portable meters are average responding. These instruments give correct readings for pure sine waves only and will typically read low by as much as 50 percent when confronted with a distorted current waveform. True-rms meters give correct readings for any wave shape within the instrument's crest factor and bandwidth specifications.

### Crest factor

The crest factor of a waveform is the ratio of the peak value to the rms value. For a sine wave, the crest factor is 1.414. A true-rms meter will have a crest factor specification. This spec relates to the level of peaking that can be measured without errors.

A quality true-rms handheld digital multimeter has a crest factor of 3.0 at full scale. This is more than adequate for most power distribution measurements. At half scale the crest factor is double. For example, the Fluke 187 DMM has a crest factor spec of up to 3.0 when measuring 400 V ac and a crest factor of up to 6.0 when measuring 200 V ac.



Using a true-rms meter with a "Peak" function—like the Fluke 187—the crest factor can be

easily calculated. A crest factor other than 1.414 indicates the presence of harmonics. In typical single-phase cases, the greater the difference from 1.414, the higher the harmonic content. For voltage harmonics, the typical crest factor is below 1.414; i.e., a "flat top" waveform. For single-phase current harmonics, the typical crest factor is much higher than 1.414.

Three-phase current waveforms often exhibit a "double hump" waveform, therefore the crest factor comparison method should not be applied to three-phase load current.

After you've determined that harmonics are present, you can make a more in-depth analysis of the situation with a harmonic analyzer such as the Fluke 43B Power Quality Analyzer.

### Multimeter performance comparison average responding vs. true-rms

Meter Type	Measuring Circuit	Sine Wave Response* 	Square Wave Response* 	Distorted Wave Response* 
Average Responding	Rectified Average x 1.1	Correct	10 % high	Up to 50 % low
True-rms	RMS Calculating converter. Calculates heating value.	Correct	Correct	Correct

\*Within multimeter's bandwidth and crest factor specifications.

## Solving the problem

The following are suggestions of ways to address some typical harmonics problems. Before taking any such measures you should call a power quality expert to analyze the problem and design a plan tailored to your specific situation.

### In overloaded neutrals

In a three-phase, four-wire system, the 60 Hz portion of the neutral current can be minimized by balancing the loads in each phase. The triplen harmonic neutral current can be reduced by adding harmonic filters at the load. If neither of these solutions is practical, you can pull in extra neutrals—ideally one neutral for each phase—or you can install an oversized neutral shared by three phase conductors.

In new construction, under carpet wiring and modular office partitions wiring should be specified with individual neutrals and possibly an isolated ground separate from the safety ground.

### Derating transformers

One way to protect a transformer from harmonics is to limit the amount of load placed on it. This is called “derating” the transformer. The most rigorous derating method is described in ANSI/IEEE standard C57.110–1986. It is somewhat impractical because it requires extensive loss data from the transformer manufacturer plus a complete harmonic spectrum of the load current.

The Computer & Business Equipment Manufacturers Association has recommended a second method that involves several straightforward measurements that you can get with commonly available test equipment. It appears to give reasonable results for 208/120 V receptacle transformers that supply low frequency odd harmonics (third, fifth, seventh) commonly generated by computers and office machines operating from single-phase branch circuits.

### Derating factor

To determine the derating factor for the transformer, take the peak and true-rms current measurements for the three phase conductors. If the phases are not balanced, average the three measurements and plug that value into the following formula:

$$\begin{aligned} \text{HDF} &= \text{Harmonic derating factor} \\ &= \frac{(1.414)(\text{true-rms phase current})}{(\text{Instantaneous peak phase current})} \end{aligned}$$

This formula generates a value between 0 and 1.0, typically between 0.5 and 0.9. If the phase currents are purely sinusoidal (undistorted) the instantaneous peaks are 1.414 times the true-rms value and the derating factor is 1.0. If that is the case no derating is required.

However, with harmonics present the transformer rating is the product of the nameplate kVA rating times the HDF.

$$\text{kVA derated} = (\text{HDF}) \times (\text{kVA nameplate})$$

For example: 208/120 Y transformer rated at 225 kVA:

	Conductor name	True-rms current amps	Instantaneous peak current
Load currents were measured with a Fluke Model 87 and an 80i-600 ac current probe to produce the following results:	01	410 A	804 A
	02	445 A	892 A
	03	435 A	828 A

$$\text{I phase avg.} = \frac{410 + 445 + 435}{3} = 430 \text{ A}$$

$$\text{I pk avg.} = \frac{804 + 892 + 828}{3} = 841 \text{ A}$$

$$\text{HDF} = \frac{(1.414)(430)}{841} = 72.3 \%$$

The results indicate that with the level of harmonics present the transformer should be derated to 72.3 % of its rating to prevent overheating.

## Work safely

The high voltage and current present in electrical power systems can cause serious injury or death by electrocution. Consequently, only trained, experienced electricians who have knowledge of electrical systems in general and the equipment under test should perform testing and modification of electrical systems.

Fluke cannot anticipate all possible precautions that you must take when performing the measurements described here. At a minimum, however, you should:

- Use appropriate safety equipment such as safety glasses, insulating gloves, insulating mats, etc.
- Be sure that all power has been turned off, locked out, and tagged in any situation

where you will be in direct contact with circuit components. Be certain that the power can't be turned on by anyone but you.

- Read and understand all of the applicable manuals before using the application information in this application note. Take special note of all safety precautions and warnings in the instruction manuals.

This article is a general guide to understanding harmonics. It is not intended to substitute for the services of a professional electrical systems consultant. Before you take any measures to diagnose or address your potential harmonics problems, you should have your operation thoroughly analyzed by a professional electrical engineer.



## Case study

### Situation

A modern office building dedicated primarily to computer software development contained a large number of personal computers and other electronic office equipment. These electronic loads were fed by a 120/208 V transformer configured with a delta primary and a wye secondary. The PCs were fairly well distributed throughout the building, except for one large room that contained several machines. The PCs in this room, used exclusively for testing, were served by several branch circuits.

The transformer and main switch gear were located in a ground floor electrical room. Inspection of this room immediately revealed two symptoms of high harmonic currents:

- The transformer was generating a substantial amount of heat.

- The main panel emitted an audible buzzing sound. The sound was not the chatter commonly associated with a faulty circuit breaker, but rather a deep resonant buzz that indicated the mechanical parts of the panel itself were vibrating.

Ductwork installed directly over the transformer to carry off some of the excess heat kept the room temperature within reasonable limits.

### Defining the problem

**Transformer** – Current measurements (see Table 1) were taken on the neutral and on each phase of the transformer secondary using both a true-rms multimeter and an average-responding unit. A 600 A clamp-on current transformer accessory was connected to allow them to make high current readings. The current waveshapes are shown in Figures 4 and 5.

Conductor name	True-rms multimeter (amps)	Average responding multimeter (amps)	Instantaneous peak current (amps)
Phase 1	410	328	804
Phase 2	445	346	892
Phase 3	435	355	828
Neutral	548	537	762

The presence of harmonics was obvious by comparison of phase current and neutral current measurements. As Table 1 shows, the neutral current was substantially higher than any of the phase currents, even though the phase currents were relatively well balanced. The average-responding meter consistently took readings approximately 20 percent low on all the phases. Its neutral current readings were only 2 percent low.

The waveforms explain the discrepancy. The *phase* currents were badly distorted by large amounts of third harmonic current, while the *neutral* current was nearly a pure sinewave at the third harmonic frequency. The phase current readings listed in Table 1 demonstrate clearly why true-rms measurement capability is required to accurately determine the value of harmonic currents.

The next step was to calculate the "harmonic derating factor" or HDF (Refer to "Derating transformers" section on page 6.)

The results indicated that, with the level of harmonics present, the transformer should be derated to 72.3 percent of its nameplate rating to prevent overheating. In this case the transformer should be derated to 72.3 percent of its 225 kVA rating, or derated to 162.7 kVA. The actual load was calculated to be 151.3 kVA. Although that figure was far less than the nameplate rating, the transformer was operating close to its derated capacity.

**Subpanel**—Next a subpanel which supplied branch circuits for the 120 V receptacles was examined. The current in each neutral was measured and recorded (see Table 2).

When a marginal or overloaded conductor was identified, the associated phase currents and the neutral-to-ground voltage at the receptacle were also measured. When a check of neutral #6 revealed 15 A in a conductor rated for 16 A, the phase currents of the circuits

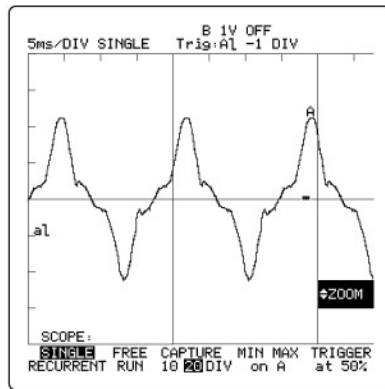

Figure 4. Phase current.

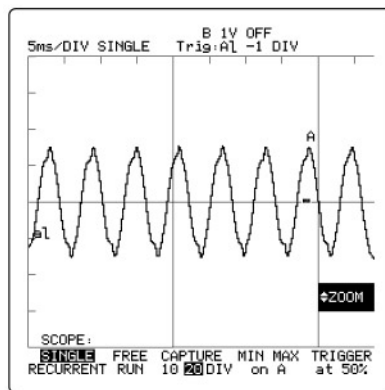

Figure 5. Neutral current.

Neutral conductor number	Current (amps)
01	5.0
02	11.3
03	5.0
04	13.1
05	12.4
06	15.0*
07	1.8
08	11.7
09	4.5
10	11.8
11	9.6
12	11.5
13	11.3
14	6.7
15	7.0
16	2.3
17	2.6

Table 2. Subpanel branch circuit neutral currents.

(#25, #27, and #29) that shared that neutral were also measured (Table 3). Note that each of the phase currents of these three branch circuits was substantially less than 15 A, and also the same phase conductors had significant neutral-to-ground voltage drops.

In the branch circuits which had high neutral current, the relationship between the neutral and the phase currents was similar to that of the transformer secondary. The neutral current was higher than any of the associated phase currents. The danger here is that the neutral conductors could become overloaded and not offer the warning signs of tripped circuit breakers.

### Recommendations

1. Refrain from adding additional loads to the receptacle transformer unless steps are taken to reduce the level of harmonics.
2. Pull in extra neutrals to the branch circuits that are heavily loaded.
3. Monitor the load currents on a regular basis using true-rms measuring test equipment.

Circuit number	Phase current (amps)	Neutral-to-ground voltage drop at receptacle
25	7.8	3.75 V
27	9.7	4.00 V
29	13.5	8.05 V

Table 3. Phase currents and neutral-to-ground voltage for neutral #06.

**Fluke.** Keeping your world up and running.®

**Fluke Corporation**  
PO Box 9090, Everett, WA 98206 U.S.A.

**Fluke Europe B.V.**  
PO Box 1186, 5602 BD Eindhoven, The Netherlands

**For more information call:**  
In the U.S.A. (800) 443-5853 or Fax (425) 446-5116  
In Europe/M-East/Africa +31 (0) 40 2675 200 or Fax +31 (0) 40 2675 222  
In Canada (800)-36-FLUKE or Fax (905) 890-6866  
From other countries +1 (425) 446-5500 or Fax +1 (425) 446-5116  
Web access: <http://www.fluke.com>

©2003-2009 Fluke Corporation.  
Specifications subject to change without notice.  
Printed in U.S.A. 6/2009 1260362K A-EN-N

**Modification of this document is not permitted without written permission from Fluke Corporation.**