

**UEI**  
TEST INSTRUMENTS™

**DL589**

# True RMS HVAC/R Clamp Meter w/ DC Amps

**INSTRUCTION MANUAL**

**ENGLISH**

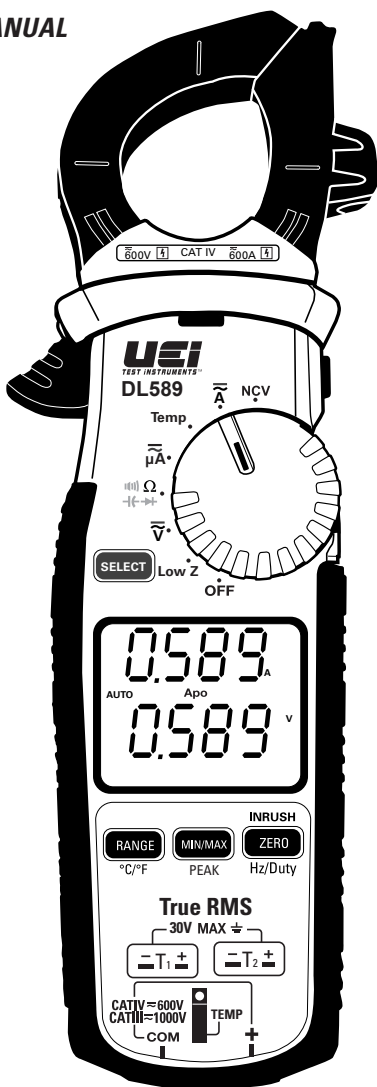

1-800-547-5740

www.ueitest.com • email: info@ueitest.com



## Table Of Contents

<b>FUNCTIONS</b> .....	4
<b>FEATURES</b> .....	4
<b>GENERAL SPECIFICATIONS</b> .....	4
<b>IMPORTANT SAFETY WARNINGS</b> .....	5
<b>SYMBOLS</b> .....	6
<b>CATEGORY DEFINITIONS</b> .....	6
<b>OVERVIEW</b> .....	7 - 8
<b>OPERATING INSTRUCTIONS</b>	
Low Z (Low Impedance) .....	8
AC/DC Amps: <600A – Jaw .....	9
Non-Contact Voltage.....	10
AC/DC Microamps: <2000 $\mu$ A .....	11
Temperature Calibration .....	11
Temperature F°/C° .....	12
Continuity .....	12
Resistance: < 60M $\Omega$ .....	13
Capacitance.....	13
Diode .....	14
Voltage: 750V AC/1000V DC.....	15
Frequency (Hz) / Duty Cycle .....	16
LRA Inrush .....	17
Zero DC Amps.....	17
Test Lead Notes .....	18
Battery Replacement .....	18
<b>WARRANTY</b> .....	20
<b>DISPOSAL</b> .....	20
<b>CLEANING</b> .....	20
<b>STORAGE</b> .....	20

## Functions

- True RMS
- 750V AC/1000V DC
- 600A AC/DC
- Differential temperature
- AC/DC microamps: 2000 $\mu$ A
- Capacitance: 2000 $\mu$ F
- Frequency: 99.99kHz
- Duty cycle
- Diode test
- Audible continuity
- NCV
- LRA Inrush
- DC Zero
- Temperature range: -328° to 2462°F
- Resistance: 60M $\Omega$
- Low Z (Low Impedance)

## Features

- Dual display
- Auto/Manual ranging
- Worklight
- Back light
- Low battery indicator
- Data Hold
- Auto power off
- Test lead storage
- Auto calibration
- Built-in Magnet w/ hanging strap
- Visible high-voltage alert
- Input jack locks
- Min/Max/Avg
- Peak Hold

## General Specifications

- Operating Temperature: 32° to 122°F (0° to 50°C)
- Storage Temperature: -4° to 140°F (-20° to 60°C)
- Operating Humidity: <80%
- Pollution Degree: 2
- Display: 3 5/6 digits 6,000 count
- Back light: Yes
- Refresh Rate: 3/sec
- Over-range: "OL" is displayed
- Apo: Auto power off after 30 minutes of use.
- Dimensions: 9.45" x 2.58" x 1.67"
- Item Weight: 0.888 lb.
- CAT Rating: CATIV 600V
- Certifications: cETLus UL 61010-1: 2012, IP42, 6 ft. Drop Protection
- Battery Type: (AAA) 4
- Test Leads: Test leads w/ alligator clips  
Use ATL58 test leads w/ AAC3 alligator clips.  
ATL55, ATL57 and ATLTX will not work with DL589

## Important Safety Warnings

### **WARNING**

Read entire Safety Notes section regarding potential hazards and proper instructions before using this meter. In this manual the word **“WARNING”** is used to indicate conditions or actions that may pose physical hazards to the user. The word **“CAUTION”** is used to indicate conditions or actions that may damage this instrument.

### **WARNING**

To ensure safe operation and service of the tester, follow these instructions. Failure to observe these warnings can result in severe injury or death.

### **WARNING**

- Before each use, verify meter operation by measuring a known voltage or current.
- Never use the meter on a circuit with voltages that exceed the category based rating of this meter.
- Do not use this meter during electrical storms or in wet weather.
- Do not use the meter or test leads if they appear damaged.
- Ensure meter leads are fully seated and keep fingers away from the metal probe contact when making measurements. Always grip the leads behind the finger guards molded into the probe. For information on test lead shields instructions on page 19.
- Do not open the meter to replace batteries while the probes are connected.
- Use caution when working with voltages above 60 DC or 25 AC RMS. Such voltages pose shock hazards.
- To avoid false readings that can lead to electrical shock, replace batteries if a low battery indicator appears.
- Unless measuring voltage or current, shut off and lockout power before measuring resistance or capacitance.
- Always adhere to national and local safety codes. Use proper personal protective equipment (PPE) to prevent shock and arc blast injury where hazardous live conductors are exposed.
- Always turn off power to a circuit or assembly under test before cutting, unsoldering or breaking the current path. Even small amounts of current can be dangerous.
- Always disconnect the live test lead before disconnecting the common test lead from the circuit.
- In the event of electrical shock, ALWAYS bring the victim to the emergency room for evaluation, regardless of victim's apparent recovery. Electrical shock can cause unstable heart rhythms that may need medical attention.
- If any of the following occur during testing, turn off the power source to the circuit being tested: arcing, flame, smoke, extreme heat, smell of burning materials or discoloration or melting of components.













### **WARNING**

Higher voltages and currents require greater awareness of physical safety hazards. Before connecting the test leads; turn off power to the circuit under test, set meter to the desired function and range; connect the test leads to the meter first, then connect to the circuit under test. Reapply power. If an erroneous reading is observed, disconnect power immediately and recheck all settings and connections.

### **WARNING**

This meter is designed to provide HVAC/R technicians with the capabilities they need to diagnose and repair HVAC/R system. Observe all recommended safety procedures that include proper lockout utilization and use of personal protective equipment that includes safety glasses, gloves and flame resistant clothing.

## Symbols

	AC (Alternating current)		DC (Direct current)
	Negative		AC/DC Voltage or Current
<b>AT</b>	Auto-ranging	<b>OL</b>	Overload: Range Exceeded
<b>Apo</b>	Auto power off Active	<b>NCV</b>	Non-Contact Voltage
	Low Battery	<b>HOLD</b>	Hold/Capture Value
<b>MIN</b>	Minimum measured value displayed	<b>MAX</b>	Maximum measured value displayed
<b>P-MIN</b>	Peak Min measured value displayed	<b>P-MAX</b>	Peak Max measured value displayed
<b>%</b>	Duty Cycle	<b>Hz</b>	Hertz/Frequency
<b>V</b>	Voltage	<b>INRUSH</b>	Inrush
<b>A</b>	Amperage	$\Omega$	Ohms/Resistance
	Diode		Capacitance
<b>nF</b>	Nanofarad	$\mu\text{F}$	Microfarad
<b><math>\mu\text{A}</math></b>	Microamps		Continuity
<b><math>^{\circ}\text{F}</math></b>	Degrees Fahrenheit	<b><math>^{\circ}\text{C}</math></b>	Degrees Celsius
<b>M</b>	Mega ( $\times 10^6$ or 1,000,000)	<b>m</b>	Milli ( $\times 10^{-3}$ or 0.001)
<b>k</b>	Kilo ( $\times 10^3$ or 1,000)	$\mu$	Micro ( $\times 10^{-6}$ or 0.000001)
	Warning or Caution		Ground
	Dangerous Levels		Double Insulation (Protection to Class II)
	Safe for disconnect from live conductors	- - - -	No reading detected
<b>AVG</b>	Average	<b>EF</b>	Electric Field
<b>T<sub>1</sub></b>	Temperature input 1	<b>T<sub>2</sub></b>	Temperature input 2
<b>M<math>\Omega</math></b>	Mega Ohms	<b>k<math>\Omega</math></b>	Kilo Ohms

## Category Definitions

Measurement Category	Short-Circuit (typical) kA <sup>a</sup>	Location in the building installation
II	< 10	Circuits connected to mains socket outlets and similar points in the MAINS installation
III	< 50	Mains distributions parts of the building
IV	> 50	Source of the mains installation in the building

## Overview

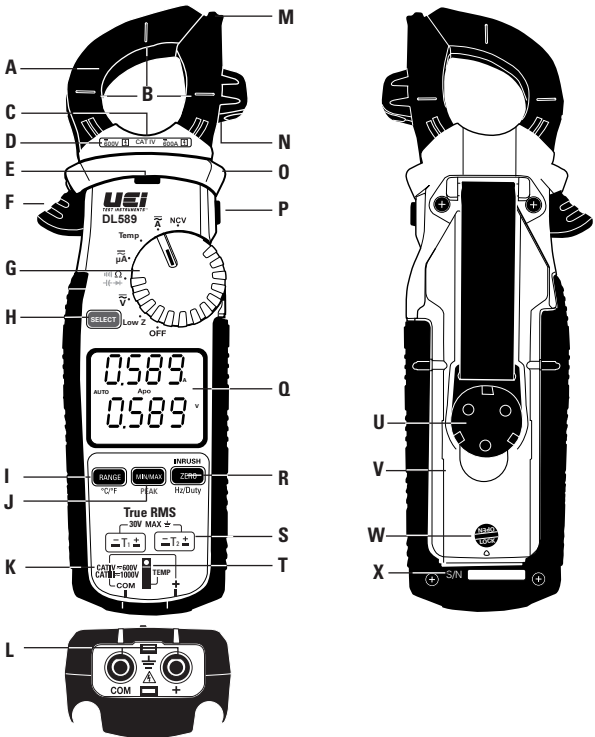

- A. Clamp:** Measure inductive AC/DC current. Opens to 1.25" (32.0mm).
- B. Conductor Alignment Marks:** Use to aid the visual alignment of a conductor when measuring inductive amperage. Greatest accuracy is achieved when the conductor inside the clamp is centered at the intersection of these marks.
- C. Worklight:** Lights clamp area in dark work environments.
- D. Category Max Indicator:** Maximum CAT Rating for clamp jaw.
- E. NCV Alert Light:** Indicates voltage when in NCV (Non Contact Voltage) mode and High Voltage alert.
- F. Clamp Lever:** Opens and closes current clamp jaw.  
**NOTE:** *The clamp uses a high-tension spring to close the jaw. Do not allow fingers or objects to become pinched in the base as the jaws close.*
- G. Rotary Selector Dial:** Set Rotary Selector Dial desired function
- H. SELECT Button:**
- Press to select AC or DC on Low Z setting; AC or DC on voltage setting; to activate Ohms, Continuity, Diode, Capacitance on Ohms/Continuity/Diode/Capacitance setting; AC or DC on Low Amps setting; T1, T2, T1-T2 on temperature setting
- I. Range/°C°F Button:**
- Press to set manual range desired
  - Press and Hold to select °F or °C temperature setting.
- J. Min/Max/Avg/Peak Button:**
- Press to enter MIN/MAX mode.
  - Step through maximum(MAX), minimum(MIN), average(AVG) and present values.
  - Press and hold return to Live readings
  - Press and hold to select PEAK hold at AC or DC voltage.
- K. Category Max Indicator:** Maximum CAT Rating for input jacks.

## Overview (Cont.)

- L. Test Lead Input Jacks:** Multifunction and Positive input jacks.
- Multifunction input port used for measuring: AC or DC volts, resistance, continuity, diode, capacitance, AC or DC  $\mu$ A.
- M. Wire Separation Tab/ NCV sensor:** Use to isolate an individual wire from a bundle for testing. NCV sensor detects live voltage.
- N. Test Lead Holder**
- O. Hand Guide:** Used as a point of reference for the operator's safety.
- P. Hold/Worklight/ Back light Button:**
- Press to hold the reading on the display. Press again to return to live reading.
  - Press and hold to turn on Worklight and Back light.
  - Worklight and Backlight turn off after 60 seconds.
  - Press hold during power up to disable the Auto power off function.
- Q. Display:**
- High contrast dual display with backlit.
  - Amps (AC/DC) reading will always display on upper display.
- R. LRA Inrush/Zero/Hz/Duty Button:**
- Press to Zero the DC Amps reading.
  - Press to enter LRA Inrush mode (See page 17 for details) (must be in AC Amps mode first).
  - Press again to return to live readings.
  - Press and hold to select Hz/Duty in AC volt or AC  $\mu$ A.
- S. K-Type Temperature Probe Inputs:** T1 (Left) and T2 (Right))
- T. Input Jack Lock:** Switch to use Temperature or Test lead inputs
- U. Built-in versatile magnet to use as a mount or as a strap**
- V. Battery Cover:** Easy access for replacing batteries without breaking calibration seal.
- W. Battery Compartment Latches:**
- X. Serial Number**

## Low Z (Low Impedance)

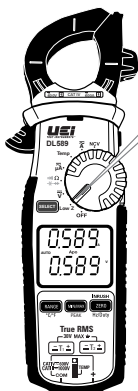

### Low Z

- Rotate Selector Dial to Low Z
- Default = Auto Selection (AC or DC)
- Press SELECT x1 =  $\tilde{V}$
- Press SELECT x2 =  $\overline{\tilde{V}}$

Features:





## AC/DC Amps <600A Jaw

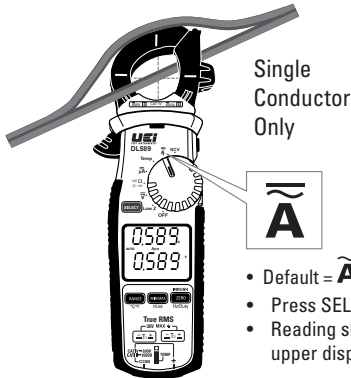

- Center wire in guides for best accuracy.
- Opposing currents cancel each other (use line-splitter when necessary).
- Keep hands below guard when measuring high current levels.
- Do not attempt to measure more than 600A AC / 600A DC.

### Features:



### AC Amps Measurement - Jaw input

Range	Resolution	Accuracy	Overload Protection
60.00A	0.01A	$\pm 2.0\% + 8\text{dgts}$	600V RMS
600.0A	0.1A	$\pm 2.0\% + 8\text{dgts}$	

45Hz to 400Hz True RMS

Minimum Current for Clamp Measurement: 0.3A

### DC Amps Measurement - Jaw input

Range	Resolution	Accuracy	Overload Protection
60.00A	0.01A	$\pm 2.0\% + 8\text{dgts}$	600V RMS
600.0A	0.1A	$\pm 2.0\% + 8\text{dgts}$	

Minimum Current for Clamp Measurement: 0.2A

## Non-Contact Voltage

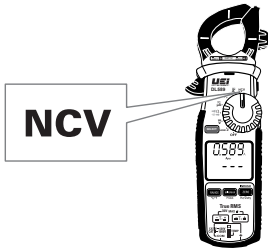

NCV Sensor in the tip.

- Rotate Rotary Selector Dial to **NCV** position move the tip of the clamp meter near voltage source.
- Non-Contact Voltage Detection is used to detect power with sensor located in the tip of the clamp head, indicates positive response with both an Audible and Visual alert.
- Do not use Non-contact voltage detector to determine if there is current on the wire. Detection operation could be affected by socket design, insulation thickness, type or other factors.
- Voltage indicator light may also light when voltage (>AC/DC 30V) is present on the meter's input jack or from an external interference such as motors, flashlights, etc.

Features:



**On Voltage**

Approx. 24V AC

## AC/DC Microamps: <math> < 2000\mu A </math>



- Default =  $\overline{\mu A}$
- Press SELECT =  $\tilde{\mu A}$
- Readings show on lower display

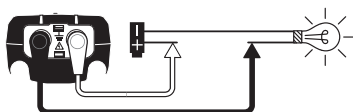

### **WARNING**

- Do not attempt to measure more than 2000 $\mu A$ .

Features:



### DC Microamps Measurement - Test lead input

Range	Resolution	Accuracy	Overload Protection
600 $\mu A$	0.1 $\mu A$	$\pm 1.2\% + 3\text{dpts}$	600V RMS
2000 $\mu A$	1 $\mu A$		

### AC Microamps Measurement - Test lead input

Range	Resolution	Accuracy	Overload Protection
600.0 $\mu A$	0.1 $\mu A$	$\pm 1.5\% + 3\text{dpts}$	600V RMS
2000 $\mu A$	1 $\mu A$		

45Hz to 400Hz True RMS

## Temperature Calibration

The new DL589 clamp meter offers a digital field temperature calibration procedure to make the process easier. Here are the steps.

- 1) Set dial position to "°F°C" and check T1 mode
- 2) Press and hold SELECT button for about 2 seconds
- 3) Press HOLD button while "FCAL" is displayed on top of the LCD to enter Field Calibration.
- 4) After immersing T1 temperature probe in ice bath and the temperature is stable, press and hold Hz/Duty button
- 5) Press SELECT button to switch to T2 mode.
- 6) After immersing T2 temperature probe in ice bath and temperature is stable, press and hold Hz/Duty button to complete Field Calibration

## Temperature F°/C°



**Temp**

- Default = T1
- Press SELECT x1 = T2
- Press SELECT x2 = T1 - T2
- Press and hold RANGE = °F or °C
- Readings show on lower display

**TEMP**

- Disconnect test lead probes from voltage source and meter.
- Move Input Jack Locks to "TEMP" setting.
- Use K-Type thermocouple temperature probes only.
- Stated accuracy does not account for thermocouple accuracy.

Features:



SELECT

MIN/MAX

Range	Resolution	Accuracy	Overload Protection
-328°F to 999°F (-200°C to 999°C)	0.1°F (0.1°C)	±(1.0% + 3.6°F) ±(1.0% + 2.0°C)	30V RMS
1000°F to 2462°F (1000°C to 1350°C)	1°F (1°C)	±(1.0% + 3°F) ±(1.0% + 2°C)	

## Continuity



- Default =  $\Omega$
- Press SELECT x1 = 

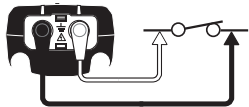

- Buzzer sounds at less than  $< 40\Omega$ .

### WARNING

- Do not measure resistance on a live circuit.

Features:



SELECT

MIN/MAX

Open Circuit V $< 1.00V$	Overload Protection
Threshold Approx. $< 40\Omega$	600V RMS

## Resistance: < 60M $\Omega$



- Default =  $\Omega$
- Press RANGE to select resolution

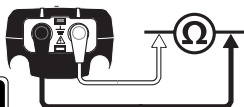

Features:



### ⚠ WARNING

- Do not measure resistance on a live circuit.

Range	Resolution	Accuracy	Overload Protection
600.0 $\Omega$	0.1 $\Omega$	$\pm 0.8\% + 3\text{dpts}$	600V RMS
6.000k $\Omega$	0.001k $\Omega$		
60.00k $\Omega$	0.01k $\Omega$		
600.0k $\Omega$	0.1k $\Omega$		
6.000M $\Omega$	0.001M $\Omega$	$\pm 1.2\% + 3\text{dpts}$	
60.00M $\Omega$	0.01M $\Omega$		

## Capacitance



- Default =  $\Omega$
- Press SELECT x3 =  $\text{C}$
- Press RANGE to select resolution

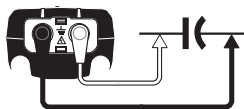

Features:



Range	Resolution	Accuracy	Overload Protection
10.00nF	0.01nF	$3.0\% + 5\text{dpts}$	600V RMS
100.0nF	0.1nF		
1.000 $\mu$ F	0.001 $\mu$ F		
10.00 $\mu$ F	0.01 $\mu$ F		
100.0 $\mu$ F	0.1 $\mu$ F		
2000 $\mu$ F	1 $\mu$ F		

⚠ **WARNING** To avoid damaging the meter or equipment under test, safely discharge Capacitors before measuring capacitance. Large value capacitors should be discharged through an appropriate resistance load. Use the DC Voltage function to confirm the capacitor discharge.

## GOOD DIODE

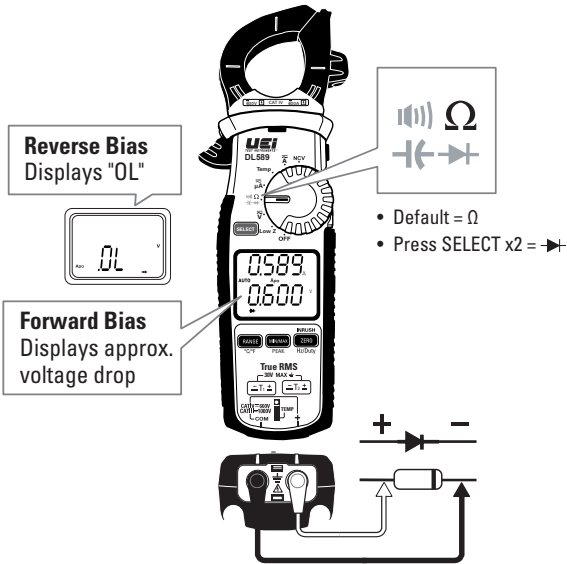

## BAD DIODE

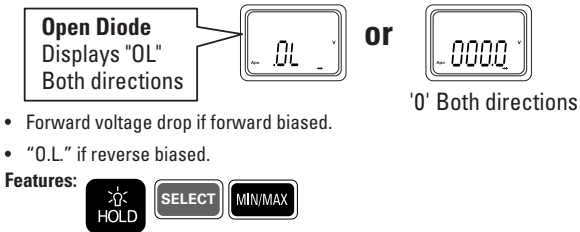

### Diode Test

Range	Open Circuit V	Test Current	Overload Protection
3.0V	< 3.2V DC	0.25mA	600V RMS

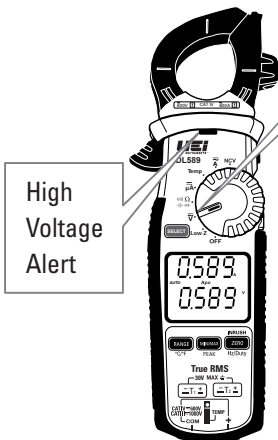

- Default =  $\tilde{V}$
- Press SELECT =  $\bar{V}$
- Press RANGE to select resolution



**WARNING**

- Use CATIII rated test leads or higher.
- Do not attempt to measure more than 750V AC/1000V DC.
- Keep hands below line when measuring high current levels.
- Select AC or DC Voltage.

**WARNING**

- High Voltage indicator will display and audible alert will sound over 600V AC/DC
- AC/DC and High Voltage indicator will display (without audible alert) over 30V AC/DC

Features:



**AC Volts**

Range	Resolution	Accuracy	Overload Protection
600.0mV	0.1mV	±1.0% + 3dpts	1000V RMS
6.000V	0.001V		
60.00V	0.01V		
600.0V	0.1V		
750V	1V		

True RMS: 45Hz to 400Hz

**DC Volts**

Range	Resolution	Accuracy	Overload Protection
600.0mV	0.1mV	±0.5% + 4dpts	1000V RMS
6.000V	0.001V		
60.00V	0.01V		
600.0V	0.1V		
1000V	1V	±0.8% + 5dpts	

## Frequency (Hz) / Duty Cycle



- Default =  $\tilde{V}$
- Press and hold ZERO x1 = Hz
- Press and hold ZERO x2 = %
- Press RANGE to select resolution

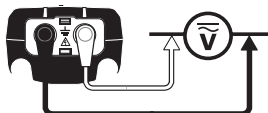

**⚠ Use CAT III rated leads or higher.**

Press the SELECT button to select AC voltage, press and hold the button for Frequency and Duty Cycle modes.

**⚠ WARNING**

Do not attempt to measure more than 750V AC/1000V DC.

Features:



### Frequency Measurement - Test lead input

Range	Resolution	Accuracy	Overload Protection
99.99Hz	0.01Hz	0.1% + 3dgts	1000V RMS
999.9Hz	0.1Hz		
9.999kHz	0.001kHz		
99.99kHz	0.01kHz		

Sensitivity: 1.8Vrms

### Duty Cycle - Test lead input

Range	Accuracy	Overload Protection
1.0 to 99.0%	$\pm(0.2\% \text{ per kHz} + 0.1\% + 5 \text{ dgts})$	1000V RMS



## LRA Inrush

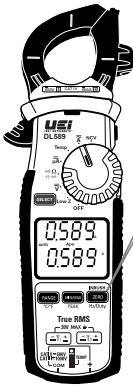

INRUSH

ZERO

- Default =  $\tilde{A}$
- Press ZERO = Inrush
- Readings show on upper display

The UEi LRA Inrush is programmed to properly capture the starting current for compressor motors.

- Select AC Amps.
- Select the range capable of capturing the maximum value.
- Press the ZERO button – INRUSH will now be shown on the screen.
- Activate the compressor and read value on the display.
- Press the Zero button to return to live readings.

## Zero DC Amps

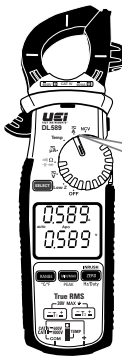

$\tilde{A}$

- Default =  $\tilde{A}$
- Press SELECT =  $\overline{\tilde{A}}$
- Press ZERO = DC Amps Zero

Select DC current.

- Press to zero any offset in Amps DC.
- Used to monitor change from present displayed value.
- Required during DC Amps measurement to establish a zero level.

**⚠ WARNING**

Do not use DC Zero mode at amps greater than 600A DC.

## Test Lead Notes

### Cat IV and CAT II Measurement Locations

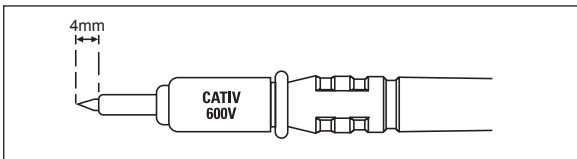

- Ensure the test lead shield is pressed firmly in place. Failure to use the CAT IV shield increases arc-flash risk.

### CAT II Measurement Locations

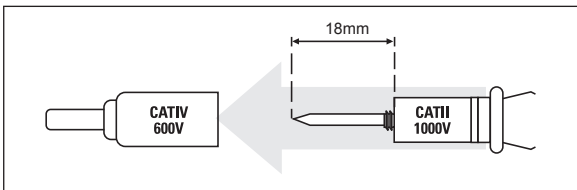

- CAT IV shields may be removed for CAT II locations. This will allow testing on recessed conductors such as standard wall outlets. Take care not to lose the shields.

**⚠ WARNING:** Test Lead category protections apply only to test leads and should not be confused with the meter's specific CAT rating. Observe the maximum category protection indicated on the meter the test leads are plugged into.

**⚠ CAUTION:** If the test leads need to be replaced, you must use a new one which should meet EN 61010-031 standard, rated CAT III 1000V or better.

**NOTE:** DL589 works with UEi ATL58 test leads and AAC3 alligator clips.

## Battery Replacement

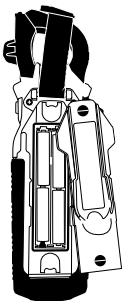

- Rotate Battery Compartment Latches to open position 
- Remove battery cover
- Replace the old batteries with 4 new (AAA) batteries
- Replace the battery cover
- Rotate Battery Compartment Latches to lock 



## Warranty

The DL589 is warranted to be free from defects in materials and workmanship for a period of 2 years from the date of purchase. If within the warranty period your instrument should become inoperative from such defects, the unit will be repaired or replaced at UEi's option. This warranty covers normal use and does not cover damage which occurs in shipment or failure which results from alteration, tampering, accident, misuse, abuse, neglect or improper maintenance. Batteries and consequential damage resulting from failed batteries are not covered by warranty.

Any implied warranties, including but not limited to implied warranties of merchantability and fitness for a particular purpose, are limited to the express warranty. UEi shall not be liable for loss of use of the instrument or other incidental or consequential damages, expenses, or economic loss, or for any claim or claims for such damage, expenses or economic loss.

Warranty only covers hardware and does not extend to software applications.

A purchase receipt or other proof of original purchase date will be required before warranty repairs will be rendered. Instruments out of warranty will be repaired (when repairable) for a service charge.

For more information on warranty and service, contact:

**www.ueitest.com • Email: info@ueitest.com**  
**1-800-547-5740**

This warranty gives you specific legal rights. You may also have other rights, which vary from state to state.

## Disposal



**CAUTION:** This symbol indicates that equipment and its accessories shall be subject to separate collection and correct disposal.

## Cleaning

Periodically clean your meter's case using a damp cloth. DO NOT use abrasive, flammable liquids, cleaning solvents, or strong detergents as they may damage the finish, impair safety, or affect the reliability of the structural components.

## Storage

Remove the batteries when instrument is not in use for a prolonged period of time. Do not expose to high temperatures or humidity. After a period of storage in extreme conditions exceeding the limits mentioned in the General Specifications section, allow the instrument to return to normal operating conditions before using it.