**User's
Manual**

UTAdvanced.

**UTAdvanced Series
Communication Interface
(RS-485, Ethernet)
User's Manual**

IM 05P07A01-01EN

vigilantplant.®

Introduction

Thank you for purchasing the UTAdvanced Series digital indicating controller (hereinafter referred to as "UTAdvanced").

This manual describes how to use the communication functions (Ethernet and serial communication) of the UTAdvanced. Read this manual thoroughly beforehand to ensure correct use of the UTAdvanced.

Note that the manuals for the UTAdvanced comprise the following documents.

To use the UTAdvanced, you must have a sufficient knowledge of the communication specifications of the host computer that the UTAdvanced is connected to, communication hardware, the program language used for communication, and other communication-related information.

● Printed manual

Manual Name	Manual Number	Description
UT75A Operation Guide	IM 05P01B41-11EN	This manual describes the basic operation method.
UT55A/UT52A Operation Guide (for Standard model)	IM 05P01C31-11EN	This manual describes the basic operation method.
UT55A/UT52A Operation Guide (for Detailed model)	IM 05P01C31-15EN	This manual describes the basic operation method.
UT35A/UT32A Operation Guide (for Standard model)	IM 05P01D31-11EN	This manual describes the basic operation method.
UT35A/UT32A Operation Guide (for Detailed model)	IM 05P01D31-15EN	This manual describes the basic operation method.
UP55A Operation Guide (for Standard model)	IM 05P02C41-11EN	This manual describes the basic operation method.
UP55A Operation Guide (for Detailed model)	IM 05P02C41-15EN	This manual describes the basic operation method.
UP35A Operation Guide (for Standard model)	IM 05P02D41-11EN	This manual describes the basic operation method.
UP35A Operation Guide (for Detailed model)	IM 05P02D41-15EN	This manual describes the basic operation method.
UM33A Operation Guide	IM 05P03D21-11EN	This manual describes the basic operation method.
UT35A-L Operation Guide	IM 05P04D41-11EN	This manual describes the basic operation method.

● Electronic manuals

Manual Name	Manual Number	Description
UT75A Operation Guide	IM 05P01B41-11EN	This is identical to the printed manual.
UT55A/UT52A Operation Guide (for Standard model)	IM 05P01C31-11EN	This is identical to the printed manual.
UT55A/UT52A Operation Guide (for Detailed model)	IM 05P01C31-15EN	This is identical to the printed manual.
UT35A/UT32A Operation Guide (for Standard model)	IM 05P01D31-11EN	This is identical to the printed manual.
UT35A/UT32A Operation Guide (for Detailed model)	IM 05P01D31-15EN	This is identical to the printed manual.
UP55A Operation Guide (for Standard model)	IM 05P02C41-11EN	This is identical to the printed manual.
UP55A Operation Guide (for Detailed model)	IM 05P02C41-15EN	This is identical to the printed manual.
UP35A Operation Guide (for Standard model)	IM 05P02D41-11EN	This is identical to the printed manual.
UP35A Operation Guide (for Detailed model)	IM 05P02D41-15EN	This is identical to the printed manual.
UM33A Operation Guide	IM 05P03D21-11EN	This is identical to the printed manual.
UT35A-L Operation Guide	IM 05P04D41-11EN	This manual describes the basic operation method.
UT75A User's Manual	IM 05P01B41-01EN	This manual describes the usage of all functions except the ladder sequence and communication functions.
UT55A/UT52A User's Manual	IM 05P01C31-01EN	This manual describes the usage of all functions except the ladder sequence and communication functions.
UT35A/UT32A User's Manual	IM 05P01D31-01EN	This manual describes the usage of all functions except the ladder sequence and communication functions.
UP55A User's Manual	IM 05P02C41-01EN	This manual describes the usage of all functions except the ladder sequence and communication functions.

Manual Name	Manual Number	Description
UP35A User's Manual	IM 05P02D41-01EN	This manual describes the usage of all functions except the ladder sequence and communication functions.
UM33A User's Manual	IM 05P03D21-01EN	This manual describes the usage of all functions except the communication functions.
UT35A-L User's manual	IM 05P04D41-01EN	This manual describes the usage of all functions except the ladder sequence and communication functions.
UTAdvanced Series Communication Interface (RS-485, Ethernet) User's Manual	IM 05P07A01-01EN	This manual. It describes how to use the UTAdvanced in Ethernet and serial communications. For communication wiring, see the Operation Guide or User's Manual.
UTAdvanced Series Communication Interface (Open Network) User's Manual	IM 05P07A01-02EN	This manual describes how to use the UTAdvanced in PROFIBUS-DP/DeviceNet/CC-Link communication. For communication wiring, see the Operation Guide or User's Manual.
LL50A Parameter Setting Software Installation Manual	IM 05P05A01-01EN	This manual describes how to install and uninstall the LL50A.
LL50A Parameter Setting Software User's Manual	IM 05P05A01-02EN	This manual describes how to use the LL50A, ladder sequence function, peer-to-peer communication, and network profile creating function.

* User's Manual can be downloaded from a website.

Intended Readers

This manual is intended for people familiar with the functions of the UTAdvanced such as control engineers and personnel in charge of the maintenance of instrumentation and control equipment.

Notice

- The contents of this manual are subject to change without notice as a result of continuing improvements to the instrument's performance and functions.
- Every effort has been made to ensure accuracy in the preparation of this manual. Should any errors or omissions come to your attention, however, please inform Yokogawa Electric's sales office or sales representative.
- Under no circumstances may the contents of this manual, in part or in whole, be transcribed or copied without our permission.
- The document concerning TCP/IP software has been created by Yokogawa based on the BSD Networking Software, Release 1 that has been licensed from the University of California.

Trademarks

- Our product names or brand names mentioned in this manual are the trademarks or registered trademarks of Yokogawa Electric Corporation (hereinafter referred to as YOKOGAWA).
- Microsoft, MS-DOS, Windows, Windows XP, and Windows Vista are either registered trademarks or trademarks of Microsoft Corporation in the United States and/or other countries.
- Adobe, Acrobat, and Postscript are either registered trademarks or trademarks of Adobe Systems Incorporated.
- Ethernet is a registered trademark of XEROX Corporation in the United States.
- Modbus is a registered trademark of Schneider Electric.
- PROFIBUS-DP is a registered trademark of PROFIBUS User Organization.
- DeviceNet is a registered trademark of Open DeviceNet Vender Association, Inc.
- CC-Link is a registered trademark of CC-Link Partner Association (CLPA.)
- We do not use the TM or ® mark to indicate these trademarks or registered trademarks in this user's manual.
- All other product names mentioned in this user's manual are trademarks or registered trademarks of their respective companies.

Symbols Used in This Manual



This symbol is used on the instrument. It indicates the possibility of injury to the user or damage to the instrument, and signifies that the user must refer to the user's manual for special instructions. The same symbol is used in the user's manual on pages that the user needs to refer to, together with the term "WARNING" or "CAUTION."

WARNING

Calls attention to actions or conditions that could cause serious or fatal injury to the user, and indicates precautions that should be taken to prevent such occurrences.

CAUTION

Calls attention to actions or conditions that could cause injury to the user or damage to the instrument or property and indicates precautions that should be taken to prevent such occurrences.

Note

Identifies important information required to operate the instrument.



Indicates related operations or explanations for the user's reference.



Indicates a character string displayed on the display.

Setting Display

Indicates a setting display and describes the keystrokes required to display the relevant setting display.

Setting Details

Provides the descriptions of settings.

Description

Describes restrictions, etc. regarding a relevant operation.

How to Use This Manual

Usage

First read through the [Operation Guide](#) to understand the basic operation and then read this manual.

This user's manual is organized into Chapters 1 to 13 as shown below.

Chapter	Title and Description
1	Overview Describes types of communication and communication specifications.
2	Setting Communication Functions Describes communication parameter setting items.
3	Description of RS-485 Communication (for UTAdvanced with RS-485 Communication) Describes how to use Modbus communication, PC link communication, and ladder communication.
4	Description of Ethernet Communication (Modbus/TCP) (for UTAdvanced with Ethernet Communication) Describes how to use Ethernet communication.
5	Description of Coordinated Operation Describes how to use coordinated operation.
6	Functions and Applications of D Registers (for UT55A/UT52A/UP55A) Provides a map of D registers.
7	Functions and Applications of I Relays (for UT55A/UT52A/UP55A) Provides a map of I relays.
8	Functions and Applications of D Registers (for UT35A/UT32A/UP35A) Provides a map of D registers.
9	Functions and Applications of I Relays (for UT35A/UT32A/UP35A) Provides a map of I relays.
10	Functions and Applications of D Registers (for UM33A) Provides a map of D registers.
11	Functions and Applications of I Relays (for UM33A) Provides a map of I relays.
12	Functions and Applications of D Registers (for UT35A-L) Provides a map of D registers.
13	Functions and Applications of I Relays (for UT35A-L) Provides a map of I relays.
14	Functions and Applications of D Registers (for UT75A) Provides a map of D registers.
15	Functions and Applications of I Relays (for UT75A) Provides a map of I relays.
Appendix	ASCII Code Table

Contents

Introduction	i
Intended Readers	ii
Notice	ii
Trademarks	ii
Symbols Used in This Manual	iii
How to Use This Manual.....	iv

Chapter 1 Overview

1.1	UTAdvanced Communication.....	1-1
1.2	RS-485 Communication (for UTAdvanced with RS-485 Communication).....	1-2
	1.2.1 Communication Specifications.....	1-2
1.3	Ethernet Communication (for UTAdvanced with Ethernet Communication).....	1-3
	1.3.1 Communication Specifications.....	1-3
1.4	Peer-to-peer Communication (for UTAdvanced with RS-485 Communication)	1-5
1.5	Coordinated Communication (for UTAdvanced with RS-485 Communication)	1-6
	1.5.1 Communication Specifications.....	1-6
1.6	D registers and I relays	1-7

Chapter 2 Setting Communication Functions

2.1	Setting Parameters.....	2-1
	2.1.1 Setting RS-485 Communication (for UTAdvanced with RS-485 communication)	2-1
	2.1.2 Setting Ethernet Communication (for UTAdvanced with Ethernet communication)	2-3
	2.1.3 Setting Coordinated Operation.....	2-5
2.2	Setting Communication Write Permit.....	2-6

Chapter 3 Description of RS-485 Communication (for UTAdvanced with RS-485 Communication)

3.1	Modbus Communication.....	3-1
	3.1.1 Overview	3-1
	3.1.2 Configuration of Messages.....	3-3
	3.1.3 Configuration of Responses (response from UTAdvanced).....	3-7
	3.1.4 Specifying Broadcast.....	3-8
	3.1.5 Messages and Responses.....	3-9
	■ 01 Reading multiple I relays	3-10
	■ 03 Reading multiple D registers	3-11
	■ 05 Writing to an I relay.....	3-12
	■ 06 Writing to a D register.....	3-12
	■ 08 Loopback test	3-13
	■ 15 Writing to multiple I relays	3-14
	■ 16 Writing to multiple D registers.....	3-15
	■ 66 Random reading.....	3-16
	■ 67 Random writing.....	3-17
	■ 68 Specify monitor.....	3-18
	■ 69 Monitoring.....	3-18
	■ 70 Writing to multiple D registers for program pattern.....	3-19
3.2	PC Link Communication.....	3-20
	3.2.1 Overview	3-20
	3.2.2 Configuration of Commands.....	3-21
	3.2.3 Configuration of Responses.....	3-23
	3.2.4 Response Error Codes.....	3-24
	3.2.5 Specifying Broadcast.....	3-25

3.2.6	Commands and Responses	3-26
■	BRD Reading I relays on a bit-by-bit basis	3-27
■	BWR Writing data into I relays on a bit-by-bit basis	3-27
■	BRR Reading I relays on a bit-by-bit basis in a random order	3-28
■	BRW Writing data into I relays on a bit-by-bit basis in a random order	3-28
■	BRS Specifying I relays to be monitored on a bit-by-bit basis	3-29
■	BRM Monitoring I relays on a bit-by-bit basis	3-29
■	WRD Reading D registers and I relays on a word-by-word basis	3-30
■	WWR Writing data into D registers and I relays on a word-by-word basis	3-30
■	WRR Reading D registers and I relays on a word-by-word basis in random order	3-31
■	WRW Writing data into D registers and I relays on a word-by-word basis in random order	3-31
■	WRS Specifying the D registers and I relays to be monitored on a word-by-word basis	3-32
■	WRM Monitoring the D registers and I relays on a word-by-word basis	3-32
■	INF6 Reading the model, suffix code, and version information	3-33
■	INF7 Reading CPU maximum value	3-39
3.2.7	Communication with FA-M3	3-40
3.3	Ladder Communication	3-41
3.3.1	Overview	3-41
3.3.2	Configuration of Commands	3-42
3.3.3	Configuration of Responses	3-43
3.3.4	Communication with PLC	3-44
3.3.5	Response Error Codes	3-45

Chapter 4 Description of Ethernet Communication (Modbus/TCP) (for UTAdvanced with Ethernet Communication)

4.1	Overview	4-1
4.2	TCP/IP-based Communication	4-3
4.3	Configuration of Network Frames	4-4
4.3.1	Configuration of MBAP Header	4-4
4.3.2	Configuration of PDU	4-4
4.4	Communication with Host Computer	4-5
4.4.1	List of Function Codes	4-5
4.4.2	Specifying D Registers	4-5
4.4.3	Requests and Responses	4-6
■	01 Reading multiple I relays	4-6
■	03 Reading multiple D registers	4-6
■	05 Writing to an I relay	4-7
■	06 Writing to a D register	4-7
■	08 Loopback test	4-8
■	15 Writing to multiple I relays	4-9
■	16 Writing to multiple D registers	4-10
■	66 Random reading	4-11
■	67 Random writing	4-11
■	68 Specify monitor	4-12
■	69 Monitoring	4-12
■	70 Writing to multiple D registers for program pattern	4-13
4.4.4	Response Error Codes	4-14
4.5	Ethernet-Serial Gateway Function	4-15
4.5.1	Overview	4-15
4.5.2	Wiring for Communication with Serial Devices	4-16
4.6	Process Data High-speed Response Function	4-17
4.6.1	Overview	4-17
4.6.2	How to Set the Function	4-18
4.6.3	Process Data for High-speed Response	4-19
4.7	IP Access Restriction Function	4-20

Chapter 5 Coordinated Operation

5.1	Overview	5-1
5.2	Coordinated Items	5-2
5.3	Starting Coordinated Operation	5-4

Chapter 6 Functions and Applications of D Registers (for UT55A/UT52A/UP55A)

6.1	Overview	6-1
6.2	Conventions Used in D Register Tables	6-2
6.3	Classification of D Registers	6-3
6.4	UT55A/UT52A/UP55A D Registers	6-5
6.4.1	Process Monitoring and Program Pattern for UP55A (D2001 to D2300)	6-5
	Process Data Area	6-9
	Process Data (D2001 to D2100)	6-9
	Current SP Group and PID Group (D2101 to D2200)	6-19
	Local-mode Operation Setting for UP55A (D2201 to D2300)	6-21
6.4.2	Loop-1 / Loop-2 Operation Mode Parameter and Loop-1 / Loop-2 Operation Parameter for UP55A (D2301 to D2500)	6-22
	Loop-1 / Loop-2 Operation Mode and Loop-1 / Loop-2 Alarm Setpoint Setting for UP55A (D2301 to D2400)	6-24
	Free Area (D2401 to D2500)	6-25
6.4.3	Loop-1 Operation Parameter (D2501 to D3600)	6-26
	Loop-1 SP and Alarm Setpoint Setting of Groups 1 to 8 (D2501 to D2700)	6-37
	Loop-1 SP-related Setting (D2701 to D2800)	6-38
	Loop-1 Alarm Function Setting (D2801 to D2900)	6-39
	Loop-1 PV-related Setting (D2901 to D3000)	6-40
	Loop-1 PID Setting of Groups 1 to 8 and R (D3001 to D3500)	6-41
	Loop-1 Control Action-related Setting (D3501 to D3600)	6-43
6.4.4	Loop-2 Operation Parameter (D3601 to D4700)	6-45
	Loop-2 SP and Alarm Setpoint Setting of Groups 1 to 8 (D3601 to D3800)	6-56
	Loop-2 SP-related Setting (D3801 to D3900)	6-57
	Loop-2 Alarm Function Setting (D3901 to D4000)	6-58
	Loop-2 PV-related Setting (D4001 to D4100)	6-59
	Loop-2 PID Setting of Groups 1 to 8 and R (D4101 to D4600)	6-60
	Loop-2 Control Action-related Setting (D4601 to D4700)	6-62
6.4.5	P Parameter (D4701 to D4800)	6-63
	P parameter (D4701 to D4800)	6-64
6.4.6	10-segment Linearizer Setting Parameter (D4801 to D5000)	6-65
6.4.7	Setup Parameters (D5001 to D7000)	6-68
	Control Function Setting (D5001 to D5100)	6-83
	Input Setting (D5101 to D5300)	6-85
	Output Setting (D5301 to D5400)	6-88
	Heater Break Alarm Setting (D5401 to D5500)	6-91
	Communication Setting (D5501 to D5700)	6-92
	Key Operation Setting, Display Function Setting, and SELECT Display Setting (D5701 to D5800)	6-95
	Lock Setting (Key Lock/Menu Lock) (D5801 to D5900)	6-100
	DI Function Setting (D5901 to D6200)	6-102
	DO Function Setting (D6201 to D6300)	6-104
	I/O Display (D6301 to D6400)	6-108
	System Setting (D6401 to D6500)	6-109
	Free Area (D6501 to D7000)	6-109
6.4.8	Registers for Ladder Program (D7001 to D7600)	6-110
	For Input Ladder Calculation (D7001 to D7100)	6-116
	For Output Ladder Calculation (D7101 to D7200)	6-118

	Status Registers (D7201 to D7300)	6-120
	Constant Register (D7301 to D7500).....	6-122
	Input Range / Scale (D7501 to D7600) (Read only)	6-122
6.4.9	Input / Output Terminal Status Register (D7601 to D7700).....	6-124
6.4.10	Program Pattern for UP55A (D8001 to D9000).....	6-128
	Pattern Data Setting (D8001 to D8100)	6-128
	Reading Pattern Data (D8001 to D8100)	6-129
	Writing Pattern Data (D8001 to D8100)	6-130
	Segment Data Setting (D8101 to D8200).....	6-131
	Reading Segment Data (D8101 to D8200)	6-134
	Writing Segment Data (D8101 to D8200).....	6-135
	Loop-1 Final Target Setpoint Setting for Batch Writing (D8201 to D8400).....	6-136
	Final Target Setpoint of Program Pattern-2 Retransmission for Batch Writing (D8401 to D8600)	6-138
	Segment Time Setting for Batch Writing (D8601 to D8800).....	6-140
	Segment Ramp-Rate Setting for Batch Writing (D8801 to D9000)	6-142
	Reading Data (Multiple Segment Data) (D8201 to D8953).....	6-144
	Writing Data (Multiple Segment Data) (D8201 to D8953)	6-145
	Used Pattern Numbers and the Number of Remaining Unused Segments (D8961 to D8963).....	6-146
	Check the Number of Segments, Copy and Clear of Program Pattern (D8971 to D8993).....	6-147
	Error Information	6-149
6.5	Writing via Communication.....	6-150
6.6	GREEN Series Compatible D Registers	6-152
	6.6.1 Compatibility with GREEN Series Controllers	6-152
	6.6.2 Interpretation of D Register Tables.....	6-152
	6.6.3 Process Data and User Area (D0001 to D0100).....	6-154
	6.6.4 Operation Mode and Operation-related Parameters (D0201 to D0300).....	6-156
	6.6.5 Loop-1 PID Parameters (D0301 to D0500).....	6-157
	6.6.6 Loop-2 PID Parameters (D0501 to D0700).....	6-159
	6.6.7 User Parameters and 10-segment Linearizer Parameters (D0701 to D0800).....	6-161
	6.6.8 Message (D0801 to D0900).....	6-162
	6.6.9 Control Action Parameters (D0901 to D1000).....	6-163
	6.6.10 Common Function Parameters (D1001 to D1100).....	6-164
	6.6.11 Display and Input / Output Parameters (D1101 to D1200).....	6-165
	6.6.12 Control Mode, PV Input, and Control Output Parameters (D1201 to D1300)	6-166
	6.6.13 D Registers Converted for GREEN Series.....	6-167
	6.6.14 D Registers Differing in Content from GREEN Series	6-172
	6.6.15 D Registers Differing Depending on Conditions.....	6-179

Chapter 7 Functions and Applications of I Relays (for UT55A/UT52A/UP55A)

7.1	Overview	7-1
7.2	Classification of I Relays	7-2
7.3	UT55A/UT52A/UP55A I Relays.....	7-4
	7.3.1 Function Status (4001 to 5024).....	7-4
	System Error, Input Error, and Operation Mode (4001 to 4320)	7-11
	Alarm, Alarm Latch, and Heater Break Alarm (4321 to 4576).....	7-12
	SP Number, PID Number, Pattern Number and Segment Number (4577 to 4704)	7-13
	Key (4705 to 4768).....	7-13
	Display, PV Event Status and Time Event Status (4769 to 5024).....	7-14
	Pattern Number Status and Segment Number Status (4849 to 5024).....	7-14
	7.3.2 Status for Ladder Program (5025 to 5664).....	7-15
	Input (Status) Relay and Output (Status) Relay (5025 to 5280)	7-24
	Control (Status) Relay (5281 to 5408).....	7-24
	Special Relay (5409 to 5536).....	7-24
	Internal Relay (5537 to 5792).....	7-25
	Peer-to-peer Communication Register (6049 to 6304)	7-25

7.3.3	Input / Output Terminal Status (6305 to 6560)	7-26
	DI Terminals and DO Terminals (6305 to 6560)	7-29
7.4	Reading via Communication	7-30
7.5	GREEN Series Compatible I Relays	7-31
7.5.1	Compatibility with GREEN Series Controllers	7-31
7.5.2	Conventions Used in I Relay Tables	7-31
7.5.3	Status (0001 to 0192)	7-32
7.5.4	SP Number, PID Number, and Status (0577 to 0720)	7-36
7.5.5	User Area (0721 to 2048)	7-39

Chapter 8 Functions and Applications of D Registers (for UT35A/UT32A/UP35A)

8.1	Overview	8-1
8.2	Conventions Used in D Register Tables	8-2
8.3	Classification of D Registers	8-3
8.4	UT35A/UT32A/UP35A D Registers	8-5
8.4.1	Process Monitoring and Program Pattern for UP35A (D2001 to D2300)	8-5
	Process Data Area	8-9
	Process Data (D2001 to D2100)	8-9
	Current SP Group and PID Group (D2101 to D2200)	8-15
	Local-mode Operation Setting for UP35A (D2201 to D2300)	8-16
8.4.2	Operation Mode Parameter and Operation Parameter for UP35A (D2301 to D2500)	8-17
	Operation Mode and Alarm Setpoint Setting for UP35A (D2301 to D2400)	8-18
	Free Area (D2401 to D2500)	8-19
8.4.3	Operation Parameter (D2501 to D4700)	8-20
	SP and Alarm Setpoint Setting of Groups 1 to 4 (D2501 to D2700)	8-28
	SP-related Setting (D2701 to D2800)	8-28
	Alarm Function Setting (D2801 to D2900)	8-29
	PV-related Setting (D2901 to D3000)	8-30
	PID Setting of Groups 1 to 4 and R (D3001 to D3500)	8-31
	Control Action-related Setting (D3501 to D3600)	8-33
	Free Area (D3601 to D4700)	8-34
8.4.4	P Parameter (D4701 to D4800)	8-35
	P parameter (D4701 to D4800)	8-36
	Free Area (D4801 to D5000)	8-36
8.4.5	Setup Parameters (D5001 to D7000)	8-37
	Control Function Setting (D5001 to D5100)	8-52
	Input Setting (D5101 to D5300)	8-53
	Output Setting (D5301 to D5400)	8-54
	Heater Break Alarm Setting (D5401 to D5500)	8-56
	Communication Setting (D5501 to D5700)	8-57
	Key Operation Setting, Display Function Setting, and SELECT Display Setting (D5701 to D5800)	8-60
	Lock Setting (Key Lock/Menu Lock) (D5801 to D5900)	8-64
	DI Function Setting (D5901 to D6200)	8-66
	I/O Display (D6301 to D6400)	8-71
	System Setting (D6401 to D6500)	8-72
	Free Area (D6501 to D7000)	8-72
8.4.6	Registers for Ladder Program (D7001 to D7600)	8-73
	For Input Ladder Calculation (D7001 to D7100)	8-79
	For Output Ladder Calculation (D7101 to D7200)	8-80
	Status Registers (D7201 to D7300)	8-82
	Constant Register (D7301 to D7500)	8-84
	Input Range / Scale (D7501 to D7600) (Read only)	8-84
8.4.7	Input / Output Terminal Status Register (D7601 to D7700)	8-85
8.4.8	Program Pattern for UP35A (D8001 to D9000)	8-88
	Pattern Data Setting (D8001 to D8100)	8-88



	Reading Pattern Data (D8001 to D8100)	8-89
	Writing Pattern Data (D8001 to D8100)	8-90
	Segment Data Setting (D8101 to D8200).....	8-91
	Reading Segment Data (D8101 to D8200)	8-93
	Writing Segment Data (D8101 to D8200).....	8-94
	Final Target Setpoint Setting for Batch Writing (D8201 to D8300).....	8-95
	Segment Time Setting for Batch Writing (D8601 to D8700).....	8-96
	Segment Ramp-Rate Setting for Batch Writing (D8801 to D9000).....	8-97
	Reading Data (Multiple Segment Data) (D8201 to D8953).....	8-98
	Writing Data (Multiple Segment Data) (D8201 to D8953).....	8-99
	Used Pattern Numbers and the Number of Remaining Unused Segments (D8961 to D8963).....	8-100
	Check the Number of Segments, Copy and Clear of Program Pattern (D8971 to D8993).....	8-101
	Error Information	8-103
8.5	Writing via Communication.....	8-104
8.6	GREEN Series Compatible D Registers	8-105
8.6.1	Compatibility with GREEN Series Controllers.....	8-105
8.6.2	Interpretation of D Register Tables.....	8-105
8.6.3	Process Data and User Area (D0001 to D0100).....	8-107
8.6.4	Operation Mode and Operation-related Parameters (D0201 to D0300).....	8-109
8.6.5	PID Parameters (D0301 to D0500).....	8-110
8.6.6	Control Action Parameters (D0901 to D1000).....	8-112
8.6.7	Common Function Parameters (D1001 to D1100).....	8-113
8.6.8	Display and Input / Output Parameters (D1101 to D1200).....	8-114
8.6.9	Control Mode, PV Input, and Control Output Parameters (D1201 to D1300).....	8-115
8.6.10	D Registers Converted for GREEN Series.....	8-116
8.6.11	D Registers Differing in Content from GREEN Series	8-120
8.6.12	D Registers Differing Depending on Conditions.....	8-122

Chapter 9 Functions and Applications of I Relays (for UT35A/UT32A/UP35A)

9.1	Overview	9-1
9.2	Classification of I Relays	9-2
9.3	UT35A/UT32A/UP35A I Relays.....	9-4
9.3.1	Function Status (4001 to 5024).....	9-4
	System Error, Input Error, and Operation Mode (4001 to 4320)	9-11
	Alarm, Alarm Latch and Heater Break Alarm (4321 to 4576).....	9-12
	SP Number and PID Number (4577 to 4704).....	9-12
	Key (4705 to 4768).....	9-13
	Display, PV Event Status and Time Event Status (4769 to 5024).....	9-13
	Pattern Number Status and Segment Number Status (4849 to 5024).....	9-13
9.3.2	Status for Ladder Program (5025 to 5664).....	9-14
	Input (Status) Relay and Output (Status) Relay (5025 to 5280)	9-23
	Control (Status) Relay (5281 to 5408).....	9-23
	Special Relay (5409 to 5536).....	9-23
	Internal Relay (5537 to 5792).....	9-24
	Peer-to-peer Communication Register (6049 to 6304)	9-24
9.3.3	Input / Output Terminal Status (6305 to 6560)	9-25
	DI Terminals and DO Terminals (6305 to 6560)	9-28
9.4	Reading via Communication	9-29
9.5	GREEN Series Compatible I Relays	9-30
9.5.1	Compatibility with GREEN Series Controllers.....	9-30
9.5.2	Conventions Used in I Relay Tables.....	9-30
9.5.3	Status (0001 to 0192).....	9-31
9.5.4	User Area (0721 to 784).....	9-34

Chapter 10 Functions and Applications of D Registers (for UM33A)

10.1	Overview	10-1
10.2	Conventions Used in D Register Tables	10-2
10.3	Classification of D Registers	10-3
10.4	UM33A D Registers	10-5
10.4.1	Process Monitoring (D2001 to D2300)	10-5
	Process Data Area	10-6
	Process Data (D2001 to D2100)	10-6
	Free Area (D2101 to D2300)	10-9
10.4.2	Operation Parameter (D2301 to D3000)	10-10
	Alarm Setpoint Setting (D2301 to D2400)	10-13
	Free Area (D2401 to D2800)	10-13
	Alarm Function Setting (D2801 to D2900)	10-14
	PV-related Setting (D2901 to D3000)	10-15
	Free Area (D3001 to D4800)	10-15
10.4.3	10-segment Linearizer Setting Parameter (D4801 to D4900)	10-16
	10-segment Linearizer Setting (D4801 to D4900)	10-17
	Free Area (D4901 to D5000)	10-17
10.4.4	Setup Parameters (D5001 to D6500)	10-18
	Function Setting (D5001 to D5100)	10-31
	Input Setting (D5101 to D5300)	10-32
	Output Setting (D5301 to D5400)	10-33
	Free Area (D5401 to D5500)	10-33
	Communication Setting (D5501 to D5700)	10-34
	Key Operation Setting, Display Function Setting, and SELECT Display Setting (D5701 to D5800)	10-35
	Lock Setting (Key Lock/Menu Lock) (D5801 to D5900)	10-37
	DI Function Setting (D5901 to D6200)	10-38
	DO Function Setting (D6201 to D6300)	10-39
	I/O Display (D6301 to D6400)	10-40
	System Setting (D6401 to D6500)	10-40
	Free Area (D6501 to D7600)	10-40
10.4.5	Input / Output Terminal Status Register (D7601 to D7700)	10-41
10.5	Writing via Communication	10-43
10.6	GREEN Series Compatible D Registers	10-44
10.6.1	Compatibility with GREEN Series Controllers	10-44
10.6.2	Interpretation of D Register Tables	10-44
10.6.3	Process Data and User Area (D0001 to D0100)	10-46
10.6.4	Operation-related Parameters (D0201 to D0300)	10-48
10.6.5	Alarm Function Parameters (D0901 to D1000)	10-49
10.6.6	Common Function Parameters (D1001 to D1100)	10-50
10.6.7	SELECT Display Setting Parameters (D1101 to D1200)	10-51
10.6.8	PV Input, and Communication Parameters (D1201 to D1300)	10-52
10.6.9	D Registers Converted for GREEN Series	10-53
10.6.10	D Registers Differing in Content from GREEN Series	10-54

Chapter 11 Functions and Applications of I Relays (for UM33A)

11.1	Overview	11-1
11.2	Classification of I Relays	11-2
11.3	UM33A I Relays	11-4
11.3.1	Function Status (4001 to 5024)	11-4
	System Error, Input Error, and Operation Mode (4001 to 4320)	11-10
	Alarm, Alarm Latch (4321 to 4576)	11-10
	Key (4705 to 4768)	11-10



	Display (4769 to 4832).....	11-10
11.3.2	Input / Output Status (5025 to 5472).....	11-11
	Input (Status) Relay and Output (Status) Relay (5025 to 5280)	11-14
11.3.3	Special Relay (5537 to 5792).....	11-15
	Special relay (5537 to 5792)	11-18
11.3.4	Input / Output Terminal Status (6305 to 6560)	11-19
	DI Terminals and DO Terminals (6305 to 6560)	11-22
11.4	Reading via Communication	11-23
11.5	GREEN Series Compatible I Relays	11-24
11.5.1	Compatibility with GREEN Series Controllers	11-24
11.5.2	Conventions Used in I Relay Tables.....	11-24
11.5.3	Status (0001 to 0192).....	11-25
11.5.4	User Area (0721 to 784).....	11-26

Chapter 12 Functions and Applications of D Registers (for UT35A-L)

12.1	Overview	12-1
12.2	Conventions Used in D Register Tables.....	12-2
12.3	Classification of D Registers	12-3
12.4	UT35A-L D Registers	12-5
12.4.1	Process Monitoring (D2001 to D2300).....	12-5
	Process Data Area	12-7
	Process Data (D2001 to D2100).....	12-7
	Current SP Group (D2101 to D2200).....	12-10
	Free Area (D2201 to D2500).....	12-10
12.4.2	Operation Parameter (D2501 to D4700).....	12-11
	SP and Alarm Setpoint Setting (D2501 to D2700)	12-15
	SP-related Setting (D2701 to D2800).....	12-15
	Alarm Function Setting (D2801 to D2900)	12-16
	PV-related Setting (D2901 to D3000).....	12-17
	Free Area (D3001 to D5000).....	12-17
12.4.3	Setup Parameters (D5001 to D7000).....	12-18
	Control Function Setting (D5001 to D5100).....	12-29
	Input Setting (D5101 to D5300).....	12-30
	Output Setting (D5301 to D5400).....	12-31
	Communication Setting (D5501 to D5700).....	12-32
	Key Operation Setting, Display Function Setting, and SELECT Display Setting (D5701 to D5800)	12-34
	Lock Setting (Key Lock/Menu Lock) (D5801 to D5900).....	12-35
	DI Function Setting (D5901 to D6200).....	12-36
	I/O Display (D6301 to D6400).....	12-38
	System Setting (D6401 to D6500).....	12-39
	Free Area (D6501 to D7000).....	12-39
12.4.4	Input / Output Terminal Status Register (D7601 to D7700).....	12-40
	Free Area (D7701 to D9000).....	12-41
12.5	GREEN Series Compatible D Registers	12-42
12.5.1	Compatibility with GREEN Series Controllers	12-42
12.5.2	Interpretation of D Register Tables.....	12-42
12.5.3	Process Data and User Area (D0001 to D0100).....	12-44
12.5.4	Operation Mode and Operation-related Parameters (D0201 to D0300)	12-45
12.5.5	SP Parameters (D0301 to D0500)	12-46
12.5.6	Control Action Parameters (D0901 to D1000).....	12-47
12.5.7	Common Function Parameters (D1001 to D1100).....	12-48
12.5.8	PV Input, and Limit Control Output Parameters (D1201 to D1300)	12-49
12.5.9	D Registers Converted for GREEN Series.....	12-50
12.5.10	D Registers Differing in Content from GREEN Series	12-52

Chapter 13 Functions and Applications of I Relays (for UT35A-L)

13.1	Overview	13-1
13.2	Classification of I Relays	13-2
13.3	UT35A-L I Relays	13-4
13.3.1	Function Status (4001 to 5024)	13-4
	System Error, Input Error, and Operation Mode (4001 to 4320)	13-10
	Alarm and Alarm Latch (4321 to 4576).....	13-10
	Key (4705 to 4768).....	13-10
	Display, PV Event Status and Time Event Status (4769 to 5024)	13-10
13.3.2	Status for Input/Output Relay	13-11
	Input (Status) Relay and Output (Status) Relay (5025 to 5280)	13-14
13.3.3	Input / Output Terminal Status (6305 to 6560)	13-15
	DI Terminals and DO Terminals (6305 to 6560)	13-18
13.4	Reading via Communication	13-19
13.5	GREEN Series Compatible I Relays	13-20
13.5.1	Compatibility with GREEN Series Controllers.....	13-20
13.5.2	Conventions Used in I Relay Tables.....	13-20
13.5.3	Status (0001 to 0192).....	13-21
13.5.4	User Area (0721 to 784).....	13-22

Chapter 14 Functions and Applications of D Registers (for UT75A)

14.1	Overview	14-1
14.2	Conventions Used in D Register Tables	14-2
14.3	Classification of D Registers	14-3
14.4	UT75A D Registers.....	14-5
14.4.1	Process Monitoring (D2001 to D2200).....	14-5
	Process Data Area	14-8
	Process Data (D2001 to D2100)	14-8
	Current SP Group and PID Group (D2101 to D2200).....	14-16
14.4.2	Loop-1 / Loop-2 Operation Mode Parameter (D2301 to D2500)	14-18
	Loop-1 / Loop-2 Operation Mode (D2301 to D2400)	14-19
14.4.3	Loop-1 Operation Parameter (D2501 to D3600).....	14-20
	Loop-1 SP and Alarm Setpoint Setting of Groups 1 to 8 (D2501 to D2700)	14-31
	Loop-1 SP-related Setting (D2701 to D2800)	14-32
	Loop-1 Alarm Function Setting (D2801 to D2900)	14-33
	Loop-1 PV-related Setting (D2901 to D3000)	14-34
	Loop-1 PID Setting of Groups 1 to 8 and R (D3001 to D3500).....	14-35
	Loop-1 Control Action-related Setting (D3501 to D3600).....	14-37
14.4.4	Loop-2 Operation Parameter/Custom Display Register (D3601 to D4700)	14-39
	Loop-2 SP and Alarm Setpoint Setting of Groups 1 to 8 (D3601 to D3800)	14-50
	Loop-2 SP-related Setting (D3801 to D3900)	14-51
	Loop-2 Alarm Function Setting (D3901 to D4000)	14-52
	Loop-2 PV-related Setting (D4001 to D4100)	14-53
	Loop-2 PID Setting of Groups 1 to 8 and R (D4101 to D4600).....	14-54
	Loop-2 Control Action-related Setting (D4601 to D4690).....	14-56
14.4.5	P Parameter (D4701 to D4800).....	14-57
	P parameter (D4701 to D4770).....	14-58
	P parameter (D4771 to D4800).....	14-59
14.4.6	10-segment Linearizer Setting Parameter (D4801 to D5000).....	14-60
	10-segment Linearizer Setting (D4801 to D5000).....	14-62
14.4.7	Setup Parameters (D5001 to D7000).....	14-63
	Control Function Setting (D5001 to D5100)	14-78
	Input Setting (D5101 to D5300).....	14-79
	Output Setting (D5301 to D5400).....	14-82



	Communication Setting (D5501 to D5700).....	14-86
	Key Operation Setting, Display Function Setting, and SELECT Display Setting (D5701 to D5800)	14-89
	Lock Setting (Key Lock/Menu Lock) (D5801 to D5900)	14-94
	DI Function Setting (D5901 to D6200)	14-96
	DO Function Setting (D6201 to D6300)	14-98
	I/O Display (D6301 to D6400)	14-100
	System Setting (D6401 to D6500).....	14-101
	Free Area (D6501 to D7000).....	14-101
	Custom Display Register (D6501 to D6686)	14-102
14.4.8	Registers for Ladder Program (D7001 to D7600)	14-103
	For Input Ladder Calculation (D7001 to D7100)	14-109
	For Output Ladder Calculation (D7101 to D7200)	14-110
	Status Registers (D7201 to D7300)	14-111
	Constant Register (D7301 to D7500).....	14-113
	Input Range / Scale (D7501 to D7600) (Read only)	14-113
14.4.9	Input / Output Terminal Status Register (D7601 to D7700).....	14-115
12.4.10	Program Pattern Parameters (D7701 to D7900)	14-118
	Program Pattern Setting (D7701 to D7900)	14-120
12.4.11	Loop-1/Loop-2 Operation Parameter (D9001 to D10000) Group 9 to 20	14-122
	Loop-1 SP and Alarm Setpoint Setting, Group 9 to 20 (D9001 to D9200)	14-132
	Loop-1 PID Setting, Group 9 to 20 (D9201 to D9500)	14-133
	Loop-2 SP and Alarm Setpoint Setting, Group 9 to 20 (D9501 to D9700)	14-134
	Loop-1 PID Setting, Group 9 to 20 (D9701 to D10000)	14-135
14.5	Writing via Communication.....	14-136
14.6	GREEN Series Compatible D Registers	14-138
14.6.1	Compatibility with GREEN Series Controllers	14-138
14.6.2	Interpretation of D Register Tables	14-138
14.6.3	Process Data and User Area (D0001 to D0100)	14-140
14.6.4	Operation Mode and Operation-related Parameters (D0201 to D0300)	14-141
6.6.5	Loop-1 PID Parameters (D0301 to D0500).....	14-142
14.6.6	Loop-2 PID Parameters (D0501 to D0700).....	14-144
14.6.7	User Parameters and 10-segment Linearizer Parameters (D0701 to D0800)	14-146
6.6.8	Message (D0801 to D0900)	14-147
14.6.9	Control Action Parameters (D0901 to D1000).....	14-148
14.6.10	Common Function Parameters (D1001 to D1100).....	14-149
14.6.11	Display and Input / Output Parameters (D1101 to D1200).....	14-150
14.6.12	Control Mode, PV Input, and Control Output Parameters (D1201 to D1300)	14-151
14.6.13	D Registers Converted for GREEN Series.....	14-152
14.6.14	D Registers Differing in Content from GREEN Series	14-156
14.6.15	D Registers Differing Depending on Conditions.....	14-163

Chapter 15 Functions and Applications of I Relays (for UT75A)

15.1	Overview	15-1
15.2	Classification of I Relays	15-2
15.3	UT75A I Relays	15-4
15.3.1	Function Status (4001 to 5024).....	15-4
	System Error, Input Error, and Operation Mode (4001 to 4320)	15-11
	Alarm and Alarm Latch (4321 to 4576).....	15-12
	SP Number, PID Number, Segment Number, and Program Operation Status (4577 to 4704).....	15-13
	Key (4705 to 4768).....	15-13
	Display and Program Segment (4769 to 5024).....	15-14
15.3.2	Status for Ladder Program (5025 to 5664).....	15-15
	Input (Status) Relay and Output (Status) Relay (5025 to 5280)	15-24
	Control (Status) Relay (5281 to 5408).....	15-24

Special Relay (5409 to 5536).....	15-24
Internal Relay (5537 to 5792).....	15-25
Peer-to-peer Communication Register (6049 to 6304)	15-25
15.3.3 Input / Output Terminal Status (6305 to 6560)	15-26
DI Terminals and DO Terminals (6305 to 6560)	15-29
15.4 Reading via Communication	15-30
15.5 GREEN Series Compatible I Relays	15-31
15.5.1 Compatibility with GREEN Series Controllers.....	15-31
15.5.2 Conventions Used in I Relay Tables.....	15-31
15.5.3 Status (0001 to 0192).....	15-32
7.5.4 SP Number, PID Number, and Status (0577 to 0720).....	15-34
15.5.5 User Area (0721 to 2048).....	15-35

Appendix ASCII Code Table

Revision Information

- 1**
- 2**
- 3**
- 4**
- 5**
- 6**
- 7**
- 8**
- 9**
- 10**
- 11**
- 12**
- 13**
- 14**
- 15**
- App.**

1.1 UTAdvanced Communication

The UTAdvanced communication supports RS-485 communication and Ethernet communication.

Three types of RS-485 communication are provided.

Host communication: Modbus communication, PC link communication, and ladder communication that enable centralized monitoring of the UTAdvanced by a host computer.

Coordinated operation: A system of coordinated operation is configured with a master controller and a number of slave controllers, all of which are UTAdvanced. The slave controllers are set to operate in the same way as the master controller.

Peer-to-peer communication: Enables sharing of data with other UTAdvanced by reading and writing peer-to-peer communication registers in the ladder program.

The UTAdvanced with Ethernet communication can be connected to IEEE802.3-compliant network (10BASE-T/100BASETX). A serial gateway function can increase the number of connected controllers.

► [Peer-to-peer communication: LL50A Parameter Setting Software User's Manual](#)

Communication function		Protocol	Connectable device	Terminal position	Suffix code	Remarks
RS-485 communication	RS-485 host communication	Modbus/RTU Modbus/ASCII	PC Touch panel			—
		PC link PC link (with checksum)	PCL (sequencer) The slave devices for Ethernet communication: UT75A/UT55A/UT35A/ UP55A/UP35A	UT75A/UT55A/UP55A: Rear terminals (E3 and E4-terminal areas)	UT75A/UT55A: Type 3 = 1, Type 2 = 1 or 2	—
		Ladder	PCL (sequencer)	UT52A/UT32A: Rear terminals (E1-terminal area)	UP55A: Type 3 = 1, Type 2 = 2	—
	Coordinated operation	Coordinated operation	UTAdvanced GREEN Series * (All models except for UM350/UM330/UM351/ UM331)	UT35A/UP35A: Rear terminals (E3-terminal area)	UT52A/UT32A/ UM33A: Type 2 = 1	—
	Peer-to-peer communication	Peer-to-peer communication	UTAdvanced (All models except for UM33A)	UM33A: Rear terminals (E1-terminal area)	UT35A/UP35A: Type 3 = 1	Configure the ladder sequence function using LL50A (sold separately)
Ethernet communication	Modbus/TCP	PC Touch panel PCL (sequencer)	Rear Ethernet terminal (E3-terminal area)	UT75A/UT55A/ UT35A/UP55A/ UP35A: Type 3 = 2	—	

*: GREEN Series controllers are the digital indicating controllers of YOKOGAWA.

► [Terminal position: UTAdvanced Operation Guide or User's Manual](#)

1.2 RS-485 Communication (for UTAdvanced with RS-485 Communication)

Four protocols are supported on the RS-485 interface: PC link communication protocol, Modbus/RTU communication protocol, Modbus/ASCII communication protocol, and ladder communication protocol.

RS-485 communication allows data to be collected from the UTAdvanced and data to be set on the UTAdvanced easily from a host computer.

1.2.1 Communication Specifications

	Communication specifications Host communication (PC link, Modbus, Ladder)
Communication interface	RS-485
Communication method	4-wire type half-duplex or 2-wire type half-duplex, asynchronous operation, non-procedural
Connection method	1:n multi-drop method (n = max. 31)
Communication distance	Max. 1200 m
Baud rate	600, 1200, 2400, 4800, 9600, 19200, 38400 bps * *: 38400 bps: UT75A/UT55A/UT35A/UP55A/UP35A; Only of suffix code Type 3 = 1 UT52A/UT32A/UM33A; Only of suffix code Type 2 = 1
Start bit	1 bits
Data length	Modbus communication (ASCII): Fixed at 7 bits Modbus communication (RTU): Fixed at 8 bits PC link communication: 7, 8 bits (with checksum / without checksum) Ladder communication: Fixed at 8 bits
Parity bit	NONE (none), EVEN (even), ODD (odd)
Stop bit	1, 2 bits

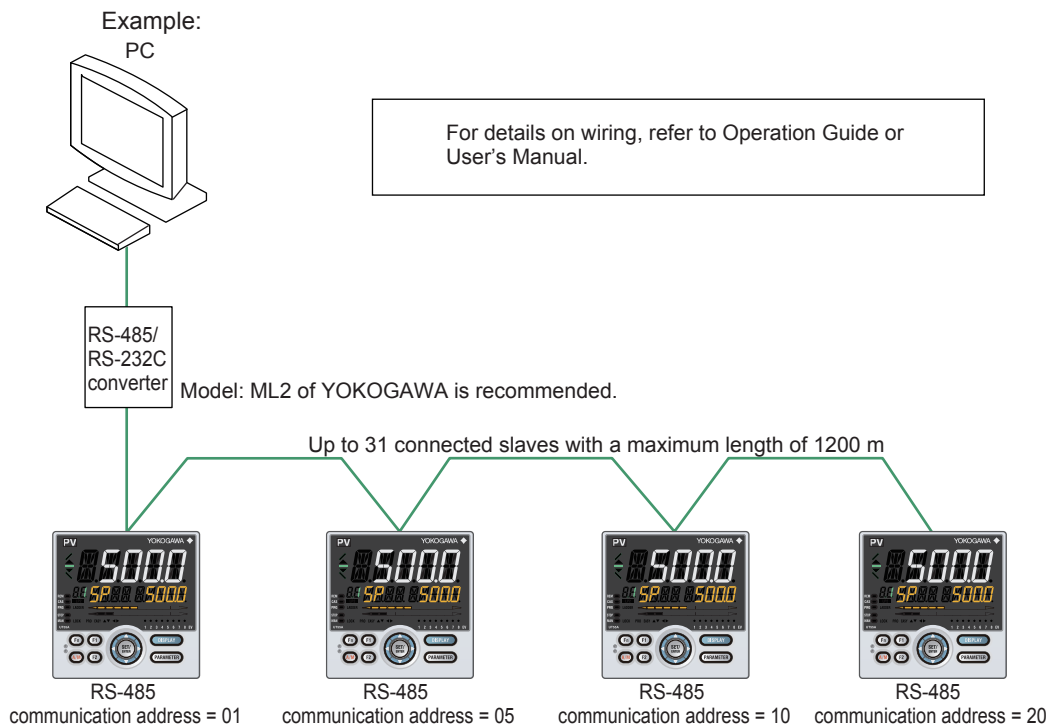

1.3 Ethernet Communication (for UTAdvanced with Ethernet Communication)

The UT55A/UT35A with Ethernet communication can be connected to an IEEE802.3-compliant network (10BASE-T/100BASE-TX) and are capable of exchanging data with host computers, such as personal computers or PLCs (sequencers), using the MODBUS/TCP protocol.

The UT55A/UT35A also has an RS-485 communication interface and the Ethernet-serial gateway function that relays the communication data received via network to the serial communication terminals. With this function, other serial communication devices not equipped with a network function can be connected to a network.

1.3.1 Communication Specifications

Ethernet Communication Interface Specification (the slave devices)

	Communication specifications
Standard	Ethernet IEEE802.3-compliant
Interface	RJ45 (10BASE-T/100BASE-TX)
Access control	CSMA/CD
Transmission speed	10 Mbps/100 Mbps
Maximum segment length	100 m (Note 1)
Maximum connecting configuration	Cascade Max. 4 stages (10BASE-T) Max. 2 stages (100BASE-TX) (Note 2)
Communication method	Modbus/TCP
Data type	Binary
Maximum number of connections	2
Port No.	502 (factory default), can be selected within the range of 1024 to 65535

Note 1: Distance from hub to UT75A/UT55A/UT35A

Note 2: Number of cascade connections on hub

RS-485 Communication Interface Specification (the master devices for serial gateway function)

	Communication specifications
Communication interface	RS-485
Communication method	2-wire type half-duplex, asynchronous operation, non-procedural
Connection method	1:n multi-drop method (n = max. 31)
Communication distance	Max. 1200 m
Baud rate	9600, 19200, 38400 bps
Protocol	Modbus/RTU
Start bit	1 bit
Data length	8 bits
Parity bit	NONE (none), EVEN (even), ODD (odd)
Stop bit	1 bit

Note

If you want to connect the UT75A/UT55A/UT35A/UP55A/UP35A to a network, you need to ensure consistency with the baud rate, connector, and the like. For details, consult with the administrator of the network to which to connect the UT75A/UT55A/UT35A/UP55A/UP35A.

1.3 Ethernet Communication (for UTAdvanced with Ethernet Communication)

Example: Ethernet Communication Connection

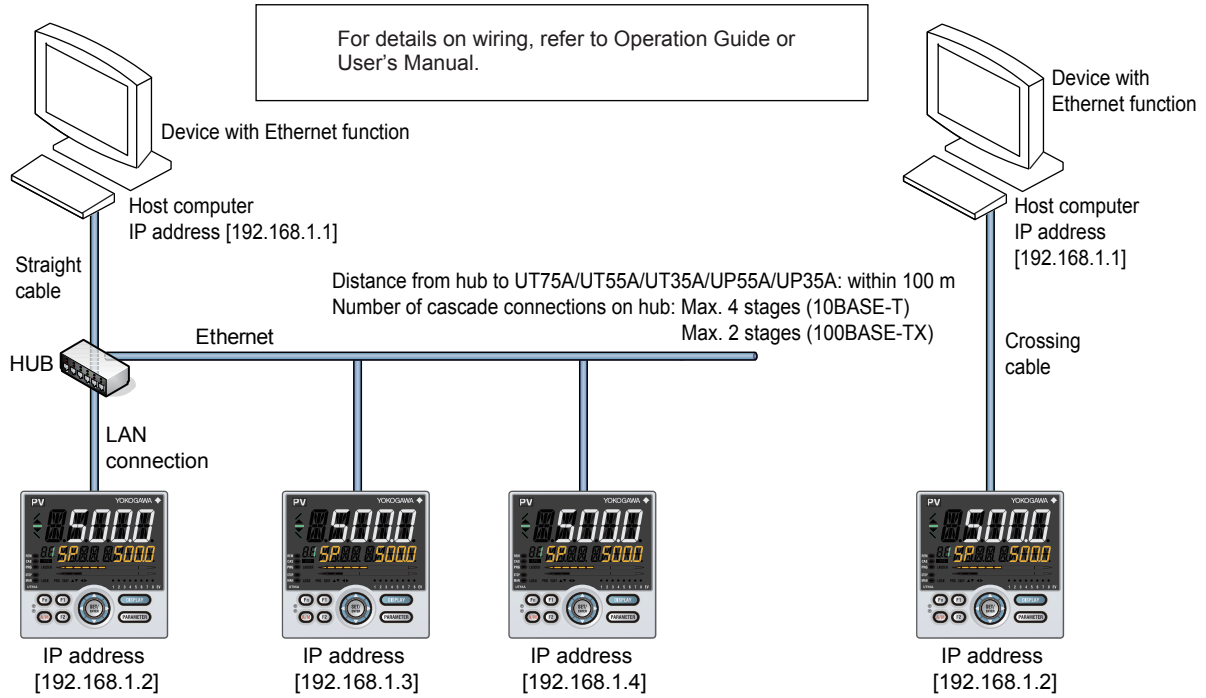

Example: Ethernet-serial Gateway Function Connection

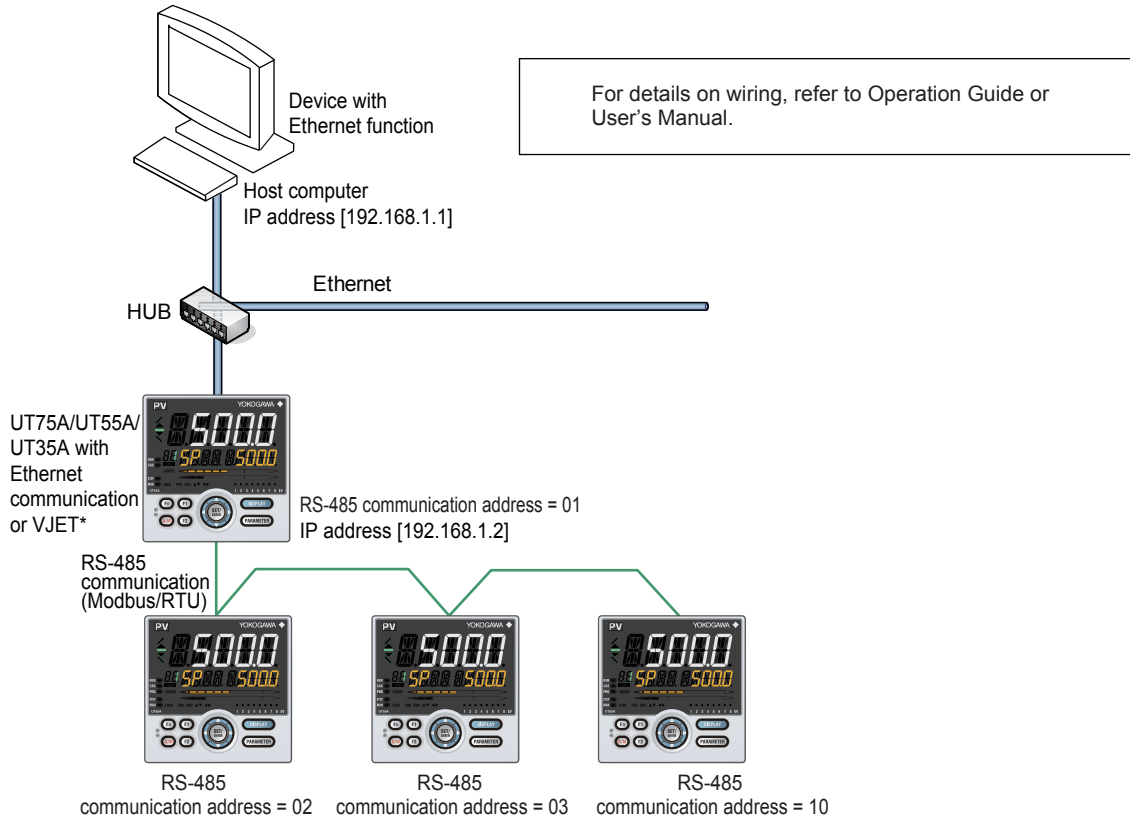

*: VJET is the converter of YOKOGAWA.
See VJET User's Manual when using the VJET.

1.4 Peer-to-peer Communication (for UTAdvanced with RS-485 Communication)

Peer-to-peer communication is a function which can be used in the ladder program of UTAdvanced and which allows sending and receiving data for computation control among devices via communication.

Peer-to-peer communication enables up to 32 UTAdvanced controllers to be connected. Of these UTAdvanced controllers, each of the units of address Nos. 1 to 4 can send 4 analog data and 16 flag data to other devices, and each of the units of address Nos. 1 to 32 can reference 4 analog data and 16 flag data of the units of address Nos. 1 to 4. These data can be used in the ladder program.

▶ [Peer-to-peer communication: LL50A Parameter Setting Software User's Manual](#)

Controller Nos.1 to 4 can transmit and receive data.

Controller Nos.5 to 32 can only receive data.

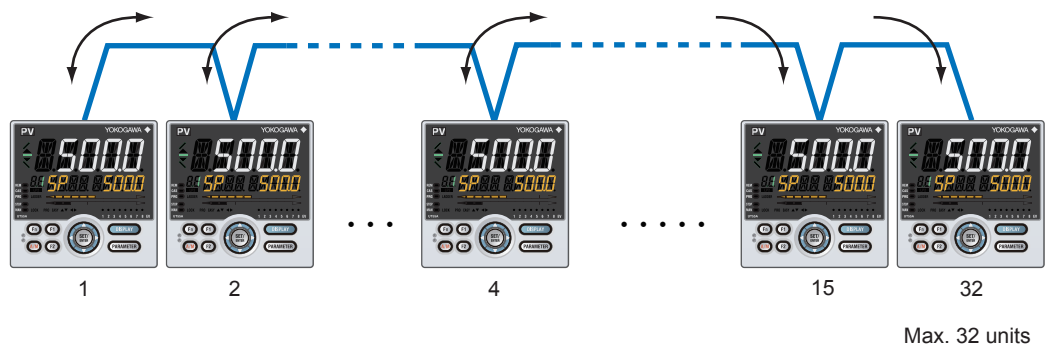

For details on wiring, refer to Operation Guide or User's Manual.

Specifications of Peer-to-peer Communications

Item	Specifications
Interface	RS-485, 2-wire type
Transmission control procedure	Asynchronous, non-procedural, half-duplex
Baud rate	19200 bps (fixed)
Connection method	Parallel connection
Number of connected units	Max. 32 (4 transmitting/receiving controllers, 28 receiving-only controllers)
Maximum connection distance	1200 m
Amount of data transmitted	(4 analog data + 16 digital data) per transmitting/receiving controller
Amount of data received	16 analog data + 64 digital data
Transmitted data update period	200 ms
Communication fail detection time	2 seconds

1.5 Coordinated Communication (for UTAdvanced with RS-485 Communication)

Coordinated operation is a function in which a UTAdvanced controller is used as the master controller, and a number of the UTAdvanced controllers are connected to each other as slave controllers and operated according to the operation of the master controller.

1.5.1 Communication Specifications

RS-485 Communication Interface Specification

	Communication specifications
Communication interface	RS-485
Communication method	4-wire type half-duplex or 2-wire type half-duplex, asynchronous operation, non-procedural
Connection method	1:n multi-drop method (n = max. 31)
Connection distance	Max. 1200 m
Baud rate	600, 1200, 2400, 4800, 9600, 19200, 38400 bps * *: 38400 bps: UT75A/UT55A/UT35A/UP55A/UP35A; Only of suffix code Type 3 = 1 UT52A/UT32A; Only of suffix code Type 2 = 1
Start bit	1 bit
Data length	7, 8 bits
Parity bit	NONE (none), EVEN (even), ODD (odd)
Stop bit	1, 2 bits

Connection Specifications

	Communication Specifications
Maximum number of devices available for connection	32
Data transmitting device	1
Data receiving device	31
Transmitted data update period	200 ms

Example:

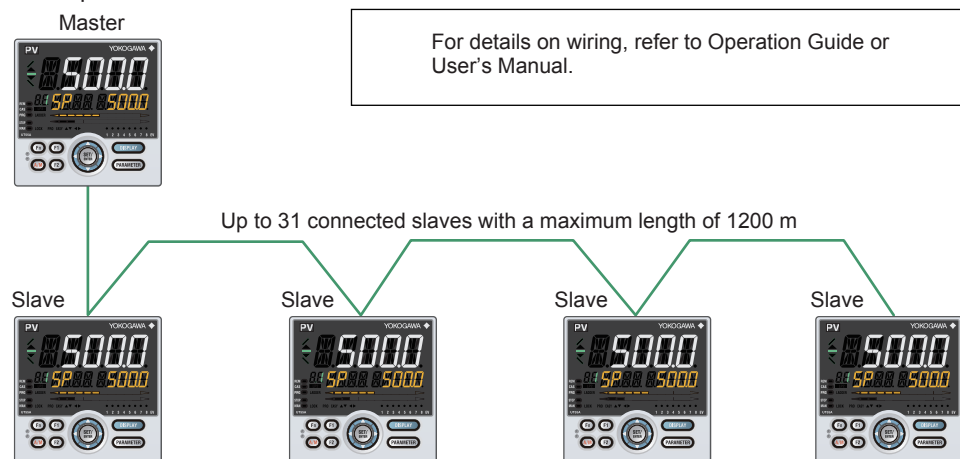

1.6 D registers and I relays

The D registers and I relays of the UTAdvanced are configured for two types of communication programs: those of the UTAdvanced and those of the existing GREEN Series controllers *1.

D registers

D registers are used for communication access and ladder program access.

If you want to newly perform communication in the UTAdvanced, use the D registers after D2001.

If an existing GREEN Series communication program is used, the D0001 to D2000 are used. The allocation is the same as that of the GREEN Series (UT300/UP300 Series or UT500/UP500 Series) controllers.

However, some functions have been changed and deleted, so see “Chapter 6 Functions and Applications of D Registers (UT55A/UT52A/UP55A)”, “Chapter 8 Functions and Applications of D Registers (UT35A/UT32A/UP35A)”, “Chapter 10 Functions and Applications of D Registers (UM33A)”, “Chapter 12 Functions and Applications of D Registers (UT35A-J)”, or “Chapter 14 Functions and Applications of D Registers (UT75A)” in this manual.

*1: GREEN Series controllers are the digital indicating controllers of YOKOGAWA.

- ▶ [UT55A/UT52A/UP55A](#)
Details of D registers: [Chapter 6 Functions and Applications of D Registers \(for UT55A/UT52A/UP55A\)](#)
Compatibility with the GREEN Series controllers: [6.6 GREEN Series Compatible D Registers](#)
- ▶ [UT35A/UT32A/UP35A](#)
Details of D registers: [Chapter 8 Functions and Applications of D Registers \(for UT35A/UT32A/UP35A\)](#)
Compatibility with the GREEN Series controllers: [8.6 GREEN Series Compatible D Registers](#)
- ▶ [UM33A](#)
Details of D registers: [Chapter 10 Functions and Applications of D Registers \(for UM33A\)](#)
Compatibility with the GREEN Series controllers: [10.6 GREEN Series Compatible D Registers](#)
- ▶ [UT35A-L](#)
Details of D registers: [Chapter 12 Functions and Applications of D Registers \(for UT35A-L\)](#)
Compatibility with the GREEN Series controllers: [12.6 GREEN Series Compatible D Registers](#)
- ▶ [UT75A](#)
Details of D registers: [Chapter 14 Functions and Applications of D Registers \(for UT75A\)](#)
Compatibility with the GREEN Series controllers: [14.6 GREEN Series Compatible D Registers](#)

1.6 D registers and I relays

I relays

I relays are used for ladder program, Modbus communication, PC link communication, and contact input / output function.

If communication is newly performed in the UTAdvanced, I relays I4001 to I7072 are used.

If an existing GREEN Series communication program is used, I relays I0001 to I2048 are used. The allocation is the same as that of the GREEN Series (UT300/UP300 Series or UT500/UP500 Series) controllers.

However, some functions have been changed and deleted, so see “Chapter 7 Functions and Applications of I Relays (for UT55A/UT52A/UP55A)”, “Chapter 9 Functions and Applications of I Relays (for UT35A/UT32A/UP35A)”, “Chapter 11 Functions and Applications of I Relays (for UM33A)”, “Chapter 13 Functions and Applications of I Relays (for UT35A-J)”, or “Chapter 15 Functions and Applications of I Relays (for UT75A).”

Reading from and writing to the I relays can be performed in the ladder program, Modbus communication, and PC link communication.

Contact input and output functions allow you to set the input and output functions of the UTAdvanced. By setting the I relay number in the contact input and output functions, the ON/OFF operation of the set I relay becomes a contact operation.

- ▶ [UT55A/UT52A/UP55A](#)
Details of I relay: [Chapter 7 Functions and Applications of I Relays \(for UT55A/UT52A/UP55A\)](#)
Compatibility with GREEN Series Controllers: [7.5 GREEN Series Compatible I Relays](#)
- ▶ [UT35A/UT32A/UP35A](#)
Details of I relay: [Chapter 9 Functions and Applications of I Relays \(for UT35A/UT32A/UP35A\)](#)
Compatibility with GREEN Series Controllers: [9.5 GREEN Series Compatible I Relays](#)
- ▶ [UM33A](#)
Details of I relay: [Chapter 11 Functions and Applications of I Relays \(for UM33A\)](#)
Compatibility with GREEN Series Controllers: [11.5 GREEN Series Compatible I Relays](#)
- ▶ [UT35A-L](#)
Details of I relay: [Chapter 13 Functions and Applications of I Relays \(for UT35A-J\)](#)
Compatibility with GREEN Series Controllers: [13.5 GREEN Series Compatible I Relays](#)
- ▶ [UT75A](#)
Details of I relay: [Chapter 15 Functions and Applications of I Relays \(for UT75A\)](#)
Compatibility with GREEN Series Controllers: [15.5 GREEN Series Compatible I Relays](#)

- ▶ [Contact input and output functions: Chapter 12 Contact Input / Output Functions of the UTAdvanced User's Manual](#)

D registers and I relays of the UTAdvanced are used for parameter settings or ladder program creations of LL50A Parameter Setting Software.

2.1 Setting Parameters

2.1.1 Setting RS-485 Communication (for UTAdvanced with RS-485 communication)

This section describes the setting parameters and setting ranges of the UTAdvanced for using the communication functions.

Set the required parameters referring to the UTAdvanced Operation Guide or User's Manual.

Setting Display

Parameter Setting Display



UT75A/UT55A/UT35A:/UP55A/PU35A

Operation Display > **PARAMETER** and **Left arrow** keys simultaneously for 3 seconds (to the [CTL] Menu Display) > **Right arrow** key (to the [R485] Menu Display in E3 or E4^{*1}) > **SET/ENTER** key (The setting parameter is displayed.)

*1: Only UT75A/UT55A/UP55A. UT35A/UP35A does not have R485 of E4. (UT75A/UT55A/UP55A: E3 or E4 indicating the terminal area is displayed on Group display. UT35A/UP35A: E3 indicating the terminal area is displayed on Group display.)

UT52A/UT32A/UM33A:

Operation Display > **PARA** and **Left arrow** keys simultaneously for 3 seconds (to the [CTL] Menu Display) > **Right arrow** key (to the [R485] Menu Display in E1) > **SET/ENTER** key (The setting parameter is displayed.) (E1 indicating the terminal area is displayed on Group display.)

Setting Details

Parameter symbol	Group display	Name	Setting range		Menu symbol	Initial value
PSL	UT75A/ UT55A/ UP55A: E3 or E4	Protocol selection	PC link communication	PCL (0)	R485	MBRTU (8)
			PC link communication (with checksum)	PCLSM (1)		
			Ladder communication	LADR (2)		
			Coordinated master station	CO-M (3) *3		
			Coordinated slave station	CO-S (4) *4		
			Modbus (ASCII)	MBASC (7)		
			Modbus (RTU)	MBRTU (8)		
			Coordinated master station (2-loop mode)	CO-M2 (9) *5		
			Coordinated slave station (Loop-1 mode)	CO-S1 (10) *4		
			Coordinated slave station (Loop-2 mode)	CO-S2 (11) *4		
			Peer-to-peer communication	P-P (12) *3		
BPS	UT52A/ UT32A/ UM33A: E1	Baud rate	600 bps	600 (0)	R485	19200 (5)
			1200 bps	1200 (1)		
			2400 bps	2400 (2)		
			4800 bps	4800 (3)		
			9600 bps	9600 (4)		
			19200 bps	19200 (5)		
38400 bps *1	38400 (6)					
PRI	UT35A/ UP35A: E3	Parity	None	NONE (0)	R485	EVEN (1)
			Even	EVEN (1)		
			Odd	ODD (2)		
STP		Stop bit	1 bit	1 (1)	R485	1 (1)
			2 bits	2 (2)		
DLN		Data length	PC link communication	7 bits (7)	R485	8 bits (1)
				8 bits (8)		
			Modbus (ASCII)	Fixed at 7 bits (0)		
ADR		Address	Ladder communication	Fixed at 8 bits (1)	R485	1
			1 to 99			
RP.T *2		Minimum response time	0 to 10 (x10ms)		R485	0

Note: Figures in parentheses "()" are values to be set when performing communication.

2.1 Setting Parameters

- *1: 38400 bps can be specified when the UT75A/UT55A/UT35A/UP55A/UP35A suffix code Type 3 = 1 or UT52A/UT32A/UM33A suffix code Type 2 = 1.
- *2: This parameter may not be displayed depending on the parameter display level (LEVL) setting.
- *3: UT75A/UT55A/UT52A/UT35A/UT32A/UP55A/UP35A only.
- *4: UT75A/UT55A/UT52A/UT35A/UT32A only.
- *5: UP55A only.

▶ [UTAdvanced Operation Guide or User's Manual](#)

Description

- Protocol selection
Select the protocol to be used.
- Baud rate
Set the same baud rate as the host computer that the controller is to be connected to.
The baud rate unit is bps (bits per second).
- Parity
Set the same parity bit as the host computer that the controller is to be connected to.
Set the handling of parity to be carried out when data is sent or received.
- Stop bit
Set the same stop bit as the host computer that the controller is to be connected to.
- Data length
Set the same data length as the host computer that the controller is to be connected to.
Modbus communication (ASCII): Fixed at 7 bits.
Modbus communication (RTU) and ladder communication: Fixed at 8 bits.
- Address
Any number within the range 1 to 99 can be set. (Numbers need not be consecutive and can be skipped. However, set only unique numbers within the same system. Do not set the same address twice.) The maximum connecting configuration is 31 controllers.
- Minimum response time
Set the time from when receiving a communication command to responding to it. The minimum response time unit is 10 ms. The actual response time is calculated using the equation: Communication processing time + setting value of PR.T x 10 (ms).

2.1.2 Setting Ethernet Communication (for UTAdvanced with Ethernet communication)

Setting Display

Parameter Setting Display



Operation Display > **PARAMETER** and **Left arrow** keys simultaneously for 3 seconds (to the [CTL] Menu Display) > **Right arrow** key (to the [ETHR] Menu Display in E3) > **SET/ENTER** key (The setting parameter is displayed.) (E3 indicating the terminal area is displayed on Group display.)

Setting Details

Parameter	Group display	Name	Setting range	Menu symbol	Factory default
HSR	E3	High-speed response mode	OFF (0) 1 to 8	ETHR	1
BPS		Baud rate	9600: 9600 bps (4) 19200: 19200 bps (5) 38400: 38400 bps (6)		38400 (6)
PRI		Parity	NONE: no parity (0) EVEN: even (1) ODD: odd (2)		EVEN (1)
IP1		IP address 1	0 to 255		192
IP2		IP address 2			168
IP3		IP address 3			1
IP4		IP address 4			1
SM1		Subnet mask 1	0 to 255		255
SM2		Subnet mask 2			255
SM3		Subnet mask 3			255
SM4		Subnet mask 4			0
DG1		Default gateway 1	0 to 255		0
DG2		Default gateway 2			0
DG3		Default gateway 3			0
DG4		Default gateway 4			0
PRT		Port number	502, 1024 to 65535		502
IPAR		IP access restriction	OFF: Disable (0) ON: Enable (1)		OFF (0)
1.IP1		Permitted IP address 1-1	0 to 255		255
1.IP2		Permitted IP address 1-2			
1.IP3		Permitted IP address 1-3			
1.IP4		Permitted IP address 1-4			
2.IP1		Permitted IP address 2-1			
2.IP2		Permitted IP address 2-2			
2.IP3	Permitted IP address 2-3				
2.IP4	Permitted IP address 2-4				
ESW	Ethernet setting switch	OFF: - (0) ON: (1)	OFF (0)		

Note: Figures in parentheses "()" are values to be set when performing communication.

▶ [Setup of serial gateway function to the serial device: 4.5 Ethernet-Serial Gateway Function](#)

2.1 Setting Parameters

Description

- High-speed response mode
Set the address of the device for which the process data high-speed response function is used.
▶ [Setting details of high-speed response mode: 4.6 Process Data High-Speed Response Function](#)
- Baud rate
Set the same baud rate as the host computer that the controller is to be connected to. The baud rate unit is bps (bits per second).
- Parity
Set the same parity bit as the host computer that the controller is to be connected to. Set the handling of parity to be carried out when data is sent or received.
- IP address
Set the UT75A/UT55A/UT35A/UP55A/UP35A's IP address according to the following format:

IP address 0 to 255 0 to 255 0 to 255 0 to 255
 . . .

- Subnet mask
Set the UT75A/UT55A/UT35A/UP55A/UP35A's subnet mask according to the following format:

Subnet Mask 0 to 255 0 to 255 0 to 255 0 to 255
 . . .

- Default gateway
Set the UT75A/UT55A/UT35A/UP55A/UP35A's default gateway according to the following format:

Default Gateway 0 to 255 0 to 255 0 to 255 0 to 255
 . . .

Note

For the settings of the IP address, subnet mask, and default gateway, consult with the administrator of the network to which to connect the UT75A/UT55A/UT35A/UP55A/UP35A before setting them.

- Port number
Generally, use "502" as the port in the Modbus/TCP protocol. To use a different port number, set within the range of 1024 to 65535.
- IP access restriction
Set this parameter to ON (1) to enable access restriction by permitted IP address.
- Permitted IP address
Register an IP address of the access permitted device.
- Ethernet setting switch
This switch is for enabling the Ethernet communications parameter settings. Setting this parameter to "ON (1)" enables the high-speed response mode, IP address, subnet mask, default gateway, port number, IP access restriction, and permitted IP address settings. After this parameter is set to "ON (1)" to enable the settings, it is automatically returned to "OFF (0)."

Note

After changing the high-speed response mode, IP address, subnet mask, default gateway, port number, IP access restriction, or permitted IP address, set the Ethernet setting switch (ESW) to ON (1) to update the settings. Turning the UT75A/UT55A/UT35A/UP55A/UP35A off/on can also update the settings.

*: It takes about 20 seconds for the new settings of the Ethernet communication parameters to be enabled.

2.1.3 Setting Coordinated Operation

Parameter Setting Display

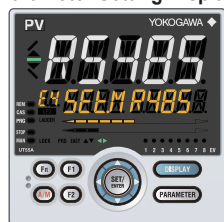

UT75A/UT55A/UT35A/UP55A/UP35A:

Operation Display > **PARAMETER** and **Left arrow** keys simultaneously for 3 seconds (to the [CTL] Menu Display) > **Right arrow** key (to the [R485] Menu Display in E3 or E4*1) > **SET/ENTER** key (The setting parameter is displayed.)

*1: Only UT75A/UT55A/UP55A. UT35A/UP35A does not have R485 of E4. (UT75A/UT55A/UP55A: E3 or E4 indicating the terminal area is displayed on Group display. UT35A/UP35A: E3 indicating the terminal area is displayed on Group display.)

UT52A/UT32A:

Operation Display > **PARA** and **Left arrow** keys simultaneously for 3 seconds (to the [CTL] Menu Display) > **Right arrow** key (to the [R485] Menu Display in E1) > **SET/ENTER** key (The setting parameter is displayed.) (E1 indicating the terminal area is displayed on Group display.)

Setting Details

Parameter	Group display	Name	Setting Range	Menu symbol	Factory Default	
PSL	UT75A/ UT55A/ UP55A: E3 or E4	Protocol selection	Coordinated master station	CO-M (3)	R485	PLC (0)
			Coordinated slave station	CO-S (4) *3		
			Coordinated master station (2-loop mode)	CO-M2 (9) *4		
			Coordinated slave station (Loop-1 mode)	CO-S1 (10) *3		
			Coordinated slave station (Loop-2 mode)	CO-S2 (11) *3		
BPS	UT35/ UP35A: E3	Baud rate	600 bps	600 (0)		19200 (5)
			1200 bps	1200 (1)		
			2400 bps	2400 (2)		
			4800 bps	4800 (3)		
			9600 bps	9600 (4)		
			19200 bps	19200 (5)		
PRI	UT52A/ UT32A: E1	Parity	None	NONE (0)	EVEN (1)	
			Even	EVEN (1)		
			Odd	ODD (2)		
STP		Stop bit	1 bit	1 (1)	1 (1)	
			2 bits	2 (2)		
DLN		Data length	7 bits	7 (7)	8 bits (8)	
			8 bits	8 (8)		
ADR		Address	1 to 99		1	
RP.T *2		Minimum response time	0 to 10 (x10ms)		0	

Note: Figures in parentheses "(") are values to be set when performing communication.

*1: 38400 bps can be specified when the UT75A/UT55A/UT35A/UP55A/UP35A suffix code Type 3 = 1 or UT52A/UT32A suffix code Type 2 = 1.

*2: This parameter may not be displayed depending on the parameter display level (LEVL) setting.

*3: UT75A/UT55A/UT52A/UT35A/UT32A only.

*4: UP55A only.

▶ [UTAdvanced Operation Guide or User's Manual](#)

Description

Master controller: UT75A/UT55A/UT52A/UT35A/UT32A/UP55A/UP35A

Slave controller: UT75A/UT55A/UT52A/UT35A/UT32A/

▶ [Description of parameters: 2.2.1 Setting RS-485 Communication \(for UTAdvanced with RS-485 communication\)](#)

2.2 Setting Communication Write Permit

Writing to registers via all communication protocols can be permitted and prohibited. (When the writing is being prohibited, the response returns as "normal" if the communication is performed, but the writing is not performed.)

However, communication using the light-loader (on the front panel) is possible.

Writing to registers via communication is possible only when the parameter COM.W (communication write enable/disable) in the KLOC menu is set to OFF (enable).

Setting Display

Parameter Setting Display



UT75A/UT55A/UT35A/UP55A/UP35A:

Operation Display > **PARAMETER** and **Left arrow** keys simultaneously for 3 seconds (to the [CTL] Menu Display) > **Right arrow** key (to the [KLOC] Menu Display) > **SET/ENTER** key (The COM.W parameter is displayed.)

UT52A/UT32A/UM33A:

Operation Display > **PARA** and **Left arrow** keys simultaneously for 3 seconds (to the [CTL] Menu Display) > **Right arrow** key (to the [KLOC] Menu Display) > **SET/ENTER** key (The COM.W parameter is displayed.)

Setting Details

Parameter symbol	Name	Setting range	Menu symbol	Initial value
COM.W	Communication write enable/disable	OFF: Enable (0)	KLOC	OFF (0)
		ON: Disable (1)		

Note: Figures in parentheses "()" are values to be set when performing communication.

3.1 Modbus Communication

3.1.1 Overview

The UTAdvanced can communicate with devices such as PCs, PLCs (sequencer), and touch panels by using Modbus communication. With Modbus communication, these devices can exchange data with UTAdvanced by reading/writing the internal registers (D registers and I relays) of the UTAdvanced.

▶ **D registers and I relays:**

Chapter 6 Functions and Applications of D Registers (for UT55A/UT52A/UP55A) or Chapter 7 Functions and Applications of I Relays (for UT55A/UT52A/UP55A) in this manual
 Chapter 8 Functions and Applications of D Registers (for UT35A/UT32A/UP35A) or Chapter 9 Functions and Applications of I Relays (for UT35A/UT32A/UP35A) in this manual
 Chapter 10 Functions and Applications of D Registers (for UM33A) or Chapter 11 Functions and Applications of I Relays (for UM33A) in this manual
 Chapter 12 Functions and Applications of D Registers (for UT35A-L) or Chapter 13 Functions and Applications of I Relays (for UT35A-L) in this manual
 Chapter 14 Functions and Applications of D Registers (for UT75A) or Chapter 15 Functions and Applications of I Relays (for UT75A) in this manual



CAUTION

The parameters of the UTAdvanced are placed in the D registers.

If the settings of some parameters are changed, the related parameters may be initialized.

When changing the parameter setting, configure (write) the settings in the following orders.

1. Setup parameters
 - 1-1 Control mode parameter (CTLM) *1
 - 1-2 Input -related parameters *2
 - 1-3 Output-related parameters
 - 1-4 Other necessary parameters
2. Operation parameters
 - 2-1 Alarm type parameters
 - 2-2 Alarm setpoint parameters
 - 2-3 Other necessary parameters

*1: If the setting of CTLM (control mode) is changed, the related parameters will be initialized. UT35A/UT32A/UM33A does not have the parameter CTLM (Control mode.)

*2: If the setting of IN (input type) is changed, the parameters related to ranges or scales such as target setpoint etc. will be initialized.

3.1 Modbus Communication

Overview of Modbus Communication Connection

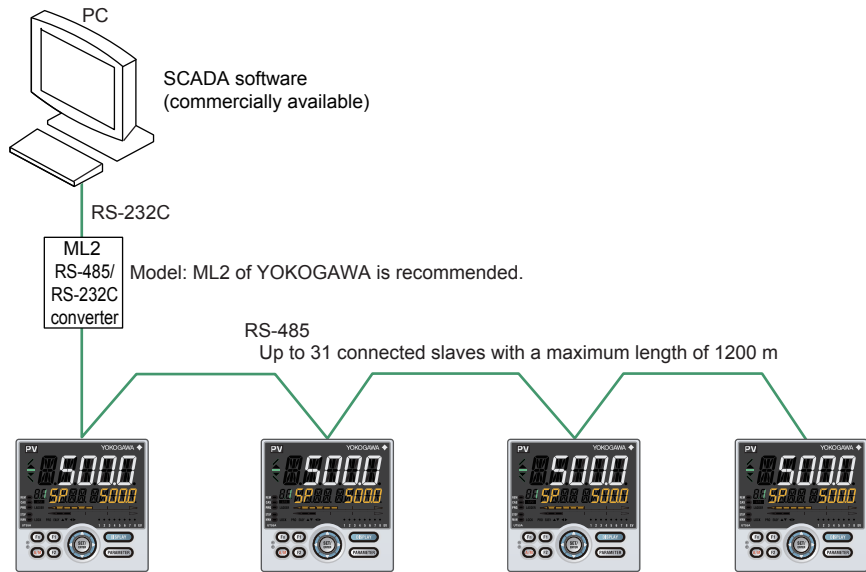

There are two transfer modes in Modbus communication, the ASCII mode and RTU mode (binary method).

When multiple controllers are connected on a single network, all of the controllers must be set to the same transfer mode.

The following table compares the RTU and ASCII modes.

Comparison of RTU and ASCII Modes

Item	ASCII Mode	RTU Mode
Number of data bits	7 bits (ASCII)	8 bits (binary)
Detection of message start	Text : (colon)	Time Data receive after the silent interval of 3.5 characters or more
Detection of message end	Text CR+LF	Time Silent interval of 3.5 characters or more after data receive
Message length (*1)	2N+1	N
Inter-character timer timeout	1 second	None
Error detection	Longitudinal redundancy check: LRC	Cyclic redundancy check: CRC-16

*1: The message length in the ASCII mode becomes "2N+1" when the message length in the RTU mode is assumed to be "N."

Detection of Message Frame Termination in RTU Mode

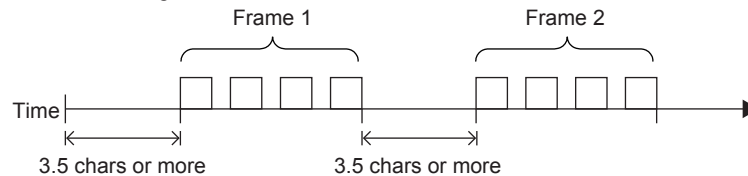

Note

When the write data to D registers / I relays is outside the valid range, the response is returned as "normal."

However, the data cannot be written to D registers / I relays.

For the 2-wire connection of the UTAdvanced series with DAQSTATION series, set the "Command wait time" of the DAQSTATION to 10 ms or more.

In case of the 2-wire connection with the MW100 Data acquisition unit via Modbus master function, set the "Gap between messages" of MW100 to 10 ms or more.

3.1.2 Configuration of Messages

The structure of messages sent to the UTAdvanced from the host computer is as follows:

	(1)	(2)	(3)	(4)	(5)	(6)
Element	Message start mark	Address No (ADR)	Function code	Data	Error check	Message end mark
Number of bytes in RTU mode	None	1	1	2n (variable length)	2	None
Number of bytes in ASCII mode	1	2	2	4n (variable length)	2	2

(1) Message start mark

This indicates the start of the message. A colon (:) is required only in the ASCII mode.

(2) Address No. (01 to 99)

This No. is for enabling the host computer to identify the UTAdvanced at the communication destination.

(Individual UTAdvanced ID numbers are expressed in Hex in messages.)

(3) Function code (See “3.1.5 Messages and Responses.”)

The instruction (function code) from the host computer is specified.

(4) Data

The D register / I relay numbers, number of D registers / I relays, parameter values, etc. are specified according to the function code. (These are expressed in Hex in messages.)

Writing to string parameters is set in the word unit to enable writing to be performed. However, although the string length of each string parameter is fixed, once 0x00 is written, 0x00 is consistently written in the subsequent strings, but not displayed in the indicator.

Example:

Condition	Content of D register n	Content of D register n+1	Content of D register n+2	Content of D register n+3	Display data
Status before writing to string parameter	12 (0x3132)	34 (0x3334)	56 (0x3536)	(0x0000)	12345678
Status after writing to string parameter	12 (0x3132)	3 (0x3300)	(0x0000)	(0x0000)	123

(5) Error check

In the RTU mode, errors are checked by the cyclic redundancy check (CRC-16).

In the ASCII mode, errors are checked by the longitudinal redundancy check (LRC).

(6) Message end mark

This indicates the end of the message. “CR” and “LF” are required only in the ASCII mode.

● Message format for communication

Example: When setting the target setpoint “50.00,” the host computer sends the value “1388” as message data which is a hexadecimal value of “5000” (50.00 excluding the decimal point) (this is also true for setting 5.000 or 500.0).

Message data to be sent from the host computer: 1388 (hexadecimal value of 5000)

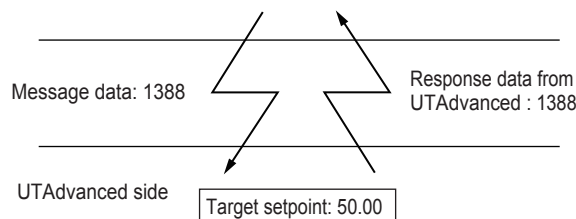

* The UTAdvanced determine the decimal point position for “5000” by the decimal point position parameter setting (in this case, P.DP = 2).

3.1 Modbus Communication

■ Specifying D registers / I relays

When you use a commercially available SCADA or the like or a user-created communication program, you must be careful when specifying D register / I relay numbers contained in messages because in both cases, you cannot use the original D register / I relay numbers as they are.

When using a commercially available SCADA or the like:

Specify D register numbers by changing them into reference numbers. To change them into a reference number, replace the D register number's leading character "D" with "4."

Specify I relay numbers by changing them into reference numbers. To change them into a reference number, remove the I relay number's leading character "I."

In a user-created communication program:

Specify D register numbers using the hexadecimal number of the value obtained by subtracting "40001" from the D register's reference number.

Specify I relay numbers using the hexadecimal number of the value obtained by subtracting "1" from the I relay's reference number.

Example:

When specifying "D2018":

- In SCADA, specify the reference number "42018."
- Specify the message in the user-created communication program as "07E1". This number is the number "2017" (number obtained by subtracting 40001 from the reference number) expressed in hexadecimal number.

■ Error check

The error checking of the ASCII mode is different from the RTU mode.

● ASCII mode

In the ASCII mode, error checking is performed by the longitudinal redundancy check (LRC).

Each individual byte from the communication address up to the final data (excluding ".", "CR" and "LF") is added, and the 2's complement of the result becomes LRC.

Ignore the uppermost carry during addition.

Example:

How to calculate the LRC in the case of command [:]110307E10004[LRC][CR][LF] for reading four values continuously from D register D0218 of the controller at communication address 17.

- (1) Communication address 17 is expressed as "0x11" in Hex.

D2018 is "0x07E1". This is the number "2017" (number obtained by subtracting 40001 from reference No. 42018) expressed in Hex.

When this is converted to 1-byte Hex data, this becomes "11,03,00,C8,00,04".

(In Modbus/ASCII messages, "11" is ASCII code "H' 31, H' 31", which comprises two bytes.)

- (2) This 1-byte Hex data is added one byte at a time as follows:

→ 11+03+07+E1+00+04 = 00

- (3) 2's complement of the lowermost 1 byte of the result of addition is "00".

00000000 (0x00) → 11111111 (complement) +1=00000000 (00)

● RTU Mode

In the RTU mode, error checking is performed by the cyclic redundancy check (CRC-16). Of all message blocks (from communication address through to final data), eight bits (excluding start bit, stop bit and parity bit) are aligned serially, and the remainder (16 bits) when the result is divided by predetermined binary 17 bits becomes the CRC-16.

Example (CRC-16 calculation example)

When reading four data from D register D2018 by function code 03 (read status of multiple D registers) from the slave at communication address 11 (0Bh). "0B0307E10004" is sent as the send command.

- (1) Default is FFFF. This is XORed (exclusive ORed) with the 1st byte (= slave address 11).
- (2) The lower byte of the result is referenced, and the value corresponding to that value in the following table is obtained. In this case, the 244th value in the table is referenced to obtain 8701h as the result is F4h.
- (3) The upper byte of the result of the XOR in (1) is XORed with the result of (2).
- (4) The result (remainder) of (3) is taken as the next default, and the same operation is performed on the 2nd byte (=function code 03).

Default value	FF FF	Convert the hex value to a decimal value, find the corresponding number in table of next page (Table Showing Results of Error Checking (CRC) of Values 0 to 255 by A001h), and substitute the number into the formula.
Communication address	0B	
XOR	FF F4	In the example shown on the left, hex value "F4" is converted to decimal value 244. From table of next page, the number corresponding to 244 proves to be "8701". This number is substituted into the formula.
Reference to table	87 01	
XOR	87 FE	
Function code	03	
XOR	87 FD	
Reference to table	81 C1	
XOR	81 46	
.	.	
.	.	
.	.	
XOR	14 78	
Last character	04	
XOR	14 7C	
Reference to table	E1 01	
Resulting error	E1 15	

- (5) From here on, steps (1) to (4) are repeated to calculate up to the final "04".
- (6) The upper and lower bytes of the result of calculation "E115" are inverted, and "15E1" is appended to the final.
0B0307E1000415E1

3.1 Modbus Communication

Showing Results of Error Checking (CRC) of Values 0 to 255 by A001h

Number	0	1	2	3	4	5	6	7
Result	0000	C0C1	C181	0140	C301	03C0	0280	C241
Number	8	9	10	11	12	13	14	15
Result	C601	06C0	0780	C741	0500	C5C1	C481	0440
Number	16	17	18	19	20	21	22	23
Result	CC01	0CC0	0D80	CD41	0F00	CFC1	CE81	0E40
Number	24	25	26	27	28	29	30	31
Result	0A00	CAC1	CB81	0B40	C901	09C0	0880	C841
Number	32	33	34	35	36	37	38	39
Result	D801	18C0	1980	D941	1B00	DBC1	DA81	1A40
Number	40	41	42	43	44	45	46	47
Result	1E00	DEC1	DF81	1F40	DD01	1DC0	1C80	DC41
Number	48	49	50	51	52	53	54	55
Result	1400	D4C1	D581	1540	D701	17C0	1680	D641
Number	56	57	58	59	60	61	62	63
Result	D201	12C0	1380	D341	1100	D1C1	D081	1040
Number	64	65	66	67	68	69	70	71
Result	F001	30C0	3180	F141	3300	F3C1	F281	3240
Number	72	73	74	75	76	77	78	79
Result	3600	F6C1	F781	3740	F501	35C0	3480	F441
Number	80	81	82	83	84	85	86	87
Result	3C00	FCC1	FD81	3D40	FF01	3FC0	3E80	FE41
Number	88	89	90	91	92	93	94	95
Result	FA01	3AC0	3B80	FB41	3900	F9C1	F881	3840
Number	96	97	98	99	100	101	102	103
Result	2800	E8C1	E981	2940	EB01	2BC0	2A80	EA41
Number	104	105	106	107	108	109	110	111
Result	EE01	2EC0	2F80	EF41	2D00	EDC1	EC81	2C40
Number	112	113	114	115	116	117	118	119
Result	E401	24C0	2580	E541	2700	E7C1	E681	2640
Number	120	121	122	123	124	125	126	127
Result	2200	E2C1	E381	2340	E101	21C0	2080	E041
Number	128	129	130	131	132	133	134	135
Result	A001	60C0	6180	A141	6300	A3C1	A281	6240
Number	136	137	138	139	140	141	142	143
Result	6600	A6C1	A781	6740	A501	65C0	6480	A441
Number	144	145	146	147	148	149	150	151
Result	6C00	ACC1	AD81	6D40	AF01	6FC0	6E80	AE41
Number	152	153	154	155	156	157	158	159
Result	AA01	6AC0	6B80	AB41	6900	A9C1	A881	6840
Number	160	161	162	163	164	165	166	167
Result	7800	B8C1	B981	7940	BB01	7BC0	7A80	BA41
Number	168	169	170	171	172	173	174	175
Result	BE01	7EC0	7F80	BF41	7D00	BDC1	BC81	7C40
Number	176	177	178	179	180	181	182	183
Result	B401	74C0	7580	B541	7700	B7C1	B681	7640
Number	184	185	186	187	188	189	190	191
Result	7200	B2C1	B381	7340	B101	71C0	7080	B041
Number	192	193	194	195	196	197	198	199
Result	5000	90C1	9181	5140	9301	53C0	5280	9241
Number	200	201	202	203	204	205	206	207
Result	9601	56C0	5780	9741	5500	95C1	9481	5440
Number	208	209	210	211	212	213	214	215
Result	9C01	5CC0	5D80	9D41	5F00	9FC1	9E81	5E40
Number	216	217	218	219	220	221	222	223
Result	5A00	9AC1	9B81	5B40	9901	59C0	5880	9841
Number	224	225	226	227	228	229	230	231
Result	8801	48C0	4980	8941	4B00	8BC1	8A81	4A40
Number	232	233	234	235	236	237	238	239
Result	4E00	8EC1	8F81	4F40	8D01	4DC0	4C80	8C41
Number	240	241	242	243	244	245	246	247
Result	4400	84C1	8581	4540	8701	47C0	4680	8641
Number	248	249	250	251	252	253	254	255
Result	8201	42C0	4380	8341	4100	81C1	8081	4040

3.1.3 Configuration of Responses (response from UTAdvanced)

If the instruction message from the host computer is normal and the address is for itself, the UTAdvanced moves to the process execution phase after it judges that the received content is normal. The UTAdvanced then parses the content of the instruction message and executes processing.

However, it does not execute processing if the content of the instruction message is in error. In this case, the UTAdvanced either ignores received content, or generates a response message to inform the host computer that the received content is in error. After executing the requested processing when the received content is normal, the UTAdvanced generates a response message appended with an error check corresponding to the instruction function code, and sends this message to the host computer.

- Response in a normal state

In the case of the loopback function and write function on a single D register / I relay, the UTAdvanced returns the same response message as the instruction message.

In the case of a write function on multiple D registers / I relays, the UTAdvanced returns part of the instruction message as the response message.

In the case of the read function, the UTAdvanced appends the address No. and function code with the data that was read, and returns this as the response message.

- Response in an error state

When a communication error (framing error, parity error, inter-character timer timeout, or receiving frame over-length) occurs, the UTAdvanced does not return a message.

When the message contains an inconsistency other than a communication error, the UTAdvanced does not perform any processing, and returns the following message.

Element	Message start mark	Address No (ADR)	Function code (*1)	Data	Error check	Message end mark
Number of bytes in RTU mode	None	1	1	1	2	None
Number of bytes in ASCII mode	1	2	2	2	2	2

*1: The value of "function code (Hex) + 0x80" is set in the function code.

The following shows the details of the error code.

Error code	Meaning	Cause
01	Function code error	The function code does not exist.
02	D register / I relay No. error	A No. outside the range has been specified.
03	Number of D registers / I relays error	A number of registers outside the range has been specified.
09	Monitor not specified	An attempt was made to read a monitor without specifying the monitor.

Even if continuous D registers specified by a read function include unused registers, no error is generated and the UTAdvanced returns "0" as the value.

The UTAdvanced returns error code "02" or "03" when the start address of continuously specified addresses is in the range, and the continuously specified addresses become out of range as a result of the number of specified addresses (according to function code).

- When there is no response even after a message is sent:

- When a transmission error (overrun, framing, parity, LRC or CRC-16 error) is detected
- When the address in the instruction message is wrong
- When the inter-character timer timeout occurs
- When the communication address is "00" or "F9" (broadcast specification)
- When a receive buffer overflow (buffer size: 512 bytes) has occurred

Note: As a measure for the above, execute time-out processing by the communication function or communication program on the host computer.

3.1.4 Specifying Broadcast

This function allows multiple instruments specified by respective addresses to receive commands.

- (1) Broadcast specification is executed with the following addresses specified to the address No. in the command:
 - “00”: All controllers supporting Modbus on network
 - “F9”: All UTAdvanced controllers on network
- (2) This command functions regardless of communication address.
- (3) This address can be used only for writing.
- (4) When communication is performed with this address specified, the UTAdvanced that receives the command does not return a response.

Note

If existing communication programs created in GREEN Series controllers are used in the UTAdvanced, a UTAdvanced controller behaves as a GREEN Series controller in terms of device information response via communication and broadcasting by setting the GREEN Series device response (C.GRN) register to 1: ON. However, in this case, the command "F9" is disregarded.

Broadcast Specification

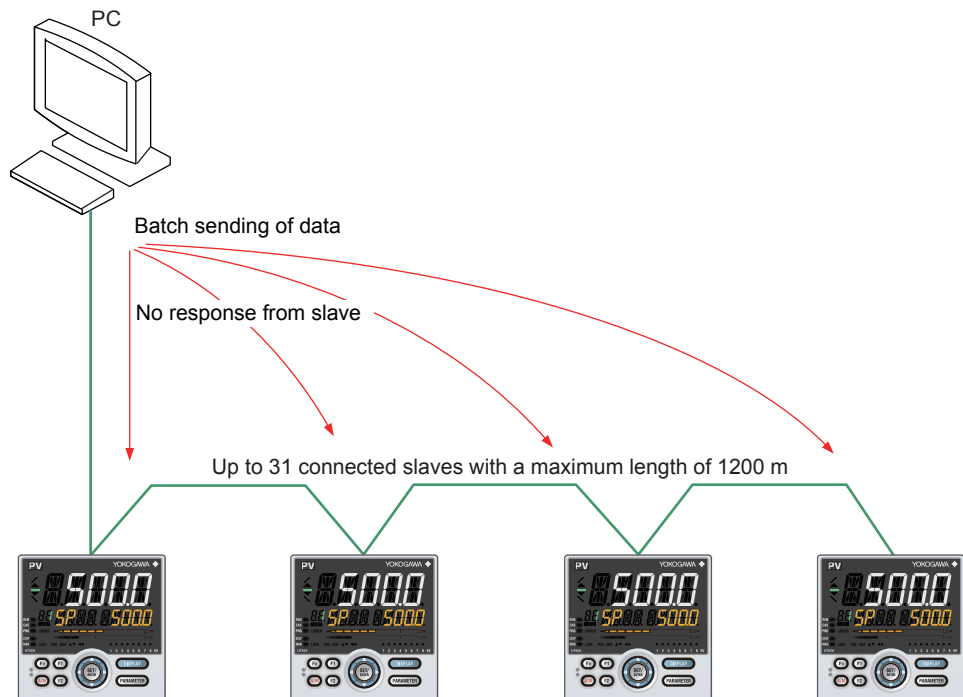

3.1.5 Messages and Responses

These instruction words are used so that the host computer obtains the D register and I relay information of the UTAdvanced.

List of Function Codes

Code No.	Function	Description
01	Reading of multiple I relays	Up to 256 I relays can be read continuously (I4001 to I7072).
03	Reading of multiple D registers	Up to 100 D registers can be read continuously (D0001 to D7600*).
05	Writing of I relays	Only one I relay can be written (I4001 to I7072).
06	Writing of D registers	Only one D register can be written (D0001 to D7600*).
08	Loopback test	This is used to check the communication connection.
15	Writing of multiple I relays	Up to 256 I relays can be written continuously (I4001 to I7072).
16	Writing of multiple D registers	Up to 50 D registers can be written continuously (D0001 to D7600*).
66	Random reading	Up to 100 registers can be read at random (D0001 to D7600*).
67	Random writing	Up to 50 registers can be written at random (D0001 to D7600*).
68	Specify monitor	Up to 100 registers can be specified at random for monitoring (D0001 to D7600*).
69	Monitoring	The register specified by "specify monitor" is read.
70	Writing of multiple D registers for program pattern	Up to 80 D registers can be written continuously (D8001 to D9000).

*: When UP55A/UP35A; D001 to D9000

Function codes cannot be written to read-only or use-disabled D registers / I relays. Broadcast specification is possible with function codes "05," "06," "15," "16," "67," and "68" only.

(Also in this case, read-only or use-disabled D registers / I relays will not be written.)

3.1 Modbus Communication

■ 01 Reading multiple I relays

● Function

The content of I relays is read continuously for the specified number of relays from the specified I relay No.

- The maximum number of relays that can be read at a time is 256.
- For details on the response format at an error, see “● Response in an error state” in “3.1.3 Configuration of Responses (response from UTAdvanced).”
- The response status of I relays is one bit for each I relay.

The bit indicates: 1 = ON and 0 = OFF. The LSB (least significant bit) of the first data item indicates the status of the read start I relay.

If the status of I relay Nos. 20 to 27 is assumed to be ON-ON-OFF-OFF-ON-OFF-ON-OFF, it is expressed as 01010011 (0x53) in the binary number.

The status of eight I relays is represented by one byte. If the number of I relays is short of eight I relays in the last data item, the remaining empty space is filled with zero.

● Message (during normal operation)

Element	Message start mark (:)	Address No. (ADR)	Function code (0x01)	I relay start No.	Number of read I relays	Error check	Message end mark (CR+LF)
Number of bytes in RTU mode	None	1	1	2	2	2	None
Number of bytes in ASCII mode	1	2	2	4	4	2	2

● Response (during normal operation)

Element	Message start mark (:)	Address No. (ADR)	Function code (0x01)	Byte count (Note 1)	I relay content	...
Number of bytes in RTU mode	None	1	1	1	1	...
Number of bytes in ASCII mode	1	2	2	2	2	...

Continuation of response

I relay content	Error check	Message end mark (CR+LF)
1	2	None
2	2	2

Note 1: When the byte count is assumed to be “N,” N = Number of read I relays / 8 (however, N = N + 1 when the remainder is not zero).

■ 03 Reading multiple D registers

● Function

The content of D registers is read continuously for the specified number of registers from the specified D register No.

- The maximum number of registers that can be read at a time is 100.
- For details on the response format at an error, see “● Response in an error state” in “3.1.3 Configuration of Responses (response from UTAdvanced).”

● Message (during normal operation)

Element	Message start mark (:)	Address No. (ADS)	Function code (0x03)	Register start No.	Number of read registers	Error check	Message end mark (CR+LF)
Number of bytes in RTU mode	None	1	1	2	2	2	None
Number of bytes in ASCII mode	1	2	2	4	4	2	2

● Response (during normal operation)

Element	Message start mark (:)	Address No. (ADRS)	Function code (0x03)	Byte count (Note 1)	Register content	...
Number of bytes in RTU mode	None	1	1	1	2	...
Number of bytes in ASCII mode	1	2	2	2	4	...

Continuation of response

Register content	Error check	Message end mark (CR+LF)
2	2	None
4	2	2

Note 1: Byte count = 2 x number of read registers

3.1 Modbus Communication

■ 05 Writing to an I relay

- Function

Data is written to the specified I relay No.

- The number of relays that can be written at a time is 1.
- For details on the response format at an error, see “● Response in an error state” in “3.1.3 Configuration of Responses (response from UTAdvanced).”
- When data outside the setting range of parameters is set, the response is a normal response, but the data is not written.
- Broadcasting can be specified. No response is returned when broadcasting is specified.

- Message (during normal operation)

Element	Message start mark (:)	Address No. (ADR)	Function code (0x05)	I relay No.	Write data	Error check	Message end mark (CR+LF)
Number of bytes in RTU mode	None	1	1	2	2	2	None
Number of bytes in ASCII mode	1	2	2	4	4	2	2

- Response (during normal operation)

Element	Message start mark (:)	Address No. (ADR)	Function code (0x05)	I relay No.	Write data	Error check	Message end mark (CR+LF)
Number of bytes in RTU mode	None	1	1	2	2	2	None
Number of bytes in ASCII mode	1	2	2	4	4	2	2

■ 06 Writing to a D register

- Function

Data is written to the specified D register No.

- The number of registers that can be written at a time is 1.
- For details on the response format at an error, see “● Response in an error state” in “3.1.3 Configuration of Responses (response from UTAdvanced).”
- When data outside the setting range of parameters is set, the response is a normal response, but the data is not written.
- Broadcasting can be specified. No response is returned when broadcasting is specified.

- Message (during normal operation)

Element	Message start mark (:)	Address No. (ADR)	Function code (0x06)	Register No.	Write data	Error check	Message end mark (CR+LF)
Number of bytes in RTU mode	None	1	1	2	2	2	None
Number of bytes in ASCII mode	1	2	2	4	4	2	2

- Response (during normal operation)

Element	Message start mark (:)	Address No. (ADR)	Function code (0x06)	Register No.	Write data	Error check	Message end mark (CR+LF)
Number of bytes in RTU mode	None	1	1	2	2	2	None
Number of bytes in ASCII mode	1	2	2	4	4	2	2

■ 08 Loopback test

● Function

This is used to check the communication connection.

- For details on the response format at an error, see “● Response in an error state” in “3.1.3 Configuration of Responses (response from UTAdvanced).”
- The diagnostics code is fixed at “0000.”
- Any data can be selected for the send data.

● Message (during normal operation)

Element	Message start mark (:)	Address No. (ADR)	Function code (0x08)	Diagnostic code (0000)	Send data (arbitrary)	Error check	Message end mark (CR+LF)
Number of bytes in RTU mode	None	1	1	2	2	2	None
Number of bytes in ASCII mode	1	2	2	4	4	2	2

● Response (during normal operation)

Element	Message start mark (:)	Address No. (ADR)	Function code (0x08)	Diagnostic code (0000)	Same as send data	Error check	Message end mark (CR+LF)
Number of bytes in RTU mode	None	1	1	2	2	2	None
Number of bytes in ASCII mode	1	2	2	4	4	2	2

3.1 Modbus Communication

■ 15 Writing to multiple I relays

● Function

Data is written to I relays continuously for the specified number of relays from the specified relay number.

- The maximum number of relays that can be written at a time is 256.
- For details on the response format at an error, see “● Response in an error state” in “3.1.3 Configuration of Responses (response from UTAdvanced).”

- The data to be written is one bit for each I relay.

The bit indicates: 1 = ON and 0 = OFF. The LSB of the first written data item indicates the status of the write start I relay.

The status of 8 I relays is represented by one byte. If the maximum number of I relays is exceeded by the last written data, the exceeding part of the data item is not written.

- Broadcasting can be specified. No response is returned when broadcasting is specified.

● Message (during normal operation)

Element	Message start mark (:)	Address No. (ADR)	Function code (0x0F)	I relay start No.	Number of I relays	Byte count (Note 1)
Number of bytes in RTU mode	None	1	1	2	2	1
Number of bytes in ASCII mode	1	2	2	4	4	2

Continuation of message

Write data	...	Write data	Error check	Message end mark (CR+LF)
1	...	1	2	None
2	...	2	2	2

Note 1: When the byte count is assumed to be “N,” N = Number of write I relays / 8 (however, N = N + 1 when the remainder is not zero).

● Response (during normal operation)

Element	Message start mark (:)	Address No. (ADR)	Function code (0x0F)	I relay start No.	Number of I relays	Error check	Message end mark (CR+LF)
Number of bytes in RTU mode	None	1	1	2	2	2	None
Number of bytes in ASCII mode	1	2	2	4	4	2	2

■ 16 Writing to multiple D registers

● Function

Data is written to D registers continuously for the specified number of registers from the specified D register No.

- The maximum number of registers that can be written at a time is 50.
- For details on the response format at an error, see “● Response in an error state” in “3.1.3 Configuration of Responses (response from UTAdvanced).”
- When data outside the setting range of parameters is set, the response is a normal response, but the data is not written.
- Broadcasting can be specified. No response is returned when broadcasting is specified.

● Message (during normal operation)

Element	Message start mark (:)	Address No. (ADR)	Function code (0x10)	Register start No.	Number of registers	Byte count (Note 1)
Number of bytes in RTU mode	None	1	1	2	2	1
Number of bytes in ASCII mode	1	2	2	4	4	2

Continuation of message

Write data	...	Write data	Error check	Message end mark (CR+LF)
2	...	2	2	None
4	...	4	2	2

Note 1: Byte count = 2 x number of write registers

● Response (during normal operation)

Element	Message start mark (:)	Address No. (ADR)	Function code (0x10)	Register start No.	Number of registers	Error check	Message end mark (CR+LF)
Number of bytes in RTU mode	None	1	1	2	2	2	None
Number of bytes in ASCII mode	1	2	2	4	4	2	2

3.1 Modbus Communication

■ 66 Random reading

- Function

The register data of register Nos. specified at random is read.

- Register Nos. can be specified from all register areas.
- The maximum number of registers that can be set is 100.
- For details on the response format at an error, see “● Response in an error state” in “3.1.3 Configuration of Responses (response from UTAdvanced).”

- Message (during normal operation)

Element	Message start mark (:)	Address No. (ADRS)	Function code (0x42)	Number of specified registers	Byte count (Note 1)
Number of bytes in RTU mode	None	1	1	2	1
Number of bytes in ASCII mode	1	2	2	4	2

Continuation of message

Specified Register No.	...	Specified Register No	Error check	Message end mark (CR+LF)
2	...	2	2	None
4	...	4	2	2

- Response (during normal operation)

Element	Message start mark (:)	Address No. (ADRS)	Function code (0x42)	Byte count (Note 1)	Register conten	...
Number of bytes in RTU mode	None	1	1	1	2	...
Number of bytes in ASCII mode	1	2	2	2	4	...

Continuation of response

Register content	Error check	Message end mark (CR+LF)
2	2	None
4	2	2

Note 1: Byte count = 2 x number of read registers

■ 67 Random writing

● Function

Data is written to the register Nos. specified at random.

- Register Nos. can be specified from all register areas.
- The maximum number of registers that can be written to at a time is 50.
- For details on the response format at an error, see “● Response in an error state” in “3.1.3 Configuration of Responses (response from UTAdvanced).”
- Broadcasting can be specified. No response is returned when broadcasting is specified.

● Message (during normal operation)

Element	Message start mark (:)	Address No. (ADR)	Function code (0x43)	Number of specified registers	Byte count (Note 1)	Specified register No.1
Number of bytes in RTU mode	None	1	1	2	2	2
Number of bytes in ASCII mode	1	2	2	4	4	4

Continuation of message

Write data 1	...	Specified Register No.n	Write data n	Error check	Message end mark (CR+LF)
2	...	2	2	2	None
4	...	4	4	2	2

Note 1: Byte count = 4 x number of write registers

● Response (during normal operation)

Element	Message start mark (:)	Address No. (ADR)	Function code (0x43)	Number of specified registers	Error check	Message end mark (CR+LF)
Number of bytes in RTU mode	None	1	1	2	2	None
Number of bytes in ASCII mode	1	2	2	4	2	2

3.1 Modbus Communication

■ 68 Specify monitor

● Function

The register No. specified at random can be specified for monitoring.

- The maximum number of registers that can be specified for monitoring is 100.
- For details on the response format at an error, see “● Response in an error state” in “3.1.3 Configuration of Responses (response from UTAdvanced).”
- Broadcasting can be specified. No response is returned when broadcasting is specified.
- When the power supply is turned off, the register specified by “specify monitor” will be erased. If the power supply is turned off, specify the register by “specify monitor” again.

● Message (during normal operation)

Element	Message start mark (:)	Address No. (ADR)	Functioncode (0x44)	Number of monitor-specified register	Byte count(Note 1)
Number of bytes in RTU mode	None	1	1	2	1
Number of bytes in ASCII mode	1	2	2	4	2

Continuation of message

Monitor-specified Register No. 1	...	Monitor-specified Register No. n	Error check	Message end mark (CR+LF)
2	...	2	2	None
4	...	4	2	2

● Response (during normal operation)

Element	Message start mark (:)	Address No. (ADR)	Function code (0x44)	Byte count (Note 1)	Error check	Message end mark (CR+LF)
Number of bytes in RTU mode	None	1	1	1	2	None
Number of bytes in ASCII mode	1	2	2	2	2	2

Note 1: Byte count = 2 x number of specify monitor registers

■ 69 Monitoring

● Function

The content of the register specified for monitoring by function code “68” is read.

- For details on the response format at an error, see “● Response in an error state” in “3.1.3 Configuration of Responses (response from UTAdvanced).”

● Message (during normal operation)

Element	Message start mark (:)	Address No. (ADR)	Function code (0x45)	Error check	Message end mark (CR+LF)
Number of bytes in RTU mode	None	1	1	2	None
Number of bytes in ASCII mode	1	2	2	2	2

● Response (during normal operation)

Element	Message start mark (:)	Address No. (ADR)	Function code (0x45)	Byte count (Note 1)	Register content	...
Number of bytes in RTU mode	None	1	1	1	2	...
Number of bytes in ASCII mode	1	2	2	2	4	...

Continuation of response

Register content	Error check	Message end mark (CR+LF)
2	2	None
4	2	2

Note 1: Byte count = 2 x number of registers of monitoring

■ 70 Writing to multiple D registers for program pattern

● Function

Data is written to D registers continuously for the specified number of registers from the specified D register No.

Can be specified register areas: D8001 to D9000.

- The maximum number of registers that can be written at a time is 80.
- For details on the response format at an error, see “● Response in an error state” in “3.1.3 Configuration of Responses (response from UTAdvanced).”
- When data outside the setting range of parameters is set, the response is a normal response, but the data is not written.

● Message (during normal operation)

Element	Message start mark (:)	Address No. (ADR)	Function code (0x46)	Register start No.	Number of registers	Byte count (Note 1)
Number of bytes in RTU mode	None	1	1	2	2	1
Number of bytes in ASCII mode	1	2	2	4	4	2

Continuation of message

Write data	• • •	Write data	Error check	Message end mark (CR+LF)
2	• • •	2	2	None
4	• • •	4	2	2

Note 1: Byte count = 2 x number of write registers

● Response (during normal operation)

Element	Message start mark (:)	Address No. (ADR)	Function code (0x46)	Error code (Note 1)	Error check	Message end mark (CR+LF)
Number of bytes in RTU mode	None	1	1	1	2	None
Number of bytes in ASCII mode	1	2	2	2	2	2

Note 1: See the "Error Information" of "6.4.10 Program Pattern for UP55A (D8001 to D9000)" or "8.4.8 Program Pattern for UP35A (D8001 to D9000)" in this manual.

► Writing via Communication:

[6.4.10 Program pattern for UP55A \(D8001 to D9000\)](#) or [8.4.8 Program pattern for UP35A \(D8000 to D9000\)](#) in this manual

3.2 PC Link Communication

3.2.1 Overview

PC link communication enables the UTAdvanced to communicate easily with PCs, touch panels, and FA-M3 (PLC) UT link modules. With PC link communication, the D registers and I relays (UTAdvanced internal registers) are read and written.

► **D registers and I relays:**

[Chapter 6 Functions and Applications of D Registers \(for UT55A/UT52A/UP55A\)](#) or [Chapter 7 Functions and Applications of I Relays \(for UT55A/UT52A/UP55A\)](#) in this manual
[Chapter 8 Functions and Applications of D Registers \(for UT35A/UT32A/UP35A\)](#) or [Chapter 9 Functions and Applications of I Relays \(for UT35A/UT32A/UP35A\)](#) in this manual
[Chapter 10 Functions and Applications of D Registers \(for UM33A\)](#) or [Chapter 11 Functions and Applications of I Relays \(for UM33A\)](#) in this manual
[Chapter 12 Functions and Applications of D Registers \(for UT35A-L\)](#) or [Chapter 13 Functions and Applications of I Relays \(for UT35A-L\)](#) in this manual
[Chapter 14 Functions and Applications of D Registers \(for UT75A\)](#) or [Chapter 15 Functions and Applications of I Relays \(for UT75A\)](#) in this manual



CAUTION

The parameters of the UTAdvanced are placed in the D registers. If the settings of some parameters are changed, the related parameters may be initialized.

When changing the parameter setting, configure (write) the settings in the following orders.

1. Setup parameters
 - 1-1 Control mode parameter (CTLM) *1
 - 1-2 Input -related parameters *2
 - 1-3 Output-related parameters
 - 1-4 Other necessary parameters
2. Operation parameters
 - 2-1 Alarm type parameters
 - 2-2 Alarm setpoint parameters
 - 2-3 Other necessary parameters

*1: If the setting of CTLM (control mode) is changed, the related parameters will be initialized. UT35A/UT32A/UP35A/UM33A does not have the parameter CTLM (Control mode.)

*2: If the setting of IN (input type) is changed, the parameters related to ranges or scales such as target setpoint etc. will be initialized.

Overview of PC Link Communication Connection

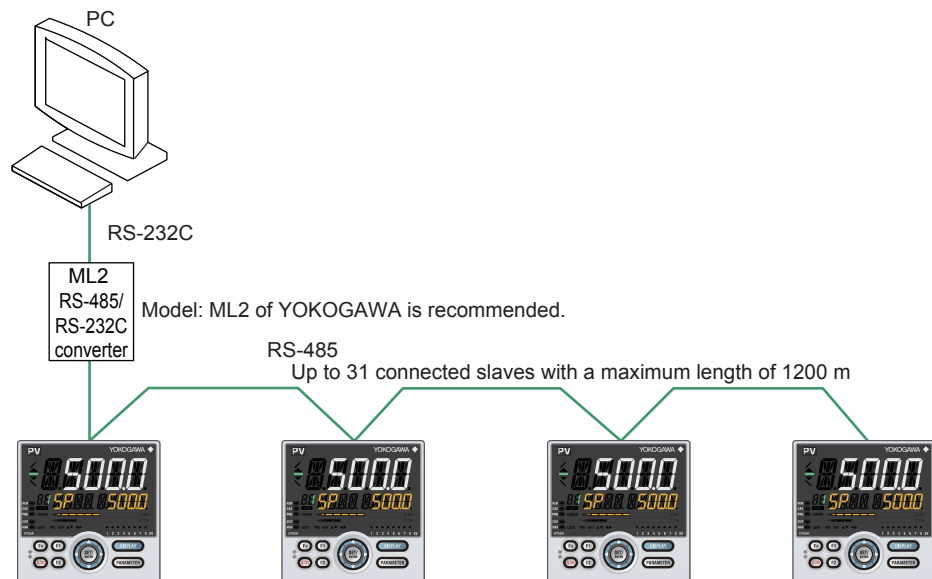

3.2.2 Configuration of Commands

The structure of commands sent to the UTAdvanced from the host computer is as follows:

	(1)	(2)	(3)	(4)	(5)	(6)	(7)	(8)	(9)
Number of bytes	1	2	2	1	3	Variable length	2	1	1
Element	STX	Address No. (ADR)	CPU No. (01)	Response waiting time	Command	Data to command corresponding	Checksum	ETX	CR

(1) STX (Start of Text)

This indicates the start of the command. ASCII code is 02 in hexadecimal.

(2) Address No. (01 to 99)

This No. is for enabling the host computer to identify the UTAdvanced at the communication destination. (These are the ID Nos. of each UTAdvanced.)

(3) CPU No.

Fixed at "01"

(4) Response waiting time

A waiting time (time delay) from transmission of a command up to reception of a response can be set.

Set the response waiting time within 0 to 600 ms using characters 0 to F.

Character	Response waiting time (unit: ms)
0	0 (Note)
1	10
2	20
3	30
4	40
5	50
6	60
7	70
8	80
9	90
A	100
B	200
C	300
D	400
E	500
F	600

Note: Even if the response waiting time is set to "0," processing is delayed by the time taken to execute internal processing.

(5) Command (For a list of commands, see "3.2.6 Commands and Responses.")

The instruction (command) from the host computer is specified.

(6) Data corresponding to command

Internal register (D register / I relay), number of data points, etc. are specified.

Data type	Data content	Data form
PV high and low limits, target setpoints, and others	PV range (EU) data	Numerical data not including the decimal point
Bias, deviation alarms, and others	PV range span (EUS) data	Numerical data not including the decimal point
Proportional bands, output high and low limits and others	% data (0.0 to 100.0%)	Numerical data not including the decimal point 0 to 1000
Various modes, alarm types and others	Seconds, absolute values, and data without unit	Absolute value not including the decimal point

3.2 PC Link Communication

(7) Checksum

The ASCII codes of text from the character following STX up to before the checksum are added one byte at a time. The lowermost byte of the addition result is removed, and an ASCII text string of two bytes expressed in Hex is taken to be the checksum. This column is required only when performing PC link communication with a checksum.

When performing PC link communication without a checksum, this ASCII code 2-byte area is not required.

(8) ETX (End of Text)

This indicates the end of the command. ASCII code is 03 in hexadecimal.

(9) CR (Carriage Return)

This indicates the end of the command line. ASCII code is 0D in hexadecimal.

Note

“STX,” “ETX,” and “CR” are required for PC link communication commands. Communication cannot be performed normally if you forget to append these codes or make a mistake in their programmed order.

● Command format for communication

Example: When setting a target setpoint “50.0,” the host computer sends the value “01F4” as command data which is a hexadecimal value of “500” (50.0 excluding the decimal point) (this is also true for setting 5.00 or 500).

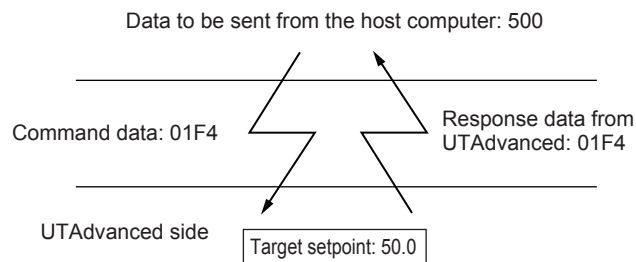

* The UTAdvanced determine the decimal point position for “500” by the decimal point position parameter setting (in this case, P.DP = 1).

3.2.3 Configuration of Responses

The UTAdvanced responses to commands sent from a host computer are configured as shown below according to whether execution of operation is normal or ends in error. When data outside the parameter setting range is set, the response is a normal response, but the data is not written.

- Response in a normal state

When communication is executed normally, the text string “OK” and data corresponding to the command are returned.

With write commands, parameter data area is not provided.

Number of bytes	1	2	2	2	Variable length	2	1	1
Element	STX	Address No. (ADR)	CPU No. (01)	OK	Parameter data	Checksum	ETX	CR

- Response in an error state

When communication is not executed normally, the text string “ER” and an error code (EC1 or EC2) are returned. (See “3.2.4 Response Error Codes.”)

- There is no response (no reply) for address No. specification errors and CPU No. specification errors.
- Responses are sometimes not made (no reply) when the ETX in a command is not received.

Note: As a measure for the above, execute time-out processing by the communication function or in the communication program on the host computer.

Number of bytes	1	2	2	2	2	2	3	2	1	1
Element	STX	Address No. (ADR)	CPU No. (01)	ER	EC1	EC2	Command	Checksum	ETX	CR

3.2.4 Response Error Codes

The error code (EC1) and detailed error code (EC2) of the response are as follows.
Error Codes (EC1)

Error code	Meaning	Cause
02	Command error	<ul style="list-style-type: none"> Command does not exist. Command cannot be executed.
03	Register specification error	<ul style="list-style-type: none"> Register name does not exist. Specification is incorrect when bits (1 relay) are used on a word-by-word basis.
04	Setting value out of range (during a write)	<ul style="list-style-type: none"> A character other than 0 or 1 is used for the bit setting. Annotation other than Hex (0 to 9, A to F) is specified for the word setting. The start position exceeds the address range in a read/save instruction, etc.
05	Data number value out of range	<ul style="list-style-type: none"> The specification of the number of bits, number of words, etc. exceeds the specification range. The number of specified data or the number of parameters such as registers is inconsistent.
06	Monitor error	<ul style="list-style-type: none"> The monitor was executed without specifying the monitor (WRS).
08	Parameter error	<ul style="list-style-type: none"> The parameter is incorrect. (This occurs when there are no commas or spaces.)
42	Checksum error	<ul style="list-style-type: none"> Sum value mismatch
43	Internal buffer overflow	<ul style="list-style-type: none"> Data more than the specified value (max. size of internal buffer: 512 [bytes]) was received.
44	Reception inter-character timer timeout	<ul style="list-style-type: none"> The end character or ETX is not received.

Detailed Error Codes (EC2)

Error code (EC1)	Meaning	Detailed error code (EC2)
03	Register specification error	Error parameter No. (Hex) Sequence No. of parameter where the error first occurred counting from the start of the parameter.
04	Setting value out of range	Example) Register name specification error ↓
05	Data number value out of range	[STX]01010WRW02_D0043,3F80,A0044,0000[ETX][CR] Parameter No. 1 2 3 4 5
08	Parameter error	[STX]0101ER0304WRW[ETX][CR] In this case, EC1=03 and EC2=04

In the case of errors other than EC1 above, EC2 is meaningless, and "00" is returned as the response.

○ Priority of Error Codes

Priority	Error code EC1
High	44
↑	43
↓	42
↓	02
Low	03,04,05,06,08

When no response is returned

- (1) Retransmission error (overrun, framing, parity)
- (2) When the communication address in the command is wrong (including broadcast specification)
- (3) When the CPU No. in the command is not "01"

3.2.5 Specifying Broadcast

This function allows multiple UTAdvanced controllers specified by respective addresses to receive writing commands.

- (1) Broadcast is executed with the address number in the table below specified as the address No. in the command.

When GREEN Series device response is enabled *1		UTAdvanced	
Address No.	Applicable controller	Address No.	Applicable controller
B1	All UT750	N1	All UT75A controllers
B2	All UT750	–	–
B3	All UT500 Series All UT400 Series	N3	All UT55A/UT52A controllers
B4	All UP550	–	All UP55A controllers
B5	All UT300 Series	N5	All UT35A/UT32A controllers
B6	All UM300 Series	–	All UM33A controllers
B7	All UP300 Series	–	All UP35A controllers
BA	All GREEN Series	NA	All UTAdvanced controllers
BT	UT controllers of GREEN Series	NT	All UTAdvanced controllers
BP	UP controllers of GREEN Series	–	–
–	UM controllers of GREEN Series	NM	All UM33A controllers
00	All controllers supporting PC link	00	All controllers supporting PC link
01 to 99	Controllers whose addresses accord	01 to 99	Controllers whose addresses accord

- (2) This address functions regardless of communication address.
 (3) This address can be used only for writing.
 (4) When communication is performed with this address specified, the UTAdvanced that receives the command does not return a response.

Note

*1: If existing communication programs created in GREEN Series controllers are used in the UTAdvanced, a UTAdvanced controller behaves as a GREEN Series controller in terms of device information response via communication and broadcasting by setting the GREEN Series device response (C.GRN) register to 1: ON.
 It also responds to GREEN Series controllers such as B3, BA, and BT in terms of broadcasting.

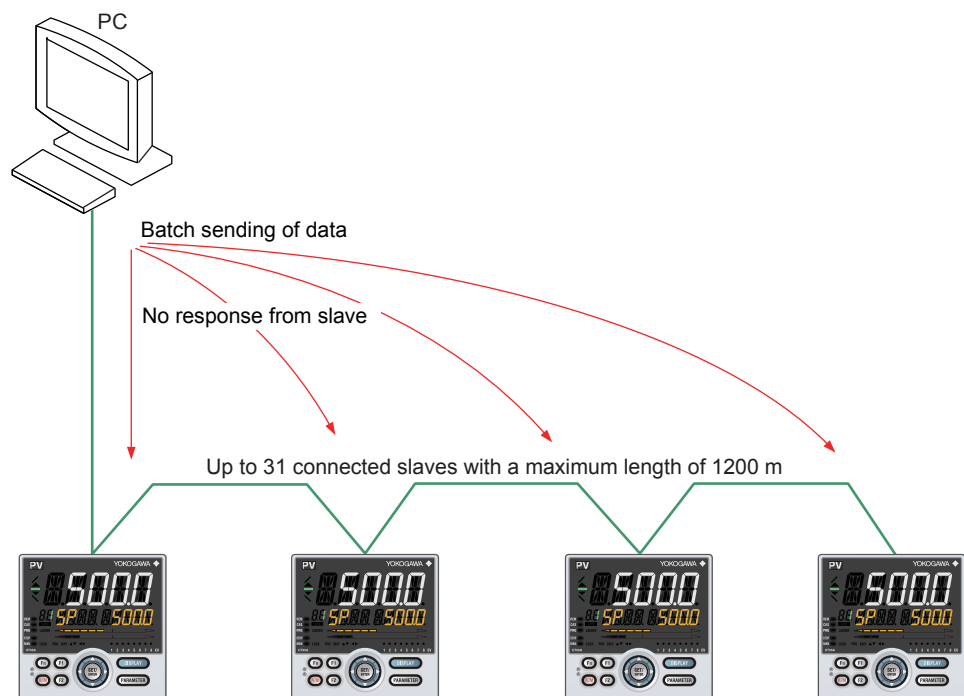

3.2.6 Commands and Responses

This item shows lists of commands that can be used in PC link communication. Details are explained in the description for each command.

(1) Bit-basis access commands dedicated to I relays

Command	Description	Number of bits handled
BRD	Bit-basis read	1 to 256 bits
BWR	Bit-basis read write	1 to 256 bits
BRR	Bit-basis, random read	1 to 32 bits
BRW	Bit-basis, random write	1 to 32 bits
BRS	Specification of registers to be monitored on a bit-by-bit basis.	1 to 32 bits
BRM	Bit-basis, monitoring	—

(2) Word-basis access commands

Command	Description	Number of bits handled
WRD	Word-basis read	1 to 64 words
WWR	Word-basis read write	1 to 64 words
WRR	Word-basis, random read	1 to 32 words
WRW	Word-basis, random write	1 to 32 words
WRS	Specification of registers to be monitored on a word-by-word basis.	1 to 32 words
WRM	Word-basis, monitoring	—

(3) Information commands

Command	Description	Number of bits handled
INF6	Read model, suffix code and, version *1	1 unit
INF7	Read CPU maximum value	1 unit

Note

*1: If existing communication programs created in GREEN Series controllers are used in the UTAdvanced, a UTAdvanced controller behaves as a GREEN Series controller in terms of device information response via communication and broadcasting by setting the GREEN Series device response (C.GRN) register to 1: ON.
As a response to INF6 command, the suffix code equivalent to the GREEN Series is returned.

- ▶ ■ [INF6 Reading the model, suffix code, and version information](#)

■ BRD Reading I relays on a bit-by-bit basis

● Function

Reads the ON/OFF status of a sequence of contiguous I relays by the specified number of bits, starting at a specified I relay number.

- The number of bits to be read at a time is 1 to 256 (decimal).
- For details on the response format at an error, see “3.2.3 Configuration of Response.”
- The command/response shown below includes the checksum function. When performing communication without checksum, do not include the 2-byte checksum element in the command.

● Command/Response (during normal operation)

Number of bytes	1	2	2	1	3	5	1	3	2	1	1
Command element	STX	Address No. (ADR)	CPU No. (01)	Response waiting time	BRD	I relay No.	, or space	Number of bits (n)	Checksum	ETX	CR

Number of bytes	1	2	2	2	1	1	1	...	1	2	1	1
Response element	STX	Address No. (ADR)	CPU No. (01)	OK	d1	d2	d3	...	dn	Checksum	ETX	CR

The response is “0” when the status is OFF or “1” when ON.

dn: read data of the specified number of bits (n = 1 to 256)

dn = 0 (OFF)

dn = 1 (ON)

■ BWR Writing data into I relays on a bit-by-bit basis

● Function

Writes ON/OFF data into a sequence of contiguous I relays by the specified number of bits, starting at a specified I relay number.

- The number of bits to be written at a time is 1 to 256 (decimal).
- For details on the response format at an error, see “3.2.3 Configuration of Response.”
- The command/response shown below includes a checksum function. When performing communication without checksum, do not include the 2-byte checksum element in the command.

● Command/Response (during normal operation)

Number of bytes	1	2	2	1	3	5	1	3	1	1	1
Command element	STX	Address No. (ADR)	CPU No. (01)	Response waiting time	BWR	I relay No.	, or space	Number of bits (n)	, or space	d1	d2

Continuation of command

...	1	2	1	1
...	dn	Checksum	ETX	CR

Write information is “0” to set OFF or “1” to set ON.

dn: write data of the specified number of bits (n = 1 to 256)

dn = 0 (OFF)

dn = 1 (ON)

Number of bytes	1	2	2	2	2	1	1
Response element	STX	Address No. (ADR)	CPU No. (01)	OK	Checksum	ETX	CR

3.2 PC Link Communication

■ BRR Reading I relays on a bit-by-bit basis in a random order

● Function

Reads the ON/OFF status of the individual I relays specified in a random order by the specified number of bits.

- The number of bits to be read at a time is 1 to 32 (decimal).
- For details on the response format at an error, see “3.2.3 Configuration of Response.”
- The command/response shown below includes a checksum function. When performing communication without the checksum, do not include the 2-byte checksum element in the command.

● Command/Response (during normal operation)

Number of bytes	1	2	2	1	3	2	5	1	5	1
Command element	STX	Address No. (ADR)	CPU No. (01)	Response waiting time	BRR	Number of bits (n)	I relay No. 1	, or space	I relay No. 2	, or space

Continuation of command

...	5	2	1	1
...	I relay No. n	Checksum	ETX	CR

Number of bytes	1	2	2	2	1	1	1	...	1	2	1	1
Response element	STX	Address No. (ADR)	CPU No. (01)	OK	d1	d2	d3	...	dn	Checksum	ETX	CR

The response is “0” when the status is OFF or “1” when ON.

dn: read data of the specified number of bits (n = 1 to 32)

dn = 0 (OFF)

dn = 1 (ON)

■ BRW Writing data into I relays on a bit-by-bit basis in a random order

● Function

Writes ON/OFF status in the individual I relays specified in a random order by the specified number of bits.

- The number of bits to be written at a time is 1 to 32 (decimal).
- For details on the response format at an error, see “3.2.3 Configuration of Response.”
- The command/response shown below includes the checksum function. When performing communication without the checksum, do not include the 2-byte checksum element in the command.

● Command/Response (during normal operation)

Number of bytes	1	2	2	1	3	2	5	1	1	1
Command element	STX	Address No. (ADR)	CPU No. (01)	Response waiting time	BRW	Number of bits (n)	I relay No. 1	, or space	d1	, or space

Continuation of command

5	1	1	1	...	5	1	1	2	1	1
I relay No. 2	, or space	d1	, or space	...	I relay No. n	, or space	d2	Checksum	ETX	CR

Write information is “0” to set OFF or “1” to set ON.

dn: write data of the specified number of bits (n = 1 to 32)

dn = 0 (OFF)

dn = 1 (ON)

Number of bytes	1	2	2	2	2	1	1
Response element	STX	Address No. (ADR)	CPU No. (01)	OK	Checksum	ETX	CR

■ BRS Specifying I relays to be monitored on a bit-by-bit basis

● Function

Specifies the numbers of I relays to be monitored on a bit-by-bit basis. Note that this command simply specifies I relays. Actual monitoring is performed by the BRM command after the I relay numbers are specified with this command.

When the volume of data is large and you wish to increase the communication rate, it is effective to use a combination of the BRS and BRM commands rather than the BRD command. If the power supply is turned off, the specified I relay numbers will be erased.

- The number of registers to be specified at a time is 1 to 32.
- For details on the response format at an error, see “3.2.3 Configuration of Response.”
- The command/response shown below includes the checksum function. When performing communication without the checksum, do not include the 2-byte checksum element in the command.

● Command/Response (during normal operation)

Number of bytes	1	2	2	1	3	2	5	1	5	1
Command element	STX	Address No. (ADR)	CPU No. (01)	Response waiting time	BRS	Number of bits (n)	I relay No. 1	, or space	I relay No. 2	, or space

Continuation of command

...	5	2	1	1
...	I relay No. n	Checksum	ETX	CR

Number of bytes	1	2	2	2	2	1	1
Response element	STX	Address No. (ADR)	CPU No. (01)	OK	Checksum	ETX	CR

■ BRM Monitoring I relays on a bit-by-bit basis

● Function

Reads the ON/OFF status of the I relays that have been specified in advance by the BRS command.

- Before executing this command, the BRS command must always be executed to specify which I relays are to be monitored. If no relay has been specified, error code 06 is returned. This error also occurs if the power supply is turned off.
- For details on the response format at an error, see “3.2.3 Configuration of Response.”
- The command shown below includes the checksum function. When performing communication without the checksum, do not include the 2-byte checksum element in the command.

● Command/Response (during normal operation)

Number of bytes	1	2	2	1	3	2	1	1
Command element	STX	Address No. (ADR)	CPU No. (01)	Response waiting time	BRM	Checksum	ETX	CR

Number of bytes	1	2	2	2	1	1	1	...	1	2	1	1
Response element	STX	Address No. (ADR)	CPU No. (01)	OK	d1	d2	d3	...	dn	Checksum	ETX	CR

The response is “0” when the status is OFF or “1” when ON.

dn: read data of the specified number of bits (n = 1 to 32)

dn = 0 (OFF)

dn = 1 (ON)

3.2 PC Link Communication

■ WRD Reading D registers and I relays on a word-by-word basis

- Function

Reads a sequence of contiguous register information on a word-by-word basis by the specified number of words, starting at the specified register number.

- The number of words to be read at a time is 1 to 64 (decimal).
- For details on the response format at an error, see “3.2.3 Configuration of Response.”
- The command/response shown below includes the checksum function. When performing communication without the checksum, do not include the 2-byte checksum element in the command.

- Command/Response (during normal operation)

Number of bytes	1	2	2	1	3	5	1	2	2	1	1
Command element	STX	Address No. (ADR)	CPU No. (01)	Response waiting time	WRD	Register No.	, or space	Number of words (n)	Checksum	ETX	CR

Number of bytes	1	2	2	2	4	4	...	4	2	1	1
Response element	STX	Address No. (ADR)	CPU No. (01)	OK	dddd1	dddd2	...	ddddn	Checksum	ETX	CR

Responses are returned as a 4-digit character string in Hex (0000 to FFFF).

ddddn: Read data of specified number of words

ddddn is a Hex character string. (n = 1 to 64)

■ WWR Writing data into D registers and I relays on a word-by-word basis.

- Function

Writes information into a sequence of contiguous registers on a word-by-word basis by the specified number of words, starting at the specified register number.

- The number of words to be written at a time is 1 to 64 (decimal).
- For details on the response format at an error, see “3.2.3 Configuration of Response.”
- The command/response shown below includes the checksum function. When performing communication without the checksum, do not include the 2-byte checksum element in the command.

- Command/Response (during normal operation)

Number of bytes	1	2	2	1	3	5	1	2	1	4
Command element	STX	Address No. (ADR)	CPU No. (01)	Response waiting time	WWR	Register No.	, or space	Number of words (n)	, or space	dddd1

Continuation of command

4	...	4	2	1	1
dddd2	...	ddddn	Checksum	ETX	CR

Write information is specified as a 4-digit character string in Hex (0000 to FFFF).

ddddn: Write data of specified number of words

ddddn is a Hex character string (n = 1 to 64)

Number of bytes	1	2	2	2	2	1	1
Response element	STX	Address No. (ADR)	CPU No. (01)	OK	Checksum	ETX	CR

■ **WRR Reading D registers and I relays on a word-by-word basis in random order**

● **Function**

Reads the status of the individual registers, on a word-by-word basis, specified in a random order by the specified number of words.

- The number of bits to be read at a time is 1 to 32 (decimal).
- For details on the response format at an error, see “3.2.3 Configuration of Response.”
- The command/response shown below includes the checksum function. When performing communication without the checksum, do not include the 2-byte checksum element in the command.

● **Command/Response (during normal operation)**

Number of bytes	1	2	2	1	3	2	5	1	5	1
Command element	STX	Address No. (ADR)	CPU No. (01)	Response waiting time	WRR	Number of words (n)	Register No. 1	, or space	Register No. 2	, or space

Continuation of command

• • •	5	2	1	1
• • •	Register number n	Checksum	ETX	CR

Number of bytes	1	2	2	2	4	4	• • •	4	2	1	1
Response element	STX	Address No. (ADR)	CPU No. (01)	OK	dddd1	dddd2	• • •	ddddn	Checksum	ETX	CR

Responses are returned as a 4-digit character string in Hex (0000 to FFFF).

ddddn: Read data of specified number of words

ddddn is a Hex character string. (n = 1 to 32)

■ **WRW Writing data into D registers and I relays on a word-by-word basis in random order**

● **Function**

Writes register information specified for each register into the registers specified in a random order by the specified number of words.

- The number of words to be written at a time is 1 to 32 (decimal).
- For details on the response format at an error, see “3.2.3 Configuration of Response.”
- The command/response shown below includes the checksum function. When performing communication without the checksum, do not include the 2-byte checksum element in the command.

● **Command/Response (during normal operation)**

Number of bytes	1	2	2	1	3	2	5	1	4	1
Command element	STX	Address No. (ADR)	CPU No. (01)	Response waiting time	WRW	Number of words (n)	Register No. 1	, or space	dddd1	, or space

Continuation of command

5	1	4	• • •	5	1	4	2	1	1
Register number 2	Comma or space	dddd2	• • •	Register No. n	, or space	ddddn	Checksum	ETX	CR

Write information is specified as a 4-digit character string in Hex (0000 to FFFF).

ddddn: Repeating of register No. and writing information for number of specified words.

ddddn is a Hex character string. (n = 1 to 32)

Number of bytes	1	2	2	2	2	1	1
Response element	STX	Address No. (ADR)	CPU No. (01)	OK	Checksum	ETX	CR

3.2 PC Link Communication

■ WRS Specifying the D registers and I relays to be monitored on a word-by-word basis

● Function

Specifies the numbers of the registers to be monitored on a word-by-word basis. Note that this command simply specifies the registers. Actual monitoring is performed by the WRM command after the register numbers are specified by this command.

If the volume of data is large and you wish to increase the communication rate, it is effective to use a combination of the WRS and WRM commands rather than the WRD command. If the power supply is turned off, the register numbers specified will be erased.

- The number of registers to be specified at a time is 1 to 32 (decimal).
- For details on the response format at an error, see “3.2.3 Configuration of Response.”
- The command/response shown below includes the checksum function. When performing communication without the checksum, do not include the 2-byte checksum element in the command.

● Command/Response (during normal operation)

Number of bytes	1	2	2	1	3	2	5	1	5	1
Command element	STX	Address No. (ADR)	CPU No. (01)	Response waiting time	WRS	Number of words (n)	Register No. 1	, or space	Register No. 2	, or space

Continuation of command

...	5	2	1	1
...	Register number n	Checksum	ETX	CR

Number of bytes	1	2	2	2	4	4	...	4	2	1	1
Response element	STX	Address No. (ADR)	CPU No. (01)	OK	dddd1	dddd2	...	ddddn	Checksum	ETX	CR

■ WRM Monitoring the D registers and I relays on a word-by-word basis

● Function

Reads the information of the registers that have been specified in advance by the WRS command.

- Before executing this command, the WRS command must always be executed to specify which registers are to be monitored. If no register has been specified, error code 06 is returned.
- For details on the response format at an error, see “3.2.3 Configuration of Response.”
- The command/response shown below includes the checksum function. When performing communication without the checksum, do not include the 2-byte checksum element in the command.

● Command/Response (during normal operation)

Number of bytes	1	2	2	1	3	2	1	1
Command element	STX	Address No. (ADR)	CPU No. (01)	Response waiting time	WRM	Checksum	ETX	CR

Number of bytes	1	2	2	2	4	4	...	4	2	1	1
Response element	STX	Address No. (ADR)	CPU No. (01)	OK	dddd1	dddd2	...	ddddn	Checksum	ETX	CR

Responses are returned as a 4-digit character string in Hex (0000 to FFFF).

ddddn: Read data of the number of words specified by the WRS command

ddddn is a Hex character string. (n = 1 to 32)

■ INF6 Reading the model, suffix code, and version information

● Function

Reads the model, version number of the UTAdvanced.

- For details on the response format at an error, see “3.2.3 Configuration of Response.”

● Command/Response (during normal operation)

Number of bytes	1	2	2	1	3	1	2	1	1
Command element	STX	Address No. (ADR)	CPU No. (01)	Response waiting time	INF	6	Checksum	ETX	CR

Number of bytes	1	2	2	2	8	8	4	4
Response element	STX	Address No. (ADR)	CPU No. (01)	OK	Suffix code Information (Note 1)	Version/revision (Note 2)	Specified start register for read refresh*	Specified number of registers for read refresh*

Continuation of response

4	4	2	1	1
Specified start register for write refresh*	Specified number of registers for write refresh*	Checksum	ETX	CR

* indicates area that is referenced by the FA-M3 UT link module.

Data type	UTAdvanced		When GREEN Series device response is enabled	
	UT75A/UT55A/UT52A/UP55A	UT35A/UT32A/UP35A/UM33A	UT75A/UT55A/UT52A/UP55A	UT35A/UT32A/UP35A/UM33A
Specified start register for read refresh	2001	2001	0001	0001
Specified number of registers for read refresh	0025	0011	0025	0011
Specified start register for write refresh	2001	2001	0001	0001
Specified number of registers for write refresh	0000	0000	0000	0000

Note 1: Model and Suffix Code Information

● UT75A

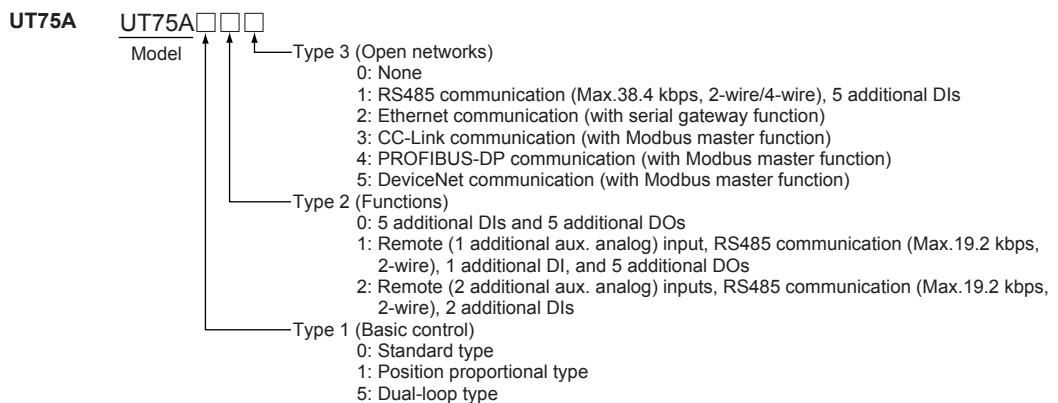

Note: When Type 1 code is "5," only "2" can be specified for Type 2 code.

3.2 PC Link Communication

● UT55A/UT52A

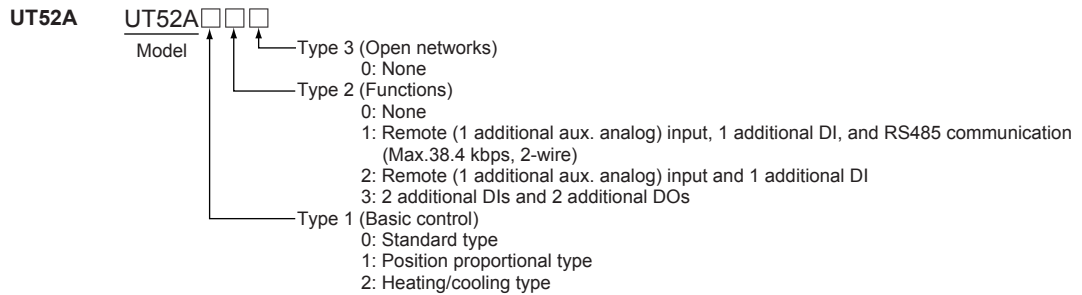
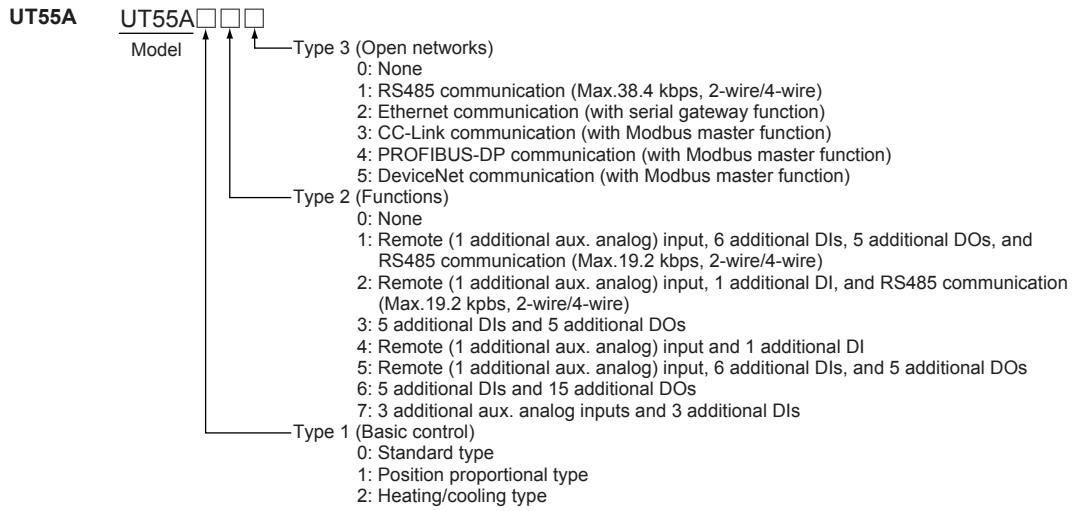

● UT35A/UT35-L/UT32A

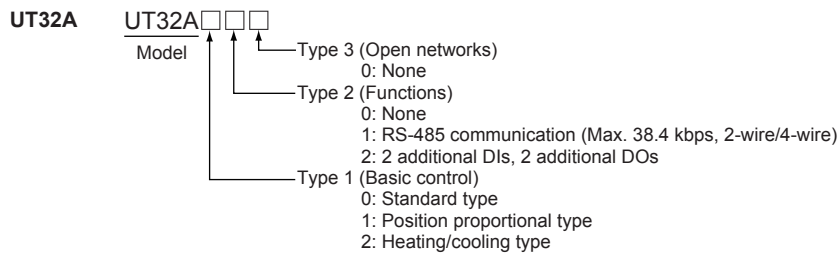
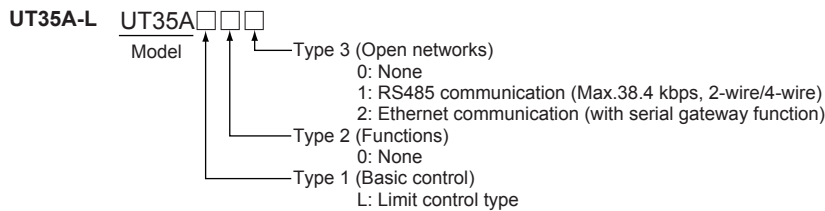
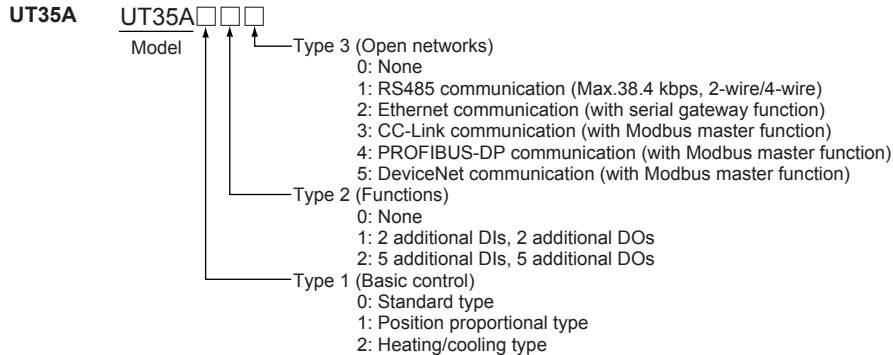

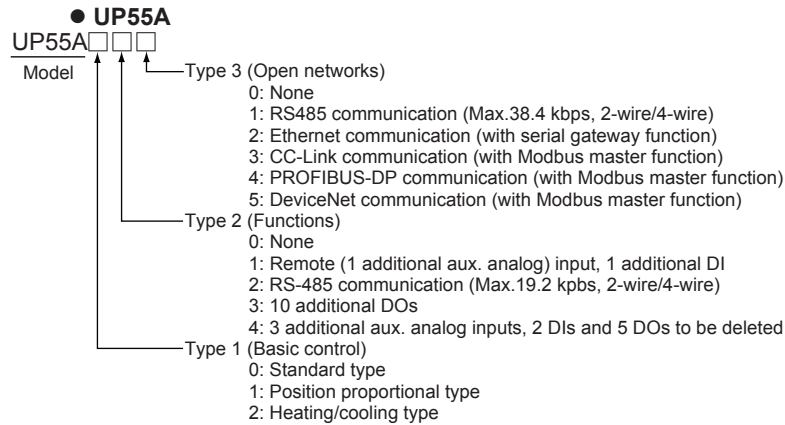

Note: When Type 2 code is "3," only "0" can be specified for Type 3 code.

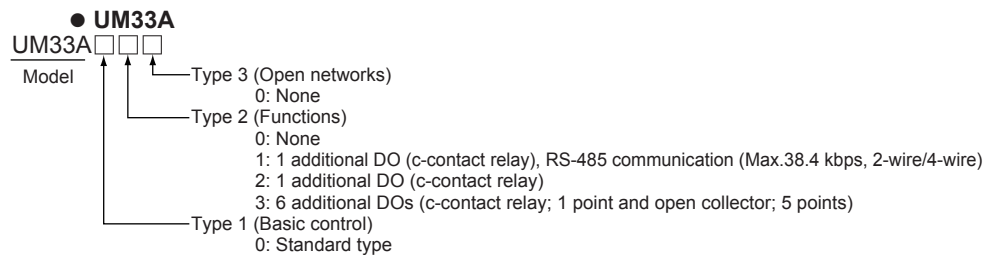
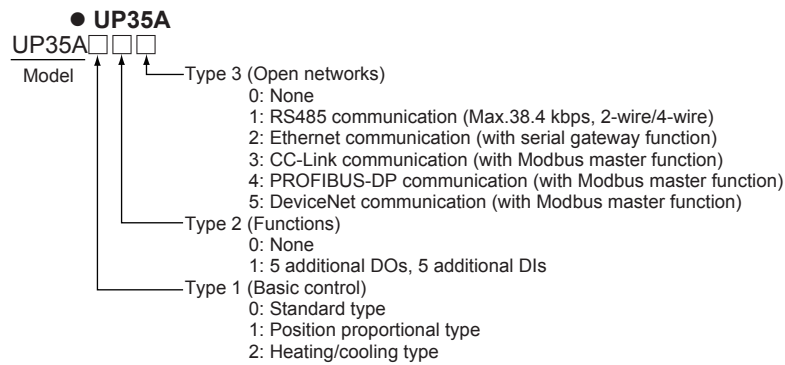

● **When GREEN Series device response is enabled (C.GRN=ON (1))**

When GREEN Series device response is enabled, the response of device information in communication is returned as GREEN Series device.

UT75A Standard type (Response is returned as UT750)

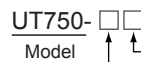

Code of UT75A		Response code is returned as UT750
0	0	None
1	1	Communication functions, auxiliary analog (remote) input
2	0	None

Code of UT75A		Response code is returned as UT750
0	0	Standard type
1	1	Position proportional type
5	5	Dual-loop type

3.2 PC Link Communication

UT55A (Response is returned as UT551)

UT551- □ □
Model

Type 2 (Functions)

Code of UT55A		Response code is returned as UT551
0	0	None
0 (when Type 3=2)	A	With Ethernet communication
1 (when Type 3=2)	1	Remote (1 additional aux. analog) input, 6 additional DIs, 4 additional DOs, and RS485 communication (Max.19.2 kbps, 2-wire/4-wire)
1 (when Type 3=2)	D	Remote (1 additional aux. analog) input, 6 additional DIs, 4 additional DOs, and Ethernet communication
2 (when Type 3=2)	2	Remote (1 additional aux. analog) input, 1 additional DI, and RS485 communication (Max.19.2 kbps, 2-wire/4-wire)
2 (when Type 3=2)	B	Remote (1 additional aux. analog) input, 1 additional DI, and Ethernet communication
3 (when Type 3=2)	3	5 additional DIs and 4 additional DOs
3 (when Type 3=2)	C	5 additional DIs and 4 additional DOs, Ethernet communication
4	4	Remote (1 additional aux. analog) input and 1 additional DI
5	4	Remote (1 additional aux. analog) input and 1 additional DI
6	3	5 additional DIs and 4 additional DOs
7	4	Remote (1 additional aux. analog) input, 1 additional DI, and 1 additional DOs

Type 1 (Basic control)

Code of UT55A		Response code is returned as UT551
0	0	Standard type
0 (with /LP)	3	Standard type (with 24V DC loop power supply)
1	1	Position proportional type
1 (with /LP)	4	Position proportional type (with 24V DC loop power supply)
2	2	Heating/cooling type

UT52A Standard type (Response is returned as UT520)

UT520- □ □
Model

Type 2 (Functions)

Code of UT52A		Response code is returned as UT520
0	0	None
1	7	Remote (1 additional aux. analog) input, 2 additional DI, and RS485 communication (Max.38.4 kbps, 2-wire)
2	8	Remote (1 additional aux. analog) input and 2 additional DI
3	0	None

Type 1 (Basic control)

Code of UT52A		Response code is returned as UT520
0	0	Standard type

UT52A Position proportional type and Heating/cooling type (Response is returned as UT551)

UT551- □ □
Model

Type 2 (Functions)

Code of UT52A		Response code is returned as UT551
0	0	None
1	2	Remote (1 additional aux. analog) input, 2 additional DI, and RS485 communication (Max.38.4 kbps, 2-wire)
2	4	Remote (1 additional aux. analog) input and 2 additional DI
3	0	None

Type 1 (Basic control)

Code of UT52A		Response code is returned as UT551
1	1	Position proportional type
2	2	Heating/cooling type

UT35A (Response is returned as UT351)

UT351- □ □
Model

Type 2 (Functions)

Code of UT35A		Response code is returned as UT351
0	0	None
0 (with /HA)	2	With heater break alarm
0 (when Type 3=1)	1	With RS-485 communication (Max.38.4 kbps, 2-wire/4-wire)
0 (when Type 3=2)	A	With Ethernet communication
1	0	None
1 (with /HA)	2	2 additional DIs, 2 additional DOs and with heater break alarm
1 (when Type 3=1)	1	2 additional DIs, 2 additional DOs and with RS-485 communication (Max.38.4 kbps, 2-wire/4-wire)
1 (when Type 3=2)	A	2 additional DIs, 2 additional DOs and with Ethernet communication
2	0	None
2 (with /HA)	2	5 additional DIs, 5 additional DOs and with heater break alarm
2 (when Type 3=1)	1	5 additional DIs, 5 additional DOs and with RS-485 communication (Max.38.4 kbps, 2-wire/4-wire)
2 (when Type 3=2)	A	5 additional DIs, 5 additional DOs and with Ethernet communication

Type 1 (Basic control)

Code of UT35A		Response code is returned as UT351
0	0	Standard type
0 (with /LP)	3	Standard type (with 24V DC loop power supply)
1	0	UT351 dose not have position proportional type (returns 0)
1 (with /LP)	3	Standard type (with 24V DC loop power supply)
2	2	Heating/cooling type

UT32A (Response is returned as UT321)

UT321- □ □
Model

Type 2 (Functions)

Code of UT32A		Response code is returned as UT321
0	0	None
0 (with /HA)	2	With heater break alarm
1	1	With RS-485 communication (Max.38.4 kbps, 2-wire/4-wire) and heater break alarm
2	0	None
2 (with /HA)	2	With heater break alarm

Type 1 (Basic control)

Code of UT32A		Response code is returned as UT321
0	0	Standard type
0 (with /LP)	3	Standard type (with 24V DC loop power supply)
1	0	UT321 dose not have position proportional type (returns 0)
1 (with /LP)	3	Standard type (with 24V DC loop power supply)
2	2	Heating/cooling type

UP55A (Response is returned as UP550)

UP550- □ □
Model

Type 2 (Functions)

Code of UP55A		Response code is returned as UP550
0	0	None
1 (when Type 3≠1)	0	None
1 (when Type 3=1)	1	Remote (1 additional aux. analog) input, 1 additional DI, and RS-485 communication (Max.38.4 kbps, 2-wire/4-wire)
2	0	None
3	0	None
4	0	None

Type 1 (Basic control)

Code of UP55A		Response code is returned as UP550
0	0	Standard type
1	1	Position proportional type
2	2	Heating/cooling type

■ INF7 Reading CPU maximum value

- Function

The CPU maximum value per one controller supporting PC link is returned.

- For details on the response format at an error, see "3.2.3 Configuration of Response."

- Command/Response (during normal operation)

Number of bytes	1	2	2	1	3	1	2	1	1
Command element	STX	Address No. (ADR)	CPU No. (01)	Response waiting time	INF	7	Checksum	ETX	CR

Number of bytes	1	2	2	2	1	2	1	1
Response element	STX	Address No. (ADR)	CPU No. (01)	OK	CPU No. maximum value (Note 1)	Checksum	ETX	CR

Note 1: The maximum value of the CPU No. on the UTAdvanced is "1."

3.2.7 Communication with FA-M3

Host computers that can use PC link communication protocol can communicate with FA-M3.

■ Communication with FA-M3 (UT link module)

The UTAdvanced can communicate with FA-M3 simply by connecting to the UT link module by PC link communication protocol.

Set the communication conditions on the UTAdvanced to the same conditions as those on the UT link module.

Communication with UT Link Module

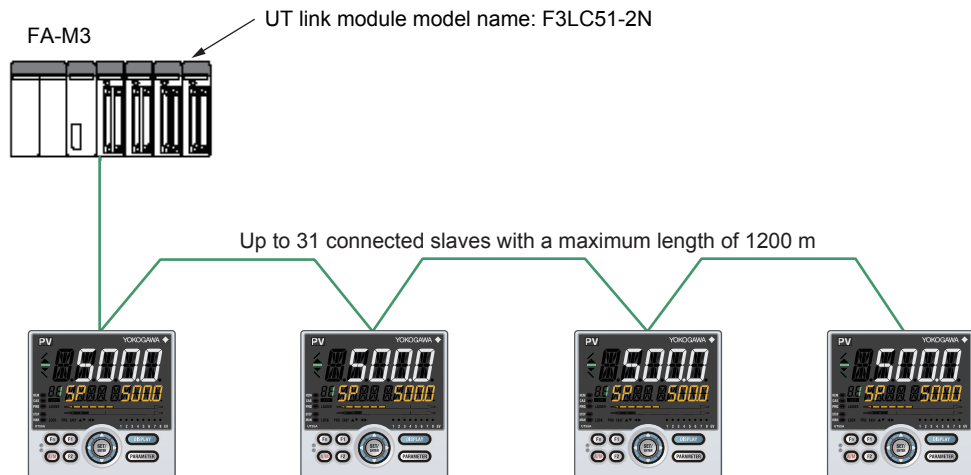

The UT link module supports two types of communication modes and command communication. So, data transactions are possible without being aware of communication. For details, see the "UT Link Module User's Manual (IM 34M06H25-01E)."

1. AUTO (automatic) mode

In this mode, fixed devices on the controller (not user-specifiable) are read and refreshed.

Fixed devices are D registers D2001 to D2025. Fixed devices cannot be written as they are the read area on the UTAdvanced.

2. MAN (manual) mode

In this mode, the devices (user-specifiable) on the UTAdvanced are read/written and refreshed manually.

▶ "Devices" here refers to D registers and I relays.

D registers and I relays: [Chapter 6 Functions and Applications of D Registers \(for UT55A/UT52A/UP55A\)](#) or [Chapter 7 Functions and Application of I Relays \(for UT55A/UT52A/UP55A\)](#)

D registers and I relays: [Chapter 8 Functions and Applications of D Registers \(for UT35A/UT32A/UP35A\)](#) or [Chapter 9 Functions and Application of I Relays \(for UT35A/UT32A/UP35A\)](#)

D registers and I relays: [Chapter 10 Functions and Applications of D Registers \(for UM33A\)](#) or [Chapter 11 Functions and Application of I Relays \(for UM33A\)](#)

D registers and I relays: [Chapter 12 Functions and Applications of D Registers \(for UT35A-L\)](#) or [Chapter 13 Functions and Application of I Relays \(for UT35A-L\)](#)

D registers and I relays: [Chapter 14 Functions and Applications of D Registers \(for UT75A\)](#) or [Chapter 15 Functions and Application of I Relays \(for UT75A\)](#)

3. Command operation

In this mode, the devices can be accessed whenever necessary.

3.3 Ladder Communication

3.3.1 Overview

By using ladder communication, you can easily perform communication between a PLC (sequencer) and UTAdvanced. This kind of communication allows for the reading/writing of D registers / I relays (internal registers of the UTAdvanced).

Hereinafter, PLC (sequencer) is referred to as PLC.

- ▶ **D registers :** [Chapter 6 Functions and Applications of D Registers \(for UT55A/UT52A/UP55A\)](#)
[Chapter 8 Functions and Applications of D Registers \(for UT35A/UT32A/UP35A\)](#)
[Chapter 10 Functions and Applications of D Registers \(for UM33A\)](#)
[Chapter 12 Functions and Applications of D Registers \(for UT35A-L\)](#)
[Chapter 14 Functions and Applications of D Registers \(for UT75A\)](#)



CAUTION

The parameters of the UTAdvanced are placed in the D registers.

If the settings of some parameters are changed, the related parameters may be initialized.

When changing the parameter setting, configure (write) the settings in the following orders.

1. Setup parameters
 - 1-1 Control mode parameter (CTLM) *1
 - 1-2 Input -related parameters *2
 - 1-3 Output-related parameters
 - 1-4 Other necessary parameters
2. Operation parameters
 - 2-1 Alarm type parameters
 - 2-2 Alarm setpoint parameters
 - 2-3 Other necessary parameters

*1: If the setting of CTLM (control mode) is changed, the related parameters will be initialized. UT35A/UT32A/UP35A/UM33A does not have the parameter CTLM (Control mode.)

*2: If the setting of IN (input type) is changed, the parameters related to ranges or scales such as target setpoint etc. will be initialized.

Connecting with Ladder Communication

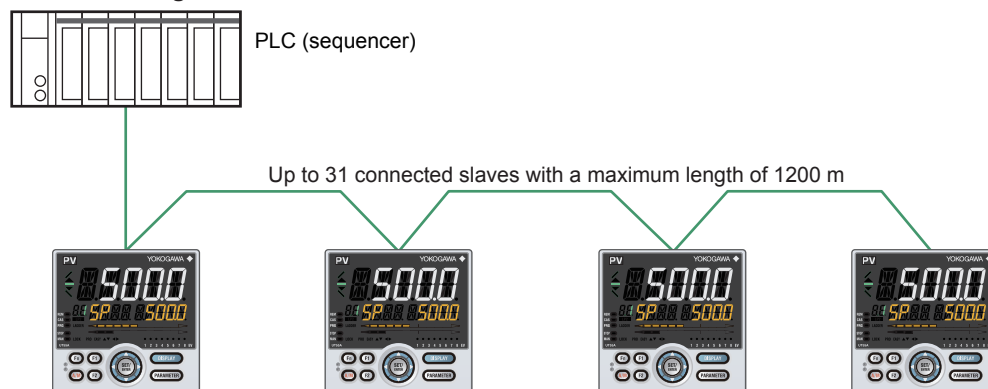

3.3 Ladder Communication

3.3.2 Configuration of Commands

Commands sent from a PLC consist of the following elements.

	(1)	(2)	(3)	(4)	(5)	(6)	(7)	(8)	(9)	
Number of bytes	1	1	2	1		1		2	1	1
Number of BCD digits	2	2	4	1	1	1	1	4	2	2
Element	Address No.	CPU No. (01)	Parameter No.	0	5th digit	R/W	+/-	Read/write data	CR (0D)	LF (0A)

(1) Address No. (01 to 99)

The address number is used by the PLC to identify which instrument to communicate with. (ID number of the UTAdvanced)

(2) CPU No.

This number is fixed to 01.

(3) Parameter No.

4-digit BCD data of a D register number with its leading character "D" removed..

(4) 0

This is fixed to 0.

(5) The 5th digit

The digit on the furthest left of the EU or EUS data when it is displayed in 5 digits. (For example, if the data value is 1234.5, the 5th digit is 1.)

(6) R/W

0: Read

1: Write

(7) +/-

0: Positive data (+)

1: Negative data (-)

(8) Read/write data

For read operation, the number of data items to be read.

For write operation, setting data with a 4-digit BCD value excluding the decimal point.

(9) CR, LF

These control codes mark the end of a command. The character codes for CR and LF are 0D and 0A in hexadecimal, respectively.

Note

The UTAdvanced displays data in 5 digits. Data that is read / written via communication also consists of 5 digits. However, if you do not need to use 5-digit data for communication, set the data display digits of the controller to no more than 4 digits.

● Data Forms of Commands

The table below shows the data forms of D registers.

Data type	Data content	Data form
PV high and low limits, target setpoints, and others	PV range (EU) data	Numeric data not including the decimal point
Bias, deviation alarms, and others	PV range span (EUS) data	Numeric data not including the decimal point
Proportional bands, output high and low limits, and others	% data (0.0 to 100.0%)	Numeric data not including the decimal point 0 to 1000
Various modes, alarm types, and others	Seconds, absolute values, and data without unit	Absolute value not including the decimal point
Various status (The type of statuses are different by the model.) AD1.E, PV1.E_L1, MOD_L1, ALM_L1, LA.ER, ALM_L2, PV2.E_L2, MOD_L2, ALO_L1, ALO_L2, PV_EV1-8, TME_EV1-8, TME_EV9-16, PV_EV_OUT, CT_AL, AD2.E, DIMG, PA.ER, OP.ER, ALOLA1_L1, ALOLA1_L2, ALOLA2_L1, ALOLA2_L2, ALOLA3_L1, ALOLA3_L2, ALOLA4_L1, ALOLA4_L2	Mode status, alarm status, error status	HEX code For example, when the status is "0x1234", the "1234" in BCD code is returned.

● Command Format for Communication

Example: When setting a target setpoint "50.0," the PLC sends the value "500" excluding the decimal point as command data (this is also true for setting 5.00 or 500).

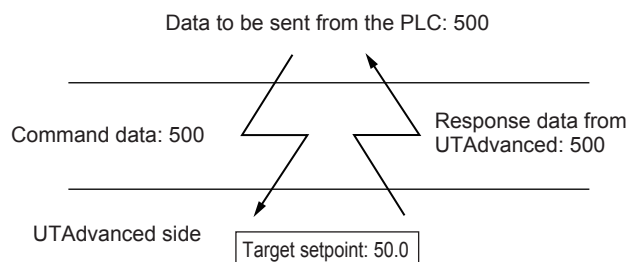

* The UTAdvanced determine the decimal point position for "500" by the decimal point position parameter setting (in this case, P.DP = 1).

3.3.3 Configuration of Responses

Response from a UTAdvanced with respect to a command sent from the PLC consists of the elements shown below.

Number of Bytes	1	1	2	1		1	2	1	1	
Number of BCD digits	2	2	4	1	1	1	4	2	2	
Element	Address No.	CPU No. (01)	Parameter No.	0	5th digit	R/W	+/-	Read/write data	CR (0D)	LF (0A)

When responding to a data read command, the length of this part varies: 64 data items at maximum.

3.3 Ladder Communication

3.3.4 Communication with PLC

With ladder communication you cannot specify D registers by using their numbers as is. Set register numbers as shown below.

D register: 4-digit BCD value of the register number with its leading character "D" removed.

PLCs that can communicate with UTAdvanced are those capable of using the ladder communication protocol.

PLCs that can be connected to a UTAdvanced are listed below.

Supplier	Product	Requirement	Remarks
Yokogawa Electric Corporation	FA-M3	With communication module (F3RZ91-0F)	(Note)
Mitsubishi Electric Corporation, or others	MELSEC-Q series and others	With Serial communication unit	
	PLCs that can communicate in non-procedural.	With computer link unit	

Note: For more information about the PLCs listed above, contact the supplier.

For details, see the user's manual of the PCL to be connected.

■ Reading Data

Shown below are the configurations of commands and responses when data in a UTAdvanced is read by the PLC.

● Command

Number of Bytes	1	1	2	1	1	2	1	1		
Number of BCD digits	2	2	4	1	1	4	2	2		
Element	Address No.	CPU No. (01)	Parameter No.	0	5th digit	0	0	Number of data items to read	CR	LF

● Response

Number of Bytes	1	1	2	1	1	2	1	1	1	2			
Number of BCD digits	2	2	4	1	1	4	1	1	1	4			
Element	Address No.	CPU No. (01)	Parameter No.	0	5th digit	0	+/-	dddd1	0	5th digit	0	+/-	dddd2
				Data of the parameter number (first data)				Data of the parameter number (second data)					

Continuation of response

	1	1	2	1	1		
...	1	1	4	2	2		
...	0	5th digit	0	+/-	dddnn	CR	LF
	Data of the parameter number (nth data)						

■ Writing Data

Shown below are the configurations of commands and responses when data is written to a UTAdvanced from the PLC.

● Command

Number of Bytes	1	1	2	1		1		2	1	1
Number of BCD digits	2	2	4	1	1	1	1	4	2	2
Element	Address No.	CPU No. (01)	Parameter No.	0	5th digit	1	+/-	dddd	CR	LF

● Response

Number of Bytes	1	1	2	1		1		2	1	1
Number of BCD digits	2	2	4	1	1	1	1	4	2	2
Element	Address No.	CPU No. (01)	Parameter No.	0	5th digit	1	+/-	dddd	CR	LF

3.3.5 Response Error Codes

The PLC may receive the following responses in the event of error.

Response in the Event of Error

Error condition	Data sent from PLC	Data PLC receives
A non-existing parameter number was sent.	0101 0000 0000 0001 CRLF 0000: The wrong parameter number.	0101 0000 0000 FFFF CRLF FFFF: Returned.
Characters other than BCD codes were used in an element other than an address number.	0101 0123 0000 000B CRLF 0101 0123 000B 0000 CRLF 0101 0123 0B00 0000 CRLF 0101 012B 0000 0000 CRLF	0101 FFFF FFFF FFFF CRLF
An LF code (0A) was used in an element other than an address number.	0101 0123 0000 000A CRLF 0101 0123 000A 0000 CRLF 0101 0123 0A00 0000 CRLF 0101 010A 0000 0000 CRLF	No response
Specified address number or CPU number does not match any of the controllers connected.	01 03 0123 0000 0000 CRLF 0001 0123 0000 0000 CRLF	No response
The write data was outside the range.	0101 0123 0011 9999 CRLF 9999: The data outside the range.	0101 0123 0011 0050 CRLF 0050: The current setting of the parameter.
Wrong command length. (Command length is 10 bytes including CR and LF codes.)	0101 0123 0000 00 CRLF 0101 0123 00 0000 CRLF 0101 0 0000 0000 CRLF	No response
A timeout occurred when sending data. (Timeout: 5 seconds)	—	No response
Send buffer overflowed. (The buffer capacity is 512 bytes.)	—	No response
A framing error or a parity error occurred.	—	No response

Note

If you try to read data of a parameter number that is not in the D register table, or that corresponds to a vacant cell in that table, no error occurs and 0 is returned.

- ▶ **D registers** : [Chapter 6 Functions and Applications of D Registers \(for UT55A/UT52A/UP55A\)](#)
[Chapter 8 Functions and Applications of D Registers \(for UT35A/UT32A/UP35A\)](#)
[Chapter 10 Functions and Applications of D Registers \(for UM33A\)](#)
[Chapter 12 Functions and Applications of D Registers \(for UT35A-L\)](#)
[Chapter 14 Functions and Applications of D Registers \(for UT75A\)](#)

4.1 Overview

The Modbus/TCP is a communication protocol used for performing communication with a general-purpose PC, PLC (sequencer), touch panel, or other device using TCP/IP protocol via Ethernet or other network.

Internal registers on UT75A/UT55A/UT35A/UP55A/UP35A are read and written, and data transactions performed with connected devices via this communication protocol.

The UT75A/UT55A/UT35A/UP55A/UP35A can be connected to IEEE802.3-compliant networks (10BASE-T/100BASE-TX), and communication with the Modbus/TCP protocol is generally performed on port No. 502. (The port No. can be changed.)

Moreover, the UT75A/UT55A/UT35A/UP55A/UP35A operates as an Ethernet serial gateway. The host computer can read/writes data from/to other devices equipped with serial communication function using the MODBUS/TCP protocol via the UT75A/UT55A/UT35A/UP55A/UP35A.

- ▶ [D registers: Chapter 6 Functions and Applications of D Registers \(for UT55A/UT52A/UP55A\)](#)
[Chapter 8 Functions and Applications of D Registers \(for UT35A/UT32A/UP35A\)](#)
[Chapter 12 Functions and Applications of D Registers \(for UT35A-L\)](#)
[Chapter 14 Functions and Applications of D Registers \(for UT75A\)](#)
- ▶ [Process Data High-speed Response Function: 4.6 Process Data High-speed Response Function](#)



CAUTION

The parameters of the UTAdvanced are placed in the D registers.

If the settings of some parameters are changed, the related parameters may be initialized.

When changing the parameter setting, configure (write) the settings in the following orders.

1. Setup parameters
 - 1-1 Control mode parameter (CTLM) *1
 - 1-2 Input -related parameters *2
 - 1-3 Output-related parameters
 - 1-4 Other necessary parameters
2. Operation parameters
 - 2-1 Alarm type parameters
 - 2-2 Alarm setpoint parameters
 - 2-3 Other necessary parameters

*1: If the setting of CTLM (control mode) is changed, the related parameters will be initialized. UT35A/UP35A does not have the parameter CTLM (Control mode.)

*2: If the setting of IN (input type) is changed, the parameters related to ranges or scales such as target setpoint etc. will be initialized.

4.1 Overview

Network Layers

Application layer
Transport layer
Network layer
Data link layer
Physical layer

Host computer (such as PC)
↕
Modbus/TCP
TCP
IP
Ethernet
10BASE-T/100BASE-TX

Overview of Ethernet Communication Connection

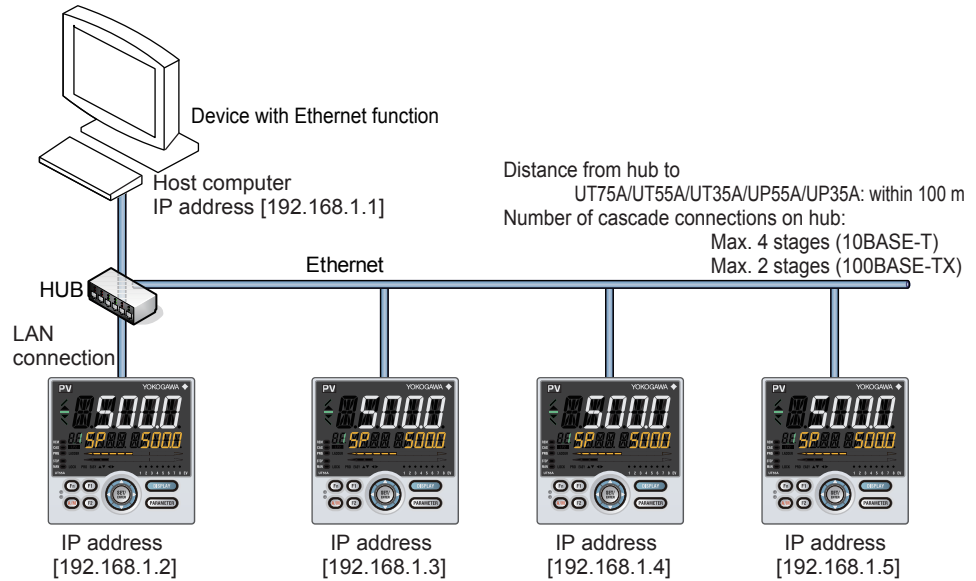

4.2 TCP/IP-based Communication

Modbus/TCP performs transactions by the procedure in the figure below on the TCP/IP socket interface.

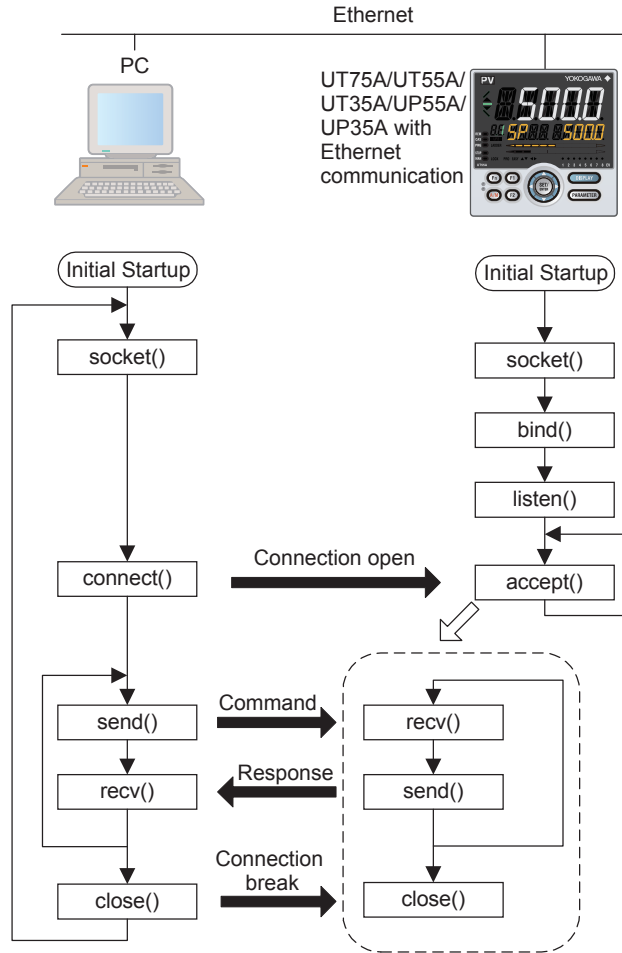

Note

If there is no request for at least 60 seconds from the host computer after the connection is established, the UT75A/UT55A/UT35A/UP55A/UP35A breaks the connection.

4.3 Configuration of Network Frames

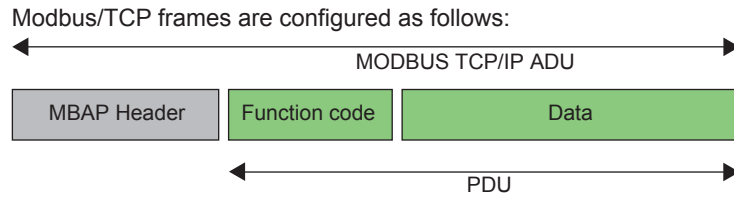

MBAP Header (Modbus Application Protocol Header): Header for identifying that the protocol is Modbus/TCP

PDU (Protocol Data Unit): Body of data communication

4.3.1 Configuration of MBAP Header

The MBAP header comprises seven bytes as follows:

Byte No	0	1	2	3	4	5	6
Content	Transfer ID		Protocol ID		Number of bytes		Unit ID

Transfer ID: The host computer specifies an arbitrary value for identifying transactions. The UT75A/UT55A/UT35A/UP55A/UP35A returns the value received from the host computer as the response.

Protocol ID: "0" is specified in the case of the Modbus/TCP protocol.

Number of bytes: Number of bytes from the unit ID (byte No.6) onwards

Unit ID: The host computer specifies "1" and the UT75A/UT55A/UT35A/UP55A/UP35A returns "1" as the response. For the communication with the device connected to the RS-485 communication terminals using the Ethernet-serial gateway function, specify its communication address (2 to 99).

4.3.2 Configuration of PDU

The PDU (Protocol Data Unit) comprises n bytes as follows:

Byte No	0	1 onwards (n-1)
Content	Function code	Data

Function code: The instruction from the host computer is specified.

Data: The D register No. and number, parameter values, and the like of internal registers are specified according to the function code.

4.4 Communication with Host Computer

4.4.1 List of Function Codes

These instruction words are used so that the host computer obtains the D register and I relay information of the UT75A/UT55A/UT35A/UP55A/UP35A.

List of Function Codes

Code No.	Function	Description
01	Reading of multiple I relays	Up to 256 registers can be read continuously (I4001 to I7072).
03	Reading of multiple D registers	Up to 100 registers can be read continuously (D0001 to D7600) *.
05	Writing of I relays	Only one register can be written (I4001 to I7072).
06	Writing of D registers	Only one register can be written (D0001 to D7600) *.
08	Loopback test	This is used to check the communication connection.
15	Writing of multiple I relays	Up to 256 registers can be written continuously (I4001 to I7072).
16	Writing of multiple D registers	Up to 50 registers can be written continuously (D0001 to D7600) *.
66	Random reading	Up to 100 registers can be read at random (D0001 to D7600) *.
67	Random writing	Up to 50 registers can be read at random (D0001 to D7600) *.
68	Specify monitor	Up to 100 registers can be specified at random for monitoring (D0001 to D7600) *.
69	Monitoring	The register specified by "specify monitor" is read.
70	Writing of multiple D registers for program pattern	Up to 80 D registers can be written continuously (D8001 to D9000).

*: When UP55A/UP35A; D0001 to D9000

Function codes cannot be written to read-only or use-disabled registers.

4.4.2 Specifying D Registers

Specify D registers from the host computer by the following procedure:

- (1) When using SCADA etc. commercially available, specify the Ref No. described in the following chapter.
 Chapter 6, "Functions and Applications of D Registers (for UT55A/UT52A/UP55A)."
 Chapter 8, "Functions and Applications of D Registers (for UT35A/UT32A/UP35A)."
 Chapter 14, "Functions and Applications of D Registers (for UT75A)."
- (2) When using a communication program made by the user. commercially available, specify the H-No. described in the following chapter.
 Chapter 6, "Functions and Applications of D Registers (for UT55A/UT52A/UP55A)."
 Chapter 8, "Functions and Applications of D Registers (for UT35A/UT32A/UP35A)."
 Chapter 14, "Functions and Applications of D Registers (for UT75A)."

4.4 Communication with Host Computer

4.4.3 Requests and Responses

■ 01 Reading multiple I relays

● Function

The content of I relays is read continuously for the specified number of relays from the specified I relay No.

- The maximum number of relays that can be read at a time is 256.
- For details on the response format at an error, see “4.4.4 Response Error Codes.”
- The response status of I relays is one bit for each I relay.

The bit indicates: 1 = ON and 0 = OFF. The LSB of the first data item indicates the status of the read start I relay.

If the status of I relay Nos. 20 to 27 is supposed to be ON-ON-OFF-OFF-ON-OFF-ON-OFF, it is expressed as 01010011 (0x53) in the binary number.

The status of eight I relays is represented by one byte. If the maximum number of I relays is short of eight I relays in the last data item, the remaining empty space is filled with zero.

● Request (during normal operation) Read n number of data

Element	MBAP Header				PDU		
Number of bytes	2	2	2	1	1	2	2
Command element	Transfer ID	Protocol ID	Number of bytes	Unit ID	Function code	I relay start No.	Number of I relays
(Hex)	Optional value	0000	0006	01	01		n

● Response (during normal operation)

Element	MBAP Header				PDU				
Number of bytes	2	2	2	1	1	1	1	• • •	1
Command element	Transfer ID	Protocol ID	Number of bytes	Unit ID	Function code	Byte count (Note 1)	I relay content 1	• • •	I relay content N
(Hex)	Optional value	0000	N+3	01	01	N			

Note 1: When the byte count is assumed to be “N,” N = Number of read I relays / 8 (however, N = N + 1 when the remainder is not zero).

■ 03 Reading multiple D registers

● Function

The content of D registers is read continuously for the specified number of registers from the specified D register No.

- The maximum number of registers that can be read at a time is 100.
- For details on the response format at an error, see “4.4.4 Response Error Codes.”

● Request (during normal operation) Read n number of data

Element	MBAP Header				PDU		
Number of bytes	2	2	2	1	1	2	2
Command element	Transfer ID	Protocol ID	Number of bytes	Unit ID	Function code	Register start No.	Number of registers
(Hex)	Optional value	0000	0006	01	03		n

● Response (during normal operation)

Element	MBAP Header				PDU				
Number of bytes	2	2	2	1	1	1	2	• • •	2
Command element	Transfer ID	Protocol ID	Number of bytes	Unit ID	Function code	Byte count	Register content 1	• • •	Register content n
(Hex)	Optional value	0000	2n+3	01	03	2n			

■ 05 Writing to an I relay

- Function

Data is written to the specified I relay No.

- The number of relays that can be written at a time is 1.
- For details on the response format at an error, see “4.4.4 Response Error Codes.”
- The write data 0xFF00 and 0x0000 indicate ON (1) and OFF (0) respectively. When data other than these is set, the response is a normal response, but the data is not written.

- Request (during normal operation)

Element	MBAP Header				PDU		
Number of bytes	2	2	2	1	1	2	2
Command element	Transfer ID	Protocol ID	Number of bytes	Unit ID	Function code	I relay No.	Write data
(Hex)	Optional value	0000	0006	01	05		

- Response (during normal operation)

Element	MBAP Header				PDU		
Number of bytes	2	2	2	1	1	2	2
Command element	Transfer ID	Protocol ID	Number of bytes	Unit ID	Function code	I relay No.	Write data
(Hex)	Optional value	0000	0006	01	05		

■ 06 Writing to a D register

- Function

Data is written to the specified D register No.

- The number of registers that can be written at a time is 1.
- For details on the response format at an error, see “4.4.4 Response Error Codes.”
- When the data out of setting range of the parameter is set, the response is a normal response, but the data is not written.

- Request (during normal operation)

Element	MBAP Header				PDU		
Number of bytes	2	2	2	1	1	2	2
Command element	Transfer ID	Protocol ID	Number of bytes	Unit ID	Function code	Register No.	Write data
(Hex)	Optional value	0000	0006	01	06		

- Response (during normal operation)

Element	MBAP Header				PDU		
Number of bytes	2	2	2	1	1	2	2
Command element	Transfer ID	Protocol ID	Number of bytes	Unit ID	Function code	Register No.	Write data
(Hex)	Optional value	0000	0006	01	06		

4.4 Communication with Host Computer

■ 08 Loopback test

- Function

This is used to check the communication connection.

- For details on the response format at an error, see “4.4.4 Response Error Codes.”
- The “0000” shown below (marked with an asterisk *) is fixed.
- Any data can be selected for the send data.

- Request (during normal operation)

Element	MBAP Header				PDU		
Number of bytes	2	2	2	1	1	2	2
Command element	Transfer ID	Protocol ID	Number of bytes	Unit ID	Function code	0000*	Send data
(Hex)	Optional value	0000	0006	01	08	0000	Optional value

- Response (during normal operation)

Element	MBAP Header				PDU		
Number of bytes	2	2	2	1	1	2	2
Command element	Transfer ID	Protocol ID	Number of bytes	Unit ID	Function code	0000*	Send data
(Hex)	Optional value	0000	0006	01	08	0000	Optional value

■ 15 Writing to multiple I relays

- Function

Data is written to I relays continuously for the specified number of relays from the specified I relay No.

- The maximum number of relays that can be written at a time is 256.
- For details on the response format at an error, see “4.4.4 Response Error Codes.”
- The data to be written is one bit for each I relay.

The bit indicates: 1 = ON and 0 = OFF. The LSB of the first written data item indicates the status of the write start I relay.

The status of 8 I relays is represented by one byte. If the maximum number of I relays is exceeded by the last written data, the exceeding part of the data item is not written.

- Request (during normal operation) Write n number of data

Element	MBAP Header				PDU		
Number of bytes	2	2	2	1	1	2	2
Command element	Transfer ID	Protocol ID	Number of bytes	Unit ID	Function code	I relay start No.	Number of I relays
(Hex)	Optional value	0000	N+7	01	0F		n

Continuation of request

PDU			
1	1		1
Byte count (Note 1)	Data 1	• • •	Data N
N			

Note 1: When the byte count is assumed to be “N,” N = Number of write I relays / 8 (however, N = N + 1 when the remainder is not zero).

- Response (during normal operation)

Element	MBAP Header				PDU		
Number of bytes	2	2	2	1	1	2	2
Command element	Transfer ID	Protocol ID	Number of bytes	Unit ID	Function code	I relay start No.	Number of I relays
(Hex)	Optional value	0000	0006	01	0F		n

4.4 Communication with Host Computer

■ 16 Writing to multiple D registers

- Function

Data is written to D registers continuously for the specified number of registers from the specified D register No.

- The maximum number of registers that can be written at a time is 50.
- For details on the response format at an error, see “4.4.4 Response Error Codes.”
- When the data out of setting range of the parameter is set, the response is a normal response, but the data is not written.

- Request (during normal operation) Write n number of data

Element	MBAP Header				PDU		
Number of bytes	2	2	2	1	1	2	2
Command element	Transfer ID	Protocol ID	Number of bytes	Unit ID	Function code	Register start No.	Number of registers
(Hex)	Optional value	0000	2n+7	01	10		n

Continuation of request

PDU			
1	2		2
Byte count	Data 1	• • •	Data n
2n			

- Response (during normal operation)

Element	MBAP Header				PDU		
Number of bytes	2	2	2	1	1	2	2
Command element	Transfer ID	Protocol ID	Number of bytes	Unit ID	Function code	Register start No.	Number of registers
(Hex)	Optional value	0000	0006	01	10		n

■ 66 Random reading

- Function
The register data of register Nos. specified at random is read.
 - Register Nos. can be specified from all register areas
 - The maximum number of registers that can be set is 100.
 - For details on the response format at an error, see “4.4.4 Response Error Codes.”
- Request (during normal operation) Read n number of data

Element	MBAP Header				PDU		
Number of bytes	2	2	2	1	1	2	1
Command element	Transfer ID	Protocol ID	Number of bytes	Unit ID	Function code	Number of registers	Byte count
(Hex)	Optional value	0000	2n+5	01	42	n	2n

Continuation of request

PDU		
2		2
Specified register No.1	• • •	Specified register No.n

- Response (during normal operation)

Element	MBAP Header				PDU				
Number of bytes	2	2	2	1	1	1	2		2
Command element	Transfer ID	Protocol ID	Number of bytes	Unit ID	Function code	Byte count	Register content 1	• • •	Register content n
(Hex)	Optional value	0000	2n+3	01	42	2n			

■ 67 Random writing

- Function
The register No. and data of register Nos. specified at random is written.
 - Register Nos. can be specified from all register areas.
 - The maximum number of registers that can be written at a time is 50.
 - For details on the response format at an error, see “4.4.4 Response Error Codes.”
- Request (during normal operation)

Element	MBAP Header				PDU		
Number of bytes	2	2	2	1	1	2	2
Command element	Transfer ID	Protocol ID	Number of bytes	Unit ID	Function code	Number of registers	Byte count
(Hex)	Optional value	0000	4n+6	01	43	n	4n

Continuation of request

PDU				
2	2		2	2
Specified register No.1	Data 1	• • •	Specified register No.n	Data n

- Response (during normal operation)

Element	MBAP Header				PDU	
Number of bytes	2	2	2	1	1	2
Command element	Transfer ID	Protocol ID	Number of bytes	Unit ID	Function code	Number of registers
(Hex)	Optional value	0000	0004	01	43	n

4.4 Communication with Host Computer

■ 68 Specify monitor

- Function
The register No. specified at random can be specified for monitoring.
 - The maximum number of registers that can be specified for monitoring is 100.
 - For details on the response format at an error, see “4.4.4 Response Error Codes.”
- Request (during normal operation)

Element	MBAP Header				PDU		
	2	2	2	1	1	2	1
Command element	Transfer ID	Protocol ID	Number of bytes	Unit ID	Function code	Number of registers	Byte count
(Hex)	Optional value	0000	2n+5	01	44	n	2n

Continuation of request

PDU		
2		2
Specified register No.1	• • •	Specified register No.n

- Response (during normal operation)

Element	MBAP Header				PDU	
	2	2	2	1	1	1
Command element	Transfer ID	Protocol ID	Number of bytes	Unit ID	Function code	Byte count
(Hex)	Optional value	0000	0003	01	44	2n

■ 69 Monitoring

- Function
The content of the register specified for monitoring by function code “68” is read.
 - For details on the response format at an error, see “4.4.4 Response Error Codes.”
- Request (during normal operation)

Element	MBAP Header				PDU
	2	2	2	1	1
Command element	Transfer ID	Protocol ID	Number of bytes	Unit ID	Function code
(Hex)	Optional value	0000	0002	01	45

- Response (during normal operation)

Element	MBAP Header				PDU				
	2	2	2	1	1	1	2	• • •	2
Command element	Transfer ID	Protocol ID	Number of bytes	Unit ID	Function code	Byte count	Register content 1	• • •	Register content n
(Hex)	Optional value	0000	2n+3	01	45	2n (Note 1)			

Note 1: The byte count specified by function code “68” is returned.

■ 70 Writing to multiple D registers for program pattern

- Function

Data is written to D registers continuously for the specified number of registers from the specified D register No.

Can be specified register areas: D8001 to D9000.

- The maximum number of registers that can be written at a time is 80.
- For details on the response format at an error, see "4.4.4 Response Error Codes."
- When the data out of setting range of the parameter is set, the response is a normal response, but the data is not written.

- Request (during normal operation) Write n number of data

Element	MBAP Header				PDU		
	2	2	2	1	1	2	2
Command element	Transfer ID	Protocol ID	Number of bytes	Unit ID	Function code	Register start No.	Number of registers
(Hex)	Optional value	0000	2n+7	01	0x46		n

Continuation of request

PDU			
1	2		2
Byte count	Data 1	• • •	Data n
2n			

- Response (during normal operation)

Element	MBAP Header				PDU	
	2	2	2	1	1	1
Command element	Transfer ID	Protocol ID	Number of bytes	Unit ID	Function code	Error code (Note 1)
(Hex)	Optional value	0000	0003	01	0x46	

Note 1: See the "Error Information" of "6.4.10 Program Pattern for UP55A (D8001 to D9000)" or "8.4.8 Program Pattern for UP35A (D8001 to D9000)" in this manual.

► Writing via Communication:

6.4.10 Program pattern for UP55A (D8001 to D9000) or 8.4.8 Program pattern for UP35A (D8000 to D9000) in this manual

4.4 Communication with Host Computer

4.4.4 Response Error Codes

- When a response is returned to a request:

When the PDU in the request contains an inconsistency, the UT75A/UT55A/UT35A/UP55A/UP35A does not perform any processing, and returns the following request.

Element	MBAP Header				PDU	
Number of bytes	2	2	2	1	1	1
Command element	Transfer ID	Protocol ID	Number of bytes	Unit ID	Function code*	Error Code
(Hex)	Optional value	0000	03	01		

* The value of "function code (Hex) + 80 (Hex)" is set in the function code.

- Response error codes

Error Code	Meaning	Cause
01	Function code error	The function code does not exist.
02	D register/I relay No. error	A No. outside the range has been specified.
03	Number of D registers/I relays error	A number of registers/relays outside the range has been specified.
09	Monitor not specified	An attempt was made to read a monitor without specifying the monitor.

- When a response is not returned to a request

In the following instances, the UT75A/UT55A/UT35A/UP55A/UP35A does not perform any processing and does not return a response:

- When a connection has not been established on the TPC/IP socket interface
- When the MBAP Header in a request contains an inconsistency

* As a measure for the above, execute time-out processing by the communication function or communication program on the host computer.

4.5 Ethernet-Serial Gateway Function

4.5.1 Overview

The Ethernet-serial gateway function is a function that reads/writes data from/to other devices equipped with RS-485 serial communication function using the MODBUS/TCP protocol via the UT75A/UT55A/UT35A/UP55A/UP35A. With this function, the host computer can access the devices connected to the RS-485 serial communication line in the same way as to access the devices connected to Ethernet.

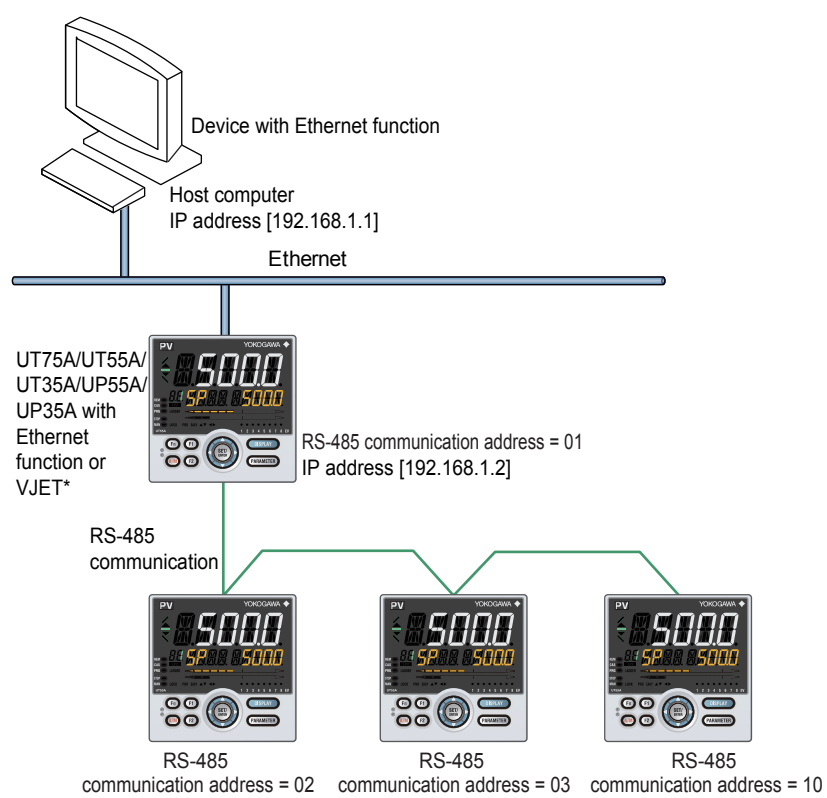

*: VJET is the converter of YOKOGAWA. See the user's manual for VJET when using it.

The UT75A/UT55A/UT35A/UP55A/UP35A operates as a gateway that changes the MODBUS/TCP protocol received via network to the MODBUS/RTU protocol for the serial devices connected to the RS-485 communication interface. Therefore, the devices supporting the MODBUS/RTU protocol are required for the devices to be connected.

Note

When Ethernet communication is used, the RS-485 communication interface of the UT75A/UT55A/UT35A/UP55A/UP35A is exclusively for the Ethernet-serial gateway function. PCs and other host computers cannot access the UT55A/UT35A/UP55A/UP35A via this RS-485 communication interface.

4.5 Ethernet-Serial Gateway Function

4.5.2 Wiring for Communication with Serial Devices

For wiring, see the Operation Guide or User's Manual. A maximum of 31 serial devices are connectable. Set a communication address (02 to 99) different from each other for each device.

Note

When Ethernet-serial gateway function is used, do not set the communication address '1' for the RS-485 communication serial devices connected to the Ethernet-connected UT75A/UT55A/UT35A/UP55A/UP35A.

- Setting for Devices Working as Ethernet-serial Gateway Function
Set the following communication conditions.

Parameter symbol	Group display	Name	Setting range		Menu symbol	Initial value
BPS	E3	Baud rate	9600 bps	9600 (4)	ETHR	38400 (6)
			19200 bps	19200 (5)		
			38400 bps	38400 (6)		
PRI		Parity	None	NONE (0)		EVEN (1)
			Even	EVEN (1)		
			Odd	ODD (2)		

Figures in parentheses “()” are values to be set when performing communication.

- Setting for Serial Devices Connected to Ethernet-connected UT55A/UT35A/UP55A/UP35A
Set the following communication conditions for the serial devices connected to the RS-485 communication line.

Parameter symbol	Group display	Name	Setting range		Menu symbol	Initial value
PSL	UT75A/ UT55A/ UP55A:	Protocol selection	Modbus (RTU)	MBRTU (8)	R485	MBRTU (8)
BPS	E3, E4	Baud rate	9600 bps	9600 (4)		19200 (5)
			19200 bps	19200 (5)		
			38400 bps	38400 (6)		
PRI	UT52A/ UT32A/ UM33A: E1	Parity	None	NONE (0)		EVEN (1)
			Even	EVEN (1)		
			Odd	ODD (2)		
STP	UT35A/ UP35A: E3	Stop bit	1 bit	1 (1)		1 (1)
DLN		Data length	8 bits	8 (8)	8 (8)	
ADR		Address	2 to 99		1	

Figures in parentheses “()” are values to be set when performing communication.

- How to Access Serial Devices
See “4.3 Configuration of Network Frame.”

4.6 Process Data High-speed Response Function

4.6.1 Overview

The UT75A/UT55A/UT35A/UP55A/UP35A has a function that reads periodically the process data from the UT75A/UT55A/UT35A/UP55A/UP35A itself and the process data from other serial devices connected to the RS-485 serial communication line and stores them in the UT75A/UT55A/UT35A/UP55A/UP35A.

With this function, when process data read-out command is sent from the host computer, the UT75A/UT55A/UT35A/UP55A/UP35A can return the process data stored in itself at high speed, without communicating with the serial devices one by one. This function is called the Process data high-speed response function.

The figure below shows the data flow when the host computer reads process data in the case of not using / using the function.

When Process Data High-speed Response Function is not Used

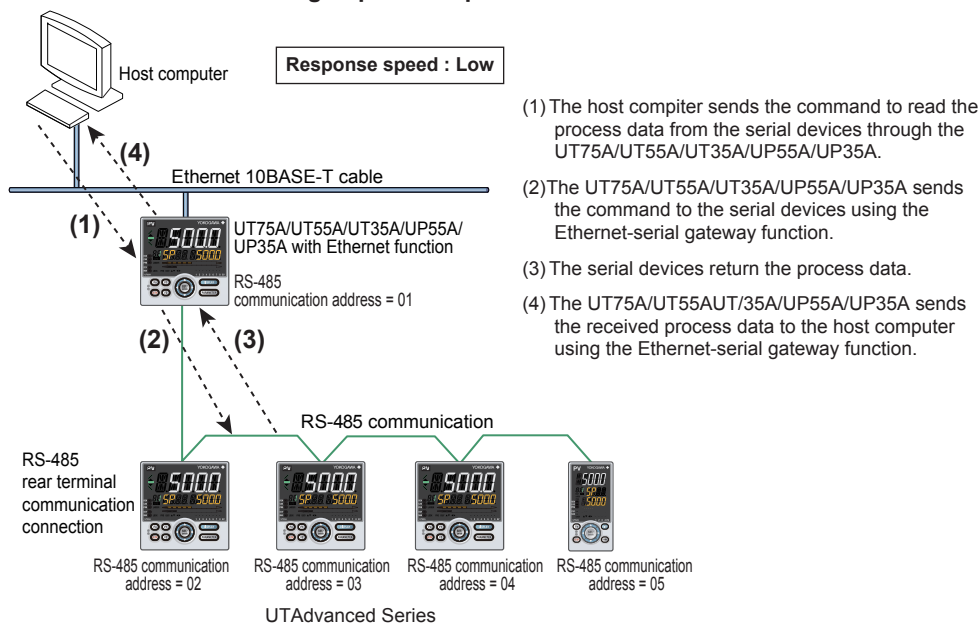

When Process Data High-speed Response Function is Used

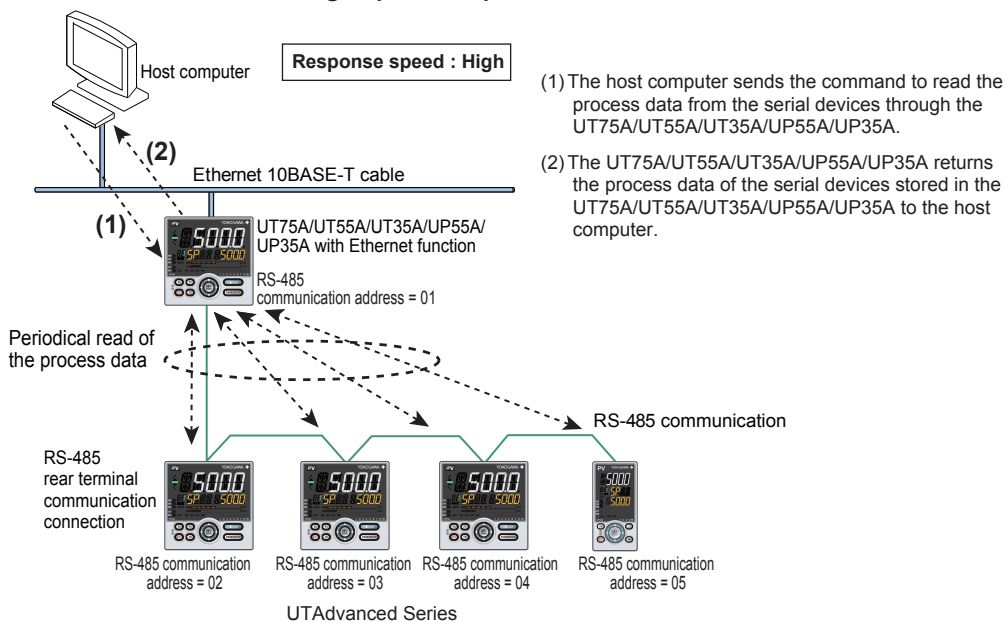

4.6 Process Data High-speed Response Function

The function can read periodically the process data from a maximum of 8 serial devices, store them in the UT75A/UT55A/UT35A/UP55A/UP35A, and return the response at high speed.

However, the function can be used for a maximum of 7 serial devices connected to the RS-485 communication line because the serial communication address "1" is for UT75A/UT55A/UT35A/UP55A/UP35A.

Note

- The period to read the process data from other serial devices cannot be specified. The UT75A/UT55A/UT35A/UP55A/UP35A reads the process data by the fastest automatically according to the number of serial devices for which the function is used.
- If the number of serial devices for which the function is used is particularly large, the process data value of each serial device stored in the UT75A/UT55A/UT35A/UP55A/UP35A may be delayed relative to the actual process. If the delay becomes a problem, turn this function off.

4.6.2 How to Set the Function

The parameter HSR specifies the operation of the function.

Parameter symbol	Group display	Name	Setting Range	Menu symbol	Initial value
HSR	E3	High-speed response mode	0: OFF (The process data high-speed response function is not used.) 1: The process data of the device itself is returned as a response at high speed. 2 to 8 :The process data of the device itself and the process data from the serial devices connected to the RS-485 communication line are returned as a response at high speed. Specify the maximum address of the serial devices. Note: Set the continuous communication address which begins from "2" for other serial communication devices connected to the RS-485 communication terminals. After setting the parameter HSR, set "1" for the parameter ESW to update the setting. If you change other parameters, update the setting at the end.	ETHR	1

Note

- A maximum of 31 serial devices are connectable to the RS-485 communication line. Set the serial communication address (2 to 99) for each device so that the host computer can access using the Ethernet-serial gateway function. However, the function can be used only for the serial devices with the continuous communication addresses from 2 to 8. Set the serial communication addresses from 2 to 8 for the serial devices for which the function is to be used.
- Simply changing the value for the above parameters does not enable the setting content. Be sure to update the setting content by setting the Ethernet setting switch (ESW) to ON (1) after the setting is made.
The setting content is also enabled by performing the power ON/OFF operation of the UT75A/UT55A/UT35A/UP55A/UP35A.

* It takes about 20 seconds for the new settings of the Ethernet communication parameters to be enabled.

4.6.3 Process Data for High-speed Response

The function treats from D2001 to D2025 as process data in D register map, regardless of the kind of the serial devices connected to the RS-485 communication line.

The UT75A/UT55A/UT35A/UP55A/UP35A reads this data periodically from the serial devices for which the function is used and returns a response at high speed to the command to read data from multiple registers (function code: 03) in this category from the host computer.

Note

- For D register map, see the user's manual of the connected instrument.
For UT75A/UT55A/UT35A/UP55A/UP35A, see Chapter 6, "Functions and Applications of D Registers (for UT55A/UT52A/UP55A)", Chapter 8, "Functions and Applications of D Registers (for UT35A/UT32A/UP35A)" or Chapter 14, "Functions and Applications of D Registers (for UT75A)."
- If the GREEN Series device response is enabled (C.GRN = ON (1)), the process data for which the high-speed response is applied is changed to from D001 to D0025 to enable the connection of GREEN Series devices.

4.7 IP Access Restriction Function

The UT75A/UT55A/UT35A/UP55A/UP35A has an IP access control function to permit access from registered IP addresses and reject access from unregistered IP addresses. This function is able to prevent unauthorized access and thereby increase security.

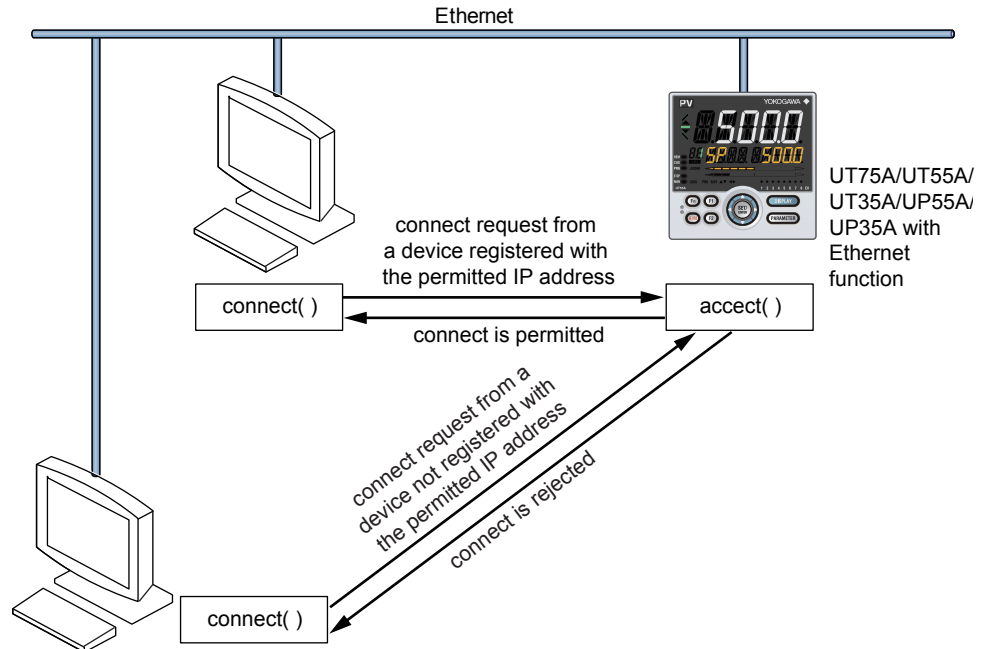

Use the following parameters to specify the IP access restriction function.

Parameter symbol	Group display	Name	Setting range	Menu symbol	Initial value
IPAR	E3	IP access restriction	Disable: OFF (0) Enable: ON (1)	ETHR	OFF (0)
1.IP1		Permitted IP address 1-1	0 to 255		255
1.IP2		Permitted IP address 1-2			
1.IP3		Permitted IP address 1-3			
1.IP4		Permitted IP address 1-4			
2.IP1		Permitted IP address 2-1			
2.IP2		Permitted IP address 2-2			
2.IP3		Permitted IP address 2-3			
2.IP4		Permitted IP address 2-4			

Note: Figures in parentheses “()” are values to be set when performing communication.

Note

- Just changing the value for the above parameters does not enable the setting content. Be sure to update the setting content by setting the Ethernet setting switch (ESW) to ON (1) after the setting is finished. The setting content is also enabled by performing the power ON/OFF operation of the UT75A/UT55A/UT35A/UP55A/UP35A.
- If the permitted IP address is 255.255.255.255, it is an invalid IP address. Access is not permitted.

* It takes about 20 seconds for the new settings of the Ethernet communication parameters to be enabled.

5.1 Overview

A system of coordinated operation is configured with a master controller and a number of slave controllers, all of which are UTAdvanced. The slave controllers are set to operate in the same way as the master controller. Therefore you do not have to create a communication program or to use specialized software for coordinated operation.

Overview of Coordinated Operation Connection

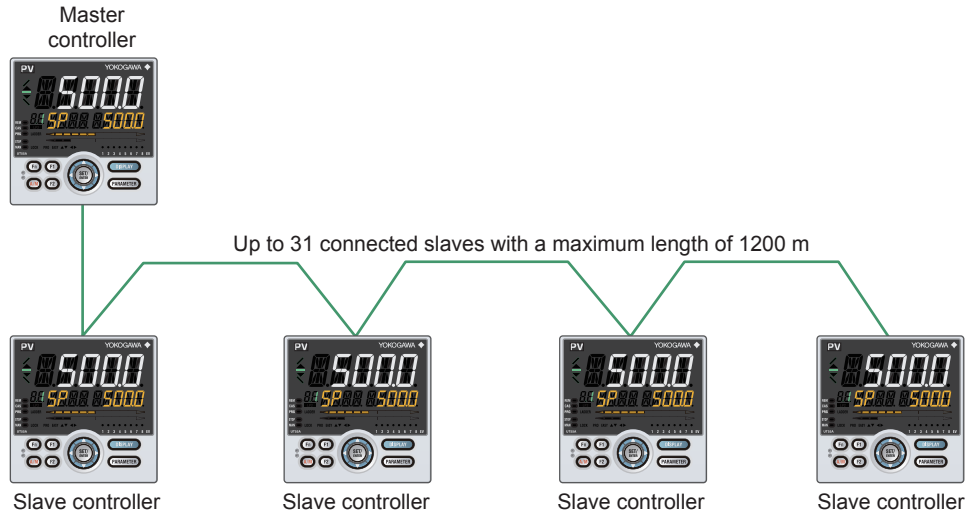

Note

Can also be connected to the GREEN Series controllers supporting the coordinated operation.

5.2 Coordinated Items

The controllers operate in coordination with respect to the following items.

● Target Setpoint

When the master is a program controller (UP controller), slave controllers (UT controllers) can be operated in the program operation.

- When the master controller is set to PSL=3 (coordinated master station) and the slave controller is set to PSL=4 (coordinated slave station):

The master controller sends the target setpoint.

The slave controller operates using the received target setpoint.

- When the master controller is set to PSL=9 (coordinated master station dual-loop mode) and the slave controller is set PSL=10, 11 (coordinated slave station):

The master controller sends the target setpoints of Loop 1 and Loop 2.

If the program pattern-2 retransmission* is ON, the master controller sends the target setpoints of Loop-1 and Loop-2.

The slave controller uses either Loop-1 or Loop-2 received target setpoint according to the PSL setting.

*: Program pattern-2 retransmission (PT2.G) is a parameter provided only for U55A.

Note

When the master controller is set to PSL=3 (coordinated master station) and the slave controller is set to PSL=10 or 11 (coordinated slave station), a coordinated operation error will occur.

When the master controller is set to PSL=9 (coordinated master station dual-loop mode) and the slave controller is set to PSL=4 (coordinated slave station), a coordinated operation error will also occur.

● Start-up condition of the Super function (overshoot suppressing function)

- The slave controller operates according to the data received from the master controller regardless of the setting of the parameter SC (Super function) for the slave controller.

Parameter symbol	Name	Setting range
SC	Super function	0: OFF (Disable)
		1: Overshoot suppressing function (normal mode)
		2: Hunting suppressing function (stable mode)
		3: Hunting suppressing function (response mode)
		4: Overshoot suppressing function (strong suppressing mode)

Note: The setpoints 2 and 3 are not available for Super function (overshoot suppressing function).

- When the master controller is the program controller (UP controller):
If the Super function (overshoot suppressing function) is disabled* by the program pattern of the master controller, the Super function of the slave controller is turned OFF according to the data received from the master controller.

*: When the target setpoint of currently-active segment is in ramp state (ramp-up or ramp-down) and the target setpoint of next segment is also in ramp state in program pattern.

● Operation mode (RUN/STOP) switching

Switching over the master controller's operation mode also switches the operation mode of the slave controllers accordingly.

When the master is a program controller (UP controller), the operation mode of the slave controller (UT controller) is: STOP when the master is in RESET, RUN when the master is not in RESET (PROG, LOC, REM).

● **PID number switching and switching over to the zone PID mode**

In coordinated operation, the slave controller's PID number depends on the setting of the parameter ZON of the master and slave controllers. The table below shows the slave controller's PID number selecting action.

Slave controller's PID number selecting action / Master controller's setting	Slave: ZON=0 SP group number selection 1	Slave: ZON=1 Zone PID selection (selection by PV)	Slave: ZON=2 Zone PID selection (selection by target SP)	Slave: ZON=3 SP group number selection 2	Slave: ZON=4 Zone PID selection (selection by SP)
Master: ZON=0 UT75A/UT55A/UT52A/UT35A/ UT32A: SP group number selection 1 UP55A/UP35A: Segment PID selection	Operates by the same PID number as the master controller.	Operates by the same PID number as the master controller.	Operates by the same PID number as the master controller.	Operates by the PID number selection of slave controller.	Operates by the same PID number as the master controller.
Master: ZON=1 Zone PID selection (selection by PV)	Operates by Zone PID (PV).	Operates by Zone PID (PV).	Operates by Zone PID (target setpoint).	Operates by the PID number selection of slave controller.	Operates by Zone PID (SP).
Master: ZON=2 Zone PID selection (selection by target SP)	Operates by Zone PID (PV).	Operates by Zone PID (PV).	Operates by Zone PID (target setpoint).	Operates by the PID number selection of slave controller.	Operates by Zone PID (SP).
Master: ZON=3 SP group number selection 2 *1	Operates by the same PID number as the master controller.	Operates by the same PID number as the master controller.	Operates by the same PID number as the master controller.	Operates by the PID number selection of slave controller.	Operates by the same PID number as the master controller.
Master: ZON=4 Zone PID selection (selection by SP)	Operates by Zone PID (PV).	Operates by Zone PID (PV).	Operates by Zone PID (target setpoint).	Operates by the PID number selection of slave controller.	Operates by Zone PID (SP).
Master: ZON=5 Local PID selection *2	Operates by the same PID number as the master controller.	Operates by the same PID number as the master controller.	Operates by the same PID number as the master controller.	Operates by the PID number selection of slave controller.	Operates by the same PID number as the master controller.

*1: Only for UT75A/UT55A/UT52A/UT35A/UT32A.

*2: Only for UP55A/UP35A.

If the PID number of the master controller exceeds the number of PID group of the slave controller, the PID number of the slave controller is "1."

Note

The UTAdvanced displays data in 5 digits. Data that is read/written via communication also consists of 5 digits. However, if you do not need to use 5-digit data for communication, set the data display digits of the controller to no more than 4 digits.

5.3 Starting Coordinated Operation

After the wiring and setup of communication parameters have been completed, turn off the power once and turn it on again.

- **Switchover of coordinated operation**

Set all the slave controllers to REM (remote) mode.

Slave controllers do not operate in coordination when they are in LCL (local) mode. (Each slave controller operates independently in LCL mode.)

- **Switchover of operation mode (RUN/STOP)**

Switching over the master controller's operation mode also switches the operation mode of the slave controllers accordingly.

Note

If the operation mode (RUN /STOP) of the slave UTAdvanced controller is under the control of an external contact input, the operation mode cannot be switched by coordinated operation because the control by the external contact input takes priority.

In coordinated operation, slave controller's "target setpoint ramp-rate setting" is disabled.

6.1 Overview

This chapter describes the functions and applications of the D registers. D registers are used in Modbus, PC link, ladder, Ethernet communications, or Open Network communication (network profile creating function of LL50A) and are used for storing UTAdvanced parameter data, flag data, process data, and other data and values. The host computer can utilize these data by reading from and writing to the D registers. When you newly perform communication with the UTAdvanced, the D registers after D2001 are used.

Use of the D registers enables the following:

- Centralized control by the host computer
- Reading and writing of data between the UTAdvanced and the host computer

Note

The D registers available vary depending on the model and suffix codes of the UTAdvanced or parameter settings. For details, refer to the respective UTAdvanced User's Manual.

D registers and I relays on the UTAdvanced are used for parameter settings or ladder program creations of LL50A Parameter Setting Software.

6.3 Classification of D Registers

■ Classification of D Register Map Tables

The table on next page outlines how the D registers are classified by their numbers in the D register map tables.

When you newly perform communication with the UTAdvanced, the D registers after D2001 are used.

CAUTION

- Check the model and suffix codes and parameter settings before writing to or read from the registers to be used.
- No data can be written to or read from blank parts of the data storage area by communication.
The UTAdvanced sometimes does not operate properly if an attempt is made to write to or read from blank parts of the data storage area.

■ Setting a Value with a Decimal Point

When setting a value with a decimal point from the host computer, set a value excluding the decimal point (hexadecimal)*.

Note

The UTAdvanced determine the decimal point position by the parameter setting.

Example: When setting a target setpoint “50.0” from the host computer

Set “1F4” which is a hexadecimal value of “500” (50.0 excluding the decimal point) (this is also true for setting 5.00 or 500).

Target setpoint “50.0”: P.DP = 1

Target setpoint “5.00”: P.DP = 2

Target setpoint “500”: P.DP = 0

*: For ladder operation, set the BCD value excluding the decimal point.

6.3 Classification of D Registers

Classification of D Registers

Register No.	Area and data categories	Description	Reference
D0001 to D0049	Configuration map for GREEN Series (See 6.6 GREEN Series Compatible D Registers)	Process data	Sections 6.6.3
D0050 to D0100		User area	Sections 6.6.3
D0101 to D0200		Program setting parameter (for UP55A only)	Sections 6.6.3
D0201 to D0230		Operation mode parameter	Sections 6.6.4
D0231 to D0300		Operation-related parameter	Sections 6.5.4
D0301 to D0700		PID parameter	Sections 6.6.5, 6.5.6
D0701 to D0800		10-segment linearizer parameters and USER parameter	Sections 6.6.7
D0801 to D0900		Message text	Sections 6.6.8
D0901 to D1000		Control action parameter	Sections 6.6.9
D1001 to D1100		Loop-common function parameter	Sections 6.6.10
D1101 to D1200		Display and I/O configuration parameter	Sections 6.6.11
D1201 to D1300		Controller mode, PV input, and control output parameter	Sections 6.6.12
D1301 to D2000		Free area	
D2001 to D2100		Process monitoring	Process data
D2101 to D2200	Current SP group and PID group		
D2201 to D2300	Program pattern parameter (for UP55A only)	Local-mode operation setting	
D2301 to D2400	Operation mode parameter, Operation parameter (for UP55A only)	Loop-1 / Loop-2 operation mode, Loop-1 / Loop-2 alarm setpoint setting (for UP55A only)	Sections 6.4.2
D2401 to D2500		Free area	
D2501 to D2700	Loop-1 operation parameter	SP and alarm setpoint setting (for UT55A/UT52A only)	Sections 6.4.3
D2701 to D2800		SP-related setting	
D2801 to D2900		Alarm function setting	
D2901 to D3000		PV-related setting	
D3001 to D3500		PID setting	
D3501 to D3600		Control action-related setting	
D3601 to D3800	Loop-2 operation parameter	SP and alarm setpoint setting (for UT55A/UT52A only)	Sections 6.4.4
D3801 to D3900		SP-related setting (for UT55A/UT52A only)	
D3901 to D4000		Alarm function setting	
D4001 to D4100		PV-related setting	
D4101 to D4600		PID setting	
D4601 to D4700		Control action-related setting	
D4701 to D4800	P parameter	P parameter	Sections 6.4.5
D4801 to D5000	10-segment linearizer setting parameter	10-segment linearizer setting	Sections 6.4.6
D5001 to D5100	Setup parameter	Control function setting	Sections 6.4.7
D5101 to D5300		Input setting	
D5301 to D5400		Output setting	
D5401 to D5500		Heater break alarm setting	
D5501 to D5700		Communication setting	
D5701 to D5800		Key action setting / Display function setting / SELECT display setting	
D5801 to D5900		Lock setting (Key lock / menu lock)	
D5901 to D6200		DI function setting	
D6201 to D6300		DO function setting	
D6301 to D6400		I/O display	
D6401 to D6500		System setting	
D6501 to D7000		Free area	
D7001 to D7100		Registers for ladder program	
D7101 to D7200	For output ladder calculation		
D7201 to D7300	Status register		
D7301 to D7500	Constant register		
D7501 to D7600	Input range / scale		
D7601 to D7700	Terminal status register	Input / Output terminal status register	Sections 6.4.9
D8001 to D8100	Program pattern parameter (for UP55A only)	Pattern data setting	Sections 6.4.10
D8101 to D8200		Segment data setting	
D8201 to D8600		Final target setpoint setting for batch writing	
D8601 to D9000		Segment time setting / Segment ramp-rate setting for batch writing	

Note 1: Data in the process values, operation parameters, and setup parameters is stored in the format (data excluding the decimal point of PV input range, PV input range span, %, or ABS) described in "Lists of Operation Parameters" and "Lists of Setup Parameters" in the UTAdvanced Operation Guide or User's Manual. The OFF status of data is indicated by "0" and the ON status is indicated by "1."
D registers D2001 to D2100 are read-only.

6.4 UT55A/UT52A/UP55A D Registers

6.4.1 Process Monitoring and Program Pattern for UP55A (D2001 to D2300)

Process monitoring area													
Process data													
D-Reg No.	Ref. No.	H No.	Register symbol	R/W			D-Reg No.	Ref. No.	H No.	Register symbol	R/W		
				UT 55A	UT 52A	UP 55A					UT 55A	UT 52A	UP 55A
D2001	42001	07D0	AD1.E	R	R	R	D2051	42051	0802				
D2002	42002	07D1	PV1.E_L1	R	R	R	D2052	42052	0803				
D2003	42003	07D2	PV_L1	R	R	R	D2053	42053	0804				
D2004	42004	07D3	CSP_L1	R	R	R	D2054	42054	0805				
D2005	42005	07D4	OUT_L1	R	R	R	D2055	42055	0806				
D2006	42006	07D5	H.OUT_L1	R	R	R	D2056	42056	0807				
D2007	42007	07D6	C.OUT_L1	R	R	R	D2057	42057	0808				
D2008	42008	07D7	MOD_L1	R	R	R	D2058	42058	0809				
D2009	42009	07D8	PID_L1	R	R	R	D2059	42059	080A				
D2010	42010	07D9	CSPNO.	R	R		D2060	42060	080B				
D2011	42011	07DA	ALM_L1	R	R	R	D2061	42061	080C	HC1	R	R	R
D2012	42012	07DB	LA.ER	R	R	R	D2062	42062	080D	HC2	R	R	R
D2013	42013	07DC	ALM_L2	R	R	R	D2063	42063	080E	CT_AL	R	R	R
D2014	42014	07DD					D2064	42064	080F	VALV	R	R	R
D2015	42015	07DE	C.PTNO.			R	D2065	42065	0810	AD2.E	R	R	R
D2016	42016	07DF	SEG.N			R	D2066	42066	0811	DIMG	R	R	R
D2017	42017	07E0	SEG_RUNTIME			R	D2067	42067	0812				
D2018	42018	07E1	PV2.E_L2	R	R	R	D2068	42068	0813	PA.ER	R	R	R
D2019	42019	07E2	PV_L2	R	R	R	D2069	42069	0814				
D2020	42020	07E3	CSP_L2	R	R	R	D2070	42070	0815	OP.ER	R	R	R
D2021	42021	07E4	OUT_L2	R	R	R	D2071	42071	0816	ALOLA1_L1	R	R	R
D2022	42022	07E5	H.OUT_L2	R	R	R	D2072	42072	0817	ALOLA1_L2	R	R	R
D2023	42023	07E6	C.OUT_L2	R	R	R	D2073	42073	0818	ALOLA2_L1	R	R	R
D2024	42024	07E7	MOD_L2	R	R	R	D2074	42074	0819	ALOLA2_L2	R	R	R
D2025	42025	07E8	PID_L2	R	R	R	D2075	42075	081A	ALOLA3_L1	R	R	R
D2026	42026	07E9					D2076	42076	081B	ALOLA3_L2	R	R	R
D2027	42027	07EA					D2077	42077	081C	ALOLA4_L1	R	R	R
D2028	42028	07EB					D2078	42078	081D	ALOLA4_L2	R	R	R
D2029	42029	07EC					D2079	42079	081E				
D2030	42030	07ED					D2080	42080	081F				
D2031	42031	07EE					D2081	42081	0820				
D2032	42032	07EF					D2082	42082	0821				
D2033	42033	07F0	CTSP_L1			R	D2083	42083	0822				
D2034	42034	07F1	CTSP_L2			R	D2084	42084	0823				
D2035	42035	07F2	DEV_L1	R	R	R	D2085	42085	0824				
D2036	42036	07F3	DEV_L2	R	R	R	D2086	42086	0825				
D2037	42037	07F4	ALO_L1	R	R	R	D2087	42087	0826				
D2038	42038	07F5	ALO_L2	R	R	R	D2088	42088	0827				
D2039	42039	07F6	PV_EV			R	D2089	42089	0828				
D2040	42040	07F7	TIME_EV_1			R	D2090	42090	0829				
D2041	42041	07F8	TIME_EV_2			R	D2091	42091	082A				
D2042	42042	07F9					D2092	42092	082B				
D2043	42043	07FA					D2093	42093	082C				
D2044	42044	07FB	SEG_USE			R	D2094	42094	082D				
D2045	42045	07FC	NOW_RCY			R	D2095	42095	082E				
D2046	42046	07FD	REM_RCY			R	D2096	42096	082F				
D2047	42047	07FE	ALL_RCY			R	D2097	42097	0830				
D2048	42048	07FF	NOW_RST			R	D2098	42098	0831				
D2049	42049	0800	NOW_REN			R	D2099	42099	0832				
D2050	42050	0801	PV_EV_OUT			R	D2100	42100	0833				

6.4 UT55A/UT52A/UP55A D Registers

Process monitoring area													
Current SP group and PID group													
D-Reg No.	Ref. No.	H No.	Register symbol	R/W			D-Reg No.	Ref. No.	H No.	Register symbol	R/W		
				UT 55A	UT 52A	UP 55A					UT 55A	UT 52A	UP 55A
D2101	42101	0834	SP_L1_*	R/W	R/W		D2151	42151	0866	SP_L2_*	R/W	R/W	
D2102	42102	0835	SUB_*	R/W	R/W		D2152	42152	0867				
D2103	42103	0836	PIDN_L1_*	R/W	R/W		D2153	42153	0868	PIDN_L2_*	R/W	R/W	
D2104	42104	0837	A1_L1_*	R/W	R/W		D2154	42154	0869	A1_L2_*	R/W	R/W	
D2105	42105	0838	A2_L1_*	R/W	R/W		D2155	42155	086A	A2_L2_*	R/W	R/W	
D2106	42106	0839	A3_L1_*	R/W	R/W		D2156	42156	086B	A3_L2_*	R/W	R/W	
D2107	42107	083A	A4_L1_*	R/W	R/W		D2157	42157	086C	A4_L2_*	R/W	R/W	
D2108	42108	083B	A5_L1_*	R/W	R/W		D2158	42158	086D	A5_L2_*	R/W	R/W	
D2109	42109	083C	A6_L1_*	R/W	R/W		D2159	42159	086E	A6_L2_*	R/W	R/W	
D2110	42110	083D	A7_L1_*	R/W	R/W		D2160	42160	086F	A7_L2_*	R/W	R/W	
D2111	42111	083E	A8_L1_*	R/W	R/W		D2161	42161	0870	A8_L2_*	R/W	R/W	
D2112	42112	083F					D2162	42162	0871				
D2113	42113	0840					D2163	42163	0872				
D2114	42114	0841	P_L1_*	R/W	R/W	R/W	D2164	42164	0873	P_L2_*	R/W	R/W	R/W
D2115	42115	0842	I_L1_*	R/W	R/W	R/W	D2165	42165	0874	I_L2_*	R/W	R/W	R/W
D2116	42116	0843	D_L1_*	R/W	R/W	R/W	D2166	42166	0875	D_L2_*	R/W	R/W	R/W
D2117	42117	0844	OH_L1_*	R/W	R/W	R/W	D2167	42167	0876	OH_L2_*	R/W	R/W	R/W
D2118	42118	0845	OL_L1_*	R/W	R/W	R/W	D2168	42168	0877	OL_L2_*	R/W	R/W	R/W
D2119	42119	0846	MR_L1_*	R/W	R/W	R/W	D2169	42169	0878	MR_L2_*	R/W	R/W	R/W
D2120	42120	0847	HYS_L1_*	R/W	R/W	R/W	D2170	42170	0879	HYS_L2_*	R/W	R/W	R/W
D2121	42121	0848	SU.HY_L1_*	R/W	R/W		D2171	42171	087A				
D2122	42122	0849	HY.UP_L1_*	R/W	R/W	R/W	D2172	42172	087B				
D2123	42123	084A	HY.LO_L1_*	R/W	R/W	R/W	D2173	42173	087C				
D2124	42124	084B	DR_L1_*	R/W	R/W	R/W	D2174	42174	087D	DR_L2_*	R/W	R/W	R/W
D2125	42125	084C	SU.DR_*	R/W	R/W		D2175	42175	087E				
D2126	42126	084D	Pc_L1_*	R/W	R/W	R/W	D2176	42176	087F	Pc_L2_*	R/W	R/W	R/W
D2127	42127	084E	Ic_L1_*	R/W	R/W	R/W	D2177	42177	0880	Ic_L2_*	R/W	R/W	R/W
D2128	42128	084F	Dc_L1_*	R/W	R/W	R/W	D2178	42178	0881	Dc_L2_*	R/W	R/W	R/W
D2129	42129	0850	OHc_L1_*	R/W	R/W	R/W	D2179	42179	0882	OHc_L2_*	R/W	R/W	R/W
D2130	42130	0851	OLc_L1_*	R/W	R/W	R/W	D2180	42180	0883	OLc_L2_*	R/W	R/W	R/W
D2131	42131	0852	HYSc_L1_*	R/W	R/W	R/W	D2181	42181	0884	HYSc_L2_*	R/W	R/W	R/W
D2132	42132	0853	DB_L1_*	R/W	R/W	R/W	D2182	42182	0885	DB_L2_*	R/W	R/W	R/W
D2133	42133	0854	PO_L1_*	R/W	R/W	R/W	D2183	42183	0886	PO_L2_*	R/W	R/W	R/W
D2134	42134	0855	SU.PO_*	R/W	R/W		D2184	42184	0887				
D2135	42135	0856	POc_L1_*	R/W	R/W	R/W	D2185	42185	0888	POc_L2_*	R/W	R/W	R/W
D2136	42136	0857					D2186	42186	0889				
D2137	42137	0858					D2187	42187	088A				
D2138	42138	0859					D2188	42188	088B				
D2139	42139	085A					D2189	42189	088C				
D2140	42140	085B					D2190	42190	088D				
D2141	42141	085C					D2191	42191	088E				
D2142	42142	085D					D2192	42192	088F				
D2143	42143	085E					D2193	42193	0890				
D2144	42144	085F					D2194	42194	0891				
D2145	42145	0860					D2195	42195	0892				
D2146	42146	0861					D2196	42196	0893				
D2147	42147	0862					D2197	42197	0894				
D2148	42148	0863					D2198	42198	0895				
D2149	42149	0864					D2199	42199	0896				
D2150	42150	0865					D2200	42200	0897				

See the next page regarding “*.”

- *: The group number to be displayed varies depending on the currently used SP number selection (D2312) and PID number (D2009, D2025).
Either 1 to 8 or R (the currently used group number) is written.
However, only 1 to 8 is written in D2101 to D2111 and D2151 to D2161.

6.4 UT55A/UT52A/UP55A D Registers

Program pattern													
Local-mode Operation Setting (Menu: LOC)													
D-Reg No.	Ref. No.	H No.	Register symbol	R/W			D-Reg No.	Ref. No.	H No.	Register symbol	R/W		
				UT 55A	UT 52A	UP 55A					UT 55A	UT 52A	UP 55A
D2201	42201	0898	LSP_L1			R/W	D2251	42251	08CA				
D2202	42202	0899	LSP_L2			R/W	D2252	42252	08CB				
D2203	42203	089A	L.PID			R/W	D2253	42253	08CC				
D2204	42204	089B	L.TY1			R/W	D2254	42254	08CD				
D2205	42205	089C	L.EV1			R/W	D2255	42255	08CE				
D2206	42206	089D	L.TY2			R/W	D2256	42256	08CF				
D2207	42207	089E	L.EV2			R/W	D2257	42257	08D0				
D2208	42208	089F	L.TY3			R/W	D2258	42258	08D1				
D2209	42209	08A0	L.EV3			R/W	D2259	42259	08D2				
D2210	42210	08A1	L.TY4			R/W	D2260	42260	08D3				
D2211	42211	08A2	L.EV4			R/W	D2261	42261	08D4				
D2212	42212	08A3	L.TY5			R/W	D2262	42262	08D5				
D2213	42213	08A4	L.EV5			R/W	D2263	42263	08D6				
D2214	42214	08A5	L.TY6			R/W	D2264	42264	08D7				
D2215	42215	08A6	L.EV6			R/W	D2265	42265	08D8				
D2216	42216	08A7	L.TY7			R/W	D2266	42266	08D9				
D2217	42217	08A8	L.EV7			R/W	D2267	42267	08DA				
D2218	42218	08A9	L.TY8			R/W	D2268	42268	08DB				
D2219	42219	08AA	L.EV8			R/W	D2269	42269	08DC				
D2220	42220	08AB					D2270	42270	08DD				
D2221	42221	08AC					D2271	42271	08DE				
D2222	42222	08AD					D2272	42272	08DF				
D2223	42223	08AE					D2273	42273	08E0				
D2224	42224	08AF					D2274	42274	08E1				
D2225	42225	08B0					D2275	42275	08E2				
D2226	42226	08B1					D2276	42276	08E3				
D2227	42227	08B2					D2277	42277	08E4				
D2228	42228	08B3					D2278	42278	08E5				
D2229	42229	08B4					D2279	42279	08E6				
D2230	42230	08B5					D2280	42280	08E7				
D2231	42231	08B6					D2281	42281	08E8				
D2232	42232	08B7					D2282	42282	08E9				
D2233	42233	08B8					D2283	42283	08EA				
D2234	42234	08B9					D2284	42284	08EB				
D2235	42235	08BA					D2285	42285	08EC				
D2236	42236	08BB					D2286	42286	08ED				
D2237	42237	08BC					D2287	42287	08EE				
D2238	42238	08BD					D2288	42288	08EF				
D2239	42239	08BE					D2289	42289	08F0				
D2240	42240	08BF					D2290	42290	08F1				
D2241	42241	08C0					D2291	42291	08F2				
D2242	42242	08C1					D2292	42292	08F3				
D2243	42243	08C2					D2293	42293	08F4				
D2244	42244	08C3					D2294	42294	08F5				
D2245	42245	08C4					D2295	42295	08F6				
D2246	42246	08C5					D2296	42296	08F7				
D2247	42247	08C6					D2297	42297	08F8				
D2248	42248	08C7					D2298	42298	08F9				
D2249	42249	08C8					D2299	42299	08FA				
D2250	42250	08C9					D2300	42300	08FB				

Process Data Area

Some of the D registers represent multiple events such as errors and status depending on combinations of bits in the register.

In the following tables, if an event indicated by a specific bit occurs, the state of that bit changes to “1.”

If no event occurs, the state of that bit is “0.” Blank lines in each table indicate unused bits.

Process Data (D2001 to D2100)

● Bit Configuration of D2001: AD1.E (A/D converter error status 1)

Bit	Symbol	Event
0	ADERR	PV input A/D converter error
1	ADERR_E1	RSP input (E1-terminal area) A/D converter error
2	ADERR_E2	AIN2 input (E2-terminal area) A/D converter error
3		
4	ADERR_E4	AIN4 input (E4-terminal area) A/D converter error
5	RJCERR	PV input RJC error
6	RJCERR_E1	RSP input RJC error
7		
8	ADBO	PV input burnout error
9	ADBO_E1	RSP input (E1-terminal area) burnout error
10	ADBO_E2	AIN2 input (E2-terminal area) burnout error
11		
12	ADBO_E4	AIN4 input (E4-terminal area) burnout error
13 to 15		

● Bit Configuration of D2002: PV1.E_L1 (Loop-1 PV input error status)

Bit	Symbol	Event
0	PVBO_L1	Loop-1 PV input burnout error
1	RSPBO_L1	Loop-1 RSP input burnout error
2	CRSPBO_L1	Burnout error when the Loop-1 RSP input is used for control.
3		
4	PVPOVER_L1	Loop-1 PV input over-scale
5	PVMOVER_L1	Loop-1 PV input under-scale
6 to 13		
14	ATERR_L1	Loop-1 auto-tuning timeout error
15		

● D2003 to D2007

Register No.	Description		Range and meaning of value
D2003	PV_L1	Loop-1 measurement value	-5.0 to 105.0% of PV input range (EU)
D2004	CSP_L1	Loop-1 control setpoint	0.0 to 100.0% of PV input range (EU) (Setting range: SPL to SPH)
D2005	OUT_L1	Loop-1 control output	-5.0 to 105.0%
D2006	H.OUT_L1	Heating-side control output	-5.0 to 105.0% (In Heating/cooling control: 0.0 to 105.0%)
D2007	C.OUT_L1	Cooling-side control output	0.0 to 105.0%

6.4 UT55A/UT52A/UP55A D Registers

● Bit Configuration of D2008: MOD_L1 (Loop-1 operation mode status)

UT55A/UT52A

Bit	Symbol	Event
0	A.M	0: AUTO, 1: MAN *1
1	R.L_L1	0: Local, 1: Remote
2	S.R	0: Run, 1: Stop
3		
4	CAS_ON	1: CAS *2
5	AUTO_ON	1: AUTO *2
6	MAN_ON	1: MAN *2
7		
8	TRK_ON_L1	1: Output tracking
9		
10 to 13		
14	AT_L1_ON	0: Auto-tuning is OFF, 1: Auto-tuning is ON
15		

*1: Effective for the control modes except for cascade control and cascade secondary-loop control.

*2: Effective for cascade control mode and cascade secondary-loop control mode.

UP55A

Bit	Symbol	Event
0	A.M	0: AUTO, 1: MAN *1
1 to 3		
4	RST_ON	1: Program reset
5	PRG_ON	1: Program operation
6	LOC_ON	1: Local operation
7		
8	REM_ON	1: Remote-mode operation
9	TRK_ONOFF	1: Output tracking
10	ADV_ON	1: Advance of segment
11		
12	HOLD_ON	1: Pause
13	WAITF	1: Wait
14	AT_L1_ON	0: Auto-tuning is OFF, 1: Auto-tuning is ON
15		

● Bit Configuration of D2009: PID_L1 (Current PID number for Loop-1)

Bit	Symbol	Event
0	PIDN.B0_L1	Loop-1 bit-0 of the PID number
1	PIDN.B1_L1	Loop-1 bit-1 of the PID number
2	PIDN.B2_L1	Loop-1 bit-2 of the PID number
3	PIDN.B3_L1	Loop-1 bit-3 of the PID number
4 to 15		

● Bit Configuration of D2010: CSPNO. (Current control setpoint number)

Bit	Symbol	Event
0	CCSPN.B0	Bit-0 of control setpoint number
1	CCSPN.B1	Bit-1 of control setpoint number
2	CCSPN.B2	Bit-2 of control setpoint number
3	CCSPN.B3	Bit-3 of control setpoint number
4 to 15		

● Bit Configuration of D2011: ALM_L1 (Loop-1 alarm-1 to alarm-8 status)

Bit	Symbol	Event
0	ALM1_L1	'1' when Loop-1 alarm 1 is ON; '0' when OFF
1	ALM2_L1	'1' when Loop-1 alarm 2 is ON; '0' when OFF
2	ALM3_L1	'1' when Loop-1 alarm 3 is ON; '0' when OFF
3		
4	ALM4_L1	'1' when Loop-1 alarm 4 is ON; '0' when OFF
5	ALM5_L1	'1' when Loop-1 alarm 5 is ON; '0' when OFF
6	ALM6_L1	'1' when Loop-1 alarm 6 is ON; '0' when OFF
7		
8	ALM7_L1	'1' when Loop-1 alarm 7 is ON; '0' when OFF
9	ALM8_L1	'1' when Loop-1 alarm 8 is ON; '0' when OFF
10 to 15		

● Bit Configuration of D2012: LA.ER (Ladder error status)

Bit	Symbol	Event
0	LAD_ERR	Corrupted ladder program
1	LAD_OVER	Ladder calculation overflow
2	LAD_P_ERR	Ladder program error
3		
4	LD100_OVER	Load factor over 100%
5	LD200_OVER	Load factor over 200% (Forced end)
6 to 15		

● Bit Configuration of D2013: ALM_L2 (Loop-2 alarm-1 to alarm-8 status)

Bit	Symbol	Event
0	ALM1_L2	'1' when Loop-2 alarm 1 is ON; '0' when OFF
1	ALM2_L2	'1' when Loop-2 alarm 2 is ON; '0' when OFF
2	ALM3_L2	'1' when Loop-2 alarm 3 is ON; '0' when OFF
3		
4	ALM4_L2	'1' when Loop-2 alarm 4 is ON; '0' when OFF
5	ALM5_L2	'1' when Loop-2 alarm 5 is ON; '0' when OFF
6	ALM6_L2	'1' when Loop-2 alarm 6 is ON; '0' when OFF
7		
8	ALM7_L2	'1' when Loop-2 alarm 7 is ON; '0' when OFF
9	ALM8_L2	'1' when Loop-2 alarm 7 is ON; '0' when OFF
10 to 15		

● D2015 to D2017

Register No.	Description		Range and meaning of value
D2015	C.PTNO.	Current program pattern number	0 to 30
D2016	SEG.N	Current segment number currently in operation	0: Not executing. 1 to 99
D2017	SEG_RTIME	Remaining segment-time during operation/Elapsed time during wait.	0 to 59999 (minute or second) * Use the parameter TMU to set the time unit.

6.4 UT55A/UT52A/UP55A D Registers

● Bit Configuration of D2018: PV2.E_L2 (Loop-2 PV input error status)

Bit	Symbol	Event
0	PVBO_L2	Loop-2 PV input burnout error
1	RSPBO_L2 *	Loop-2 RSP input burnout error
2	CRSPBO_L2 *	Burnout error when the Loop-2 RSP input is used for control.
3		
4	PVPOVER_L2	Loop-2 PV input over-scale
5	PVMOVER_L2	Loop-2 PV input under-scale
6 to 13		
14	ATERR_L2	Loop-2 auto-tuning timeout error
15		

*: For UT55A/UT52A.

● D2019 to D2023

Register No.	Description		Range and meaning of value
D2019	PV_L2	Loop-2 measurement value	-5.0 to 105.0% of PV input range (EU)
D2020	CSP_L2	Loop-2 control setpoint	0.0 to 100.0% of PV input range (EU) (Setting range: SPL to SPH)
D2021	OUT_L2	Loop-2 control output	-5.0 to 105.0%
D2022	H.OUT_L2	Heating-side control output	-5.0 to 105.0% (In Heating/cooling control: 0.0 to 105.0%)
D2023	C.OUT_L2	Cooling-side control output	0.0 to 105.0%

● Bit Configuration of D2024: MOD_L2 (Loop-2 operation mode status)

UT55A/UT52A

Bit	Symbol	Event
0		
1	R.L_L2	0: Local, 1: Remote
2 to 13		
14	AT_L2_ON	0: Auto-tuning is OFF, 1: Auto-tuning is ON
15		

UP55A

Bit	Symbol	Event
0	A.M_L2	0: AUTO, 1: MAN
1 to 7		
8	LC_L2	0: Cascad (CAS), 1: Local (LSP)
9 to 13		
14	AT_L2_ON	0: Auto-tuning is OFF; 1: Auto-tuning is ON
15		

● Bit Configuration of D2025: PID_L2 (Current PID number for Loop 2)

Bit	Symbol	Event
0	PIDN.B0_L2	Loop-2 bit-0 of the PID number
1	PIDN.B1_L2	Loop-2 bit-1 of the PID number
2	PIDN.B2_L2	Loop-2 bit-2 of the PID number
3	PIDN.B3_L2	Loop-2 bit-3 of the PID number
4 to 15		

● D2033 to D2036

Register No.	Description		Range and meaning of value
D2033	CTSP_L1	Loop-1 final target setpoint	0.0 to 100.0% of PV input range (EU) (Setting range: P.RL to P.RH)
D2034	CTSP_L2	Loop-2 final target setpoint	
D2035	DEV_L1	Loop-1 deviation	-105.0 to 105.0% of PV input range span (EUS)
D2036	DEV_L2	Loop-2 deviation	-105.0 to 105.0% of PV input range span (EUS)

● **Bit Configuration of D2037: ALO_L1 (Loop-1 alarm-1 to alarm-8 output status)**

Bit	Symbol	Event
0	ALO1_L1	Output status where Loop-1 alarm output 1 is assigned. 0: When the alarm is turned off (alarm type: energized), or the alarm is turned on (alarm type: de-energized). (The relay contact is open.) 1: When the alarm is turned on (alarm type: energized), or the alarm is turned off (alarm type: de-energized). (The relay contact is closed.)
1	ALO2_L1	Output status where Loop-1 alarm output 2 is assigned. For bit information, same as bit 0.
2	ALO3_L1	Output status where Loop-1 alarm output 3 is assigned. For bit information, same as bit 0.
3		
4	ALO4_L1	Output status where Loop-1 alarm output 4 is assigned. For bit information, same as bit 0.
5	ALO5_L1	Output status where Loop-1 alarm output 5 is assigned. For bit information, same as bit 0.
6	ALO6_L1	Output status where Loop-1 alarm output 6 is assigned. For bit information, same as bit 0.
7		
8	ALO7_L1	Output status where Loop-1 alarm output 7 is assigned. For bit information, same as bit 0.
9	ALO8_L1	Output status where Loop-1 alarm output 8 is assigned. For bit information, same as bit 0.
10 to 15		

● **Bit Configuration of D2038: ALO_L2 (Loop-2 alarm-1 to alarm-8 output status)**

Bit	Symbol	Event
0	ALO1_L2	Output status where Loop-2 alarm output 1 is assigned. 0: When the alarm is turned off (alarm type: energized), or the alarm is turned on (alarm type: de-energized). (The relay contact is open.) 1: When the alarm is turned on (alarm type: energized), or the alarm is turned off (alarm type: de-energized). (The relay contact is closed.)
1	ALO2_L2	Output status where Loop-2 alarm output 2 is assigned. For bit information, same as bit 0.
2	ALO3_L2	Output status where Loop-2 alarm output 3 is assigned. For bit information, same as bit 0.
3		
4	ALO4_L2	Output status where Loop-2 alarm output 4 is assigned. For bit information, same as bit 0.
5	ALO5_L2	Output status where Loop-2 alarm output 5 is assigned. For bit information, same as bit 0.
6	ALO6_L2	Output status where Loop-2 alarm output 6 is assigned. For bit information, same as bit 0.
7		
8	ALO7_L2	Output status where Loop-2 alarm output 7 is assigned. For bit information, same as bit 0.
9	ALO8_L2	Output status where Loop-2 alarm output 8 is assigned. For bit information, same as bit 0.
10 to 15		

6.4 UT55A/UT52A/UP55A D Registers

● Bit Configuration of D2039: PV_EV (PV event status)

Bit	Symbol	Event
0	PV_EV1	0: PV event is OFF 1: PV event is ON
1	PV_EV2	
2	PV_EV3	
3		
4	PV_EV4	0: PV event is OFF 1: PV event is ON
5	PV_EV5	
6	PV_EV6	
7		
8	PV_EV7	0: PV event is OFF 1: PV event is ON
9	PV_EV8	
10 to 15		

● Bit Configuration of D2040: TIME_EV_1 (Time event status 1)

Bit	Symbol	Event
0	TIME_EV1	0: Time event is OFF 1: Time event is ON
1	TIME_EV2	
2	TIME_EV3	
3		
4	TIME_EV4	0: Time event is OFF 1: Time event is ON
5	TIME_EV5	
6	TIME_EV6	
7		
8	TIME_EV7	0: Time event is OFF 1: Time event is ON
9	TIME_EV8	
10 to 15		

● Bit Configuration of D2041: TIME_EV_2 (Time event status 2)

Bit	Symbol	Event
0	TIME_EV9	0: Time event is OFF 1: Time event is ON
1	TIME_EV10	
2	TIME_EV11	
3		
4	TIME_EV12	0: Time event is OFF 1: Time event is ON
5	TIME_EV13	
6	TIME_EV14	
7		
8	TIME_EV15	0: Time event is OFF 1: Time event is ON
9	TIME_EV16	
10 to 15		

● D2044 to D2049

Register No.	Description		Range and meaning of value
D2044	SEG_USE	Number of segments contained in the selected pattern	0 to 99
D2045	NOW_RCY	Number of repetitions of the pattern in operation	0 to 999
D2046	REM_RCY	Number of repetitions of the pattern in operation	0 to 999
D2047	ALL_RCY	Remaining number of repetitions of the pattern in operation	0 to 1000
D2048	NOW_RST	Repeat Start number of the current segment	1 to 99
D2049	NOW_REN	Repeat End number of the current segment	1 to 99

● Bit Configuration of D2050: PV_EV_OUT (PV event output status)

0	PV_EV1_OUT	0: PV event output is OFF 1: PV event output is ON
1	PV_EV2_OUT	
2	PV_EV3_OUT	
3		
4	PV_EV4_OUT	0: PV event output is OFF 1: PV event output is ON
5 to 7		
8	PV_EV5_OUT	0: PV event output is OFF 1: PV event output is ON
9	PV_EV6_OUT	
10	PV_EV7_OUT	
11		
12	PV_EV8_OUT	0: PV event output is OFF 1: PV event output is ON
13 to 15		

● D2061, D2062

Register No.	Description		Range and meaning of value
D2061	HC1	Heter break alarm-1 current value display	0.0 to 360.0 Arms
D2062	HC2	Heter break alarm-2 current value display	0.0 to 360.0 Arms

● Bit Configuration of D2063: CT_AL (Heater break alarm status)

Bit	Symbol	Event
0	CT_AL1	'1' when heter break alarm-1 is ON; '0' when OFF
1	CT_AL2	'1' when heter break alarm-2 is ON; '0' when OFF
2 to 15		

● Bit Configuration of D2064: VALV (Valve status)

Bit	Symbol	Event
0	VALV_GUSS	0: Operation by feedback input 1: Operation by estimating type
1	VALV_OPEN	0: Output off, 1: Output on
2	VALV_CLOSE	0: Output off, 1: Output on
3	VALV_AT	0: Stop automatic valve position adjustment 1: Automatic valve position adjustment
4 to 15		

● Bit Configuration of D2065: AD2.E (A/D converter error status 2)

Bit	Symbol	Event
0	VALVBO	Feedback input resistor/current burnout
1	VALV_ATERR	Valve position automatic adjustment error
2 to 15		

● Bit Configuration of D2066: DIMG (Message display interruption status)

Bit	Symbol	Event
0	MG1.B	Message display interruption 1 (1: displayed, 0: not displayed)
1	MG2.B	Message display interruption 2 (1: displayed, 0: not displayed)
2	MG3.B	Message display interruption 3 (1: displayed, 0: not displayed)
3		
4	MG4.B	Message display interruption 4 (1: displayed, 0: not displayed)
5 to 15		

6.4 UT55A/UT52A/UP55A D Registers

● Bit Configuration of D2068: PA.ER (Parameter error status)

Bit	Symbol	Event
0	SYSTEM_ERR	System data error
1	CALB_ERR	Calibration value error
2	UPARA_ERR	User (parameter) default value error
3		
4	SETPA_ERR	Setup parameter error
5	OPEPA_ERR	Operation parameter error
6	PROG_ERR *	Program pattern error
7		
8	FRAM_ERR	Faulty FRAM
9		
10	CTLPA_ERR	Control parameter error
11 to 15		

*: For UP55A only

● Bit Configuration of D2070: OP.ER (Option error status)

Bit	Symbol	Event
0	E1_ERR	Nonresponding hardware of E1 terminal area
1	E2_ERR	Nonresponding hardware of E2 terminal area
2	E3_ERR	Nonresponding hardware of E3 terminal area
3		
4	E4_ERR	Nonresponding hardware of E4 terminal area
5 to 7		
8	COM_E1_ERR *1	Communication error E1 terminal area
9		
10	COM_E3_ERR *2	Communication error E3 terminal area
11		
12	COM_E4_ERR *2	Communication error E4 terminal area
13 to 15		

*1: For UT52A only

*2: For UT55A/UP55A only

● Bit Configuration of D2071: ALOLA1_L1 (Loop-1 alarm-1 to alarm-8 latch output status)

Bit	Symbol	Event
0	ALO1LA1_L1	Alarm-1 latch-1 output status
1	ALO2LA1_L1	Alarm-2 latch-1 output status
2	ALO3LA1_L1	Alarm-3 latch-1 output status
3		
4	ALO4LA1_L1	Alarm-4 latch-1 output status
5	ALO5LA1_L1	Alarm-5 latch-1 output status
6	ALO6LA1_L1	Alarm-6 latch-1 output status
7		
8	ALO7LA1_L1	Alarm-7 latch-1 output status
9	ALO8LA1_L1	Alarm-8 latch-1 output status
10 to 15		

● **Bit Configuration of D2072: ALOLA1_L2 (Loop-2 alarm-1 to alarm-8 latch output status)**

Bit	Symbol	Event
0	ALO1LA1_L2	Alarm-1 latch-1 output status
1	ALO2LA1_L2	Alarm-2 latch-1 output status
2	ALO3LA1_L2	Alarm-3 latch-1 output status
3		
4	ALO4LA1_L2	Alarm-4 latch-1 output status
5	ALO5LA1_L2	Alarm-5 latch-1 output status
6	ALO6LA1_L2	Alarm-6 latch-1 output status
7		
8	ALO7LA1_L2	Alarm-7 latch-1 output status
9	ALO8LA1_L2	Alarm-8 latch-1 output status
10 to 15		

● **Bit Configuration of D2073: ALOLA2_L1 (Loop-1 alarm-1 to alarm-8 latch-2 output status)**

Bit	Symbol	Event
0	ALO1LA2_L1	Alarm-1 latch-2 output status
1	ALO2LA2_L1	Alarm-2 latch-2 output status
2	ALO3LA2_L1	Alarm-3 latch-2 output status
3		
4	ALO4LA2_L1	Alarm-4 latch-2 output status
5	ALO5LA2_L1	Alarm-5 latch-2 output status
6	ALO6LA2_L1	Alarm-6 latch-2 output status
7		
8	ALO7LA2_L1	Alarm-7 latch-2 output status
9	ALO8LA2_L1	Alarm-8 latch-2 output status
10 to 15		

● **Bit Configuration of D2074: ALOLA2_L2 (Loop-2 alarm-1 to alarm-8 latch-2 output status)**

Bit	Symbol	Event
0	ALO1LA2_L2	Alarm-1 latch-2 output status
1	ALO2LA2_L2	Alarm-2 latch-2 output status
2	ALO3LA2_L2	Alarm-3 latch-2 output status
3		
4	ALO4LA2_L2	Alarm-4 latch-2 output status
5	ALO5LA2_L2	Alarm-5 latch-2 output status
6	ALO6LA2_L2	Alarm-6 latch-2 output status
7		
8	ALO7LA2_L2	Alarm-7 latch-2 output status
9	ALO8LA2_L2	Alarm-8 latch-2 output status
10 to 15		

● **Bit Configuration of D2075: ALOLA3_L1 (Loop-1 alarm-1 to alarm-8 latch-3 output status)**

Bit	Symbol	Event
0	ALO1LA3_L1	Alarm-1 latch-3 output status
1	ALO2LA3_L1	Alarm-2 latch-3 output status
2	ALO3LA3_L1	Alarm-3 latch-3 output status
3		
4	ALO4LA3_L1	Alarm-4 latch-3 output status
5	ALO5LA3_L1	Alarm-5 latch-3 output status
6	ALO6LA3_L1	Alarm-6 latch-3 output status
7		
8	ALO7LA3_L1	Alarm-7 latch-3 output status
9	ALO8LA3_L1	Alarm-8 latch-3 output status
10 to 15		

6.4 UT55A/UT52A/UP55A D Registers

● Bit Configuration of D2076: ALOLA3_L2 (Loop-2 alarm-1 to alarm-8 latch-3 output status)

Bit	Symbol	Event
0	ALO1LA3_L2	Alarm-1 latch-3 output status
1	ALO2LA3_L2	Alarm-2 latch-3 output status
2	ALO3LA3_L2	Alarm-3 latch-3 output status
3		
4	ALO4LA3_L2	Alarm-4 latch-3 output status
5	ALO5LA3_L2	Alarm-5 latch-3 output status
6	ALO6LA3_L2	Alarm-6 latch-3 output status
7		
8	ALO7LA3_L2	Alarm-7 latch-3 output status
9	ALO8LA3_L2	Alarm-8 latch-3 output status
10 to 15		

● Bit Configuration of D2077: ALOLA4_L1 (Loop-1 alarm-1 to alarm-8 latch-4 output status)

Bit	Symbol	Event
0	ALO1LA4_L1	Alarm-1 latch-4 output status
1	ALO2LA4_L1	Alarm-2 latch-4 output status
2	ALO3LA4_L1	Alarm-3 latch-4 output status
3		
4	ALO4LA4_L1	Alarm-4 latch-4 output status
5	ALO5LA4_L1	Alarm-5 latch-4 output status
6	ALO6LA4_L1	Alarm-6 latch-4 output status
7		
8	ALO7LA4_L1	Alarm-7 latch-4 output status
9	ALO8LA4_L1	Alarm-8 latch-4 output status
10 to 15		

● Bit Configuration of D2078: ALOLA4_L2 (Loop-2 alarm-1 to alarm -8 latch-4 output status)

Bit	Symbol	Event
0	ALO1LA4_L2	Alarm-1 latch-4 output status
1	ALO2LA4_L2	Alarm-2 latch-4 output status
2	ALO3LA4_L2	Alarm-3 latch-4 output status
3		
4	ALO4LA4_L2	Alarm-4 latch-4 output status
5	ALO5LA4_L2	Alarm-5 latch-4 output status
6	ALO6LA4_L2	Alarm-6 latch-4 output status
7		
8	ALO7LA4_L2	Alarm-7 latch-4 output status
9	ALO8LA4_L2	Alarm-8 latch-4 output status
10 to 15		

Current SP Group and PID Group (D2101 to D2200)

Register No.	Description		Range and meaning of value
D2101	SP_L1_*	Loop-1 target setpoint	0.0 to 100.0% of PV input range (EU) (Setting range: SPL to SPH)
D2102	SUB_*	Loop-1 sub-target setpoint (in Two-position two-level control)	Set the offset from SP. -100.0 to 100.0% of PV input range span (EUS)
D2103	PIDN_L1_*	Loop-1 PID number selection	Set a PID group number to use. 1 to 8 (Depends on the PIDG. setting.)
D2104	A1_L1_*	Loop-1 alarm-1 setpoint	Set a display value of setpoint of PV alarm, SP alarm, deviation alarm, output alarm, or velocity alarm. -19999 to 30000 (Set a value within the input range.) Decimal point position depends on the input type.
D2105	A2_L1_*	Loop-1 alarm-2 setpoint	
D2106	A3_L1_*	Loop-1 alarm-3 setpoint	
D2107	A4_L1_*	Loop-1 alarm-4 setpoint	
D2108	A5_L1_*	Loop-1 alarm-5 setpoint	
D2109	A6_L1_*	Loop-1 alarm-6 setpoint	
D2110	A7_L1_*	Loop-1 alarm-7 setpoint	
D2111	A8_L1_*	Loop-1 alarm-8 setpoint	
D2112 to D2113			
D2114	P_L1_*	Proportional band Heating-side proportional band (in Heating/cooling control)	0.0 to 999.9% When 0.0 is set, it operates as 0.1. Heating-side ON/OFF control applies when 0.0 in Heating/cooling control
D2115	I_L1_*	Integral time Heating-side integral time (in Heating/cooling control)	0: OFF (Disable) 1 to 6000 s
D2116	D_L1_*	Derivative time Heating-side derivative time (in Heating/cooling control)	0: OFF (Disable) 1 to 6000 s
D2117	OH_L1_*	Control output high limit Heating-side control output high limit (in Heating/cooling control)	-4.9 to 105.0%, (OL<OH) In Heating/cooling control: 0.1 to 105.0% (OL<OH)
D2118	OL_L1_*	Control output low limit Heating-side control output low limit (in Heating/cooling control)	-5.0 to 104.9%, (OL<OH), SD: Tight shut In Heating/cooling control: 0.0 to 104.9% (OL<OH)
D2119	MR_L1_*	Manual reset	Enabled when integral time is OFF. The manual reset value equals the output value when PV = SP. -5.0 to 105.0%
D2120	HYS_L1_*	Hysteresis (in ON/OFF control, Position proportional control, or Two-position two-level control) Heating-side ON/OFF control hysteresis (in Heating/cooling control)	In ON/OFF control or Two-position two-level control: 0.0 to 100.0% of PV input range span (EUS) In Heating/cooling control or Position proportional control: 0.0 to 100.0%
D2121	SU.HY_L1_*	Sub-hysteresis (in Two-position two-level control)	0.0 to 100.0% of PV input range span (EUS)
D2122	HY.UP_L1_*	Upper-side hysteresis (in ON/OFF control)	0.0 to 100.0% of PV input range span (EUS)
D2123	HY.LO_L1_*	Lower-side hysteresis (in ON/OFF control)	
D2124	DR_L1_*	Direct/reverse action switch	0: RVS (Reverse action)
D2125	SU.DR_*	Sub-direct/reverse action switch (in Two-position two-level control)	1: DIR (Direct action)
D2126	Pc_L1_*	Cooling-side proportional band	0.0 to 999.9% (Cooling-side ON/OFF control applies when 0.0 in Heating/cooling control)
D2127	Ic_L1_*	Cooling-side integral time	0: OFF (Disable) 1 to 6000 s
D2128	Dc_L1_*	Cooling-side derivative time	0: OFF (Disable) 1 to 6000 s
D2129	OHc_L1_*	Cooling-side control output high limit	0.1 to 105.0%, (OLc<OHc)

*: 1 to 8, or R

6.4 UT55A/UT52A/UP55A D Registers

Register No.		Description	Range and meaning of value
D2130	OLc_L1_*	Cooling-side control output low limit	0.0 to 104.9%, (OLc<OHc)
D2131	HYSc_L1_*	Cooling-side ON/OFF control hysteresis	0.0 to 100.0%
D2132	DB_L1_*	Output dead band (in Heating/cooling control or Position proportional control)	In Heating/cooling control: -100.0 to 50.0% In Position proportional control: 1.0 to 10.0%
D2133	PO_L1_*	Preset output Heating-side preset output (in Heating/cooling control)	In STOP mode, fixed control output can be generated. In Position proportional control, Valve opening can be set -5.0 to 105.0%
D2134	SU.PO_*	Sub-preset output (in Two-position two-level control)	In STOP mode, fixed sub-control output can be generated. 0%, 100%
D2135	POc_L1_*	Cooling-side preset output	In STOP mode, cooling-side fixed control output can be generated. -5.0 to 105.0%
D2136 to D2150			
D2151	SP_L2_*	Loop-2 target setpoint	Same as D2101
D2152			
D2153 to D2161	PIDN_L2_* to A8_L2_*	Loop-2 PID number selection to alarm-8 setpoint	Same as D2103 to D2111
D2162 to D2163			
D2164 to D2170	P_L2_* to HYS_L2_*	Loop-2 proportional band Heating-side proportional band (in Heating/cooling control) to Hysteresis (in ON/OFF control or Position proportional control) Heating-side ON/OFF control hysteresis (in Heating/cooling control)	Same as D2114 to D2120
D2171 to D2173			
D2174	DR_L2_*	Loop-2 direct/reverse action switch	Same as D2124
D2175			
D2176 to D2183	Pc_L2_* to PO_L2_*	Loop-2 cooling-side proportional band to Preset output Heating-side preset output (in Heating/cooling control)	Same as D2126 to D2133
D2184			
D2185	POc_L2_*	Cooling-side preset output	In STOP mode, cooling-side fixed control output can be generated. -5.0 to 105.0%
D2186 to D2200			

*: 1 to 8, or R

Local-mode Operation Setting for UP55A (D2201 to D2300)

Register No.	Description		Range and meaning of value
D2201	LSP_L1	Loop-1 local target setpoint	0.0 to 100.0% of PV input range (EU) (Setting range: P.RL to P.RH)
D2202	LSP_L2	Loop-2 local target setpoint	
D2203	L.PID	PID number selection for local-mode operation	Set a PID group number to use. 1 to 8 * Available only for the L.PID when ZON = 0 or 5. * If set to "Local PID selection," local PID is selected irrespective of the operation modes.
D2204	L.TY1	Local event-1 type	OFF: Disable (Energized) 01: PV high limit, 02: PV low limit, 03: SP high limit, 04: SP low limit, 05: Deviation high limit, 06: Deviation low limit, 07: Deviation high and low limits, 08: Deviation within high and low limits, 09: Target SP high limit, 10: Target SP low limit, 11: Target SP deviation high limit, 12: Target SP deviation low limit, 13: Target SP deviation high and low limits, 14: Target SP deviation within high and low limits, 15: OUT high limit, 16: OUT low limit, 17: Cooling-side OUT high limit, 18: Cooling-side OUT low limit * Add 100 for "de-energized". For example, when the PV high limit is de-energized, the setting is 101.
D2205	L.EV1	Local event-1 setpoint	Set a display value of setpoint of PV alarm, SP alarm, deviation alarm, or output alarm. -19999 to 30000 (Set a value within the input range.) Decimal point position depends on the input type
D2206	L.TY2	Local event-2 type	Same as D2204
D2207	L.EV2	Local event-2 setpoint	Same as D2205
D2208	L.TY3	Local event-3 type	Same as D2204
D2209	L.EV3	Local event-3 setpoint	Same as D2205
D2210	L.TY4	Local event-4 type	Same as D2204
D2211	L.EV4	Local event-4 setpoint	Same as D2205
D2212	L.TY5	Local event-5 type	Same as D2204
D2213	L.EV5	Local event-5 setpoint	Same as D2205
D2214	L.TY6	Local event-6 type	Same as D2204
D2215	L.EV6	Local event-6 setpoint	Same as D2205
D2216	L.TY7	Local event-7 type	Same as D2204
D2217	L.EV7	Local event-7 setpoint	Same as D2205
D2218	L.TY8	Local event-8 type	Same as D2204
D2219	L.EV8	Local event-8 setpoint	Same as D2205
D2220 to D2300			

6.4.2 Loop-1 / Loop-2 Operation Mode Parameter and Loop-1 / Loop-2 Operation Parameter for UP55A (D2301 to D2500)

Operation mode parameters													
Loop-1 / Loop-2 operation mode (Menu: MODE), Loop-1 / Loop-2 Alarm setpoint setting (Menu:AL)													
D-Reg No.	Ref. No.	H No.	Register symbol	R/W			D-Reg No.	Ref. No.	H No.	Register symbol	R/W		
				UT 55A	UT 52A	UP 55A					UT 55A	UT 52A	UP 55A
D2301	42301	08FC	A.M	R/W	R/W	/	D2351	42351	092E	A1_L1	/	/	R/W
D2302	42302	08FD					D2352	42352	092F	A2_L1	/	/	R/W
D2303	42303	08FE	C.A.M	R/W	R/W	/	D2353	42353	0930	A3_L1	/	/	R/W
D2304	42304	08FF	S.R	R/W	R/W	/	D2354	42354	0931	A4_L1	/	/	R/W
D2305	42305	0900					D2355	42355	0932	A5_L1	/	/	R/W
D2306	42306	0901	R.L_L1	R/W	R/W	/	D2356	42356	0933	A6_L1	/	/	R/W
D2307	42307	0902	R.L_L2	R/W	R/W	/	D2357	42357	0934	A7_L1	/	/	R/W
D2308	42308	0903	AT_L1	R/W	R/W	R/W	D2358	42358	0935	A8_L1	/	/	R/W
D2309	42309	0904	AT_L2	R/W	R/W	R/W	D2359	42359	0936				
D2310	42310	0905					D2360	42360	0937				
D2311	42311	0906					D2361	42361	0938	A1_L2	/	/	R/W
D2312	42312	0907	SPNO.	R/W	R/W	/	D2362	42362	0939	A2_L2	/	/	R/W
D2313	42313	0908					D2363	42363	093A	A3_L2	/	/	R/W
D2314	42314	0909	TRK_ON_L1	R/W	R/W	R/W	D2364	42364	093B	A4_L2	/	/	R/W
D2315	42315	090A					D2365	42365	093C	A5_L2	/	/	R/W
D2316	42316	090B	MODE	/	/	R/W	D2366	42366	093D	A6_L2	/	/	R/W
D2317	42317	090C	HOLD	/	/	R/W	D2367	42367	093E	A7_L2	/	/	R/W
D2318	42318	090D	ADV	/	/	R/W	D2368	42368	093F	A8_L2	/	/	R/W
D2319	42319	090E	A.M_L1	/	/	R/W	D2369	42369	0940				
D2320	42320	090F	A.M_L2	/	/	R/W	D2370	42370	0941				
D2321	42321	0910	L.C	/	/	R/W	D2371	42371	0942				
D2322	42322	0911	PTNO.	/	/	R/W	D2372	42372	0943				
D2323	42323	0912					D2373	42373	0944				
D2324	42324	0913					D2374	42374	0945				
D2325	42325	0914					D2375	42375	0946				
D2326	42326	0915					D2376	42376	0947				
D2327	42327	0916					D2377	42377	0948				
D2328	42328	0917					D2378	42378	0949				
D2329	42329	0918					D2379	42379	094A				
D2330	42330	0919					D2380	42380	094B				
D2331	42331	091A	C.RSP_L1	R/W	R/W	R/W	D2381	42381	094C				
D2332	42332	091B	C.RSP_L2	R/W	R/W	/	D2382	42382	094D				
D2333	42333	091C	MOUT_L1	R/W	R/W	R/W	D2383	42383	094E				
D2334	42334	091D	MOUTc_L1	R/W	R/W	R/W	D2384	42384	094F				
D2335	42335	091E	MOUT_L2	R/W	R/W	R/W	D2385	42385	0950				
D2336	42336	091F	MOUTc_L2	R/W	R/W	R/W	D2386	42386	0951				
D2337	42337	0920	H.SP_L1	/	/	R/W	D2387	42387	0952				
D2338	42338	0921	H.SP_L2	/	/	R/W	D2388	42388	0953				
D2339	42339	0922	H.TSP_L1	/	/	R/W	D2389	42389	0954				
D2340	42340	0923	H.TSP_L2	/	/	R/W	D2390	42390	0955				
D2341	42341	0924	H.TM	/	/	R/W	D2391	42391	0956				
D2342	42342	0925	SST	/	/	R/W	D2392	42392	0957				
D2343	42343	0926	P.FWD	/	/	R/W	D2393	42393	0958				
D2344	42344	0927					D2394	42394	0959				
D2345	42345	0928					D2395	42395	095A				
D2346	42346	0929					D2396	42396	095B				
D2347	42347	092A					D2397	42397	095C				
D2348	42348	092B					D2398	42398	095D				
D2349	42349	092C					D2399	42399	095E				
D2350	42350	092D					D2400	42400	095F				

Process monitoring area													
Free area													
D-Reg No.	Ref. No.	H No.	Register symbol	R/W			D-Reg No.	Ref. No.	H No.	Register symbol	R/W		
				UT 55A	UT 52A	UP 55A					UT 55A	UT 52A	UP 55A
D2401	42401	0960					D2451	42451	0992				
D2402	42402	0961					D2452	42452	0993				
D2403	42403	0962					D2453	42453	0994				
D2404	42404	0963					D2454	42454	0995				
D2405	42405	0964					D2455	42455	0996				
D2406	42406	0965					D2456	42456	0997				
D2407	42407	0966					D2457	42457	0998				
D2408	42408	0967					D2458	42458	0999				
D2409	42409	0968					D2459	42459	099A				
D2410	42410	0969					D2460	42460	099B				
D2411	42411	096A					D2461	42461	099C				
D2412	42412	096B					D2462	42462	099D				
D2413	42413	096C					D2463	42463	099E				
D2414	42414	096D					D2464	42464	099F				
D2415	42415	096E					D2465	42465	09A0				
D2416	42416	096F					D2466	42466	09A1				
D2417	42417	0970					D2467	42467	09A2				
D2418	42418	0971					D2468	42468	09A3				
D2419	42419	0972					D2469	42469	09A4				
D2420	42420	0973					D2470	42470	09A5				
D2421	42421	0974					D2471	42471	09A6				
D2422	42422	0975					D2472	42472	09A7				
D2423	42423	0976					D2473	42473	09A8				
D2424	42424	0977					D2474	42474	09A9				
D2425	42425	0978					D2475	42475	09AA				
D2426	42426	0979					D2476	42476	09AB				
D2427	42427	097A					D2477	42477	09AC				
D2428	42428	097B					D2478	42478	09AD				
D2429	42429	097C					D2479	42479	09AE				
D2430	42430	097D					D2480	42480	09AF				
D2431	42431	097E					D2481	42481	09B0				
D2432	42432	097F					D2482	42482	09B1				
D2433	42433	0980					D2483	42483	09B2				
D2434	42434	0981					D2484	42484	09B3				
D2435	42435	0982					D2485	42485	09B4				
D2436	42436	0983					D2486	42486	09B5				
D2437	42437	0984					D2487	42487	09B6				
D2438	42438	0985					D2488	42488	09B7				
D2439	42439	0986					D2489	42489	09B8				
D2440	42440	0987					D2490	42490	09B9				
D2441	42441	0988					D2491	42491	09BA				
D2442	42442	0989					D2492	42492	09BB				
D2443	42443	098A					D2493	42493	09BC				
D2444	42444	098B					D2494	42494	09BD				
D2445	42445	098C					D2495	42495	09BE				
D2446	42446	098D					D2496	42496	09BF				
D2447	42447	098E					D2497	42497	09C0				
D2448	42448	098F					D2498	42498	09C1				
D2449	42449	0990					D2499	42499	09C2				
D2450	42450	0991					D2500	42500	09C3				

6.4 UT55A/UT52A/UP55A D Registers

Loop-1 / Loop-2 Operation Mode and Loop-1 / Loop-2 Alarm Setpoint Setting for UP55A (D2301 to D2400)

Register No.	Description		Range and meaning of value
D2301	A.M	AUTO/MAN switch	0: AUTO (Automatic mode) 1: MAN (Manual mode) Effective for the control modes except for cascade control and cascade secondary-loop control.
D2302			
D2303	C.A.M	CAS/AUTO/MAN switch	0: AUTO (Automatic mode) 1: MAN (Manual mode) 2: CAS (Cascade mode) Effective for cascade control mode and cascade secondary-loop control mode.
D2304	S.R	STOP/RUN switch	0: RUN (Run mode) 1: STOP (Stop mode) Preset output (PO) is generated in STOP mode. Default: Not displayed. STOP/RUN switch is assigned to contact input.
D2305			
D2306	R.L_L1	Loop-1 REMOTE/LOCAL switch	0: LCL (Local mode) 1: REM (Remote mode) Select a remote input method for acquiring the target setpoint from remote input, program operation, or communication using the parameter RMS.
D2307	R.L_L2	Loop-2 REMOTE/LOCAL switch	0: LCL (Local mode) 1: REM (Remote mode) Select a remote input method for acquiring the target setpoint from remote input, program operation, or communication using the parameter RMS.
D2308	AT_L1	Loop-1 auto-tuning switch	0: OFF (Disable)
D2309	AT_L2	Loop-2 auto-tuning switch	1 to 8: Perform auto-tuning. Tuning result is stored in the specified numbered PID. 9: R (Tuning result is stored in the PID for reference deviation.)
D2310 to D2311			
D2312	SPNO.	SP number selection	1 to 8 (Depends on the setup parameter SPGR. setting.)
D2313			
D2314	TRK_ON_L1	Output tracking status	0: OFF 1: ON
D2315			
D2316	MODE	Operation mode (Start/stop of program operation / start of local-mode operation / start of remote-mode operation)	0: RESET (Stop of program operation) 1: PROG (Start of program operation) 2: LOCAL (Start of local-mode operation) 3: REM (Start of remote-mode operation)
D2317	HOLD	Pause/cancel release of program operation	Display during program operation. 0: OFF (Cancel release (Program operation restart)) 1: ON (Pause)
D2318	ADV	Advance of segment	Display during program operation. Set as "ADV = 1 (ON)" to advance from the current segment to the next segment.
D2319	A.M_L1	Loop-1 AUTO/MAN switch	0: AUTO (Automatic mode)
D2320	A.M_L2	Loop-2 AUTO/MAN switch	1: MAN (Manual mode)
D2321	L.C	LOCAL(LSP)/CAS switch	0: CAS (Cascade mode) 1: LSP (Local mode))
D2322	PTNO.	Program pattern number selection	0: Not select program pattern 1 to 30
D2323 to D2330			

6.4 UT55A/UT52A/UP55A D Registers

Register No.	Description		Range and meaning of value
D2331	C.RSP_L1	Loop-1 communication remote setpoint	0.0 to 100.0% of PV input range (EU)
D2332	C.RSP_L2	Loop-2 communication remote setpoint	
D2333	MOU_T_L1	Loop-1 heating-side control output in MAN mode	0.0 to 105.0% (Standard type: -5.0 to 105.0%)
D2334	MOU_Tc_L1	Loop-1 cooling-side control output in MAN mode	0.0 to 105.0%
D2335	MOU_T_L2	Loop-2 heating-side control output in MAN mode	0.0 to 105.0% (Standard type: -5.0 to 105.0%)
D2336	MOU_Tc_L2	Loop-2 cooling-side control output in MAN mode	0.0 to 105.0%
D2337	H.SP_L1	Loop-1 SP for HOLD state	0.0 to 100.0% of PV input range (EU)
D2338	H.SP_L2	Loop-2 SP for HOLD state	
D2339	H.TSP_L1	Loop-1 TSP for HOLD state	
D2340	H.TSP_L2	Loop-2 TSP for HOLD state	
D2341	H.TM	HOLD time	0 to 59999 (minute or second) * Use the parameter TMU to set the time unit.
D2343	SST	Start-of-program segment number	1 to 99 The setting value returns to "1" when the program operation (PROG) changes into RESET, LOCAL, or REM.
D2343	P.FWD	Fast-forwarding of program operation	1: Normal 2: Twice 5: Five times 10: Ten times 20: Twenty times * Use this function when checking the program pattern setting. Only Segment time and Time event can be faster. * The operation returns to the normal speed after fast-forwarding.
D2344 to D2350			
D2351	A1_L1_1	Loop-1 Alarm-1 setpoint	These alarms work irrespective of the operation mode. Set a display value of setpoint of PV alarm, SP alarm, deviation alarm, output alarm, or velocity alarm. -19999 to 30000 (Set a value within the input range.) Decimal point position depends on the input type.
D2352	A2_L1_1	Loop-1 Alarm-2 setpoint	
D2353	A3_L1_1	Loop-1 Alarm-3 setpoint	
D2354	A4_L1_1	Loop-1 Alarm-4 setpoint	
D2355	A5_L1_1	Loop-1 Alarm-5 setpoint	
D2356	A6_L1_1	Loop-1 Alarm-6 setpoint	
D2357	A7_L1_1	Loop-1 Alarm-7 setpoint	
D2358	A8_L1_1	Loop-1 Alarm-8 setpoint	
D2359 to D2360			
D2361	A1_L2_1	Loop-2 Alarm-1 setpoint	
D2362	A2_L2_1	Loop-2 Alarm-2 setpoint	
D2363	A3_L2_1	Loop-2 Alarm-3 setpoint	
D2364	A4_L2_1	Loop-2 Alarm-4 setpoint	
D2365	A5_L2_1	Loop-2 Alarm-5 setpoint	
D2366	A6_L2_1	Loop-2 Alarm-6 setpoint	
D2367	A7_L2_1	Loop-2 Alarm-7 setpoint	
D2368	A8_L2_1	Loop-2 Alarm-8 setpoint	
D2369 to D2400			

Free Area (D2401 to D2500)

Register No.	Description	Range and meaning of value
D2401 to D2500	Free area	

6.4 UT55A/UT52A/UP55A D Registers

6.4.3 Loop-1 Operation Parameter (D2501 to D3600)

Loop-1 operation parameter													
SP and alarm setpoint setting (Menu: SP)													
D-Reg No.	Ref. No.	H No.	Register symbol	R/W			D-Reg No.	Ref. No.	H No.	Register symbol	R/W		
				UT 55A	UP 52A	UP 55A					UT 55A	UT 52A	UP 55A
D2501	42501	09C4	SP_L1_1	R/W	R/W	/	D2551	42551	09F6	A8_L1_3	R/W	R/W	/
D2502	42502	09C5	SUB_1	R/W	R/W	/	D2552	42552	09F7				
D2503	42503	09C6	PIDN_L1_1	R/W	R/W	/	D2553	42553	09F8				
D2504	42504	09C7	A1_L1_1	R/W	R/W	/	D2554	42554	09F9				
D2505	42505	09C8	A2_L1_1	R/W	R/W	/	D2555	42555	09FA				
D2506	42506	09C9	A3_L1_1	R/W	R/W	/	D2556	42556	09FB				
D2507	42507	09CA	A4_L1_1	R/W	R/W	/	D2557	42557	09FC				
D2508	42508	09CB	A5_L1_1	R/W	R/W	/	D2558	42558	09FD				
D2509	42509	09CC	A6_L1_1	R/W	R/W	/	D2559	42559	09FE				
D2510	42510	09CD	A7_L1_1	R/W	R/W	/	D2560	42560	09FF				
D2511	42511	09CE	A8_L1_1	R/W	R/W	/	D2561	42561	0A00	SP_L1_4	R/W	R/W	/
D2512	42512	09CF					D2562	42562	0A01	SUB_4	R/W	R/W	/
D2513	42513	09D0					D2563	42563	0A02	PIDN_L1_4	R/W	R/W	/
D2514	42514	09D1					D2564	42564	0A03	A1_L1_4	R/W	R/W	/
D2515	42515	09D2					D2565	42565	0A04	A2_L1_4	R/W	R/W	/
D2516	42516	09D3					D2566	42566	0A05	A3_L1_4	R/W	R/W	/
D2517	42517	09D4					D2567	42567	0A06	A4_L1_4	R/W	R/W	/
D2518	42518	09D5					D2568	42568	0A07	A5_L1_4	R/W	R/W	/
D2519	42519	09D6					D2569	42569	0A08	A6_L1_4	R/W	R/W	/
D2520	42520	09D7					D2570	42570	0A09	A7_L1_4	R/W	R/W	/
D2521	42521	09D8	SP_L1_2	R/W	R/W	/	D2571	42571	0A0A	A8_L1_4	R/W	R/W	/
D2522	42522	09D9	SUB_2	R/W	R/W	/	D2572	42572	0A0B				
D2523	42523	09DA	PIDN_L1_2	R/W	R/W	/	D2573	42573	0A0C				
D2524	42524	09DB	A1_L1_2	R/W	R/W	/	D2574	42574	0A0D				
D2525	42525	09DC	A2_L1_2	R/W	R/W	/	D2575	42575	0A0E				
D2526	42526	09DD	A3_L1_2	R/W	R/W	/	D2576	42576	0A0F				
D2527	42527	09DE	A4_L1_2	R/W	R/W	/	D2577	42577	0A10				
D2528	42528	09DF	A5_L1_2	R/W	R/W	/	D2578	42578	0A11				
D2529	42529	09E0	A6_L1_2	R/W	R/W	/	D2579	42579	0A12				
D2530	42530	09E1	A7_L1_2	R/W	R/W	/	D2580	42580	0A13				
D2531	42531	09E2	A8_L1_2	R/W	R/W	/	D2581	42581	0A14	SP_L1_5	R/W	R/W	/
D2532	42532	09E3					D2582	42582	0A15	SUB_5	R/W	R/W	/
D2533	42533	09E4					D2583	42583	0A16	PIDN_L1_5	R/W	R/W	/
D2534	42534	09E5					D2584	42584	0A17	A1_L1_5	R/W	R/W	/
D2535	42535	09E6					D2585	42585	0A18	A2_L1_5	R/W	R/W	/
D2536	42536	09E7					D2586	42586	0A19	A3_L1_5	R/W	R/W	/
D2537	42537	09E8					D2587	42587	0A1A	A4_L1_5	R/W	R/W	/
D2538	42538	09E9					D2588	42588	0A1B	A5_L1_5	R/W	R/W	/
D2539	42539	09EA					D2589	42589	0A1C	A6_L1_5	R/W	R/W	/
D2540	42540	09EB					D2590	42590	0A1D	A7_L1_5	R/W	R/W	/
D2541	42541	09EC	SP_L1_3	R/W	R/W	/	D2591	42591	0A1E	A8_L1_5	R/W	R/W	/
D2542	42542	09ED	SUB_3	R/W	R/W	/	D2592	42592	0A1F				
D2543	42543	09EE	PIDN_L1_3	R/W	R/W	/	D2593	42593	0A20				
D2544	42544	09EF	A1_L1_3	R/W	R/W	/	D2594	42594	0A21				
D2545	42545	09F0	A2_L1_3	R/W	R/W	/	D2595	42595	0A22				
D2546	42546	09F1	A3_L1_3	R/W	R/W	/	D2596	42596	0A23				
D2547	42547	09F2	A4_L1_3	R/W	R/W	/	D2597	42597	0A24				
D2548	42548	09F3	A5_L1_3	R/W	R/W	/	D2598	42598	0A25				
D2549	42549	09F4	A6_L1_3	R/W	R/W	/	D2599	42599	0A26				
D2550	42550	09F5	A7_L1_3	R/W	R/W	/	D2600	42600	0A27				

Loop-1 operation parameter													
SP and alarm setpoint setting (Menu: SP)													
D-Reg No.	Ref. No.	H No.	Register symbol	R/W			D-Reg No.	Ref. No.	H No.	Register symbol	R/W		
				UT 55A	UT 52A	UP 55A					UT 55A	UT 52A	UP 55A
D2601	42601	0A28	SP_L1_6	R/W	R/W	/	D2651	42651	0A5A	A8_L1_8	R/W	R/W	/
D2602	42602	0A29	SUB_6	R/W	R/W	/	D2652	42652	0A5B				
D2603	42603	0A2A	PIDN_L1_6	R/W	R/W	/	D2653	42653	0A5C				
D2604	42604	0A2B	A1_L1_6	R/W	R/W	/	D2654	42654	0A5D				
D2605	42605	0A2C	A2_L1_6	R/W	R/W	/	D2655	42655	0A5E				
D2606	42606	0A2D	A3_L1_6	R/W	R/W	/	D2656	42656	0A5F				
D2607	42607	0A2E	A4_L1_6	R/W	R/W	/	D2657	42657	0A60				
D2608	42608	0A2F	A5_L1_6	R/W	R/W	/	D2658	42658	0A61				
D2609	42609	0A30	A6_L1_6	R/W	R/W	/	D2659	42659	0A62				
D2610	42610	0A31	A7_L1_6	R/W	R/W	/	D2660	42660	0A63				
D2611	42611	0A32	A8_L1_6	R/W	R/W	/	D2661	42661	0A64				
D2612	42612	0A33					D2662	42662	0A65				
D2613	42613	0A34					D2663	42663	0A66				
D2614	42614	0A35					D2664	42664	0A67				
D2615	42615	0A36					D2665	42665	0A68				
D2616	42616	0A37					D2666	42666	0A69				
D2617	42617	0A38					D2667	42667	0A6A				
D2618	42618	0A39					D2668	42668	0A6B				
D2619	42619	0A3A					D2669	42669	0A6C				
D2620	42620	0A3B					D2670	42670	0A6D				
D2621	42621	0A3C	SP_L1_7	R/W	R/W	/	D2671	42671	0A6E				
D2622	42622	0A3D	SUB_7	R/W	R/W	/	D2672	42672	0A6F				
D2623	42623	0A3E	PIDN_L1_7	R/W	R/W	/	D2673	42673	0A70				
D2624	42624	0A3F	A1_L1_7	R/W	R/W	/	D2674	42674	0A71				
D2625	42625	0A40	A2_L1_7	R/W	R/W	/	D2675	42675	0A72				
D2626	42626	0A41	A3_L1_7	R/W	R/W	/	D2676	42676	0A73				
D2627	42627	0A42	A4_L1_7	R/W	R/W	/	D2677	42677	0A74				
D2628	42628	0A43	A5_L1_7	R/W	R/W	/	D2678	42678	0A75				
D2629	42629	0A44	A6_L1_7	R/W	R/W	/	D2679	42679	0A76				
D2630	42630	0A45	A7_L1_7	R/W	R/W	/	D2680	42680	0A77				
D2631	42631	0A46	A8_L1_7	R/W	R/W	/	D2681	42681	0A78				
D2632	42632	0A47					D2682	42682	0A79				
D2633	42633	0A48					D2683	42683	0A7A				
D2634	42634	0A49					D2684	42684	0A7B				
D2635	42635	0A4A					D2685	42685	0A7C				
D2636	42636	0A4B					D2686	42686	0A7D				
D2637	42637	0A4C					D2687	42687	0A7E				
D2638	42638	0A4D					D2688	42688	0A7F				
D2639	42639	0A4E					D2689	42689	0A80				
D2640	42640	0A4F					D2690	42690	0A81				
D2641	42641	0A50	SP_L1_8	R/W	R/W	/	D2691	42691	0A82				
D2642	42642	0A51	SUB_8	R/W	R/W	/	D2692	42692	0A83				
D2643	42643	0A52	PIDN_L1_8	R/W	R/W	/	D2693	42693	0A84				
D2644	42644	0A53	A1_L1_8	R/W	R/W	/	D2694	42694	0A85				
D2645	42645	0A54	A2_L1_8	R/W	R/W	/	D2695	42695	0A86				
D2646	42646	0A55	A3_L1_8	R/W	R/W	/	D2696	42696	0A87				
D2647	42647	0A56	A4_L1_8	R/W	R/W	/	D2697	42697	0A88				
D2648	42648	0A57	A5_L1_8	R/W	R/W	/	D2698	42698	0A89				
D2649	42649	0A58	A6_L1_8	R/W	R/W	/	D2699	42699	0A8A				
D2650	42650	0A59	A7_L1_8	R/W	R/W	/	D2700	42700	0A8B				

6.4 UT55A/UT52A/UP55A D Registers

Loop-1 operation parameter													
SP-related setting (Menu: SPS)													
D-Reg No.	Ref. No.	H No.	Register symbol	R/W			D-Reg No.	Ref. No.	H No.	Register symbol	R/W		
				UT 55A	UT 52A	UP 55A					UT 55A	UT 52A	UP 55A
D2701	42701	0A8C	RMS_L1	R/W	R/W	R/W	D2751	42751	0ABE				
D2702	42702	0A8D	RFL_L1	R/W	R/W	R/W	D2752	42752	0ABF				
D2703	42703	0A8E	RT_L1	R/W	R/W	R/W	D2753	42753	0AC0				
D2704	42704	0A8F	RBS_L1	R/W	R/W	R/W	D2754	42754	0AC1				
D2705	42705	0A90	UPR_L1	R/W	R/W		D2755	42755	0AC2				
D2706	42706	0A91	DNR_L1	R/W	R/W		D2756	42756	0AC3				
D2707	42707	0A92	TMU_L1	R/W	R/W		D2757	42757	0AC4				
D2708	42708	0A93					D2758	42758	0AC5				
D2709	42709	0A94					D2759	42759	0AC6				
D2710	42710	0A95	SPT_L1	R/W	R/W	R/W	D2760	42760	0AC7				
D2711	42711	0A96	PVT_L1	R/W	R/W		D2761	42761	0AC8				
D2712	42712	0A97	S.TM			R/W	D2762	42762	0AC9				
D2713	42713	0A98	PNC			R/W	D2763	42763	0ACA				
D2714	42714	0A99					D2764	42764	0ACB				
D2715	42715	0A9A					D2765	42765	0ACC				
D2716	42716	0A9B					D2766	42766	0ACD				
D2717	42717	0A9C					D2767	42767	0ACE				
D2718	42718	0A9D					D2768	42768	0ACF				
D2719	42719	0A9E					D2769	42769	0AD0				
D2720	42720	0A9F					D2770	42770	0AD1				
D2721	42721	0AA0					D2771	42771	0AD2				
D2722	42722	0AA1					D2772	42772	0AD3				
D2723	42723	0AA2					D2773	42773	0AD4				
D2724	42724	0AA3					D2774	42774	0AD5				
D2725	42725	0AA4					D2775	42775	0AD6				
D2726	42726	0AA5					D2776	42776	0AD7				
D2727	42727	0AA6					D2777	42777	0AD8				
D2728	42728	0AA7					D2778	42778	0AD9				
D2729	42729	0AA8					D2779	42779	0ADA				
D2730	42730	0AA9					D2780	42780	0ADB				
D2731	42731	0AAA					D2781	42781	0ADC				
D2732	42732	0AAB					D2782	42782	0ADD				
D2733	42733	0AAC					D2783	42783	0ADE				
D2734	42734	0AAD					D2784	42784	0ADF				
D2735	42735	0AAE					D2785	42785	0AE0				
D2736	42736	0AAF					D2786	42786	0AE1				
D2737	42737	0AB0					D2787	42787	0AE2				
D2738	42738	0AB1					D2788	42788	0AE3				
D2739	42739	0AB2					D2789	42789	0AE4				
D2740	42740	0AB3					D2790	42790	0AE5				
D2741	42741	0AB4					D2791	42791	0AE6				
D2742	42742	0AB5					D2792	42792	0AE7				
D2743	42743	0AB6					D2793	42793	0AE8				
D2744	42744	0AB7					D2794	42794	0AE9				
D2745	42745	0AB8					D2795	42795	0AEA				
D2746	42746	0AB9					D2796	42796	0AEB				
D2747	42747	0ABA					D2797	42797	0AEC				
D2748	42748	0ABB					D2798	42798	0AED				
D2749	42749	0ABC					D2799	42799	0AEE				
D2750	42750	0ABD					D2800	42800	0AEF				

Loop-1 operation parameter													
Alarm function setting (Menu: ALRM)													
D-Reg No.	Ref. No.	H No.	Register symbol	R/W			D-Reg No.	Ref. No.	H No.	Register symbol	R/W		
				UT 55A	UT 52A	UP 55A					UT 55A	UT 52A	UP 55A
D2801	42801	0AF0	AL1.T_L1	R/W	R/W	R/W	D2851	42851	0B22	DYN3_L1	R/W	R/W	R/W
D2802	42802	0AF1	AL1.W_L1	R/W	R/W	R/W	D2852	42852	0B23	DYN4_L1	R/W	R/W	R/W
D2803	42803	0AF2	AL1.D_L1	R/W	R/W	R/W	D2853	42853	0B24	DYN5_L1	R/W	R/W	R/W
D2804	42804	0AF3	AL1.L_L1	R/W	R/W	R/W	D2854	42854	0B25	DYN6_L1	R/W	R/W	R/W
D2805	42805	0AF4	AL2.T_L1	R/W	R/W	R/W	D2855	42855	0B26	DYN7_L1	R/W	R/W	R/W
D2806	42806	0AF5	AL2.W_L1	R/W	R/W	R/W	D2856	42856	0B27	DYN8_L1	R/W	R/W	R/W
D2807	42807	0AF6	AL2.D_L1	R/W	R/W	R/W	D2857	42857	0B28	DYF1_L1	R/W	R/W	R/W
D2808	42808	0AF7	AL2.L_L1	R/W	R/W	R/W	D2858	42858	0B29	DYF2_L1	R/W	R/W	R/W
D2809	42809	0AF8	AL3.T_L1	R/W	R/W	R/W	D2859	42859	0B2A	DYF3_L1	R/W	R/W	R/W
D2810	42810	0AF9	AL3.W_L1	R/W	R/W	R/W	D2860	42860	0B2B	DYF4_L1	R/W	R/W	R/W
D2811	42811	0AFA	AL3.D_L1	R/W	R/W	R/W	D2861	42861	0B2C	DYF5_L1	R/W	R/W	R/W
D2812	42812	0AFB	AL3.L_L1	R/W	R/W	R/W	D2862	42862	0B2D	DYF6_L1	R/W	R/W	R/W
D2813	42813	0AFC	AL4.T_L1	R/W	R/W	R/W	D2863	42863	0B2E	DYF7_L1	R/W	R/W	R/W
D2814	42814	0AFD	AL4.W_L1	R/W	R/W	R/W	D2864	42864	0B2F	DYF8_L1	R/W	R/W	R/W
D2815	42815	0AFE	AL4.D_L1	R/W	R/W	R/W	D2865	42865	0B30				
D2816	42816	0AFF	AL4.L_L1	R/W	R/W	R/W	D2866	42866	0B31	AMD_L1	R/W	R/W	R/W
D2817	42817	0B00	AL5.T_L1	R/W	R/W	R/W	D2867	42867	0B32				
D2818	42818	0B01	AL5.W_L1	R/W	R/W	R/W	D2868	42868	0B33				
D2819	42819	0B02	AL5.D_L1	R/W	R/W	R/W	D2869	42869	0B34				
D2820	42820	0B03	AL5.L_L1	R/W	R/W	R/W	D2870	42870	0B35				
D2821	42821	0B04	AL6.T_L1	R/W	R/W	R/W	D2871	42871	0B36	EHY1			R/W
D2822	42822	0B05	AL6.W_L1	R/W	R/W	R/W	D2872	42872	0B37	EHY2			R/W
D2823	42823	0B06	AL6.D_L1	R/W	R/W	R/W	D2873	42873	0B38	EHY3			R/W
D2824	42824	0B07	AL6.L_L1	R/W	R/W	R/W	D2874	42874	0B39	EHY4			R/W
D2825	42825	0B08	AL7.T_L1	R/W	R/W	R/W	D2875	42875	0B3A	EHY5			R/W
D2826	42826	0B09	AL7.W_L1	R/W	R/W	R/W	D2876	42876	0B3B	EHY6			R/W
D2827	42827	0B0A	AL7.D_L1	R/W	R/W	R/W	D2877	42877	0B3C	EHY7			R/W
D2828	42828	0B0B	AL7.L_L1	R/W	R/W	R/W	D2878	42878	0B3D	EHY8			R/W
D2829	42829	0B0C	AL8.T_L1	R/W	R/W	R/W	D2879	42879	0B3E				
D2830	42830	0B0D	AL8.W_L1	R/W	R/W	R/W	D2880	42880	0B3F				
D2831	42831	0B0E	AL8.D_L1	R/W	R/W	R/W	D2881	42881	0B40				
D2832	42832	0B0F	AL8.L_L1	R/W	R/W	R/W	D2882	42882	0B41				
D2833	42833	0B10	VT1_L1	R/W	R/W	R/W	D2883	42883	0B42				
D2834	42834	0B11	VT2_L1	R/W	R/W	R/W	D2884	42884	0B43				
D2835	42835	0B12	VT3_L1	R/W	R/W	R/W	D2885	42885	0B44				
D2836	42836	0B13	VT4_L1	R/W	R/W	R/W	D2886	42886	0B45				
D2837	42837	0B14	VT5_L1	R/W	R/W	R/W	D2887	42887	0B46				
D2838	42838	0B15	VT6_L1	R/W	R/W	R/W	D2888	42888	0B47				
D2839	42839	0B16	VT7_L1	R/W	R/W	R/W	D2889	42889	0B48				
D2840	42840	0B17	VT8_L1	R/W	R/W	R/W	D2890	42890	0B49				
D2841	42841	0B18	HY1_L1	R/W	R/W	R/W	D2891	42891	0B4A				
D2842	42842	0B19	HY2_L1	R/W	R/W	R/W	D2892	42892	0B4B				
D2843	42843	0B1A	HY3_L1	R/W	R/W	R/W	D2893	42893	0B4C				
D2844	42844	0B1B	HY4_L1	R/W	R/W	R/W	D2894	42894	0B4D				
D2845	42845	0B1C	HY5_L1	R/W	R/W	R/W	D2895	42895	0B4E				
D2846	42846	0B1D	HY6_L1	R/W	R/W	R/W	D2896	42896	0B4F				
D2847	42847	0B1E	HY7_L1	R/W	R/W	R/W	D2897	42897	0B50				
D2848	42848	0B1F	HY8_L1	R/W	R/W	R/W	D2898	42898	0B51				
D2849	42849	0B20	DYN1_L1	R/W	R/W	R/W	D2899	42899	0B52				
D2850	42850	0B21	DYN2_L1	R/W	R/W	R/W	D2900	42900	0B53				

6.4 UT55A/UT52A/UP55A D Registers

Loop-1 operation parameter													
PV-related setting (Menu: PVS)													
D-Reg No.	Ref. No.	H No.	Register symbol	R/W			D-Reg No.	Ref. No.	H No.	Register symbol	R/W		
				UT 55A	UT 52A	UT 52A					UT 55A	UT 52A	UP 55A
D2901	42901	0B54	BS_L1	R/W	R/W	R/W	D2951	42951	0B86				
D2902	42902	0B55	FL_L1	R/W	R/W	R/W	D2952	42952	0B87				
D2903	42903	0B56					D2953	42953	0B88				
D2904	42904	0B57					D2954	42954	0B89				
D2905	42905	0B58					D2955	42955	0B8A				
D2906	42906	0B59					D2956	42956	0B8B				
D2907	42907	0B5A					D2957	42957	0B8C				
D2908	42908	0B5B					D2958	42958	0B8D				
D2909	42909	0B5C					D2959	42959	0B8E				
D2910	42910	0B5D					D2960	42960	0B8F				
D2911	42911	0B5E					D2961	42961	0B90				
D2912	42912	0B5F					D2962	42962	0B91				
D2913	42913	0B60					D2963	42963	0B92				
D2914	42914	0B61					D2964	42964	0B93				
D2915	42915	0B62					D2965	42965	0B94				
D2916	42916	0B63					D2966	42966	0B95				
D2917	42917	0B64					D2967	42967	0B96				
D2918	42918	0B65					D2968	42968	0B97				
D2919	42919	0B66					D2969	42969	0B98				
D2920	42920	0B67					D2970	42970	0B99				
D2921	42921	0B68					D2971	42971	0B9A				
D2922	42922	0B69					D2972	42972	0B9B				
D2923	42923	0B6A					D2973	42973	0B9C				
D2924	42924	0B6B					D2974	42974	0B9D				
D2925	42925	0B6C					D2975	42975	0B9E				
D2926	42926	0B6D					D2976	42976	0B9F				
D2927	42927	0B6E					D2977	42977	0BA0				
D2928	42928	0B6F					D2978	42978	0BA1				
D2929	42929	0B70					D2979	42979	0BA2				
D2930	42930	0B71					D2980	42980	0BA3				
D2931	42931	0B72					D2981	42981	0BA4				
D2932	42932	0B73					D2982	42982	0BA5				
D2933	42933	0B74					D2983	42983	0BA6				
D2934	42934	0B75					D2984	42984	0BA7				
D2935	42935	0B76					D2985	42985	0BA8				
D2936	42936	0B77					D2986	42986	0BA9				
D2937	42937	0B78					D2987	42987	0BAA				
D2938	42938	0B79					D2988	42988	0BAB				
D2939	42939	0B7A					D2989	42989	0BAC				
D2940	42940	0B7B					D2990	42990	0BAD				
D2941	42941	0B7C					D2991	42991	0BAE				
D2942	42942	0B7D					D2992	42992	0BAF				
D2943	42943	0B7E					D2993	42993	0BB0				
D2944	42944	0B7F					D2994	42994	0BB1				
D2945	42945	0B80					D2995	42995	0BB2				
D2946	42946	0B81					D2996	42996	0BB3				
D2947	42947	0B82					D2997	42997	0BB4				
D2948	42948	0B83					D2998	42998	0BB5				
D2949	42949	0B84					D2999	42999	0BB6				
D2950	42950	0B85					D3000	43000	0BB7				

Loop-1 operation parameter													
PID setting (Menu: PID)													
D-Reg No.	Ref. No.	H No.	Register symbol	R/W			D-Reg No.	Ref. No.	H No.	Register symbol	R/W		
				UT 55A	UT 52A	UT 52A					UT 55A	UT 52A	UP 55A
D3001	43001	0BB8	P_L1_1	R/W	R/W	R/W	D3051	43051	0BEA	P_L1_2	R/W	R/W	R/W
D3002	43002	0BB9	I_L1_1	R/W	R/W	R/W	D3052	43052	0BEB	I_L1_2	R/W	R/W	R/W
D3003	43003	0BBA	D_L1_1	R/W	R/W	R/W	D3053	43053	0BEC	D_L1_2	R/W	R/W	R/W
D3004	43004	0BBB	OH_L1_1	R/W	R/W	R/W	D3054	43054	0BED	OH_L1_2	R/W	R/W	R/W
D3005	43005	0BBC	OL_L1_1	R/W	R/W	R/W	D3055	43055	0BEE	OL_L1_2	R/W	R/W	R/W
D3006	43006	0BBD	MR_L1_1	R/W	R/W	R/W	D3056	43056	0BEF	MR_L1_2	R/W	R/W	R/W
D3007	43007	0BBE	HYS_L1_1	R/W	R/W	R/W	D3057	43057	0BF0	HYS_L1_2	R/W	R/W	R/W
D3008	43008	0BBF	SU.HY_1	R/W	R/W	/	D3058	43058	0BF1	SU.HY_2	R/W	R/W	/
D3009	43009	0BC0	HY.UP_L1_1	R/W	R/W	R/W	D3059	43059	0BF2	HY.UP_L1_2	R/W	R/W	R/W
D3010	43010	0BC1	HY.LO_L1_1	R/W	R/W	R/W	D3060	43060	0BF3	HY.LO_L1_2	R/W	R/W	R/W
D3011	43011	0BC2	DR_L1_1	R/W	R/W	R/W	D3061	43061	0BF4	DR_L1_2	R/W	R/W	R/W
D3012	43012	0BC3	SU.DR_1	R/W	R/W	/	D3062	43062	0BF5	SU.DR_2	R/W	R/W	/
D3013	43013	0BC4	Pc_L1_1	R/W	R/W	R/W	D3063	43063	0BF6	Pc_L1_2	R/W	R/W	R/W
D3014	43014	0BC5	Ic_L1_1	R/W	R/W	R/W	D3064	43064	0BF7	Ic_L1_2	R/W	R/W	R/W
D3015	43015	0BC6	Dc_L1_1	R/W	R/W	R/W	D3065	43065	0BF8	Dc_L1_2	R/W	R/W	R/W
D3016	43016	0BC7	OHc_L1_1	R/W	R/W	R/W	D3066	43066	0BF9	OHc_L1_2	R/W	R/W	R/W
D3017	43017	0BC8	OLc_L1_1	R/W	R/W	R/W	D3067	43067	0BFA	OLc_L1_2	R/W	R/W	R/W
D3018	43018	0BC9	HYSc_L1_1	R/W	R/W	R/W	D3068	43068	0BFB	HYSc_L1_2	R/W	R/W	R/W
D3019	43019	0BCA	DB_L1_1	R/W	R/W	R/W	D3069	43069	0BFC	DB_L1_2	R/W	R/W	R/W
D3020	43020	0BCB	PO_L1_1	R/W	R/W	R/W	D3070	43070	0BFD	PO_L1_2	R/W	R/W	R/W
D3021	43021	0BCC	SU.PO_1	R/W	R/W	/	D3071	43071	0BFE	SU.PO_2	R/W	R/W	/
D3022	43022	0BCD	POc_L1_1	R/W	R/W	R/W	D3072	43072	0BFF	POc_L1_2	R/W	R/W	R/W
D3023	43023	0BCE					D3073	43073	0C00				
D3024	43024	0BCF					D3074	43074	0C01				
D3025	43025	0BD0					D3075	43075	0C02				
D3026	43026	0BD1					D3076	43076	0C03				
D3027	43027	0BD2					D3077	43077	0C04				
D3028	43028	0BD3					D3078	43078	0C05				
D3029	43029	0BD4					D3079	43079	0C06				
D3030	43030	0BD5					D3080	43080	0C07				
D3031	43031	0BD6					D3081	43081	0C08				
D3032	43032	0BD7					D3082	43082	0C09				
D3033	43033	0BD8					D3083	43083	0C0A				
D3034	43034	0BD9					D3084	43084	0C0B				
D3035	43035	0BDA					D3085	43085	0C0C				
D3036	43036	0BDB					D3086	43086	0C0D				
D3037	43037	0BDC					D3087	43087	0C0E				
D3038	43038	0BDD					D3088	43088	0C0F				
D3039	43039	0BDE					D3089	43089	0C10				
D3040	43040	0BDF					D3090	43090	0C11				
D3041	43041	0BE0					D3091	43091	0C12				
D3042	43042	0BE1					D3092	43092	0C13				
D3043	43043	0BE2					D3093	43093	0C14				
D3044	43044	0BE3					D3094	43094	0C15				
D3045	43045	0BE4					D3095	43095	0C16				
D3046	43046	0BE5					D3096	43096	0C17				
D3047	43047	0BE6					D3097	43097	0C18				
D3048	43048	0BE7					D3098	43098	0C19				
D3049	43049	0BE8					D3099	43099	0C1A				
D3050	43050	0BE9					D3100	43100	0C1B				

6.4 UT55A/UT52A/UP55A D Registers

Loop-1 operation parameter													
PID setting (Menu: PID)													
D-Reg No.	Ref. No.	H No.	Register symbol	R/W			D-Reg No.	Ref. No.	H No.	Register symbol	R/W		
				UT 55A	UT 52A	UP 55A					UT 55A	UT 52A	UP 55A
D3101	43101	0C1C	P_L1_3	R/W	R/W	R/W	D3151	43151	0C4E	P_L1_4	R/W	R/W	R/W
D3102	43102	0C1D	I_L1_3	R/W	R/W	R/W	D3152	43152	0C4F	I_L1_4	R/W	R/W	R/W
D3103	43103	0C1E	D_L1_3	R/W	R/W	R/W	D3153	43153	0C50	D_L1_4	R/W	R/W	R/W
D3104	43104	0C1F	OH_L1_3	R/W	R/W	R/W	D3154	43154	0C51	OH_L1_4	R/W	R/W	R/W
D3105	43105	0C20	OL_L1_3	R/W	R/W	R/W	D3155	43155	0C52	OL_L1_4	R/W	R/W	R/W
D3106	43106	0C21	MR_L1_3	R/W	R/W	R/W	D3156	43156	0C53	MR_L1_4	R/W	R/W	R/W
D3107	43107	0C22	HYS_L1_3	R/W	R/W	R/W	D3157	43157	0C54	HYS_L1_4	R/W	R/W	R/W
D3108	43108	0C23	SU.HY_3	R/W	R/W		D3158	43158	0C55	SU.HY_4	R/W	R/W	
D3109	43109	0C24	HY.UP_L1_3	R/W	R/W	R/W	D3159	43159	0C56	HY.UP_L1_4	R/W	R/W	R/W
D3110	43110	0C25	HY.LO_L1_3	R/W	R/W	R/W	D3160	43160	0C57	HY.LO_L1_4	R/W	R/W	R/W
D3111	43111	0C26	DR_L1_3	R/W	R/W	R/W	D3161	43161	0C58	DR_L1_4	R/W	R/W	R/W
D3112	43112	0C27	SU.DR_3	R/W	R/W		D3162	43162	0C59	SU.DR_4	R/W	R/W	
D3113	43113	0C28	Pc_L1_3	R/W	R/W	R/W	D3163	43163	0C5A	Pc_L1_4	R/W	R/W	R/W
D3114	43114	0C29	Ic_L1_3	R/W	R/W	R/W	D3164	43164	0C5B	Ic_L1_4	R/W	R/W	R/W
D3115	43115	0C2A	Dc_L1_3	R/W	R/W	R/W	D3165	43165	0C5C	Dc_L1_4	R/W	R/W	R/W
D3116	43116	0C2B	OHc_L1_3	R/W	R/W	R/W	D3166	43166	0C5D	OHc_L1_4	R/W	R/W	R/W
D3117	43117	0C2C	OLc_L1_3	R/W	R/W	R/W	D3167	43167	0C5E	OLc_L1_4	R/W	R/W	R/W
D3118	43118	0C2D	HYSc_L1_3	R/W	R/W	R/W	D3168	43168	0C5F	HYSc_L1_4	R/W	R/W	R/W
D3119	43119	0C2E	DB_L1_3	R/W	R/W	R/W	D3169	43169	0C60	DB_L1_4	R/W	R/W	R/W
D3120	43120	0C2F	PO_L1_3	R/W	R/W	R/W	D3170	43170	0C61	PO_L1_4	R/W	R/W	R/W
D3121	43121	0C30	SU.PO_3	R/W	R/W		D3171	43171	0C62	SU.PO_4	R/W	R/W	
D3122	43122	0C31	POc_L1_3	R/W	R/W	R/W	D3172	43172	0C63	POc_L1_4	R/W	R/W	R/W
D3123	43123	0C32					D3173	43173	0C64				
D3124	43124	0C33					D3174	43174	0C65				
D3125	43125	0C34					D3175	43175	0C66				
D3126	43126	0C35					D3176	43176	0C67				
D3127	43127	0C36					D3177	43177	0C68				
D3128	43128	0C37					D3178	43178	0C69				
D3129	43129	0C38					D3179	43179	0C6A				
D3130	43130	0C39					D3180	43180	0C6B				
D3131	43131	0C3A					D3181	43181	0C6C				
D3132	43132	0C3B					D3182	43182	0C6D				
D3133	43133	0C3C					D3183	43183	0C6E				
D3134	43134	0C3D					D3184	43184	0C6F				
D3135	43135	0C3E					D3185	43185	0C70				
D3136	43136	0C3F					D3186	43186	0C71				
D3137	43137	0C40					D3187	43187	0C72				
D3138	43138	0C41					D3188	43188	0C73				
D3139	43139	0C42					D3189	43189	0C74				
D3140	43140	0C43					D3190	43190	0C75				
D3141	43141	0C44					D3191	43191	0C76				
D3142	43142	0C45					D3192	43192	0C77				
D3143	43143	0C46					D3193	43193	0C78				
D3144	43144	0C47					D3194	43194	0C79				
D3145	43145	0C48					D3195	43195	0C7A				
D3146	43146	0C49					D3196	43196	0C7B				
D3147	43147	0C4A					D3197	43197	0C7C				
D3148	43148	0C4B					D3198	43198	0C7D				
D3149	43149	0C4C					D3199	43199	0C7E				
D3150	43150	0C4D					D3200	43200	0C7F				

Loop-1 operation parameter													
PID setting (Menu: PID)													
D-Reg No.	Ref. No.	H No.	Register symbol	R/W			D-Reg No.	Ref. No.	H No.	Register symbol	R/W		
				UT 55A	UT 52A	UP 55A					UT 55A	UT 52A	UP 55A
D3201	43201	0C80	P_L1_5	R/W	R/W	R/W	D3251	43251	0CB2	P_L1_6	R/W	R/W	R/W
D3202	43202	0C81	I_L1_5	R/W	R/W	R/W	D3252	43252	0CB3	I_L1_6	R/W	R/W	R/W
D3203	43203	0C82	D_L1_5	R/W	R/W	R/W	D3253	43253	0CB4	D_L1_6	R/W	R/W	R/W
D3204	43204	0C83	OH_L1_5	R/W	R/W	R/W	D3254	43254	0CB5	OH_L1_6	R/W	R/W	R/W
D3205	43205	0C84	OL_L1_5	R/W	R/W	R/W	D3255	43255	0CB6	OL_L1_6	R/W	R/W	R/W
D3206	43206	0C85	MR_L1_5	R/W	R/W	R/W	D3256	43256	0CB7	MR_L1_6	R/W	R/W	R/W
D3207	43207	0C86	HYS_L1_5	R/W	R/W	R/W	D3257	43257	0CB8	HYS_L1_6	R/W	R/W	R/W
D3208	43208	0C87	SU.HY_5	R/W	R/W	/	D3258	43258	0CB9	SU.HY_6	R/W	R/W	/
D3209	43209	0C88	HY.UP_L1_5	R/W	R/W	R/W	D3259	43259	0CBA	HY.UP_L1_6	R/W	R/W	R/W
D3210	43210	0C89	HY.LO_L1_5	R/W	R/W	R/W	D3260	43260	0CBB	HY.LO_L1_6	R/W	R/W	R/W
D3211	43211	0C8A	DR_L1_5	R/W	R/W	R/W	D3261	43261	0CBC	DR_L1_6	R/W	R/W	R/W
D3212	43212	0C8B	SU.DR_5	R/W	R/W	/	D3262	43262	0CBD	SU.DR_6	R/W	R/W	/
D3213	43213	0C8C	Pc_L1_5	R/W	R/W	R/W	D3263	43263	0CBE	Pc_L1_6	R/W	R/W	R/W
D3214	43214	0C8D	Ic_L1_5	R/W	R/W	R/W	D3264	43264	0CBF	Ic_L1_6	R/W	R/W	R/W
D3215	43215	0C8E	Dc_L1_5	R/W	R/W	R/W	D3265	43265	0CC0	Dc_L1_6	R/W	R/W	R/W
D3216	43216	0C8F	OHc_L1_5	R/W	R/W	R/W	D3266	43266	0CC1	OHc_L1_6	R/W	R/W	R/W
D3217	43217	0C90	OLc_L1_5	R/W	R/W	R/W	D3267	43267	0CC2	OLc_L1_6	R/W	R/W	R/W
D3218	43218	0C91	HYSc_L1_5	R/W	R/W	R/W	D3268	43268	0CC3	HYSc_L1_6	R/W	R/W	R/W
D3219	43219	0C92	DB_L1_5	R/W	R/W	R/W	D3269	43269	0CC4	DB_L1_6	R/W	R/W	R/W
D3220	43220	0C93	PO_L1_5	R/W	R/W	R/W	D3270	43270	0CC5	PO_L1_6	R/W	R/W	R/W
D3221	43221	0C94	SU.PO_5	R/W	R/W	/	D3271	43271	0CC6	SU.PO_6	R/W	R/W	/
D3222	43222	0C95	POc_L1_5	R/W	R/W	R/W	D3272	43272	0CC7	POc_L1_6	R/W	R/W	R/W
D3223	43223	0C96					D3273	43273	0CC8				
D3224	43224	0C97					D3274	43274	0CC9				
D3225	43225	0C98					D3275	43275	0CCA				
D3226	43226	0C99					D3276	43276	0CCB				
D3227	43227	0C9A					D3277	43277	0CCC				
D3228	43228	0C9B					D3278	43278	0CCD				
D3229	43229	0C9C					D3279	43279	0CCE				
D3230	43230	0C9D					D3280	43280	0CCF				
D3231	43231	0C9E					D3281	43281	0CD0				
D3232	43232	0C9F					D3282	43282	0CD1				
D3233	43233	0CA0					D3283	43283	0CD2				
D3234	43234	0CA1					D3284	43284	0CD3				
D3235	43235	0CA2					D3285	43285	0CD4				
D3236	43236	0CA3					D3286	43286	0CD5				
D3237	43237	0CA4					D3287	43287	0CD6				
D3238	43238	0CA5					D3288	43288	0CD7				
D3239	43239	0CA6					D3289	43289	0CD8				
D3240	43240	0CA7					D3290	43290	0CD9				
D3241	43241	0CA8					D3291	43291	0CDA				
D3242	43242	0CA9					D3292	43292	0CDB				
D3243	43243	0CAA					D3293	43293	0CDC				
D3244	43244	0CAB					D3294	43294	0CDD				
D3245	43245	0CAC					D3295	43295	0CDE				
D3246	43246	0CAD					D3296	43296	0CDF				
D3247	43247	0CAE					D3297	43297	0CE0				
D3248	43248	0CAF					D3298	43298	0CE1				
D3249	43249	0CB0					D3299	43299	0CE2				
D3250	43250	0CB1					D3300	43300	0CE3				

6.4 UT55A/UT52A/UP55A D Registers

Loop-1 operation parameter													
PID setting (Menu: PID)													
D-Reg No.	Ref. No.	H No.	Register symbol	R/W			D-Reg No.	Ref. No.	H No.	Register symbol	R/W		
				UT 55A	UT 52A	UP 55A					UT 55A	UT 52A	UP 55A
D3301	43301	0CE4	P_L1_7	R/W	R/W	R/W	D3351	43351	0D16	P_L1_8	R/W	R/W	R/W
D3302	43302	0CE5	I_L1_7	R/W	R/W	R/W	D3352	43352	0D17	I_L1_8	R/W	R/W	R/W
D3303	43303	0CE6	D_L1_7	R/W	R/W	R/W	D3353	43353	0D18	D_L1_8	R/W	R/W	R/W
D3304	43304	0CE7	OH_L1_7	R/W	R/W	R/W	D3354	43354	0D19	OH_L1_8	R/W	R/W	R/W
D3305	43305	0CE8	OL_L1_7	R/W	R/W	R/W	D3355	43355	0D1A	OL_L1_8	R/W	R/W	R/W
D3306	43306	0CE9	MR_L1_7	R/W	R/W	R/W	D3356	43356	0D1B	MR_L1_8	R/W	R/W	R/W
D3307	43307	0CEA	HYS_L1_7	R/W	R/W	R/W	D3357	43357	0D1C	HYS_L1_8	R/W	R/W	R/W
D3308	43308	0CEB	SU.HY_7	R/W	R/W		D3358	43358	0D1D	SU.HY_8	R/W	R/W	
D3309	43309	0CEC	HY.UP_L1_7	R/W	R/W	R/W	D3359	43359	0D1E	HY.UP_L1_8	R/W	R/W	R/W
D3310	43310	0CED	HY.LO_L1_7	R/W	R/W	R/W	D3360	43360	0D1F	HY.LO_L1_8	R/W	R/W	R/W
D3311	43311	0CEE	DR_L1_7	R/W	R/W	R/W	D3361	43361	0D20	DR_L1_8	R/W	R/W	R/W
D3312	43312	0CEF	SU.DR_7	R/W	R/W		D3362	43362	0D21	SU.DR_8	R/W	R/W	
D3313	43313	0CF0	Pc_L1_7	R/W	R/W	R/W	D3363	43363	0D22	Pc_L1_8	R/W	R/W	R/W
D3314	43314	0CF1	Ic_L1_7	R/W	R/W	R/W	D3364	43364	0D23	Ic_L1_8	R/W	R/W	R/W
D3315	43315	0CF2	Dc_L1_7	R/W	R/W	R/W	D3365	43365	0D24	Dc_L1_8	R/W	R/W	R/W
D3316	43316	0CF3	OHc_L1_7	R/W	R/W	R/W	D3366	43366	0D25	OHc_L1_8	R/W	R/W	R/W
D3317	43317	0CF4	OLc_L1_7	R/W	R/W	R/W	D3367	43367	0D26	OLc_L1_8	R/W	R/W	R/W
D3318	43318	0CF5	HYSc_L1_7	R/W	R/W	R/W	D3368	43368	0D27	HYSc_L1_8	R/W	R/W	R/W
D3319	43319	0CF6	DB_L1_7	R/W	R/W	R/W	D3369	43369	0D28	DB_L1_8	R/W	R/W	R/W
D3320	43320	0CF7	PO_L1_7	R/W	R/W	R/W	D3370	43370	0D29	PO_L1_8	R/W	R/W	R/W
D3321	43321	0CF8	SU.PO_7	R/W	R/W		D3371	43371	0D2A	SU.PO_8	R/W	R/W	
D3322	43322	0CF9	POc_L1_7	R/W	R/W	R/W	D3372	43372	0D2B	POc_L1_8	R/W	R/W	R/W
D3323	43323	0CFA					D3373	43373	0D2C				
D3324	43324	0CFB					D3374	43374	0D2D				
D3325	43325	0CFC					D3375	43375	0D2E				
D3326	43326	0CFD					D3376	43376	0D2F				
D3327	43327	0CFE					D3377	43377	0D30				
D3328	43328	0CFF					D3378	43378	0D31				
D3329	43329	0D00					D3379	43379	0D32				
D3330	43330	0D01					D3380	43380	0D33				
D3331	43331	0D02					D3381	43381	0D34				
D3332	43332	0D03					D3382	43382	0D35				
D3333	43333	0D04					D3383	43383	0D36				
D3334	43334	0D05					D3384	43384	0D37				
D3335	43335	0D06					D3385	43385	0D38				
D3336	43336	0D07					D3386	43386	0D39				
D3337	43337	0D08					D3387	43387	0D3A				
D3338	43338	0D09					D3388	43388	0D3B				
D3339	43339	0D0A					D3389	43389	0D3C				
D3340	43340	0D0B					D3390	43390	0D3D				
D3341	43341	0D0C					D3391	43391	0D3E				
D3342	43342	0D0D					D3392	43392	0D3F				
D3343	43343	0D0E					D3393	43393	0D40				
D3344	43344	0D0F					D3394	43394	0D41				
D3345	43345	0D10					D3395	43395	0D42				
D3346	43346	0D11					D3396	43396	0D43				
D3347	43347	0D12					D3397	43397	0D44				
D3348	43348	0D13					D3398	43398	0D45				
D3349	43349	0D14					D3399	43399	0D46				
D3350	43350	0D15					D3400	43400	0D47				

Loop-1 operation parameter													
PID setting (Menu: PID)													
D-Reg No.	Ref. No.	H No.	Register symbol	R/W			D-Reg No.	Ref. No.	H No.	Register symbol	R/W		
				UT 55A	UT 52A	UP 55A					UT 55A	UT 52A	UP 55A
D3401	43401	0D48	P_L1_R	R/W	R/W	R/W	D3451	43451	0D7A				
D3402	43402	0D49	I_L1_R	R/W	R/W	R/W	D3452	43452	0D7B				
D3403	43403	0D4A	D_L1_R	R/W	R/W	R/W	D3453	43453	0D7C				
D3404	43404	0D4B	OH_L1_R	R/W	R/W	R/W	D3454	43454	0D7D				
D3405	43405	0D4C	OL_L1_R	R/W	R/W	R/W	D3455	43455	0D7E				
D3406	43406	0D4D	MR_L1_R	R/W	R/W	R/W	D3456	43456	0D7F				
D3407	43407	0D4E	HYS_L1_R	R/W	R/W	R/W	D3457	43457	0D80				
D3408	43408	0D4F	SU.HY_R	R/W	R/W		D3458	43458	0D81				
D3409	43409	0D50	HY.UP_L1_R	R/W	R/W	R/W	D3459	43459	0D82				
D3410	43410	0D51	HY.LO_L1_R	R/W	R/W	R/W	D3460	43460	0D83				
D3411	43411	0D52	DR_L1_R	R/W	R/W	R/W	D3461	43461	0D84				
D3412	43412	0D53	SU.DR_R	R/W	R/W		D3462	43462	0D85				
D3413	43413	0D54	Pc_L1_R	R/W	R/W	R/W	D3463	43463	0D86				
D3414	43414	0D55	Ic_L1_R	R/W	R/W	R/W	D3464	43464	0D87				
D3415	43415	0D56	Dc_L1_R	R/W	R/W	R/W	D3465	43465	0D88				
D3416	43416	0D57	OHc_L1_R	R/W	R/W	R/W	D3466	43466	0D89				
D3417	43417	0D58	OLc_L1_R	R/W	R/W	R/W	D3467	43467	0D8A				
D3418	43418	0D59	HYSc_L1_R	R/W	R/W	R/W	D3468	43468	0D8B				
D3419	43419	0D5A	DB_L1_R	R/W	R/W	R/W	D3469	43469	0D8C				
D3420	43420	0D5B	PO_L1_R	R/W	R/W	R/W	D3470	43470	0D8D				
D3421	43421	0D5C	SU.PO_R	R/W	R/W		D3471	43471	0D8E				
D3422	43422	0D5D	POc_L1_R	R/W	R/W	R/W	D3472	43472	0D8F				
D3423	43423	0D5E					D3473	43473	0D90				
D3424	43424	0D5F					D3474	43474	0D91				
D3425	43425	0D60					D3475	43475	0D92				
D3426	43426	0D61					D3476	43476	0D93				
D3427	43427	0D62					D3477	43477	0D94				
D3428	43428	0D63					D3478	43478	0D95				
D3429	43429	0D64					D3479	43479	0D96				
D3430	43430	0D65					D3480	43480	0D97				
D3431	43431	0D66					D3481	43481	0D98				
D3432	43432	0D67					D3482	43482	0D99				
D3433	43433	0D68					D3483	43483	0D9A				
D3434	43434	0D69					D3484	43484	0D9B				
D3435	43435	0D6A					D3485	43485	0D9C				
D3436	43436	0D6B					D3486	43486	0D9D				
D3437	43437	0D6C					D3487	43487	0D9E				
D3438	43438	0D6D					D3488	43488	0D9F				
D3439	43439	0D6E					D3489	43489	0DA0				
D3440	43440	0D6F					D3490	43490	0DA1				
D3441	43441	0D70					D3491	43491	0DA2				
D3442	43442	0D71					D3492	43492	0DA3				
D3443	43443	0D72					D3493	43493	0DA4				
D3444	43444	0D73					D3494	43494	0DA5				
D3445	43445	0D74					D3495	43495	0DA6				
D3446	43446	0D75					D3496	43496	0DA7				
D3447	43447	0D76					D3497	43497	0DA8				
D3448	43448	0D77					D3498	43498	0DA9				
D3449	43449	0D78					D3499	43499	0DAA				
D3450	43450	0D79					D3500	43500	0DAB				

6.4 UT55A/UT52A/UP55A D Registers

Loop-1 operation parameter													
Control action-related setting (Tuning menu: TUNE) (Zone control menu: ZONE)													
D-Reg No.	Ref. No.	H No.	Register symbol	R/W			D-Reg No.	Ref. No.	H No.	Register symbol	R/W		
				UT 55A	UT 52A	UP 55A					UT 55A	UT 52A	UP 55A
D3501	43501	0DAC	SC_L1	R/W	R/W	R/W	D3551	43551	0DDE	RP1_L1	R/W	R/W	R/W
D3502	43502	0DAD					D3552	43552	0DDF	RP2_L1	R/W	R/W	R/W
D3503	43503	0DAE	AT.TY_L1	R/W	R/W	R/W	D3553	43553	0DE0	RP3_L1	R/W	R/W	R/W
D3504	43504	0DAF	AT.OH_L1	R/W	R/W	R/W	D3554	43554	0DE1	RP4_L1	R/W	R/W	R/W
D3505	43505	0DB0	AT.OL_L1	R/W	R/W	R/W	D3555	43555	0DE2	RP5_L1	R/W	R/W	R/W
D3506	43506	0DB1	AT.BS_L1	R/W	R/W	R/W	D3556	43556	0DE3	RP6_L1	R/W	R/W	R/W
D3507	43507	0DB2					D3557	43557	0DE4	RP7_L1	R/W	R/W	R/W
D3508	43508	0DB3					D3558	43558	0DE5	RHY_L1	R/W	R/W	R/W
D3509	43509	0DB4					D3559	43559	0DE6	RDV_L1	R/W	R/W	R/W
D3510	43510	0DB5					D3560	43560	0DE7				
D3511	43511	0DB6	STM	R/W	R/W	/	D3561	43561	0DE8				
D3512	43512	0DB7	SWD	R/W	R/W	/	D3562	43562	0DE9				
D3513	43513	0DB8	GW_L1	R/W	R/W	R/W	D3563	43563	0DEA				
D3514	43514	0DB9	GG_L1	R/W	R/W	R/W	D3564	43564	0DEB				
D3515	43515	0DBA					D3565	43565	0DEC				
D3516	43516	0DBB					D3566	43566	0DED				
D3517	43517	0DBC	BD	R/W	R/W	/	D3567	43567	0DEE				
D3518	43518	0DBD	BB	R/W	R/W	/	D3568	43568	0DEF				
D3519	43519	0DBE	BL	R/W	R/W	/	D3569	43569	0DF0				
D3520	43520	0DBF					D3570	43570	0DF1				
D3521	43521	0DC0	FLG	R/W	R/W	/	D3571	43571	0DF2				
D3522	43522	0DC1	FGN	R/W	R/W	/	D3572	43572	0DF3				
D3523	43523	0DC2	FBI	R/W	R/W	/	D3573	43573	0DF4				
D3524	43524	0DC3	FBO	R/W	R/W	/	D3574	43574	0DF5				
D3525	43525	0DC4					D3575	43575	0DF6				
D3526	43526	0DC5	AR_L1	R/W	R/W	R/W	D3576	43576	0DF7				
D3527	43527	0DC6	OPR_L1	R/W	R/W	R/W	D3577	43577	0DF8				
D3528	43528	0DC7	OLMT_L1	R/W	R/W	R/W	D3578	43578	0DF9				
D3529	43529	0DC8					D3579	43579	0DFA				
D3530	43530	0DC9					D3580	43580	0DFB				
D3531	43531	0DCA	MPON_L1	R/W	R/W	R/W	D3581	43581	0DFC				
D3532	43532	0DCB	MPO1_L1	R/W	R/W	R/W	D3582	43582	0DFD				
D3533	43533	0DCC	MPO2_L1	R/W	R/W	R/W	D3583	43583	0DFE				
D3534	43534	0DCD	MPO3_L1	R/W	R/W	R/W	D3584	43584	0DFF				
D3535	43535	0DCE	MPO4_L1	R/W	R/W	R/W	D3585	43585	0E00				
D3536	43536	0DCF	MPO5_L1	R/W	R/W	R/W	D3586	43586	0E01				
D3537	43537	0DD0					D3587	43587	0E02				
D3538	43538	0DD1					D3588	43588	0E03				
D3539	43539	0DD2					D3589	43589	0E04				
D3540	43540	0DD3					D3590	43590	0E05				
D3541	43541	0DD4					D3591	43591	0E06				
D3542	43542	0DD5					D3592	43592	0E07				
D3543	43543	0DD6					D3593	43593	0E08				
D3544	43544	0DD7					D3594	43594	0E09				
D3545	43545	0DD8					D3595	43595	0E0A				
D3546	43546	0DD9					D3596	43596	0E0B				
D3547	43547	0DDA					D3597	43597	0E0C				
D3548	43548	0DDB					D3598	43598	0E0D				
D3549	43549	0DDC					D3599	43599	0E0E				
D3550	43550	0DDD					D3600	43600	0E0F				

Loop-1 SP and Alarm Setpoint Setting of Groups 1 to 8 (D2501 to D2700)

Register No.	Description		Range and meaning of value
D2501	SP_L1_1	Target setpoint of group 1	0.0 to 100.0% of PV input range (EU) (Setting range: SPL to SPH)
D2502	SUB_1	Sub-target setpoint (in Two-position two-level control) of group 1	Set the offset from SP. -100.0 to 100.0% of PV input range span (EUS)
D2503	PIDN_L1_1	PID number selection of group 1	Set a PID group number to use. 1 to 8 (Depends on the PIDG. setting.)
D2504	A1_L1_1	Alarm-1 setpoint of group 1	Set a display value of setpoint of PV alarm, SP alarm, deviation alarm, output alarm, or velocity alarm. -19999 to 30000 (Set a value within the input range.) Decimal point position depends on the input type.
D2505	A2_L1_1	Alarm-2 setpoint of group 1	
D2506	A3_L1_1	Alarm-3 setpoint of group 1	
D2507	A4_L1_1	Alarm-4 setpoint of group 1	
D2508	A5_L1_1	Alarm-5 setpoint of group 1	
D2509	A6_L1_1	Alarm-6 setpoint of group 1	
D2510	A7_L1_1	Alarm-7 setpoint of group 1	
D2511	A8_L1_1	Alarm-8 setpoint of group 1	
D2512 to D2520			
D2521 to D2531	SP_L1_2 to A8_L1_2	Target setpoint of group 2 to Alarm-8 setpoint of group 2	Same as 2501 to D2511
D2542 to D2540			
D2541 to D2551	SP_L1_3 to A8_L1_3	Target setpoint of group 3 to Alarm-8 setpoint of group 3	Same as D2501 to D2511
D2552 to D2560			
D2561 to D2571	SP_L1_4 to A8_L1_4	Target setpoint of group 4 to Alarm-8 setpoint of group 4	Same as D2501 to D2511
D2572 to D2580			
D2581 to D2591	SP_L1_5 to A8_L1_5	Target setpoint of group 5 to Alarm-8 setpoint of group 5	Same as D2501 to D2511
D2593 to D2600			
D2601 to D2611	SP_L1_6 to A8_L1_6	Target setpoint of group 6 to Alarm-8 setpoint of group 6	Same as D2501 to D2511
D2612 to D2620			
D2621 to D2631	SP_L1_7 to A8_L1_7	Target setpoint of group 7 to Alarm-8 setpoint of group 7	Same as D2501 to D2511
D2632 to D2640			
D2641 to D2651	SP_L1_8 to A8_L1_8	Target setpoint of group 8 to Alarm-8 setpoint of group 8	Same as D2501 to D2511
D2652 to D2700			

6.4 UT55A/UT52A/UP55A D Registers

Loop-1 SP-related Setting (D2701 to D2800)

Register No.		Description	Range and meaning of value
D2701	RMS_L1	Remote input method	0: RSP (Via remote (aux. analog) input) 1: COM (Via communication) RSP is not displayed if the remote (auxiliary analog) input is not specified. COM is not displayed if the communication function is not specified. When neither the remote (auxiliary analog) input nor communication function is specified, this parameter is not displayed.
D2702	RFL_L1	Remote input filter	0: OFF (Disable) 1 to 120 s
D2703	RT_L1	Remote input ratio	SP = Remote input x RT + Remote input bias 0.001 to 9.999
D2704	RBS_L1	Remote input bias	-100.0 to 100.0% of PV input range span (EUS)
D2705	UPR_L1	SP ramp-up rate	Used to prevent SP from changing suddenly. Set a ramp-up rate or ramp-down rate per hour or minute. Set a time unit using the parameter TMU.
D2706	DNR_L1	SP ramp-down rate	0: OFF (Disable) 0.0 + 1 digit to 100.0% of PV input range span (EUS)
D2707	TMU_L1	SP ramp-rate time unit	0: HOUR (Ramp-up rate or ramp-down rate per hour) 1: MIN (Ramp-up rate or ramp-down rate per minute)
D2708 to D2709			
D2710	SPT_L1	SP tracking selection	Tracking is performed when the mode changes from Remote to Local. (The local setpoint keeps track of the remote setpoint.) 0: OFF (Disable) 1: ON (Enable)
D2711	PVT_L1	PV tracking selection	Causes the setpoint to keep track of the PV so the setpoint automatically reverts to its original value at a preset rate of change. The UPR, DNR, and TMU are used in combination. Operating conditions: 1) MAN → AUTO, 2) STOP → AUTO, 3) Power-on, 4) SP number change, 5) SP change 0: OFF (Disable) 1: ON (Enable)
D2712	S.TM	Starting time of program operation	0 to 59999 (minute or second) * Use the parameter TMU to set the time unit.
D2713	PNC	Program pattern number clearance	0: OFF (Not cleared) 1: ON (Cleared. (Set the program No.) before restart program operation) * The controller resets (clears) the program pattern number on the operating display to "0" at the end of program operation.
D2714 to D2800			

Loop-1 Alarm Function Setting (D2801 to D2900)

Register No.	Description	Range and meaning of value
D2801	AL1.T_L1	AL1.T_L1 to AL8.T_L1 0: Disable 1: PV high limit 2: PV low limit 3: SP high limit 4: SP low limit 5: Deviation high limit 6: Deviation low limit 7: Deviation high and low limits 8: Deviation within high and low limits 9: Target SP high limit 10: Target SP low limit 11: Target SP deviation high limit 12: Target SP deviation low limit 13: Target SP deviation high and low limits 14: Target SP deviation within high and low limits 15: OUT high limit 16: OUT low limit 17: Cooling-side OUT high limit 18: Cooling-side OUT low limit 19: Analog input PV high limit 20: Analog input PV low limit 21: Analog input RSP high limit 22: Analog input RSP low limit 23: Analog input AIN2 high limit 24: Analog input AIN2 low limit 25: Analog input AIN4 high limit 26: Analog input AIN4 low limit 27: Feedback input high limit 28: Feedback input low limit 29: PV velocity 30: Fault diagnosis 31: FAIL
D2802	AL1.W_L1	
D2803	AL1.D_L1	
D2804	AL1.L_L1	
D2805	AL2.T_L1	
D2806	AL2.W_L1	
D2807	AL2.D_L1	
D2808	AL2.L_L1	
D2809	AL3.T_L1	
D2810	AL3.W_L1	
D2811	AL3.D_L1	
D2812	AL3.L_L1	
D2813	AL4.T_L1	
D2814	AL4.W_L1	
D2815	AL4.D_L1	
D2816	AL4.L_L1	
D2817	AL5.T_L1	
D2818	AL5.W_L1	
D2819	AL5.D_L1	
D2820	AL5.L_L1	
D2821	AL6.T_L1	
D2822	AL6.W_L1	AL1.W_L1 to AL8.W_L1 0: Without Stand-by action 1: With Stand-by action
D2823	AL6.D_L1	
D2824	AL6.L_L1	AL1.D_L1 to AL8.D_L1 0: Alarm output: Energized 1: Alarm output: De-energized
D2825	AL7.T_L1	
D2826	AL7.W_L1	AL1.L_L1 to AL8.L_L1 0: OFF 1: Latch 1 2: Latch 2 3: Latch 3 4: Latch 4
D2827	AL7.D_L1	
D2828	AL7.L_L1	
D2829	AL8.T_L1	When the UTAdvanced parameter is set by key stroke, the alarm type, stand-by action, energized/de-energized, and latch comprise one parameter. 1 to 5999 (second)
D2830	AL8.W_L1	
D2831	AL8.D_L1	
D2832	AL8.L_L1	
D2833	VT1_L1	
D2834	VT2_L1	
D2835	VT3_L1	
D2836	VT4_L1	
D2837	VT5_L1	
D2838	VT6_L1	
D2839	VT7_L1	
D2840	VT8_L1	

6.4 UT55A/UT52A/UP55A D Registers

Register No.	Description	Range and meaning of value
D2841	HY1_L1	Alarm-1 hysteresis
D2842	HY2_L1	Alarm-2 hysteresis
D2843	HY3_L1	Alarm-3 hysteresis
D2844	HY4_L1	Alarm-4 hysteresis
D2845	HY5_L1	Alarm-5 hysteresis
D2846	HY6_L1	Alarm-6 hysteresis
D2847	HY7_L1	Alarm-7 hysteresis
D2848	HY8_L1	Alarm-8 hysteresis
D2849	DYN1_L1	Alarm-1 On-delay timer
D2850	DYN2_L1	Alarm-2 On-delay timer
D2851	DYN3_L1	Alarm-3 On-delay timer
D2852	DYN4_L1	Alarm-4 On-delay timer
D2853	DYN5_L1	Alarm-5 On-delay timer
D2854	DYN6_L1	Alarm-6 On-delay timer
D2855	DYN7_L1	Alarm-7 On-delay timer
D2856	DYN8_L1	Alarm-8 On-delay timer
D2857	DYF1_L1	Alarm-1 Off-delay timer
D2858	DYF2_L1	Alarm-2 Off-delay timer
D2859	DYF3_L1	Alarm-3 Off-delay timer
D2860	DYF4_L1	Alarm-4 Off-delay timer
D2861	DYF5_L1	Alarm-5 Off-delay timer
D2862	DYF6_L1	Alarm-6 Off-delay timer
D2863	DYF7_L1	Alarm-7 Off-delay timer
D2864	DYF8_L1	Alarm-8 Off-delay timer
D2865		
D2866	AMD_L1	Alarm mode
D2871	EHY1	Event-1 hysteresis
D2872	EHY2	Event-2 hysteresis
D2873	EHY3	Event-3 hysteresis
D2874	EHY4	Event-4 hysteresis
D2875	EHY5	Event-5 hysteresis
D2876	EHY6	Event-6 hysteresis
D2877	EHY7	Event-7 hysteresis
D2878	EHY8	Event-8 hysteresis
D2879 to D2900		

Set a display value of setpoint of hysteresis.
-19999 to 30000 (Set a value within the input range.)
Decimal point position depends on the input type.

An alarm output is ON when the delay timer expires after the alarm setpoint is reached.
0 to 5999 (second)

An alarm output is OFF when the delay timer expires after the alarm setpoint is reached.
0 to 5999 (second)

UT55A/UT52A
0: Always active
1: Not active in STOP mode
2: Not active in STOP or MAN mode

UP55A
0: Always active
1: Not active in RESET mode
2: Not active in RESET or MAN mode

The hysteresis setpoint of PV event or Local event is set to the percentage of 0.0 to 100.0%.
The setting value (%) is for the PV input range span or output span.

Loop-1 PV-related Setting (D2901 to D3000)

Register No.	Description	Range and meaning of value
D2901	BS_L1	PV input bias
D2902	FL_L1	PV input filter
D2903 to D2900		

-100.0 to 100.0% of PV input range span (EUS)

0: OFF (Disable)
1 to 120 s

Loop-1 PID Setting of Groups 1 to 8 and R (D3001 to D3500)

Register No.		Description	Range and meaning of value
D3001	P_L1_1	Proportional band of group 1 Heating-side proportional band (in Heating/cooling control) of group 1	0.0 to 999.9% When 0.0% is set, it operates as 0.1%. Heating-side ON/OFF control applies when 0.0% in Heating/cooling control
D3002	I_L1_1	Integral time of group 1 Heating-side integral time (in Heating/cooling control) of group 1	0: OFF (Disable) 1 to 6000 s
D3003	D_L1_1	Derivative time of group 1 Heating-side derivative time (in Heating/cooling control) of group 1	0: OFF (Disable) 1 to 6000 s
D3004	OH_L1_1	Control output high limit of group 1 Heating-side control output high limit (in Heating/cooling control) of group 1	-4.9 to 105.0%, (OL<OH) In Heating/cooling control: 0.1 to 105.0% (OL<OH)
D3005	OL_L1_1	Control output low limit of group 1 Heating-side control output low limit (in Heating/cooling control) of group 1	-5.0 to 104.9%, (OL<OH), SD: Tight shut In Heating/cooling control: 0.0 to 104.9% (OL<OH)
D3006	MR_L1_1	Manual reset of group 1	Enabled when integral time is OFF. The manual reset value equals the output value when PV = SP. -5.0 to 105.0%
D3007	HYS_L1_1	Hysteresis (in ON/OFF control, Position proportional control, or Two-position two-level control) Heating-side ON/OFF control hysteresis (in Heating/cooling control)	In ON/OFF control or Two-position two-level control: 0.0 to 100.0% of PV input range span (EUS) In Heating/cooling control or Position proportional control: 0.0 to 100.0%
D3008	SU.HY_1	Sub-hysteresis (in Two-position two-level control) of group 1	0.0 to 100.0% of PV input range span (EUS)
D3009	HY.UP_L1_1	Upper-side hysteresis (in ON/OFF control) of group 1	0.0 to 100.0% of PV input range span (EUS)
D3010	HY.LO_L1_1	Lower-side hysteresis (in ON/OFF control) of group 1	
D3011	DR_L1_1	Direct/reverse action switch of group 1	0: RVS: Reverse action 1: DIR: Direct action
D3012	SU.DR_1	Sub-direct/reverse action switch (in Two-position two-level control) of group 1	
D3013	Pc_L1_1	Cooling-side proportional band of group 1	0.0 to 999.9% (Cooling-side ON/OFF control applies when 0.0% in Heating/cooling control)
D3014	Ic_L1_1	Cooling-side integral time of group 1	0: OFF (Disable) 1 to 6000 s
D3015	Dc_L1_1	Cooling-side derivative time of group 1	0: OFF (Disable) 1 to 6000 s
D3016	OHc_L1_1	Cooling-side control output high limit of group 1	0.1 to 105.0%, (OLc<OHc)
D3017	OLc_L1_1	Cooling-side control output low limit of group 1	0.0 to 104.9%, (OLc<OHc)
D3018	HYSc_L1_1	Cooling-side ON/OFF control hysteresis of group 1	0.0 to 100.0%
D3019	DB_L1_1	Output dead band (in Heating/cooling control or Position proportional control)	In Heating/cooling control: -100.0 to 50.0% In Position proportional control: 1.0 to 10.0%
D3020	PO_L1_1	Preset output of group 1 Heating-side preset output (in Heating/cooling control) of group 1	In STOP mode, fixed control output can be generated. In Position proportional control, Valve opening can be set -5.0 to 105.0%
D3021	SU.PO_1	Sub-preset output (in Two-position two-level control) of group 1	In STOP mode, fixed sub-control output can be generated. 0%, 100%
D3022	POc_L1_1	Cooling-side preset output of group 1	In STOP mode, cooling-side fixed control output can be generated. -5.0 to 105.0%
D3023 to D3050			

6.4 UT55A/UT52A/UP55A D Registers

Register No.	Description	Range and meaning of value
D3051 to D3072	P_L1_2 to POc_L1_2 Proportional band of group 2 Heating-side proportional band (in Heating/cooling control) of group 2 to Cooling-side preset output of group 2	Same as D3001 to D3022
D3073 to D3100		
D3101 to D3122	P_L1_3 to POc_L1_3 Proportional band of group 3 Heating-side proportional band (in Heating/cooling control) of group 3 to Cooling-side preset output of group 3	Same as D3001 to D3022
D3123 to D3150		
D3151 to D3172	P_L1_4 to POc_L1_4 Proportional band of group 4 Heating-side proportional band (in Heating/cooling control) of group 4 to Cooling-side preset output of group 4	Same as D3001 to D3022
D3173 to D3200		
D3201 to D3222	P_L1_5 to POc_L1_5 Proportional band of group 5 Heating-side proportional band (in Heating/cooling control) of group 5 to Cooling-side preset output of group 5	Same as D3001 to D3022
D3223 to D3250		
D3251 to D3272	P_L1_6 to POc_L1_6 Proportional band of group 6 Heating-side proportional band (in Heating/cooling control) of group 6 to Cooling-side preset output of group 6	Same as D3001 to D3022
D3273 to D3300		
D3301 to D3322	P_L1_7 to POc_L1_7 Proportional band of group 7 Heating-side proportional band (in Heating/cooling control) of group 7 to Cooling-side preset output of group 7	Same as D3001 to D3022
D3323 to D3350		
D3351 to D3372	P_L1_8 to POc_L1_8 Proportional band of group 8 Heating-side proportional band (in Heating/cooling control) of group 8 to Cooling-side preset output of group 8	Same as D3001 to D3022
D3373 to D3400		
D3401 to D3422	P_L1_R to POc_L1_R Proportional band of group R Heating-side proportional band (in Heating/cooling control) of group R to Cooling-side preset output of group R	Same as D3001 to D3022
D3423 to D3500		

Loop-1 Control Action-related Setting (D3501 to D3600)

Register No.	Description		Range and meaning of value
D3501	SC_L1	Super function	0: OFF (Disable) 1: Overshoot suppressing function (normal mode) 2: Hunting suppressing function (stable mode) Enables to answer the wider characteristic changes compared with response mode. 3: Hunting suppressing function (response mode) Enables quick follow-up and short converging time of PV for the changed SP. 4: Overshoot suppressing function (strong suppressing mode) Note: Setpoints 2 and 3 must be used in PID control or PI control. Disabled in the following controls: 1) ON/OFF control, 2) PD control, 3) P control, 4) Heating/cooling control Do not use the function for the control processes with response such as flow or pressure control.
D3502			
D3503	AT.TY_L1	Auto-tuning type	0: Normal 1: Stability
D3504	AT.OH_L1	Output high limit in auto-tuning	-5.0 to 105.0% (Disabled in Heating/cooling control)
D3505	AT.OL_L1	Output low limit in auto-tuning	
D3506	AT.BS_L1	SP bias in auto-tuning	-100.0 to 100.0% of PV input range span (EUS)
D3507 to D3510			
D3511	STM	Sample PI sampled time	0 to 9999 s
D3512	SWD	Sample PI control time span	0 to 9999 s
D3513	GW_L1	Non-linear control gap width	0: OFF 0.0+1digit to 50.0% of PV input range span (EUS)
D3514	GG_L1	Non-linear control gain	0.001 to 1.000
D3515 to D3516			
D3517	BD	Batch PID deviation setpoint	0.0 to 100.0% of PV input range span (EUS)
D3518	BB	Batch PID bias	0.0 to 100.0%
D3519	BL	Batch PID lock-up width	0.0 to 100.0% of PV input range span (EUS)
D3520			
D3521	FLG	Feedforward first-order lag time constant	0: OFF, 1 to 120 s
D3522	FGN	Feedforward gain	-9.999 to 9.999
D3523	FBI	Feedforward input bias	-100.0 to 100.0%
D3524	FBO	Feedforward output bias	-999.9 to 999.9%
D3525			
D3526	AR_L1	Anti-reset windup (excess integration prevention)	0: AUTO, 50.0 to 200.0%
D3527	OPR_L1	Output velocity limiter	0: OFF (Disable), 0.1 to 100.0%/s
D3528	OLMT_L1	Output limiter switch	0: OFF (Disable output limiter in MAN mode) 1: ON (Enable output limiter in MAN mode)
D3529 to D3530			
D3531	MPON_L1	Manual preset output number selection	Select the output used in MAN mode when switched from AUTO to MAN mode. 0: OFF (Hold the control output in AUTO mode (bumpless)) 1: Use manual preset output 1 (output bump) 2: Use manual preset output 2 (output bump) 3: Use manual preset output 3 (output bump) 4: Use manual preset output 4 (output bump) 5: Use manual preset output 5 (output bump)
D3532	MPO1_L1	Manual preset output 1	-5.0 to 105.0% However, output is limited to the output high limit and low limit.
D3533	MPO2_L1	Manual preset output 2	
D3534	MPO3_L1	Manual preset output 3	
D3535	MPO4_L1	Manual preset output 4	
D3536	MPO5_L1	Manual preset output 5	
D3537 to D3550			

6.4 UT55A/UT52A/UP55A D Registers

Register No.	Description	Range and meaning of value
D3551	RP1_L1	Reference point 1
D3552	RP2_L1	Reference point 2
D3553	RP3_L1	Reference point 3
D3554	RP4_L1	Reference point 4
D3555	RP5_L1	Reference point 5
D3556	RP6_L1	Reference point 6
D3557	RP7_L1	Reference point 7
D3558	RHY_L1	Zone PID switching hysteresis
D3559	RDV_L1	Reference deviation
D3560 to D3600		

6.4.4 Loop-2 Operation Parameter (D3601 to D4700)

Loop-2 operation parameter													
SP and alarm setpoint setting (Menu: SP)													
D-Reg No.	Ref. No.	H No.	Register symbol	R/W			D-Reg No.	Ref. No.	H No.	Register symbol	R/W		
				UT 55A	UT 52A	UP 55A					UT 55A	UT 52A	UP 55A
D3601	43601	0E10	SP_L2_1	R/W	R/W	/	D3651	43651	0E42	A8_L2_3	R/W	R/W	/
D3602	43602	0E11					D3652	43652	0E43				
D3603	43603	0E12	PIDN_L2_1	R/W	R/W	/	D3653	43653	0E44				
D3604	43604	0E13	A1_L2_1	R/W	R/W	/	D3654	43654	0E45				
D3605	43605	0E14	A2_L2_1	R/W	R/W	/	D3655	43655	0E46				
D3606	43606	0E15	A3_L2_1	R/W	R/W	/	D3656	43656	0E47				
D3607	43607	0E16	A4_L2_1	R/W	R/W	/	D3657	43657	0E48				
D3608	43608	0E17	A5_L2_1	R/W	R/W	/	D3658	43658	0E49				
D3609	43609	0E18	A6_L2_1	R/W	R/W	/	D3659	43659	0E4A				
D3610	43610	0E19	A7_L2_1	R/W	R/W	/	D3660	43660	0E4B				
D3611	43611	0E1A	A8_L2_1	R/W	R/W	/	D3661	43661	0E4C	SP_L2_4	R/W	R/W	/
D3612	43612	0E1B					D3662	43662	0E4D				
D3613	43613	0E1C					D3663	43663	0E4E	PIDN_L2_4	R/W	R/W	/
D3614	43614	0E1D					D3664	43664	0E4F	A1_L2_4	R/W	R/W	/
D3615	43615	0E1E					D3665	43665	0E50	A2_L2_4	R/W	R/W	/
D3616	43616	0E1F					D3666	43666	0E51	A3_L2_4	R/W	R/W	/
D3617	43617	0E20					D3667	43667	0E52	A4_L2_4	R/W	R/W	/
D3618	43618	0E21					D3668	43668	0E53	A5_L2_4	R/W	R/W	/
D3619	43619	0E22					D3669	43669	0E54	A6_L2_4	R/W	R/W	/
D3620	43620	0E23					D3670	43670	0E55	A7_L2_4	R/W	R/W	/
D3621	43621	0E24	SP_L2_2	R/W	R/W	/	D3671	43671	0E56	A8_L2_4	R/W	R/W	/
D3622	43622	0E25					D3672	43672	0E57				
D3623	43623	0E26	PIDN_L2_2	R/W	R/W	/	D3673	43673	0E58				
D3624	43624	0E27	A1_L2_2	R/W	R/W	/	D3674	43674	0E59				
D3625	43625	0E28	A2_L2_2	R/W	R/W	/	D3675	43675	0E5A				
D3626	43626	0E29	A3_L2_2	R/W	R/W	/	D3676	43676	0E5B				
D3627	43627	0E2A	A4_L2_2	R/W	R/W	/	D3677	43677	0E5C				
D3628	43628	0E2B	A5_L2_2	R/W	R/W	/	D3678	43678	0E5D				
D3629	43629	0E2C	A6_L2_2	R/W	R/W	/	D3679	43679	0E5E				
D3630	43630	0E2D	A7_L2_2	R/W	R/W	/	D3680	43680	0E5F				
D3631	43631	0E2E	A8_L2_2	R/W	R/W	/	D3681	43681	0E60	SP_L2_5	R/W	R/W	/
D3632	43632	0E2F					D3682	43682	0E61				
D3633	43633	0E30					D3683	43683	0E62	PIDN_L2_5	R/W	R/W	/
D3634	43634	0E31					D3684	43684	0E63	A1_L2_5	R/W	R/W	/
D3635	43635	0E32					D3685	43685	0E64	A2_L2_5	R/W	R/W	/
D3636	43636	0E33					D3686	43686	0E65	A3_L2_5	R/W	R/W	/
D3637	43637	0E34					D3687	43687	0E66	A4_L2_5	R/W	R/W	/
D3638	43638	0E35					D3688	43688	0E67	A5_L2_5	R/W	R/W	/
D3639	43639	0E36					D3689	43689	0E68	A6_L2_5	R/W	R/W	/
D3640	43640	0E37					D3690	43690	0E69	A7_L2_5	R/W	R/W	/
D3641	43641	0E38	SP_L2_3	R/W	R/W	/	D3691	43691	0E6A	A8_L2_5	R/W	R/W	/
D3642	43642	0E39					D3692	43692	0E6B				
D3643	43643	0E3A	PIDN_L2_3	R/W	R/W	/	D3693	43693	0E6C				
D3644	43644	0E3B	A1_L2_3	R/W	R/W	/	D3694	43694	0E6D				
D3645	43645	0E3C	A2_L2_3	R/W	R/W	/	D3695	43695	0E6E				
D3646	43646	0E3D	A3_L2_3	R/W	R/W	/	D3696	43696	0E6F				
D3647	43647	0E3E	A4_L2_3	R/W	R/W	/	D3697	43697	0E70				
D3648	43648	0E3F	A5_L2_3	R/W	R/W	/	D3698	43698	0E71				
D3649	43649	0E40	A6_L2_3	R/W	R/W	/	D3699	43699	0E72				
D3650	43650	0E41	A7_L2_3	R/W	R/W	/	D3700	43700	0E73				

6.4 UT55A/UT52A/UP55A D Registers

Loop-2 operation parameter													
SP and alarm setpoint setting (Menu: SP)													
D-Reg No.	Ref. No.	H No.	Register symbol	R/W			D-Reg No.	Ref. No.	H No.	Register symbol	R/W		
				UT 55A	UT 52A	UP 55A					UT 55A	UT 52A	UP 55A
D3701	43701	0E74	SP_L2_6	R/W	R/W		D3751	43751	0EA6	A8_L2_8	R/W	R/W	
D3702	43702	0E75					D3752	43752	0EA7				
D3703	43703	0E76	PIDN_L2_6	R/W	R/W		D3753	43753	0EA8				
D3704	43704	0E77	A1_L2_6	R/W	R/W		D3754	43754	0EA9				
D3705	43705	0E78	A2_L2_6	R/W	R/W		D3755	43755	0EAA				
D3706	43706	0E79	A3_L2_6	R/W	R/W		D3756	43756	0EAB				
D3707	43707	0E7A	A4_L2_6	R/W	R/W		D3757	43757	0EAC				
D3708	43708	0E7B	A5_L2_6	R/W	R/W		D3758	43758	0EAD				
D3709	43709	0E7C	A6_L2_6	R/W	R/W		D3759	43759	0EAE				
D3710	43710	0E7D	A7_L2_6	R/W	R/W		D3760	43760	0EAF				
D3711	43711	0E7E	A8_L2_6	R/W	R/W		D3761	43761	0EB0				
D3712	43712	0E7F					D3762	43762	0EB1				
D3713	43713	0E80					D3763	43763	0EB2				
D3714	43714	0E81					D3764	43764	0EB3				
D3715	43715	0E82					D3765	43765	0EB4				
D3716	43716	0E83					D3766	43766	0EB5				
D3717	43717	0E84					D3767	43767	0EB6				
D3718	43718	0E85					D3768	43768	0EB7				
D3719	43719	0E86					D3769	43769	0EB8				
D3720	43720	0E87					D3770	43770	0EB9				
D3721	43721	0E88	SP_L2_7	R/W	R/W		D3771	43771	0EBA				
D3722	43722	0E89					D3772	43772	0EBB				
D3723	43723	0E8A	PIDN_L2_7	R/W	R/W		D3773	43773	0EBC				
D3724	43724	0E8B	A1_L2_7	R/W	R/W		D3774	43774	0EBD				
D3725	43725	0E8C	A2_L2_7	R/W	R/W		D3775	43775	0EBE				
D3726	43726	0E8D	A3_L2_7	R/W	R/W		D3776	43776	0EBF				
D3727	43727	0E8E	A4_L2_7	R/W	R/W		D3777	43777	0EC0				
D3728	43728	0E8F	A5_L2_7	R/W	R/W		D3778	43778	0EC1				
D3729	43729	0E90	A6_L2_7	R/W	R/W		D3779	43779	0EC2				
D3730	43730	0E91	A7_L2_7	R/W	R/W		D3780	43780	0EC3				
D3731	43731	0E92	A8_L2_7	R/W	R/W		D3781	43781	0EC4				
D3732	43732	0E93					D3782	43782	0EC5				
D3733	43733	0E94					D3783	43783	0EC6				
D3734	43734	0E95					D3784	43784	0EC7				
D3735	43735	0E96					D3785	43785	0EC8				
D3736	43736	0E97					D3786	43786	0EC9				
D3737	43737	0E98					D3787	43787	0ECA				
D3738	43738	0E99					D3788	43788	0ECB				
D3739	43739	0E9A					D3789	43789	0ECC				
D3740	43740	0E9B					D3790	43790	0ECD				
D3741	43741	0E9C	SP_L2_8	R/W	R/W		D3791	43791	0ECE				
D3742	43742	0E9D					D3792	43792	0ECF				
D3743	43743	0E9E	PIDN_L2_8	R/W	R/W		D3793	43793	0ED0				
D3744	43744	0E9F	A1_L2_8	R/W	R/W		D3794	43794	0ED1				
D3745	43745	0EA0	A2_L2_8	R/W	R/W		D3795	43795	0ED2				
D3746	43746	0EA1	A3_L2_8	R/W	R/W		D3796	43796	0ED3				
D3747	43747	0EA2	A4_L2_8	R/W	R/W		D3797	43797	0ED4				
D3748	43748	0EA3	A5_L2_8	R/W	R/W		D3798	43798	0ED5				
D3749	43749	0EA4	A6_L2_8	R/W	R/W		D3799	43799	0ED6				
D3750	43750	0EA5	A7_L2_8	R/W	R/W		D3800	43800	0ED7				

Loop-2 operation parameter													
SP-related setting (Menu: SPS)													
D-Reg No.	Ref. No.	H No.	Register symbol	R/W			D-Reg No.	Ref. No.	H No.	Register symbol	R/W		
				UT 55A	UT 52A	UP 55A					UT 55A	UT 52A	UP 55A
D3801	43801	0ED8	RMS_L2	R/W	R/W		D3851	43851	F0A				
D3802	43802	0ED9	RFL_L2	R/W	R/W		D3852	43852	F0B				
D3803	43803	0EDA	RT_L2	R/W	R/W		D3853	43853	F0C				
D3804	43804	0EDB	RBS_L2	R/W	R/W		D3854	43854	F0D				
D3805	43805	0EDC	UPR_L2	R/W	R/W		D3855	43855	F0E				
D3806	43806	0EDD	DNR_L2	R/W	R/W		D3856	43856	F0F				
D3807	43807	0EDE	TMU_L2	R/W	R/W		D3857	43857	F10				
D3808	43808	0EDF					D3858	43858	F11				
D3809	43809	0EE0					D3859	43859	F12				
D3810	43810	0EE1	SPT_L2	R/W	R/W		D3860	43860	F13				
D3811	43811	0EE2	PVT_L2	R/W	R/W		D3861	43861	F14				
D3812	43812	0EE3					D3862	43862	F15				
D3813	43813	0EE4					D3863	43863	F16				
D3814	43814	0EE5					D3864	43864	F17				
D3815	43815	0EE6					D3865	43865	F18				
D3816	43816	0EE7					D3866	43866	F19				
D3817	43817	0EE8					D3867	43867	F1A				
D3818	43818	0EE9					D3868	43868	F1B				
D3819	43819	0EEA					D3869	43869	F1C				
D3820	43820	0EEB					D3870	43870	F1D				
D3821	43821	0EEC					D3871	43871	F1E				
D3822	43822	0EED					D3872	43872	F1F				
D3823	43823	0EEE					D3873	43873	F20				
D3824	43824	0EEF					D3874	43874	F21				
D3825	43825	0EF0					D3875	43875	F22				
D3826	43826	0EF1					D3876	43876	F23				
D3827	43827	0EF2					D3877	43877	F24				
D3828	43828	0EF3					D3878	43878	F25				
D3829	43829	0EF4					D3879	43879	F26				
D3830	43830	0EF5					D3880	43880	F27				
D3831	43831	0EF6					D3881	43881	F28				
D3832	43832	0EF7					D3882	43882	F29				
D3833	43833	0EF8					D3883	43883	F2A				
D3834	43834	0EF9					D3884	43884	F2B				
D3835	43835	0EFA					D3885	43885	F2C				
D3836	43836	0EFB					D3886	43886	F2D				
D3837	43837	0EFC					D3887	43887	F2E				
D3838	43838	0EFD					D3888	43888	F2F				
D3839	43839	0EFE					D3889	43889	F30				
D3840	43840	0EFF					D3890	43890	F31				
D3841	43841	0F00					D3891	43891	F32				
D3842	43842	0F01					D3892	43892	F33				
D3843	43843	0F02					D3893	43893	F34				
D3844	43844	0F03					D3894	43894	F35				
D3845	43845	0F04					D3895	43895	F36				
D3846	43846	0F05					D3896	43896	F37				
D3847	43847	0F06					D3897	43897	F38				
D3848	43848	0F07					D3898	43898	F39				
D3849	43849	0F08					D3899	43899	F3A				
D3850	43850	0F09					D3900	43900	F3B				

6.4 UT55A/UT52A/UP55A D Registers

Loop-2 operation parameter													
Alarm function setting (Menu: ALRM)													
D-Reg No.	Ref. No.	H No.	Register symbol	R/W			D-Reg No.	Ref. No.	H No.	Register symbol	R/W		
				UT 55A	UT 52A	UP 55A					UT 55A	UT 52A	UP 55A
D3901	43901	0F3C	AL1.T_L2	R/W	R/W	R/W	D3951	43951	0F6E	DYN3_L2	R/W	R/W	R/W
D3902	43902	0F3D	AL1.W_L2	R/W	R/W	R/W	D3952	43952	0F6F	DYN4_L2	R/W	R/W	R/W
D3903	43903	0F3E	AL1.D_L2	R/W	R/W	R/W	D3953	43953	0F70	DYN5_L2	R/W	R/W	R/W
D3904	43904	0F3F	AL1.L_L2	R/W	R/W	R/W	D3954	43954	0F71	DYN6_L2	R/W	R/W	R/W
D3905	43905	0F40	AL2.T_L2	R/W	R/W	R/W	D3955	43955	0F72	DYN7_L2	R/W	R/W	R/W
D3906	43906	0F41	AL2.W_L2	R/W	R/W	R/W	D3956	43956	0F73	DYN8_L2	R/W	R/W	R/W
D3907	43907	0F42	AL2.D_L2	R/W	R/W	R/W	D3957	43957	0F74	DYF1_L2	R/W	R/W	R/W
D3908	43908	0F43	AL2.L_L2	R/W	R/W	R/W	D3958	43958	0F75	DYF2_L2	R/W	R/W	R/W
D3909	43909	0F44	AL3.T_L2	R/W	R/W	R/W	D3959	43959	0F76	DYF3_L2	R/W	R/W	R/W
D3910	43910	0F45	AL3.W_L2	R/W	R/W	R/W	D3960	43960	0F77	DYF4_L2	R/W	R/W	R/W
D3911	43911	0F46	AL3.D_L2	R/W	R/W	R/W	D3961	43961	0F78	DYF5_L2	R/W	R/W	R/W
D3912	43912	0F47	AL3.L_L2	R/W	R/W	R/W	D3962	43962	0F79	DYF6_L2	R/W	R/W	R/W
D3913	43913	0F48	AL4.T_L2	R/W	R/W	R/W	D3963	43963	0F7A	DYF7_L2	R/W	R/W	R/W
D3914	43914	0F49	AL4.W_L2	R/W	R/W	R/W	D3964	43964	0F7B	DYF8_L2	R/W	R/W	R/W
D3915	43915	0F4A	AL4.D_L2	R/W	R/W	R/W	D3965	43965	0F7C				
D3916	43916	0F4B	AL4.L_L2	R/W	R/W	R/W	D3966	43966	0F7D	AMD_L2	R/W	R/W	R/W
D3917	43917	0F4C	AL5.T_L2	R/W	R/W	R/W	D3967	43967	0F7E				
D3918	43918	0F4D	AL5.W_L2	R/W	R/W	R/W	D3968	43968	0F7F				
D3919	43919	0F4E	AL5.D_L2	R/W	R/W	R/W	D3969	43969	0F80				
D3920	43920	0F4F	AL5.L_L2	R/W	R/W	R/W	D3970	43970	0F81				
D3921	43921	0F50	AL6.T_L2	R/W	R/W	R/W	D3971	43971	0F82				
D3922	43922	0F51	AL6.W_L2	R/W	R/W	R/W	D3972	43972	0F83				
D3923	43923	0F52	AL6.D_L2	R/W	R/W	R/W	D3973	43973	0F84				
D3924	43924	0F53	AL6.L_L2	R/W	R/W	R/W	D3974	43974	0F85				
D3925	43925	0F54	AL7.T_L2	R/W	R/W	R/W	D3975	43975	0F86				
D3926	43926	0F55	AL7.W_L2	R/W	R/W	R/W	D3976	43976	0F87				
D3927	43927	0F56	AL7.D_L2	R/W	R/W	R/W	D3977	43977	0F88				
D3928	43928	0F57	AL7.L_L2	R/W	R/W	R/W	D3978	43978	0F89				
D3929	43929	0F58	AL8.T_L2	R/W	R/W	R/W	D3979	43979	0F8A				
D3930	43930	0F59	AL8.W_L2	R/W	R/W	R/W	D3980	43980	0F8B				
D3931	43931	0F5A	AL8.D_L2	R/W	R/W	R/W	D3981	43981	0F8C				
D3932	43932	0F5B	AL8.L_L2	R/W	R/W	R/W	D3982	43982	0F8D				
D3933	43933	0F5C	VT1_L2	R/W	R/W	R/W	D3983	43983	0F8E				
D3934	43934	0F5D	VT2_L2	R/W	R/W	R/W	D3984	43984	0F8F				
D3935	43935	0F5E	VT3_L2	R/W	R/W	R/W	D3985	43985	0F90				
D3936	43936	0F5F	VT4_L2	R/W	R/W	R/W	D3986	43986	0F91				
D3937	43937	0F60	VT5_L2	R/W	R/W	R/W	D3987	43987	0F92				
D3938	43938	0F61	VT6_L2	R/W	R/W	R/W	D3988	43988	0F93				
D3939	43939	0F62	VT7_L2	R/W	R/W	R/W	D3989	43989	0F94				
D3940	43940	0F63	VT8_L2	R/W	R/W	R/W	D3990	43990	0F95				
D3941	43941	0F64	HY1_L2	R/W	R/W	R/W	D3991	43991	0F96				
D3942	43942	0F65	HY2_L2	R/W	R/W	R/W	D3992	43992	0F97				
D3943	43943	0F66	HY3_L2	R/W	R/W	R/W	D3993	43993	0F98				
D3944	43944	0F67	HY4_L2	R/W	R/W	R/W	D3994	43994	0F99				
D3945	43945	0F68	HY5_L2	R/W	R/W	R/W	D3995	43995	0F9A				
D3946	43946	0F69	HY6_L2	R/W	R/W	R/W	D3996	43996	0F9B				
D3947	43947	0F6A	HY7_L2	R/W	R/W	R/W	D3997	43997	0F9C				
D3948	43948	0F6B	HY8_L2	R/W	R/W	R/W	D3998	43998	0F9D				
D3949	43949	0F6C	DYN1_L2	R/W	R/W	R/W	D3999	43999	0F9E				
D3950	43950	0F6D	DYN2_L2	R/W	R/W	R/W	D4000	44000	0F9F				

Loop-2 operation parameter													
PV-related setting (Menu: PVS)													
D-Reg No.	Ref. No.	H No.	Register symbol	R/W			D-Reg No.	Ref. No.	H No.	Register symbol	R/W		
				UT 55A	UT 52A	UP 55A					UT 55A	UT 52A	UP 55A
D4001	44001	0FA0	BS_L2	R/W	R/W	R/W	D4051	44051	0FD2				
D4002	44002	0FA1	FL_L2	R/W	R/W	R/W	D4052	44052	0FD3				
D4003	44003	0FA2					D4053	44053	0FD4				
D4004	44004	0FA3					D4054	44054	0FD5				
D4005	44005	0FA4					D4055	44055	0FD6				
D4006	44006	0FA5					D4056	44056	0FD7				
D4007	44007	0FA6					D4057	44057	0FD8				
D4008	44008	0FA7					D4058	44058	0FD9				
D4009	44009	0FA8					D4059	44059	0FDA				
D4010	44010	0FA9					D4060	44060	vFDB				
D4011	44011	0FAA					D4061	44061	0FDC				
D4012	44012	0FAB					D4062	44062	0FDD				
D4013	44013	0FAC					D4063	44063	0FDE				
D4014	44014	0FAD					D4064	44064	0FDF				
D4015	44015	0FAE					D4065	44065	0FE0				
D4016	44016	0FAF					D4066	44066	0FE1				
D4017	44017	0FB0					D4067	44067	0FE2				
D4018	44018	0FB1					D4068	44068	0FE3				
D4019	44019	0FB2					D4069	44069	0FE4				
D4020	44020	0FB3					D4070	44070	0FE5				
D4021	44021	0FB4					D4071	44071	0FE6				
D4022	44022	0FB5					D4072	44072	0FE7				
D4023	44023	0FB6					D4073	44073	0FE8				
D4024	44024	0FB7					D4074	44074	0FE9				
D4025	44025	0FB8					D4075	44075	0FEA				
D4026	44026	0FB9					D4076	44076	0FEB				
D4027	44027	0FBA					D4077	44077	0FEC				
D4028	44028	0FBB					D4078	44078	0FED				
D4029	44029	0FBC					D4079	44079	0FEE				
D4030	44030	0FBD					D4080	44080	0FEF				
D4031	44031	0FBE					D4081	44081	0FF0				
D4032	44032	0FBF					D4082	44082	0FF1				
D4033	44033	0FC0					D4083	44083	0FF2				
D4034	44034	0FC1					D4084	44084	0FF3				
D4035	44035	0FC2					D4085	44085	0FF4				
D4036	44036	0FC3					D4086	44086	0FF5				
D4037	44037	0FC4					D4087	44087	0FF6				
D4038	44038	0FC5					D4088	44088	0FF7				
D4039	44039	0FC6					D4089	44089	0FF8				
D4040	44040	0FC7					D4090	44090	0FF9				
D4041	44041	0FC8					D4091	44091	0FFA				
D4042	44042	0FC9					D4092	44092	0FFB				
D4043	44043	0FCA					D4093	44093	0FFC				
D4044	44044	0FCB					D4094	44094	0FFD				
D4045	44045	0FCC					D4095	44095	0FFE				
D4046	44046	0FCD					D4096	44096	0FFF				
D4047	44047	0FCE					D4097	44097	1000				
D4048	44048	0FCF					D4098	44098	1001				
D4049	44049	0FD0					D4099	44099	1002				
D4050	44050	0FD1					D4100	44100	1003				

6.4 UT55A/UT52A/UP55A D Registers

Loop-2 operation parameter													
PID setting (Menu: PID)													
D-Reg No.	Ref. No.	H No.	Register symbol	R/W			D-Reg No.	Ref. No.	H No.	Register symbol	R/W		
				UT 55A	UT 52A	UP 55A					UT 55A	UT 52A	UP 55A
D4101	44101	1004	P_L2_1	R/W	R/W	R/W	D4151	44151	1036	P_L2_2	R/W	R/W	R/W
D4102	44102	1005	I_L2_1	R/W	R/W	R/W	D4152	44152	1037	I_L2_2	R/W	R/W	R/W
D4103	44103	1006	D_L2_1	R/W	R/W	R/W	D4153	44153	1038	D_L2_2	R/W	R/W	R/W
D4104	44104	1007	OH_L2_1	R/W	R/W	R/W	D4154	44154	1039	OH_L2_2	R/W	R/W	R/W
D4105	44105	1008	OL_L2_1	R/W	R/W	R/W	D4155	44155	103A	OL_L2_2	R/W	R/W	R/W
D4106	44106	1009	MR_L2_1	R/W	R/W	R/W	D4156	44156	103B	MR_L2_2	R/W	R/W	R/W
D4107	44107	100A	HYS_L2_1	R/W	R/W	R/W	D4157	44157	103C	HYS_L2_2	R/W	R/W	R/W
D4108	44108	100B					D4158	44158	103D				
D4109	44109	100C					D4159	44159	103E				
D4110	44110	100D					D4160	44160	103F				
D4111	44111	100E	DR_L2_1	R/W	R/W	R/W	D4161	44161	1040	DR_L2_2	R/W	R/W	R/W
D4112	44112	100F					D4162	44162	1041				
D4113	44113	1010	Pc_L2_1	R/W	R/W	R/W	D4163	44163	1042	Pc_L2_2	R/W	R/W	R/W
D4114	44114	1011	Ic_L2_1	R/W	R/W	R/W	D4164	44164	1043	Ic_L2_2	R/W	R/W	R/W
D4115	44115	1012	Dc_L2_1	R/W	R/W	R/W	D4165	44165	1044	Dc_L2_2	R/W	R/W	R/W
D4116	44116	1013	OHc_L2_1	R/W	R/W	R/W	D4166	44166	1045	OHc_L2_2	R/W	R/W	R/W
D4117	44117	1014	OLc_L2_1	R/W	R/W	R/W	D4167	44167	1046	OLc_L2_2	R/W	R/W	R/W
D4118	44118	1015	HYSc_L2_1	R/W	R/W	R/W	D4168	44168	1047	HYSc_L2_2	R/W	R/W	R/W
D4119	44119	1016	DB_L2_1	R/W	R/W	R/W	D4169	44169	1048	DB_L2_2	R/W	R/W	R/W
D4120	44120	1017	PO_L2_1	R/W	R/W	R/W	D4170	44170	1049	PO_L2_2	R/W	R/W	R/W
D4121	44121	1018					D4171	44171	104A				
D4122	44122	1019	POc_L2_1	R/W	R/W	R/W	D4172	44172	104B	POc_L2_2	R/W	R/W	R/W
D4123	44123	101A					D4173	44173	104C				
D4124	44124	101B					D4174	44174	104D				
D4125	44125	101C					D4175	44175	104E				
D4126	44126	101D					D4176	44176	104F				
D4127	44127	101E					D4177	44177	1050				
D4128	44128	101F					D4178	44178	1051				
D4129	44129	1020					D4179	44179	1052				
D4130	44130	1021					D4180	44180	1053				
D4131	44131	1022					D4181	44181	1054				
D4132	44132	1023					D4182	44182	1055				
D4133	44133	1024					D4183	44183	1056				
D4134	44134	1025					D4184	44184	1057				
D4135	44135	1026					D4185	44185	1058				
D4136	44136	1027					D4186	44186	1059				
D4137	44137	1028					D4187	44187	105A				
D4138	44138	1029					D4188	44188	105B				
D4139	44139	102A					D4189	44189	105C				
D4140	44140	102B					D4190	44190	105D				
D4141	44141	102C					D4191	44191	105E				
D4142	44142	102D					D4192	44192	105F				
D4143	44143	102E					D4193	44193	1060				
D4144	44144	102F					D4194	44194	1061				
D4145	44145	1030					D4195	44195	1062				
D4146	44146	1031					D4196	44196	1063				
D4147	44147	1032					D4197	44197	1064				
D4148	44148	1033					D4198	44198	1065				
D4149	44149	1034					D4199	44199	1066				
D4150	44150	1035					D4200	44200	1067				

Loop-2 operation parameter													
PID setting (Menu: PID)													
D-Reg No.	Ref. No.	H No.	Register symbol	R/W			D-Reg No.	Ref. No.	H No.	Register symbol	R/W		
				UT 55A	UT 52A	UP 55A					UT 55A	UT 52A	UP 55A
D4201	44201	1068	P_L2_3	R/W	R/W	R/W	D4251	44251	109A	P_L2_4	R/W	R/W	R/W
D4202	44202	1069	I_L2_3	R/W	R/W	R/W	D4252	44252	109B	I_L2_4	R/W	R/W	R/W
D4203	44203	106A	D_L2_3	R/W	R/W	R/W	D4253	44253	109C	D_L2_4	R/W	R/W	R/W
D4204	44204	106B	OH_L2_3	R/W	R/W	R/W	D4254	44254	109D	OH_L2_4	R/W	R/W	R/W
D4205	44205	106C	OL_L2_3	R/W	R/W	R/W	D4255	44255	109E	OL_L2_4	R/W	R/W	R/W
D4206	44206	106D	MR_L2_3	R/W	R/W	R/W	D4256	44256	109F	MR_L2_4	R/W	R/W	R/W
D4207	44207	106E	HYS_L2_3	R/W	R/W	R/W	D4257	44257	10A0	HYS_L2_4	R/W	R/W	R/W
D4208	44208	106F					D4258	44258	10A1				
D4209	44209	1070					D4259	44259	10A2				
D4210	44210	1071					D4260	44260	10A3				
D4211	44211	1072	DR_L2_3	R/W	R/W	R/W	D4261	44261	10A4	DR_L2_4	R/W	R/W	R/W
D4212	44212	1073					D4262	44262	10A5				
D4213	44213	1074	Pc_L2_3	R/W	R/W	R/W	D4263	44263	10A6	Pc_L2_4	R/W	R/W	R/W
D4214	44214	1075	Ic_L2_3	R/W	R/W	R/W	D4264	44264	10A7	Ic_L2_4	R/W	R/W	R/W
D4215	44215	1076	Dc_L2_3	R/W	R/W	R/W	D4265	44265	10A8	Dc_L2_4	R/W	R/W	R/W
D4216	44216	1077	OHc_L2_3	R/W	R/W	R/W	D4266	44266	10A9	OHc_L2_4	R/W	R/W	R/W
D4217	44217	1078	OLc_L2_3	R/W	R/W	R/W	D4267	44267	10AA	OLc_L2_4	R/W	R/W	R/W
D4218	44218	1079	HYSc_L2_3	R/W	R/W	R/W	D4268	44268	10AB	HYSc_L2_4	R/W	R/W	R/W
D4219	44219	107A	DB_L2_3	R/W	R/W	R/W	D4269	44269	10AC	DB_L2_4	R/W	R/W	R/W
D4220	44220	107B	PO_L2_3	R/W	R/W	R/W	D4270	44270	10AD	PO_L2_4	R/W	R/W	R/W
D4221	44221	107C					D4271	44271	10AE				
D4222	44222	107D	POc_L2_3	R/W	R/W	R/W	D4272	44272	10AF	POc_L2_4	R/W	R/W	R/W
D4223	44223	107E					D4273	44273	10B0				
D4224	44224	107F					D4274	44274	10B1				
D4225	44225	1080					D4275	44275	10B2				
D4226	44226	1081					D4276	44276	10B3				
D4227	44227	1082					D4277	44277	10B4				
D4228	44228	1083					D4278	44278	10B5				
D4229	44229	1084					D4279	44279	10B6				
D4230	44230	1085					D4280	44280	10B7				
D4231	44231	1086					D4281	44281	10B8				
D4232	44232	1087					D4282	44282	10B9				
D4233	44233	1088					D4283	44283	10BA				
D4234	44234	1089					D4284	44284	10BB				
D4235	44235	108A					D4285	44285	10BC				
D4236	44236	108B					D4286	44286	10BD				
D4237	44237	108C					D4287	44287	10BE				
D4238	44238	108D					D4288	44288	10BF				
D4239	44239	108E					D4289	44289	10C0				
D4240	44240	108F					D4290	44290	10C1				
D4241	44241	1090					D4291	44291	10C2				
D4242	44242	1091					D4292	44292	10C3				
D4243	44243	1092					D4293	44293	10C4				
D4244	44244	1093					D4294	44294	10C5				
D4245	44245	1094					D4295	44295	10C6				
D4246	44246	1095					D4296	44296	10C7				
D4247	44247	1096					D4297	44297	10C8				
D4248	44248	1097					D4298	44298	10C9				
D4249	44249	1098					D4299	44299	10CA				
D4250	44250	1099					D4300	44300	10CB				

6.4 UT55A/UT52A/UP55A D Registers

Loop-2 operation parameter													
PID setting (Menu: PID)													
D-Reg No.	Ref. No.	H No.	Register symbol	R/W			D-Reg No.	Ref. No.	H No.	Register symbol	R/W		
				UT 55A	UT 52A	UP 55A					UT 55A	UT 52A	UP 55A
D4301	44301	10CC	P_L2_5	R/W	R/W	R/W	D4351	44351	10FE	P_L2_6	R/W	R/W	R/W
D4302	44302	10CD	I_L2_5	R/W	R/W	R/W	D4352	44352	10FF	I_L2_6	R/W	R/W	R/W
D4303	44303	10CE	D_L2_5	R/W	R/W	R/W	D4353	44353	1100	D_L2_6	R/W	R/W	R/W
D4304	44304	10CF	OH_L2_5	R/W	R/W	R/W	D4354	44354	1101	OH_L2_6	R/W	R/W	R/W
D4305	44305	10D0	OL_L2_5	R/W	R/W	R/W	D4355	44355	1102	OL_L2_6	R/W	R/W	R/W
D4306	44306	10D1	MR_L2_5	R/W	R/W	R/W	D4356	44356	1103	MR_L2_6	R/W	R/W	R/W
D4307	44307	10D2	HYS_L2_5	R/W	R/W	R/W	D4357	44357	1104	HYS_L2_6	R/W	R/W	R/W
D4308	44308	10D3					D4358	44358	1105				
D4309	44309	10D4					D4359	44359	1106				
D4310	44310	10D5					D4360	44360	1107				
D4311	44311	10D6	DR_L2_5	R/W	R/W	R/W	D4361	44361	1108	DR_L2_6	R/W	R/W	R/W
D4312	44312	10D7					D4362	44362	1109				
D4313	44313	10D8	Pc_L2_5	R/W	R/W	R/W	D4363	44363	110A	Pc_L2_6	R/W	R/W	R/W
D4314	44314	10D9	Ic_L2_5	R/W	R/W	R/W	D4364	44364	110B	Ic_L2_6	R/W	R/W	R/W
D4315	44315	10DA	Dc_L2_5	R/W	R/W	R/W	D4365	44365	110C	Dc_L2_6	R/W	R/W	R/W
D4316	44316	10DB	OHc_L2_5	R/W	R/W	R/W	D4366	44366	110D	OHc_L2_6	R/W	R/W	R/W
D4317	44317	10DC	OLc_L2_5	R/W	R/W	R/W	D4367	44367	110E	OLc_L2_6	R/W	R/W	R/W
D4318	44318	10DD	HYSc_L2_5	R/W	R/W	R/W	D4368	44368	110F	HYSc_L2_6	R/W	R/W	R/W
D4319	44319	10DE	DB_L2_5	R/W	R/W	R/W	D4369	44369	1110	DB_L2_6	R/W	R/W	R/W
D4320	44320	10DF	PO_L2_5	R/W	R/W	R/W	D4370	44370	1111	PO_L2_6	R/W	R/W	R/W
D4321	44321	10E0					D4371	44371	1112				
D4322	44322	10E1	POc_L2_5	R/W	R/W	R/W	D4372	44372	1113	POc_L2_6	R/W	R/W	R/W
D4323	44323	10E2					D4373	44373	1114				
D4324	44324	10E3					D4374	44374	1115				
D4325	44325	10E4					D4375	44375	1116				
D4326	44326	10E5					D4376	44376	1117				
D4327	44327	10E6					D4377	44377	1118				
D4328	44328	10E7					D4378	44378	1119				
D4329	44329	10E8					D4379	44379	111A				
D4330	44330	10E9					D4380	44380	111B				
D4331	44331	10EA					D4381	44381	111C				
D4332	44332	10EB					D4382	44382	111D				
D4333	44333	10EC					D4383	44383	111E				
D4334	44334	10ED					D4384	44384	111F				
D4335	44335	10EE					D4385	44385	1120				
D4336	44336	10EF					D4386	44386	1121				
D4337	44337	10F0					D4387	44387	1122				
D4338	44338	10F1					D4388	44388	1123				
D4339	44339	10F2					D4389	44389	1124				
D4340	44340	10F3					D4390	44390	1125				
D4341	44341	10F4					D4391	44391	1126				
D4342	44342	10F5					D4392	44392	1127				
D4343	44343	10F6					D4393	44393	1128				
D4344	44344	10F7					D4394	44394	1129				
D4345	44345	10F8					D4395	44395	112A				
D4346	44346	10F9					D4396	44396	112B				
D4347	44347	10FA					D4397	44397	112C				
D4348	44348	10FB					D4398	44398	112D				
D4349	44349	10FC					D4399	44399	112E				
D4350	44350	10FD					D4400	44400	112F				

Loop-2 operation parameter													
PID setting (Menu: PID)													
D-Reg No.	Ref. No.	H No.	Register symbol	R/W			D-Reg No.	Ref. No.	H No.	Register symbol	R/W		
				UT 55A	UT 52A	UP 55A					UT 55A	UT 52A	UP 55A
D4401	44401	1130	P_L2_7	R/W	R/W	R/W	D4451	44451	1162	P_L2_8	R/W	R/W	R/W
D4402	44402	1131	I_L2_7	R/W	R/W	R/W	D4452	44452	1163	I_L2_8	R/W	R/W	R/W
D4403	44403	1132	D_L2_7	R/W	R/W	R/W	D4453	44453	1164	D_L2_8	R/W	R/W	R/W
D4404	44404	1133	OH_L2_7	R/W	R/W	R/W	D4454	44454	1165	OH_L2_8	R/W	R/W	R/W
D4405	44405	1134	OL_L2_7	R/W	R/W	R/W	D4455	44455	1166	OL_L2_8	R/W	R/W	R/W
D4406	44406	1135	MR_L2_7	R/W	R/W	R/W	D4456	44456	1167	MR_L2_8	R/W	R/W	R/W
D4407	44407	1136	HYS_L2_7	R/W	R/W	R/W	D4457	44457	1168	HYS_L2_8	R/W	R/W	R/W
D4408	44408	1137					D4458	44458	1169				
D4409	44409	1138					D4459	44459	116A				
D4410	44410	1139					D4460	44460	116B				
D4411	44411	113A	DR_L2_7	R/W	R/W	R/W	D4461	44461	116C	DR_L2_8	R/W	R/W	R/W
D4412	44412	113B					D4462	44462	116D				
D4413	44413	113C	Pc_L2_7	R/W	R/W	R/W	D4463	44463	116E	Pc_L2_8	R/W	R/W	R/W
D4414	44414	113D	Ic_L2_7	R/W	R/W	R/W	D4464	44464	116F	Ic_L2_8	R/W	R/W	R/W
D4415	44415	113E	Dc_L2_7	R/W	R/W	R/W	D4465	44465	1170	Dc_L2_8	R/W	R/W	R/W
D4416	44416	113F	OHc_L2_7	R/W	R/W	R/W	D4466	44466	1171	OHc_L2_8	R/W	R/W	R/W
D4417	44417	1140	OLc_L2_7	R/W	R/W	R/W	D4467	44467	1172	OLc_L2_8	R/W	R/W	R/W
D4418	44418	1141	HYSc_L2_7	R/W	R/W	R/W	D4468	44468	1173	HYSc_L2_8	R/W	R/W	R/W
D4419	44419	1142	DB_L2_7	R/W	R/W	R/W	D4469	44469	1174	DB_L2_8	R/W	R/W	R/W
D4420	44420	1143	PO_L2_7	R/W	R/W	R/W	D4470	44470	1175	PO_L2_8	R/W	R/W	R/W
D4421	44421	1144					D4471	44471	1176				
D4422	44422	1145	POc_L2_7	R/W	R/W	R/W	D4472	44472	1177	POc_L2_8	R/W	R/W	R/W
D4423	44423	1146					D4473	44473	1178				
D4424	44424	1147					D4474	44474	1179				
D4425	44425	1148					D4475	44475	117A				
D4426	44426	1149					D4476	44476	117B				
D4427	44427	114A					D4477	44477	117C				
D4428	44428	114B					D4478	44478	117D				
D4429	44429	114C					D4479	44479	117E				
D4430	44430	114D					D4480	44480	117F				
D4431	44431	114E					D4481	44481	1180				
D4432	44432	114F					D4482	44482	1181				
D4433	44433	1150					D4483	44483	1182				
D4434	44434	1151					D4484	44484	1183				
D4435	44435	1152					D4485	44485	1184				
D4436	44436	1153					D4486	44486	1185				
D4437	44437	1154					D4487	44487	1186				
D4438	44438	1155					D4488	44488	1187				
D4439	44439	1156					D4489	44489	1188				
D4440	44440	1157					D4490	44490	1189				
D4441	44441	1158					D4491	44491	118A				
D4442	44442	1159					D4492	44492	118B				
D4443	44443	115A					D4493	44493	118C				
D4444	44444	115B					D4494	44494	118D				
D4445	44445	115C					D4495	44495	118E				
D4446	44446	115D					D4496	44496	118F				
D4447	44447	115E					D4497	44497	1190				
D4448	44448	115F					D4498	44498	1191				
D4449	44449	1160					D4499	44499	1192				
D4450	44450	1161					D4500	44500	1193				

6.4 UT55A/UT52A/UP55A D Registers

Loop-2 operation parameter													
PID setting (Menu: PID)													
D-Reg No.	Ref. No.	H No.	Register symbol	R/W			D-Reg No.	Ref. No.	H No.	Register symbol	R/W		
				UT 55A	UT 52A	UP 55A					UT 55A	UT 52A	UP 55A
D4501	44501	1194	P_L2_R	R/W	R/W	R/W	D4551	44551	11C6				
D4502	44502	1195	I_L2_R	R/W	R/W	R/W	D4552	44552	11C7				
D4503	44503	1196	D_L2_R	R/W	R/W	R/W	D4553	44553	11C8				
D4504	44504	1197	OH_L2_R	R/W	R/W	R/W	D4554	44554	11C9				
D4505	44505	1198	OL_L2_R	R/W	R/W	R/W	D4555	44555	11CA				
D4506	44506	1199	MR_L2_R	R/W	R/W	R/W	D4556	44556	11CB				
D4507	44507	119A	HYS_L2_R	R/W	R/W	R/W	D4557	44557	11CC				
D4508	44508	119B					D4558	44558	11CD				
D4509	44509	119C					D4559	44559	11CE				
D4510	44510	119D					D4560	44560	11CF				
D4511	44511	119E	DR_L2_R	R/W	R/W	R/W	D4561	44561	11D0				
D4512	44512	119F					D4562	44562	11D1				
D4513	44513	11A0	Pc_L2_R	R/W	R/W	R/W	D4563	44563	11D2				
D4514	44514	11A1	Ic_L2_R	R/W	R/W	R/W	D4564	44564	11D3				
D4515	44515	11A2	Dc_L2_R	R/W	R/W	R/W	D4565	44565	11D4				
D4516	44516	11A3	OHc_L2_R	R/W	R/W	R/W	D4566	44566	11D5				
D4517	44517	11A4	OLc_L2_R	R/W	R/W	R/W	D4567	44567	11D6				
D4518	44518	11A5	HYSc_L2_R	R/W	R/W	R/W	D4568	44568	11D7				
D4519	44519	11A6	DB_L2_R	R/W	R/W	R/W	D4569	44569	11D8				
D4520	44520	11A7	PO_L2_R	R/W	R/W	R/W	D4570	44570	11D9				
D4521	44521	11A8					D4571	44571	11DA				
D4522	44522	11A9	POc_L2_R	R/W	R/W	R/W	D4572	44572	11DB				
D4523	44523	11AA					D4573	44573	11DC				
D4524	44524	11AB					D4574	44574	11DD				
D4525	44525	11AC					D4575	44575	11DE				
D4526	44526	11AD					D4576	44576	11DF				
D4527	44527	11AE					D4577	44577	11E0				
D4528	44528	11AF					D4578	44578	11E1				
D4529	44529	11B0					D4579	44579	11E2				
D4530	44530	11B1					D4580	44580	11E3				
D4531	44531	11B2					D4581	44581	11E4				
D4532	44532	11B3					D4582	44582	11E5				
D4533	44533	11B4					D4583	44583	11E6				
D4534	44534	11B5					D4584	44584	11E7				
D4535	44535	11B6					D4585	44585	11E8				
D4536	44536	11B7					D4586	44586	11E9				
D4537	44537	11B8					D4587	44587	11EA				
D4538	44538	11B9					D4588	44588	11EB				
D4539	44539	11BA					D4589	44589	11EC				
D4540	44540	11BB					D4590	44590	11ED				
D4541	44541	11BC					D4591	44591	11EE				
D4542	44542	11BD					D4592	44592	11EF				
D4543	44543	11BE					D4593	44593	11F0				
D4544	44544	11BF					D4594	44594	11F1				
D4545	44545	11C0					D4595	44595	11F2				
D4546	44546	11C1					D4596	44596	11F3				
D4547	44547	11C2					D4597	44597	11F4				
D4548	44548	11C3					D4598	44598	11F5				
D4549	44549	11C4					D4599	44599	11F6				
D4550	44550	11C5					D4600	44600	11F7				

Loop-2 operation parameter													
Control action-related setting (Tuning menu: TUNE) (Zone control menu: ZONE)													
D-Reg No.	Ref. No.	H No.	Register symbol	R/W			D-Reg No.	Ref. No.	H No.	Register symbol	R/W		
				UT 55A	UT 52A	UP 55A					UT 55A	UT 52A	UP 55A
D4601	44601	11F8	SC_L2	R/W	R/W	R/W	D4651	44651	122A				
D4602	44602	11F9					D4652	44652	122B				
D4603	44603	11FA	AT.TY_L2	R/W	R/W	R/W	D4653	44653	122C	RP1_L2	R/W	R/W	R/W
D4604	44604	11FB	AT.OH_L2	R/W	R/W	R/W	D4654	44654	122D	RP2_L2	R/W	R/W	R/W
D4605	44605	11FC	AT.OL_L2	R/W	R/W	R/W	D4655	44655	122E	RP3_L2	R/W	R/W	R/W
D4606	44606	11FD	AT.BS_L2	R/W	R/W	R/W	D4656	44656	122F	RP4_L2	R/W	R/W	R/W
D4607	44607	11FE					D4657	44657	1230	RP5_L2	R/W	R/W	R/W
D4608	44608	11FF					D4658	44658	1231	RP6_L2	R/W	R/W	R/W
D4609	44609	1200					D4659	44659	1232	RP7_L2	R/W	R/W	R/W
D4610	44610	1201					D4660	44660	1233	RHY_L2	R/W	R/W	R/W
D4611	44611	1202					D4661	44661	1234	RDV_L2	R/W	R/W	R/W
D4612	44612	1203					D4662	44662	1235				
D4613	44613	1204	GW_L2	R/W	R/W	R/W	D4663	44663	1236				
D4614	44614	1205	GG_L2	R/W	R/W	R/W	D4664	44664	1237				
D4615	44615	1206					D4665	44665	1238				
D4616	44616	1207					D4666	44666	1239				
D4617	44617	1208					D4667	44667	123A				
D4618	44618	1209					D4668	44668	123B				
D4619	44619	120A					D4669	44669	123C				
D4620	44620	120B					D4670	44670	123D				
D4621	44621	120C					D4671	44671	123E				
D4622	44622	120D					D4672	44672	123F				
D4623	44623	120E					D4673	44673	1240				
D4624	44624	120F					D4674	44674	1241				
D4625	44625	1210					D4675	44675	1242				
D4626	44626	1211	AR_L2	R/W	R/W	R/W	D4676	44676	1243				
D4627	44627	1212	OPR_L2	R/W	R/W	R/W	D4677	44677	1244				
D4628	44628	1213	OLMT_L2	R/W	R/W	R/W	D4678	44678	1245				
D4629	44629	1214					D4679	44679	1246				
D4630	44630	1215					D4680	44680	1247				
D4631	44631	1216	MPON_L2	R/W	R/W	R/W	D4681	44681	1248				
D4632	44632	1217	MPO1_L2	R/W	R/W	R/W	D4682	44682	1249				
D4633	44633	1218	MPO2_L2	R/W	R/W	R/W	D4683	44683	124A				
D4634	44634	1219	MPO3_L2	R/W	R/W	R/W	D4684	44684	124B				
D4635	44635	121A	MPO4_L2	R/W	R/W	R/W	D4685	44685	124C				
D4636	44636	121B	MPO5_L2	R/W	R/W	R/W	D4686	44686	124D				
D4637	44637	121C					D4687	44687	124E				
D4638	44638	121D					D4688	44688	124F				
D4639	44639	121E					D4689	44689	1250				
D4640	44640	121F					D4690	44690	1251				
D4641	44641	1220					D4691	44691	1252				
D4642	44642	1221					D4692	44692	1253				
D4643	44643	1222					D4693	44693	1254				
D4644	44644	1223					D4694	44694	1255				
D4645	44645	1224					D4695	44695	1256				
D4646	44646	1225					D4696	44696	1257				
D4647	44647	1226					D4697	44697	1258				
D4648	44648	1227					D4698	44698	1259				
D4649	44649	1228					D4699	44699	125A				
D4650	44650	1229					D4700	44700	125B				

6.4 UT55A/UT52A/UP55A D Registers

Loop-2 SP and Alarm Setpoint Setting of Groups 1 to 8 (D3601 to D3800)

Register No.	Description	Range and meaning of value
D3601	SP_L2_1	Target setpoint of group 1
D3602		
D3603	PIDN_L2_1	PID number selection of group 1
D3604	A1_L2_1	Alarm-1 setpoint of group 1
D3605	A2_L2_1	Alarm-2 setpoint of group 1
D3606	A3_L2_1	Alarm-3 setpoint of group 1
D3607	A4_L2_1	Alarm-4 setpoint of group 1
D3608	A5_L2_1	Alarm-5 setpoint of group 1
D3609	A6_L2_1	Alarm-6 setpoint of group 1
D3610	A7_L2_1	Alarm-7 setpoint of group 1
D3611	A8_L2_1	Alarm-8 setpoint of group 1
D3612 to D3620		
D3621 to D3631	SP_L2_2 to A8_L2_2	Target setpoint of group 2 to Alarm-8 setpoint of group 2
D3632 to D3640		
D3641 to D3651	SP_L2_3 to A8_L2_3	Target setpoint of group 3 to Alarm-8 setpoint of group 3
D3652 to D3660		
D3661 to D3671	SP_L2_4 to A8C_L2_4	Target setpoint of group 4 to Alarm-8 setpoint of group 4
D3672 to D3680		
D3681 to D3691	SP_L2_5 to A8_L2_5	Target setpoint of group 5 to Alarm-8 setpoint of group 5
D3691 to D3700		
D3701 to D3711	SP_L2_6 to A8_L2_6	Target setpoint of group 6 to Alarm-8 setpoint of group 6
D3712 to D3720		
D3721 to D3731	SP_L2_7 to A8_L2_7	Target setpoint of group 7 to Alarm-8 setpoint of group 7
D3732 to D3740		
D3741 to D3751	SP_L2_8 to A8_L2_8	Target setpoint of group 8 to Alarm-8 setpoint of group 8
D3752 to D3800		

Loop-2 SP-related Setting (D3801 to D3900)

Register No.		Description	Range and meaning of value
D3801	RMS_L2	Remote input method	0: RSP (Via remote (aux. analog) input) 1: COM (Via communication) RSP is not displayed if the remote (auxiliary analog) input is not specified. COM is not displayed if the communication function is not specified. When neither the remote (auxiliary analog) input nor communication function is specified, this parameter is not displayed.
D3802	RFL_L2	Remote input filter	0: OFF (Disable) 1 to 120 s
D3803	RT_L2	Remote input ratio	SP = Remote input x RT + Remote input bias 0.001 to 9.999
D3804	RBS_L2	Remote input bias	-100.0 to 100.0% of PV input range span (EUS)
D3805	UPR_L2	SP ramp-up rate	Used to prevent SP from changing suddenly. Set a ramp-up rate or ramp-down rate per hour or minute. Set a time unit using the parameter TMU.
D3806	DNR_L2	SP ramp-down rate	0: OFF (Disable) 0.0 + 1 digit to 100.0% of PV input range span (EUS)
D3807	TMU_L2	SP ramp-rate time unit	0: HOUR (Ramp-up rate or ramp-down rate per hour) 1: MIN (Ramp-up rate or ramp-down rate per minute)
D3808 to D3809			
D3810	SPT_L2	SP tracking selection	Tracking is performed when the mode changes from Remote to Local. (The local setpoint keeps track of the remote setpoint.) 0: OFF (Disable) 1: ON (Enable)
D3811	PVT_L2	PV tracking selection	Causes the setpoint to keep track of the PV so the setpoint automatically reverts to its original value at a preset rate of change. The UPR, DNR, and TMU are used in combination. Operating conditions: 1) MAN → AUTO, 2) STOP → AUTO, 3) Power-on, 4) SP number change, 5) SP change 0: OFF (Disable) 1: ON (Enable)
D3812 to D3900			

6.4 UT55A/UT52A/UP55A D Registers

Loop-2 Alarm Function Setting (D3901 to D4000)

Register No.	Description	Range and meaning of value	
D3901	AL1.T_L2	AL1.T_L1 to AL8.T_L1 00: Disable 01: PV high limit 02: PV low limit 03: SP high limit 04: SP low limit 05: Deviation high limit 06: Deviation low limit 07: Deviation high and low limits 08: Deviation within high and low limits 09: Target SP high limit 10: Target SP low limit 11: Target SP deviation high limit 12: Target SP deviation low limit 13: Target SP deviation high and low limits 14: Target SP deviation within high and low limits 15: OUT high limit 16: OUT low limit 17: Cooling-side OUT high limit 18: Cooling-side OUT low limit 19: Analog input PV high limit 20: Analog input PV low limit 21: Analog input RSP high limit 22: Analog input RSP low limit 23: Analog input AIN2 high limit 24: Analog input AIN2 low limit 25: Analog input AIN4 high limit 26: Analog input AIN4 low limit 27: Feedback input high limit 28: Feedback input low limit 29: PV velocity 30: Fault diagnosis 31: FAIL	
D3902	AL1.W_L2		
D3903	AL1.D_L2		
D3904	AL1.L_L2		
D3905	AL2.T_L2		
D3906	AL2.W_L2		
D3907	AL2.D_L2		
D3908	AL2.L_L2		
D3909	AL3.T_L2		
D3910	AL3.W_L2		
D3911	AL3.D_L2		
D3912	AL3.L_L2		
D3913	AL4.T_L2		
D3914	AL4.W_L2		
D3915	AL4.D_L2		
D3916	AL4.L_L2		
D3917	AL5.T_L2		
D3918	AL5.W_L2		
D3919	AL5.D_L2		
D3920	AL5.L_L2		
D3921	AL6.T_L2		
D3922	AL6.W_L2		AL1.W_L1 to AL8.W_L1 0: Without Stand-by action 1: With Stand-by action
D3923	AL6.D_L2		
D3924	AL6.L_L2		AL1.D_L1 to AL8.D_L1 0: Alarm output: Energized 1: Alarm output: De-energized
D3925	AL7.T_L2		
D3926	AL7.W_L2		
D3927	AL7.D_L2		AL1.L_L1 to AL8.L_L1 0: OFF 1: Latch 1 2: Latch 2 3: Latch 3 4: Latch 4
D3928	AL7.L_L2		
D3929	AL8.T_L2		
D3930	AL8.W_L2		
D3931	AL8.D_L2		When the UTAdvanced parameter is set by key stroke, the alarm type, stand-by action, energized/de-energized, and latch comprise one parameter.
D3932	AL8.L_L2		
D3933	VT1_L2	0.01 to 99.59 (m.s)	
D3934	VT2_L2		
D3935	VT3_L2		
D3936	VT4_L2		
D3937	VT5_L2		
D3938	VT6_L2		
D3939	VT7_L2		
D3940	VT8_L2		

6.4 UT55A/UT52A/UP55A D Registers

Register No.	Description		Range and meaning of value
D3941	HY1_L2	Alarm-1 hysteresis	Set a display value of setpoint of hysteresis. -19999 to 30000 (Set a value within the input range.) Decimal point position depends on the input type.
D3942	HY2_L2	Alarm-2 hysteresis	
D3943	HY3_L2	Alarm-3 hysteresis	
D3944	HY4_L2	Alarm-4 hysteresis	
D3945	HY5_L2	Alarm-5 hysteresis	
D3946	HY6_L2	Alarm-6 hysteresis	
D3947	HY7_L2	Alarm-7 hysteresis	
D3948	HY8_L2	Alarm-8 hysteresis	
D3949	DYN1_L2	Alarm-1 On-delay timer	An alarm output is ON when the delay timer expires after the alarm setpoint is reached. 0.00 to 99.59 (m.s)
D3950	DYN2_L2	Alarm-2 On-delay timer	
D3951	DYN3_L2	Alarm-3 On-delay timer	
D3952	DYN4_L2	Alarm-4 On-delay timer	
D3953	DYN5_L2	Alarm-5 On-delay timer	
D3954	DYN6_L2	Alarm-6 On-delay timer	
D3955	DYN7_L2	Alarm-7 On-delay timer	
D3956	DYN8_L2	Alarm-8 On-delay timer	
D3957	DYF1_L2	Alarm-1 Off-delay timer	An alarm output is OFF when the delay timer expires after the alarm setpoint is reached. 0.00 to 99.59 (m.s)
D3958	DYF2_L2	Alarm-2 Off-delay timer	
D3959	DYF3_L2	Alarm-3 Off-delay timer	
D3960	DYF4_L2	Alarm-4 Off-delay timer	
D3961	DYF5_L2	Alarm-5 Off-delay timer	
D3962	DYF6_L2	Alarm-6 Off-delay timer	
D3963	DYF7_L2	Alarm-7 Off-delay timer	
D3964	DYF8_L2	Alarm-8 Off-delay timer	
D3965			
D3966	AMD_L2	Alarm mode	UT55A/UT52A 0: Always active 1: Not active in STOP mode 2: Not active in STOP or MAN mode UP55A 0: Always active 1: Not active in RESET mode 2: Not active in RESET or MAN mode
D3967 to D4000			

Loop-2 PV-related Setting (D4001 to D4100)

Register No.	Description		Range and meaning of value
D4001	BS_L2	PV input bias	-100.0 to 100.0% of PV input range span (EUS)
D4002	FL_L2	PV input filter	0: OFF (Disable) 1 to 120 s
D4003 to D4100			

6.4 UT55A/UT52A/UP55A D Registers

Loop-2 PID Setting of Groups 1 to 8 and R (D4101 to D4600)

Register No.	Description		Range and meaning of value
D4101	P_L2_1	Proportional band of group 1 Heating-side proportional band (in Heating/cooling control) of group 1	0.0 to 999.9% When 0.0% is set, it operates as 0.1%. Heating-side ON/OFF control applies when 0.0% in Heating/cooling control
D4102	I_L2_1	Integral time of group 1 Heating-side integral time (in Heating/cooling control) of group 1	0: OFF (Disable) 1 to 6000 s
D4103	D_L2_1	Derivative time of group 1 Heating-side derivative time (in Heating/cooling control) of group 1	0: OFF (Disable) 1 to 6000 s
D4104	OH_L2_1	Control output high limit of group 1 Heating-side control output high limit (in Heating/cooling control) of group 1	-4.9 to 105.0%, (OL<OH) In Heating/cooling control: 0.1 to 105.0% (OL<OH)
D4105	OL_L2_1	Control output low limit of group 1 Heating-side control output low limit (in Heating/cooling control) of group 1	-5.0 to 104.9%, (OL<OH), SD: Tight shut In Heating/cooling control: 0.0 to 104.9% (OL<OH)
D4106	MR_L2_1	Manual reset of group 1	Enabled when integral time is OFF. The manual reset value equals the output value when PV = SP. -5.0 to 105.0%
D4107	HYS_L2_1	Hysteresis (in Position proportional control) Heating-side ON/OFF control hysteresis (in Heating/cooling control)	In Heating/cooling control or Position proportional control: 0.0 to 100.0%
D4108 to D4110			
D4111	DR_L2_1	Direct/reverse action switch of group 1	0: RVS: Reverse action 1: DIR: Direct action
D4112			
D4113	Pc_L2_1	Cooling-side proportional band of group 1	0.0 to 999.9% (Cooling-side ON/OFF control applies when 0.0% in Heating/cooling control)
D4114	Ic_L2_1	Cooling-side integral time of group 1	0: OFF (Disable) 1 to 6000 s
D4115	Dc_L2_1	Cooling-side derivative time of group 1	0: OFF (Disable) 1 to 6000 s
D4116	OHc_L2_1	Cooling-side control output high limit of group 1	0.1 to 105.0%, (OLc<OHc)
D4117	OLc_L2_1	Cooling-side control output low limit of group 1	0.0 to 104.9%, (OLc<OHc)
D4118	HYSc_L2_1	Cooling-side ON/OFF control hysteresis of group 1	0.0 to 100.0%
D4119	DB_L2_1	Output dead band (in Heating/cooling control or Position proportional control)	In Heating/cooling control: -100.0 to 50.0% In Position proportional control: 1.0 to 10.0%
D4120	PO_L2_1	Preset output of group 1 Heating-side preset output (in Heating/cooling control) of group 1	In STOP mode, fixed control output can be generated. In Position proportional control, Valve opening can be set -5.0 to 105.0%
D4121			
D4122	POc_L2_1	Cooling-side preset output of group 1	In STOP mode, cooling-side fixed control output can be generated. -5.0 to 105.0%
D4123 to D4450			

Register No.	Description		Range and meaning of value
D4151 to D4172	P_L2_2 to POc_L2_2	Proportional band of group 2 Heating-side proportional band (in Heating/cooling control) of group 2 to Cooling-side preset output of group 2	Same as D4101 to D4122
D4173 to D4200			
D4201 to D4222	P_L2_3 to POc_L2_3	Proportional band of group 3 Heating-side proportional band (in Heating/cooling control) of group 3 to Cooling-side preset output of group 3	Same as D4101 to D4122
D4223 to D4250			
D4251 to D4272	P_L2_4 to POc_L2_4	Proportional band of group 4 Heating-side proportional band (in Heating/cooling control) of group 4 to Cooling-side preset output of group 4	Same as D4101 to D4122
D4273 to D4300			
D4301 to D4322	P_L2_5 to POc_L2_5	Proportional band of group 5 Heating-side proportional band (in Heating/cooling control) of group 5 to Cooling-side preset output of group 5	Same as D4101 to D4122
D4323 to D4350			
D4351 to D4372	P_L2_6 to POc_L2_6	Proportional band of group 6 Heating-side proportional band (in Heating/cooling control) of group 6 to Cooling-side preset output of group 6	Same as D4101 to D4122
D4373 to D4400			
D4401 to D4422	P_L2_7 to POc_L2_7	Proportional band of group 7 Heating-side proportional band (in Heating/cooling control) of group 7 to Cooling-side preset output of group 7	Same as D4101 to D4122
D4423 to D4450			
D4451 to D4472	P_L2_8 to POc_L2_8	Proportional band of group 8 Heating-side proportional band (in Heating/cooling control) of group 8 to Cooling-side preset output of group 8	Same as D4101 to D4122
D4473 to D4500			
D4501 to D4522	P_L2_R to POc_L2_R	Proportional band of group R Heating-side proportional band (in Heating/cooling control) of group R to Cooling-side preset output of group R	Same as D4101 to D4122
D4523 to D4600			

6.4 UT55A/UT52A/UP55A D Registers

Loop-2 Control Action-related Setting (D4601 to D4700)

Register No.	Description		Range and meaning of value
D4601	SC_L2	Super function	0: OFF (Disable) 1: Overshoot suppressing function (normal mode) 2: Hunting suppressing function (stable mode) Enables to answer the wider characteristic changes compared with response mode. 3: Hunting suppressing function (response mode) Enables quick follow-up and short converging time of PV for the changed SP. 4: Overshoot suppressing function (strong suppressing mode) Note: Setpoints 2 and 3 must be used in PID control or PI control. Disabled in the following controls: 1) ON/OFF control, 2) PD control, 3) P control, 4) Heating/cooling control Do not use the function for the control processes with response such as flow or pressure control.
D4602			
D4603	AT.TY_L2	Auto-tuning type	0: Normal, 1: Stability
D4604	AT.OH_L2	Output high limit in auto-tuning	-5.0 to 105.0% (Disabled in Heating/cooling control)
D4605	AT.OL_L2	Output low limit in auto-tuning	
D4606	AT.BS_L2	SP bias in auto-tuning	-100.0 to 100.0% of PV input range span (EUS)
D4607 to D4612			
D4613	GW_L2	Non-linear control gap width	0: OFF 0.0+1digit to 50.0% of PV input range span (EUS)
D4614	GG_L2	Non-linear control gain	0.001 to 1.000
D4615 to D4625			
D4626	AR_L2	Anti-reset windup (excess integration prevention)	0: AUTO, 50.0 to 200.0%
D4627	OPR_L2	Output velocity limiter	0: OFF (Disable), 0.1 to 100.0%/s
D4628	OLMT_L2	Output limiter switch	0: OFF (Disable output limiter in MAN mode) 1: ON (Enable output limiter in MAN mode)
D4629 to D4630			
D4631	MPON_L2	Manual preset output number selection	Select the output used in MAN mode when switched from AUTO to MAN mode. 0: OFF (Hold the control output in AUTO mode (bumpless)) 1: Use manual preset output 1 (output bump) 2: Use manual preset output 2 (output bump) 3: Use manual preset output 3 (output bump) 4: Use manual preset output 4 (output bump) 5: Use manual preset output 5 (output bump)
D4632	MPO1_L2	Manual preset output 1	-5.0 to 105.0%
D4633	MPO2_L2	Manual preset output 2	
D4634	MPO3_L2	Manual preset output 3	
D4635	MPO4_L2	Manual preset output 4	
D4636	MPO5_L2	Manual preset output 5	
D4637 to D4652			
D4653	RP1_L2	Reference point 1	0.0 to 100.0% of PV input range (EU) (RP1 ≤ RP2 ≤ RP3 ≤ RP4 ≤ RP5 ≤ RP6 ≤ RP7)
D4654	RP2_L2	Reference point 2	
D4655	RP3_L2	Reference point 3	
D4656	RP4_L2	Reference point 4	
D4657	RP5_L2	Reference point 5	
D4658	RP6_L2	Reference point 6	
D4659	RP7_L2	Reference point 7	
D4660	RHY_L2	Zone PID switching hysteresis	0.0 to 10.0% of PV input range span (EUS)
D4661	RDV_L2	Reference deviation	0: OFF (Disable) 0.0 + 1 digit to 100.0% of PV input range span (EUS)
D4662 to D4700			

6.4.5 P Parameter (D4701 to D4800)

P parameter													
P parameter (Menu: PPAR)													
D-Reg No.	Ref. No.	H No.	Register symbol	R/W			D-Reg No.	Ref. No.	H No.	Register symbol	R/W		
				UT 55A	UT 52A	UP 55A					UT 55A	UT 52A	UP 55A
D4701	44701	125C	P01D	R/W	R/W	R/W	D4751	44751	128E				
D4702	44702	125D	P02D	R/W	R/W	R/W	D4752	44752	128F				
D4703	44703	125E	P03D	R/W	R/W	R/W	D4753	44753	1290				
D4704	44704	125F	P04D	R/W	R/W	R/W	D4754	44754	1291				
D4705	44705	1260	P05D	R/W	R/W	R/W	D4755	44755	1292				
D4706	44706	1261	P06D	R/W	R/W	R/W	D4756	44756	1293				
D4707	44707	1262	P07D	R/W	R/W	R/W	D4757	44757	1294				
D4708	44708	1263	P08D	R/W	R/W	R/W	D4758	44758	1295				
D4709	44709	1264	P09D	R/W	R/W	R/W	D4759	44759	1296				
D4710	44710	1265	P10D	R/W	R/W	R/W	D4760	44760	1297				
D4711	44711	1266					D4761	44761	1298				
D4712	44712	1267					D4762	44762	1299				
D4713	44713	1268					D4763	44763	129A				
D4714	44714	1269					D4764	44764	129B				
D4715	44715	126A					D4765	44765	129C				
D4716	44716	126B					D4766	44766	129D				
D4717	44717	126C					D4767	44767	129E				
D4718	44718	126D					D4768	44768	129F				
D4719	44719	126E					D4769	44769	12A0				
D4720	44720	126F					D4770	44770	12A1				
D4721	44721	1270	P01	R/W	R/W	R/W	D4771	44771	12A2				
D4722	44722	1271	P02	R/W	R/W	R/W	D4772	44772	12A3				
D4723	44723	1272	P03	R/W	R/W	R/W	D4773	44773	12A4				
D4724	44724	1273	P04	R/W	R/W	R/W	D4774	44774	12A5				
D4725	44725	1274	P05	R/W	R/W	R/W	D4775	44775	12A6				
D4726	44726	1275	P06	R/W	R/W	R/W	D4776	44776	12A7				
D4727	44727	1276	P07	R/W	R/W	R/W	D4777	44777	12A8				
D4728	44728	1277	P08	R/W	R/W	R/W	D4778	44778	12A9				
D4729	44729	1278	P09	R/W	R/W	R/W	D4779	44779	12AA				
D4730	44730	1279	P10	R/W	R/W	R/W	D4780	44780	12AB				
D4731	44731	127A					D4781	44781	12AC				
D4732	44732	127B					D4782	44782	12AD				
D4733	44733	127C					D4783	44783	12AE				
D4734	44734	127D					D4784	44784	12AF				
D4735	44735	127E					D4785	44785	12B0				
D4736	44736	127F					D4786	44786	12B1				
D4737	44737	1280					D4787	44787	12B2				
D4738	44738	1281					D4788	44788	12B3				
D4739	44739	1282					D4789	44789	12B4				
D4740	44740	1283					D4790	44790	12B5				
D4741	44741	1284					D4791	44791	12B6				
D4742	44742	1285					D4792	44792	12B7				
D4743	44743	1286					D4793	44793	12B8				
D4744	44744	1287					D4794	44794	12B9				
D4745	44745	1288					D4795	44795	12BA				
D4746	44746	1289					D4796	44796	12BB				
D4747	44747	128A					D4797	44797	12BC				
D4748	44748	128B					D4798	44798	12BD				
D4749	44749	128C					D4799	44799	12BE				
D4750	44750	128D					D4800	44800	12BF				

6.4 UT55A/UT52A/UP55A D Registers

P parameter (D4701 to D4800)

Register No.	Description	Range and meaning of value
D4701	P01D	0: No decimal place 1: One decimal place 2: Two decimal places 3: Three decimal places 4: Four decimal places
D4702	P02D	
D4703	P03D	
D4704	P04D	
D4705	P05D	
D4706	P06D	
D4707	P07D	
D4708	P08D	
D4709	P09D	
D4710	P10D	
D4711 to D4720		
D4721	P01	-19999 to 30000 (Set a decimal point position using LL50A Parameter Setting Software.)
D4722	P02	
D4723	P03	
D4724	P04	
D4725	P05	
D4726	P06	
D4727	P07	
D4728	P08	
D4729	P09	
D4730	P10	
D4731 to D4800		

6.4.6 10-segment Linearizer Setting Parameter (D4801 to D5000)

10-segment linearizer setting parameter													
10-segment inearizer setting (Menu: PYS1, PYS2, PYS3)													
D-Reg No.	Ref. No.	H No.	Register symbol	R/W			D-Reg No.	Ref. No.	H No.	Register symbol	R/W		
				UT 55A	UT 52A	UP 55A					UT 55A	UT 52A	UP 55A
D4801	44801	12C0	PYS_1	R/W	R/W	R/W	D4851	44851	12F2	B10_2			
D4802	44802	12C1	A1_1	R/W	R/W	R/W	D4852	44852	12F3	A11_2	R/W	R/W	R/W
D4803	44803	12C2	B1_1	R/W	R/W	R/W	D4853	44853	12F4	B11_2	R/W	R/W	R/W
D4804	44804	12C3	A2_1	R/W	R/W	R/W	D4854	44854	12F5	PMD_2	R/W	R/W	R/W
D4805	44805	12C4	B2_1	R/W	R/W	R/W	D4855	44855	12F6				
D4806	44806	12C5	A3_1	R/W	R/W	R/W	D4856	44856	12F7				
D4807	44807	12C6	B3_1	R/W	R/W	R/W	D4857	44857	12F8				
D4808	44808	12C7	A4_1	R/W	R/W	R/W	D4858	44858	12F9				
D4809	44809	12C8	B4_1	R/W	R/W	R/W	D4859	44859	12FA				
D4810	44810	12C9	A5_1	R/W	R/W	R/W	D4860	44860	12FB				
D4811	44811	12CA	B5_1	R/W	R/W	R/W	D4861	44861	12FC	PYS_3	R/W	R/W	R/W
D4812	44812	12CB	A6_1	R/W	R/W	R/W	D4862	44862	12FD	A1_3	R/W	R/W	R/W
D4813	44813	12CC	B6_1	R/W	R/W	R/W	D4863	44863	12FE	B1_3	R/W	R/W	R/W
D4814	44814	12CD	A7_1	R/W	R/W	R/W	D4864	44864	12FF	A2_3	R/W	R/W	R/W
D4815	44815	12CE	B7_1	R/W	R/W	R/W	D4865	44865	1300	B2_3	R/W	R/W	R/W
D4816	44816	12CF	A8_1	R/W	R/W	R/W	D4866	44866	1301	A3_3	R/W	R/W	R/W
D4817	44817	12D0	B8_1	R/W	R/W	R/W	D4867	44867	1302	B3_3	R/W	R/W	R/W
D4818	44818	12D1	A9_1	R/W	R/W	R/W	D4868	44868	1303	A4_3	R/W	R/W	R/W
D4819	44819	12D2	B9_1	R/W	R/W	R/W	D4869	44869	1304	B4_3	R/W	R/W	R/W
D4820	44820	12D3	A10_1	R/W	R/W	R/W	D4870	44870	1305	A5_3	R/W	R/W	R/W
D4821	44821	12D4	B10_1	R/W	R/W	R/W	D4871	44871	1306	B5_3	R/W	R/W	R/W
D4822	44822	12D5	A11_1	R/W	R/W	R/W	D4872	44872	1307	A6_3	R/W	R/W	R/W
D4823	44823	12D6	B11_1	R/W	R/W	R/W	D4873	44873	1308	B6_3	R/W	R/W	R/W
D4824	44824	12D7	PMD_1	R/W	R/W	R/W	D4874	44874	1309	A7_3	R/W	R/W	R/W
D4825	44825	12D8					D4875	44875	130A	B7_3	R/W	R/W	R/W
D4826	44826	12D9					D4876	44876	130B	A8_3	R/W	R/W	R/W
D4827	44827	12DA					D4877	44877	130C	B8_3	R/W	R/W	R/W
D4828	44828	12DB					D4878	44878	130D	A9_3	R/W	R/W	R/W
D4829	44829	12DC					D4879	44879	130E	B9_3	R/W	R/W	R/W
D4830	44830	12DD					D4880	44880	130F	A10_3	R/W	R/W	R/W
D4831	44831	12DE	PYS_2	R/W	R/W	R/W	D4881	44881	1310	B10_3	R/W	R/W	R/W
D4832	44832	12DF	A1_2	R/W	R/W	R/W	D4882	44882	1311	A11_3	R/W	R/W	R/W
D4833	44833	12E0	B1_2	R/W	R/W	R/W	D4883	44883	1312	B11_3	R/W	R/W	R/W
D4834	44834	12E1	A2_2	R/W	R/W	R/W	D4884	44884	1313	PMD_3	R/W	R/W	R/W
D4835	44835	12E2	B2_2	R/W	R/W	R/W	D4885	44885	1314				
D4836	44836	12E3	A3_2	R/W	R/W	R/W	D4886	44886	1315				
D4837	44837	12E4	B3_2	R/W	R/W	R/W	D4887	44887	1316				
D4838	44838	12E5	A4_2	R/W	R/W	R/W	D4888	44888	1317				
D4839	44839	12E6	B4_2	R/W	R/W	R/W	D4889	44889	1318				
D4840	44840	12E7	A5_2	R/W	R/W	R/W	D4890	44890	1319				
D4841	44841	12E8	B5_2	R/W	R/W	R/W	D4891	44891	131A				
D4842	44842	12E9	A6_2	R/W	R/W	R/W	D4892	44892	131B				
D4843	44843	12EA	B6_2	R/W	R/W	R/W	D4893	44893	131C				
D4844	44844	12EB	A7_2	R/W	R/W	R/W	D4894	44894	131D				
D4845	44845	12EC	B7_2	R/W	R/W	R/W	D4895	44895	131E				
D4846	44846	12ED	A8_2	R/W	R/W	R/W	D4896	44896	131F				
D4847	44847	12EE	B8_2	R/W	R/W	R/W	D4897	44897	1320				
D4848	44848	12EF	A9_2	R/W	R/W	R/W	D4898	44898	1321				
D4849	44849	12F0	B9_2	R/W	R/W	R/W	D4899	44899	1322				
D4850	44850	12F1	A10_2	R/W	R/W	R/W	D4900	44900	1323				

6.4 UT55A/UT52A/UP55A D Registers

10-segment linearizer setting parameter													
10-segment linearizer setting (Menu: PYS4)													
D-Reg No.	Ref. No.	H No.	Register symbol	R/W			D-Reg No.	Ref. No.	H No.	Register symbol	R/W		
				UT 55A	UT 52A	UP 55A					UT 55A	UT 52A	UP 55A
D4901	44901	1324	PYS_4	R/W	R/W	R/W	D4951	44951	1356				
D4902	44902	1325	A1_4	R/W	R/W	R/W	D4952	44952	1357				
D4903	44903	1326	B1_4	R/W	R/W	R/W	D4953	44953	1358				
D4904	44904	1327	A2_4	R/W	R/W	R/W	D4954	44954	1359				
D4905	44905	1328	B2_4	R/W	R/W	R/W	D4955	44955	135A				
D4906	44906	1329	A3_4	R/W	R/W	R/W	D4956	44956	135B				
D4907	44907	132A	B3_4	R/W	R/W	R/W	D4957	44957	135C				
D4908	44908	132B	A4_4	R/W	R/W	R/W	D4958	44958	135D				
D4909	44909	132C	B4_4	R/W	R/W	R/W	D4959	44959	135E				
D4910	44910	132D	A5_4	R/W	R/W	R/W	D4960	44960	135F				
D4911	44911	132E	B5_4	R/W	R/W	R/W	D4961	44961	1360				
D4912	44912	132F	A6_4	R/W	R/W	R/W	D4962	44962	1361				
D4913	44913	1330	B6_4	R/W	R/W	R/W	D4963	44963	1362				
D4914	44914	1331	A7_4	R/W	R/W	R/W	D4964	44964	1363				
D4915	44915	1332	B7_4	R/W	R/W	R/W	D4965	44965	1364				
D4916	44916	1333	A8_4	R/W	R/W	R/W	D4966	44966	1365				
D4917	44917	1334	B8_4	R/W	R/W	R/W	D4967	44967	1366				
D4918	44918	1335	A9_4	R/W	R/W	R/W	D4968	44968	1367				
D4919	44919	1336	B9_4	R/W	R/W	R/W	D4969	44969	1368				
D4920	44920	1337	A10_4	R/W	R/W	R/W	D4970	44970	1369				
D4921	44921	1338	B10_4	R/W	R/W	R/W	D4971	44971	136A				
D4922	44922	1339	A11_4	R/W	R/W	R/W	D4972	44972	136B				
D4923	44923	133A	B11_4	R/W	R/W	R/W	D4973	44973	136C				
D4924	44924	133B	PMD_4	R/W	R/W	R/W	D4974	44974	136D				
D4925	44925	133C					D4975	44975	136E				
D4926	44926	133D					D4976	44976	136F				
D4927	44927	133E					D4977	44977	1370				
D4928	44928	133F					D4978	44978	1371				
D4929	44929	1340					D4979	44979	1372				
D4930	44930	1341					D4980	44980	1373				
D4931	44931	1342					D4981	44981	1374				
D4932	44932	1343					D4982	44982	1375				
D4933	44933	1344					D4983	44983	1376				
D4934	44934	1345					D4984	44984	1377				
D4935	44935	1346					D4985	44985	1378				
D4936	44936	1347					D4986	44986	1379				
D4937	44937	1348					D4987	44987	137A				
D4938	44938	1349					D4988	44988	137B				
D4939	44939	134A					D4989	44989	137C				
D4940	44940	134B					D4990	44990	137D				
D4941	44941	134C					D4991	44991	137E				
D4942	44942	134D					D4992	44992	137F				
D4943	44943	134E					D4993	44993	1380				
D4944	44944	134F					D4994	44994	1381				
D4945	44945	1350					D4995	44995	1382				
D4946	44946	1351					D4996	44996	1383				
D4947	44947	1352					D4997	44997	1384				
D4948	44948	1353					D4998	44998	1385				
D4949	44949	1354					D4999	44999	1386				
D4950	44950	1355					D5000	45000	1387				

10-segment Linearizer Setting (D4801 to D5000)

Register No.	Description		Range and meaning of value
D4801	PYS_1	10-segment linearizer selection of group 1	0: OFF (Disable) 1: PV (PV analog input) 2: RSP (RSP analog input) 3: AIN2 (AIN2 analog input) 4: AIN4 (AIN4 analog input) 5: PVIN (PV input) 6: OUT (OUT analog output) 7: OUT2 (OUT2 analog output) 8: RET (RET analog output)
D4802	A1_1	10-segment linearizer input 1 of group 1	A1_1 to A11_1 -66.7 to 105.0% of input range (EU) Output linearizer: -5.0 to 105.0% B1_1 to B11_1 10-segment linearizer bias: -66.7 to 105.0% of input range span (EUS) 10-segment linearizer approximation: -66.7 to 105.0% of input range (EU) Output linearizer: -5.0 to 105.0%
D4803	B1_1	10-segment linearizer output 1 of group 1	
D4804	A2_1	10-segment linearizer input 2 of group 1	
D4805	B2_1	10-segment linearizer output 2 of group 1	
D4806	A3_1	10-segment linearizer input 3 of group 1	
D4807	B3_1	10-segment linearizer output 3 of group 1	
D4808	A4_1	10-segment linearizer input 4 of group 1	
D4809	B4_1	10-segment linearizer output 4 of group 1	
D4810	A5_1	10-segment linearizer input 5 of group 1	
D4811	B5_1	10-segment linearizer output 5 of group 1	
D4812	A6_1	10-segment linearizer input 6 of group 1	
D4813	B6_1	10-segment linearizer output 6 of group 1	
D4814	A7_1	10-segment linearizer input 7 of group 1	
D4815	B7_1	10-segment linearizer output 7 of group 1	
D4816	A8_1	10-segment linearizer input 8 of group 1	
D4817	B8_1	10-segment linearizer output 8 of group 1	
D4818	A9_1	10-segment linearizer input 9 of group 1	
D4819	B9_1	10-segment linearizer output 9 of group 1	
D4820	A10_1	10-segment linearizer input 10 of group 1	
D4821	B10_1	10-segment linearizer output 10 of group 1	
D4822	A11_1	10-segment linearizer input 11 of group 1	
D4823	B11_1	10-segment linearizer output 11 of group 1	
D4824	PMD_1	10-segment linearizer mode of group 1	0: 10-segment linearizer bias 1: 10-segment linearizer approximation
D4825 to D4830			
D4831	PYS_2	10-segment linearizer selection of group 2	Same as D4801
D4832 to D4853	A1_2 to B11_2	10-segment linearizer input 1 of group 2 to 10-segment linearizer output 11 of group 2	Same as D4802 to D4823
D4854	PMD_2	10-segment linearizer mode of group 2	Same as D4824
D4855 to D4860			
D4861	PYS_3	10-segment linearizer selection of group 3	Same as D4801
D4862 to D4883	A1_3 to B11_3	10-segment linearizer input 1 of group 3 to 10-segment linearizer output 11 of group 3	Same as D4802 to D4823
D4884	PMD_3	10-segment linearizer mode of group 3	Same as D4824
D4885 to D4890			
D4891	PYS_4	10-segment linearizer selection of group 4	Same as D4801
D4892 to D4913	A1_4 to B11_4	10-segment linearizer input 1 of group 4 to 10-segment linearizer output 11 of group 4	Same as D4802 to D4823
D4914	PMD_4	10-segment linearizer mode of group 4	Same as D4824
D4915 to D5000			

6.4 UT55A/UT52A/UP55A D Registers

6.4.7 Setup Parameters (D5001 to D7000)

Setup parameter													
Control function setting (Menu: CTL)													
D-Reg No.	Ref. No.	H No.	Register symbol	R/W			D-Reg No.	Ref. No.	H No.	Register symbol	R/W		
				UT 55A	UT 52A	UP 55A					UT 55A	UT 52A	UP 55A
D5001	45001	1388	CTLM	R/W			D5051	45051	13BA				
D5002	45002	1389					D5052	45052	13BB				
D5003	45003	138A	CNT_L1	R/W	R/W	R/W	D5053	45053	13BC				
D5004	45004	138B	CNT_L2	R/W	R/W	R/W	D5054	45054	13BD				
D5005	45005	138C	ALG_L1	R/W	R/W	R/W	D5055	45055	13BE				
D5006	45006	138D	ALG_L2	R/W	R/W	R/W	D5056	45056	13BF				
D5007	45007	138E	SPGR.	R/W	R/W		D5057	45057	13C0				
D5008	45008	138F					D5058	45058	13C1				
D5009	45009	1390	ALNO_L1	R/W	R/W	R/W	D5059	45059	13C2				
D5010	45010	1391	ALNO_L2	R/W	R/W	R/W	D5060	45060	13C3				
D5011	45011	1392					D5061	45061	13C4				
D5012	45012	1393	ZON	R/W	R/W	R/W	D5062	45062	13C5				
D5013	45013	1394					D5063	45063	13C6				
D5014	45014	1395	PIDG.	R/W	R/W		D5064	45064	13C7				
D5015	45015	1396					D5065	45065	13C8				
D5016	45016	1397	SEG.T			R/W	D5066	45066	13C9				
D5017	45017	1398	TMU			R/W	D5067	45067	13CA				
D5018	45018	1399	PT2.G			R/W	D5068	45068	13CB				
D5019	45019	139A	SMP	R/W	R/W	R/W	D5069	45069	13CC				
D5020	45020	139B					D5070	45070	13CD				
D5021	45021	139C					D5071	45071	13CE				
D5022	45022	139D					D5072	45072	13CF				
D5023	45023	139E					D5073	45073	13D0				
D5024	45024	139F					D5074	45074	13D1				
D5025	45025	13A0					D5075	45075	13D2				
D5026	45026	13A1					D5076	45076	13D3				
D5027	45027	13A2					D5077	45077	13D4				
D5028	45028	13A3					D5078	45078	13D5				
D5029	45029	13A4					D5079	45079	13D6				
D5030	45030	13A5					D5080	45080	13D7				
D5031	45031	13A6					D5081	45081	13D8				
D5032	45032	13A7					D5082	45082	13D9				
D5033	45033	13A8					D5083	45083	13DA				
D5034	45034	13A9					D5084	45084	13DB				
D5035	45035	13AA					D5085	45085	13DC				
D5036	45036	13AB					D5086	45086	13DD				
D5037	45037	13AC					D5087	45087	13DE				
D5038	45038	13AD					D5088	45088	13DF				
D5039	45039	13AE					D5089	45089	13E0				
D5040	45040	13AF					D5090	45090	13E1				
D5041	45041	13B0					D5091	45091	13E2				
D5042	45042	13B1					D5092	45092	13E3				
D5043	45043	13B2					D5093	45093	13E4				
D5044	45044	13B3					D5094	45094	13E5				
D5045	45045	13B4					D5095	45095	13E6				
D5046	45046	13B5					D5096	45096	13E7				
D5047	45047	13B6					D5097	45097	13E8				
D5048	45048	13B7					D5098	45098	13E9				
D5049	45049	13B8					D5099	45099	13EA				
D5050	45050	13B9					D5100	45100	13EB				

6.4 UT55A/UT52A/UP55A D Registers

Setup parameter													
Input setting (PV input setting menu: PV) (RSP input setting menu: RSP)													
D-Reg No.	Ref. No.	H No.	Register symbol	R/W			D-Reg No.	Ref. No.	H No.	Register symbol	R/W		
				UT 55A	UT 52A	UP 55A					UT 55A	UT 52A	UP 55A
D5101	45101	13EC	IN	R/W	R/W	R/W	D5151	45151	141E				
D5102	45102	13ED	UNIT	R/W	R/W	R/W	D5152	45152	141F	A.BS_E2	R/W		
D5103	45103	13EE	DP	R	R	R	D5153	45153	1420	A.FL_E2	R/W		
D5104	45104	13EF	RH	R/W	R/W	R/W	D5154	45154	1421	A.SR_E2	R/W		
D5105	45105	13F0	RL	R/W	R/W	R/W	D5155	45155	1422	A.LC_E2	R/W		
D5106	45106	13F1	SDP	R/W	R/W	R/W	D5156	45156	1423				
D5107	45107	13F2	SH	R/W	R/W	R/W	D5157	45157	1424	DI6.D_E2	R/W		
D5108	45108	13F3	SL	R/W	R/W	R/W	D5158	45158	1425				
D5109	45109	13F4	BSL	R/W	R/W	R/W	D5159	45159	1426				
D5110	45110	13F5	RJC	R/W	R/W	R/W	D5160	45160	1427				
D5111	45111	13F6	ERJC	R/W	R/W	R/W	D5161	45161	1428				
D5112	45112	13F7	A.BS	R/W	R/W	R/W	D5162	45162	1429				
D5113	45113	13F8	A.FL	R/W	R/W	R/W	D5163	45163	142A				
D5114	45114	13F9	A.SR	R/W	R/W	R/W	D5164	45164	142B				
D5115	45115	13FA	A.LC	R/W	R/W	R/W	D5165	45165	142C				
D5116	45116	13FB					D5166	45166	142D				
D5117	45117	13FC					D5167	45167	142E				
D5118	45118	13FD					D5168	45168	142F				
D5119	45119	13FE					D5169	45169	1430				
D5120	45120	13FF					D5170	45170	1431				
D5121	45121	1400	IN_E1	R/W	R/W	R/W	D5171	45171	1432				
D5122	45122	1401	UNIT_E1	R/W	R/W	R/W	D5172	45172	1433				
D5123	45123	1402	DP_E1	R	R	R	D5173	45173	1434				
D5124	45124	1403	RH_E1	R/W	R/W	R/W	D5174	45174	1435				
D5125	45125	1404	RL_E1	R/W	R/W	R/W	D5175	45175	1436				
D5126	45126	1405	SDP_E1	R/W	R/W	R/W	D5176	45176	1437				
D5127	45127	1406	SH_E1	R/W	R/W	R/W	D5177	45177	1438				
D5128	45128	1407	SL_E1	R/W	R/W	R/W	D5178	45178	1439				
D5129	45129	1408	BSL_E1	R/W	R/W	R/W	D5179	45179	143A				
D5130	45130	1409	RJC_E1	R/W	R/W	R/W	D5180	45180	143B				
D5131	45131	140A	ERJC_E1	R/W	R/W	R/W	D5181	45181	143C	IN_E4	R/W		
D5132	45132	140B	RTD.S_E1	R/W	R/W	R/W	D5182	45182	143D	UNIT_E4	R/W		
D5133	45133	140C	A.BS_E1	R/W	R/W	R/W	D5183	45183	143E	DP_E4	R		
D5134	45134	140D	A.FL_E1	R/W	R/W	R/W	D5184	45184	143F	RH_E4	R/W		
D5135	45135	140E	A.SR_E1	R/W	R/W	R/W	D5185	45185	1440	RL_E4	R/W		
D5136	45136	140F	A.LC_E1	R/W	R/W	R/W	D5186	45186	1441	SDP_E4	R/W		
D5137	45137	1410	DI6.D_E1	R/W	R/W	R/W	D5187	45187	1442	SH_E4	R/W		
D5138	45138	1411					D5188	45188	1443	SL_E4	R/W		
D5139	45139	1412					D5189	45189	1444	BSL_E4	R/W		
D5140	45140	1413					D5190	45190	1445				
D5141	45141	1414	IN_E2	R/W			D5191	45191	1446				
D5142	45142	1415	UNIT_E2	R/W			D5192	45192	1447	A.BS_E4	R/W		
D5143	45143	1416	DP_E2	R			D5193	45193	1448	A.FL_E4	R/W		
D5144	45144	1417	RH_E2	R/W			D5194	45194	1449	A.SR_E4	R/W		
D5145	45145	1418	RL_E2	R/W			D5195	45195	144A	A.LC_E4	R/W		
D5146	45146	1419	SDP_E2	R/W			D5196	45196	144B				
D5147	45147	141A	SH_E2	R/W			D5197	45197	144C	DI6.D_E4	R/W		
D5148	45148	141B	SL_E2	R/W			D5198	45198	144D				
D5149	45149	141C	BSL_E2	R/W			D5199	45199	144E				
D5150	45150	141D					D5200	45200	144F				

6.4 UT55A/UT52A/UP55A D Registers

Setup parameter													
Input setting (Input range·SP limiter/input switch/input auto-selector setting parameters menu: MPV)													
D-Reg No.	Ref. No.	H No.	Register symbol	R/W			D-Reg No.	Ref. No.	H No.	Register symbol	R/W		
				UT 55A	UT 52A	UP 55A					UT 55A	UT 52A	UP 55A
D5201	45201	1450	P.UNI_L1	R/W	R/W	R/W	D5251	45251	1482				
D5202	45202	1451	P.DP_L1	R/W	R/W	R/W	D5252	45252	1483				
D5203	45203	1452	P.RH_L1	R/W	R/W	R/W	D5253	45253	1484				
D5204	45204	1453	P.RL_L1	R/W	R/W	R/W	D5254	45254	1485				
D5205	45205	1454	PV.HL	R/W	R/W	R/W	D5255	45255	1486				
D5206	45206	1455	PV.LL	R/W	R/W	R/W	D5256	45256	1487				
D5207	45207	1456	PV.2C	R/W	R/W	R/W	D5257	45257	1488				
D5208	45208	1457	PV.AS	R/W	R/W	R/W	D5258	45258	1489				
D5209	45209	1458	PV.NU	R/W	R/W	R/W	D5259	45259	148A				
D5210	45210	1459	SPH_L1	R/W	R/W	R/W	D5260	45260	148B				
D5211	45211	145A	SPL_L1	R/W	R/W	R/W	D5261	45261	148C				
D5212	45212	145B					D5262	45262	148D				
D5213	45213	145C					D5263	45263	148E				
D5214	45214	145D					D5264	45264	148F				
D5215	45215	145E					D5265	45265	1490				
D5216	45216	145F					D5266	45266	1491				
D5217	45217	1460					D5267	45267	1492				
D5218	45218	1461					D5268	45268	1493				
D5219	45219	1462					D5269	45269	1494				
D5220	45220	1463					D5270	45270	1495				
D5221	45221	1464	P.UNI_L2	R/W	R/W	R/W	D5271	45271	1496				
D5222	45222	1465	P.DP_L2	R/W	R/W	R/W	D5272	45272	1497				
D5223	45223	1466	P.RH_L2	R/W	R/W	R/W	D5273	45273	1498				
D5224	45224	1467	P.RL_L2	R/W	R/W	R/W	D5274	45274	1499				
D5225	45225	1468					D5275	45275	149A				
D5226	45226	1469					D5276	45276	149B				
D5227	45227	146A					D5277	45277	149C				
D5228	45228	146B					D5278	45278	149D				
D5229	45229	146C					D5279	45279	149E				
D5230	45230	146D	SPH_L2	R/W	R/W	R/W	D5280	45280	149F				
D5231	45231	146E	SPL_L2	R/W	R/W	R/W	D5281	45281	14A0				
D5232	45232	146F					D5282	45282	14A1				
D5233	45233	1470					D5283	45283	14A2				
D5234	45234	1471					D5284	45284	14A3				
D5235	45235	1472					D5285	45285	14A4				
D5236	45236	1473					D5286	45286	14A5				
D5237	45237	1474					D5287	45287	14A6				
D5238	45238	1475					D5288	45288	14A7				
D5239	45239	1476					D5289	45289	14A8				
D5240	45240	1477					D5290	45290	14A9				
D5241	45241	1478					D5291	45291	14AA				
D5242	45242	1479					D5292	45292	14AB				
D5243	45243	147A					D5293	45293	14AC				
D5244	45244	147B					D5294	45294	14AD				
D5245	45245	147C					D5295	45295	14AE				
D5246	45246	147D					D5296	45296	14AF				
D5247	45247	147E					D5297	45297	14B0				
D5248	45248	147F					D5298	45298	14B1				
D5249	45249	1480					D5299	45299	14B2				
D5250	45250	1481					D5300	45300	14B3				

Setup parameter													
Output setting (Menu: OUT)													
D-Reg No.	Ref. No.	H No.	Register symbol	R/W			D-Reg No.	Ref. No.	H No.	Register symbol	R/W		
				UT 55A	UT 52A	UP 55A					UT 55A	UT 52A	UP 55A
D5301	45301	14B4	OT.H	R/W	R/W	R/W	D5351	45351	14E6				
D5302	45302	14B5	OT.C	R/W	R/W	R/W	D5352	45352	14E7				
D5303	45303	14B6	CT	R/W	R/W	R/W	D5353	45353	14E8				
D5304	45304	14B7	CTc	R/W	R/W	R/W	D5354	45354	14E9				
D5305	45305	14B8					D5355	45355	14EA				
D5306	45306	14B9					D5356	45356	14EB				
D5307	45307	14BA					D5357	45357	14EC				
D5308	45308	14BB					D5358	45358	14ED				
D5309	45309	14BC					D5359	45359	14EE				
D5310	45310	14BD					D5360	45360	14EF				
D5311	45311	14BE	V.AT	R/W	R/W	R/W	D5361	45361	14F0				
D5312	45312	14BF	V.RS	R/W	R/W	R/W	D5362	45362	14F1				
D5313	45313	14C0	V.L	R	R	R	D5363	45363	14F2				
D5314	45314	14C1	V.H	R	R	R	D5364	45364	14F3				
D5315	45315	14C2	TR.T	R/W	R/W	R/W	D5365	45365	14F4				
D5316	45316	14C3	V.MOD	R/W	R/W	R/W	D5366	45366	14F5				
D5317	45317	14C4					D5367	45367	14F6				
D5318	45318	14C5					D5368	45368	14F7				
D5319	45319	14C6					D5369	45369	14F8				
D5320	45320	14C7					D5370	45370	14F9				
D5321	45321	14C8	RTS	R/W	R/W	R/W	D5371	45371	14FA				
D5322	45322	14C9	RTH	R/W	R/W	R/W	D5372	45372	14FB				
D5323	45323	14CA	RTL	R/W	R/W	R/W	D5373	45373	14FC				
D5324	45324	14CB	O1RS	R/W	R/W	R/W	D5374	45374	14FD				
D5325	45325	14CC	O1RH	R/W	R/W	R/W	D5375	45375	14FE				
D5326	45326	14CD	O1RL	R/W	R/W	R/W	D5376	45376	14FF				
D5327	45327	14CE	O2RS	R/W	R/W	R/W	D5377	45377	1500				
D5328	45328	14CF	O2RH	R/W	R/W	R/W	D5378	45378	1501				
D5329	45329	14D0	O2RL	R/W	R/W	R/W	D5379	45379	1502				
D5330	45330	14D1					D5380	45380	1503				
D5331	45331	14D2	OU.H	R/W	R/W	R/W	D5381	45381	1504				
D5332	45332	14D3	OU.L	R/W	R/W	R/W	D5382	45382	1505				
D5333	45333	14D4	OU2.H	R/W	R/W	R/W	D5383	45383	1506				
D5334	45334	14D5	OU2.L	R/W	R/W	R/W	D5384	45384	1507				
D5335	45335	14D6	RET.H	R/W	R/W	R/W	D5385	45385	1508				
D5336	45336	14D7	RET.L	R/W	R/W	R/W	D5386	45386	1509				
D5337	45337	14D8					D5387	45387	150A				
D5338	45338	14D9					D5388	45388	150B				
D5339	45339	14DA					D5389	45389	150C				
D5340	45340	14DB					D5390	45390	150D				
D5341	45341	14DC	OU.A	R/W	R/W	R/W	D5391	45391	150E				
D5342	45342	14DD	OU2.A	R/W	R/W	R/W	D5392	45392	150F				
D5343	45343	14DE	RET.A	R/W	R/W	R/W	D5393	45393	1510				
D5344	45344	14DF					D5394	45394	1511				
D5345	45345	14E0					D5395	45395	1512				
D5346	45346	14E1					D5396	45396	1513				
D5347	45347	14E2					D5397	45397	1514				
D5348	45348	14E3					D5398	45398	1515				
D5349	45349	14E4					D5399	45399	1516				
D5350	45350	14E5					D5400	45400	1517				

6.4 UT55A/UT52A/UP55A D Registers

Setup parameter													
Heater break alarm setting (Menu: HBA)													
D-Reg No.	Ref. No.	H No.	Register symbol	R/W			D-Reg No.	Ref. No.	H No.	Register symbol	R/W		
				UT 55A	UT 52A	UP 55A					UT 55A	UT 52A	UP 55A
D5401	45401	1518	HB1.S	R/W	R/W	R/W	D5451	45451	154A				
D5402	45402	1519	HB2.S	R/W	R/W	R/W	D5452	45452	154B				
D5403	45403	151A	HB1	R/W	R/W	R/W	D5453	45453	154C				
D5404	45404	151B	HB2	R/W	R/W	R/W	D5454	45454	154D				
D5405	45405	151C	CT1.T	R/W	R/W	R/W	D5455	45455	154E				
D5406	45406	151D	CT2.T	R/W	R/W	R/W	D5456	45456	154F				
D5407	45407	151E	HDN1	R/W	R/W	R/W	D5457	45457	1550				
D5408	45408	151F	HDN2	R/W	R/W	R/W	D5458	45458	1551				
D5409	45409	1520	HDF1	R/W	R/W	R/W	D5459	45459	1552				
D5410	45410	1521	HDF2	R/W	R/W	R/W	D5460	45460	1553				
D5411	45411	1522	HB1.D	R/W	R/W	R/W	D5461	45461	1554				
D5412	45412	1523	HB2.D	R/W	R/W	R/W	D5462	45462	1555				
D5413	45413	1524					D5463	45463	1556				
D5414	45414	1525					D5464	45464	1557				
D5415	45415	1526					D5465	45465	1558				
D5416	45416	1527					D5466	45466	1559				
D5417	45417	1528					D5467	45467	155A				
D5418	45418	1529					D5468	45468	155B				
D5419	45419	152A					D5469	45469	155C				
D5420	45420	152B					D5470	45470	155D				
D5421	45421	152C					D5471	45471	155E				
D5422	45422	152D					D5472	45472	155F				
D5423	45423	152E					D5473	45473	1560				
D5424	45424	152F					D5474	45474	1561				
D5425	45425	1530					D5475	45475	1562				
D5426	45426	1531					D5476	45476	1563				
D5427	45427	1532					D5477	45477	1564				
D5428	45428	1533					D5478	45478	1565				
D5429	45429	1534					D5479	45479	1566				
D5430	45430	1535					D5480	45480	1567				
D5431	45431	1536					D5481	45481	1568				
D5432	45432	1537					D5482	45482	1569				
D5433	45433	1538					D5483	45483	156A				
D5434	45434	1539					D5484	45484	156B				
D5435	45435	153A					D5485	45485	156C				
D5436	45436	153B					D5486	45486	156D				
D5437	45437	153C					D5487	45487	156E				
D5438	45438	153D					D5488	45488	156F				
D5439	45439	153E					D5489	45489	1570				
D5440	45440	153F					D5490	45490	1571				
D5441	45441	1540					D5491	45491	1572				
D5442	45442	1541					D5492	45492	1573				
D5443	45443	1542					D5493	45493	1574				
D5444	45444	1543					D5494	45494	1575				
D5445	45445	1544					D5495	45495	1576				
D5446	45446	1545					D5496	45496	1577				
D5447	45447	1546					D5497	45497	1578				
D5448	45448	1547					D5498	45498	1579				
D5449	45449	1548					D5499	45499	157A				
D5450	45450	1549					D5500	45500	157B				

6.4 UT55A/UT52A/UP55A D Registers

Setup parameter													
Communication setting (RS-485 communication setting menu: R485) (Ethernet communication setting menu: ETHR) (Error and version confirmation menu: VER) (CC-Link communication setting menu: CC-L) (DeviceNet communication setting menu: DNET)													
D-Reg No.	Ref. No.	H No.	Register symbol	R/W			D-Reg No.	Ref. No.	H No.	Register symbol	R/W		
				UT 55A	UT 52A	UP 55A					UT 55A	UT 52A	UP 55A
D5501	45501	157C	PSL_E1	R/W	R/W	/	D5551	45551	15AE	SM4_E3	R/W	/	R/W
D5502	45502	157D	BPS_E1	R/W	R/W	/	D5552	45552	15AF	DG1_E3	R/W	/	R/W
D5503	45503	157E	PRI_E1	R/W	R/W	/	D5553	45553	15B0	DG2_E3	R/W	/	R/W
D5504	45504	157F	STP_E1	R/W	R/W	/	D5554	45554	15B1	DG3_E3	R/W	/	R/W
D5505	45505	1580	DLN_E1	R/W	R/W	/	D5555	45555	15B2	DG4_E3	R/W	/	R/W
D5506	45506	1581	ADR_E1	R/W	R/W	/	D5556	45556	15B3	PRT_E3	R/W	/	R/W
D5507	45507	1582	RP.T_E1	R/W	R/W	/	D5557	45557	15B4	IPAR_E3	R/W	/	R/W
D5508	45508	1583					D5558	45558	15B5	1.IP1_E3	R/W	/	R/W
D5509	45509	1584					D5559	45559	15B6	1.IP2_E3	R/W	/	R/W
D5510	45510	1585					D5560	45560	15B7	1.IP3_E3	R/W	/	R/W
D5511	45511	1586					D5561	45561	15B8	1.IP4_E3	R/W	/	R/W
D5512	45512	1587					D5562	45562	15B9	2.IP1_E3	R/W	/	R/W
D5513	45513	1588					D5563	45563	15BA	2.IP2_E3	R/W	/	R/W
D5514	45514	1589					D5564	45564	15BB	2.IP3_E3	R/W	/	R/W
D5515	45515	158A					D5565	45565	15BC	2.IP4_E3	R/W	/	R/W
D5516	45516	158B					D5566	45566	15BD	ESW_E3	R/W	/	R/W
D5517	45517	158C					D5567	45567	15BE				
D5518	45518	158D					D5568	45568	15BF				
D5519	45519	158E					D5569	45569	15C0				
D5520	45520	158F					D5570	45570	15C1				
D5521	45521	1590	PSL_E3	R/W	/	R/W	D5571	45571	15C2	MAC1_E3	R	/	R
D5522	45522	1591	BPS_E3	R/W	/	R/W	D5572	45572	15C3	MAC2_E3	R	/	R
D5523	45523	1592	PRI_E3	R/W	/	R/W	D5573	45573	15C4	MAC3_E3	R	/	R
D5524	45524	1593	STP_E3	R/W	/	R/W	D5574	45574	15C5				
D5525	45525	1594	DLN_E3	R/W	/	R/W	D5575	45575	15C6				
D5526	45526	1595	ADR_E3	R/W	/	R/W	D5576	45576	15C7				
D5527	45527	1596	RP.T_E3	R/W	/	R/W	D5577	45577	15C8				
D5528	45528	1597					D5578	45578	15C9				
D5529	45529	1598					D5579	45579	15CA				
D5530	45530	1599					D5580	45580	15CB				
D5531	45531	159A	PSL_E4	R/W	/	R/W	D5581	45581	15CC	BR_E3-C *1	R/W	/	R/W
D5532	45532	159B	BPS_E4	R/W	/	R/W	D5582	45582	15CD	ADR_E3-C *1	R/W	/	R/W
D5533	45533	159C	PRI_E4	R/W	/	R/W	D5583	45583	15CE	BPS_E3-C *1	R/W	/	R/W
D5534	45534	159D	STP_E4	R/W	/	R/W	D5584	45584	15CF	FILE_E3-C *1	R/W	/	R/W
D5535	45535	159E	DLN_E4	R/W	/	R/W	D5585	45585	15D0	SCAN_E3-C *1	R/W	/	R/W
D5536	45536	159F	ADR_E4	R/W	/	R/W	D5586	45586	15D1				
D5537	45537	15A0	RP.T_E4	R/W	/	R/W	D5587	45587	15D2				
D5538	45538	15A1					D5588	45588	15D3				
D5539	45539	15A2					D5589	45589	15D4				
D5540	45540	15A3					D5590	45590	15D5				
D5541	45541	15A4	HSR_E3	R/W	/	R/W	D5591	45591	15D6	BR_E3-D *1	R/W	/	R/W
D5542	45542	15A5	BPS_E3	R/W	/	R/W	D5592	45592	15D7	ADR_E3-D *1	R/W	/	R/W
D5543	45543	15A6	PRI_E3	R/W	/	R/W	D5593	45593	15D8	BPS_E3-D *1	R/W	/	R/W
D5544	45544	15A7	IP1_E3	R/W	/	R/W	D5594	45594	15D9	FILE_E3-D *1	R/W	/	R/W
D5545	45545	15A8	IP2_E3	R/W	/	R/W	D5595	45595	15DA	SCAN_E3-D *1	R/W	/	R/W
D5546	45546	15A9	IP3_E3	R/W	/	R/W	D5596	45596	15DB				
D5547	45547	15AA	IP4_E3	R/W	/	R/W	D5597	45597	15DC				
D5548	45548	15AB	SM1_E3	R/W	/	R/W	D5598	45598	15DD				
D5549	45549	15AC	SM2_E3	R/W	/	R/W	D5599	45599	15DE				
D5550	45550	15AD	SM3_E3	R/W	/	R/W	D5600	45600	15DF				

*1: Same parameter exists in other menu. "-C" is added to the end of the parameter in CC-L menu (for CC-Link communication), and "-D" is added to the end of the parameter in DNET menu (for DeviceNet communication).

6.4 UT55A/UT52A/UP55A D Registers

Setup parameter													
Communication setting (PROFIBUS-DP communication setting menu: PROF)													
D-Reg No.	Ref. No.	H No.	Register symbol	R/W			D-Reg No.	Ref. No.	H No.	Register symbol	R/W		
				UT 55A	UT 52A	UP 55A					UT 55A	UT 52A	UP 55A
D5601	45601	15E0	BR_E3-P *1	R/W		R/W	D5651	45651	1612				
D5602	45602	15E1	ADR_E3-P *1	R/W		R/W	D5652	45652	1613				
D5603	45603	15E2	BPS_E3-P *1	R/W		R/W	D5653	45653	1614				
D5604	45604	15E3	FILE_E3-P *1	R/W		R/W	D5654	45654	1615				
D5605	45605	15E4	SCAN_E3-P *1	R/W		R/W	D5655	45655	1616				
D5606	45606	15E5					D5656	45656	1617				
D5607	45607	15E6					D5657	45657	1618				
D5608	45608	15E7					D5658	45658	1619				
D5609	45609	15E8					D5659	45659	161A				
D5610	45610	15E9					D5660	45660	161B				
D5611	45611	15EA					D5661	45661	161C				
D5612	45612	15EB					D5662	45662	161D				
D5613	45613	15EC					D5663	45663	161E				
D5614	45614	15ED					D5664	45664	161F				
D5615	45615	15EE					D5665	45665	1620				
D5616	45616	15EF					D5666	45666	1621				
D5617	45617	15F0					D5667	45667	1622				
D5618	45618	15F1					D5668	45668	1623				
D5619	45619	15F2					D5669	45669	1624				
D5620	45620	15F3					D5670	45670	1625				
D5621	45621	15F4					D5671	45671	1626				
D5622	45622	15F5					D5672	45672	1627				
D5623	45623	15F6					D5673	45673	1628				
D5624	45624	15F7					D5674	45674	1629				
D5625	45625	15F8					D5675	45675	162A				
D5626	45626	15F9					D5676	45676	162B				
D5627	45627	15FA					D5677	45677	162C				
D5628	45628	15FB					D5678	45678	162D				
D5629	45629	15FC					D5679	45679	162E				
D5630	45630	15FD					D5680	45680	162F				
D5631	45631	15FE					D5681	45681	1630				
D5632	45632	15FF					D5682	45682	1631				
D5633	45633	1600					D5683	45683	1632				
D5634	45634	1601					D5684	45684	1633				
D5635	45635	1602					D5685	45685	1634				
D5636	45636	1603					D5686	45686	1635				
D5637	45637	1604					D5687	45687	1636				
D5638	45638	1605					D5688	45688	1637				
D5639	45639	1606					D5689	45689	1638				
D5640	45640	1607					D5690	45690	1639				
D5641	45641	1608					D5691	45691	163A				
D5642	45642	1609					D5692	45692	163B				
D5643	45643	160A					D5693	45693	163C				
D5644	45644	160B					D5694	45694	163D				
D5645	45645	160C					D5695	45695	163E				
D5646	45646	160D					D5696	45696	163F				
D5647	45647	160E					D5697	45697	1640				
D5648	45648	160F					D5698	45698	1641				
D5649	45649	1610					D5699	45699	1642				
D5650	45650	1611					D5700	45700	1643				

*1: Same parameter exists in other menu. "-P" is added to the end of the parameter in PROF menu (for PROFIBUS-DP communication).

Setup parameter													
Key operation setting (Menu: KEY), Display function setting (Menu: DISP), SELECT Display setting (Menu: CSEL)													
D-Reg No.	Ref. No.	H No.	Register symbol	R/W			D-Reg No.	Ref. No.	H No.	Register symbol	R/W		
				UT 55A	UT 52A	UP 55A					UT 55A	UT 52A	UP 55A
D5701	45701	1644	F1-K *1	R/W	/	/	D5751	45751	1676	B.STS	R/W	R/W	R/W
D5702	45702	1645	F2-K *1	R/W	/	/	D5752	45752	1677	CTRS			
D5703	45703	1646	Fn-K *1	R/W	R/W	/	D5753	45753	1678	D.CYC	R/W	R/W	R/W
D5704	45704	1647	A/M-K *1	R/W	R/W	/	D5754	45754	1679	OP.JP	R/W	R/W	R/W
D5705	45705	1648	RUN-K *1	/	/	R/W	D5755	45755	167A	MLSD	R/W	R/W	R/W
D5706	45706	1649	RST-K *1	/	/	R/W	D5756	45756	167B	PTSL	/	/	R/W
D5707	45707	164A	PTN-K *1	/	/	R/W	D5757	45757	167C				
D5708	45708	164B	MODE-K *1	/	/	R/W	D5758	45758	167D				
D5709	45709	164C					D5759	45759	167E				
D5710	45710	164D					D5760	45760	167F				
D5711	45711	164E	DVB_L1	R/W	/	/	D5761	45761	1680	CS1	R/W	R/W	R/W
D5712	45712	164F	DVB_L2	R/W	/	/	D5762	45762	1681	CS2	R/W	R/W	R/W
D5713	45713	1650	PCMD_L1	R/W	R/W	R/W	D5763	45763	1682	CS3	R/W	R/W	R/W
D5714	45714	1651	PCH_L1	R/W	R/W	R/W	D5764	45764	1683	CS4	R/W	R/W	R/W
D5715	45715	1652	PCL_L1	R/W	R/W	R/W	D5765	45765	1684	CS5	R/W	R/W	R/W
D5716	45716	1653	PCMD_L2	R/W	R/W	R/W	D5766	45766	1685				
D5717	45717	1654	PCH_L2	R/W	R/W	R/W	D5767	45767	1686				
D5718	45718	1655	PCL_L2	R/W	R/W	R/W	D5768	45768	1687				
D5719	45719	1656	BAR1	R/W	R/W	R/W	D5769	45769	1688				
D5720	45720	1657	BAR2	R/W	R/W	R/W	D5770	45770	1689	CS10	R/W	R/W	R/W
D5721	45721	1658	BDV_L1	R/W	R/W	R/W	D5771	45771	168A	CS11	R/W	R/W	R/W
D5722	45722	1659	BDV_L2	R/W	R/W	R/W	D5772	45772	168B	CS12	R/W	R/W	R/W
D5723	45723	165A	EV1_L1	R/W	R/W	R/W	D5773	45773	168C	CS13	R/W	R/W	R/W
D5724	45724	165B	EV2_L1	R/W	R/W	R/W	D5774	45774	168D	CS14	R/W	R/W	R/W
D5725	45725	165C	EV3_L1	R/W	R/W	R/W	D5775	45775	168E	CS15	R/W	R/W	R/W
D5726	45726	165D	EV4_L1	R/W	R/W	R/W	D5776	45776	168F	CS16	R/W	R/W	R/W
D5727	45727	165E	EV5_L1	R/W	/	R/W	D5777	45777	1690	CS17	R/W	R/W	R/W
D5728	45728	165F	EV6_L1	R/W	/	R/W	D5778	45778	1691	CS18	R/W	R/W	R/W
D5729	45729	1660	EV7_L1	R/W	/	R/W	D5779	45779	1692	CS19	R/W	R/W	R/W
D5730	45730	1661	EV8_L1	R/W	/	R/W	D5780	45780	1693				
D5731	45731	1662	EV1_L2	R/W	R/W	R/W	D5781	45781	1694				
D5732	45732	1663	EV2_L2	R/W	R/W	R/W	D5782	45782	1695				
D5733	45733	1664	EV3_L2	R/W	R/W	R/W	D5783	45783	1696				
D5734	45734	1665	EV4_L2	R/W	R/W	R/W	D5784	45784	1697				
D5735	45735	1666	EV5_L2	R/W	/	R/W	D5785	45785	1698				
D5736	45736	1667	EV6_L2	R/W	/	R/W	D5786	45786	1699				
D5737	45737	1668	EV7_L2	R/W	/	R/W	D5787	45787	169A				
D5738	45738	1669	EV8_L2	R/W	/	R/W	D5788	45788	169B				
D5739	45739	166A	PV.D	R/W	R/W	R/W	D5789	45789	169C				
D5740	45740	166B	SP.D	R/W	R/W	R/W	D5790	45790	169D				
D5741	45741	166C	STS.D	R/W	R/W	R/W	D5791	45791	169E				
D5742	45742	166D	SPD	R/W	R/W	R/W	D5792	45792	169F				
D5743	45743	166E	GUID	R/W	R/W	R/W	D5793	45793	16A0				
D5744	45744	166F	HOME	R/W	R/W	R/W	D5794	45794	16A1				
D5745	45745	1670	ECO	R/W	R/W	R/W	D5795	45795	16A2				
D5746	45746	1671	BRI	R/W	R/W	R/W	D5796	45796	16A3				
D5747	45747	1672	B.PVW	R/W	R/W	R/W	D5797	45797	16A4				
D5748	45748	1673	B.PVR	R/W	R/W	R/W	D5798	45798	16A5				
D5749	45749	1674	B.SP	R/W	R/W	R/W	D5799	45799	16A6				
D5750	45750	1675	B.BAR	R/W	R/W	R/W	D5800	45800	16A7				

*1: Same parameter exists in other menu. "-K" is added to the end of the parameter in KEY menu.

6.4 UT55A/UT52A/UP55A D Registers

Setup parameter													
Lock setting (Key lock setting menu: KLOC) (Menu lock setting menu: MLOC)													
D-Reg No.	Ref. No.	H No.	Register symbol	R/W			D-Reg No.	Ref. No.	H No.	Register symbol	R/W		
				UT 55A	UT 52A	UP 55A					UT 55A	UT 52A	UP 55A
D5801	45801	16A8	U.SP_L1	R/W	R/W	R/W	D5851	45851	16DA	DI.SL-L *1	R/W	R/W	R/W
D5802	45802	16A9	U.SP_L2	R/W	R/W	R/W	D5852	45852	16DB	DI.NU-L *1	R/W	R/W	R/W
D5803	45803	16AA	U.OUT_L1	R/W	R/W	R/W	D5853	45853	16DC	DI.D-L *1	R/W	R/W	R/W
D5804	45804	16AB	U.OUT_L2	R/W	R/W	R/W	D5854	45854	16DD	DI.D_E1-L *1	R/W	R/W	R/W
D5805	45805	16AC	U.HCO	R/W	R/W	R/W	D5855	45855	16DE	DI.D_E2-L *1	R/W		R/W
D5806	45806	16AD	U.VP	R/W	R/W	R/W	D5856	45856	16DF	DI.D_E3-L *1	R/W		R/W
D5807	45807	16AE	U.MV	R/W	R/W	R/W	D5857	45857	16E0	DI.D_E4-L *1	R/W		R/W
D5808	45808	16AF	U.TSP2			R/W	D5858	45858	16E1	ALM-L *1	R/W	R/W	R/W
D5809	45809	16B0	U.PID_L1	R/W	R/W	R/W	D5859	45859	16E2	DO_E1-L *1	R/W	R/W	R/W
D5810	45810	16B1	U.PID_L2	R/W	R/W	R/W	D5860	45860	16E3	DO_E2-L *1	R/W		R/W
D5811	45811	16B2	U.HC	R/W	R/W	R/W	D5861	45861	16E4	DO_E3-L *1	R/W		R/W
D5812	45812	16B3	U.PV1	R/W	R/W	R/W	D5862	45862	16E5	DO_E4-L *1	R/W		R/W
D5813	45813	16B4	U.PV2	R/W	R/W	R/W	D5863	45863	16E6	I/O-L *1	R/W	R/W	R/W
D5814	45814	16B5	U.PV	R/W	R/W	R/W	D5864	45864	16E7	SYS-L *1	R/W	R/W	R/W
D5815	45815	16B6	U.RSP	R/W	R/W	R/W	D5865	45865	16E8	INIT-L *1	R/W	R/W	R/W
D5816	45816	16B7	U.AI2	R/W	R/W	R/W	D5866	45866	16E9	VER-L *1	R/W	R/W	R/W
D5817	45817	16B8	U.AI4	R/W	R/W	R/W	D5867	45867	16EA	LVL-L *1	R/W	R/W	R/W
D5818	45818	16B9	COM.W	R/W	R/W	R/W	D5868	45868	16EB	MODE-L *1	R/W	R/W	R/W
D5819	45819	16BA	DATA-L *1	R/W	R/W	R/W	D5869	45869	16EC	CS-L *1	R/W	R/W	R/W
D5820	45820	16BB	A/M-L *1	R/W	R/W		D5870	45870	16ED	SP_L1-L *1	R/W	R/W	
D5821	45821	16BC	RUN-L *1			R/W	D5871	45871	16EE	SPS_L1-L *1	R/W	R/W	R/W
D5822	45822	16BD	RST-L *1			R/W	D5872	45872	16EF	ALRM_L1-L *1	R/W	R/W	R/W
D5823	45823	16BE	PTN-L *1			R/W	D5873	45873	16F0	PROG-L *1			R/W
D5824	45824	16BF	MODE-L *1			R/W	D5874	45874	16F1	PVS_L1-L *1	R/W	R/W	R/W
D5825	45825	16C0	U.TSP			R/W	D5875	45875	16F2	PID_L1-L *1	R/W	R/W	R/W
D5826	45826	16C1	U.TM			R/W	D5876	45876	16F3	TUNE_L1-L *1	R/W	R/W	R/W
D5827	45827	16C2	U.SEG			R/W	D5877	45877	16F4	ZONE_L1-L *1	R/W	R/W	R/W
D5828	45828	16C3	U.RCY			R/W	D5878	45878	16F5	SP_L2-L *1	R/W	R/W	
D5829	45829	16C4	U.PTN			R/W	D5879	45879	16F6	SPS_L2-L *1	R/W	R/W	
D5830	45830	16C5	U.AL_L1			R/W	D5880	45880	16F7	ALRM_L2-L *1	R/W	R/W	R/W
D5831	45831	16C6	CTL-L *1	R/W	R/W	R/W	D5881	45881	16F8	PVS_L2-L *1	R/W	R/W	R/W
D5832	45832	16C7	PV-L *1	R/W	R/W	R/W	D5882	45882	16F9	PID_L2-L *1	R/W	R/W	R/W
D5833	45833	16C8	RSP_E1-L *1	R/W	R/W	R/W	D5883	45883	16FA	TUNE_L2-L *1	R/W	R/W	R/W
D5834	45834	16C9	AIN2_E2-L *1	R/W		R/W	D5884	45884	16FB	ZONE_L2-L *1	R/W	R/W	R/W
D5835	45835	16CA	AIN4_E4-L *1	R/W		R/W	D5885	45885	16FC	PPAR-L *1	R/W	R/W	R/W
D5836	45836	16CB	MPV_L1-L *1	R/W	R/W	R/W	D5886	45886	16FD	PYS1-L *1	R/W	R/W	R/W
D5837	45837	16CC	MPV_L2-L *1	R/W	R/W	R/W	D5887	45887	16FE	PYS2-L *1	R/W	R/W	R/W
D5838	45838	16CD	OUT-L *1	R/W	R/W	R/W	D5888	45888	16FF	PYS3-L *1	R/W	R/W	R/W
D5839	45839	16CE	HBA-L *1	R/W	R/W	R/W	D5889	45889	1700	PYS4-L *1	R/W	R/W	R/W
D5840	45840	16CF	R485_E1-L *1	R/W	R/W		D5890	45890	1701	LOC-L *1			R/W
D5841	45841	16D0	R485_E3-L *1	R/W		R/W	D5891	45891	1702	EDIT-L *1			R/W
D5842	45842	16D1	R485_E4-L *1	R/W		R/W	D5892	45892	1703	AL_L1-L *1			R/W
D5843	45843	16D2	ETHR_E3-L *1	R/W		R/W	D5893	45893	1704	AL_L2-L *1			R/W
D5844	45844	16D3	PROF_E3-L *1	R/W		R/W	D5894	45894	1705	U.AL_L2			R/W
D5845	45845	16D4	DNET_E3-L *1	R/W		R/W	D5895	45895	1706				
D5846	45846	16D5	CC-L_E3-L *1	R/W		R/W	D5896	45896	1707				
D5847	45847	16D6	KEY-L *1	R/W	R/W	R/W	D5897	45897	1708				
D5848	45848	16D7	DISP-L *1	R/W	R/W	R/W	D5898	45898	1709				
D5849	45849	16D8	CSEL-L *1	R/W	R/W	R/W	D5899	45899	170A				
D5850	45850	16D9	KLOC-L *1	R/W		R/W	D5900	45900	170B				

*1: Same parameter exists in other menu. "-L" is added to the end of the parameter in KLOC menu or MLOC menu.

Setup parameter													
DI function setting (DI function registration menu: DI.SL) (DI function numbering menu: DI.NU)													
D-Reg No.	Ref. No.	H No.	Register symbol	R/W			D-Reg No.	Ref. No.	H No.	Register symbol	R/W		
				UT 55A	UT 52A	UP 55A					UT 55A	UT 52A	UP 55A
D5901	45901	170C	A/M-D *1	R/W	R/W		D5951	45951	173E	PN.B3	R/W	R/W	R/W
D5902	45902	170D	R/L_L1-D *1	R/W	R/W		D5952	45952	173F				
D5903	45903	170E	R/L_L2-D *1	R/W	R/W		D5953	45953	1740	PT.BC-D			R/W
D5904	45904	170F	S/R-D *1	R/W	R/W		D5954	45954	1741	PT.B0-D			R/W
D5905	45905	1710	CAS-D *1	R/W	R/W		D5955	45955	1742	PT.B1D			R/W
D5906	45906	1711	AUTO-D *1	R/W	R/W		D5956	45956	1743	PT.B2-D			R/W
D5907	45907	1712	MAN-D *1	R/W	R/W		D5957	45957	1744	PT.B3-D			R/W
D5908	45908	1713	REM_L1-D *1	R/W	R/W		D5958	45958	1745	PT.B4-D			R/W
D5909	45909	1714	LCL_L1-D *1	R/W	R/W		D5959	45959	1746	PT.B5-D			R/W
D5910	45910	1715	REM_L2-D *1	R/W	R/W		D5960	45960	1747	MP.BC_L1	R/W	R/W	R/W
D5911	45911	1716	LCL_L2-D *1	R/W	R/W		D5961	45961	1748	MP.B0_L1	R/W	R/W	R/W
D5912	45912	1717	ADV-D			R/W	D5962	45962	1749	MP.B1_L1	R/W	R/W	R/W
D5913	45913	1718	HOLD-D			R/W	D5963	45963	174A	MP.B2_L1	R/W	R/W	R/W
D5914	45914	1719	AT-D *1	R/W	R/W	R/W	D5964	45964	174B				
D5915	45915	171A	TRK-D *1	R/W	R/W	R/W	D5965	45965	174C	MP.BC_L2	R/W	R/W	R/W
D5916	45916	171B	SW-D *1	R/W	R/W	R/W	D5966	45966	174D	MP.B0_L2	R/W	R/W	R/W
D5917	45917	171C	PVHD-D *1	R/W	R/W		D5967	45967	174E	MP.B1_L2	R/W	R/W	R/W
D5918	45918	171D	CTOA-D *1	R/W	R/W		D5968	45968	174F	MP.B2_L2	R/W	R/W	R/W
D5919	45919	171E					D5969	45969	1750				
D5920	45920	171F	LAT-D *1	R/W	R/W	R/W	D5970	45970	1751				
D5921	45921	1720	LCD-D *1	R/W	R/W	R/W	D5971	45971	1752				
D5922	45922	1721	MG1-D *1	R/W	R/W	R/W	D5972	45972	1753				
D5923	45923	1722	MG2-D *1	R/W	R/W	R/W	D5973	45973	1754				
D5924	45924	1723	MG3-D *1	R/W	R/W	R/W	D5974	45974	1755				
D5925	45925	1724	MG4-D *1	R/W	R/W	R/W	D5975	45975	1756				
D5926	45926	1725	PRG-D *1			R/W	D5976	45976	1757				
D5927	45927	1726	RST-D *1			R/W	D5977	45977	1758				
D5928	45928	1727	LOC-D *1			R/W	D5978	45978	1759				
D5929	45929	1728	REM-D *1			R/W	D5979	45979	175A				
D5930	45930	1729	P/R-D *1			R/W	D5980	45980	175B				
D5931	45931	172A	P/L-D *1			R/W	D5981	45981	175C				
D5932	45932	172B	WAIT -D *1			R/W	D5982	45982	175D				
D5933	45933	172C	A/M_L1-D *1			R/W	D5983	45983	175E				
D5934	45934	172D	A/M_L2-D *1			R/W	D5984	45984	175F				
D5935	45935	172E	L/C-D *1			R/W	D5985	45985	1760				
D5936	45936	172F	P/H-D *1			R/W	D5986	45986	1761				
D5937	45937	1730	PVRW_L1-D *1	R/W	R/W	R/W	D5987	45987	1762				
D5938	45938	1731	PVRW_L2-D *1	R/W	R/W	R/W	D5988	45988	1763				
D5939	45939	1732	S.HLD-D			R/W	D5989	45989	1764				
D5940	45940	1733					D5990	45990	1765				
D5941	45941	1734	SP.BC	R/W	R/W		D5991	45991	1766				
D5942	45942	1735	SP.B0	R/W	R/W		D5992	45992	1767				
D5943	45943	1736	SP.B1	R/W	R/W		D5993	45993	1768				
D5944	45944	1737	SP.B2	R/W	R/W		D5994	45994	1769				
D5945	45945	1738	SP.B3	R/W	R/W		D5995	45995	176A				
D5946	45946	1739					D5996	45996	176B				
D5947	45947	173A	PN.BC	R/W	R/W	R/W	D5997	45997	176C				
D5948	45948	173B	PN.B0	R/W	R/W	R/W	D5998	45998	176D				
D5949	45949	173C	PN.B1	R/W	R/W	R/W	D5999	45999	176E				
D5950	45950	173D	PN.B2	R/W	R/W	R/W	D6000	46000	176F				

*1: Same parameter exists in other menu. "-D" is added to the end of the parameter in DI.SL menu.

6.4 UT55A/UT52A/UP55A D Registers

Setup parameter													
DI function setting (Message)													
D-Reg No.	Ref. No.	H No.	Register symbol	R/W			D-Reg No.	Ref. No.	H No.	Register symbol	R/W		
				UT 55A	UT 52A	UP 55A					UT 55A	UT 52A	UP 55A
D6001	46001	1770	MSG1	R/W	R/W	R/W	D6051	46051	17A2	MSG3	R/W	R/W	R/W
D6002	46002	1771	MSG1	R/W	R/W	R/W	D6052	46052	17A3				
D6003	46003	1772	MSG1	R/W	R/W	R/W	D6053	46053	17A4				
D6004	46004	1773	MSG1	R/W	R/W	R/W	D6054	46054	17A5				
D6005	46005	1774	MSG1	R/W	R/W	R/W	D6055	46055	17A6				
D6006	46006	1775	MSG1	R/W	R/W	R/W	D6056	46056	17A7				
D6007	46007	1776	MSG1	R/W	R/W	R/W	D6057	46057	17A8				
D6008	46008	1777	MSG1	R/W	R/W	R/W	D6058	46058	17A9				
D6009	46009	1778	MSG1	R/W	R/W	R/W	D6059	46059	17AA				
D6010	46010	1779	MSG1	R/W	R/W	R/W	D6060	46060	17AB				
D6011	46011	177A	MSG1	R/W	R/W	R/W	D6061	46061	17AC	MSG4	R/W	R/W	R/W
D6012	46012	177B					D6062	46062	17AD	MSG4	R/W	R/W	R/W
D6013	46013	177C					D6063	46063	17AE	MSG4	R/W	R/W	R/W
D6014	46014	177D					D6064	46064	17AF	MSG4	R/W	R/W	R/W
D6015	46015	177E					D6065	46065	17B0	MSG4	R/W	R/W	R/W
D6016	46016	177F					D6066	46066	17B1	MSG4	R/W	R/W	R/W
D6017	46017	1780					D6067	46067	17B2	MSG4	R/W	R/W	R/W
D6018	46018	1781					D6068	46068	17B3	MSG4	R/W	R/W	R/W
D6019	46019	1782					D6069	46069	17B4	MSG4	R/W	R/W	R/W
D6020	46020	1783					D6070	46070	17B5	MSG4	R/W	R/W	R/W
D6021	46021	1784	MSG2	R/W	R/W	R/W	D6071	46071	17B6	MSG4	R/W	R/W	R/W
D6022	46022	1785	MSG2	R/W	R/W	R/W	D6072	46072	17B7				
D6023	46023	1786	MSG2	R/W	R/W	R/W	D6073	46073	17B8				
D6024	46024	1787	MSG2	R/W	R/W	R/W	D6074	46074	17B9				
D6025	46025	1788	MSG2	R/W	R/W	R/W	D6075	46075	17BA				
D6026	46026	1789	MSG2	R/W	R/W	R/W	D6076	46076	17BB				
D6027	46027	178A	MSG2	R/W	R/W	R/W	D6077	46077	17BC				
D6028	46028	178B	MSG2	R/W	R/W	R/W	D6078	46078	17BD				
D6029	46029	178C	MSG2	R/W	R/W	R/W	D6079	46079	17BE				
D6030	46030	178D	MSG2	R/W	R/W	R/W	D6080	46080	17BF				
D6031	46031	178E	MSG2	R/W	R/W	R/W	D6081	46081	17C0				
D6032	46032	178F					D6082	46082	17C1				
D6033	46033	1790					D6083	46083	17C2				
D6034	46034	1791					D6084	46084	17C3				
D6035	46035	1792					D6085	46085	17C4				
D6036	46036	1793					D6086	46086	17C5				
D6037	46037	1794					D6087	46087	17C6				
D6038	46038	1795					D6088	46088	17C7				
D6039	46039	1796					D6089	46089	17C8				
D6040	46040	1797					D6090	46090	17C9				
D6041	46041	1798	MSG3	R/W	R/W	R/W	D6091	46091	17CA				
D6042	46042	1799	MSG3	R/W	R/W	R/W	D6092	46092	17CB				
D6043	46043	179A	MSG3	R/W	R/W	R/W	D6093	46093	17CC				
D6044	46044	179B	MSG3	R/W	R/W	R/W	D6094	46094	17CD				
D6045	46045	179C	MSG3	R/W	R/W	R/W	D6095	46095	17CE				
D6046	46046	179D	MSG3	R/W	R/W	R/W	D6096	46096	17CF				
D6047	46047	179E	MSG3	R/W	R/W	R/W	D6097	46097	17D0				
D6048	46048	179F	MSG3	R/W	R/W	R/W	D6098	46098	17D1				
D6049	46049	17A0	MSG3	R/W	R/W	R/W	D6099	46099	17D2				
D6050	46050	17A1	MSG3	R/W	R/W	R/W	D6100	46100	17D3				

Setup parameter													
DI function setting (DI1-DI3 contact type setting menu: DI.D) (DI setting menu (E1 to E4): DI.D)													
D-Reg No.	Ref. No.	H No.	Register symbol	R/W			D-Reg No.	Ref. No.	H No.	Register symbol	R/W		
				UT 55A	UT 52A	UP 55A					UT 55A	UT 52A	UP 55A
D6101	46101	17D4	DI1.D	R/W	R/W	R/W	D6151	46151	1806				
D6102	46102	17D5	DI2.D	R/W	R/W	R/W	D6152	46152	1807				
D6103	46103	17D6	DI3.D	R/W	R/W	R/W	D6153	46153	1808				
D6104	46104	17D7					D6154	46154	1809				
D6105	46105	17D8					D6155	46155	180A				
D6106	46106	17D9					D6156	46156	180B				
D6107	46107	17DA					D6157	46157	180C				
D6108	46108	17DB					D6158	46158	180D				
D6109	46109	17DC					D6159	46159	180E				
D6110	46110	17DD					D6160	46160	180F				
D6111	46111	17DE					D6161	46161	1810	DI1.D_E3	R/W	R/W	
D6112	46112	17DF					D6162	46162	1811	DI2.D_E3	R/W	R/W	
D6113	46113	17E0					D6163	46163	1812	DI3.D_E3	R/W	R/W	
D6114	46114	17E1					D6164	46164	1813	DI4.D_E3	R/W	R/W	
D6115	46115	17E2					D6165	46165	1814	DI5.D_E3	R/W	R/W	
D6116	46116	17E3					D6166	46166	1815				
D6117	46117	17E4					D6167	46167	1816				
D6118	46118	17E5					D6168	46168	1817				
D6119	46119	17E6					D6169	46169	1818				
D6120	46120	17E7					D6170	46170	1819				
D6121	46121	17E8	DI1.D_E1	R/W	R/W	R/W	D6171	46171	181A				
D6122	46122	17E9	DI2.D_E1	R/W	R/W	R/W	D6172	46172	181B				
D6123	46123	17EA	DI3.D_E1	R/W	R/W	R/W	D6173	46173	181C				
D6124	46124	17EB	DI4.D_E1	R/W	R/W	R/W	D6174	46174	181D				
D6125	46125	17EC	DI5.D_E1	R/W	R/W	R/W	D6175	46175	181E				
D6126	46126	17ED					D6176	46176	181F				
D6127	46127	17EE					D6177	46177	1820				
D6128	46128	17EF					D6178	46178	1821				
D6129	46129	17F0					D6179	46179	1822				
D6130	46130	17F1					D6180	46180	1823				
D6131	46131	17F2					D6181	46181	1824	DI1.D_E4	R/W	R/W	
D6132	46132	17F3					D6182	46182	1825	DI2.D_E4	R/W	R/W	
D6133	46133	17F4					D6183	46183	1826	DI3.D_E4	R/W	R/W	
D6134	46134	17F5					D6184	46184	1827	DI4.D_E4	R/W	R/W	
D6135	46135	17F6					D6185	46185	1828	DI5.D_E4	R/W	R/W	
D6136	46136	17F7					D6186	46186	1829				
D6137	46137	17F8					D6187	46187	182A				
D6138	46138	17F9					D6188	46188	182B				
D6139	46139	17FA					D6189	46189	182C				
D6140	46140	17FB					D6190	46190	182D				
D6141	46141	17FC	DI1.D_E2	R/W		R/W	D6191	46191	182E				
D6142	46142	17FD	DI2.D_E2	R/W		R/W	D6192	46192	182F				
D6143	46143	17FE	DI3.D_E2	R/W		R/W	D6193	46193	1830				
D6144	46144	17FF	DI4.D_E2	R/W		R/W	D6194	46194	1831				
D6145	46145	1800	DI5.D_E2	R/W		R/W	D6195	46195	1832				
D6146	46146	1801					D6196	46196	1833				
D6147	46147	1802					D6197	46197	1834				
D6148	46148	1803					D6198	46198	1835				
D6149	46149	1804					D6199	46199	1836				
D6150	46150	1805					D6200	46200	1837				

6.4 UT55A/UT52A/UP55A D Registers

Setup parameter													
DO function setting (AL1-AL3 function registration menu: ALM) (DO setting menu (E1 to E4): DO)													
D-Reg No.	Ref. No.	H No.	Register symbol	R/W			D-Reg No.	Ref. No.	H No.	Register symbol	R/W		
				UT 55A	UT 52A	UP 55A					UT 55A	UT 52A	UP 55A
D6201	46201	1838	AL1.S	R/W	R/W	R/W	D6251	46251	186A				
D6202	46202	1839	AL2.S	R/W	R/W	R/W	D6252	46252	186B				
D6203	46203	183A	AL3.S	R/W	R/W	R/W	D6253	46253	186C				
D6204	46204	183B	OR.S	R/W	R/W	R/W	D6254	46254	186D				
D6205	46205	183C	OR2.S	R/W	R/W	R/W	D6255	46255	186E				
D6206	46206	183D	AL1.D	R/W	R/W	R/W	D6256	46256	186F				
D6207	46207	183E	AL2.D	R/W	R/W	R/W	D6257	46257	1870				
D6208	46208	183F	AL3.D	R/W	R/W	R/W	D6258	46258	1871				
D6209	46209	1840	OR.D	R/W	R/W	R/W	D6259	46259	1872				
D6210	46210	1841	OR2.D	R/W	R/W	R/W	D6260	46260	1873				
D6211	46211	1842					D6261	46261	1874	DO1.S_E3	R/W	R/W	
D6212	46212	1843					D6262	46262	1875	DO2.S_E3	R/W	R/W	
D6213	46213	1844					D6263	46263	1876	DO3.S_E3	R/W	R/W	
D6214	46214	1845					D6264	46264	1877	DO4.S_E3	R/W	R/W	
D6215	46215	1846					D6265	46265	1878	DO5.S_E3	R/W	R/W	
D6216	46216	1847					D6266	46266	1879	DO1.D_E3	R/W	R/W	
D6217	46217	1848					D6267	46267	187A	DO2.D_E3	R/W	R/W	
D6218	46218	1849					D6268	46268	187B	DO3.D_E3	R/W	R/W	
D6219	46219	184A					D6269	46269	187C	DO4.D_E3	R/W	R/W	
D6220	46220	184B					D6270	46270	187D	DO5.D_E3	R/W	R/W	
D6221	46221	184C	DO1.S_E1	R/W	R/W	R/W	D6271	46271	187E				
D6222	46222	184D	DO2.S_E1	R/W	R/W	R/W	D6272	46272	187F				
D6223	46223	184E	DO3.S_E1	R/W	R/W	R/W	D6273	46273	1880				
D6224	46224	184F	DO4.S_E1	R/W	R/W	R/W	D6274	46274	1881				
D6225	46225	1850	DO5.S_E1	R/W	R/W	R/W	D6275	46275	1882				
D6226	46226	1851	DO1.D_E1	R/W	R/W	R/W	D6276	46276	1883				
D6227	46227	1852	DO2.D_E1	R/W	R/W	R/W	D6277	46277	1884				
D6228	46228	1853	DO3.D_E1	R/W	R/W	R/W	D6278	46278	1885				
D6229	46229	1854	DO4.D_E1	R/W	R/W	R/W	D6279	46279	1886				
D6230	46230	1855	DO5.D_E1	R/W	R/W	R/W	D6280	46280	1887				
D6231	46231	1856					D6281	46281	1888	DO1.S_E4	R/W	R/W	
D6232	46232	1857					D6282	46282	1889	DO2.S_E4	R/W	R/W	
D6233	46233	1858					D6283	46283	188A	DO3.S_E4	R/W	R/W	
D6234	46234	1859					D6284	46284	188B	DO4.S_E4	R/W	R/W	
D6235	46235	185A					D6285	46285	188C	DO5.S_E4	R/W	R/W	
D6236	46236	185B					D6286	46286	188D	DO1.D_E4	R/W	R/W	
D6237	46237	185C					D6287	46287	188E	DO2.D_E4	R/W	R/W	
D6238	46238	185D					D6288	46288	188F	DO3.D_E4	R/W	R/W	
D6239	46239	185E					D6289	46289	1890	DO4.D_E4	R/W	R/W	
D6240	46240	185F					D6290	46290	1891	DO5.D_E4	R/W	R/W	
D6241	46241	1860	DO1.S_E2	R/W		R/W	D6291	46291	1892				
D6242	46242	1861	DO2.S_E2	R/W		R/W	D6292	46292	1893				
D6243	46243	1862	DO3.S_E2	R/W		R/W	D6293	46293	1894				
D6244	46244	1863	DO4.S_E2	R/W		R/W	D6294	46294	1895				
D6245	46245	1864	DO5.S_E2	R/W		R/W	D6295	46295	1896				
D6246	46246	1865	DO1.D_E2	R/W		R/W	D6296	46296	1897				
D6247	46247	1866	DO2.D_E2	R/W		R/W	D6297	46297	1898				
D6248	46248	1867	DO3.D_E2	R/W		R/W	D6298	46298	1899				
D6249	46249	1868	DO4.D_E2	R/W		R/W	D6299	46299	189A				
D6250	46250	1869	DO5.D_E2	R/W		R/W	D6300	46300	189B				

6.4 UT55A/UT52A/UP55A D Registers

Setup parameter													
I/O display (Menu: I/O)													
D-Reg No.	Ref. No.	H No.	Register symbol	R/W			D-Reg No.	Ref. No.	H No.	Register symbol	R/W		
				UT 55A	UT 52A	UP 55A					UT 55A	UT 52A	UP 55A
D6301	46301	189C	KEY-IO *1	R	R	R	D6351	46351	18CE				
D6302	46302	189D					D6352	46352	18CF				
D6303	46303	189E					D6353	46353	18D0				
D6304	46304	189F					D6354	46354	18D1				
D6305	46305	18A0					D6355	46355	18D2				
D6306	46306	18A1					D6356	46356	18D3				
D6307	46307	18A2					D6357	46357	18D4				
D6308	46308	18A3					D6358	46358	18D5				
D6309	46309	18A4					D6359	46359	18D6				
D6310	46310	18A5					D6360	46360	18D7				
D6311	46311	18A6					D6361	46361	18D8				
D6312	46312	18A7					D6362	46362	18D9				
D6313	46313	18A8					D6363	46363	18DA				
D6314	46314	18A9					D6364	46364	18DB				
D6315	46315	18AA					D6365	46365	18DC				
D6316	46316	18AB					D6366	46366	18DD				
D6317	46317	18AC					D6367	46367	18DE				
D6318	46318	18AD					D6368	46368	18DF				
D6319	46319	18AE					D6369	46369	18E0				
D6320	46320	18AF					D6370	46370	18E1				
D6321	46321	18B0					D6371	46371	18E2				
D6322	46322	18B1					D6372	46372	18E3				
D6323	46323	18B2					D6373	46373	18E4				
D6324	46324	18B3					D6374	46374	18E5				
D6325	46325	18B4					D6375	46375	18E6				
D6326	46326	18B5					D6376	46376	18E7				
D6327	46327	18B6					D6377	46377	18E8				
D6328	46328	18B7					D6378	46378	18E9				
D6329	46329	18B8					D6379	46379	18EA				
D6330	46330	18B9					D6380	46380	18EB				
D6331	46331	18BA					D6381	46381	18EC				
D6332	46332	18BB					D6382	46382	18ED				
D6333	46333	18BC					D6383	46383	18EE				
D6334	46334	18BD					D6384	46384	18EF				
D6335	46335	18BE					D6385	46385	18F0				
D6336	46336	18BF					D6386	46386	18F1				
D6337	46337	18C0					D6387	46387	18F2				
D6338	46338	18C1					D6388	46388	18F3				
D6339	46339	18C2					D6389	46389	18F4				
D6340	46340	18C3					D6390	46390	18F5				
D6341	46341	18C4					D6391	46391	18F6				
D6342	46342	18C5					D6392	46392	18F7				
D6343	46343	18C6					D6393	46393	18F8				
D6344	46344	18C7					D6394	46394	18F9				
D6345	46345	18C8					D6395	46395	18FA				
D6346	46346	18C9					D6396	46396	18FB				
D6347	46347	18CA					D6397	46397	18FC				
D6348	46348	18CB					D6398	46398	18FD				
D6349	46349	18CC					D6399	46399	18FE				
D6350	46350	18CD					D6400	46400	18FF				

*1: Same parameter exists in other menu. "-IO" is added to the end of the parameter in I/O menu.

6.4 UT55A/UT52A/UP55A D Registers

Setup parameter													
System setting (Menu: SYS)													
D-Reg No.	Ref. No.	H No.	Register symbol	R/W			D-Reg No.	Ref. No.	H No.	Register symbol	R/W		
				UT 55A	UT 52A	UP 55A					UT 55A	UT 52A	UP 55A
D6401	46401	1900	R.MD	R/W	R/W	R/W	D6451	46451	1932				
D6402	46402	1901	R.TM	R/W	R/W	R/W	D6452	46452	1933				
D6403	46403	1902					D6453	46453	1934				
D6404	46404	1903					D6454	46454	1935				
D6405	46405	1904					D6455	46455	1936				
D6406	46406	1905					D6456	46456	1937				
D6407	46407	1906					D6457	46457	1938				
D6408	46408	1907	EPO	R/W	R/W	R/W	D6458	46458	1939				
D6409	46409	1908	C.GRN	R/W	R/W	R/W	D6459	46459	193A				
D6410	46410	1909	FREQ	R/W	R/W	R/W	D6460	46460	193B				
D6411	46411	190A					D6461	46461	193C				
D6412	46412	190B					D6462	46462	193D				
D6413	46413	190C					D6463	46463	193E				
D6414	46414	190D					D6464	46464	193F				
D6415	46415	190E					D6465	46465	1940				
D6416	46416	190F					D6466	46466	1941				
D6417	46417	1910	QSM	R/W	R/W	R/W	D6467	46467	1942				
D6418	46418	1911	LANG	R/W	R/W	R/W	D6468	46468	1943				
D6419	46419	1912					D6469	46469	1944				
D6420	46420	1913					D6470	46470	1945				
D6421	46421	1914	U.DEF	R/W	R/W	R/W	D6471	46471	1946				
D6422	46422	1915					D6472	46472	1947				
D6423	46423	1916	F.DEF	R/W	R/W	R/W	D6473	46473	1948				
D6424	46424	1917					D6474	46474	1949				
D6425	46425	1918	P.DEF	/	/	R/W	D6475	46475	194A				
D6426	46426	1919					D6476	46476	194B				
D6427	46427	191A					D6477	46477	194C				
D6428	46428	191B					D6478	46478	194D				
D6429	46429	191C					D6479	46479	194E				
D6430	46430	191D					D6480	46480	194F				
D6431	46431	191E	LEVL	R/W	R/W	R/W	D6481	46481	1950				
D6432	46432	191F					D6482	46482	1951				
D6433	46433	1920					D6483	46483	1952				
D6434	46434	1921					D6484	46484	1953				
D6435	46435	1922					D6485	46485	1954				
D6436	46436	1923					D6486	46486	1955				
D6437	46437	1924					D6487	46487	1956				
D6438	46438	1925					D6488	46488	1957				
D6439	46439	1926					D6489	46489	1958				
D6440	46440	1927					D6490	46490	1959				
D6441	46441	1928					D6491	46491	195A				
D6442	46442	1929					D6492	46492	195B				
D6443	46443	192A					D6493	46493	195C				
D6444	46444	192B					D6494	46494	195D				
D6445	46445	192C					D6495	46495	195E				
D6446	46446	192D					D6496	46496	195F				
D6447	46447	192E					D6497	46497	1960				
D6448	46448	192F					D6498	46498	1961				
D6449	46449	1930					D6499	46499	1962				
D6450	46450	1931					D6500	46500	1963				

D6501 to D7000: Free area

Control Function Setting (D5001 to D5100)

Register No.	Description		Range and meaning of value
D5001	CTLM	Control mode	1: SGL (Single-loop control) 2: CAS1 (Cascade primary-loop control) 3: CAS2 (Cascade secondary-loop control) *1 4: CAS (Cascade control) 5: BUM (Loop control for backup) *1 6: PVSU (Loop control with PV switching) 7: PVSEL (Loop control with PV auto-selector) 8: PVHD (Loop control with PV-hold function)*1 * When using the ladder program, the control mode cannot be changed. *1: For UT55A/UT52A only
D5002			
D5003	CNT_L1	Loop-1 control type	0: PID (PID control) 1: ONOF (ON/OFF control (1 point of hysteresis)) 2: ONOF2 (ON/OFF control (2 points of hysteresis)) 3: 2P2L (Two-position two-level control) * 4: H/C (Heating/cooling control) 5: S-PI (Sample PI control) * 6: BATCH (Batch PID control) * 7: FFPID (Feedforward control) * *: For UT55A/UT52A only
D5004	CNT_L2	Loop-2 control type	0: PID (PID control) 4: H/C (Heating/cooling control)
D5005	ALG_L1	Loop-1 PID control mode	0: Standard PID control mode 1: Fixed-point control mode
D5006	ALG_L2	Loop-2 PID control mode	Select "Fixed-point control mode" for pressure or flow rate control.
D5007	SPGR.	Number of SP groups	Set a number of SP groups to use. 1 to 8
D5008			
D5009	ALNO_L1	Loop-1 number of alarms	1 to 8
D5010	ALNO_L2	Loop-2 number of alarms	1 to 8
D5011			
D5012	ZON	Zone PID selection	UT55A/UT52A If set to "SP group number selection," allows PID constants to be selected for each SP group. If set to "Zone PID selection," automatically selects PID constants according to the range set in the Reference point. 0: SP group number selection 1 1: Zone PID selection (selection by PV) 2: Zone PID selection (selection by target SP) 3: SP group number selection 2 4: Zone PID selection (selection by SP) UP55A 0: Segment PID selection 1: Zone PID selection (selection by PV) 2: Zone PID selection (selection by target SP) 4: Zone PID selection (selection by SP) 5: Local PID selection * If set to "Segment PID selection," allows PID constants to be selected for each segments. * If set to "Zone PID selection," automatically selects PID constants according to the range set in the Reference point. * If set to "Local PID selection," local PID is selected irrespective of the operation modes.
D5013			
D5014	PIDG.	Number of PID groups	Set a number of PID groups to use. 1 to 8

6.4 UT55A/UT52A/UP55A D Registers

Register No.		Description	Range and meaning of value
D5015			
D5016	SEG.T	Segment setting method	0: TIME (Segment time setting) 1: TM.RT (Segment ramp-rate setting) * Note: A change of setting deletes a program pattern.
D5017	TMU	Program time unit	0: HH.MM (hour.minute) 1: MM.SS (minute.second)
D5018	PT2.G	Program pattern-2 retransmission	0: OFF (Not used) 1: ON (used) * The controller can serve as a program pattern generator. * Retransmission output types (RTS, O1RS, or O2RS) need to be set to SP2.
D5019	SMP	Input sampling period (control period)	0: 50 (50 ms) * 1: 100 (100 ms) 2: 200 (200 ms) *: For UT55A/UT52A only
D5020 to D5100			

Input Setting (D5101 to D5300)

Register No.		Description	Range and meaning of value
D5101	IN	PV input type	0: OFF (Disable) 1: K1 (-270.0 to 1370.0°C / -450.0 to 2500.0 F) 2: K2 (-270.0 to 1000.0°C / -450.0 to 2300.0 F) 3: K3 (-200.0 to 500.0°C / -200.0 to 1000.0 F) 4: J (-200.0 to 1200.0°C / -300.0 to 2300.0 F) 5: T1 (-270.0 to 400.0°C / -450.0 to 750.0 F) 6: T2 (0.0 to 400.0°C / -200.0 to 750.0 F) 7: B (0.0 to 1800.0°C / 32 to 3300 F) 8: S (0.0 to 1700.0°C / 32 to 3100 F) 9: R (0.0 to 1700.0°C / 32 to 3100 F) 10: N (-200.0 to 1300.0°C / -300.0 to 2400.0 F) 11: E (-270.0 to 1000.0°C / -450.0 to 1800.0 F) 12: L (-200.0 to 900.0°C / -300.0 to 1600.0 F) 13: U1 (-200.0 to 400.0°C / -300.0 to 750.0 F) 14: U2 (0.0 to 400.0°C / -200.0 to 1000.0 F) 15: W (0.0 to 2300.0°C / 32 to 4200 F) 16: PL2 (0.0 to 1390.0°C / 32.0 to 2500.0 F) 17: P2040 (0.0 to 1900.0°C / 32 to 3400 F) 18: WRE (0.0 to 2000.0°C / 32 to 3600 F) 30: JPT1 (-200.0 to 500.0°C / -300.0 to 1000.0 F) 31: JPT2 (-150.00 to 150.00°C / -200.0 to 300.0 F) 35: PT1 (-200.0 to 850.0°C / -300.0 to 1560.0 F) 36: PT2 (-200.0 to 500.0°C / -300.0 to 1000.0 F) 37: PT3 (-150.00 to 150.00°C / -200.0 to 300.0 F) 40: 0.4-2V (0.400 to 2.000 V) 41: 1-5V (1.000 to 5.000 V) 42: 4-20 (4.00 to 20.00 mA) 50: 0-2V (0.000 to 2.000 V) 51: 0-10V (0.00 to 10.00 V) 52: 0-20 (0.00 to 20.00 mA) 55: -1020 (-10.00 to 20.00 mV) 56: 0-100 (0.0 to 100.0 mV) *W: W-5% Re/W-26% Re(Hoskins Mfg. Co.), ASTM E988 WRE: W97Re3-W75Re25
D5102	UNIT	PV input unit	0, 2, 3, 4: - (No unit) 1: C (Degree Celsius) 5: F (Degree Fahrenheit)
D5103	DP	PV input decimal point position	0: No decimal place 1: One decimal place 2: Two decimal places 3: Three decimal places 4: Four decimal places
D5104	RH	Maximum value of PV input range	Depends on the input type. - For temperature input - Set the temperature range that is actually controlled. (RL<RH) - For voltage / current input - Set the range of a voltage / current signal that is applied. The scale across which the voltage / current signal is actually controlled should be set using the maximum value of input scale (SH) and minimum value of input scale (SL). (Input is always 0% when RL = RH.)
D5105	RL	Minimum value of PV input range	
D5106	SDP	PV input scale decimal point position	Same as D5103
D5107	SH	Maximum value of PV input scale	
D5108	SL	Minimum value of PV input scale	-19999 to 30000, (SL<SH), SH - SL ≤ 30000
D5109	BSL	PV input burnout action	0: OFF (Disable) 1: UP (Upscale) 2: DOWN (Downscale)
D5110	RJC	PV input reference junction compensation	0: OFF (RJC OFF) 1: ON (RJC ON)
D5111	ERJC	PV input external RJC setpoint	-10.0 to 60.0°C
D5112	A.BS	PV analog input bias	-100.0 to 100.0% of PV input range span (EUS)
D5113	A.FL	PV analog input filter	0: OFF 1 to 120 s
D5114	A.SR	PV analog input square root extraction	0: OFF (No square root extraction.) 1: Compute the square root. (The slope equals "1.") 2: Compute the square root. (The slope equals "0.")

6.4 UT55A/UT52A/UP55A D Registers

Register No.	Description		Range and meaning of value
D5115	A.LC	PV analog input low signal cutoff	0.0 to 5.0%
D5116 to D5120			
D5121	IN_E1	RSP remote input type	40: 0.4-2V (0.400 to 2.000 V) 41: 1-5V (1.000 to 5.000 V) 50: 0-2V (0.000 to 2.000 V) 51: 0-10V (0.00 to 10.00 V) 57: 0-125 (0.000 to 1.250 V) For option /DR, RSP remote input type is same as PV input type.
D5122	UNIT_E1	RSP remote input unit	Same as D5102
D5123	DP_E1	RSP remote input decimal point position	Same as D5103
D5124	RH_E1	Maximum value of RSP remote input range	Depends on the input type. - For temperature input (with /DR option) - Set the temperature range that is actually controlled. (RL<RH) - For voltage / current (with /DR option) input - Set the range of a voltage / current signal that is applied.
D5125	RL_E1	Minimum value of RSP remote input range	The scale across which the voltage / current signal is actually controlled should be set using the maximum value of input scale (SH) and minimum value of input scale (SL). (Input is always 0% when RL = RH.)
D5126	SDP_E1	RSP remote input scale decimal point position	Same as D5103
D5127	SH_E1	Maximum value of RSP remote input scale	Same as D5107, D5108
D5128	SL_E1	Minimum value of RSP remote input scale	
D5129	BSL_E1	RSP remote input burnout action	Same as D5109
D5130	RJC_E1	RSP remote input reference junction compensation (for /DR option)	Same as D5110
D5131	ERJC_E1	RSP remote input external RJC setpoint (for /DR option)	-10.0 to 60.0°x
D5132	RTD.S_E1	RTD wiring system	0: 3-W (3-wire system) 1: 4-W (4-wire system) (The LL50A Parameter Setting Software is required to use RSP terminals input as PV.)
D5133	A.BS_E1	RSP analog input bias	-100.0 to 100.0% of RSP input range span (EUS)
D5134	A.FL_E1	RSP analog input filter	Same as D 5113
D5135	A.SR_E1	RSP analog input square root extraction	Same as D5114
D5136	A.LC_E1	RSP analog input low signal cutoff	Same as D5115
D5137	DI6.D_E1	DI16 contact type (for no /DR option)	0: The assigned function is enabled when the contact is closed. 1: The assigned function is enabled when the contact is opened.
D5138 to D5140			
D5141	IN_E2	AIN2 aux. analog input type	Same as D5121
D5142	UNIT_E2	AIN2 aux. analog input unit	Same as D5102
D5143	DP_E2	AIN2 aux. analog input decimal point position	Same as D5103
D5144	RH_E2	Maximum value of AIN2 aux. analog input range	Depends on the input type. Set the range of a voltage signal that is applied. The scale across which the voltage signal is actually controlled should be set using the maximum value of input scale (SH) and minimum value of input scale (SL).
D5145	RL_E2	Minimum value of AIN2 aux. analog input range	(Input is always 0% when RL = RH.)
D5146	SDP_E2	AIN2 aux. analog input scale decimal point position	Same as D5103
D5147	SH_E2	Maximum value of AIN2 aux. analog input scale	Same as D5107, D5108
D5148	SL_E2	Minimum value of AIN2 aux. analog input scale	
D5149	BSL_E2	AIN2 aux. analog input burnout action	Same as D5109
D5150 to D5151			
D5152	A.BS_E2	AIN2 aux. analog input bias	-100.0 to 100.0% of AIN2 input range span (EUS)
D5153	A.FL_E2	AIN2 aux. analog input filter	Same as D5113
D5154	A.SR_E2	AIN2 aux. analog input square root extraction	Same as D5114
D5155	A.LC_E2	AIN2 aux. analog input low signal cutoff	Same as D5115
D5156			
D5157	DI6.D_E2	DI26 contact type	Same as D5137
D5158 to D5180			

Register No.	Description		Range and meaning of value
D5181	IN_E4	AIN4 aux. analog input type	Same as D5121
D5182	UNIT_E4	AIN4 aux. analog input unit	Same as D5102
D5183	DP_E4	Maximum value of AIN4 aux. analog input position	Same as D5103
D5184	RH_E4	Maximum value of AIN4 aux. analog input range	Same as D5144, D5145
D5185	RL_E4	Minimum value of AIN4 aux. analog input range	
D5186	SDP_E4	AIN4 aux. analog input scale decimal point position	Same as D5103
D5187	SH_E4	Maximum value of AIN4 aux. analog input scale	Same as D5107, D5108
D5188	SL_E4	Minimum value of AIN4 aux. analog input scale	
D5189	BSL_E4	AIN4 aux. analog input burnout action	Same as D5109
D5190 to D5191			
D5192	A.BS_E4	AIN4 aux. analog input bias	-100.0 to 100.0% of AIN4 input range span (EUS)
D5193	A.FL_E4	AIN4 aux. analog input filter	Same as D5113
D5194	A.SR_E4	AIN4 aux. analog input square root extraction	Same as D5114
D5195	A.LC_E4	AIN4 aux. analog input low signal cutoff	Same as D5115
D5196			
D5197	DI6.D_E4	DI46 contact type	Same as D5137
D5198 to D5200			
D5201	P.UNI_L1	Loop-1 control PV input unit	0, 2, 3, 4: - (No unit) 1: C (Degree Celsius) 5: F (Degree Fahrenheit)
D5202	P.DP_L1	Loop-1 control PV input decimal point position	0: No decimal place 1: One decimal place 2: Two decimal places 3: Three decimal places 4: Four decimal places
D5203	P.RH_L1	Loop-1 maximum value of control PV input range	-19999 to 30000, (P.RL<P.RH), P.RH - P.RL ≤ 30000
D5204	P.RL_L1	Loop-1 minimum value of control PV input range	
D5205	PV.HL	Input switching PV high limit (in Loop control with PV switching)	0.0 to 100.0% of control PV input range (EU), (PV.HL>PV.LL)
D5206	PV.LL	Input switching PV low limit (in Loop control with PV switching)	
D5207	PV.2C	Input switching action (in Loop control with PV switching)	0: Switch based on low limit of temperature range 1: Switch using the parameter PV.HL 2: Switch using DI 3: Switch based on high limit of temperature range
D5208	PV.AS	Input computation selection (in Loop control with PV auto-selector)	0: Max. value 1: Min. value 2: Ave. value 3: Input 1 - Input 2 4: Input 2 - Input 1
D5209	PV.NU	Number of inputs (in Loop control with PV auto-selector)	2: Use Input 1 and Input 2 3: Use Input 1, Input 2, and Input 3 4: Use 4 inputs
D5210	SPH_L1	Loop-1 SP high limit	0.0 to 100.0% of PV input range (EU), (SPL<SPH)
D5211	SPL_L1	Loop-1 SP low limit	
D5210 to D5220			
D5221	P.UNI_L2	Loop-2 control PV input unit (in Cascade control)	Same as D5201
D5222	P.DP_L2	Loop-2 control PV input decimal point position (in Cascade control)	Same as D5202
D5223	P.RH_L2	Loop-2 maximum value of Control PV input range (in Cascade control)	Same as D5203, D5204
D5224	P.RL_L2	Loop-2 minimum value of Control PV input range (in Cascade control)	
D5225 to D5229			
D5230	SPH_L2	Loop-2 SP high limit	Same as D5210, D5211
D5231	SPL_L2	loop-2 SP low limit	
D5225 to D5300			

6.4 UT55A/UT52A/UP55A D Registers

Output Setting (D5301 to D5400)

Register No.	Description		Range and meaning of value
D5301	OT.H	Heating-side control output selection	0: OFF 1: OUT terminals (voltage pulse) 2: OUT terminals (current) 3: OUT terminals (relay) 4: OUT2 terminals (voltage pulse)
D5302	OT.C	Cooling-side control output selection	5: OUT2 terminals (current) 6: OUT2 terminals (relay) When the UTAdvanced parameter is set by key stroke, the heating-side control output selection, and cooling-side control output selection comprise one parameter.
D5303	CT	Control output cycle time Heating-side control output cycle time (in Heating/cooling control)	0.5 to 1000.0 s
D5304	CTc	Cooling-side control output cycle time	
D5305 to D5310			
D5311	V.AT	Automatic valve position adjustment	0: OFF (Stop automatic adjustment) 1: ON (Start automatic adjustment)
D5312	V.RS	Valve position setting reset	0: OFF 1: ON (Resets the valve adjustment settings and causes the indication "V.RS" to blink.)
D5313	V.L	Fully-closed valve position setting	Pressing the SET/ENTER key with valve position set to the fully-closed position by Down arrow key causes the adjusted value to be stored. When V.L adjustment is complete, V.L stops blinking.
D5314	V.H	Fully-opened valve position setting	Pressing the SET/ENTER key with valve position set to the fully-opened position by Up arrow key causes the adjusted value to be stored. When V.H adjustment is complete, V.H stops blinking.
D5315	TR.T	Valve traveling time	5 to 300 s
D5316	V.MOD	Valve adjusting mode	0: Valve position feedback type 1: Valve position feedback type (moves to the estimating type if a feedback input error or break occurs.) 2: Valve position estimating type
D5317 to D5320			
D5321	RTS	Retransmission output type of RET	0: OFF (Disable) 1: PV1 (PV) 2: SP1 (SP) 3: OUT1 (OUT (Valve opening: 0 to 100 % in Position proportional control)) 4: LPS (15 V DC loop power supply) 5: PV2 (Loop-2 PV) 6: SP2 (Loop-2 SP) 7: OUT2 (Loop-2 OUT) 8: TSP1 (Target SP) 9: HOUT1 (Heating-side OUT) 10: COUT1 (Cooling-side OUT) 11: MV1 (Position proportional output (internal computed value)) 12: TSP2 (Loop-2 target SP) 13: HOUT2 (Loop-2 heating-side OUT) 14: COUT2 Loop-2 cooling-side OUT 15: MV2 (Loop-2 position proportional output (internal computed value)) 16: PV (PV terminals analog input) 17: RSP (RSP terminals analog input) 18: AIN2 (AIN2 terminals analog input) 19: ANI4 (AIN4 terminals analog input) Loop-2 setting values are unavailable in Single-loop control.

Register No.		Description	Range and meaning of value
D5322	RTH	Maximum value of retransmission output scale of RET	When RTS=1 (PV1), 2 (SP1), 5 (PV2), 6 (SP2), 8 (TSP1), 12 (TSP2), 16 (PV), 17 (RSP), 18 (AIN2), 19 (AIN4), RTL+1digit to 30000 Decimal point position: RTS=1 (PV1), 2 (SP1), or 8 (TSP1): decimal point position is same as that of PV input. RTS=5 (PV2), 6 (SP2), or 12 (TSP2): decimal point position is same as that of RSP input. RTS=16 (PV): decimal point position is same as that of PV input scale. RTS=17 (RSP): decimal point position is same as that of RSP input scale. RTS=18 (AIN2): decimal point position is same as that of AIN2 scale. RTS=19 (AIN4): decimal point position is same as that of AIN4 scale.
D5323	RTL	Minimum value of retransmission output scale of RET	When RTS=1 (PV1), 2 (SP1), 5 (PV2), 6 (SP2), 8 (TSP1), 12 (TSP2), 16 (PV), 17 (RSP), 18 (AIN2), or 19 (AIN4), -19999 to RTH-1digit Decimal point position: RTS=1 (PV1), 2 (SP1), 8 (TSP1): decimal point position is same as that of AIN4 scale. RTS=5 (PV2), 6 (SP2), 12 (TSP2): decimal point position is same as that of RSP input. RTS=16 (PV): decimal point position is same as that of PV input scale. RTS=17 (RSP): decimal point position is same as that of RSP input scale. RTS=18 (AIN2): decimal point position is same as that of AIN2 scale. RTS=19 (AIN4): decimal point position is same as that of AIN4 scale.
D5324	O1RS	Retransmission output type of OUT current output	Same as D5321
D5325	O1RH	Maximum value of retransmission output scale of OUT current output	When O1RS=1 (PV1), 2 (SP1), 5 (PV2), 6 (SP2), 8 (TSP1), 12 (TSP2), 16 (PV), 17 (RSP), 18 (AIN2), or 19 (AIN4), O1RL+1digit to 30000 Decimal point position: O1RS=1 (PV1), 2 (SP1), 8 (TSP1): decimal point position is same as that of PV input. O1RS=5 (PV2), 6 (SP2), 12 (TSP2): decimal point position is same as that of RSP input. O1RS=16 (PV): decimal point position is same as that of PV input scale. O1RS=17 (RSP): decimal point position is same as that of RSP input scale. O1RS=18 (AIN2): decimal point position is same as that of AIN2 scale. O1RS=19 (AIN4): decimal point position is same as that of AIN4 scale.
D5326	O1RL	Minimum value of retransmission output scale of OUT current output	When O1RS=1 (PV1), 2 (SP1), 5 (PV2), 6 (SP2), 8 (TSP1), 12 (TSP2), 16 (PV), 17 (RSP), 18 (AIN2), 19 (AIN4), -19999 to O1RH-1digit O1RS=1 (PV1), 2 (SP1), 8 (TSP1): decimal point position is same as that of PV input. O1RS=5 (PV2), 6 (SP2), 12 (TSP2): decimal point position is same as that of RSP input. O1RS=16 (PV): decimal point position is same as that of PV input scale. O1RS=17 (RSP): decimal point position is same as that of RSP input scale. O1RS=18 (AIN2): decimal point position is same as that of AIN2 scale. O1RS=19 (AIN4): decimal point position is same as that of AIN4 scale.

6.4 UT55A/UT52A/UP55A D Registers

Register No.		Description	Range and meaning of value
D5327	O2RS	Retransmission output type of OUT2 current output	Aame as D5321
D5328	O2RH	Maximum value of retransmission output scale of OUT2 current output	When O2RS=1 (PV1), 2 (SP1), 5 (PV2), 6 (SP2), 8 (TSP1), 12 (TSP2), 16 (PV), 17 (RSP), 18 (AIN2), or 19 (AIN4), O2RL+1digit to 30000 Decimal point position: O2RS=1 (PV1), 2 (SP1), 8 (TSP1): decimal point position is same as that of PV input. O2RS=5 (PV2), 6 (SP2), 12 (TSP2): decimal point position is same as that of RSP input. O2RS=16 (PV): decimal point position is same as that of PV input scale. O2RS=17 (RSP): decimal point position is same as that of RSP input scale. O2RS=18 (AIN2): decimal point position is same as that of AIN2 scale. O2RS=19 (AIN4): decimal point position is same as that of AIN4 scale.
D5329	O2RL	Minimum value of retransmission output scale of OUT2 current output	When O2RS=1 (PV1), 2 (SP1), 5 (PV2), 6 (SP2), 8 (TSP1), 12 (TSP2), 16 (PV), 17 (RSP), 18 (AIN2), 19 (AIN4), -19999 to O2RH-1digit Decimal point position: O2RS=1 (PV1), 2 (SP1), 8 (TSP1): decimal point position is same as that of PV input. O2RS=5 (PV2), 6 (SP2), 12 (TSP2): decimal point position is same as that of RSP input. O2RS=16 (PV): decimal point position is same as that of PV input scale. O2RS=17 (RSP): decimal point position is same as that of RSP input scale. O2RS=18 (AIN2): decimal point position is same as that of AIN2 scale. O2RS=19 (AIN4): decimal point position is same as that of AIN4 scale.
D5330			
D5331	OU.H	100% segmental point of OUT current output	-100.0 to 200.0%
D5332	OU.L	0% segmental point of OUT current output	
D5333	OU2.H	100% segmental point of OUT2 current output	
D5334	OU2.L	0% segmental point of OUT2 current output	
D5335	RET.H	100% segmental point of RET current output	
D5336	RET.L	0% segmental point of RET current output	
D5337 to D5340			
D5341	OU.A	OUT current output range	0: 4-20 (4 to 20 mA)
D5342	OU2.A	OUT2 current output range	1: 0-20 (0 to 20 mA) 2: 20-4 (20 to 4 mA)
D5343	RET.A	RET current output range	3: 20-0 (20 to 0 mA)
D5344 to D5400			

Heater Break Alarm Setting (D5401 to D5500)

Register No.		Description	Range and meaning of value
D5401	HB1.S	Heater break alarm-1 function selection	0: Heater current measurement 1: Heater break alarm
D5402	HB2.S	Heater break alarm-2 function selection	
D5403	HB1	Heater break alarm-1 current setpoint	0: OFF 0.1 to 300.0 Arms
D5404	HB2	Heater break alarm-2 current setpoint	
D5405	CT1.T	CT1 coil winding number ratio	1 to 3300
D5406	CT2.T	CT2 coil winding number ratio	
D5407	HDN1	Heater break alarm-1 On-delay timer	0 to 5999 (second)
D5408	HDN2	Heater break alarm-2 On-delay timer	
D5409	HDF1	Heater break alarm-1 Off-delay timer	0 to 5999 (second)
D5410	HDF2	Heater break alarm-2 Off-delay timer	
D5411	HB1.D	Heater break alarm-1 contact type	0: CLS (When the event occurs, the contact is closed.) 1: OPN (When the event occurs, the contact is opened.)
D5412	HB2.D	Heater break alarm-2 contact type	
D5413 to D5500			

6.4 UT55A/UT52A/UP55A D Registers

Communication Setting (D5501 to D5700)

Register No.		Description	Range and meaning of value
D5501	PSL_E1	Protocol selection	0: PCL (PC link communication) 1: PCLSM (PC link communication (with checksum)) 2: LADR (Ladder communication) 3: CO-M (Coordinated master station) 4: CO-S (Coordinated slave station) 7: MBASC (Modbus (ASCII)) 8: MBRTU (Modbus (RTU)) 10: CO-S1 (Coordinated slave station (Loop-1 mode)) 11: CO-S2 (Coordinated slave station (Loop-2 mode)) 12: P-P (Peer-to-peer communication)
D5502	BPS_E1	Baud rate	0: 600 (600 bps) 1: 1200 (1200 bps) 2: 2400 (2400 bps) 3: 4800 (4800 bps) 4: 9600 (9600 bps) 5: 19200 (19.2k bps) 6: 38400 (38.4k bps)
D5503	PRI_E1	Parity	0: NONE (None) 1: EVEN (Even) 2: ODD (Odd)
D5504	STP_E1	Stop bit	1: 1 bit, 2: 2 bit
D5505	DLN_E1	Data length	7: 7 bit, 8: 8bit
D5506	ADR_E1	Address	1 to 99
D5507	RP.T_E1	Minimum response time	0 to 10 (x10ms)
D5508 ro D5520			
D5521	PSL_E3	Protocol selection	0: PCL (PC link communication) 1: PCLSM (PC link communication (with checksum)) 2: LADR (Ladder communication) 3: CO-M (Coordinated master station) 4: CO-S (Coordinated slave station) * 7: MBASC (Modbus (ASCII)) 8: MBRTU (Modbus (RTU)) 9: CO-M2 (Coordinated master station (Loop-2 mode)) ** 10: CO-S1 (Coordinated slave station (Loop-1 mode)) * 11: CO-S2 (Coordinated slave station (Loop-2 mode)) * 12: P-P (Peer-to-peer communication) *: For UT55A only **: For UP55A only
D5522	BPS_E3	Baud rate	Same as D5502
D5523	PRI_E3	Parity	Same as D5503
D5524	STP_E3	Stop bit	1: 1 bit, 2: 2 bit
D5525	DLN_E3	Data length	7: 7 bit, 8: 8 bit
D5526	ADR_E3	Address	1 to 99
D5527	RP.T_E3	Minimum response time	0 to 10 (x10ms)
D5528 to D5530			
D5531	PSL_E4	Protocol selection	Same as D5521
D5532	BPS_E4	Baud rate	0: 600 (600 bps) 1: 1200 (1200 bps) 2: 2400 (2400 bps) 3: 4800 (4800 bps) 4: 9600 (9600 bps) 5: 19200 (19.2k bps)
D5533	PRI_E4	Parity	Same as D5503
D5534	STP_E4	Stop bit	1: 1 bit, 2: 2 bit
D5535	DLN_E4	Data length	7: 7 bit, 8: 8 bit
D5536	ADR_E4	Address	1 to 99
D5537	RP.T_E4	Minimum response time	0 to 10 (x10ms)
D5538 to D5540			
D5541	HSR_E3	High-speed response mode	0: OFF, 1 to 8

Register No.	Description		Range and meaning of value
D5542	BPS_E3	Baud rate	4: 9600 (9600 bps) 5: 19200 (19.2k bps) 6: 38400 (38.4k bps)
D5543	PRI_E3	Parity	0: NONE (None) 1: EVEN (Even) 2: ODD (Odd)
D5544	IP1_E3	IP address 1	0 to 255 Address : D5542.D5543.D5544.D5545
D5545	IP2_E3	IP address 2	
D5546	IP3_E3	IP address 3	
D5547	IP4_E3	IP address 4	
D5548	SM1_E3	Subnet mask 1	0 to 255 Address : D5546.D5547.D5548.D5549
D5549	SM2_E3	Subnet mask 2	
D5550	SM3_E3	Subnet mask 3	
D5551	SM4_E3	Subnet mask 4	
D5552	DG1_E3	Default gateway 1	0 to 255 Address : D5550.D5551.D5552.D5553
D5553	DG2_E3	Default gateway 2	
D5554	DG3_E3	Default gateway 3	
D5555	DG4_E3	Default gateway 4	
D5556	PRT_E3	Port number	502, 1024 to 65535
D5557	IPAR_E3	IP access restriction	0: OFF (Disable) 1: ON (Enable)
D5558	1.IP1_E3	Permitted IP address 1-1	0 to 255 Address : D5556.D5557.D5558.D5559
D5559	1.IP2_E3	Permitted IP address 1-2	
D5560	1.IP3_E3	Permitted IP address 1-3	
D5561	1.IP4_E3	Permitted IP address 1-4	
D5562	2.IP1_E3	Permitted IP address 2-1	0 to 255 Address : D5560.D5561.D5562.D5563
D5563	2.IP2_E3	Permitted IP address 2-2	
D5564	2.IP3_E3	Permitted IP address 2-3	
D5565	2.IP4_E3	Permitted IP address 2-4	
D5566	ESW_E3	Ethernet setting switch	0: OFF, 1: ON (Enable) Setting this parameter to "1: ON" enables the Ethernet communication parameter settings. * The parameter ESW automatically returns to "0: OFF" after "1: ON" is set.
D5567 to D5570			
D5571	MAC1_E3	MAC address 1 *1	0000 to FFFF (Hex) Arrangement: D5771, D5772, D5773
D5572	MAC2_E3	MAC address 2 *1	
D5573	MAC3_E3	MAC address 3 *1	
D5574 to D5580			
D5581	BR_E3-C *2	Baud rate (for CC-link communication)	0: 156K (156k bps) 1: 625K (625k bps) 2: 2.5M (2.5M bps) 3: 5M (5M bps) 4: 10M (10M bps)
D5582	ADR_E3-C *2	Address (for CC-link communication)	1 to 64
D5583	BPS_E3-C *2	Baud rate (for CC-link communication)	4: 9600 (9600 bps) 5: 19200 (19.2k bps) 6: 38400 (38.4k bps)
D5584	FILE_E3-C *2	Profile number (for CC-link communication)	UT55A: 0 to 5 UP55A: 0, 11 to 15
D5585	SCAN_E3-C *2	Automatic rescan time (for CC-link communication)	0: OFF 1: 1M (1 minute) 2: 10M (10 minutes) 3: 30M (30 minutes) 4: 60M (60 minutes)
D5586 to D5590			

*1: With regards to the information on D5571 to D5573, three D registers comprise one parameter data.

*2: Same parameter exists in other menu. "-C" is added to the end of the parameter in CC-L menu (for CC-Link communication).

6.4 UT55A/UT52A/UP55A D Registers

Register No.	Description		Range and meaning of value
D5591	BR_E3-D *1	Baud rate (for DeviceNet communication)	0: 125K (125k bps) 1: 250K (250k bps) 2: 500K (500k bps)
D5592	ADR_E3-D *1	Address (for DeviceNet communication)	0 to 63
D5593	BPS_E3-D *1	Baud rate (for DeviceNet communication)	Same as D5583
D5594	FILE_E3-D *1	Profile number (for DeviceNet communication)	Same as D5584
D5595	SCAN_E3-C *1	Automatic rescan time (for DeviceNet communication)	Same as D5585
D5596 to D5600			
D5601	BR_E3-P *1	Baud rate (for PROFIBUS-DP communication)	0: 9.6K (9.6k bps) 1: .2K (19.2k bps) 2: 93.75K (93.75k bps) 3: 187.5K (187.5k bps) 4: 0.5M (0.5M bps) 5: 1.5M (1.5M bps) 6: 3M (3M bps) 7: 6M (6M bps) 8: 12M (12M bps) 9: AUTO 10: 45.45K (45.45k bps)
D5602	ADR_E3-P *1	Address (for PROFIBUS-DP communication)	0 to 125
D5603	BPS_E3-P *1	Baud rate (for PROFIBUS-DP communication)	Same as D5583
D5604	FILE_E3-P *1	Profile number (for PROFIBUS-DP communication)	Same as D5584
D5605	SCAN_E3-P *1	Automatic rescan time (for PROFIBUS-DP communication)	Same as D5585
D5606 to D5700			

*1: Same parameter exists in other menu. "-D" is added to the end of the parameter in DNET menu (for DeviceNet communication), and "-P" is added to the end of the parameter in PROF menu (for PROFIBUS-DP communication).

Key Operation Setting, Display Function Setting, and SELECT Display Setting (D5701 to D5800)

Register No.		Description	Range and meaning of value
D5701	F1 *1	User function key-1 action setting	0: OFF (Disable) 1: A/M (AUTO/MAN switch) 2: C/A/M (CAS/AUTO/MAN switch) 3: R/L1 (REM/LCL switch) 4: R/L2 (Loop-2 REM/LCL switch) 5: S/R (STOP/RUN switch) 6: CAS (Switch to CAS) 7: AUTO (Switch to AUTO) 8: MAN (Switch to MAN) 9: REM1 (Switch to REM) 10: LCL1 (Switch to LCL) 11: REM2 (Switch to Loop-2 REM) 12: LCL2 (Switch to Loop-2 LCL) 13: STOP (Switch to STOP) 14: RUN (Switch to RUN) 17: AT (Auto-tuning) 18: LTUP (LCD brightness UP) 19: LTDN (LCD brightness DOWN) 20: BRI (Adjust LCD brightness) 21: LCD (LCD backlight ON/OFF switch) 22: LAT (Latch release) 23: PID (PID tuning switch) Loop-2 setting values are unavailable in Single-loop control.
D5702	F2 *1	User function key-2 action setting	0: OFF (Disable) 1: A/M (AUTO/MAN switch) 2: C/A/M (CAS/AUTO/MAN switch) 3: R/L1 (REM/LCL switch) 4: R/L2 (Loop-2 REM/LCL switch) 5: S/R (STOP/RUN switch) 6: CAS (Switch to CAS) 7: AUTO (Switch to AUTO) 8: MAN (Switch to MAN) 9: REM1 (Switch to REM) 10: LCL1 (Switch to LCL) 11: REM2 (Switch to Loop-2 REM) 12: LCL2 (Switch to Loop-2 LCL) 13: STOP (Switch to STOP) 14: RUN (Switch to RUN) 17: AT (Auto-tuning) 18: LTUP (LCD brightness UP) 19: LTDN (LCD brightness DOWN) 20: BRI (Adjust LCD brightness) 21: LCD (LCD backlight ON/OFF switch) 22: LAT (Latch release) 23: PID (PID tuning switch) Loop-2 setting values are unavailable in Single-loop control.
D5703	Fn *1	User function key-n action setting	0: OFF (Disable) 1: A/M (AUTO/MAN switch) 2: C/A/M (CAS/AUTO/MAN switch) 3: R/L1 (REM/LCL switch) 4: R/L2 (Loop-2 REM/LCL switch) 5: S/R (STOP/RUN switch) 6: CAS (Switch to CAS) 7: AUTO (Switch to AUTO) 8: MAN (Switch to MAN) 9: REM1 (Switch to REM) 10: LCL1 (Switch to LCL) 11: REM2 (Switch to Loop-2 REM) 12: LCL2 (Switch to Loop-2 LCL) 13: STOP (Switch to STOP) 14: RUN (Switch to RUN) 17: AT (Auto-tuning) 18: LTUP (LCD brightness UP) 19: LTDN (LCD brightness DOWN) 20: BRI (Adjust LCD brightness) 21: LCD (LCD backlight ON/OFF switch) 22: LAT (Latch release) 23: PID (PID tuning switch) Loop-2 setting values are unavailable in Single-loop control.
D5704	A/M-K *1	A/M key action setting	0: OFF (Disable) 1: A/M (AUTO/MAN switch) 2: C/A/M (CAS/AUTO/MAN switch) 3: R/L1 (REM/LCL switch) 4: R/L2 (Loop-2 REM/LCL switch) 5: S/R (STOP/RUN switch) 6: CAS (Switch to CAS) 7: AUTO (Switch to AUTO) 8: MAN (Switch to MAN)
D5705	RUN-K *1	RUN key action setting	0: OFF (Disable) 1: PROG (Switch to PROG (Start of program operation)) 2: RESET (Switch to RESET (Stop of program operation)) 3: LOCAL (Switch to LOCAL(LSP) (Start of local-mode operation)) 4: REM (Switch to REMOTE) 5: P/R (PROG/RESET switch) 6: P/H (PROG/HOLD switch) 7: P/L (PROG/LOCAL(LSP) switch) 8: L/C (LOCAL(LSP)/CAS switch) 9: HLD (Switch to HOLD (Start of hold-mode operation)) 10: ADV (Advance of segment) 11: A/M1 (AUTO/MAN switch) 12: A/M2 (Loop-2 AUTO/MAN switch) 13: PRG1 (Switch to PROG1 (Start of program-1 operation)) 14: PRG2 (Switch to PROG2 (Start of program-2 operation)) 17: AT (Auto-tuning) 18: LTUP (LCD brightness UP) 19: LTDN (LCD brightness DOWN) 20: BRI (Adjust LCD brightness) 21: LCD (LCD backlight ON/OFF switch) 22: LAT (Latch release) 23: PID (PID tuning switch) 24: PTN (Program pattern number switch) 25: MODE (Operation mode)
D5706	RST-K *1	RST key action setting	0: OFF (Disable) 1: A/M (AUTO/MAN switch) 2: C/A/M (CAS/AUTO/MAN switch) 3: R/L1 (REM/LCL switch) 4: R/L2 (Loop-2 REM/LCL switch) 5: S/R (STOP/RUN switch) 6: CAS (Switch to CAS) 7: AUTO (Switch to AUTO) 8: MAN (Switch to MAN)
D5707	PTN-K *1	PTN Key action setting	0: OFF (Disable) 1: A/M (AUTO/MAN switch) 2: C/A/M (CAS/AUTO/MAN switch) 3: R/L1 (REM/LCL switch) 4: R/L2 (Loop-2 REM/LCL switch) 5: S/R (STOP/RUN switch) 6: CAS (Switch to CAS) 7: AUTO (Switch to AUTO) 8: MAN (Switch to MAN)
D5708	MODE-K *1	MODE key action setting	0: OFF (Disable) 1: A/M (AUTO/MAN switch) 2: C/A/M (CAS/AUTO/MAN switch) 3: R/L1 (REM/LCL switch) 4: R/L2 (Loop-2 REM/LCL switch) 5: S/R (STOP/RUN switch) 6: CAS (Switch to CAS) 7: AUTO (Switch to AUTO) 8: MAN (Switch to MAN)
D5709 to D5710			
D5711	DVB_L1	Loop-1 deviation display band	Permits a change in the span of deviation shown on the front-panel deviation monitor.
D5712	DVB_L2	Loop-2 deviation display band	Displayed only for UT55A. 0.0 to 100.0% of PV input range span (EUS)

*1: Same parameter exists in other menu. "-K" is added to the end of the parameter in KEY menu.

6.4 UT55A/UT52A/UP55A D Registers

Register No.		Description	Range and meaning of value
D5713	PCMD_L1	Loop-1 active color PV display switch	0: Fixed in white 1: Fixed in red 2: Link to alarm 1 (Alarm OFF: white, Alarm ON: red) 3: Link to alarm 1 (Alarm OFF: red, Alarm ON: white) 4: Link to alarm 1 or 2 (Alarm OFF: white, Alarm ON: red) 5: Link to alarm 1 or 2 (Alarm OFF: red, Alarm ON: white) 6: PV limit (Within range: white, Out of range: red) 7: PV limit (Within range: red, Out of range: white) 8: SP deviation (Within deviation: white, Out of deviation: red) 9: SP deviation (Within deviation: red, Out of deviation: white) 10: Link to DI (ON: red, OFF: white)
D5714	PCH_L1	Loop-1 PV color change high limit	Set a display value when in PV limit or SP deviation.
D5715	PCL_L1	Loop-1 PV color change low limit	-19999 to 30000 (Set a value within the input range.)
D5716	PCMD_L2	Loop-2 active color PV display switch	Decimal point position depends on the input type.
D5717	PCH_L2	Loop-2 PV color change high limit	Same as D5713
D5718	PCL_L2	Loop-2 PV color change low limit	Same as D5714
D5719	BAR1	Upper bar-graph display registration	0: Disable 1: OUT, Heating-side OUT, Internal value in Position proportional control 2: Cooling-side OUT 3: PV 4: SP 5: Deviation 6: Loop-2 OUT, Loop-2 heating-side OUT 7: Loop-2 cooling-side OUT 8: Loop-2 PV 9: Loop-2 SP 10: Loop-2 deviation 11 to 16: Disable 17: Feedback input (valve opening) 18: PV terminals analog input 19: RSP terminals analog input 20: AIN2 terminals analog input 21: AIN4 terminals analog input 22: Segment progress * 23: Time event and alarm status * *: For BAR1 only
D5720	BAR2	Lower bar-graph display registration	
D5721	BDV_L1	Loop-1 bar-graph deviation display band	0.0 to 100.0% of PV input range span (EUS)
D5722	BDV_L2	Loop-2 bar-graph deviation display band	

Register No.		Description	Range and meaning of value
D5723	EV1_L1	Loop-1 EV1 display condition registration	Setting range: 4001 to 6304 OFF: Disable
D5724	EV2_L1	Loop-1 EV2 display condition registration	4321: Link to alarm 1 (Lit when the alarm occurs) 4322: Link to alarm 2 (Lit when the alarm occurs) 4323: Link to alarm 3 (Lit when the alarm occurs) 4325: Link to alarm 4 (Lit when the alarm occurs) 4326: Link to alarm 5 (Lit when the alarm occurs) 4327: Link to alarm 6 (Lit when the alarm occurs) 4329: Link to alarm 7 (Lit when the alarm occurs) 4330: Link to alarm 8 (Lit when the alarm occurs)
D5725	EV3_L1	Loop-1 EV3 display condition registration	4337: Link to Loop-2 alarm 1 (Lit when the alarm occurs) * 4338: Link to Loop-2 alarm 2 (Lit when the alarm occurs) * 4339: Link to Loop-2 alarm 3 (Lit when the alarm occurs) * 4341: Link to Loop-2 alarm 4 (Lit when the alarm occurs) * 4342: Link to Loop-2 alarm 5 (Lit when the alarm occurs) * 4343: Link to Loop-2 alarm 6 (Lit when the alarm occurs) * 4345: Link to Loop-2 alarm 7 (Lit when the alarm occurs) * 4346: Link to Loop-2 alarm 8 (Lit when the alarm occurs) *
D5726	EV4_L1	Loop-1 EV4 display condition registration	4529: Heater break alarm 1 (Lit when the alarm occurs) * 4530: Heater break alarm 2 (Lit when the alarm occurs) *
D5727	EV5_L1	Loop-1 EV5 display condition registration	*: For UT55A/UT52A only
D5728	EV6_L1	Loop-1 EV6 display condition registration	5025 to 5027: Link to DI1-DI3 (Lit when the contact is closed)** 5041 to 5046: Link to DI11-DI16 (E1-terminal area) (Lit when the contact is closed)**
D5729	EV7_L1	Loop-1 EV7 display condition registration	5057 to 5062: Link to DI21-DI26 (E2-terminal area) (Lit when the contact is closed)** 5073 to 5077: Link to DI31-DI35 (E3-terminal area) (Lit when the contact is closed)**
D5730	EV8_L1	Loop-1 EV8 display condition registration	5089 to 5094: Link to DI41-DI46 (E4-terminal area) (Lit when the contact is closed)** 5153 to 5155: Link to AL1-AL3 (Lit when the contact is closed)** 5169 to 5173: Link to DO11-DO15 (E1-terminal area) (Lit when the contact is closed)**
D5731	EV1_L2	Loop-2 EV1 display condition registration	5185 to 5189: Link to DO21-DO25 (E2-terminal area) (Lit when the contact is closed)** 5201 to 5205: Link to DO31-DO35 (E3-terminal area) (Lit when the contact is closed)** 5217 to 5221: Link to DO41-DO45 (E4-terminal area) (Lit when the contact is closed)**
D5732	EV2_L2	Loop-2 EV2 display condition registration	**: Initial value. The contact action changes by the setting of each "contact type" parameter.
D5733	EV3_L2	Loop-2 EV3 display condition registration	4785: Link to PV event 1/local event-1 (Lit when occurs) *** 4786: Link to PV event 2/local event-2 (Lit when occurs) *** 4787: Link to PV event 3/local event-3 (Lit when occurs) *** 4789: Link to PV event 4/local event-4 (Lit when occurs) *** 4790: Link to PV event 5/local event-5 (Lit when occurs) *** 4791: Link to PV event 6/local event-6 (Lit when occurs) *** 4793: Link to PV event 7/local event-7 (Lit when occurs) *** 4794: Link to PV event 8/local event-8 (Lit when occurs) ***
D5734	EV4_L2	Loop-2 EV4 display condition registration	4817: Link to time event 1 (Lit when occurs) *** 4818: Link to time event 2 (Lit when occurs) *** 4819: Link to time event 3 (Lit when occurs) *** 4821: Link to time event 4 (Lit when occurs) *** 4822: Link to time event 5 (Lit when occurs) *** 4823: Link to time event 6 (Lit when occurs) *** 4825: Link to time event 7 (Lit when occurs) *** 4826: Link to time event 8 (Lit when occurs) *** 4833: Link to time event 9 (Lit when occurs) *** 4834: Link to time event 10 (Lit when occurs) ***
D5735	EV5_L2	Loop-2 EV5 display condition registration	4835: Link to time event 11 (Lit when occurs) *** 4837: Link to time event 12 (Lit when occurs) *** 4838: Link to time event 13 (Lit when occurs) *** 4839: Link to time event 14 (Lit when occurs) *** 4841: Link to time event 15 (Lit when occurs) *** 4842: Link to time event 16 (Lit when occurs) ***
D5736	EV6_L2	Loop-2 EV6 display condition registration	***: For UP55A only
D5737	EV7_L2	Loop-2 EV7 display condition registration	For other functions, see the Chapter 7 Functions and Applications of I Relays (for UT55A/UT52A/UP55A).
D5738	EV8_L2	Loop-2 EV8 display condition registration	

6.4 UT55A/UT52A/UP55A D Registers

Register No.		Description	Range and meaning of value
D5739	PV.D	PV display area ON/OFF	0: OFF (Nondisplay) 1: ON (Display)
D5740	SP.D	Setpoint display area ON/OFF	
D5741	STS.D	Status display area ON/OFF	
D5742	SPD	Scroll speed	
D5743	GUID	Guide display ON/OFF	0: OFF (Nondisplay) 1: ON (Display)
D5744	HOME	Home Operation Display setting	0: SP1 (SP Display) 1: SP2 (Loop-2 SP Display) 2: OUT1 (OUT Display) 3: OUT2 (Loop-2 OUT Display) 4: HCO (Heating/cooling OUT Display) 5: VP (Valve Position Display) 6: MV (Position Proportional Computation Output Display) 8: PID1 (PID Number Display) 9: PID2 (Loop-2 PID Number Display) 10: HC1 (Heater Break Alarm-1 Current Display) 11: HC2 (Heater Break Alarm-2 Current Display) 12: PV1 (PV2/PV1 Display) 13: PV2 (PV1/PV2 Display) 14: PV (PV Analog Input Display) 15: RSP (RSP Analog Input Display) 16: AIN2 (AIN2 Analog Input Display) 17: AIN4 (AIN4 Analog Input Display) 18: CS1 (SELECT Display 1) 19: CS2 (SELECT Display 2) 20: CS3 (SELECT Display 3) 21: CS4 (SELECT Display 4) 22: CS5 (SELECT Display 5) 23: TSP1 (TSP Display) * 24: TSP2 (Loop-2 TSP Display) * 25: R.TIM (Remaining Segment-tim Display) * 26: SEG.N (Segment Number Display) * 27: R.CYC (Remaining Repetition Display) * 28: PTN (Program Pattern Display) * 29: AL5.8.1 (Alarm-5 to -8 Status Display) * 30: AL5.8.2 (Loop-2 Alarm-5 to -8 Status Display) * *: For UP55A only
D5745	ECO	Economy mode	0: OFF (Disable) 1: Economy mode ON (All indications except PV display OFF) 2: Economy mode ON (All indications OFF) 3: Brightness 10 % (whole indication)
D5746	BRI	Brightness	(Dark) 1 to 5 (Bright)
D5747	B.PVW	White brightness adjustment of PV display	Adjusts the white brightness of PV display. (Dark) -4 to 4 (Bright)
D5748	B.PVR	Red brightness adjustment of PV display	Adjusts the red brightness of PV display. (Dark) -4 to 4 (Bright)
D5749	B.SP	Brightness adjustment of Setpoint display	Adjusts the brightness of SP display. (Dark) -4 to 4 (Bright)
D5750	B.BAR	Brightness adjustment of Bar-graph display	Adjusts the brightness of SP display. (Dark) -4 to 4 (Bright)
D5751	B.STS	Brightness adjustment of Status indicator	Adjusts the brightness of Status display. (Dark) -4 to 4 (Bright)
D5752			
D5753	D.CYC	Display update cycle	1: 100 ms 2: 200 ms 3: 500 ms 4: 1 s 5: 2 s
D5754	OP.JP	AUTORETURN TO OPERATION DISPLAY	Automatically returned to the Operation Display when there has been no keystroke operation for 5 minutes. 0: OFF (Not automatically returned) 1: ON (Automatically returned)
D5755	MLSD	Least significant digital mask of PV display	0: OFF (With least significant digit) 1: ON (Without least significant digit)
D5756	PTSL	Program display pattern selection	0: PTN (Pattern display) 1: SK.RP (Ramp and soak display)

6.4 UT55A/UT52A/UP55A D Registers

Register No.		Description	Range and meaning of value
D5757 to D5760			
D5761	CS1	SELECT Display-1 registration	Register the operation parameter (except the Operation Mode) that is frequently modified to display it in the Operation Display. (Register the register number of the parameter)
D5762	CS2	SELECT Display-2 registration	
D5763	CS3	SELECT Display-3 registration	UT55A/UT52A 0: OFF 2301 to 5000
D5764	CS4	SELECT Display-4 registration	
D5765	CS5	SELECT Display-5 registration	UP55A 0: OFF 2201 to 5000
D5766 to D5770			
D5770	CS10	SELECT parameter-10 registration	Register the parameter that is frequently modified in the Operation Parameter Setting Display. (Register the register number of the parameter)
D5771	CS11	SELECT parameter-11 registration	
D5772	CS12	SELECT parameter-12 registration	UT55A/UT52A 0: OFF 2301 to 5000
D5773	CS13	SELECT parameter-13 registration	
D5774	CS14	SELECT parameter-14 registration	UP55A 0: OFF 2201 to 5000
D5775	CS15	SELECT parameter-15 registration	
D5776	CS16	SELECT parameter-16 registration	
D5777	CS17	SELECT parameter-17 registration	
D5778	CS18	SELECT parameter-18 registration	
D5779	CS19	SELECT parameter-19 registration	
D5780 to D5800			

6.4 UT55A/UT52A/UP55A D Registers

Lock Setting (Key Lock/Menu Lock) (D5801 to D5900)

Register No.	Description		Range and meaning of value
D5801	U.SP_L1	Loop-1 SP Display lock	0: OFF (Display) 1: ON (Nondisplay)
D5802	U.SP_L2	Loop-2 SP Display lock	
D5803	U.OUT_L1	Loop-1 OUT Display lock	
D5804	U.OUT_L2	Loop-2 OUT Display lock	
D5805	U.HCO	Heating/cooling OUT Display lock	
D5806	U.VP	Valve Position Display lock	
D5807	U.MV	Position Proportional Computation Output Display lock	
D5808	U.TSP_L2	Loop-2 TSP Display lock	
D5809	U.PID_L1	Loop-1 PID Number Display lock	
D5810	U.PID_L2	Loop-2 PID Number Display lock	
D5811	U.HC	Heater Break Alarm Current Value Display lock	
D5812	U.PV1	PV2/PV1 Display lock	
D5813	U.PV2	PV1/PV2 Display lock	
D5814	U.PV	PV Analog Input Display lock	
D5815	U.RSP	RSP Analog Input Display lock	
D5816	U.AI2	AIN2 Analog Input Display lock	
D5817	U.AI4	AIN4 Analog Input Display lock	
D5818	COM.W	Communication write enable/disable	0: OFF (Enable) 1: ON (Disable)
D5819	DATA-L *1	Front panel parameter data key lock	0: OFF (Unlock) 1: ON (Lock)
D5820	A/M-L *1	Front panel A/M key lock	
D5821	RUN-L *1	Front panel RUN key lock	
D5822	RST-L *1	Front panel RST key lock	
D5823	PTN-L *1	Front panel PTN key lock	
D5824	MODE-L *1	Front panel MODE key lock	
D5825	U.TSP_L1	Loop-1 TSP Display lock	
D5826	U.TM	Remaining Segment-tim Display lock	
D5827	U.SEG	Segment Number Display lock	
D5828	U.RCY	Remaining Repetition Display lock	
D5829	U.PTN	Program Pattern Display lock	
D5830	U.AL_L1	Loop-1 Alarm-5 to -8 Display lock	
D5831	CTL-L *1	[CTL] menu lock	
D5832	PV-L *1	[PV] menu lock	
D5833	RSP_E1-L *1	[RSP] menu lock (E1-terminal area)	
D5834	AIN2_E2-L *1	[AIN2] menu lock (E2-terminal area)	
D5835	AIN4_E4-L *1	[AIN4] menu lock (E4-terminal area)	
D5836	MPV_L1-L *1	Loop-1 [MPV] menu lock	
D5837	MPV_L2-L *1	Loop-2 [MPV] menu lock	
D5838	OUT-L *1	[OUT] menu lock	
D5839	HBA-L *1	[HBA] menu lock	
D5840	R485_E1-L *1	[R485] menu lock (E1-terminal area)	
D5841	R485_E3-L *1	[R485] menu lock (E3-terminal area)	
D5842	R485_E4-L *1	[R485] menu lock (E4-terminal area)	
D5843	ETHR_E3-L *1	[ETHR] menu lock (E3-terminal area)	
D5844	PROF_E3-L *1	[PROF] menu lock (E3-terminal area)	
D5845	DNET_E3-L *1	[DNET] menu lock (E3-terminal area)	
D5846	CC-L_E3-L *1	[CC-L] menu lock (E3-terminal area)	
D5847	KEY-L *1	[KEY] menu lock	
D5848	DISP-L *1	[DISP] menu lock	
D5849	CSEL-L *1	[CSEL] menu lock	
D5850	KLOC-L *1	[KLOC] menu lock	
D5851	DI.SL-L *1	[DI.SL] menu lock	
D5852	DI.NU-L *1	[DI.NU] menu lock	

*1: Same parameter exists in other menu. "-L" is added to the end of the parameter in KLOC menu or MLOC menu.

Register No.	Description		Range and meaning of value
D5853	DI.D-L *1	[DI.D] menu lock	0: OFF (Display) 1: ON (Nondisplay)
D5854	DI.D_E1-L *1	[DI.D] menu lock (E1-terminal area)	
D5855	DI.D_E2-L *1	[DI.D] menu lock (E2-terminal area)	
D5856	DI.D_E3-L *1	[DI.D] menu lock (E3-terminal area)	
D5857	DI.D_E4-L *1	[DI.D] menu lock (E4-terminal area)	
D5858	ALM-L *1	[ALM] menu lock	
D5859	DO_E1-L *1	[DO] menu lock (E1-terminal area)	
D5860	DO_E2-L *1	[DO] menu lock (E2-terminal area)	
D5861	DO_E3-L *1	[DO] menu lock (E3-terminal area)	
D5862	DO_E4-L *1	[DO] menu lock (E4-terminal area)	
D5863	I/O-L *1	[I/O] menu lock	
D5864	SYS-L *1	[SYS] menu lock	
D5865	INIT-L *1	[INIT] menu lock	
D5866	VER-L *1	[VER] menu lock	
D5867	LVL-L *1	[LVL] menu lock	
D5868	MODE-L *1	[MODE] menu lock	
D5869	CS-L *1	[CS] menu lock	
D5870	SP_L1-L *1	Loop-1 [SP] menu lock	
D5871	SPS_L1-L *1	Loop-1 [SPS] menu lock	
D5872	ALRM_L1-L *1	Loop-1 [ALRM] menu lock	
D5873	PROG-L	[PROG] menu lock	
D5874	PVS_L1-L *1	Loop-1 [PVS] menu lock	
D5875	PID_L1-L *1	Loop-1 [PID] menu lock	
D5876	TUNE_L1-L *1	Loop-1 [TUNE] menu lock	
D5877	ZONE_L1-L *1	Loop-1 [ZONE] menu lock	
D5878	SP_L2-L *1	Loop-2 [SP] menu lock	
D5879	SPS_L2-L *1	Loop-2 [SPS] menu lock	
D5880	ALRM_L2-L *1	Loop-2 [ALRM] menu lock	
D5881	PVS_L2-L *1	Loop-2 [PVS] menu lock	
D5882	PID_L2-L *1	Loop-2 [PID] menu lock	
D5883	TUNE_L2-L *1	Loop-2 [TUNE] menu lock	
D5884	ZONE_L2-L *1	Loop-2 [ZONE] menu lock	
D5885	PPAR-L *1	[PPAR] menu lock	
D5886	PYS1-L *1	[PYS1] menu lock	
D5887	PYS2-L *1	[PYS2] menu lock	
D5888	PYS3-L *1	[PYS3] menu lock	
D5889	PYS4-L *1	[PYS4] menu lock	
D5890	LOC-L *1	[LOC] menu lock	
D5891	EDIT-L *1	[EDIT] menu lock	
D5892	AL_L1-L *1	Loop-1 [AL] menu lock	
D5893	AL_L2-L *1	Loop-2 [AL] menu lock	
D5894	U.AL_L2	Loop-2 Alarm-5 to -8 Display lock	
D5895 to D5900			

*1: Same parameter exists in other menu. "-L" is added to the end of the parameter in KLOC menu or MLOC menu.

6.4 UT55A/UT52A/UP55A D Registers

DI Function Setting (D5901 to D6200)

Register No.	Description		Range and meaning of value
D5901	A/M-D *1	AUTO/MAN switch	Set an I relay number of contact input. 0: OFF (Disable) Standard terminals DI1: 5025, DI2: 5026, DI3: 5027 E1-terminal area DI11: 5041, DI12: 5042, DI13: 5043, DI14: 5044, DI15: 5045, DI16: 5046 E2-terminal area DI21: 5057, DI22: 5058, DI23: 5059, DI24: 5060, DI25: 5061, DI26: 5062 * E3-terminal area DI31: 5073, DI32: 5074, DI33: 5075, DI34: 5076, DI35: 5077 E4-terminal area DI41: 5089, DI42: 5090, DI43: 5091, DI44: 5092, DI45: 5093, DI46: 5094 * *: [DI26: 5062] and [DI46: 5094] are only for UT55A and UP55A.
D5902	R/L_L1-D *1	REMOTE/LOCAL switch	
D5903	R/L_L2-D *1	REMOTE/LOCAL switch	
D5904	S/R-D *1	STOP/RUN switch	
D5905	CAS-D *1	Switch to CAS	
D5906	AUTO-D *1	Switch to AUTO	
D5907	MAN-D *1	Switch to MAN	
D5908	REM_L1-D *1	Switch to REMOTE	
D5909	LCL_L1-D *1	Switch to LOCAL	
D5910	REM_L2-D *1	Switch to REMOTE	
D5911	LCL_L2-D *1	Switch to LOCAL	
D5912	ADV-D *1	Advance of segment	
D5913	HOLD-D *1	Switch to HOLD (Start of hold-mode operation)	
D5914	AT-D *1	Auto-tuning START/STOP switch	
D5915	TRK-D *1	Output tracking switch	
D5916	SW-D *1	PV switch	
D5917	PVHD-D *1	PV hold	
D5918	CTOA-D *1	CAS to AUTO switch	
D5919			
D5920	LAT-D *1	Latch release	
D5921	LCD-D *1	LCD backlight ON/OFF switch	
D5922	MG1-D *1	Message display interruption 1	
D5923	MG2-D *1	Message display interruption 2	
D5924	MG3-D *1	Message display interruption 3	
D5925	MG4-D *1	Message display interruption 4	
D5926	PRG-D *1	Switch to PROG (Start of program operation)	
D5927	RST-D *1	Switch to RESET (Stop of program operation)	
D5928	LOC-D *1	Switch to LOCAL (LSP) (Start of local-mode operation)	
D5929	REM-D *1	Switch to REMOTE (Start of local-mode operation)	
D5930	P/R-D *1	PROG/RESET switch	
D5931	P/L-D *1	PROG/LOCAL (LSP) switch	
D5932	WAIT-D *1	Wait ON/OFF switch	
D5933	A/M_L1-D *1	AUTO/MAN switch	
D5934	A/M_L2-D *1	Loop-2 AUTO/MAN switch	
D5935	L/C-D *1	LOCAL (LSP)/CAS switch	
D5936	P/H-D *1	PROG/HOLD switch	
D5937	PVRW_L1-D *1	Loop-1 PV red/white switch	
D5938	PVRW_L2-D *1	Loop-2 PV red/white switch	
D5939	S.HLD-D *1	Switch to HOLD for synchronized program operation	
D5940 to D5940			
D5941	SP.BC	Bit changing method of SP number	0: Status switch 1 (Operation by key keystrokes or via communication is enabled according to the conditions.) 1: Status switch 2 (Operation by key keystrokes or via communication is disabled.)

*1: Same parameter exists in other menu. "-D" is added to the end of the parameter in DI.SL menu.

6.4 UT55A/UT52A/UP55A D Registers

Register No.	Description		Range and meaning of value
D5942	SP.B0	Bit-0 of SP number	Set an I relay number of contact input. 0: OFF (Disable)
D5943	SP.B1	Bit-1 of SP number	Standard terminals DI1: 5025, DI2: 5026, DI3: 5027 E1-terminal area DI11: 5041, DI12: 5042, DI13: 5043, DI14: 5044, DI15: 5045, DI16: 5046
D5944	SP.B2	Bit-2 of SP number	E2-terminal area * DI21: 5057, DI22: 5058, DI23: 5059, DI24: 5060, DI25: 5061, DI26: 5062 *
D5945	SP.B3	Bit-3 of SP number	E3-terminal area DI31: 5073, DI32: 5074, DI33: 5075, DI34: 5076, DI35: 5077 E4-terminal area DI41: 5089, DI42: 5090, DI43: 5091, DI44: 5092, DI45: 5093, DI46: 5094 * *: [DI26: 5062] and [DI46: 5094] are only for UT55A and UP55A.
D5946			
D5947	PN.BC	Bit changing method of PID number	Same as D5941
D5948	PN.B0	Bit-0 of PID number	Same as D5942
D5949	PN.B1	Bit-1 of PID number	
D5950	PN.B2	Bit-2 of PID number	
D5951	PN.B3	Bit-3 of PID number	
D5953	PT.BC-D *1	Bit changing method of program pattern number	
D5954	PT.B0-D *1	Bit-0 of program pattern number	Same as D5942
D5955	PT.B1-D *1	Bit-1 of program pattern number	
D5956	PT.B2-D *1	Bit-2 of program pattern number	
D5957	PT.B3-D *1	Bit-3 of program pattern number	
D5958	PT.B4-D *1	Bit-4 of program pattern number	
D5959	PT.B5-D *1	Bit-5 of program pattern number	
D5960	MP.BC_L1	Bit changing method of manual preset output number	Same as D5941
D5961	MP.B0_L1	Bit-0 of manual preset output number	Same as D5942
D5962	MP.B1_L1	Bit-1 of manual preset output number	
D5963	MP.B2_L1	Bit-2 of manual preset output number	
D5964			
D5965	MP.BC_L2	Bit changing method of manual preset output number	Same as D5941
D5966	MP.B0_L2	Bit-0 of manual preset output number	Same as D5942
D5967	MP.B1_L2	Bit-1 of manual preset output number	
D5968	MP.B2_L2	Bit-2 of manual preset output number	
D5969 to D6000			
D6001	MSG1	Message-1 *2	20-digit value of alphanumeric characters can be set. Arrangement: D6001, D6002, D6003, D6004, D6005, D6006, D6007, DD6008, D6009, D6010, D6011 Write "0x00" to the register after the character string.
D6002	MSG1		
D6003	MSG1		
D6004	MSG1		
D6005	MSG1		
D6006	MSG1		
D6007	MSG1		
D6008	MSG1		
D6009	MSG1		
D6010	MSG1		
D6011	MSG1		
D6012 to D6020			

*2: With regards to the information on D6001 to D6011, D6021 to D6031, D6041 to D6051, and D6061 to D6071, 11 D registers comprise one message.

6.4 UT55A/UT52A/UP55A D Registers

DO Function Setting (D6201 to D6300)

Register No.	Description	Range and meaning of value
D6021	MSG2	20-digit value of alphanumeric characters can be set. Arrangement: D6021, D6022, D6023, D6024, D6025, D6026, D6027, D6028, D6029, D6030, D6031 Write "0x00" to the register after the character string.
D6022	MSG2	
D6023	MSG2	
D6024	MSG2	
D6025	MSG2	
D6026	MSG2	
D6027	MSG2	
D6028	MSG2	
D6029	MSG2	
D6030	MSG2	
D6031	MSG2	
D6032 to D6040		
D6041	MSG3	20-digit value of alphanumeric characters can be set. Arrangement: D6041, D6042, D6043, D6044, D6045, D6046, D6047, D6048, D6049, D6050, D6051 Write "0x00" to the register after the character string.
D6042	MSG3	
D6043	MSG3	
D6044	MSG3	
D6045	MSG3	
D6046	MSG3	
D6047	MSG3	
D6048	MSG3	
D6049	MSG3	
D6050	MSG3	
D6051	MSG3	
D6052 to D6060		
D6061	MSG4	20-digit value of alphanumeric characters can be set. Arrangement: D6061, D6062, D6063, D6064, D6065, D6066, D6067, D6068, D6069, D6070, D6071 Write "0x00" to the register after the character string.
D6062	MSG4	
D6063	MSG4	
D6064	MSG4	
D6065	MSG4	
D6066	MSG4	
D6067	MSG4	
D6068	MSG4	
D6069	MSG4	
D6070	MSG4	
D6071	MSG4	
D6072 to D6100		
D6101	DI1.D	0: The assigned function is enabled when the contact is closed. 1: The assigned function is enabled when the contact is opened.
D6102	DI2.D	
D6103	DI3.D	
D6104 to D6120		
D6121	DI1.D_E1	0: The assigned function is enabled when the contact is closed. 1: The assigned function is enabled when the contact is opened.
D6122	DI2.D_E1	
D6123	DI3.D_E1	
D6124	DI4.D_E1	
D6125	DI5.D_E1	
D6126 to D6140		
D6141	DI1.D_E2	0: The assigned function is enabled when the contact is closed. 1: The assigned function is enabled when the contact is opened.
D6142	DI2.D_E2	
D6143	DI3.D_E2	
D6144	DI4.D_E2	
D6145	DI5.D_E2	
D6146 to D6160		

*2: With regards to the information on D6001 to D6011, D6021 to D6031, D6041 to D6051, and D6061 to D6071, 11 D registers comprise one message.

6.4 UT55A/UT52A/UP55A D Registers

Register No.	Description		Range and meaning of value
D6161	D11.D_E3	DI31 contact type	0: The assigned function is enabled when the contact is closed. 1: The assigned function is enabled when the contact is opened.
D6162	D12.D_E3	DI32 contact type	
D6163	D13.D_E3	DI33 contact type	
D6164	D14.D_E3	DI34 contact type	
D6165	D15.D_E3	DI35 contact type	
D6166 to D6180			
D6181	D11.D_E4	DI41 contact type	0: The assigned function is enabled when the contact is closed. 1: The assigned function is enabled when the contact is opened.
D6182	D12.D_E4	DI42 contact type	
D6183	D13.D_E4	DI43 contact type	
D6184	D14.D_E4	DI44 contact type	
D6185	D15.D_E4	DI45 contact type	
D6186 to D6200			

6.4 UT55A/UT52A/UP55A D Registers

Register No.		Description	Range and meaning of value
D6201	AL1.S	AL1 function selection	<p>Set an I relay number (Setting range: 4001 to 6000, UP55A: 4001 to 6304). Ex.) Set the number 4353 for AL1.S to use the alarm 1.</p> <p>UT55A/UT52A 0: OFF (No function) Alarm 1: 4353 Alarm 2: 4354 Alarm 3: 4355 Alarm 4: 4357 Alarm 5: 4358 Alarm 6: 4359 Alarm 7: 4361 Alarm 8: 4362 AUTO (ON) / MAN (OFF) status: 4193 REM (ON) / LCL (OFF) status: 4194 STOP (ON) / RUN (OFF) status: 4195 Output tracking (ON) switching signal: 4201</p>
D6202	AL2.S	AL2 function selection	<p>UP55A 0: OFF (No function) PV event-1: 4801 PV event-2: 4802, PV event-3: 4803, PV event 4: 4805, PV event 5: 4806, PV event 6 4807, PV event 7: 4809, PV event 8: 4810, Time event 1: 4817, Time event 2: 4818, Time event 3: 4819, Time event 4: 4821, Time event 5: 4822, Time event 6: 4823, Time event 7: 4825, Time event 8: 4826, Time event 9: 4833, Time event 10: 4834, Time event 11: 4835, Time event 12: 4837, Time event 13: 4838, Time event 14: 4839, Time event 15: 4841, Time event 16: 4842, Alarm 1: 4353, Alarm 2: 4354, Alarm 3: 4355, Alarm 4: 4357, Alarm 5: 4358, Alarm 6: 4359, Alarm 7: 4361, Alarm 8: 4362, AUTO (ON) / MAN (OFF) status: 4177, Program RESET status: 4181, Program RUN status: 4182, Local operation status: 4183, Remote operation status: 4185, HOLD mode status: 4189, Program advance status: 4187, Pattern end signal (1 second): 4265, Pattern end signal (3 seconds): 4266, Pattern end signal (5 seconds): 4267, Wait end signal (1 second) : 4257, Wait end signal (3 seconds) : 4258, Wait end signal (5 seconds) : 4259, Output tracking (ON) switching signal: 4186</p>
D6203	AL3.S	AL3 function selection	
D6204	OR.S	OUT relay function selection	
D6205	OR2.S	OUT2 relay function selection	<p>For the items other than below, see the Chapter 7 Functions and Applications of I Relays (for UT55A/UT52A/UP55A).</p>

6.4 UT55A/UT52A/UP55A D Registers

Register No.	Description		Range and meaning of value
D6206	AL1.D	AL1 contact type	0: When the event of assigned function occurs, the contact is closed. 1: When the event of assigned function occurs, the contact is opened.
D6207	AL2.D	AL2 contact type	
D6208	AL3.D	AL3 contact type	
D6209	OR.D	OUT relay contact type	Same as D6206
D6210	OR2.D	OUT2 relay contact type	
D6211 to D6220			
D6221	DO1.S_E1	DO11 function selection	Same as D6201
D6222	DO2.S_E1	DO12 function selection	
D6223	DO3.S_E1	DO13 function selection	
D6224	DO4.S_E1	DO14 function selection	
D6225	DO5.S_E1	DO15 function selection	
D6226	DO1.D_E1	DO11 contact type	Same as D6206
D6227	DO2.D_E1	DO12 contact type	
D6228	DO3.D_E1	DO13 contact type	
D6229	DO4.D_E1	DO14 contact type	
D6230	DO5.D_E1	DO15 contact type	
D6231 to D6240			
D6241	DO1.S_E2	DO21 function selection	Same as D6201
D6242	DO2.S_E2	DO22 function selection	
D6243	DO3.S_E2	DO23 function selection	
D6244	DO4.S_E2	DO24 function selection	
D6245	DO5.S_E2	DO25 function selection	
D6246	DO1.D_E2	DO21 contact type	Same as D6206
D6247	DO2.D_E2	DO22 contact type	
D6248	DO3.D_E2	DO23 contact type	
D6249	DO4.D_E2	DO24 contact type	
D6250	DO5.D_E2	DO25 contact type	
D6251 to D6260			
D6261	DO1.S_E3	DO31 function selection	Same as D6201
D6262	DO2.S_E3	DO32 function selection	
D6263	DO3.S_E3	DO33 function selection	
D6264	DO4.S_E3	DO34 function selection	
D6265	DO5.S_E3	DO35 function selection	
D6266	DO1.D_E3	DO31 contact type	Same as D6206
D6267	DO2.D_E3	DO32 contact type	
D6268	DO3.D_E3	DO33 contact type	
D6269	DO4.D_E3	DO34 contact type	
D6270	DO5.D_E3	DO35 contact type	
D6271 to D6280			
D6281	DO1.S_E4	DO41 function selection	Same as D6201
D6282	DO2.S_E4	DO42 function selection	
D6283	DO3.S_E4	DO43 function selection	
D6284	DO4.S_E4	DO44 function selection	
D6285	DO5.S_E4	DO45 function selection	
D6286	DO1.D_E4	DO41 contact type	Same as D6206
D6287	DO2.D_E4	DO42 contact type	
D6288	DO3.D_E4	DO43 contact type	
D6289	DO4.D_E4	DO44 contact type	
D6290	DO5.D_E4	DO45 contact type	
D6291 to D6300			

6.4 UT55A/UT52A/UP55A D Registers

I/O Display (D6301 to D6400)

● Bit Configuration of D6301: KEY-IO*1 (Key status)

Bit	Symbol	Event
0	PARA_KEY	PARAMETER (PARA) key (0: OFF 1: ON)
1	DISP_KEY	DISPLAY (DISP) key (0: OFF 1: ON)
2	RIGHT_KEY	RIGHT key (0: OFF 1: ON)
3	DOWN_KEY	DOWN key (0: OFF 1: ON)
4	SET_KEY	SET/ENTER key (0: OFF 1: ON)
5	UP_KEY	UP key (0: OFF 1: ON)
6	LEFT_KEY	LEFT key (0: OFF 1: ON)
7 *2	F2_KEY	F2 key (0: OFF 1: ON)
8 *2	F1_KEY	F1 key (0: OFF 1: ON)
9 *3	A/M_KEY	A/M key (0: OFF 1: ON)
10 *3	FN_KEY	Fn key (0: OFF 1: ON)
11 *4	PTN_KEY	PNT key (0: OFF 1: ON)
12 *4	RST_KEY	RST key (0: OFF 1: ON)
13 *4	MODE_KEY	MODE key (0: OFF 1: ON)
14 *4	RUN_KEY	RUN key (0: OFF 1: ON)
15		

*1: Same parameter exists in other menu. "-IO" is added to the end of the parameter in I/O menu.

*2: For UT55A only

*3: For UT55A/UT52A only

*4: For UP55A only

● D6302 to D6400

Register No.	Description	Range and meaning of value
D6302 to D6400	Free area	

System Setting (D6401 to D6500)

Register No.		Description	Range and meaning of value
D6401	R.MD	Restart mode	Set how the controller should recover from a power failure of 5 seconds or more. UT55A/UT52A 0: CONT (Continue action set before power failure.) 1: MAN (Start from MAN.) 2: AUTO (Start from AUTO.) UP55A 0: CONT (Continue action set before power failure.) 1: MAN (Start from MAN.) 2: RESET (Start from AUTO and RESET. The preset output value is outputted.)
D6402	R.TM	Restart timer	Set time between power on and the instant where controller starts computation. 0 to 10 s
D6403 to D6407			
D6408	EPO	Input error preset output	Set preset output value when the input burnout or ADC error occurs. Manual output is prioritized when input burnout occurs in MAN. 0: Preset output 1: 0% output 2: 100% output
D6409	C.GRN	Response as GREEN Series	0: OFF (Works as UT55A/UT52A/UP55A in communication of device information response or broadcasting.) 1: ON (Works as GREEN Series in communication of device information response or broadcasting.)
D6410	FREQ	Power frequency	0: AUTO 1: 60 Hz 2: 50 Hz
D6411 to D6416			
D6417	QSM	Quick setting mode	0: OFF (Disable) 1: ON (Enable)
D6418	LANG	Guide display language	0: ENG (English) 1: FRA (French) 2: GER (German) 3: SPA (Spanish)
D6419 to D6420			
D6421	U.DEF	Initialization to user default value	12345: Initialization, automatically returned to "0" after initialization.
D6422			
D6423	F.DEF	Initialization to factory default value	-12345: Initialization, automatically returned to "0" after initialization. *
D6424			
D6425	P.DEF	Clearing all program pattern data	13579: Initialization, automatically returned to "0" after initialization. * Data all deletions in menu [PROG]
D6426 to D6430			
D6431	LEVL	Parameter display level	1: EASY (Easy setting mode) 2: STD (Standard setting mode) 3: PRO (Professional setting mode)
D6432 to D6500			

*: UP55A does not respond for the initialization command via Ethernet communication.

Free Area (D6501 to D7000)

Register No.	Description	Range and meaning of value
D6501 to D7000	Free area	

6.4 UT55A/UT52A/UP55A D Registers

6.4.8 Registers for Ladder Program (D7001 to D7600)

Registers for ladder program													
For input ladder calculation													
D-Reg No.	Ref. No.	H No.	Register symbol	R/W			D-Reg No.	Ref. No.	H No.	Register symbol	R/W		
				UT 55A	UT 52A	UP 55A					UT 55A	UT 52A	UP 55A
D7001	47001	1B58	X_PV	R	R	R	D7051	47051	1B8A	PVIN_CTL	R *	R *	R *
D7002	47002	1B59	X_RSP	R	R	R	D7052	47052	1B8B	PVIN1_CTL	R *	R *	R *
D7003	47003	1B5A	X_AIN2	R	/	R	D7053	47053	1B8C	PVIN2_CTL	R *	R *	R *
D7004	47004	1B5B					D7054	47054	1B8D	PVIN3_CTL	R *	R *	R *
D7005	47005	1B5C	X_AIN4	R	/	R	D7055	47055	1B8E	PVIN4_CTL	R *	R *	R *
D7006	47006	1B5D					D7056	47056	1B8F	RSP_CTL	R *	R *	R *
D7007	47007	1B5E					D7057	47057	1B90	TRK_CTL	R *	R *	R *
D7008	47008	1B5F					D7058	47058	1B91	FF_CTL	R *	R *	/
D7009	47009	1B60					D7059	47059	1B92				
D7010	47010	1B61					D7060	47060	1B93				
D7011	47011	1B62	X000	R	R	R	D7061	47061	1B94	PV2IN_CTL	R *	R *	R *
D7012	47012	1B63	X100_E1	R	R	R	D7062	47062	1B95				
D7013	47013	1B64	X200_E2	R	/	R	D7063	47063	1B96				
D7014	47014	1B65	X300_E3	R	/	R	D7064	47064	1B97				
D7015	47015	1B66	X400_E4	R	/	R	D7065	47065	1B98				
D7016	47016	1B67					D7066	47066	1B99	RSP2_CTL	R *	R *	/
D7017	47017	1B68					D7067	47067	1B9A				
D7018	47018	1B69					D7068	47068	1B9B				
D7019	47019	1B6A					D7069	47069	1B9C				
D7020	47020	1B6B					D7070	47070	1B9D				
D7021	47021	1B6C					D7071	47071	1B9E				
D7022	47022	1B6D					D7072	47072	1B9F				
D7023	47023	1B6E					D7073	47073	1BA0				
D7024	47024	1B6F					D7074	47074	1BA1				
D7025	47025	1B70					D7075	47075	1BA2				
D7026	47026	1B71					D7076	47076	1BA3				
D7027	47027	1B72					D7077	47077	1BA4				
D7028	47028	1B73					D7078	47078	1BA5				
D7029	47029	1B74					D7079	47079	1BA6				
D7030	47030	1B75					D7080	47080	1BA7				
D7031	47031	1B76					D7081	47081	1BA8				
D7032	47032	1B77					D7082	47082	1BA9				
D7033	47033	1B78					D7083	47083	1BAA				
D7034	47034	1B79					D7084	47084	1BAB				
D7035	47035	1B7A					D7085	47085	1BAC				
D7036	47036	1B7B					D7086	47086	1BAD				
D7037	47037	1B7C					D7087	47087	1BAE				
D7038	47038	1B7D					D7088	47088	1BAF				
D7039	47039	1B7E					D7089	47089	1BB0				
D7040	47040	1B7F					D7090	47090	1BB1				
D7041	47041	1B80					D7091	47091	1BB2				
D7042	47042	1B81					D7092	47092	1BB3				
D7043	47043	1B82					D7093	47093	1BB4				
D7044	47044	1B83					D7094	47094	1BB5				
D7045	47045	1B84					D7095	47095	1BB6				
D7046	47046	1B85					D7096	47096	1BB7				
D7047	47047	1B86					D7097	47097	1BB8				
D7048	47048	1B87					D7098	47098	1BB9				
D7049	47049	1B88					D7099	47099	1BBA				
D7050	47050	1B89					D7100	47100	1BBB				

*: R/W when the LL50A Parameter Setting Software is used.

Registers for ladder program													
For output ladder calculation													
D-Reg No.	Ref. No.	H No.	Register symbol	R/W			D-Reg No.	Ref. No.	H No.	Register symbol	R/W		
				UT 55A	UT 52A	UP 55A					UT 55A	UT 52A	UP 55A
D7101	47101	1BBC	OUT_CTL	R	R	R	D7151	47151	1BEE	Y_OUT	R *	R *	R *
D7102	47102	1BBD	OUT2_CTL	R	R	R	D7152	47152	1BEF	Y_OUT2	R *	R *	R *
D7103	47103	1BBE	RET_CTL	R	R	R	D7153	47153	1BF0	Y_RET	R *	R *	R *
D7104	47104	1BBF	OUT2R_CTL	R	R	R	D7154	47154	1BF1	Y_OUT2R	R *	R *	R *
D7105	47105	1BC0	OUTR_CTL	R	R	R	D7155	47155	1BF2	Y_OUTR	R *	R *	R *
D7106	47106	1BC1					D7156	47156	1BF3				
D7107	47107	1BC2					D7157	47157	1BF4				
D7108	47108	1BC3					D7158	47158	1BF5				
D7109	47109	1BC4					D7159	47159	1BF6				
D7110	47110	1BC5					D7160	47160	1BF7				
D7111	47111	1BC6	DOAL	R	R	R	D7161	47161	1BF8	Y000	R *	R *	R *
D7112	47112	1BC7	DO10_E1	R	R	R	D7162	47162	1BF9	Y100_E1	R *	R *	R *
D7113	47113	1BC8	DO20_E2	R	/	R	D7163	47163	1BFA	Y200_E2	R *	/	R *
D7114	47114	1BC9	DO30_E3	R	/	R	D7164	47164	1BFB	Y300_E3	R *	/	R *
D7115	47115	1BCA	DO40_E4	R	/	R	D7165	47165	1BFC	Y400_E4	R *	/	R *
D7116	47116	1BCB					D7166	47166	1BFD				
D7117	47117	1BCC					D7167	47167	1BFE				
D7118	47118	1BCD					D7168	47168	1BFF				
D7119	47119	1BCE					D7169	47169	1C00				
D7120	47120	1BCF					D7170	47170	1C01				
D7121	47121	1BD0					D7171	47171	1C02				
D7122	47122	1BD1					D7172	47172	1C03				
D7123	47123	1BD2					D7173	47173	1C04				
D7124	47124	1BD3					D7174	47174	1C05				
D7125	47125	1BD4					D7175	47175	1C06				
D7126	47126	1BD5					D7176	47176	1C07				
D7127	47127	1BD6					D7177	47177	1C08				
D7128	47128	1BD7					D7178	47178	1C09				
D7129	47129	1BD8					D7179	47179	1C0A				
D7130	47130	1BD9					D7180	47180	1C0B				
D7131	47131	1BDA					D7181	47181	1C0C				
D7132	47132	1BDB					D7182	47182	1C0D				
D7133	47133	1BDC					D7183	47183	1C0E				
D7134	47134	1BDD					D7184	47184	1C0F				
D7135	47135	1BDE					D7185	47185	1C10				
D7136	47136	1BDF					D7186	47186	1C11				
D7137	47137	1BE0					D7187	47187	1C12				
D7138	47138	1BE1					D7188	47188	1C13				
D7139	47139	1BE2					D7189	47189	1C14				
D7140	47140	1BE3					D7190	47190	1C15				
D7141	47141	1BE4					D7191	47191	1C16				
D7142	47142	1BE5					D7192	47192	1C17				
D7143	47143	1BE6					D7193	47193	1C18				
D7144	47144	1BE7					D7194	47194	1C19				
D7145	47145	1BE8					D7195	47195	1C1A				
D7146	47146	1BE9					D7196	47196	1C1B				
D7147	47147	1BEA					D7197	47197	1C1C				
D7148	47148	1BEB					D7198	47198	1C1D				
D7149	47149	1BEC					D7199	47199	1C1E				
D7150	47150	1BED					D7200	47200	1C1F				

*: R/W when the LL50A Parameter Setting Software is used.

6.4 UT55A/UT52A/UP55A D Registers

Registers for ladder program													
Status register													
D-Reg No.	Ref. No.	H No.	Register symbol	R/W			D-Reg No.	Ref. No.	H No.	Register symbol	R/W		
				UT 55A	UT 52A	UP 55A					UT 55A	UT 52A	UP 55A
D7201	47201	1C20	M1_16	R/W	R/W	R/W	D7251	47251	1C52				
D7202	47202	1C21	M17_32	R/W	R/W	R/W	D7252	47252	1C53				
D7203	47203	1C22	M33_48	R/W	R/W	R/W	D7253	47253	1C54				
D7204	47204	1C23	M49_64	R/W	R/W	R/W	D7254	47254	1C55				
D7205	47205	1C24	M65_80	R/W	R/W	R/W	D7255	47255	1C56				
D7206	47206	1C25	M81_96	R/W	R/W	R/W	D7256	47256	1C57				
D7207	47207	1C26	M97_112	R/W	R/W	R/W	D7257	47257	1C58				
D7208	47208	1C27	M113_128	R/W	R/W	R/W	D7258	47258	1C59				
D7209	47209	1C28					D7259	47259	1C5A				
D7210	47210	1C29					D7260	47260	1C5B				
D7211	47211	1C2A	M1_16_B	R/W	R/W	R/W	D7261	47261	1C5C				
D7212	47212	1C2B	M17_32_B	R/W	R/W	R/W	D7262	47262	1C5D				
D7213	47213	1C2C	M33_48_B	R/W	R/W	R/W	D7263	47263	1C5E				
D7214	47214	1C2D	M49_64_B	R/W	R/W	R/W	D7264	47264	1C5F				
D7215	47215	1C2E	M65_80_B	R/W	R/W	R/W	D7265	47265	1C60				
D7216	47216	1C2F	M81_96_B	R/W	R/W	R/W	D7266	47266	1C61				
D7217	47217	1C30	M97_112_B	R/W	R/W	R/W	D7267	47267	1C62				
D7218	47218	1C31	M113_128_B	R/W	R/W	R/W	D7268	47268	1C63				
D7219	47219	1C32					D7269	47269	1C64				
D7220	47220	1C33					D7270	47270	1C65				
D7221	47221	1C34	TIM_RELAY	R	R	R	D7271	47271	1C66				
D7222	47222	1C35	CNT_RELAY	R	R	R	D7272	47272	1C67				
D7223	47223	1C36					D7273	47273	1C68				
D7224	47224	1C37					D7274	47274	1C69				
D7225	47225	1C38					D7275	47275	1C6A				
D7226	47226	1C39					D7276	47276	1C6B				
D7227	47227	1C3A					D7277	47277	1C6C				
D7228	47228	1C3B					D7278	47278	1C6D				
D7229	47229	1C3C					D7279	47279	1C6E				
D7230	47230	1C3D					D7280	47280	1C6F				
D7231	47231	1C3E					D7281	47281	1C70				
D7232	47232	1C3F					D7282	47282	1C71				
D7233	47233	1C40					D7283	47283	1C72				
D7234	47234	1C41					D7284	47284	1C73				
D7235	47235	1C42					D7285	47285	1C74				
D7236	47236	1C43					D7286	47286	1C75				
D7237	47237	1C44					D7287	47287	1C76				
D7238	47238	1C45					D7288	47288	1C77				
D7239	47239	1C46					D7289	47289	1C78				
D7240	47240	1C47					D7290	47290	1C79				
D7241	47241	1C48					D7291	47291	1C7A				
D7242	47242	1C49					D7292	47292	1C7B				
D7243	47243	1C4A					D7293	47293	1C7C				
D7244	47244	1C4B					D7294	47294	1C7D				
D7245	47245	1C4C					D7295	47295	1C7E				
D7246	47246	1C4D					D7296	47296	1C7F				
D7247	47247	1C4E					D7297	47297	1C80				
D7248	47248	1C4F					D7298	47298	1C81				
D7249	47249	1C50					D7299	47299	1C82				
D7250	47250	1C51					D7300	47300	1C83				

Registers for ladder program													
Constant register													
D-Reg No.	Ref. No.	H No.	Register symbol	R/W			D-Reg No.	Ref. No.	H No.	Register symbol	R/W		
				UT 55A	UT 52A	UP 55A					UT 55A	UT 52A	UP 55A
D7301	47301	1C84	K01	R/W	R/W	R/W	D7351	47351	1CB6				
D7302	47302	1C85	K02	R/W	R/W	R/W	D7352	47352	1CB7				
D7303	47303	1C86	K03	R/W	R/W	R/W	D7353	47353	1CB8				
D7304	47304	1C87	K04	R/W	R/W	R/W	D7354	47354	1CB9				
D7305	47305	1C88	K05	R/W	R/W	R/W	D7355	47355	1CBA				
D7306	47306	1C89	K06	R/W	R/W	R/W	D7356	47356	1CBB				
D7307	47307	1C8A	K07	R/W	R/W	R/W	D7357	47357	1CBC				
D7308	47308	1C8B	K08	R/W	R/W	R/W	D7358	47358	1CBD				
D7309	47309	1C8C	K09	R/W	R/W	R/W	D7359	47359	1CBE				
D7310	47310	1C8D	K10	R/W	R/W	R/W	D7360	47360	1CBF				
D7311	47311	1C8E	K11	R/W	R/W	R/W	D7361	47361	1CC0				
D7312	47312	1C8F	K12	R/W	R/W	R/W	D7362	47362	1CC1				
D7313	47313	1C90	K13	R/W	R/W	R/W	D7363	47363	1CC2				
D7314	47314	1C91	K14	R/W	R/W	R/W	D7364	47364	1CC3				
D7315	47315	1C92	K15	R/W	R/W	R/W	D7365	47365	1CC4				
D7316	47316	1C93	K16	R/W	R/W	R/W	D7366	47366	1CC5				
D7317	47317	1C94	K17	R/W	R/W	R/W	D7367	47367	1CC6				
D7318	47318	1C95	K18	R/W	R/W	R/W	D7368	47368	1CC7				
D7319	47319	1C96	K19	R/W	R/W	R/W	D7369	47369	1CC8				
D7320	47320	1C97	K20	R/W	R/W	R/W	D7370	47370	1CC9				
D7321	47321	1C98	K21	R/W	R/W	R/W	D7371	47371	1CCA				
D7322	47322	1C99	K22	R/W	R/W	R/W	D7372	47372	1CCB				
D7323	47323	1C9A	K23	R/W	R/W	R/W	D7373	47373	1CCC				
D7324	47324	1C9B	K24	R/W	R/W	R/W	D7374	47374	1CCD				
D7325	47325	1C9C	K25	R/W	R/W	R/W	D7375	47375	1CCE				
D7326	47326	1C9D	K26	R/W	R/W	R/W	D7376	47376	1CCF				
D7327	47327	1C9E	K27	R/W	R/W	R/W	D7377	47377	1CD0				
D7328	47328	1C9F	K28	R/W	R/W	R/W	D7378	47378	1CD1				
D7329	47329	1CA0	K29	R/W	R/W	R/W	D7379	47379	1CD2				
D7330	47330	1CA1	K30	R/W	R/W	R/W	D7380	47380	1CD3				
D7331	47331	1CA2					D7381	47381	1CD4				
D7332	47332	1CA3					D7382	47382	1CD5				
D7333	47333	1CA4					D7383	47383	1CD6				
D7334	47334	1CA5					D7384	47384	1CD7				
D7335	47335	1CA6					D7385	47385	1CD8				
D7336	47336	1CA7					D7386	47386	1CD9				
D7337	47337	1CA8					D7387	47387	1CDA				
D7338	47338	1CA9					D7388	47388	1CDB				
D7339	47339	1CAA					D7389	47389	1CDC				
D7340	47340	1CAB					D7390	47390	1CDD				
D7341	47341	1CAC					D7391	47391	1CDE				
D7342	47342	1CAD					D7392	47392	1CDF				
D7343	47343	1CAE					D7393	47393	1CE0				
D7344	47344	1CAF					D7394	47394	1CE1				
D7345	47345	1CB0					D7395	47395	1CE2				
D7346	47346	1CB1					D7396	47396	1CE3				
D7347	47347	1CB2					D7397	47397	1CE4				
D7348	47348	1CB3					D7398	47398	1CE5				
D7349	47349	1CB4					D7399	47399	1CE6				
D7350	47350	1CB5					D7400	47400	1CE7				

6.4 UT55A/UT52A/UP55A D Registers

Registers for ladder program													
Constant register													
D-Reg No.	Ref. No.	H No.	Register symbol	R/W			D-Reg No.	Ref. No.	H No.	Register symbol	R/W		
				UT 55A	UT 52A	UP 55A					UT 55A	UT 52A	UP 55A
D7401	47401	1CE8					D7451	47451	1D1A				
D7402	47402	1CE9					D7452	47452	1D1B				
D7403	47403	1CEA					D7453	47453	1D1C				
D7404	47404	1CEB					D7454	47454	1D1D				
D7405	47405	1CEC					D7455	47455	1D1E				
D7406	47406	1CED					D7456	47456	1D1F				
D7407	47407	1CEE					D7457	47457	1D20				
D7408	47408	1CEF					D7458	47458	1D21				
D7409	47409	1CF0					D7459	47459	1D22				
D7410	47410	1CF1	C_1	R	R	R	D7460	47460	1D23				
D7411	47411	1CF2	C0	R	R	R	D7461	47461	1D24				
D7412	47412	1CF3	C1	R	R	R	D7462	47462	1D25				
D7413	47413	1CF4	C2	R	R	R	D7463	47463	1D26				
D7414	47414	1CF5	C3	R	R	R	D7464	47464	1D27				
D7415	47415	1CF6	C4	R	R	R	D7465	47465	1D28				
D7416	47416	1CF7	C5	R	R	R	D7466	47466	1D29				
D7417	47417	1CF8	C10	R	R	R	D7467	47467	1D2A				
D7418	47418	1CF9	C50	R	R	R	D7468	47468	1D2B				
D7419	47419	1CFA	C60	R	R	R	D7469	47469	1D2C				
D7420	47420	1CFB	C100	R	R	R	D7470	47470	1D2D				
D7421	47421	1CFC	C1000	R	R	R	D7471	47471	1D2E				
D7422	47422	1CFD	C10000	R	R	R	D7472	47472	1D2F				
D7423	47423	1CFE					D7473	47473	1D30				
D7424	47424	1CFF					D7474	47474	1D31				
D7425	47425	1D00					D7475	47475	1D32				
D7426	47426	1D01					D7476	47476	1D33				
D7427	47427	1D02					D7477	47477	1D34				
D7428	47428	1D03					D7478	47478	1D35				
D7429	47429	1D04					D7479	47479	1D36				
D7430	47430	1D05					D7480	47480	1D37				
D7431	47431	1D06					D7481	47481	1D38				
D7432	47432	1D07					D7482	47482	1D39				
D7433	47433	1D08					D7483	47483	1D3A				
D7434	47434	1D09					D7484	47484	1D3B				
D7435	47435	1D0A					D7485	47485	1D3C				
D7436	47436	1D0B					D7486	47486	1D3D				
D7437	47437	1D0C					D7487	47487	1D3E				
D7438	47438	1D0D					D7488	47488	1D3F				
D7439	47439	1D0E					D7489	47489	1D40				
D7440	47440	1D0F					D7490	47490	1D41				
D7441	47441	1D10					D7491	47491	1D42				
D7442	47442	1D11					D7492	47492	1D43				
D7443	47443	1D12					D7493	47493	1D44				
D7444	47444	1D13					D7494	47494	1D45				
D7445	47445	1D14					D7495	47495	1D46				
D7446	47446	1D15					D7496	47496	1D47				
D7447	47447	1D16					D7497	47497	1D48				
D7448	47448	1D17					D7498	47498	1D49				
D7449	47449	1D18					D7499	47499	1D4A				
D7450	47450	1D19					D7500	47500	1D4B				

Registers for ladder program													
Input range / scale													
D-Reg No.	Ref. No.	H No.	Register symbol	R/W			D-Reg No.	Ref. No.	H No.	Register symbol	R/W		
				UT 55A	UT 52A	UP 55A					UT 55A	UT 52A	UP 55A
D7501	47501	1D4C	DP_R	R	R	R	D7551	47551	1D7E				
D7502	47502	1D4D	RH_R	R	R	R	D7552	47552	1D7F				
D7503	47503	1D4E	RL_R	R	R	R	D7553	47553	1D80				
D7504	47504	1D4F					D7554	47554	1D81				
D7505	47505	1D50	SDP_R	R	R	R	D7555	47555	1D82				
D7506	47506	1D51	SH_R	R	R	R	D7556	47556	1D83				
D7507	47507	1D52	SL_R	R	R	R	D7557	47557	1D84				
D7508	47508	1D53					D7558	47558	1D85				
D7509	47509	1D54	DP_E1_R	R	R	R	D7559	47559	1D86				
D7510	47510	1D55	RH_E1_R	R	R	R	D7560	47560	1D87				
D7511	47511	1D56	RL_E1_R	R	R	R	D7561	47561	1D88				
D7512	47512	1D57					D7562	47562	1D89				
D7513	47513	1D58	SDP_E1_R	R	R	R	D7563	47563	1D8A				
D7514	47514	1D59	SH_E1_R	R	R	R	D7564	47564	1D8B				
D7515	47515	1D5A	SL_E1_R	R	R	R	D7565	47565	1D8C				
D7516	47516	1D5B					D7566	47566	1D8D				
D7517	47517	1D5C	DP_E2_R	R	/	R	D7567	47567	1D8E				
D7518	47518	1D5D	RH_E2_R	R	/	R	D7568	47568	1D8F				
D7519	47519	1D5E	RL_E2_R	R	/	R	D7569	47569	1D90				
D7520	47520	1D5F					D7570	47570	1D91				
D7521	47521	1D60	SDP_E2_R	R	/	R	D7571	47571	1D92				
D7522	47522	1D61	SH_E2_R	R	/	R	D7572	47572	1D93				
D7523	47523	1D62	SL_E2_R	R	/	R	D7573	47573	1D94				
D7524	47524	1D63					D7574	47574	1D95				
D7525	47525	1D64	DP_E4_R	R	/	R	D7575	47575	1D96				
D7526	47526	1D65	RH_E4_R	R	/	R	D7576	47576	1D97				
D7527	47527	1D66	RL_E4_R	R	/	R	D7577	47577	1D98				
D7528	47528	1D67					D7578	47578	1D99				
D7529	47529	1D68	SDP_E4_R	R	/	R	D7579	47579	1D9A				
D7530	47530	1D69	SH_E4_R	R	/	R	D7580	47580	1D9B				
D7531	47531	1D6A	SL_E4_R	R	/	R	D7581	47581	1D9C				
D7532	47532	1D6B					D7582	47582	1D9D				
D7533	47533	1D6C	P.DP_L1_R	R	R	R	D7583	47583	1D9E				
D7534	47534	1D6D	P.RH_L1_R	R	R	R	D7584	47584	1D9F				
D7535	47535	1D6E	P.RL_L1_R	R	R	R	D7585	47585	1DA0				
D7536	47536	1D6F					D7586	47586	1DA1				
D7537	47537	1D70	P.DP_L2_R	R	R	R	D7587	47587	1DA2				
D7538	47538	1D71	P.RH_L2_R	R	R	R	D7588	47588	1DA3				
D7539	47539	1D72	P.RL_L2_R	R	R	R	D7589	47589	1DA4				
D7540	47540	1D73					D7590	47590	1DA5				
D7541	47541	1D74					D7591	47591	1DA6				
D7542	47542	1D75					D7592	47592	1DA7				
D7543	47543	1D76					D7593	47593	1DA8				
D7544	47544	1D77					D7594	47594	1DA9				
D7545	47545	1D78					D7595	47595	1DAA				
D7546	47546	1D79					D7596	47596	1DAB				
D7547	47547	1D7A					D7597	47597	1DAC				
D7548	47548	1D7B					D7598	47598	1DAD				
D7549	47549	1D7C					D7599	47599	1DAE				
D7550	47550	1D7D					D7600	47600	1DAF				

6.4 UT55A/UT52A/UP55A D Registers

For Input Ladder Calculation (D7001 to D7100)

● D7001 to D7010

Register No.	Description		Range and meaning of value
D7001	X_PV	PV analog input	-5.0 to 105.0%
D7002	X_RSP	RSP analog input	-5.0 to 105.0%
D7003	X_AIN2	AIN2 aux. analog input	-5.0 to 105.0%
D7004			
D7005	X_AIN4	AIN4 aux. analog input	-5.0 to 105.0%
D7006 to D7010			

● Bit Configuration of D7011: X000 (DI1-DI3 status: equipped as standard)

Bit	Symbol	Event	
0	X_DI1	DI1 status	(0: OFF 1: ON)
1	X_DI2	DI2 status	(0: OFF 1: ON)
2	X_DI3	DI3 status	(0: OFF 1: ON)
3 to 15			

● Bit Configuration of D7012: X100_E1 (DI11-DI16 status: E1-terminal area)

Bit	Symbol	Event	
0	X_DI11	DI11 status	(0: OFF 1: ON)
1	X_DI12	DI12 status	(0: OFF 1: ON)
2	X_DI13	DI13 status	(0: OFF 1: ON)
3	X_DI14	DI14 status	(0: OFF 1: ON)
4	X_DI15	DI15 status	(0: OFF 1: ON)
5	X_DI16	DI16 status	(0: OFF 1: ON)
6 to 15			

● Bit Configuration of D7013: X200_E2 (DI21-DI26 status: E2-terminal area)

Bit	Symbol	Event	
0	X_DI21	DI21 status	(0: OFF 1: ON)
1	X_DI22	DI22 status	(0: OFF 1: ON)
2	X_DI23	DI23 status	(0: OFF 1: ON)
3	X_DI24	DI24 status	(0: OFF 1: ON)
4	X_DI25	DI25 status	(0: OFF 1: ON)
5	X_DI26	DI26 status	(0: OFF 1: ON)
6 to 15			

● Bit Configuration of 7014: X300_E3 (DI31-DI35 status: E3-terminal area)

Bit	Symbol	Event	
0	X_DI31	DI31 status	(0: OFF 1: ON)
1	X_DI32	DI32 status	(0: OFF 1: ON)
2	X_DI33	DI33 status	(0: OFF 1: ON)
3	X_DI34	DI34 status	(0: OFF 1: ON)
4	X_DI35	DI35 status	(0: OFF 1: ON)
5 to 15			

● Bit Configuration of D7015: **X400_E4** (DI41-DI46 status: E4-terminal area)

Bit	Symbol	Event	
0	X_DI41	DI41 status	(0: OFF 1: ON)
1	X_DI42	DI42 status	(0: OFF 1: ON)
2	X_DI43	DI43 status	(0: OFF 1: ON)
3	X_DI44	DI44 status	(0: OFF 1: ON)
4	X_DI45	DI45 status	(0: OFF 1: ON)
5	X_DI46	DI46 status	(0: OFF 1: ON)
6 to 15			

● D7051 to D7100

Register No.	Description		Range and meaning of value
D7051	PVIN_CTL	Control PV input	-5.0 to 105.0% of PV input range (EU)
D7052	PVIN1_CTL	Control PV input 1	
D7053	PVIN2_CTL	Control PV input 2	
D7054	PVIN3_CTL	Control PV input 3	
D7055	PVIN4_CTL	Control PV input 4	
D7056	RSP_CTL	Control RSP input	0.0 to 100.0% of RSP input range (EU)
D7057	TRK_CTL	Control tracking input	-5.0 to 105.0% of TRK input range (EU)
D7058	FF_CTL	Control feedforward input	-100.0 to 100.0% of FF input range (EU)
D7059 to D7060			
D7061	PV2IN_CTL	Control PV2 input	-5.0 to 105.0% of PV input range (EU)
D7062 to D7065			
D7066	RSP2_CTL	Control RSP2 input	0.0 to 100.0% of RSP input range (EU)
D7067 to D7100			

6.4 UT55A/UT52A/UP55A D Registers

For Output Ladder Calculation (D7101 to D7200)

● D7101 to D7110

Register No.	Description		Range and meaning of value
D7101	OUT_CTL	Control OUT output	-5.0 to 105.0% of control OUT output range
D7102	OUT2_CTL	Control OUT2 output	-5.0 to 105.0% of control OUT2 output range
D7103	RET_CTL	Control RET output	-5.0 to 105.0% of control ERT output range
D7104	OUT2R_CTL	Control OUT2R output (Relay)	-5.0 to 105.0% of control OUT2R output range
D7105	OUTR_CTL	Control OUTR output (Relay)	-5.0 to 105.0% of control OUTR output range
D7106 to D7110			

● Bit Configuration of D7111: DOAL (Control AL1-AL3 status: equipped as standard)

Bit	Symbol	Event	
0	AL1_CTL	Control AL1 status	(0: OFF 1: ON)
1	AL2_CTL	Control AL2 status	(0: OFF 1: ON)
2	AL3_CTL	Control AL3 status	(0: OFF 1: ON)
3 to 15			

● Bit Configuration of D7112: DO10_E1 (Control DO11-DO15 status: E1-terminal area)

Bit	Symbol	Event	
0	DO11_CTL	Control DO11 status	(0: OFF 1: ON)
1	DO12_CTL	Control DO12 status	(0: OFF 1: ON)
2	DO13_CTL	Control DO13 status	(0: OFF 1: ON)
3	DO14_CTL	Control DO14 status	(0: OFF 1: ON)
4	DO15_CTL	Control DO15 status	(0: OFF 1: ON)
5 to 15			

● Bit Configuration of D7113: DO20_E2 (Control DO21-DO25 status: E2-terminal area)

Bit	Symbol	Event	
0	DO21_CTL	Control DO21 status	(0: OFF 1: ON)
1	DO22_CTL	Control DO22 status	(0: OFF 1: ON)
2	DO23_CTL	Control DO23 status	(0: OFF 1: ON)
3	DO24_CTL	Control DO24 status	(0: OFF 1: ON)
4	DO25_CTL	Control DO25 status	(0: OFF 1: ON)
5 to 15			

● Bit Configuration of D7114: DO30_E3 (Control DO31-DO35 status: E3-terminal area)

Bit	Symbol	Event	
0	DO31_CTL	Control DO31 status	(0: OFF 1: ON)
1	DO32_CTL	Control DO32 status	(0: OFF 1: ON)
2	DO33_CTL	Control DO33 status	(0: OFF 1: ON)
3	DO34_CTL	Control DO34 status	(0: OFF 1: ON)
4	DO35_CTL	Control DO35 status	(0: OFF 1: ON)
5 to 15			

● **Bit Configuration of D7115: DO40_E4 (Control DO41-DO45 status: E4-terminal area)**

Bit	Symbol	Event
0	DO41_CTL	Control DO41 status (0: OFF 1: ON)
1	DO42_CTL	Control DO42 status (0: OFF 1: ON)
2	DO43_CTL	Control DO43 status (0: OFF 1: ON)
3	DO44_CTL	Control DO44 status (0: OFF 1: ON)
4	DO45_CTL	Control DO45 status (0: OFF 1: ON)
5 to 15		

● **D7116 to D7160**

Register No.	Description	Range and meaning of value
D7116 to D7150		
D7151	Y_OUT	OUT control output -5.0 to 105.0%
D7152	Y_OUT2	OUT2 control output -5.0 to 105.0%
D7153	Y_RET	RET control output -5.0 to 105.0%
D7154	Y_OUT2R	OUT2R control output -5.0 to 105.0%
D7155	Y_OUTR	OUTR control output -5.0 to 105.0%
D7156 to D7160		

● **Bit Configuration of D7161: Y000 (AL1-AL3 status: equipped as standard)**

Bit	Symbol	Event
0	Y_AL1	AL1 status (0: OFF 1: ON)
1	Y_AL2	AL2 status (0: OFF 1: ON)
2	Y_AL3	AL3 status (0: OFF 1: ON)
3 to 15		

● **Bit Configuration of D7162: Y100_E1 (DO11-DO15 status: E1-terminal area)**

Bit	Symbol	Event
0	Y_DO11	DO11 status (0: OFF 1: ON)
1	Y_DO12	DO12 status (0: OFF 1: ON)
2	Y_DO13	DO13 status (0: OFF 1: ON)
3	Y_DO14	DO14 status (0: OFF 1: ON)
4	Y_DO15	DO15 status (0: OFF 1: ON)
5 to 15		

● **Bit Configuration of D7163: Y200_E2 (DO21-DO25 status: E2-terminal area)**

Bit	Symbol	Event
0	Y_DO21	DO21 status (0: OFF 1: ON)
1	Y_DO22	DO22 status (0: OFF 1: ON)
2	Y_DO23	DO23 status (0: OFF 1: ON)
3	Y_DO24	DO24 status (0: OFF 1: ON)
4	Y_DO25	DO25 status (0: OFF 1: ON)
5 to 15		

6.4 UT55A/UT52A/UP55A D Registers

● Bit Configuration of D7164: Y300_E3 (DO31-DO35 status: E3-terminal area)

Bit	Symbol	Event	
0	Y_DO31	DO31 status	(0: OFF 1: ON)
1	Y_DO32	DO32 status	(0: OFF 1: ON)
2	Y_DO33	DO33 status	(0: OFF 1: ON)
3	Y_DO34	DO34 status	(0: OFF 1: ON)
4	Y_DO35	DO35 status	(0: OFF 1: ON)
5 to 15			

● Bit Configuration of D7165: Y400_E4 (DO41-DO45 status: E4-terminal area)

Bit	Symbol	Event	
0	Y_DO41	DO41 status	(0: OFF 1: ON)
1	Y_DO42	DO42 status	(0: OFF 1: ON)
2	Y_DO43	DO43 status	(0: OFF 1: ON)
3	Y_DO44	DO44 status	(0: OFF 1: ON)
4	Y_DO45	DO45 status	(0: OFF 1: ON)
5 to 15			

Status Registers (D7201 to D7300)

● Bit Configuration of D7201 to D7208: M1_16 to M113_128 (Status register (M1-M16 to M113-M128, Non-holding type))

Bit	Symbol								Event	
0	M01	M17	M33	M49	M65	M81	M97	M113	Internal relay (Non-holding type)	(0: OFF 1: ON)
1	M02	M18	M34	M50	M66	M82	M98	M114	Internal relay (Non-holding type)	(0: OFF 1: ON)
2	M03	M19	M35	M51	M67	M83	M99	M115	Internal relay (Non-holding type)	(0: OFF 1: ON)
3	M04	M20	M36	M52	M68	M84	M100	M116	Internal relay (Non-holding type)	(0: OFF 1: ON)
4	M05	M21	M37	M53	M69	M85	M101	M117	Internal relay (Non-holding type)	(0: OFF 1: ON)
5	M06	M22	M38	M54	M70	M86	M102	M118	Internal relay (Non-holding type)	(0: OFF 1: ON)
6	M07	M23	M39	M55	M71	M87	M103	M119	Internal relay (Non-holding type)	(0: OFF 1: ON)
7	M08	M24	M40	M56	M72	M88	M104	M120	Internal relay (Non-holding type)	(0: OFF 1: ON)
8	M09	M25	M41	M57	M73	M89	M105	M121	Internal relay (Non-holding type)	(0: OFF 1: ON)
9	M10	M26	M42	M58	M74	M90	M106	M122	Internal relay (Non-holding type)	(0: OFF 1: ON)
10	M11	M27	M43	M59	M75	M91	M107	M123	Internal relay (Non-holding type)	(0: OFF 1: ON)
11	M12	M28	M44	M60	M76	M92	M108	M124	Internal relay (Non-holding type)	(0: OFF 1: ON)
12	M13	M29	M45	M61	M77	M93	M109	M125	Internal relay (Non-holding type)	(0: OFF 1: ON)
13	M14	M30	M46	M62	M78	M94	M110	M126	Internal relay (Non-holding type)	(0: OFF 1: ON)
14	M15	M31	M47	M63	M79	M95	M111	M127	Internal relay (Non-holding type)	(0: OFF 1: ON)
15	M16	M32	M48	M64	M80	M96	M112	M128	Internal relay (Non-holding type)	(0: OFF 1: ON)

● Bit Configuration of D7211 to D7212: M1_16_B to M17_32_B (Status register (M1_B-M16_B to M17_B-M32_B, Holding type))

Bit	Symbol		Event	
0	M01_B	M17_B	Internal relay (Holding type)	(0: OFF 1: ON)
1	M02_B	M18_B	Internal relay (Holding type)	(0: OFF 1: ON)
2	M03_B	M19_B	Internal relay (Holding type)	(0: OFF 1: ON)
3	M04_B	M20_B	Internal relay (Holding type)	(0: OFF 1: ON)
4	M05_B	M21_B	Internal relay (Holding type)	(0: OFF 1: ON)
5	M06_B	M22_B	Internal relay (Holding type)	(0: OFF 1: ON)
6	M07_B	M23_B	Internal relay (Holding type)	(0: OFF 1: ON)
7	M08_B	M24_B	Internal relay (Holding type)	(0: OFF 1: ON)
8	M09_B	M25_B	Internal relay (Holding type)	(0: OFF 1: ON)
9	M10_B	M26_B	Internal relay (Holding type)	(0: OFF 1: ON)
10	M11_B	M27_B	Internal relay (Holding type)	(0: OFF 1: ON)
11	M12_B	M28_B	Internal relay (Holding type)	(0: OFF 1: ON)
12	M13_B	M29_B	Internal relay (Holding type)	(0: OFF 1: ON)
13	M14_B	M30_B	Internal relay (Holding type)	(0: OFF 1: ON)
14	M15_B	M31_B	Internal relay (Holding type)	(0: OFF 1: ON)
15	M16_B	M32_B	Internal relay (Holding type)	(0: OFF 1: ON)

● **Bit Configuration of D7213 to D7218: M33_48_B to M113_128_B (Status register (M33_B-M48_B to M113_B-M128_B, Holding type))**

Bit	Symbol						Event
0	M33_B	M49_B	M65_B	M81_B	M97_B	M113_B	Internal relay (Holding type) * (0: OFF 1: ON)
1	M34_B	M50_B	M66_B	M82_B	M98_B	M114_B	Internal relay (Holding type) * (0: OFF 1: ON)
2	M35_B	M51_B	M67_B	M83_B	M99_B	M115_B	Internal relay (Holding type) * (0: OFF 1: ON)
3	M36_B	M52_B	M68_B	M84_B	M100_B	M116_B	Internal relay (Holding type) * (0: OFF 1: ON)
4	M37_B	M53_B	M69_B	M85_B	M101_B	M117_B	Internal relay (Holding type) * (0: OFF 1: ON)
5	M38_B	M54_B	M70_B	M86_B	M102_B	M118_B	Internal relay (Holding type) * (0: OFF 1: ON)
6	M39_B	M55_B	M71_B	M87_B	M103_B	M119_B	Internal relay (Holding type) * (0: OFF 1: ON)
7	M40_B	M56_B	M72_B	M88_B	M104_B	M120_B	Internal relay (Holding type) * (0: OFF 1: ON)
8	M41_B	M57_B	M73_B	M89_B	M105_B	M121_B	Internal relay (Holding type) * (0: OFF 1: ON)
9	M42_B	M58_B	M74_B	M90_B	M106_B	M122_B	Internal relay (Holding type) * (0: OFF 1: ON)
10	M43_B	M59_B	M75_B	M91_B	M107_B	M123_B	Internal relay (Holding type) * (0: OFF 1: ON)
11	M44_B	M60_B	M76_B	M92_B	M108_B	M124_B	Internal relay (Holding type) * (0: OFF 1: ON)
12	M45_B	M61_B	M77_B	M93_B	M109_B	M125_B	Internal relay (Holding type) * (0: OFF 1: ON)
13	M46_B	M62_B	M78_B	M94_B	M110_B	M126_B	Internal relay (Holding type) * (0: OFF 1: ON)
14	M47_B	M63_B	M79_B	M95_B	M111_B	M127_B	Internal relay (Holding type) * (0: OFF 1: ON)
15	M48_B	M64_B	M80_B	M96_B	M112_B	M128_B	Internal relay (Holding type) * (0: OFF 1: ON)

*: It is Non-holding type when the input sampling period (control period) (SMP) is 50 ms.

● **Bit Configuration of D7221: TIM_RELAY (Time out flag)**

Bit	Symbol	Event
0	TIM1	Timer-1 time out flag (0: OFF 1: ON)
1	TIM2	Timer-2 time out flag (0: OFF 1: ON)
2	TIM3	Timer-3 time out flag (0: OFF 1: ON)
3	TIM4	Timer-4 time out flag (0: OFF 1: ON)
4 to 15		

● **Bit Configuration of D7222: CNT_RELAY (Count out relay flag)**

Bit	Symbol	Event
0	CNT1	Counter-1 count out flag (0: OFF 1: ON)
1	CNT2	Counter-2 count out flag (0: OFF 1: ON)
2	CNT3	Counter-3 count out flag (0: OFF 1: ON)
3	CNT4	Counter-4 count out flag (0: OFF 1: ON)
4 to 15		

6.4 UT55A/UT52A/UP55A D Registers

Constant Register (D7301 to D7500)

Register No.	Description		Range and meaning of value
D7301 to D7330	K01 to K30	K01 data register to K30 data register	K01 to K20: -32768 to 32767 K21 to K30: 0 to 65535
D7331 to D7409			
D7410	C_1	Constant -1	-1
D7411	C0	Constant 0	0
D7412	C1	Constant 1	1
D7413	C2	Constant 2	2
D7414	C3	Constant 3	3
D7415	C4	Constant 4	4
D7416	C5	Constant 5	5
D7417	C10	Constant 10	10
D7418	C50	Constant 50	50
D7419	C60	Constant 60	60
D7420	C100	Constant 100	100
D7421	C1000	Constant 1000	1000
D7422	C10000	Constant 10000	10000
D7423 to D7500			

Input Range / Scale (D7501 to D7600) (Read only)

Register No.	Description		Range and meaning of value
D7501	DP_R	PV input decimal point position	Same as D5103 (DP)
D7502	RH_R	Maximum value of PV input range	Same as D5104 (RH)
D7503	RL_R	Minimum value of PV input range	Same as D5105 (RL)
D7504			
D7505	SDP_R	PV input scale decimal point position	Same as D5106 (SDP)
D7506	SH_R	Maximum value of PV input scale	Same as D5107 (SH)
D7507	SL_R	Minimum value of PV input scale	Same as D5108 (SL)
D7508			
D7509	DP_E1_R	RSP remote input decimal point position	Same as D5123 (DP_E1)
D7510	RH_E1_R	Maximum value of RSP remote input range	Same as D5124 (RH_E1)
D7511	RL_E1_R	Minimum value of RSP remote input range	Same as D5125 (RL_E1)
D7512			
D7513	SDP_E1_R	RSP remote input scale decimal point position	Same as D5126 (SDP_E1)
D7514	SH_E1_R	Maximum value of RSP remote input scale	Same as D5127 (SH_E1)
D7515	SL_E1_R	Minimum value of RSP remote input scale	Same as D5128 (SL_E1)
D7516			
D7517	DP_E2_R	AIN2 aux. analog input decimal point position	Same as D5143 (DP_E2)
D7518	RH_E2_R	Maximum value of AIN2 aux. analog input range	Same as D5144 (RH_E2)
D7519	RL_E2_R	Minimum value of AIN2 aux. analog input range	Same as D5145 (RL_E2)
D7520			
D7521	SDP_E2_R	AIN2 aux. analog input scale decimal point position	Same as D5146 (SDP_E2)
D7522	SH_E2_R	Maximum value of AIN2 aux. analog input scale	Same as D5147 (SH_E2)
D7523	SL_E2_R	Minimum value of AIN2 aux. analog input scale	Same as D5148 (SL_E2)
D7524			

6.4 UT55A/UT52A/UP55A D Registers

Register No.	Description		Range and meaning of value
D7525	DP_E4_R	Maximum value of AIN4 aux. analog input position	Same as D5183 (DP_E4)
D7526	RH_E4_R	Maximum value of AIN4 aux. analog input range	Same as D5184 (RH_E4)
D7527	RL_E4_R	Minimum value of AIN4 aux. analog input range	Same as D5185 (RL_E4)
D7528			
D7529	SDP_E4_R	AIN4 aux. analog input scale decimal point position	Same as D5186 (SDP_E4)
D7530	SH_E4_R	Maximum value of AIN4 aux. analog input scale	Same as D5187 (SH_E4)
D7531	SL_E4_R	Minimum value of AIN4 aux. analog input scale	Same as D5188 (SL_E4)
D7532			
D7533	P.DP_L1_R	Loop-1 control PV input decimal point position	Same as D5202 (P.DP_L1)
D7534	P.RH_L1_R	Loop-1 maximum value of control PV input range	Same as D5203 (P.RH_L1)
D7535	P.RL_L1_R	Loop-1 minimum value of control PV input range	Same as D5204 (P.RL_L1)
D7536			
D7537	P.DP_L2_R	Loop-2 control PV input decimal point position (in Cascade control)	Same as D5222 (P.DP_L2)
D7538	P.RH_L2_R	Loop-2 maximum value of Control PV input range (in Cascade control)	Same as D5223 (P.RH_L2)
D7539	P.RL_L2_R	Loop-2 minimum value of Control PV input range (in Cascade control)	Same as D5224 (P.RL_L2)
D7540 to D7600			

6.4 UT55A/UT52A/UP55A D Registers

6.4.9 Input / Output Terminal Status Register (D7601 to D7700)

Terminal status registers													
Input / output terminal status register													
D-Reg No.	Ref. No.	H No.	Register symbol	R/W			D-Reg No.	Ref. No.	H No.	Register symbol	R/W		
				UT 55A	UT 52A	UP 55A					UT 55A	UT 52A	UP 55A
D7601	47601	1DB0	DI	R	R	R	D7651	47651	1DE2				
D7602	47602	1DB1	DI_E1	R	R	R	D7652	47652	1DE3				
D7603	47603	1DB2	DI_E2	R		R	D7653	47653	1DE4				
D7604	47604	1DB3	DI_E3	R		R	D7654	47654	1DE5				
D7605	47605	1DB4	DI_E4	R		R	D7655	47655	1DE6				
D7606	47606	1DB5					D7656	47656	1DE7				
D7607	47607	1DB6					D7657	47657	1DE8				
D7608	47608	1DB7					D7658	47658	1DE9				
D7609	47609	1DB8					D7659	47659	1DEA				
D7610	47610	1DB9					D7660	47660	1DEB				
D7611	47611	1DBA	OUT_AL	R	R	R	D7661	47661	1DEC				
D7612	47612	1DBB	OUT_DO_E1	R	R	R	D7662	47662	1DED				
D7613	47613	1DBC	OUT_DO_E2	R		R	D7663	47663	1DEE				
D7614	47614	1DBD	OUT_DO_E3	R		R	D7664	47664	1DEF				
D7615	47615	1DBE	OUT_DO_E4	R		R	D7665	47665	1DF0				
D7616	47616	1DBF					D7666	47666	1DF1				
D7617	47617	1DC0					D7667	47667	1DF2				
D7618	47618	1DC1					D7668	47668	1DF3				
D7619	47619	1DC2					D7669	47669	1DF4				
D7620	47620	1DC3					D7670	47670	1DF5				
D7621	47621	1DC4	OUT_OUT	R	R	R	D7671	47671	1DF6				
D7622	47622	1DC5	OUT_OUT2H	R	R	R	D7672	47672	1DF7				
D7623	47623	1DC6	OUT_OUT2L	R	R	R	D7673	47673	1DF8				
D7624	47624	1DC7	OUT_RET	R	R	R	D7674	47674	1DF9				
D7625	47625	1DC8	OUT_OUTR	R	R	R	D7675	47675	1DFA				
D7626	47626	1DC9	OUT_OUT2R		R		D7676	47676	1DFB				
D7627	47627	1DCA					D7677	47677	1DFC				
D7628	47628	1DCB					D7678	47678	1DFD				
D7629	47629	1DCC					D7679	47679	1DFE				
D7630	47630	1DCD					D7680	47680	1DFF				
D7631	47631	1DCE					D7681	47681	1E00				
D7632	47632	1DCF					D7682	47682	1E01				
D7633	47633	1DD0					D7683	47683	1E02				
D7634	47634	1DD1					D7684	47684	1E03				
D7635	47635	1DD2					D7685	47685	1E04				
D7636	47636	1DD3					D7686	47686	1E05				
D7637	47637	1DD4					D7687	47687	1E06				
D7638	47638	1DD5					D7688	47688	1E07				
D7639	47639	1DD6					D7689	47689	1E08				
D7640	47640	1DD7					D7690	47690	1E09				
D7641	47641	1DD8					D7691	47691	1E0A				
D7642	47642	1DD9					D7692	47692	1E0B				
D7643	47643	1DDA					D7693	47693	1E0C				
D7644	47644	1ddb					D7694	47694	1E0D				
D7645	47645	1DDC					D7695	47695	1E0E				
D7646	47646	1DDD					D7696	47696	1E0F				
D7647	47647	1DDE					D7697	47697	1E10				
D7648	47648	1DDF					D7698	47698	1E11				
D7649	47649	1DE0					D7699	47699	1E12				
D7650	47650	1DE1					D7700	47700	1E13				

● **Bit Configuration of D7601: DI (DI1-DI3 terminal status: equipped as standard)**

Bit	Symbol	Event	
0	DI1	DI1 terminal status	(0: OFF 1: ON)
1	DI2	DI2 terminal status	(0: OFF 1: ON)
2	DI3	DI3 terminal status	(0: OFF 1: ON)
3 to 15			

● **Bit Configuration of D7602: DI_E1 (DI11-DI16 terminal status: E1-terminal area)**

Bit	Symbol	Event	
0	DI11	DI11 terminal status	(0: OFF 1: ON)
1	DI12	DI12 terminal status	(0: OFF 1: ON)
2	DI13	DI13 terminal status	(0: OFF 1: ON)
3	DI14	DI14 terminal status	(0: OFF 1: ON)
4	DI15	DI15 terminal status	(0: OFF 1: ON)
5	DI16	DI16 terminal status	(0: OFF 1: ON)
6 to 15			

● **Bit Configuration of D7603: DI_E2 (DI21-DI26 terminal status: E2-terminal area)**

Bit	Symbol	Event	
0	DI21	DI21 terminal status	(0: OFF 1: ON)
1	DI22	DI22 terminal status	(0: OFF 1: ON)
2	DI23	DI23 terminal status	(0: OFF 1: ON)
3	DI24	DI24 terminal status	(0: OFF 1: ON)
4	DI25	DI25 terminal status	(0: OFF 1: ON)
5	DI26	DI26 terminal status	(0: OFF 1: ON)
5 to 15			

● **Bit Configuration of D7604: DI_E3 (DI31- DI35 terminal status: E3-terminal area)**

Bit	Symbol	Event	
0	DI31	DI31 terminal status	(0: OFF 1: ON)
1	DI32	DI32 terminal status	(0: OFF 1: ON)
2	DI33	DI33 terminal status	(0: OFF 1: ON)
3	DI34	DI34 terminal status	(0: OFF 1: ON)
4	DI35	DI35 terminal status	(0: OFF 1: ON)
5 to 15			

● **Bit Configuration of D7605: DI_E4 (DI41-DI46 terminal status: E4-terminal area)**

Bit	Symbol	Event	
0	DI41	DI41 terminal status	(0: OFF 1: ON)
1	DI42	DI42 terminal status	(0: OFF 1: ON)
2	DI43	DI43 terminal status	(0: OFF 1: ON)
3	DI44	DI44 terminal status	(0: OFF 1: ON)
4	DI45	DI45 terminal status	(0: OFF 1: ON)
5	DI46	DI46 terminal status	(0: OFF 1: ON)
6 to 15			

● **Bit Configuration of D7611: OUT_AL (AL1-AL3 terminal status: equipped as standard)**

Bit	Symbol	Event	
0	OUT_AL1	AL1 terminal status	(0: OFF 1: ON)
1	OUT_AL2	AL2 terminal status	(0: OFF 1: ON)
2	OUT_AL3	AL3 terminal status	(0: OFF 1: ON)
3 to 15			

6.4 UT55A/UT52A/UP55A D Registers

● Bit Configuration of D7612: OUT_DO_E1 (DO11-DO15 terminal status: E1-terminal area)

Bit	Symbol	Event
0	OUT_DO11	DO11 terminal status (0: OFF 1: ON)
1	OUT_DO12	DO12 terminal status (0: OFF 1: ON)
2	OUT_DO13	DO13 terminal status (0: OFF 1: ON)
3	OUT_DO14	DO14 terminal status (0: OFF 1: ON)
4	OUT_DO15	DO15 terminal status (0: OFF 1: ON)
5 to 15		

● Bit Configuration of D7613: OUT_DO_E2 (DO21-DO25 terminal status: E2-terminal area)

Bit	Symbol	Event
0	OUT_DO21	DO21 terminal status (0: OFF 1: ON)
1	OUT_DO22	DO22 terminal status (0: OFF 1: ON)
2	OUT_DO23	DO23 terminal status (0: OFF 1: ON)
3	OUT_DO24	DO24 terminal status (0: OFF 1: ON)
4	OUT_DO25	DO25 terminal status (0: OFF 1: ON)
5 to 15		

● Bit Configuration of D7614: OUT_DO_E3 (DO31-DO35 terminal status: E3-terminal area)

Bit	Symbol	Event
0	OUT_DO31	DO31 terminal status (0: OFF 1: ON)
1	OUT_DO32	DO32 terminal status (0: OFF 1: ON)
2	OUT_DO33	DO33 terminal status (0: OFF 1: ON)
3	OUT_DO34	DO34 terminal status (0: OFF 1: ON)
4	OUT_DO35	DO35 terminal status (0: OFF 1: ON)
5 to 15		

● Bit Configuration of D7615: OUT_DO_E4 (DO41-DO45 terminal status: E4-terminal area)

Bit	Symbol	Event
0	OUT_DO41	DO41 terminal status (0: OFF 1: ON)
1	OUT_DO42	DO42 terminal status (0: OFF 1: ON)
2	OUT_DO43	DO43 terminal status (0: OFF 1: ON)
3	OUT_DO44	DO44 terminal status (0: OFF 1: ON)
4	OUT_DO45	DO45 terminal status (0: OFF 1: ON)
5 to 15		

● D7616 to D7700

Register No.	Description		Range and meaning of value
D7616 to D7620			
D7621	OUT_OUT	OUT terminal	-1500 to 31500
D7622	OUT_OUT2H	UT55A/UP55A Cooling-side control output: OUT2 terminal (Relay) Heater break alarm: HAL1 terminal Position proportional control output: VALV (HIGH) terminal UT52A Heater break alarm: HAL1 terminal	0: OFF 30000: ON
D7623	OUT_OUT2L	Cooling-side control output in Heating/cooling control: OUT2 terminal	-1500 to 31500
		UT55A/UP55A Heater break alarm: HAL2 terminal Position proportional control output: VALV (LOW) terminal UT52A Heater break alarm: HAL2 terminal	0: OFF 30000: ON
D7624	OUT_RET	RET terminal	-1500 to 31500
D7625	OUT_OUTR	UT55A/UP55A OUT terminal (Relay) UT52A OUT terminal (Relay) Position proportional control output: VALV (LOW) terminal	-1500 to 31500
D7626	OUT_OUT2R	UT55A/UP55A OUT2 terminal (Relay) UT52A Cooling-side control output: OUT2 terminal (Relay) Position proportional control output: VALV (HIGH) terminal	-1500 to 31500
D7627 to D7700			

6.4.10 Program Pattern for UP55A (D8001 to D9000)

Pattern Data Setting (D8001 to D8100)

Register No.	Ref. No.	H No.	Register symbol	R/W	Description	Range and meaning of value	
D8001	48001	1F40	PTNO_C	R/W	Program pattern number selection	0: Not select program pattern 1 to 30	
D8002	48002	1F41	SEGNO_C	R/W	Segment number designation	0 (1 to 99) *:When reading from or writing to D8003 to D8043 registers, write "0" to the register.	
D8003	48003	1F42	SSP_L1	R/W	Loop-1 Starting target setpoint	0.0 to 100.0% of PV input range (EU) (Setting range: P.RL to P.RH)	
D8004	48004	1F43	SSP_L2	R/W	Loop-2 Starting target setpoint		
D8005	48005	1F44	STC	R/W	Start code	0: SSP (Program operation begins with the starting target setpoint. 1: RAMP (Ramp-prioritized PV start) 2: TIME (Time-prioritized PV start) 4: LSP (Local-mode start) 5: RSP (Remote-mode start) * STC=TIME cannot be selected when the parameter SEG.T is TM.RT.	
D8006	48006	1F45	WT.SW1	R/W	Wait function ON/OFF 1	WT.SW1 to WT.SW5 0: OFF (Disable) 1: ON (Enable) WZ.UP1 to WZ.UP5 0.0 to 10.0% of PV input range (EU) WT.TM1 to WT.TM5 0: OFF (No function) 1 to 59999 (minute or second) * Available only for the wait time at the segment switching. * Use the parameter TMU to set the time unit. (Common in the instrument.)	
D8007	48007	1F46	WZ.UP1	R/W	Upper-side wait zone 1		
D8008	48008	1F47	WZ.LO1	R/W	Lower-side wait zone 1		
D8009	48009	1F48	WT.TM1	R/W	Wait time 1		
D8010	48010	1F49	WT.SW2	R/W	Wait function ON/OFF 2		
D8011	48011	1F4A	WZ.UP2	R/W	Upper-side wait zone 2		
D8012	48012	1F4B	WZ.LO2	R/W	Lower-side wait zone 2		
D8013	48013	1F4C	WT.TM2	R/W	Wait time 2		
D8014	48014	1F4D	WT.SW3	R/W	Wait function ON/OFF 3		
D8015	48015	1F4E	WZ.UP3	R/W	Upper-side wait zone 3		
D8016	48016	1F4F	WZ.LO3	R/W	Lower-side wait zone 3		
D8017	48017	1F50	WT.TM3	R/W	Wait time 3		
D8018	48018	1F51	WT.SW4	R/W	Wait function ON/OFF 4		
D8019	48019	1F52	WZ.UP4	R/W	Upper-side wait zone 4		
D8020	48020	1F53	WZ.LO4	R/W	Lower-side wait zone 4		
D8021	48021	1F54	WT.TM4	R/W	Wait time 4		
D8022	48022	1F55	WT.SW5	R/W	Wait function ON/OFF 5		
D8023	48023	1F56	WZ.UP5	R/W	Upper-side wait zone 5		
D8024	48024	1F57	WZ.LO5	R/W	Lower-side wait zone 5		
D8025	48025	1F58	WT.TM5	R/W	Wait time 5		
D8026	48026	1F59	R.CYCL	R/W	Number of repeat cycles		0 to 999, 1000: CONT (The controller indefinitely repeats the segment specified by the RST and REN parameters.)
D8027	48027	1F5A	R.STRT	R/W	Repeat cycle start segment number		1 to 99
D8028	48028	1F5B	R.END	R/W	Repeat cycle end segment number		1 ≤ R.STRT ≤ R.END ≤ 99
D8029	48029	1F5C					
D8030	48030	1F5D					
D8031	48031	1F5E	P.NAME	R/W	Program pattern name	20-digit value of alphanumeric characters can be set. Arrangement: D8031, D8032, D8033, D6004, D8035, D8036, D8037, D8038, D8039, D8040, D8041 Write "0x00" to the register after the character string.	
D8032	48032	1F5F	P.NAME	R/W	Program pattern name		
D8033	48033	1F60	P.NAME	R/W	Program pattern name		
D8034	48034	1F61	P.NAME	R/W	Program pattern name		
D8035	48035	1F62	P.NAME	R/W	Program pattern name		
D8036	48036	1F63	P.NAME	R/W	Program pattern name		
D8037	48037	1F64	P.NAME	R/W	Program pattern name		
D8038	48038	1F65	P.NAME	R/W	Program pattern name		
D8039	48039	1F66	P.NAME	R/W	Program pattern name		
D8040	48040	1F67	P.NAME	R/W	Program pattern name		
D8041	48041	1F68	P.NAME	R/W	Program pattern name		
D8042	48042	1F69	PTN.ERR	R	Read/write error information		0: Normal end Except 0: error (See "Error information" described later in this chapter.)
D8043 to D8100							

Reading Pattern Data (D8001 to D8100)

■ Modbus communication

The example for the communication command is Modbus/RTU. For easy understanding, space is added but it is not present in the actual command. The device address is "1."

● Reading start segment data

Example: Reading start target setpoint (SSP_L1) for pattern 2

- (1) Write pattern number "2" to D8001 (PTNO._C), and segment number "0" to D8002 (SEGNO._C).
- (2) Read from D8003 (SSP_L1).
- (3) Read from D8042 (PTN.ERR).

If reading PTN.ERR results in other than zero, an error occurred. If zero, the read was successful.

```
(1) 01 10 1F40 0002 04 0002 0000 [CRC]
(2) 01 03 1F42 0001 [CRC]
(3) 01 03 1F69 0001 [CRC]
```

Example: Batch reading start segment data for pattern 2

- (1) Write pattern number "2" to D8001 (PTNO._C), and segment number "0" to D8002 (SEGNO._C).
- (2) Read from 40 registers continuously: D8003 (SSP_L1) to D8041 (P.NAME) and D8042 (PTN.ERR).

If reading PTN.ERR results in other than zero, an error occurred. If zero, the read was successful.

```
(1) 01 10 1F40 0002 04 0002 0000 [CRC]
(2) 01 03 1F42 0028 [CRC]
```

■ PC link communication

The example for the communication command is a PC link without a checksum. The device address is "1."

● Reading start segment data

Example: Reading start target setpoint (SSP_L1) for pattern 2

- (1) Write pattern number "2" to D8001 (PTNO._C), and segment number "0" to D8002 (SEGNO._C).
- (2) Read from D8003 (SSP_L1).
- (3) Read from D8042 (PTN.ERR).

If reading PTN.ERR results in other than zero, an error occurred. If zero, the read was successful.

```
(1) 01010WWRD8001,02,00020000
(2) 01010WRDD8003,01
(3) 01010WRDD8042,01
```

Example: Batch reading start segment data for pattern 2

- (1) Write pattern number "2" to D8001 (PTNO._C), and segment number "0" to D8002 (SEGNO._C).
- (2) Read from 40 registers continuously: D8003 (SSP_L1) to D8041 (P.NAME) and D8042 (PTN.ERR).

If reading PTN.ERR results in other than zero, an error occurred. If zero, the read was successful.

```
(1) 01010WWRD8001,02,00020000
(2) 01010WRDD8003,40
```

Writing Pattern Data (D8001 to D8100)

■ Modbus communication

The example for the communication command is Modbus/RTU. For easy understanding, space is added but it is not present in the actual command. The device address is "1."

● Writing start segment data

Example: Writing "2" to start code (STC) for pattern 2

- (1) Write pattern number "2" to D8001 (PTNO._C), and segment number "0" to D8002 (SEGNO._C).
- (2) Write "2" to D8005 (STC).
- (3) Read from D8042 (PTN.ERR).

If the result is other than zero, an error occurred. If zero, the write was successful.

- (1) 01 10 1F40 0002 04 0002 0000 [CRC]
- (2) 01 10 1F44 0001 02 0002 [CRC]
- (3) 01 03 1F69 0001 [CRC]

Example: Batch writing start segment data for pattern 2

- (1) Write to 41 registers continuously: pattern number "2" to D8001 (PTNO._C), segment number "0" to D8002 (SEGNO._C), and data to D8003 (SSP_L1) to D8041 (P.NAME).
If "PTN.ERR" in the response is other than zero, an error occurred. If zero, the write was successful.

- (1) 01 46 1F40 0029 52 0002 0000 **03 **04 ... **40 **41 [CRC]

■ PC link communication

The example for the communication command is a PC link without a checksum. The device address is "1."

● Writing start segment data

Example: Writing "2" to start code (STC) for pattern 2

- (1) Write pattern number "2" to D8001 (PTNO._C), and segment number "0" to D8002 (SEGNO._C).
- (2) Write "2" to D8005 (STC).
- (3) Read from D8042 (PTN.ERR).

If the result is other than zero, an error occurred. If zero, the write was successful.

- (1) 01010WWRD8001,02,00020000
- (2) 01010WWRD8005,01,0002
- (3) 01010WRDD8042,01

Example: Batch writing start segment data for pattern 2

- (1) Write to 41 registers continuously: pattern number "2" to D8001 (PTNO._C), segment number "0" to D8002 (SEGNO._C), and data to D8003 (SSP_L1) to D8041 (P.NAME).
- (2) Read from D8042 (PTN.ERR).

If the result is other than zero, an error occurred. If zero, the write was successful.

- (1) 01010WWRD8001,41,0002 0000 **03 **04 ... **40 **41
- (2) 01010WRDD8042,01

Segment Data Setting (D8101 to D8200)

Register No.	Ref. No.	H No.	Register symbol	R/W	Description	Range and meaning of value
D8101	48101	1FA4	PTNO._C	R/W	Program pattern number selection	0: Not select program pattern 1 to 30
D8102	48102	1FA5	SEGNO._C	R/W	Segment number designation	(0) 1 to 99
D8103	48103	1FA6	TSP_L1	R/W	Loop-1 final target setpoint	0.0 to 100.0% of PV input range (EU) (Setting range: P.RL to P.RH)
D8104	48104	1FA7	TSP_L2	R/W	Loop-2 final target setpoint	
D8105	48105	1FA8	TIME	R/W	Segment time setting	Unregistered (65535) 0 to 59999 (minute or second) * Setting available for the parameter SEG. T=TIME.* Use the parameter TMU to set the time unit. (Common in the instrument.) * If the setting is 0.00, TSP changes in stepwise after one control period.
D8106	48106	1FA9	TM.RT	R/W	Segment ramp-rate setting	Unregistered (65535) Ramp: 0.0 to 100.0% of PV input range span (EUS) / 1 hour or 1 minute Soak: 0 to 59999 (minute or second) * Setting available for the parameter SEG. T=RAMP. * Use the parameter TMU to set the time unit. (Common in the instrument.) Per 1 hour: TMU=HH.MM, Per 1 minute: TMU=MM.SS * If it is set to 0.0% of the input range span, or the segment time 0.00, the program moves to the next segment after one control period.
D8107	48107	1FAA	S.PID	R/W	Segment PID number selection	1 to 8 * PID number can be set when the parameter "ZON = 0."
D8108	48108	1FAB	JC	R/W	Junction code	0: CONT (Switching for continuation) 1: HOLD (Hold-on switching (the controller holds the end-of-segment setpoint when the segment is completed, to perform control)). 2: LOC (Local-mode switching (the controller switches to a local setpoint when the segment is completed)). 3: REM (Remote-mode switching (the controller switches to a remote setpoint when the segment is completed)). 11 to 15: W.SW1 to W.SW5 (Wait during switching between segments). 16 to 20: W.IV1 to W.IV5 (Wait within a segment interval). 21 to 25: W.SL1 to W.SL5 (Segment switching (the controller switches to a local setpoint when the segment is completed after release.)) (5 groups) 26 to 30: W.SR1 to W.SR5 (Segment switching (the controller switches to a remote setpoint when the segment is completed after release.)) (5 groups) 31 to 60: PLK.1 to PLK.30 (Linked to patterns 1 to 30.)

6.4 UT55A/UT52A/UP55A D Registers

Register No.	Ref. No.	H No.	Register symbol	R/W	Description	Range and meaning of value	
D8109	48109	1FAC	PV.TY1	R/W	PV event-1 type	OFF: Disable (Energized) 1: PV high limit, 02: PV low limit, 3: SP high limit, 04: SP low limit, 5: Deviation high limit, 6: Deviation low limit, 7: Deviation high and low limits, 8: Deviation within high and low limits, 9: Target SP high limit, 10: Target SP low limit, 11: Target SP deviation high limit, 12: Target SP deviation low limit, 13: Target SP deviation high and low limits, 14: Target SP deviation within high and low limits, 15: OUT high limit, 16: OUT low limit, 17: Cooling-side OUT high limit, 18: Cooling-side OUT low limit * Add 100 for "de-energized". For example, when the PV high limit is de-energized, the setting is 101.	
D8110	48110	1FAD	PV.EV1	R/W	PV event-1 setpoint	Set a display value of setpoint of PV alarm, SP alarm, deviation alarm, or output alarm. -19999 to 30000 (Set a value within the input range.) Decimal point position depends on the input type.	
D8111	48111	1FAE	PV.TY2	R/W	PV event-2 type	PV.TY2 to PV.TY8 Same as D8109 PV.EV2 to PV.EV8 Same as D8110	
D8112	48112	1FAF	PV.EV2	R/W	PV event-2 setpoint		
D8113	48113	1FB0	PV.TY3	R/W	PV event-3 type		
D8114	48114	1FB1	PV.EV3	R/W	PV event-3 setpoint		
D8115	48115	1FB2	PV.TY4	R/W	PV event-4 type		
D8116	48116	1FB3	PV.EV4	R/W	PV event-4 setpoint		
D8117	48117	1FB4	PV.TY5	R/W	PV event-5 type		
D8118	48118	1FB5	PV.EV5	R/W	PV event-5 setpoint		
D8119	48119	1FB6	PV.TY6	R/W	PV event-6 type		
D8120	48120	1FB7	PV.EV6	R/W	PV event-6 setpoint		
D8121	48121	1FB8	PV.TY7	R/W	PV event-7 type		
D8122	48122	1FB9	PV.EV7	R/W	PV event-7 setpoint		
D8123	48123	1FBA	PV.TY8	R/W	PV event-8 type		
D8124	48124	1FBB	PV.EV8	R/W	PV event-8 setpoint		
D8125	48125	1FBC	TME1	R/W	Start condition of time event 1		0: OFF (Start OFF state) 1: ON (Start ON state)
D8126	48126	1FBD	T.ON1	R/W	On time of time event 1		0: Unregistered 1 to 59999 (minute or second) * Available only within the segment time. * OFF when the operation mode is changed to the mode except the program operation.
D8127	48127	1FBE	T.OF1	R/W	Off time of time event 1	* Use the parameter TMU to set the time unit. (Common in the instrument.)	

6.4 UT55A/UT52A/UP55A D Registers

Register No.	Ref. No.	H No.	Register symbol	R/W	Description	Range and meaning of value
D8128	48128	1FBF	TME2	R/W	Start condition of time event 2	TME2 to TME16 Same as D8125
D8129	48129	1FC0	T.ON2	R/W	On time of time event 2	
D8130	48130	1FC1	T.OF2	R/W	Off time of time event 2	
D8131	48131	1FC2	TME3	R/W	Start condition of time event 3	
D8132	48132	1FC3	T.ON3	R/W	On time of time event 3	
D8133	48133	1FC4	T.OF3	R/W	Off time of time event 3	
D8134	48134	1FC5	TME4	R/W	Start condition of time event 4	
D8135	48135	1FC6	T.ON4	R/W	On time of time event 4	
D8136	48136	1FC7	T.OF4	R/W	Off time of time event 4	
D8137	48137	1FC8	TME5	R/W	Start condition of time event 5	
D8138	48138	1FC9	T.ON5	R/W	On time of time event 5	
D8139	48139	1FCA	T.OF5	R/W	Off time of time event 5	
D8140	48140	1FCB	TME6	R/W	Start condition of time event 6	
D8141	48141	1FCC	T.ON6	R/W	On time of time event 6	
D8142	48142	1FCD	T.OF6	R/W	Off time of time event 6	
D8143	48143	1FCE	TME7	R/W	Start condition of time event 7	
D8144	48144	1FCF	T.ON7	R/W	On time of time event 7	
D8145	48145	1FD0	T.OF7	R/W	Off time of time event 7	
D8146	48146	1FD1	TME8	R/W	Start condition of time event 8	
D8147	48147	1FD2	T.ON8	R/W	On time of time event 8	
D8148	48148	1FD3	T.OF8	R/W	Off time of time event 8	
D8149	48149	1FD4	TME9	R/W	Start condition of time event 9	
D8150	48150	1FD5	T.ON9	R/W	On time of time event 9	
D8151	48151	1FD6	T.OF9	R/W	Off time of time event 9	
D8152	48152	1FD7	TME10	R/W	Start condition of time event 10	
D8153	48153	1FD8	T.ON10	R/W	On time of time event 10	
D8154	48154	1FD9	T.OF10	R/W	Off time of time event 10	
D8155	48155	1FDA	TME11	R/W	Start condition of time event 11	
D8156	48156	1FDB	T.ON11	R/W	On time of time event 11	
D8157	48157	1FDC	T.OF11	R/W	Off time of time event 11	
D8158	48158	1FDD	TME12	R/W	Start condition of time event 12	
D8159	48159	1FDE	T.ON12	R/W	On time of time event 12	
D8160	48160	1FDF	T.OF12	R/W	Off time of time event 12	
D8161	48161	1FE0	TME13	R/W	Start condition of time event 13	
D8162	48162	1FE1	T.ON13	R/W	On time of time event 13	
D8163	48163	1FE2	T.OF13	R/W	Off time of time event 13	
D8164	48164	1FE3	TME14	R/W	Start condition of time event 14	
D8165	48165	1FE4	T.ON14	R/W	On time of time event 14	
D8166	48166	1FE5	T.OF14	R/W	Off time of time event 14	
D8167	48167	1FE6	TME15	R/W	Start condition of time event 15	
D8168	48168	1FE7	T.ON15	R/W	On time of time event 15	
D8169	48169	1FE8	T.OF15	R/W	Off time of time event 15	
D8170	48170	1FE9	TME16	R/W	Start condition of time event 16	
D8171	48171	1FEA	T.ON16	R/W	On time of time event 16	
D8172	48172	1FEB	T.OF16	R/W	Off time of time event 16	
D8173	48173	1FEC	PTN.ERR	R	Read/write error information	0: normal end Except 0: error (See "Error information" described later in this chapter.)
D8174 to D8200						

Reading Segment Data (D8101 to D8200)

■ Modbus communication

The example for the communication command is Modbus/RTU. For easy understanding, space is added but it is not present in the actual command. The device address is "1."

Example: Reading final target setpoint (TSP_L1) of segment 5 for pattern 3

- (1) Write pattern number "3" to D8101 (PTNO._C), and segment number "5" to D8102 (SEGNO._C).
- (2) Read from D8103 (TSP_L1).
- (3) Read from D8173 (PTN.ERR).

If the result is other than zero, an error occurred. If zero, the read was successful.

- (1) 01 10 1FA4 0002 04 0003 0005 [CRC]
- (2) 01 03 1FA6 0001 [CRC]
- (3) 01 03 1FEC 0001 [CRC]

Example: Batch reading segment data of segment 5 for pattern 3

- (1) Write pattern number "3" to D8101 (PTNO._C), and segment number "5" to D8102 (SEGNO._C).
- (2) Read from 71 registers continuously: D8103 (TSP_L1) to D8172 (T.OF16) and D8173 (PTN.ERR).

If reading PTN.ERR results in other than zero, an error occurred. If zero, the read was successful.

- (1) 01 10 1FA4 0002 04 0003 0005 [CRC]
- (2) 01 03 1FA6 0047 [CRC]

■ PC link communication

The example for the communication command is a PC link without a checksum. The device address is "1."

Example: Reading final target setpoint (TSP_L1) of segment 5 for pattern 3

- (1) Write pattern number "3" to D8101 (PTNO._C), and segment number "5" to D8102 (SEGNO._C).
- (2) Read from D8103 (TSP_L1).
- (3) Read from D8173 (PTN.ERR).

If the result is other than zero, an error occurred. If zero, the read was successful.

- (1) 01010WWRD8101,02,00030005
- (2) 01010WRDD8103,01
- (3) 01010WRDD8173,01

Example: Batch reading segment data of segment 5 for pattern 3

- (1) Write pattern number "3" to D8101 (PTNO._C) and segment number "5" to D8102 (SEGNO._C).
- (2) Read from 64 registers continuously: D8103 (TSP_L1) to D8166 (T.OF14).
- (3) Read from D8173 (PTN.ERR).

If the result is other than zero, an error occurred. If zero, the read was successful.

- (4) Read from 10 registers continuously: D8167 (TME15) to D8173 (PTN.ERR).
- If reading from PTN.ERR results in other than zero, an error occurred. If zero, the read was successful.

- (1) 01010WWRD8101,02,00030005
- (2) 01010WRDD8103,64
- (3) 01010WRDD8173,01
- (4) 01010WRDD8167,10

Writing Segment Data (D8101 to D8200)

■ Modbus communication

The example for the communication command is Modbus/RTU. For easy understanding, space is added but it is not present in the actual command. The device address is "1."

Example: Writing final target setpoint (TSP_L1) of segment 5 for pattern 3

- (1) Write pattern number "3" to D8101 (PTNO._C), and segment number "5" to D8102 (SEGNO._C).
- (2) Write "50" to D8103 (TSP_L1).
- (3) Read from D8173 (PTN.ERR).

If the result is other than zero, an error occurred. If zero, the write was successful.

```
(1) 01 10 1FA4 0002 04 0003 0005 [CRC]
(2) 01 10 1FA6 0001 02 0032 [CRC]
(3) 01 03 1FEC 0001 [CRC]
```

Example: Batch writing segment data of segment 5 for pattern 3

- (1) Write to 72 registers continuously: pattern number "3" to D8101 (PTNO._C), segment number "5" to D8102 (SEGNO._C), and data to D8103 (TSP_L1) to D8163 (T.OF13). If reading PTN.ERR results in other than zero, an error occurred. If zero, the write was successful.

```
(1) 01 46 1FA4 0048 90 0003 0005 **03 **04 ... **71 **72 [CRC]
```

■ PC link communication

The example for the communication command is a PC link without a checksum. The device address is "1."

Example: Writing final target setpoint (TSP_L1) of segment 5 for pattern 3

- (1) Write pattern number "3" to D8101 (PTNO._C), and segment number "5" to D8102 (SEGNO._C).
- (2) Read from D8103 (TSP_L1).
- (3) Read from D8173 (PTN.ERR).

If the result is other than zero, an error occurred. If zero, the write was successful.

```
(1) 01010WWRD8101,02,00030005
(2) 01010WWRD8103,01,0032
(3) 01010WRDD8173,01
```

Example: Batch writing segment data of segment 5 for pattern 3

- (1) Write to 63 registers continuously: pattern number "3" to D8101 (PTNO._C), segment number "5" to D8102 (SEGNO._C), and data to D8103 (TSP_L1) to D8163 (T.OF13).
- (2) Read from D8173 (PTN.ERR).
If the result is other than zero, an error occurred. If zero, the write was successful.
- (3) Write to 9 registers continuously: D8164 (TME14) to D8172 (T.OF16).
- (4) Read from D8173 (PTN.ERR).
If the result is other than zero, an error occurred. If zero, the write was successful

```
(1) 01010WWRD8101,63,0003 0005 **03 **04 ... **62 **63
(2) 01010WRDD8173,01
(3) 01010WWRD8164,09,**01 **02 ... **08 **09
(4) 01010WRDD8173,01
```

6.4 UT55A/UT52A/UP55A D Registers

Loop-1 Final Target Setpoint Setting for Batch Writing (D8201 to D8400)

Register No.	Ref. No.	H No.	Register symbol	R/W	Description	Range and meaning of value
D8201	48201	2008	PTNO_C	R/W	Program pattern number selection	0: Not select program pattern 1 to 30
D8202	48202	2009				
D8203	48203	200A	SSP_L1	R/W	Loop-1 starting target setpoint	0.0 to 100.0% of PV input range (EU) (Setting range: P.RL to P.RH)
D8204	48204	200B	TSP_L1_S1	R/W	Segment-1 final target setpoint	0.0 to 100.0% of PV input range (EU) (Setting range: P.RL to P.RH)
D8205	48205	200C	TSP_L1_S2	R/W	Segment-2 final target setpoint	
D8206	48206	200D	TSP_L1_S3	R/W	Segment-3 final target setpoint	
D8207	48207	200E	TSP_L1_S4	R/W	Segment-4 final target setpoint	
D8208	48208	200F	TSP_L1_S5	R/W	Segment-5 final target setpoint	
D8209	48209	2010	TSP_L1_S6	R/W	Segment-6 final target setpoint	
D8210	48210	2011	TSP_L1_S7	R/W	Segment-7 final target setpoint	
D8211	48211	2012	TSP_L1_S8	R/W	Segment-8 final target setpoint	
D8212	48212	2013	TSP_L1_S9	R/W	Segment-9 final target setpoint	
D8213	48213	2014	TSP_L1_S10	R/W	Segment-10 final target setpoint	
D8214	48214	2015	TSP_L1_S11	R/W	Segment-11 final target setpoint	
D8215	48215	2016	TSP_L1_S12	R/W	Segment-12 final target setpoint	
D8216	48216	2017	TSP_L1_S13	R/W	Segment-13 final target setpoint	
D8217	48217	2018	TSP_L1_S14	R/W	Segment-14 final target setpoint	
D8218	48218	2019	TSP_L1_S15	R/W	Segment-15 final target setpoint	
D8219	48219	201A	TSP_L1_S16	R/W	Segment-16 final target setpoint	
D8220	48220	201B	TSP_L1_S17	R/W	Segment-17 final target setpoint	
D8221	48221	201C	TSP_L1_S18	R/W	Segment-18 final target setpoint	
D8222	48222	201D	TSP_L1_S19	R/W	Segment-19 final target setpoint	
D8223	48223	201E	TSP_L1_S20	R/W	Segment-20 final target setpoint	
D8224	48224	201F	TSP_L1_S21	R/W	Segment-21 final target setpoint	
D8225	48225	2020	TSP_L1_S22	R/W	Segment-22 final target setpoint	
D8226	48226	2021	TSP_L1_S23	R/W	Segment-23 final target setpoint	
D8227	48227	2022	TSP_L1_S24	R/W	Segment-24 final target setpoint	
D8228	48228	2023	TSP_L1_S25	R/W	Segment-25 final target setpoint	
D8229	48229	2024	TSP_L1_S26	R/W	Segment-26 final target setpoint	
D8230	48230	2025	TSP_L1_S27	R/W	Segment-27 final target setpoint	
D8231	48231	2026	TSP_L1_S28	R/W	Segment-28 final target setpoint	
D8232	48232	2027	TSP_L1_S29	R/W	Segment-29 final target setpoint	
D8233	48233	2028	TSP_L1_S30	R/W	Segment-30 final target setpoint	
D8234	48234	2029	TSP_L1_S31	R/W	Segment-31 final target setpoint	
D8235	48235	202A	TSP_L1_S32	R/W	Segment-32 final target setpoint	
D8236	48236	202B	TSP_L1_S33	R/W	Segment-33 final target setpoint	
D8237	48237	202C	TSP_L1_S34	R/W	Segment-34 final target setpoint	
D8238	48238	202D	TSP_L1_S35	R/W	Segment-35 final target setpoint	
D8239	48239	202E	TSP_L1_S36	R/W	Segment-36 final target setpoint	
D8240	48240	202F	TSP_L1_S37	R/W	Segment-37 final target setpoint	
D8241	48241	2030	TSP_L1_S38	R/W	Segment-38 final target setpoint	
D8242	48242	2031	TSP_L1_S39	R/W	Segment-39 final target setpoint	
D8243	48243	2032	TSP_L1_S40	R/W	Segment-40 final target setpoint	
D8244	48244	2033	TSP_L1_S41	R/W	Segment-41 final target setpoint	
D8245	48245	2034	TSP_L1_S42	R/W	Segment-42 final target setpoint	
D8246	48246	2035	TSP_L1_S43	R/W	Segment-43 final target setpoint	
D8247	48247	2036	TSP_L1_S44	R/W	Segment-44 final target setpoint	
D8248	48248	2037	TSP_L1_S45	R/W	Segment-45 final target setpoint	
D8249	48249	2038	TSP_L1_S46	R/W	Segment-46 final target setpoint	
D8250	48250	2039	TSP_L1_S47	R/W	Segment-47 final target setpoint	
D8251	48251	203A	TSP_L1_S48	R/W	Segment-48 final target setpoint	
D8252	48252	203B	TSP_L1_S49	R/W	Segment-49 final target setpoint	
D8253	48253	203C	PTN.ERR	R	Read/write error information	0: normal end Except 0: error (See "Error information" described later in this chapter.)
D8254 to D8300						

6.4 UT55A/UT52A/UP55A D Registers

Register No.	Ref. No.	H No.	Register symbol	R/W	Description	Range and meaning of value
D8301	48301	206C	PTNO._C	R/W	Program pattern number selection	0: Not select program pattern 1 to 30
D8302	48302	206D				
D8303	48303	206E	TSP_L1_S50	R/W	Segment-50 final target setpoint	0.0 to 100.0% of PV input range (EU) (Setting range: P.RL to P.RH)
D8304	48304	206F	TSP_L1_S51	R/W	Segment-51 final target setpoint	
D8305	48305	2070	TSP_L1_S52	R/W	Segment-52 final target setpoint	
D8306	48306	2071	TSP_L1_S53	R/W	Segment-53 final target setpoint	
D8307	48307	2072	TSP_L1_S54	R/W	Segment-54 final target setpoint	
D8308	48308	2073	TSP_L1_S55	R/W	Segment-55 final target setpoint	
D8309	48309	2074	TSP_L1_S56	R/W	Segment-56 final target setpoint	
D8310	48310	2075	TSP_L1_S57	R/W	Segment-57 final target setpoint	
D8311	48311	2076	TSP_L1_S58	R/W	Segment-58 final target setpoint	
D8312	48312	2077	TSP_L1_S59	R/W	Segment-59 final target setpoint	
D8313	48313	2078	TSP_L1_S60	R/W	Segment-60 final target setpoint	
D8314	48314	2079	TSP_L1_S61	R/W	Segment-61 final target setpoint	
D8315	48315	207A	TSP_L1_S62	R/W	Segment-62 final target setpoint	
D8316	48316	207B	TSP_L1_S63	R/W	Segment-63 final target setpoint	
D8317	48317	207C	TSP_L1_S64	R/W	Segment-64 final target setpoint	
D8318	48318	207D	TSP_L1_S65	R/W	Segment-65 final target setpoint	
D8319	48319	207E	TSP_L1_S66	R/W	Segment-66 final target setpoint	
D8320	48320	207F	TSP_L1_S67	R/W	Segment-67 final target setpoint	
D8321	48321	2080	TSP_L1_S68	R/W	Segment-68 final target setpoint	
D8322	48322	2081	TSP_L1_S69	R/W	Segment-69 final target setpoint	
D8323	48323	2082	TSP_L1_S70	R/W	Segment-70 final target setpoint	
D8324	48324	2083	TSP_L1_S71	R/W	Segment-71 final target setpoint	
D8325	48325	2084	TSP_L1_S72	R/W	Segment-72 final target setpoint	
D8326	48326	2085	TSP_L1_S73	R/W	Segment-73 final target setpoint	
D8327	48327	2086	TSP_L1_S74	R/W	Segment-74 final target setpoint	
D8328	48328	2087	TSP_L1_S75	R/W	Segment-75 final target setpoint	
D8329	48329	2088	TSP_L1_S76	R/W	Segment-76 final target setpoint	
D8330	48330	2089	TSP_L1_S77	R/W	Segment-77 final target setpoint	
D8331	48331	208A	TSP_L1_S78	R/W	Segment-78 final target setpoint	
D8332	48332	208B	TSP_L1_S79	R/W	Segment-79 final target setpoint	
D8333	48333	208C	TSP_L1_S80	R/W	Segment-80 final target setpoint	
D8334	48334	208D	TSP_L1_S81	R/W	Segment-81 final target setpoint	
D8335	48335	208E	TSP_L1_S82	R/W	Segment-82 final target setpoint	
D8336	48336	208F	TSP_L1_S83	R/W	Segment-83 final target setpoint	
D8337	48337	2090	TSP_L1_S84	R/W	Segment-84 final target setpoint	
D8338	48338	2091	TSP_L1_S85	R/W	Segment-85 final target setpoint	
D8339	48339	2092	TSP_L1_S86	R/W	Segment-86 final target setpoint	
D8340	48340	2093	TSP_L1_S87	R/W	Segment-87 final target setpoint	
D8341	48341	2094	TSP_L1_S88	R/W	Segment-88 final target setpoint	
D8342	48342	2095	TSP_L1_S89	R/W	Segment-89 final target setpoint	
D8343	48343	2096	TSP_L1_S90	R/W	Segment-90 final target setpoint	
D8344	48344	2097	TSP_L1_S91	R/W	Segment-91 final target setpoint	
D8345	48345	2098	TSP_L1_S92	R/W	Segment-92 final target setpoint	
D8346	48346	2099	TSP_L1_S93	R/W	Segment-93 final target setpoint	
D8347	48347	209A	TSP_L1_S94	R/W	Segment-94 final target setpoint	
D8348	48348	209B	TSP_L1_S95	R/W	Segment-95 final target setpoint	
D8349	48349	209C	TSP_L1_S96	R/W	Segment-96 final target setpoint	
D8350	48350	209D	TSP_L1_S97	R/W	Segment-97 final target setpoint	
D8351	48351	209E	TSP_L1_S98	R/W	Segment-98 final target setpoint	
D8352	48352	209F	TSP_L1_S99	R/W	Segment-99 final target setpoint	
D8353	48353	20A0	PTN.ERR	R	Read/write error information	0: normal end Except 0: error (See "Error information" described later in this chapter.)
D8354 to D8400						

6.4 UT55A/UT52A/UP55A D Registers

Final Target Setpoint of Program Pattern-2 Retransmission for Batch Writing (D8401 to D8600)

Register No.	Ref. No.	H No.	Register symbol	R/W	Description	Range and meaning of value
D8401	48401	20D0	PTNO_C	R/W	Program pattern number selection	0: Not select program pattern 1 to 30
D8402	48402	20D1				
D8403	48403	20D2	SSP_L2	R/W	Loop-2 starting target setpoint	0.0 to 100.0% of PV input range (EU) (Setting range: P.RL to P.RH)
D8404	48404	20D3	TSP_L2_S1	R/W	Segment-1 final target setpoint	0.0 to 100.0% of PV input range (EU) (Setting range: P.RL to P.RH)
D8405	48405	20D4	TSP_L2_S2	R/W	Segment-2 final target setpoint	
D8406	48406	20D5	TSP_L2_S3	R/W	Segment-3 final target setpoint	
D8407	48407	20D6	TSP_L2_S4	R/W	Segment-4 final target setpoint	
D8408	48408	20D7	TSP_L2_S5	R/W	Segment-5 final target setpoint	
D8409	48409	20D8	TSP_L2_S6	R/W	Segment-6 final target setpoint	
D8410	48410	20D9	TSP_L2_S7	R/W	Segment-7 final target setpoint	
D8411	48411	20DA	TSP_L2_S8	R/W	Segment-8 final target setpoint	
D8412	48412	20DB	TSP_L2_S9	R/W	Segment-9 final target setpoint	
D8413	48413	20DC	TSP_L2_S10	R/W	Segment-10 final target setpoint	
D8414	48414	20DD	TSP_L2_S11	R/W	Segment-11 final target setpoint	
D8415	48415	20DE	TSP_L2_S12	R/W	Segment-12 final target setpoint	
D8416	48416	20DF	TSP_L2_S13	R/W	Segment-13 final target setpoint	
D8417	48417	20E0	TSP_L2_S14	R/W	Segment-14 final target setpoint	
D8418	48418	20E1	TSP_L2_S15	R/W	Segment-15 final target setpoint	
D8419	48419	20E2	TSP_L2_S16	R/W	Segment-16 final target setpoint	
D8420	48420	20E3	TSP_L2_S17	R/W	Segment-17 final target setpoint	
D8421	48421	20E4	TSP_L2_S18	R/W	Segment-18 final target setpoint	
D8422	48422	20E5	TSP_L2_S19	R/W	Segment-19 final target setpoint	
D8423	48423	20E6	TSP_L2_S20	R/W	Segment-20 final target setpoint	
D8424	48424	20E7	TSP_L2_S21	R/W	Segment-21 final target setpoint	
D8425	48425	20E8	TSP_L2_S22	R/W	Segment-22 final target setpoint	
D8426	48426	20E9	TSP_L2_S23	R/W	Segment-23 final target setpoint	
D8427	48427	20EA	TSP_L2_S24	R/W	Segment-24 final target setpoint	
D8428	48428	20EB	TSP_L2_S25	R/W	Segment-25 final target setpoint	
D8429	48429	20EC	TSP_L2_S26	R/W	Segment-26 final target setpoint	
D8430	48430	20ED	TSP_L2_S27	R/W	Segment-27 final target setpoint	
D8431	48431	20EE	TSP_L2_S28	R/W	Segment-28 final target setpoint	
D8432	48432	20EF	TSP_L2_S29	R/W	Segment-29 final target setpoint	
D8433	48433	20F0	TSP_L2_S30	R/W	Segment-30 final target setpoint	
D8434	48434	20F1	TSP_L2_S31	R/W	Segment-31 final target setpoint	
D8435	48435	20F2	TSP_L2_S32	R/W	Segment-32 final target setpoint	
D8436	48436	20F3	TSP_L2_S33	R/W	Segment-33 final target setpoint	
D8437	48437	20F4	TSP_L2_S34	R/W	Segment-34 final target setpoint	
D8438	48438	20F5	TSP_L2_S35	R/W	Segment-35 final target setpoint	
D8439	48439	20F6	TSP_L2_S36	R/W	Segment-36 final target setpoint	
D8440	48440	20F7	TSP_L2_S37	R/W	Segment-37 final target setpoint	
D8441	48441	20F8	TSP_L2_S38	R/W	Segment-38 final target setpoint	
D8442	48442	20F9	TSP_L2_S39	R/W	Segment-39 final target setpoint	
D8443	48443	20FA	TSP_L2_S40	R/W	Segment-40 final target setpoint	
D8444	48444	20FB	TSP_L2_S41	R/W	Segment-41 final target setpoint	
D8445	48445	20FC	TSP_L2_S42	R/W	Segment-42 final target setpoint	
D8446	48446	20FD	TSP_L2_S43	R/W	Segment-43 final target setpoint	
D8447	48447	20FE	TSP_L2_S44	R/W	Segment-44 final target setpoint	
D8448	48448	20FF	TSP_L2_S45	R/W	Segment-45 final target setpoint	
D8449	48449	2100	TSP_L2_S46	R/W	Segment-46 final target setpoint	
D8450	48450	2101	TSP_L2_S47	R/W	Segment-47 final target setpoint	
D8451	48451	2102	TSP_L2_S48	R/W	Segment-48 final target setpoint	
D8452	48452	2103	TSP_L2_S49	R/W	Segment-49 final target setpoint	
D8453	48453	2104	PTN.ERR	R	Read/write error information	0: normal end Except 0: error (See "Error information" described later in this chapter.)
D8454 to D8500						

6.4 UT55A/UT52A/UP55A D Registers

Register No.	Ref. No.	H No.	Register symbol	R/W	Description	Range and meaning of value
D8501	48501	2134	PTNO_C	R/W	Program pattern number selection	0: Not select program pattern 1 to 30
D8502	48502	2135				
D8503	48503	2136	TSP_L2_S50	R/W	Segment-50 final target setpoint	0.0 to 100.0% of PV input range (EU) (Setting range: P.RL to P.RH)
D8504	48504	2137	TSP_L2_S51	R/W	Segment-51 final target setpoint	
D8505	48505	2138	TSP_L2_S52	R/W	Segment-52 final target setpoint	
D8506	48506	2139	TSP_L2_S53	R/W	Segment-53 final target setpoint	
D8507	48507	213A	TSP_L2_S54	R/W	Segment-54 final target setpoint	
D8508	48508	213B	TSP_L2_S55	R/W	Segment-55 final target setpoint	
D8509	48509	213C	TSP_L2_S56	R/W	Segment-56 final target setpoint	
D8510	48510	213D	TSP_L2_S57	R/W	Segment-57 final target setpoint	
D8511	48511	213E	TSP_L2_S58	R/W	Segment-58 final target setpoint	
D8512	48512	213F	TSP_L2_S59	R/W	Segment-59 final target setpoint	
D8513	48513	2140	TSP_L2_S60	R/W	Segment-60 final target setpoint	
D8514	48514	2141	TSP_L2_S61	R/W	Segment-61 final target setpoint	
D8515	48515	2142	TSP_L2_S62	R/W	Segment-62 final target setpoint	
D8516	48516	2143	TSP_L2_S63	R/W	Segment-63 final target setpoint	
D8517	48517	2144	TSP_L2_S64	R/W	Segment-64 final target setpoint	
D8518	48518	2145	TSP_L2_S65	R/W	Segment-65 final target setpoint	
D8519	48519	2146	TSP_L2_S66	R/W	Segment-66 final target setpoint	
D8520	48520	2147	TSP_L2_S67	R/W	Segment-67 final target setpoint	
D8521	48521	2148	TSP_L2_S68	R/W	Segment-68 final target setpoint	
D8522	48522	2149	TSP_L2_S69	R/W	Segment-69 final target setpoint	
D8523	48523	214A	TSP_L2_S70	R/W	Segment-70 final target setpoint	
D8524	48524	214B	TSP_L2_S71	R/W	Segment-71 final target setpoint	
D8525	48525	214C	TSP_L2_S72	R/W	Segment-72 final target setpoint	
D8526	48526	214D	TSP_L2_S73	R/W	Segment-73 final target setpoint	
D8527	48527	214E	TSP_L2_S74	R/W	Segment-74 final target setpoint	
D8528	48528	214F	TSP_L2_S75	R/W	Segment-75 final target setpoint	
D8529	48529	2150	TSP_L2_S76	R/W	Segment-76 final target setpoint	
D8530	48530	2151	TSP_L2_S77	R/W	Segment-77 final target setpoint	
D8531	48531	2152	TSP_L2_S78	R/W	Segment-78 final target setpoint	
D8532	48532	2153	TSP_L2_S79	R/W	Segment-79 final target setpoint	
D8533	48533	2154	TSP_L2_S80	R/W	Segment-80 final target setpoint	
D8534	48534	2155	TSP_L2_S81	R/W	Segment-81 final target setpoint	
D8535	48535	2156	TSP_L2_S82	R/W	Segment-82 final target setpoint	
D8536	48536	2157	TSP_L2_S83	R/W	Segment-83 final target setpoint	
D8537	48537	2158	TSP_L2_S84	R/W	Segment-84 final target setpoint	
D8538	48538	2159	TSP_L2_S85	R/W	Segment-85 final target setpoint	
D8539	48539	215A	TSP_L2_S86	R/W	Segment-86 final target setpoint	
D8540	48540	215B	TSP_L2_S87	R/W	Segment-87 final target setpoint	
D8541	48541	215C	TSP_L2_S88	R/W	Segment-88 final target setpoint	
D8542	48542	215D	TSP_L2_S89	R/W	Segment-89 final target setpoint	
D8543	48543	215E	TSP_L2_S90	R/W	Segment-90 final target setpoint	
D8544	48544	215F	TSP_L2_S91	R/W	Segment-91 final target setpoint	
D8545	48545	2160	TSP_L2_S92	R/W	Segment-92 final target setpoint	
D8546	48546	2161	TSP_L2_S93	R/W	Segment-93 final target setpoint	
D8547	48547	2162	TSP_L2_S94	R/W	Segment-94 final target setpoint	
D8548	48548	2163	TSP_L2_S95	R/W	Segment-95 final target setpoint	
D8549	48549	2164	TSP_L2_S96	R/W	Segment-96 final target setpoint	
D8550	48550	2165	TSP_L2_S97	R/W	Segment-97 final target setpoint	
D8551	48551	2166	TSP_L2_S98	R/W	Segment-98 final target setpoint	
D8552	48552	2167	TSP_L2_S99	R/W	Segment-99 final target setpoint	
D8553	48553	2168	PTN.ERR	R	Read/write error information	0: normal end Except 0: error (See "Error information" described later in this chapter.)
D8554 to D8600						

6.4 UT55A/UT52A/UP55A D Registers

Segment Time Setting for Batch Writing (D8601 to D8800)

Register No.	Ref. No.	H No.	Register symbol	R/W	Description	Range and meaning of value
D8601	48601	2198	PTNO_C	R/W	Program pattern number selection	0: Not select program pattern 1 to 30
D8602	48602	2199				
D8603	48603	219A				
D8604	48604	219B	TIME_S1	R/W	Segment-1 segment time setting	
D8605	48605	219C	TIME_S2	R/W	Segment-2 segment time setting	
D8606	48606	219D	TIME_S3	R/W	Segment-3 segment time setting	
D8607	48607	219E	TIME_S4	R/W	Segment-4 segment time setting	
D8608	48608	219F	TIME_S5	R/W	Segment-5 segment time setting	
D8609	48609	21A0	TIME_S6	R/W	Segment-6 segment time setting	
D8610	48610	21A1	TIME_S7	R/W	Segment-7 segment time setting	
D8611	48611	21A2	TIME_S8	R/W	Segment-8 segment time setting	
D8612	48612	21A3	TIME_S9	R/W	Segment-9 segment time setting	
D8613	48613	21A4	TIME_S10	R/W	Segment-10 segment time setting	
D8614	48614	21A5	TIME_S11	R/W	Segment-11 segment time setting	
D8615	48615	21A6	TIME_S12	R/W	Segment-12 segment time setting	
D8616	48616	21A7	TIME_S13	R/W	Segment-13 segment time setting	
D8617	48617	21A8	TIME_S14	R/W	Segment-14 segment time setting	
D8618	48618	21A9	TIME_S15	R/W	Segment-15 segment time setting	
D8619	48619	21AA	TIME_S16	R/W	Segment-16 segment time setting	
D8620	48620	21AB	TIME_S17	R/W	Segment-17 segment time setting	
D8621	48621	21AC	TIME_S18	R/W	Segment-18 segment time setting	
D8622	48622	21AD	TIME_S19	R/W	Segment-19 segment time setting	
D8623	48623	21AE	TIME_S20	R/W	Segment-20 segment time setting	
D8624	48624	21AF	TIME_S21	R/W	Segment-21 segment time setting	
D8625	48625	21B0	TIME_S22	R/W	Segment-22 segment time setting	Unregistered (65535) 0 to 59999 (minute or second)
D8626	48626	21B1	TIME_S23	R/W	Segment-23 segment time setting	
D8627	48627	21B2	TIME_S24	R/W	Segment-24 segment time setting	* Setting available for the parameter SEG. T=TIME.
D8628	48628	21B3	TIME_S25	R/W	Segment-25 segment time setting	* Use the parameter TMU to set the time unit. (Common in the instrument.)
D8629	48629	21B4	TIME_S26	R/W	Segment-26 segment time setting	* If the setting is 0.00, TSP changes in stepwise after one control period.
D8630	48630	21B5	TIME_S27	R/W	Segment-27 segment time setting	
D8631	48631	21B6	TIME_S28	R/W	Segment-28 segment time setting	
D8632	48632	21B7	TIME_S29	R/W	Segment-29 segment time setting	
D8633	48633	21B8	TIME_S30	R/W	Segment-30 segment time setting	
D8634	48634	21B9	TIME_S31	R/W	Segment-31 segment time setting	
D8635	48635	21BA	TIME_S32	R/W	Segment-32 segment time setting	
D8636	48636	21BB	TIME_S33	R/W	Segment-33 segment time setting	
D8637	48637	21BC	TIME_S34	R/W	Segment-34 segment time setting	
D8638	48638	21BD	TIME_S35	R/W	Segment-35 segment time setting	
D8639	48639	21BE	TIME_S36	R/W	Segment-36 segment time setting	
D8640	48640	21BF	TIME_S37	R/W	Segment-37 segment time setting	
D8641	48641	21C0	TIME_S38	R/W	Segment-38 segment time setting	
D8642	48642	21C1	TIME_S39	R/W	Segment-39 segment time setting	
D8643	48643	21C2	TIME_S40	R/W	Segment-40 segment time setting	
D8644	48644	21C3	TIME_S41	R/W	Segment-41 segment time setting	
D8645	48645	21C4	TIME_S42	R/W	Segment-42 segment time setting	
D8646	48646	21C5	TIME_S43	R/W	Segment-43 segment time setting	
D8647	48647	21C6	TIME_S44	R/W	Segment-44 segment time setting	
D8648	48648	21C7	TIME_S45	R/W	Segment-45 segment time setting	
D8649	48649	21C8	TIME_S46	R/W	Segment-46 segment time setting	
D8650	48650	21C9	TIME_S47	R/W	Segment-47 segment time setting	
D8651	48651	21CA	TIME_S48	R/W	Segment-48 segment time setting	
D8652	48652	21CB	TIME_S49	R/W	Segment-49 segment time setting	
D8653	48653	21CC	PTN.ERR	R	Read/write error information	0: normal end Except 0: error (See "Error information" described later in this chapter.)
D8654 to D8700						

6.4 UT55A/UT52A/UP55A D Registers

Register No.	Ref. No.	H No.	Register symbol	R/W	Description	Range and meaning of value
D8701	48701	21FC	PTNO_C	R/W	Program pattern number selection	0: Not select program pattern 1 to 30
D8702	48702	21FD				
D8703	48703	21FE	TIME_S50	R/W	Segment-50 segment time setting	Unregistered (65535) 0 to 59999 (minute or second) * Setting available for the parameter SEG. T=TIME. * Use the parameter TMU to set the time unit. (Common in the instrument.) * If the setting is 0.00, TSP changes in stepwise after one control period.
D8704	48704	21FF	TIME_S51	R/W	Segment-51 segment time setting	
D8705	48705	2200	TIME_S52	R/W	Segment-52 segment time setting	
D8706	48706	2201	TIME_S53	R/W	Segment-53 segment time setting	
D8707	48707	2202	TIME_S54	R/W	Segment-54 segment time setting	
D8708	48708	2203	TIME_S55	R/W	Segment-55 segment time setting	
D8709	48709	2204	TIME_S56	R/W	Segment-56 segment time setting	
D8710	48710	2205	TIME_S57	R/W	Segment-57 segment time setting	
D8711	48711	2206	TIME_S58	R/W	Segment-58 segment time setting	
D8712	48712	2207	TIME_S59	R/W	Segment-59 segment time setting	
D8713	48713	2208	TIME_S60	R/W	Segment-60 segment time setting	
D8714	48714	2209	TIME_S61	R/W	Segment-61 segment time setting	
D8715	48715	220A	TIME_S62	R/W	Segment-62 segment time setting	
D8716	48716	220B	TIME_S63	R/W	Segment-63 segment time setting	
D8717	48717	220C	TIME_S64	R/W	Segment-64 segment time setting	
D8718	48718	220D	TIME_S65	R/W	Segment-65 segment time setting	
D8719	48719	220E	TIME_S66	R/W	Segment-66 segment time setting	
D8720	48720	220F	TIME_S67	R/W	Segment-67 segment time setting	
D8721	48721	2210	TIME_S68	R/W	Segment-68 segment time setting	
D8722	48722	2211	TIME_S69	R/W	Segment-69 segment time setting	
D8723	48723	2212	TIME_S70	R/W	Segment-70 segment time setting	
D8724	48724	2213	TIME_S71	R/W	Segment-71 segment time setting	
D8725	48725	2214	TIME_S72	R/W	Segment-72 segment time setting	
D8726	48726	2215	TIME_S73	R/W	Segment-73 segment time setting	
D8727	48727	2216	TIME_S74	R/W	Segment-74 segment time setting	
D8728	48728	2217	TIME_S75	R/W	Segment-75 segment time setting	
D8729	48729	2218	TIME_S76	R/W	Segment-76 segment time setting	
D8730	48730	2219	TIME_S77	R/W	Segment-77 segment time setting	
D8731	48731	221A	TIME_S78	R/W	Segment-78 segment time setting	
D8732	48732	221B	TIME_S79	R/W	Segment-79 segment time setting	
D8733	48733	221C	TIME_S80	R/W	Segment-80 segment time setting	
D8734	48734	221D	TIME_S81	R/W	Segment-81 segment time setting	
D8735	48735	221E	TIME_S82	R/W	Segment-82 segment time setting	
D8736	48736	221F	TIME_S83	R/W	Segment-83 segment time setting	
D8737	48737	2220	TIME_S84	R/W	Segment-84 segment time setting	
D8738	48738	2221	TIME_S85	R/W	Segment-85 segment time setting	
D8739	48739	2222	TIME_S86	R/W	Segment-86 segment time setting	
D8740	48740	2223	TIME_S87	R/W	Segment-87 segment time setting	
D8741	48741	2224	TIME_S88	R/W	Segment-88 segment time setting	
D8742	48742	2225	TIME_S89	R/W	Segment-89 segment time setting	
D8743	48743	2226	TIME_S90	R/W	Segment-90 segment time setting	
D8744	48744	2227	TIME_S91	R/W	Segment-91 segment time setting	
D8745	48745	2228	TIME_S92	R/W	Segment-92 segment time setting	
D8746	48746	2229	TIME_S93	R/W	Segment-93 segment time setting	
D8747	48747	222A	TIME_S94	R/W	Segment-94 segment time setting	
D8748	48748	222B	TIME_S95	R/W	Segment-95 segment time setting	
D8749	48749	222C	TIME_S96	R/W	Segment-96 segment time setting	
D8750	48750	222D	TIME_S97	R/W	Segment-97 segment time setting	
D8751	48751	222E	TIME_S98	R/W	Segment-98 segment time setting	
D8752	48752	222F	TIME_S99	R/W	Segment-99 segment time setting	
D8753	48753	2230	PTN.ERR	R	Read/write error information	0: normal end Except 0: error (See "Error information" described later in this chapter.)
D8754 to D8800						

6.4 UT55A/UT52A/UP55A D Registers

Segment Ramp-Rate Setting for Batch Writing (D8801 to D9000)

Register No.	Ref. No.	H No.	Register symbol	R/W	Description	Range and meaning of value
D8801	48801	2260	PTNO_C	R/W	Program pattern number selection	0: Not select program pattern 1 to 30
D8802	48802	2261				
D8803	48803	2262				
D8804	48804	2263	TM.RT_S1	R/W	Segment-1 segment ramp-rate setting	Unregistered (65535) Ramp: 0.0 to 100.0% of PV input range span (EUS) / 1 hour or 1 minute Soak: 0 to 59999 (minute or second) * Setting available for the parameter SEG. T=RAMP. * Use the parameter TMU to set the time unit. (Common in the instrument.) Per 1 hour: TMU=HH.MM, Per 1 minute: TMU=MM.SS * If it is set to 0.0% of the input range span, or the segment time 0.00, the program moves to the next segment after one control period.
D8805	48805	2264	TM.RT_S2	R/W	Segment-2 segment ramp-rate setting	
D8806	48806	2265	TM.RT_S3	R/W	Segment-3 segment ramp-rate setting	
D8807	48807	2266	TM.RT_S4	R/W	Segment-4 segment ramp-rate setting	
D8808	48808	2267	TM.RT_S5	R/W	Segment-5 segment ramp-rate setting	
D8809	48809	2268	TM.RT_S6	R/W	Segment-6 segment ramp-rate setting	
D8810	48810	2269	TM.RT_S7	R/W	Segment-7 segment ramp-rate setting	
D8811	48811	226A	TM.RT_S8	R/W	Segment-8 segment ramp-rate setting	
D8812	48812	226B	TM.RT_S9	R/W	Segment-9 segment ramp-rate setting	
D8813	48813	226C	TM.RT_S10	R/W	Segment-10 segment ramp-rate setting	
D8814	48814	226D	TM.RT_S11	R/W	Segment-11 segment ramp-rate setting	
D8815	48815	226E	TM.RT_S12	R/W	Segment-12 segment ramp-rate setting	
D8816	48816	226F	TM.RT_S13	R/W	Segment-13 segment ramp-rate setting	
D8817	48817	2270	TM.RT_S14	R/W	Segment-14 segment ramp-rate setting	
D8818	48818	2271	TM.RT_S15	R/W	Segment-15 segment ramp-rate setting	
D8819	48819	2272	TM.RT_S16	R/W	Segment-16 segment ramp-rate setting	
D8820	48820	2273	TM.RT_S17	R/W	Segment-17 segment ramp-rate setting	
D8821	48821	2274	TM.RT_S18	R/W	Segment-18 segment ramp-rate setting	
D8822	48822	2275	TM.RT_S19	R/W	Segment-19 segment ramp-rate setting	
D8823	48823	2276	TM.RT_S20	R/W	Segment-20 segment ramp-rate setting	
D8824	48824	2277	TM.RT_S21	R/W	Segment-21 segment ramp-rate setting	
D8825	48825	2278	TM.RT_S22	R/W	Segment-22 segment ramp-rate setting	
D8826	48826	2279	TM.RT_S23	R/W	Segment-23 segment ramp-rate setting	
D8827	48827	227A	TM.RT_S24	R/W	Segment-24 segment ramp-rate setting	
D8828	48828	227B	TM.RT_S25	R/W	Segment-25 segment ramp-rate setting	
D8829	48829	227C	TM.RT_S26	R/W	Segment-26 segment ramp-rate setting	
D8830	48830	227D	TM.RT_S27	R/W	Segment-27 segment ramp-rate setting	
D8831	48831	227E	TM.RT_S28	R/W	Segment-28 segment ramp-rate setting	
D8832	48832	227F	TM.RT_S29	R/W	Segment-29 segment ramp-rate setting	
D8833	48833	2280	TM.RT_S30	R/W	Segment-30 segment ramp-rate setting	
D8834	48834	2281	TM.RT_S31	R/W	Segment-31 segment ramp-rate setting	
D8835	48835	2282	TM.RT_S32	R/W	Segment-32 segment ramp-rate setting	
D8836	48836	2283	TM.RT_S33	R/W	Segment-33 segment ramp-rate setting	
D8837	48837	2284	TM.RT_S34	R/W	Segment-34 segment ramp-rate setting	
D8838	48838	2285	TM.RT_S35	R/W	Segment-35 segment ramp-rate setting	
D8839	48839	2286	TM.RT_S36	R/W	Segment-36 segment ramp-rate setting	
D8840	48840	2287	TM.RT_S37	R/W	Segment-37 segment ramp-rate setting	
D8841	48841	2288	TM.RT_S38	R/W	Segment-38 segment ramp-rate setting	
D8842	48842	2289	TM.RT_S39	R/W	Segment-39 segment ramp-rate setting	
D8843	48843	228A	TM.RT_S40	R/W	Segment-40 segment ramp-rate setting	
D8844	48844	228B	TM.RT_S41	R/W	Segment-41 segment ramp-rate setting	
D8845	48845	228C	TM.RT_S42	R/W	Segment-42 segment ramp-rate setting	
D8846	48846	228D	TM.RT_S43	R/W	Segment-43 segment ramp-rate setting	
D8847	48847	228E	TM.RT_S44	R/W	Segment-44 segment ramp-rate setting	
D8848	48848	228F	TM.RT_S45	R/W	Segment-45 segment ramp-rate setting	
D8849	48849	2290	TM.RT_S46	R/W	Segment-46 segment ramp-rate setting	
D8850	48850	2291	TM.RT_S47	R/W	Segment-47 segment ramp-rate setting	
D8851	48851	2292	TM.RT_S48	R/W	Segment-48 segment ramp-rate setting	
D8852	48852	2293	TM.RT_S49	R/W	Segment-49 segment ramp-rate setting	
D8853	48853	2294	PTN.ERR	R	Read/write error information	0: normal end Except 0: error (See "Error information" described later in this chapter.)
D8854 to D8900						

6.4 UT55A/UT52A/UP55A D Registers

Register No.	Ref. No.	H No.	Register symbol	R/W	Description	Range and meaning of value
D8901	48901	22C4	PTNO._C	R/W	Program pattern number selection	0: Not select program pattern 1 to 30
D8902	48902	22C5				
D8903	48903	22C6	TM.RT_S50	R/W	Segment-50 segment ramp-rate setting	
D8904	48904	22C7	TM.RT_S51	R/W	Segment-51 segment ramp-rate setting	
D8905	48905	22C8	TM.RT_S52	R/W	Segment-52 segment ramp-rate setting	
D8906	48906	22C9	TM.RT_S53	R/W	Segment-53 segment ramp-rate setting	
D8907	48907	22CA	TM.RT_S54	R/W	Segment-54 segment ramp-rate setting	
D8908	48908	22CB	TM.RT_S55	R/W	Segment-55 segment ramp-rate setting	
D8909	48909	22CC	TM.RT_S56	R/W	Segment-56 segment ramp-rate setting	
D8910	48910	22CD	TM.RT_S57	R/W	Segment-57 segment ramp-rate setting	
D8911	48911	22CE	TM.RT_S58	R/W	Segment-58 segment ramp-rate setting	
D8912	48912	22CF	TM.RT_S59	R/W	Segment-59 segment ramp-rate setting	
D8913	48913	22D0	TM.RT_S60	R/W	Segment-60 segment ramp-rate setting	
D8914	48914	22D1	TM.RT_S61	R/W	Segment-61 segment ramp-rate setting	
D8915	48915	22D2	TM.RT_S62	R/W	Segment-62 segment ramp-rate setting	
D8916	48916	22D3	TM.RT_S63	R/W	Segment-63 segment ramp-rate setting	
D8917	48917	22D4	TM.RT_S64	R/W	Segment-64 segment ramp-rate setting	
D8918	48918	22D5	TM.RT_S65	R/W	Segment-65 segment ramp-rate setting	
D8919	48919	22D6	TM.RT_S66	R/W	Segment-66 segment ramp-rate setting	
D8920	48920	22D7	TM.RT_S67	R/W	Segment-67 segment ramp-rate setting	
D8921	48921	22D8	TM.RT_S68	R/W	Segment-68 segment ramp-rate setting	Unregistered (65535)
D8922	48922	22D9	TM.RT_S69	R/W	Segment-69 segment ramp-rate setting	Ramp: 0.0 to 100.0% of PV input range span (EUS) / 1 hour or 1 minute Soak: 0 to 59999 (minute or second)
D8923	48923	22DA	TM.RT_S70	R/W	Segment-70 segment ramp-rate setting	
D8924	48924	22DB	TM.RT_S71	R/W	Segment-71 segment ramp-rate setting	
D8925	48925	22DC	TM.RT_S72	R/W	Segment-72 segment ramp-rate setting	* Setting available for the parameter SEG. T=RAMP.
D8926	48926	22DD	TM.RT_S73	R/W	Segment-73 segment ramp-rate setting	
D8927	48927	22DE	TM.RT_S74	R/W	Segment-74 segment ramp-rate setting	* Use the parameter TMU to set the time unit. (Common in the instrument.)
D8928	48928	22DF	TM.RT_S75	R/W	Segment-75 segment ramp-rate setting	Per 1 hour: TMU=HH.MM, Per 1 minute: TMU=MM.SS
D8929	48929	22E0	TM.RT_S76	R/W	Segment-76 segment ramp-rate setting	
D8930	48930	22E1	TM.RT_S77	R/W	Segment-77 segment ramp-rate setting	* If it is set to 0.0% of the input range span, or the segment time 0.00, the program moves to the next segment after one control period.
D8931	48931	22E2	TM.RT_S78	R/W	Segment-78 segment ramp-rate setting	
D8932	48932	22E3	TM.RT_S79	R/W	Segment-79 segment ramp-rate setting	
D8933	48933	22E4	TM.RT_S80	R/W	Segment-80 segment ramp-rate setting	
D8934	48934	22E5	TM.RT_S81	R/W	Segment-81 segment ramp-rate setting	
D8935	48935	22E6	TM.RT_S82	R/W	Segment-82 segment ramp-rate setting	
D8936	48936	22E7	TM.RT_S83	R/W	Segment-83 segment ramp-rate setting	
D8937	48937	22E8	TM.RT_S84	R/W	Segment-84 segment ramp-rate setting	
D8938	48938	22E9	TM.RT_S85	R/W	Segment-85 segment ramp-rate setting	
D8939	48939	22EA	TM.RT_S86	R/W	Segment-86 segment ramp-rate setting	
D8940	48940	22EB	TM.RT_S87	R/W	Segment-87 segment ramp-rate setting	
D8941	48941	22EC	TM.RT_S88	R/W	Segment-88 segment ramp-rate setting	
D8942	48942	22ED	TM.RT_S89	R/W	Segment-89 segment ramp-rate setting	
D8943	48943	22EE	TM.RT_S90	R/W	Segment-90 segment ramp-rate setting	
D8944	48944	22EF	TM.RT_S91	R/W	Segment-91 segment ramp-rate setting	
D8945	48945	22F0	TM.RT_S92	R/W	Segment-92 segment ramp-rate setting	
D8946	48946	22F1	TM.RT_S93	R/W	Segment-93 segment ramp-rate setting	
D8947	48947	22F2	TM.RT_S94	R/W	Segment-94 segment ramp-rate setting	
D8948	48948	22F3	TM.RT_S95	R/W	Segment-95 segment ramp-rate setting	
D8949	48949	22F4	TM.RT_S96	R/W	Segment-96 segment ramp-rate setting	
D8950	48950	22F5	TM.RT_S97	R/W	Segment-97 segment ramp-rate setting	
D8951	48951	22F6	TM.RT_S98	R/W	Segment-98 segment ramp-rate setting	
D8952	48952	22F7	TM.RT_S99	R/W	Segment-99 segment ramp-rate setting	
D8953	48953	22F8	PTN.ERR	R	Read/write error information	0: normal end Except 0: error (See "Error information" described later in this chapter.)
D8954 to D8970						

Reading Data (Multiple Segment Data) (D8201 to D8953)

■ Modbus communication

The example for the communication command is Modbus/RTU. For easy understanding, space is added but it is not present in the actual command. The device address is "1."

Example: Batch reading SSP_L1 and target setpoints in segments 1 to 5 (TSP_L1_S1 to TSP_L1_S5) for pattern 3

- (1) Write pattern number "3" to D8201 (PTNO._C).
- (2) Read from 6 registers continuously: D8203 (SSP_L1) and D8204 (TSP_L1_S1) to D8208 (TSP_L1_S5).
- (3) Read from D8253 (PTN.ERR).

If the result is other than zero, an error occurred. If zero, the read was successful.

- (1) 01 10 2008 0001 02 0003 [CRC]
- (2) 01 03 200A 0006 [CRC]
- (3) 01 03 203C 0001 [CRC]

Example: Batch reading SSP_L1 and target setpoints in segments 1 to 49 (TSP_L1_S1 to TSP_L1_S49) for pattern 3

- (1) Write pattern number "3" to D8201 (PTNO._C).
- (2) Read from 51 registers continuously: D8204 (TSP_L1_S1) to D8252 (TSP_L1_S49) and D8253 (PTN.ERR).

If reading PTN.ERR results in other than zero, an error occurred. If zero, the read was successful.

- (1) 01 10 2008 0001 02 0003 [CRC]
- (2) 01 03 200A 0033 [CRC]

■ PC link communication

The example for the communication command is a PC link without a checksum. The device address is "1."

Example: Batch reading SSP_L1 and target setpoints in segments 1 to 5 (TSP_L1_S1 to TSP_L1_S5) for pattern 3

- (1) Write pattern number "3" to D8201 (PTNO._C).
- (2) Read from 6 registers continuously: D8203 (SSP_L1) and D8204 (TSP_L1_S1) to D8208 (TSP_L1_S5).
- (3) Read from D8253 (PTN.ERR).

If the result is other than zero, an error occurred. If zero, the read was successful.

- (1) 01010WWRD8201,01,0003
- (2) 01010WRDD8203,06
- (3) 01010WRDD8253,01

Example: Batch reading SSP_L1 and target setpoints in segments 1 to 49 (TSP_L1_S1 to TSP_L1_S49) for pattern 3

- (1) Write pattern number "3" to D8201 (PTNO._C).
- (2) Read from 51 registers continuously: D8203 (SSP_L1), D8204 (TSP_L1_S1) to D8252 (TSP_L1_S49) and D8253 (PTN.ERR).

If reading PTN.ERR results in other than zero, an error occurred. If zero, the read was successful.

- (1) 01010WWRD8201,01,0003
- (2) 01010WRDD8203,51

Writing Data (Multiple Segment Data) (D8201 to D8953)**■ Modbus communication**

The example for the communication command is Modbus/RTU. For easy understanding, space is added but it is not present in the actual command. The device address is "1."

Example: Batch writing SSP_L1 and target setpoints in segments 1 to 5 (TSP_L1_S1 to TSP_L1_S5) for pattern 3

- (1) Write to 52 registers continuously: pattern number "3" to D8201 (PTNO._C), "0" to D8202 (unused), D8203 (SSP_L1), and D8204 (TSP_L1_S1) to D8252 (TSP_L1_S49).

If "PTN.ERR" in the response is other than zero, an error occurred. If zero, the write was successful.

(1) 01 01 46 2008 0034 68 0003 0000 **03 ... **51 **52 [CRC]

■ PC link communication

The example for the communication command is a PC link without a checksum. The device address is "1."

Example: Batch writing SSP_L1 and target setpoints in segments 1 to 5 (TSP_L1_S1 to TSP_L1_S5) for pattern 3

- (1) Write to 52 registers continuously: pattern number "3" to D8201 (PTNO._C), "0" to D8202 (unused), D8203 (SSP_L1), and D8204 (TSP_L1_S1) to D8252 (TSP_L1_S49).

- (2) Read from D8253 (PTN.ERR).

If the result is other than zero, an error occurred. If zero, the read was successful.

(1) 01010WWRD8201,52,0003 0000 **03 **04 ... **51 **52

(2) 01010WRDD8253,01

6.4 UT55A/UT52A/UP55A D Registers

Used Pattern Numbers and the Number of Remaining Unused Segments (D8961 to D8963)

Register No.	Ref. No.	H No.	Register symbol	R/W	Description	Range and meaning of value
D8961	48961	2300	PTN_USE1	R/W	Used program pattern numbers (Patterns 1 to 16)	See below
D8962	48962	2301	PTN_USE2	R/W	Used program pattern numbers (Patterns 17 to 30)	See below
D8963	48963	2302	ALL.S	R/W	Number of remaining unused segments	0 to 300
D8964 to 8970						

● Bit Configuration of D8961: PTN_USE1 (Used program pattern numbers (Patterns 1 to 16))

Bit	Symbol	Event
0	PT1_USE	Used pattern 1
1	PT2_USE	Used pattern 2
2	PT3_USE	Used pattern 3
3	PT4_USE	Used pattern 4
4	PT5_USE	Used pattern 5
5	PT6_USE	Used pattern 6
6	PT7_USE	Used pattern 7
7	PT8_USE	Used pattern 8
8	PT9_USE	Used pattern 9
9	PT10_USE	Used pattern 10
10	PT11_USE	Used pattern 11
11	PT12_USE	Used pattern 12
12	PT13_USE	Used pattern 13
13	PT14_USE	Used pattern 14
14	PT15_USE	Used pattern 15
15	PT16_USE	Used pattern 16

● Bit Configuration of D8962: PTN_USE2 (Used program pattern numbers (Patterns 17 to 30))

Bit	Symbol	Event
0	PT17_USE	Used pattern 17
1	PT18_USE	Used pattern 18
2	PT19_USE	Used pattern 19
3	PT20_USE	Used pattern 20
4	PT21_USE	Used pattern 21
5	PT22_USE	Used pattern 22
6	PT23_USE	Used pattern 23
7	PT24_USE	Used pattern 24
8	PT25_USE	Used pattern 25
9	PT26_USE	Used pattern 26
10	PT27_USE	Used pattern 27
11	PT28_USE	Used pattern 28
12	PT29_USE	Used pattern 29
13	PT30_USE	Used pattern 30
14	-	Unused
15	-	Unused

Check the Number of Segments, Copy and Clear of Program Pattern (D8971 to D8993)

Register No.	Ref. No.	H No.	Register symbol	R/W	Description	Range and meaning of value
D8971	48971	230A	PTN.S	R/W	Pattern number designation for confirming number of segments	0: not select program pattern 1 to 30
D8972	48972	230B	USE.S	R	Number of segments within a pattern	The number of the segment is displayed when the program pattern number is specified in the parameter PTN.S. 0: Not registered 1 to 99
D8974 to D8980						
D8981	2315	2314	CPY.S	R/W	Source-of-copying pattern number designation	Set the source-of-copying pattern number designation. 1 to 30
D8982	2316	2315	CPY.D	R/W	Target-of-copying pattern number designation	Set the target-of-copying pattern number designation. 1 to 30
D8983	2317	2316	PTC.TRG	R/W	Copy trigger	1: copy
D8984	2318	2317	PTN.ERR	R	Read/write error information	0: normal end Except 0: error (See "Error information" described later in this chapter.)
D8985 to D8990						
D8991	48991	231E	CLR.P	R/W	Program pattern clearance	Set the number of program pattern erase. 1 to 30
D8992	48992	231F	CLR.TRG	R/W	Clearance trigger	1: clear
D8993	48993	2320	PTN.ERR	R	Read/write error information	0: normal end Except 0: error (See "Error information" described later in this chapter.)
D8994 to D9000						

■ Modbus communication

The example for the communication command is Modbus/RTU. For easy understanding, space is added but it is not present in the actual command. The device address is "1."

● How to check the number of segments used in one pattern

Example: Checking segment numbers used in pattern 3

- Write pattern number "3" to D8971 (PTN.S).
- Read from D8972 (USE.S).

(1) 01 10 230A 0001 02 0003 [CRC]

(2) 01 03 230B 0001 [CRC]

● How to copy pattern

Example: Copying patterns 1 to 2

- Write "1" to D8981 (CPY.S: Source-of-copying pattern number designation), "2" to D8982 (CPY.D: Target-of-copying pattern number designation), and "1" to D8983 (PTC.TRG: Copy trigger).

If "PTN.ERR" in the response is other than zero, an error occurred. If zero, the write was successful.

(1) 01 46 2314 0003 06 0001 0002 0001 [CRC]

● How to clear pattern

Example: Clearing pattern 2

- Write "2" to D8911 (CLR.P: Program pattern clearance) and "1" to D8992 (CLR.TRG: Clearance trigger).

If "PTN.ERR" in the response is other than zero, an error occurred. If zero, the write was successful.

(1) 01 46 231E 0002 04 0002 0001 [CRC]

■ PC link communication

The example for the communication command is a PC link without a checksum. The device address is "1."

● How to check the number of segments used in one pattern

Example: Checking segment numbers used in pattern 3

- (1) Write pattern number "3" to D8971 (PTN.S).
- (2) Read from D8972 (USE.S).

(1) 01010WWRD8971,01,0003
(2) 01010WRDD8972,01

● How to copy pattern

Example: Copying patterns 1 to 2

- (1) Write "1" to D8981 (COY.S: Source-of-copying pattern number designation), "2" to D8982 (COY.D: Target-of-copying pattern number designation), and "1" to D8983 (PTC.TRG: Copy trigger).
- (2) Read from D8984 (PTN.ERR).

If the result is other than zero, an error occurred. If zero, the read was successful.

(1) 01010WWRD8981,03,0001 0002 0001
(2) 01010WRDD8984,01

● How to clear pattern

Example: Clearing pattern 2

- (1) Write "2" to D8911 (CLR.P: Program pattern clearance) and "1" to D8992 (CLR.TRG: Clearance trigger).
If "PTN.ERR" in the response is other than zero, an error occurred. If zero, the write was successful.
- (2) Read from D8993 (PTN.ERR).

If the result is other than zero, an error occurred. If zero, the read was successful.

(1) 01010WWRD8991,02,0002 0001
(2) 01010WRDD8993,01

Error Information

The following table shows the Error Information for the register symbol "PTN.ERR".

Error code	Meaning	Cause
0	No error	Normal end
1	Pattern creation or editing is disabled during program operation.	Deleting or copying of the program pattern, or inserting or deleting of the segment was executed during program operation.
2	Segment number error	The specified program pattern number does not exist. Pattern number range: 1 to 30
3	Segment number error	The specified segment number does not exist. Segment number range: 1 to 99
22	Segment write error	The number of segments exceeded 300.
31	Pattern copy error	The program pattern does not exist at the copy source, or at the copy destination.
41	Pattern delete error	The pattern to be deleted does not exist.

6.5 Writing via Communication

■ Setting Target Setpoint

In LCL (local) mode

- (1) Set the Loop-1 and Loop-2 target setpoints of groups 1 to 8 parameters (SP_L1_1 to SP_L1_8 or SP_L2_1 to SP_L2_8).
- (2) Write the setpoint (1 to 8) in the SPNO. (SP number selection) (depends on the setup parameter SPGR. setting)
- (3) Set the operation mode (R.L_L1, R.L_L2) to LCL (local) (0).

Register No.	Register symbol	Description
D2312	SPNO.	SP number selection

In REM (remote) mode

- (1) The target setpoint can be written via communication only when the operation mode (R.L_L1, R.L_L2) is set to REM (remote) mode.
- (2) Write the setpoint in the C.RSP_L1 or C.RSP_L2.
Example: When setting 150.0°C for the C.RSP_L1, write "1500" to this register.
- (3) Set the operation mode (R.L_L1, R.L_L2) to the REM (remote) mode.

Register No.	Register symbol	Description
D2331	C.RSP_L1	Loop-1 communication remote setpoint
D2332	C.RSP_L2	Loop-2 communication remote setpoint

■ Setting Control Output Value in MAN Mode

The control output value can be written via communication only when the operation mode is set to MAN mode.

- (1) Set the operation mode (A.M) to MAN (1).
- (2) Write the control output value in the MOUT_L1, MOUT_L2, MOUTc_L1, or MOUTc_L2.

Register No.	Register symbol	Description
D2333	MOUT_L1	Loop-1 heating-side control output in MAN mode
D2334	MOUTc_L1	Loop-1 cooling-side control output in MAN mode
D2335	MOUT_L2	Loop-2 heating-side control output in MAN mode
D2336	MOUTc_L2	Loop-2 cooling-side control output in MAN mode

■ Setting Manual Preset Output Number

The manual preset output number can be written via communication only when the operation mode is set to MAN mode.

- (1) Set the Loop-1 and Loop-2 manual preset output 1 to 5 parameters (MPO1_L1 to MPO5_L1 or MPO1_L2 to MPO5_L2).
- (2) Write the setpoint (1 to 5) in the MPON_L1 or MPON_L2.
- (3) Set the operation mode (A.M) to MAN (1).

Register No.	Register symbol	Description
D3531	MPON_L1	Loop-1 manual preset output number selection
D4631	MPON_L2	Loop-2 manual preset output number selection

■ Operating a Valve (for Position proportional type only)

Write a valve position in MOUT_L1 in MAN mode for position proportional PID computation.

■ Setting PID Number (D2503: PIDN_L1_1 to D2643: PIDN_L1_8, D3603: PIDN_L2_1 to D3743: PIDN_L2_8)

PID number can be selected via communication only when the zone PID selection parameter (ZON) is set to 1, 2, or 4.

D2503 to D2643 = 1 to 8, D3603 to D3743 = 1 to 8 (depends on the setup parameter SPGR. setting).

When the PID number is selected using the external contact input, the setting via communication is impossible.

6.6 GREEN Series Compatible D Registers

6.6.1 Compatibility with GREEN Series Controllers

The D register map configuration of the UTAdvanced is the same as that of the GREEN Series (UT500 Series/UP550) controllers that perform access in the 2-byte integer data format.

When GREEN Series devices are replaced with the UTAdvanced, communication programs created in the GREEN Series controllers can be used by just carrying out wiring. If existing programs created in the GREEN Series controllers are used, communication is performed using the area from D0001 to D2000.

However, although the function allocation from D0001 to D1300 is the same as that of the GREEN Series (UT500 Series/UP550) controllers, the setting ranges and the function operation specifications of registers are subject to the specifications of the UTAdvanced. Furthermore, the functions have been enhanced from the GREEN Series controllers, so the generic settings and functions for some registers have been changed. For the changed registers, see “6.6.14 D Registers Differing in Content from GREEN Series.”

The register map after D2001 is a D register map allocated for the UTAdvanced.

When you want to newly perform communication, be sure to use the registers after D2001.

6.6.2 Interpretation of D Register Tables

Register map (Categories)					
Register contents					
D-Reg No.	Ref. No.	H No.	Register symbol for GREEN	Register symbol for UTAdvanced	R/W
D0001	40001	0000	ADERROR	AD1.E_G *1	R
D0002	40002	0001	ERROR.1	PV1.E_L1_G *1	R
D0003	40003	0002	PV.1	PV_L1 (D2003)	
⋮	⋮	⋮	⋮	⋮	⋮
D0033	40033	0020	DISTS	DI00 (D7601) *2	R
⋮	⋮	⋮	⋮	⋮	⋮
D0250	40250	00F9	ORB.1	 *3	R
⋮	⋮	⋮	⋮	⋮	⋮
D0310	40310	0135	1.OL	Depends on the conditions *4	R/W
⋮	⋮	⋮	⋮	⋮	⋮
D0915	40915	0392	AL1.1	AL1.T_L1 (D2801)	R/W

(1) D register numbers (2) Reference numbers (for Modbus communication) (3) Hexadecimal numbers (for Modbus communication)

Numbers in parentheses indicate the same register after D2001. Read/write by communication
R: Read enabled
W: Write enabled

■ Interpretation of Cell

*1: AD1.E_G (with _G) indicates a D register converted for the GREEN Series.

Furthermore, PV1.E_L1_G (shaded cell) indicates that it differs in content from that of the GREEN Series.

See “6.6.13 D Registers Converted for GREEN Series” described later.

*2: DI00 (D7601) (shaded cell) indicates that it differs in content from that of the GREEN Series. See “6.6.14 D Registers Differing in Content from GREEN Series” described later.

*3: A cell marked with a diagonal line (“

*4: Depends on the conditions indicates that the D register varies depending on the setting condition of other parameters.

See “6.6.15 D Registers Differing Depending on Condition” described later.

■ D register symbols

- With regards to some D register symbols, the loop number, terminal area, and group number are indicated by adding the underline () to the end of the parameter symbols.

If both the loop number and group number are added to the parameter symbols, they are added in the order of loop number and group number.

□□□□ **Ln**: Loop numbers (L1 or L2)

Y: Group numbers (1 to 8)

□□□□ **En**: Terminal area (E1 to E4)

Example : **SP_L1_3** Indicates Loop-1 SP of group 3.

A2_2 Indicates A2 of group 2.

UNI_E1 Indicates UNI in E1-terminal area.

- With regards to D register symbols from D0001 to D2000, the capital letter G with underline (G) is added to the end of the parameter symbols to indicate that the D register was converted for the GREEN Series.

D registers with G do not appear in the area for the UTAdvanced after D2001.

See "6.6.13 D Registers Converted for GREEN Series."

□□□□ **G** Example: AD1.E_G, PV1.E_L1_G, ALM_G

- Numbers in parentheses after the register symbols of the UTAdvanced indicate the same D register after D2001.

6.6 GREEN Series Compatible D Registers

6.6.3 Process Data and User Area (D0001 to D0100)

Configuration map for GREEN Series											
Process data						User area					
D-Reg No.	Ref. No.	H No.	Register symbol for GREEN	Register symbol for UTAdvanced	R/W	D-Reg No.	Ref. No.	H No.	Register symbol for GREEN	Register symbol for UTAdvanced	R/W
D0001	40001	0000	ADERROR	AD1.E_G	R	D0051	40051	0032	USER	USER1	R/W
D0002	40002	0001	ERROR.1	PV1.E_L1_G	R	D0052	40052	0033	USER	USER2	R/W
D0003	40003	0002	PV.1	PV_L1 (D2003)	R	D0053	40053	0034	USER	USER3	R/W
D0004	40004	0003	CSP.1	CSP_L1 (D2004)	R	D0054	40054	0035	USER	USER4	R/W
D0005	40005	0004	OUT.1	OUT_L1 (D2005)	R	D0055	40055	0036	USER	USER5	R/W
D0006	40006	0005	HOUT.1	H.OUT_L1 (D2006)	R	D0056	40056	0037	USER	USER6	R/W
D0007	40007	0006	COU.T.1	C.OUT_L1 (D2007)	R	D0057	40057	0038	USER	USER7	R/W
D0008	40008	0007	MOD.1	MOD_L1_G	R	D0058	40058	0039	USER	USER8	R/W
D0009	40009	0008	PIDNO.1	PID_L1 (D2009)	R	D0059	40059	003A	USER	USER9	R/W
D0010	40010	0009	CSPNO (Note 1)	CSPNO. (D2010)	R	D0060	40060	003B	USER	USER10	R/W
D0011	40011	000A	ALM	ALM_G	R	D0061	40061	003C	USER	USER11	R/W
D0012	40012	000B	PVEV (Note 2)	PV_EV (D2039)	R	D0062	40062	003D	USER	USER12	R/W
D0013	40013	000C	TMEV1 (Note 2)	TIME_EV_1 (D2040)	R	D0063	40063	003E	USER	USER13	R/W
D0014	40014	000D	TMEV2 (Note 2)	TIME_EV_2 (D2041)	R	D0064	40064	003F	USER	USER14	R/W
D0015	40015	000E	PTN (Note 2)	C.PTNO. (D2015)	R	D0065	40065	0040	USER	USER15	R/W
D0016	40016	000F	SEGNO (Note 2)	SEG.N (D2016)	R	D0066	40066	0041	USER	USER16	R/W
D0017	40017	0010	TIME (Note 2)	SEG_RUNTIME (D2017)	R	D0067	40067	0042	USER	USER17	R/W
D0018	40018	0011	ERROR.2	PV2.E_L2_G	R	D0068	40068	0043	USER	USER18	R/W
D0019	40019	0012	PV.2	PV_L2 (D2019)	R	D0069	40069	0044	USER	USER19	R/W
D0020	40020	0013	CSP.2	CSP_L2 (D2020)	R	D0070	40070	0045	USER	USER20	R/W
D0021	40021	0014	OUT.2	OUT_L2 (D2021)	R	D0071	40071	0046	USER	USER21	R/W
D0022	40022	0015	HOUT.2	H.OUT_L2 (D2022)	R	D0072	40072	0047	USER	USER22	R/W
D0023	40023	0016	COU.T.2	C.OUT_L2 (D2023)	R	D0073	40073	0048	USER	USER23	R/W
D0024	40024	0017	MOD.2	MOD_L2_G	R	D0074	40074	0049	USER	USER24	R/W
D0025	40025	0018	PIDNO.2	PIDN_L2 (D2025)	R	D0075	40075	004A	USER	USER25	R/W
D0026	40026	0019	DEV.1	DEV_L1 (D2035)	R	D0076	40076	004B	USER	USER26	R/W
D0027	40027	001A	OR.1 (Note 2)		R	D0077	40077	004C	USER	USER27	R/W
D0028	40028	001B				D0078	40078	004D	USER	USER28	R/W
D0029	40029	001C				D0079	40079	004E	USER	USER29	R/W
D0030	40030	001D	DEV.2	DEV_L2 (D2036)	R	D0080	40080	004F	USER	USER30	R/W
D0031	40031	001E	OR.2 (Note 2)		R	D0081	40081	0050	USER	USER31	R/W
D0032	40032	001F	SMEC (Note 2)		R	D0082	40082	0051	USER	USER32	R/W
D0033	40033	0020	DISTS	DI00 (D7601)	R	D0083	40083	0052	USER	USER33	R/W
D0034	40034	0021	RDISTS (Note 2)		R	D0084	40084	0053	USER	USER34	R/W
D0035	40035	0022	PARAERR	PA.ER_G	R	D0085	40085	0054	USER	USER35	R/W
D0036	40036	0023	ALOSTS	ALO_G	R	D0086	40086	0055	USER	USER36	R/W
D0037	40037	0024				D0087	40087	0056	USER	USER37	R/W
D0038	40038	0025				D0088	40088	0057	USER	USER38	R/W
D0039	40039	0026	DISP1 (Note 2)		R	D0089	40089	0058	USER	USER39	R/W
D0040	40040	0027	DISP2 (Note 2)		R	D0090	40090	0059	USER	USER40	R/W
D0041	40041	0028	TIME (Note 2)	SEG_RUNTIME (D2017)	R	D0091	40091	005A	USER	USER41	R/W
D0042	40042	0029	PTNO (Note 2)	C.PTNO. (D2015)	R	D0092	40092	005B	USER	USER42	R/W
D0043	40043	002A	SEGNO (Note 2)	SEGNO (D2016)	R	D0093	40093	005C	USER	USER43	R/W
D0044	40044	002B	SEGUSE (Note 2)	SEG_USE (D2044)	R	D0094	40094	005D	USER	USER44	R/W
D0045	40045	002C	REM.RCY (Note 2)	NOW_RCY (D2045)	R	D0095	40095	005E	USER	USER45	R/W
D0046	40046	002D	ALL.RCY (Note 2)	ALL_RCY (D2047)	R	D0096	40096	005F	USER	USER46	R/W
D0047	40047	002E	RST (Note 2)	RST (D2048)	R	D0097	40097	0060	USER	USER47	R/W
D0048	40048	002F	REN (Note 2)	REN (D2049)	R	D0098	40098	0061	USER	USER48	R/W
D0049	40049	0030	PVEOSTS (Note 2)	PV_EV_OUT (D2050)	R	D0099	40099	0062	USER	USER49	R/W
D0050	40050	0031	USER	USER0	R/W	D0100	40100	0063	USER	USER50	R/W

(Note 1): Not for UP550.

(Note 2): For UP550.

Configuration map for GREEN Series											
Program setting parameters											
Process data						User area					
D-Reg No.	Ref. No.	H No.	Register symbol for GREEN	Register symbol for UTAdvanced	R/W	D-Reg No.	Ref. No.	H No.	Register symbol for GREEN	Register symbol for UTAdvanced	R/W
D0101	40101	0064	LSP1 (Note)	LSP1_L1 (D2201)	R/W	D0151	40151	0096			
D0102	40102	0065	LSP2 (Note)	LSP2_L2 (D2202)	R/W	D0152	40152	0097			
D0103	40103	0066	PIDNO (Note)	L.PID (D2203)	R/W	D0153	40153	0098			
D0104	40104	0067	EV21A (Note)	L.TY1 (D2204)	R/W	D0154	40154	0099			
D0105	40105	0068	EV21B (Note)	L.EV1 (D2205)	R/W	D0155	40155	009A			
D0106	40106	0069	EV22A (Note)	L.TY2 (D2206)	R/W	D0156	40156	009B			
D0107	40107	006A	EV22B (Note)	L.EV2 (D2207)	R/W	D0157	40157	009C			
D0108	40108	006B	EV23A (Note)	L.TY3 (D2208)	R/W	D0158	40158	009D			
D0109	40109	006C	EV23B (Note)	L.EV3 (D2209)	R/W	D0159	40159	009E			
D0110	40110	006D	EV24A (Note)	L.TY4 (D2210)	R/W	D0160	40160	009F			
D0111	40111	006E	EV24B (Note)	L.EV4 (D2211)	R/W	D0161	40161	00A0			
D0112	40112	006F	EV25A (Note)	L.TY5 (D2212)	R/W	D0162	40162	00A1			
D0113	40113	0070	EV25B (Note)	L.EV5 (D2213)	R/W	D0163	40163	00A2			
D0114	40114	0071	EV26A (Note)	L.TY6 (D2214)	R/W	D0164	40164	00A3			
D0115	40115	0072	EV26B (Note)	L.EV6 (D2215)	R/W	D0165	40165	00A4			
D0116	40116	0073	EV27A (Note)	L.TY7 (D2216)	R/W	D0166	40166	00A5			
D0117	40117	0074	EV27B (Note)	L.EV7 (D2217)	R/W	D0167	40167	00A6			
D0118	40118	0075	EV28A (Note)	L.TY8 (D2218)	R/W	D0168	40168	00A7			
D0119	40119	0076	EV28B (Note)	L.EV8 (D2219)	R/W	D0169	40169	00A8			
D0120	40120	0077				D0170	40170	00A9			
D0121	40121	0078				D0171	40171	00AA			
D0122	40122	0079				D0172	40172	00AB			
D0123	40123	007A				D0173	40173	00AC			
D0124	40124	007B				D0174	40174	00AD			
D0125	40125	007C				D0175	40175	00AE			
D0126	40126	007D				D0176	40176	00AF			
D0127	40127	007E				D0177	40177	00B0			
D0128	40128	007F				D0178	40178	00B1			
D0129	40129	0080				D0179	40179	00B2			
D0130	40130	0081				D0180	40180	00B3			
D0131	40131	0082				D0181	40181	00B4			
D0132	40132	0083				D0182	40182	00B5			
D0133	40133	0084				D0183	40183	00B6			
D0134	40134	0085				D0184	40184	00B7			
D0135	40135	0086				D0185	40185	00B8			
D0136	40136	0087				D0186	40186	00B9			
D0137	40137	0088				D0187	40187	00BA			
D0138	40138	0089				D0188	40188	00BB			
D0139	40139	008A				D0189	40189	00BC			
D0140	40140	008B				D0190	40190	00BD			
D0141	40141	008C				D0191	40191	00BE			
D0142	40142	008D				D0192	40192	00BF			
D0143	40143	008E				D0193	40193	00C0			
D0144	40144	008F				D0194	40194	00C1			
D0145	40145	0090				D0195	40195	00C2			
D0146	40146	0091				D0196	40196	00C3			
D0147	40147	0092				D0197	40197	00C4			
D0148	40148	0093				D0198	40198	00C5			
D0149	40149	0094				D0199	40199	00C6			
D0150	40150	0095				D0200	40200	00C7			

(Note): For UP550.

6.6 GREEN Series Compatible D Registers

6.6.4 Operation Mode and Operation-related Parameters (D0201 to D0300)

Configuration map for GREEN Series											
Operation mode / Operation-related parameters											
D-Reg No.	Ref. No.	H No.	Register symbol for GREEN	Register symbol for UTAdvanced	R/W	D-Reg No.	Ref. No.	H No.	Register symbol for GREEN	Register symbol for UTAdvanced	R/W
D0201	40201	00C8	A/M1 (Note 1)	A.M (D2301)	R/W	D0251	40251	00FA	ORH.1		R
D0202	40202	00C9				D0252	40252	00FB	ORL.1		R
D0203	40203	00CA	R/L1 (Note 1)	R.L_L1 (D2306)	R/W	D0253	40253	00FC	S.TM (Note 2)	S.TM (D2712)	R
D0204	40204	00CB			R/W	D0254	40254	00FD			
D0205	40205	00CC	S/R (Note 1)	S.R (D2304)	R/W	D0255	40255	00FE			
D0206	40206	00CD	C.A.M (Note 1)	C.A.M (D2303)	R/W	D0256	40256	00FF			
D0207	40207	00CE	SPN (Note 1)	SPNO. (D2312)	R/W	D0257	40257	0100			
D0208	40208	00CF	R/P/L (Note 2)	MODE (D2316)	R/W	D0258	40258	0101			
D0209	40209	00D0	HOLD (Note 2)	HOLD (D2317)	R/W	D0259	40259	0102			
D0210	40210	00D1	ADV (Note 2)	ADV (D2318)	R/W	D0260	40260	0103			
D0211	40211	00D2	A/M.1 (Note 2)	A.M_L1 (D2319)	R/W	D0261	40261	0104			
D0212	40212	00D3	A/M.2 (Note 2)	A.M_L2 (D2320)	R/W	D0262	40262	0105	PCH.1 (Note 1)	PCH_L1 (D5714)	R/W
D0213	40213	00D4	LSP/CAS (Note 2)	L.C (D2321)	R/W	D0263	40263	0106	PCL.1 (Note 1)	PCL_L1 (D5715)	R/W
D0214	40214	00D5	PTNO (Note 2)	PTNO. (D2322)	R/W	D0264	40264	0107			
D0215	40215	00D6	C.RSP.1 (Note 1)	C.RSP_L1 (D2331)	R/W	D0265	40265	0108			
D0216	40216	00D7				D0266	40266	0109			
D0217	40217	00D8	MOUT.1	MOUT_L1 (D2333)	R/W	D0267	40267	010A			
D0218	40218	00D9	MOUTc.1	MOUTc_L1 (D2334)	R/W	D0268	40268	010B			
D0219	40219	00DA	MOUT.2	MOUT_L2 (D2335)	R/W	D0269	40269	010C			
D0220	40220	00DB	MOUTc.2	MOUTc_L2 (D2336)	R/W	D0270	40270	010D			
D0221	40221	00DC	HOLDSP.1 (Note 2)	H.SP_L1 (D2337)	R/W	D0271	40271	010E	AT.2	AT_L2 (D2309)	R/W
D0222	40222	00DD	HOLDSP.2 (Note 2)	H.SP_L2 (D2338)	R/W	D0272	40272	010F	SC.2	SC_L2 (D4601)	R/W
D0223	40223	00DE	HOLDTM (Note 2)	H.TM (D2341)	R/W	D0273	40273	0110	BS.2	BS_L2 (D4001)	R/W
D0224	40224	00DF	SST (Note 2)	SST (D2342)	R/W	D0274	40274	0111	FL.2	FL_L2 (D4002)	R/W
D0225	40225	00E0	PNO (Note 1)	PID_G	R/W	D0275	40275	0112	UPR.2 (Note 1)	UPR_L2 (D3805)	R/W
D0226	40226	00E1				D0276	40276	0113	DNR.2 (Note 1)	DNR_L2 (D3806)	R/W
D0227	40227	00E2				D0277	40277	0114	RT.2 (Note 1)	RT_L2 (D3803)	R/W
D0228	40228	00E3				D0278	40278	0115	RBS.2 (Note 1)	RBS_L2 (D3804)	R/W
D0229	40229	00E4				D0279	40279	0116	RFL.2 (Note 1)	RFL_L2 (D3802)	R/W
D0230	40230	00E5				D0280	40280	0117	ORB.2		R
D0231	40231	00E6	A1 (Note 3)	A1_G	R/W	D0281	40281	0118	ORH.2		R
D0232	40232	00E7	A2 (Note 3)	A2_G	R/W	D0282	40282	0119	ORL.2		R
D0233	40233	00E8	A3 (Note 3)	A3_G	R/W	D0283	40283	011A			
D0234	40234	00E9	A4 (Note 3)	A4_G	R/W	D0284	40284	011B			
D0235	40235	00EA				D0285	40285	011C			
D0236	40236	00EB				D0286	40286	011D			
D0237	40237	00EC				D0287	40287	011E			
D0238	40238	00ED				D0288	40288	011F			
D0239	40239	00EE				D0289	40289	0120			
D0240	40240	00EF				D0290	40290	0121			
D0241	40241	00F0	AT.1	AT_L1 (D2308)	R/W	D0291	40291	0122			
D0242	40242	00F1	SC.1	SC_L1 (D3501)	R/W	D0292	40292	0123	PCH.2 (Note 1)	PCH_L2 (D5717)	R/W
D0243	40243	00F2	BS.1	BS_L1 (D2901)	R/W	D0293	40293	0124	PCL.2 (Note 1)	PCL_L2 (D5718)	R/W
D0244	40244	00F3	FL.1	FL_L1 (D2902)	R/W	D0294	40294	0125			
D0245	40245	00F4	UPR.1 (Note 1)	UPR_L1 (D2705)	R/W	D0295	40295	0126			
D0246	40246	00F5	DNR.1 (Note 1)	DNR_L1 (D2706)	R/W	D0296	40296	0127			
D0247	40247	00F6	RT.1 (Note 1)	RT_L1 (D2703)	R/W	D0297	40297	0128			
D0248	40248	00F7	RBS.1 (Note 1)	RBS_L1 (D2704)	R/W	D0298	40298	0129			
D0249	40249	00F8	RFL.1 (Note 1)	RFL_L1 (D2702)	R/W	D0299	40299	012A			
D0250	40250	00F9	ORB.1		R	D0300	40300	012B			

(Note 1): Not for UP550.

(Note 2): For UP550.

(Note 3): For UT400 Series, UP550. Note that for the UP550, the register symbols for UTAdvanced are "A1_L1 (D2351)," "A2_L1 (D2352)," "A3_L1 (D2353)," and "A4_L1 (D2354)."

6.6.5 Loop-1 PID Parameters (D0301 to D0500)

Configuration map for GREEN Series											
Loop-1 SP / AL / PID parameters											
D-Reg No.	Ref. No.	H No.	Register symbol for GREEN	Register symbol for UTAdvanced	R/W	D-Reg No.	Ref. No.	H No.	Register symbol for GREEN	Register symbol for UTAdvanced	R/W
D0301	40301	012C	1.SP (Note 1)	SP_L1_1 (D2501)	R/W	D0351	40351	015E	3.SP (Note 1)	SP_L1_3 (D2541)	R/W
D0302	40302	012D	1.A1 (Note 1)	A1_L1_1 (D2504)	R/W	D0352	40352	015F	3.A1 (Note 1)	A1_L1_3 (D2544)	R/W
D0303	40303	012E	1.A2 (Note 1)	A2_L1_1 (D2505)	R/W	D0353	40353	0160	3.A2 (Note 1)	A2_L1_3 (D2545)	R/W
D0304	40304	012F	1.A3 (Note 1)	A3_L1_1 (D2506)	R/W	D0354	40354	0161	3.A3 (Note 1)	A3_L1_3 (D2546)	R/W
D0305	40305	0130	1.A4 (Note 1)	A4_L1_1 (D2507)	R/W	D0355	40355	0162	3.A4 (Note 1)	A4_L1_3 (D2547)	R/W
D0306	40306	0131	1.P	P_L1_1 (D3001)	R/W	D0356	40356	0163	3.P	P_L1_3 (D3101)	R/W
D0307	40307	0132	1.I	I_L1_1 (D3002)	R/W	D0357	40357	0164	3.I	I_L1_3 (D3102)	R/W
D0308	40308	0133	1.D	D_L1_1 (D3003)	R/W	D0358	40358	0165	3.D	D_L1_3 (D3103)	R/W
D0309	40309	0134	1.OH	OH_L1_1 (D3004)	R/W	D0359	40359	0166	3.OH	OH_L1_3 (D3104)	R/W
D0310	40310	0135	1.OL	Depends on the conditions (Note2)	R/W	D0360	40360	0167	3.OL	Depends on the conditions (Note2)	R/W
D0311	40311	0136	1.MR	MR_L1_1 (D3006)	R/W	D0361	40361	0168	3.MR	MR_L1_3 (D3106)	R/W
D0312	40312	0137	1.H	HYS_L1_1 (D3007)	R/W	D0362	40362	0169	3.H	HYS_L1_3 (D3107)	R/W
D0313	40313	0138	1.DR	DR_L1_1 (D3011)	R/W	D0363	40363	016A	3.DR	DR_L1_3 (D3111)	R/W
D0314	40314	0139	1.Pc	Pc_L1_1 (D3013)	R/W	D0364	40364	016B	3.Pc	Pc_L1_3 (D3113)	R/W
D0315	40315	013A	1.Ic	Ic_L1_1 (D3014)	R/W	D0365	40365	016C	3.Ic	Ic_L1_3 (D3114)	R/W
D0316	40316	013B	1.Dc	Dc_L1_1 (D3015)	R/W	D0366	40366	016D	3.Dc	Dc_L1_3 (D3115)	R/W
D0317	40317	013C	1.Hc	HYS_L1_1 (D3018)	R/W	D0367	40367	016E	3.Hc	HYS_L1_3 (D3118)	R/W
D0318	40318	013D	1.DB	DB_L1_1 (D3019)	R/W	D0368	40368	016F	3.DB	DB_L1_3 (D3119)	R/W
D0319	40319	013E	1.RP	RP1_L1 (D3551)	R/W	D0369	40369	0170	3.RP	RP3_L1 (D3553)	R/W
D0320	40320	013F	1.PO	PO_L1_1 (D3020)	R/W	D0370	40370	0171	3.PO	PO_L1_3 (D3120)	R/W
D0321	40321	0140	1.Oc	POc_L1_1 (D3022)	R/W	D0371	40371	0172	3.Oc	POc_L1_3 (D3122)	R/W
D0322	40322	0141				D0372	40372	0173			
D0323	40323	0142				D0373	40373	0174			
D0324	40324	0143				D0374	40374	0175			
D0325	40325	0144				D0375	40375	0176			
D0326	40326	0145	2.SP (Note 1)	SP_L1_2 (D2521)	R/W	D0376	40376	0177	4.SP (Note 1)	SP_L1_4 (D2561)	R/W
D0327	40327	0146	2.A1 (Note 1)	A1_L1_2 (D2524)	R/W	D0377	40377	0178	4.A1 (Note 1)	A1_L1_4 (D2564)	R/W
D0328	40328	0147	2.A2 (Note 1)	A2_L1_2 (D2525)	R/W	D0378	40378	0179	4.A2 (Note 1)	A2_L1_4 (D2565)	R/W
D0329	40329	0148	2.A3 (Note 1)	A3_L1_2 (D2526)	R/W	D0379	40379	017A	4.A3 (Note 1)	A3_L1_4 (D2566)	R/W
D0330	40330	0149	2.A4 (Note 1)	A4_L1_2 (D2527)	R/W	D0380	40380	017B	4.A4 (Note 1)	A4_L1_4 (D2567)	R/W
D0331	40331	014A	2.P	P_L1_2 (D3051)	R/W	D0381	40381	017C	4.P	P_L1_4 (D3151)	R/W
D0332	40332	014B	2.I	I_L1_2 (D3052)	R/W	D0382	40382	017D	4.I	I_L1_4 (D3152)	R/W
D0333	40333	014C	2.D	D_L1_2 (D3053)	R/W	D0383	40383	017E	4.D	D_L1_4 (D3153)	R/W
D0334	40334	014D	2.OH	OH_L1_2 (D3054)	R/W	D0384	40384	017F	4.OH	OH_L1_4 (D3154)	R/W
D0335	40335	014E	2.OL	Depends on the conditions (Note2)	R/W	D0385	40385	0180	4.OL	Depends on the conditions (Note2)	R/W
D0336	40336	014F	2.MR	MR_L1_2 (D3056)	R/W	D0386	40386	0181	4.MR	MR_L1_4 (D3156)	R/W
D0337	40337	0150	2.H	HYS_L1_2 (D3057)	R/W	D0387	40387	0182	4.H	HYS_L1_4 (D3157)	R/W
D0338	40338	0151	2.DR	DR_L1_2 (D3061)	R/W	D0388	40388	0183	4.DR	DR_L1_4 (D3161)	R/W
D0339	40339	0152	2.Pc	Pc_L1_2 (D3063)	R/W	D0389	40389	0184	4.Pc	Pc_L1_4 (D3163)	R/W
D0340	40340	0153	2.Ic	Ic_L1_2 (D3064)	R/W	D0390	40390	0185	4.Ic	Ic_L1_4 (D3164)	R/W
D0341	40341	0154	2.Dc	Dc_L1_2 (3065)	R/W	D0391	40391	0186	4.Dc	Dc_L1_4 (D3165)	R/W
D0342	40342	0155	2.Hc	HYS_L1_2 (D3068)	R/W	D0392	40392	0187	4.Hc	HYS_L1_4 (D3168)	R/W
D0343	40343	0156	2.DB	DB_L1_2 (D3069)	R/W	D0393	40393	0188	4.DB	DB_L1_4 (D3169)	R/W
D0344	40344	0157	2.RP	RP2_L1 (D3552)	R/W	D0394	40394	0189	4.RP	RP4_L1 (D3554)	R/W
D0345	40345	0158	2.PO	PO_L1_2 (D3070)	R/W	D0395	40395	018A	4.PO	PO_L1_4 (D3170)	R/W
D0346	40346	0159	2.Oc	POc_L1_2 (D3072)	R/W	D0396	40396	018B	4.Oc	POc_L1_4 (D3172)	R/W
D0347	40347	015A				D0397	40397	018C			
D0348	40348	015B				D0398	40398	018D			
D0349	40349	015C				D0399	40399	018E			
D0350	40350	015D				D0400	40400	018F			

(Note 1): Not for UP550.

(Note 2): See the 6.6.15 D Registers Differing Depending on Conditions

6.6 GREEN Series Compatible D Registers

Configuration map for GREEN Series											
Loop-1 SP / AL / PID parameters											
D-Reg No.	Ref. No.	H No.	Register symbol for GREEN	Register symbol for UTAdvanced	R/W	D-Reg No.	Ref. No.	H No.	Register symbol for GREEN	Register symbol for UTAdvanced	R/W
D0401	40401	0190	5.SP (Note 1)	SP_L1_5 (D2581)	R/W	D0451	40451	01C2	7.SP (Note 1)	SP_L1_7 (D2621)	R/W
D0402	40402	0191	5.A1 (Note 1)	A1_L1_5 (D2584)	R/W	D0452	40452	01C3	7.A1 (Note 1)	A1_L1_7 (D2624)	R/W
D0403	40403	0192	5.A2 (Note 1)	A2_L1_5 (D2585)	R/W	D0453	40453	01C4	7.A2 (Note 1)	A2_L1_7 (D2625)	R/W
D0404	40404	0193	5.A3 (Note 1)	A3_L1_5 (D2586)	R/W	D0454	40454	01C5	7.A3 (Note 1)	A3_L1_7 (D2626)	R/W
D0405	40405	0194	5.A4 (Note 1)	A4_L1_5 (D2587)	R/W	D0455	40455	01C6	7.A4 (Note 1)	A4_L1_7 (D2627)	R/W
D0406	40406	0195	5.P	P_L1_5 (D3201)	R/W	D0456	40456	01C7	7.P	P_L1_7 (D3301)	R/W
D0407	40407	0196	5.I	I_L1_5 (D3202)	R/W	D0457	40457	01C8	7.I	I_L1_7 (D3302)	R/W
D0408	40408	0197	5.D	D_L1_5 (D3203)	R/W	D0458	40458	01C9	7.D	D_L1_7 (D3303)	R/W
D0409	40409	0198	5.OH	OH_L1_5 (D3204)	R/W	D0459	40459	01CA	7.OH	OH_L1_7 (D3304)	R/W
D0410	40410	0199	5.OL	Depends on the conditions (Note2)	R/W	D0460	40460	01CB	7.OL	Depends on the conditions (Note2)	R/W
D0411	40411	019A	5.MR	MR_L1_5 (D3206)	R/W	D0461	40461	01CC	7.MR	MR_L1_7 (D3306)	R/W
D0412	40412	019B	5.H	HYS_L1_5 (D3207)	R/W	D0462	40462	01CD	7.H	HYS_L1_7 (D3307)	R/W
D0413	40413	019C	5.DR	DR_L1_5 (D3211)	R/W	D0463	40463	01CE	7.DR	DR_L1_7 (D3311)	R/W
D0414	40414	019D	5.Pc	Pc_L1_5 (D3213)	R/W	D0464	40464	01CF	7.Pc	Pc_L1_7 (D3313)	R/W
D0415	40415	019E	5.Ic	Ic_L1_5 (D3214)	R/W	D0465	40465	01D0	7.Ic	Ic_L1_7 (D3314)	R/W
D0416	40416	019F	5.Dc	Dc_L1_5 (D3215)	R/W	D0466	40466	01D1	7.Dc	Dc_L1_7 (D3315)	R/W
D0417	40417	01A0	5.Hc	HYS_L1_5 (D3218)	R/W	D0467	40467	01D2	7.Hc	HYS_L1_7 (D3318)	R/W
D0418	40418	01A1	5.DB	DB_L1_5 (D3219)	R/W	D0468	40468	01D3	7.DB	DB_L1_7 (D3319)	R/W
D0419	40419	01A2	5.RP	RP5_L1 (D3555)	R/W	D0469	40469	01D4	RHY	RHY_L1 (D3558)	R/W
D0420	40420	01A3	5.PO	PO_L1_5 (D3220)	R/W	D0470	40470	01D5	7.PO	PO_L1_7 (D3320)	R/W
D0421	40421	01A4	5.Oc	POc_L1_5 (D3222)	R/W	D0471	40471	01D6	7.Oc	POc_L1_7 (D3322)	R/W
D0422	40422	01A5				D0472	40472	01D7			
D0423	40423	01A6				D0473	40473	01D8			
D0424	40424	01A7				D0474	40474	01D9			
D0425	40425	01A8				D0475	40475	01DA			
D0426	40426	01A9	6.SP (Note 1)	SP_L1_6 (D2601)	R/W	D0476	40476	01DB	8.SP (Note 1)	SP_L1_8 (D2641)	R/W
D0427	40427	01AA	6.A1 (Note 1)	A1_L1_6 (D2604)	R/W	D0477	40477	01DC	8.A1 (Note 1)	A1_L1_8 (D2644)	R/W
D0428	40428	01AB	6.A2 (Note 1)	A2_L1_6 (D2605)	R/W	D0478	40478	01DD	8.A2 (Note 1)	A2_L1_8 (D2645)	R/W
D0429	40429	01AC	6.A3 (Note 1)	A3_L1_6 (D2606)	R/W	D0479	40479	01DE	8.A3 (Note 1)	A3_L1_8 (D2646)	R/W
D0430	40430	01AD	6.A4 (Note 1)	A4_L1_6 (D2607)	R/W	D0480	40480	01DF	8.A4 (Note 1)	A4_L1_8 (D2647)	R/W
D0431	40431	01AE	6.P	P_L1_6 (D3251)	R/W	D0481	40481	01E0	8.P	P_L1_8 (D3351)	R/W
D0432	40432	01AF	6.I	I_L1_6 (D3252)	R/W	D0482	40482	01E1	8.I	I_L1_8 (D2352)	R/W
D0433	40433	01B0	6.D	D_L1_6 (D3253)	R/W	D0483	40483	01E2	8.D	D_L1_8 (D3353)	R/W
D0434	40434	01B1	6.OH	OH_L1_6 (D3254)	R/W	D0484	40484	01E3	8.OH	OH_L1_8 (D3354)	R/W
D0435	40435	01B2	6.OL	Depends on the conditions (Note2)	R/W	D0485	40485	01E4	8.OL	Depends on the conditions (Note2)	R/W
D0436	40436	01B3	6.MR	MR_L1_6 (D3256)	R/W	D0486	40486	01E5	8.MR	MR_L1_8 (D3356)	R/W
D0437	40437	01B4	6.H	HYS_L1_6 (D3257)	R/W	D0487	40487	01E6	8.H	HYS_L1_8 (D3357)	R/W
D0438	40438	01B5	6.DR	DR_L1_6 (D3261)	R/W	D0488	40488	01E7	8.DR	DR_L1_8 (D3361)	R/W
D0439	40439	01B6	6.Pc	Pc_L1_6 (D3263)	R/W	D0489	40489	01E8	8.Pc	Pc_L1_8 (D3363)	R/W
D0440	40440	01B7	6.Ic	Ic_L1_6 (D3264)	R/W	D0490	40490	01E9	8.Ic	Ic_L1_8 (D3364)	R/W
D0441	40441	01B8	6.Dc	Dc_L1_6 (D3265)	R/W	D0491	40491	01EA	8.Dc	Dc_L1_8 (D3365)	R/W
D0442	40442	01B9	6.Hc	HYS_L1_6 (D3268)	R/W	D0492	40492	01EB	8.Hc	HYS_L1_8 (D3368)	R/W
D0443	40443	01BA	6.DB	DB_L1_6 (D3269)	R/W	D0493	40493	01EC	8.DB	DB_L1_8 (D3369)	R/W
D0444	40444	01BB	6.RP	RP6_L1 (D3556)	R/W	D0494	40494	01ED	RDV	RDV_L1 (D3559)	R/W
D0445	40445	01BC	6.PO	PO_L1_6 (D3270)	R/W	D0495	40495	01EE	8.PO	PO_L1_8 (D3370)	R/W
D0446	40446	01BD	6.Oc	POc_L1_6 (D3272)	R/W	D0496	40496	01EF	8.Oc	POc_L1_8 (D3372)	R/W
D0447	40447	01BE				D0497	40497	01F0			
D0448	40448	01BF				D0498	40498	01F1			
D0449	40449	01C0				D0499	40499	01F2			
D0450	40450	01C1				D0500	40500	01F3			

(Note 1): Not for UP550.

(Note 2): See the 6.6.15 D Registers Differing Depending on Conditions

6.6.6 Loop-2 PID Parameters (D0501 to D0700)

Configuration map for GREEN Series											
Loop-2 SP / AL / PID parameters											
D-Reg No.	Ref. No.	H No.	Register symbol for GREEN	Register symbol for UTAdvanced	R/W	D-Reg No.	Ref. No.	H No.	Register symbol for GREEN	Register symbol for UTAdvanced	R/W
D0501	40501	01F4	1.SP (Note 1)	SP_L2_1 (D3601)	R/W	D0551	40551	0226	3.SP (Note 1)	SP_L2_3 (D3641)	R/W
D0502	40502	01F5	1.A1 (Note 1)	A1_L2_1 (D3604)	R/W	D0552	40552	0227	3.A1 (Note 1)	A1_L2_3 (D3644)	R/W
D0503	40503	01F6	1.A2 (Note 1)	A2_L2_1 (D3605)	R/W	D0553	40553	0228	3.A2 (Note 1)	A2_L2_3 (D3645)	R/W
D0504	40504	01F7	1.A3 (Note 1)	A3_L2_1 (D3606)	R/W	D0554	40554	0229	3.A3 (Note 1)	A3_L2_3 (D3646)	R/W
D0505	40505	01F8	1.A4 (Note 1)	A4_L2_1 (D3607)	R/W	D0555	40555	022A	3.A4 (Note 1)	A4_L2_3 (D3647)	R/W
D0506	40506	01F9	1.P	P_L2_1 (D4101)	R/W	D0556	40556	022B	3.P	P_L2_3 (D4201)	R/W
D0507	40507	01FA	1.I	I_L2_1 (D4102)	R/W	D0557	40557	022C	3.I	I_L2_3 (D4202)	R/W
D0508	40508	01FB	1.D	D_L2_1 (D4103)	R/W	D0558	40558	022D	3.D	D_L2_3 (D4203)	R/W
D0509	40509	01FC	1.OH	OH_L2_1 (D4104)	R/W	D0559	40559	022E	3.OH	OH_L2_3 (D4204)	R/W
D0510	40510	01FD	1.OL	Depends on the conditions (Note2)	R/W	D0560	40560	022F	3.OL	Depends on the conditions (Note2)	R/W
D0511	40511	01FE	1.MR	MR_L2_1 (D4106)	R/W	D0561	40561	0230	3.MR	MR_L2_3 (D4206)	R/W
D0512	40512	01FF	1.H	HYS_L2_1 (D4107)	R/W	D0562	40562	0231	3.H	HYS_L2_3 (D4207)	R/W
D0513	40513	0200	1.DR	DR_L2_1 (D4111)	R/W	D0563	40563	0232	3.DR	DR_L2_3 (D4211)	R/W
D0514	40514	0201	1.Pc	Pc_L2_1 (D4113)	R/W	D0564	40564	0233	3.Pc	Pc_L2_3 (D4213)	R/W
D0515	40515	0202	1.Ic	Ic_L2_1 (D4114)	R/W	D0565	40565	0234	3.Ic	Ic_L2_3 (D4214)	R/W
D0516	40516	0203	1.Dc	Dc_L2_1 (D4115)	R/W	D0566	40566	0235	3.Dc	Dc_L2_3 (D4215)	R/W
D0517	40517	0204	1.Hc	HYS_L2_1 (D4118)	R/W	D0567	40567	0236	3.Hc	HYS_L2_3 (D4218)	R/W
D0518	40518	0205	1.DB	DB_L2_1 (D4119)	R/W	D0568	40568	0237	3.DB	DB_L2_3 (D4219)	R/W
D0519	40519	0206	1.RP	RP1_L2 (D4653)	R/W	D0569	40569	0238	3.RP	RP3_L2 (D4655)	R/W
D0520	40520	0207	1.PO	PO_L2_1 (D4120)	R/W	D0570	40570	0239	3.PO	PO_L2_3 (D4220)	R/W
D0521	40521	0208	1.Oc	POc_L2_1 (D4122)	R/W	D0571	40571	023A	3.Oc	POc_L2_3 (D4222)	R/W
D0522	40522	0209				D0572	40572	023B			
D0523	40523	020A				D0573	40573	023C			
D0524	40524	020B				D0574	40574	023D			
D0525	40525	020C				D0575	40575	023E			
D0526	40526	020D	2.SP (Note 1)	SP_L2_2 (D3621)	R/W	D0576	40576	023F	4.SP (Note 1)	SP_L2_4 (D3661)	R/W
D0527	40527	020E	2.A1 (Note 1)	A1_L2_2 (D3624)	R/W	D0577	40577	0240	4.A1 (Note 1)	A1_L2_4 (D3664)	R/W
D0528	40528	020F	2.A2 (Note 1)	A2_L2_2 (D3625)	R/W	D0578	40578	0241	4.A2 (Note 1)	A2_L2_4 (D3665)	R/W
D0529	40529	0210	2.A3 (Note 1)	A3_L2_2 (D3626)	R/W	D0579	40579	0242	4.A3 (Note 1)	A3_L2_4 (D3666)	R/W
D0530	40530	0211	2.A4 (Note 1)	A4_L2_2 (D3637)	R/W	D0580	40580	0243	4.A4 (Note 1)	A4_L2_4 (D3667)	R/W
D0531	40531	0212	2.P	P_L2_2 (D4151)	R/W	D0581	40581	0244	4.P	P_L2_4 (D4251)	R/W
D0532	40532	0213	2.I	I_L2_2 (D4152)	R/W	D0582	40582	0245	4.I	I_L2_4 (D4252)	R/W
D0533	40533	0214	2.D	D_L2_2 (D4153)	R/W	D0583	40583	0246	4.D	D_L2_4 (D4253)	R/W
D0534	40534	0215	2.OH	OH_L2_2 (D4154)	R/W	D0584	40584	0247	4.OH	OH_L2_4 (D4254)	R/W
D0535	40535	0216	2.OL	Depends on the conditions (Note2)	R/W	D0585	40585	0248	4.OL	Depends on the conditions (Note2)	R/W
D0536	40536	0217	2.MR	MR_L2_2 (D4156)	R/W	D0586	40586	0249	4.MR	MR_L2_4 (D4256)	R/W
D0537	40537	0218	2.H	HYS_L2_2 (D4157)	R/W	D0587	40587	024A	4.H	HYS_L2_4 (D4257)	R/W
D0538	40538	0219	2.DR	DR_L2_2 (D4161)	R/W	D0588	40588	024B	4.DR	DR_L2_4 (D4261)	R/W
D0539	40539	021A	2.Pc	Pc_L2_2 (D4163)	R/W	D0589	40589	024C	4.Pc	Pc_L2_4 (D4263)	R/W
D0540	40540	021B	2.Ic	Ic_L2_2 (D4164)	R/W	D0590	40590	024D	4.Ic	Ic_L2_4 (D4264)	R/W
D0541	40541	021C	2.Dc	Dc_L2_2 (D4165)	R/W	D0591	40591	024E	4.Dc	Dc_L2_4 (D4265)	R/W
D0542	40542	021D	2.Hc	HYS_L2_2 (D4168)	R/W	D0592	40592	024F	4.Hc	HYS_L2_4 (D4268)	R/W
D0543	40543	021E	2.DB	DB_L2_2 (D4169)	R/W	D0593	40593	0250	4.DB	DB_L2_4 (D4269)	R/W
D0544	40544	021F	2.RP	RP2_L2 (D4654)	R/W	D0594	40594	0251	4.RP	RP4_L2 (D4656)	R/W
D0545	40545	0220	2.PO	PO_L2_2 (D4170)	R/W	D0595	40595	0252	4.PO	PO_L2_4 (D4270)	R/W
D0546	40546	0221	2.Oc	POc_L2_2 (D4172)	R/W	D0596	40596	0253	4.Oc	POc_L2_4 (D4272)	R/W
D0547	40547	0222				D0597	40597	0254			
D0548	40548	0223				D0598	40598	0255			
D0549	40549	0224				D0599	40599	0256			
D0550	40550	0225				D0600	40600	0257			

(Note1): Not for UP550.

(Note 2): See the 6.6.15 D Registers Differing Depending on Conditions

6.6 GREEN Series Compatible D Registers

Configuration map for GREEN Series											
Loop-2 SP / AL / PID parameters											
D-Reg No.	Ref. No.	H No.	Register symbol for GREEN	Register symbol for UTAdvanced	R/W	D-Reg No.	Ref. No.	H No.	Register symbol for GREEN	Register symbol for UTAdvanced	R/W
D0601	40601	0258	5.SP (Note 1)	SP_L2_5 (D3681)	R/W	D0651	40651	028A	7.SP (Note 1)	SP_L2_7 (D3721)	R/W
D0602	40602	0259	5.A1 (Note 1)	A1_L2_5 (D3684)	R/W	D0652	40652	028B	7.A1 (Note 1)	A1_L2_7 (D3724)	R/W
D0603	40603	025A	5.A2 (Note 1)	A2_L2_5 (D3635)	R/W	D0653	40653	028C	7.A2 (Note 1)	A2_L2_7 (D3725)	R/W
D0604	40604	025B	5.A3 (Note 1)	A3_L2_5 (D6386)	R/W	D0654	40654	028D	7.A3 (Note 1)	A3_L2_7 (D3726)	R/W
D0605	40605	025C	5.A4 (Note 1)	A4_L2_5 (D3687)	R/W	D0655	40655	028E	7.A4 (Note 1)	A4_L2_7 (D3727)	R/W
D0606	40606	025D	5.P	P_L2_5 (D4301)	R/W	D0656	40656	028F	7.P	P_L2_7 (D4401)	R/W
D0607	40607	025E	5.I	I_L2_5 (D4302)	R/W	D0657	40657	0290	7.I	I_L2_7 (D4402)	R/W
D0608	40608	025F	5.D	D_L2_5 (D4303)	R/W	D0658	40658	0291	7.D	D_L2_7 (D4403)	R/W
D0609	40609	0260	5.OH	OH_L2_5 (D4304)	R/W	D0659	40659	0292	7.OH	OH_L2_7 (D4404)	R/W
D0610	40610	0261	5.OL	Depends on the conditions (Note2)	R/W	D0660	40660	0293	7.OL	Depends on the conditions (Note2)	R/W
D0611	40611	0262	5.MR	MR_L2_5 (D4306)	R/W	D0661	40661	0294	7.MR	MR_L2_7 (D4406)	R/W
D0612	40612	0263	5.H	HYS_L2_5 (D4307)	R/W	D0662	40662	0295	7.H	HYS_L2_7 (D4407)	R/W
D0613	40613	0264	5.DR	DR_L2_5 (D4311)	R/W	D0663	40663	0296	7.DR	DR_L2_7 (D4411)	R/W
D0614	40614	0265	5.Pc	Pc_L2_5 (D4313)	R/W	D0664	40664	0297	7.Pc	Pc_L2_7 (D4413)	R/W
D0615	40615	0266	5.lc	lc_L2_5 (D4314)	R/W	D0665	40665	0298	7.lc	lc_L2_7 (D4414)	R/W
D0616	40616	0267	5.Dc	Dc_L2_5 (D4315)	R/W	D0666	40666	0299	7.Dc	Dc_L2_7 (D4415)	R/W
D0617	40617	0268	5.Hc	HYS_L2_5 (D4318)	R/W	D0667	40667	029A	7.Hc	HYS_L2_7 (D4418)	R/W
D0618	40618	0269	5.DB	DB_L2_5 (D4319)	R/W	D0668	40668	029B	7.DB	DB_L2_7 (D4419)	R/W
D0619	40619	026A	5.RP	RP5_L2 (D4657)	R/W	D0669	40669	029C	RHY	RHY_L2 (D4660)	R/W
D0620	40620	026B	5.PO	PO_L2_5 (D4320)	R/W	D0670	40670	029D	7.PO	PO_L2_7 (D4420)	R/W
D0621	40621	026C	5.Oc	POc_L2_5 (D4322)	R/W	D0671	40671	029E	7.Oc	POc_L2_7 (D4422)	R/W
D0622	40622	026D				D0672	40672	029F			
D0623	40623	026E				D0673	40673	02A0			
D0624	40624	026F				D0674	40674	02A1			
D0625	40625	0270				D0675	40675	02A2			
D0626	40626	0271	6.SP (Note 1)	SP_L2_6 (D3701)	R/W	D0676	40676	02A3	8.SP (Note 1)	SP_L2_8 (D3741)	R/W
D0627	40627	0272	6.A1 (Note 1)	A1_L2_6 (D3704)	R/W	D0677	40677	02A4	8.A1 (Note 1)	A1_L2_8 (D3744)	R/W
D0628	40628	0273	6.A2 (Note 1)	A2_L2_6 (D3705)	R/W	D0678	40678	02A5	8.A2 (Note 1)	A2_L2_8 (D3745)	R/W
D0629	40629	0274	6.A3 (Note 1)	A3_L2_6 (D3706)	R/W	D0679	40679	02A6	8.A3 (Note 1)	A3_L2_8 (D3746)	R/W
D0630	40630	0275	6.A4 (Note 1)	A4_L2_6 (D3707)	R/W	D0680	40680	02A7	8.A4 (Note 1)	A4_L2_8 (D3747)	R/W
D0631	40631	0276	6.P	P_L2_6 (D4351)	R/W	D0681	40681	02A8	8.P	P_L2_8 (D4451)	R/W
D0632	40632	0277	6.I	I_L2_6 (D4352)	R/W	D0682	40682	02A9	8.I	I_L2_8 (D4452)	R/W
D0633	40633	0278	6.D	D_L2_6 (D4353)	R/W	D0683	40683	02AA	8.D	D_L2_8 (D4453)	R/W
D0634	40634	0279	6.OH	OH_L2_6 (D4354)	R/W	D0684	40684	02AB	8.OH	OH_L2_8 (D4454)	R/W
D0635	40635	027A	6.OL	Depends on the conditions (Note2)	R/W	D0685	40685	02AC	8.OL	Depends on the conditions (Note2)	R/W
D0636	40636	027B	6.MR	MR_L2_6 (D4356)	R/W	D0686	40686	02AD	8.MR	MR_L2_8 (D4456)	R/W
D0637	40637	027C	6.H	HYS_L2_6 (D4357)	R/W	D0687	40687	02AE	8.H	HYS_L2_8 (D4457)	R/W
D0638	40638	027D	6.DR	DR_L2_6 (D4361)	R/W	D0688	40688	02AF	8.DR	DR_L2_8 (D4461)	R/W
D0639	40639	027E	6.Pc	Pc_L2_6 (D4363)	R/W	D0689	40689	02B0	8.Pc	Pc_L2_8 (D4463)	R/W
D0640	40640	027F	6.lc	lc_L2_6 (D4364)	R/W	D0690	40690	02B1	8.lc	lc_L2_8 (D4464)	R/W
D0641	40641	0280	6.Dc	Dc_L2_6 (D4365)	R/W	D0691	40691	02B2	8.Dc	Dc_L2_8 (D4465)	R/W
D0642	40642	0281	6.Hc	HYS_L2_6 (D4368)	R/W	D0692	40692	02B3	8.Hc	HYS_L2_8 (D4468)	R/W
D0643	40643	0282	6.DB	DB_L2_6 (D4369)	R/W	D0693	40693	02B4	8.DB	DB_L2_8 (D4469)	R/W
D0644	40644	0283	6.RP	RP6_L2 (D4658)	R/W	D0694	40694	02B5	RDV	RDV_L2 (D4661)	R/W
D0645	40645	0284	6.PO	PO_L2_6 (D4370)	R/W	D0695	40695	02B6	8.PO	PO_L2_8 (D4470)	R/W
D0646	40646	0285	6.Oc	POc_L2_6 (D4372)	R/W	D0696	40696	02B7	8.Oc	POc_L2_8 (D4472)	R/W
D0647	40647	0286				D0697	40697	02B8			
D0648	40648	0287				D0698	40698	02B9			
D0649	40649	0288				D0699	40699	02BA			
D0650	40650	0289				D0700	40700	02BB			

(Note1): Not for UP550.

(Note 2): See the 6.6.15 D Registers Differing Depending on Conditions

6.6.7 User Parameters and 10-segment Linearizer Parameters (D0701 to D0800)

Configuration map for GREEN Series											
User parameters / 10-segment linearizer parameters											
D-Reg No.	Ref. No.	H No.	Register symbol for GREEN	Register symbol for UTAdvanced	R/W	D-Reg No.	Ref. No.	H No.	Register symbol for GREEN	Register symbol for UTAdvanced	R/W
D0701	40701	02BC	U1	Depends on the conditions (Note1)	R/W	D0751	40751	02EE	2.A1	A1_2 (D4832)	R/W
D0702	40702	02BD	U2	Depends on the conditions (Note1)	R/W	D0752	40752	02EF	2.B1	B1_2 (D4833)	R/W
D0703	40703	02BE	U3	Depends on the conditions (Note1)	R/W	D0753	40753	02F0	2.A2	A2_2 (D4834)	R/W
D0704	40704	02BF				D0754	40754	02F1	2.B2	B2_2 (D4835)	R/W
D0705	40705	02C0				D0755	40755	02F2	2.A3	A3_2 (D4836)	R/W
D0706	40706	02C1				D0756	40756	02F3	2.B3	B3_2 (D4837)	R/W
D0707	40707	02C2				D0757	40757	02F4	2.A4	A4_2 (D4838)	R/W
D0708	40708	02C3				D0758	40758	02F5	2.B4	B4_2 (D4839)	R/W
D0709	40709	02C4				D0759	40759	02F6	2.A5	A5_2 (D4840)	R/W
D0710	40710	02C5				D0760	40760	02F7	2.B5	B5_2 (D4841)	R/W
D0711	40711	02C6				D0761	40761	02F8	2.A6	A6_2 (D4842)	R/W
D0712	40712	02C7				D0762	40762	02F9	2.B6	B6_2 (D4843)	R/W
D0713	40713	02C8				D0763	40763	02FA	2.A7	A7_2 (D4844)	R/W
D0714	40714	02C9				D0764	40764	02FB	2.B7	B7_2 (D4845)	R/W
D0715	40715	02CA				D0765	40765	02FC	2.A8	A8_2 (D4846)	R/W
D0716	40716	02CB				D0766	40766	02FD	2.B8	B8_2 (D4847)	R/W
D0717	40717	02CC				D0767	40767	02FE	2.A9	A9_2 (D4848)	R/W
D0718	40718	02CD				D0768	40768	02FF	2.B9	B9_2 (D4849)	R/W
D0719	40719	02CE				D0769	40769	0300	2.A10	A10_2 (D4850)	R/W
D0720	40720	02CF				D0770	40770	0301	2.B10	B10_2 (D4851)	R/W
D0721	40721	02D0				D0771	40771	0302	2.A11	A11_2 (D4852)	R/W
D0722	40722	02D1				D0772	40772	0303	2.B11	B11_2 (D4853)	R/W
D0723	40723	02D2				D0773	40773	0304	2.PMD	PMD_2 (D4854)	R/W
D0724	40724	02D3				D0774	40774	0305			
D0725	40725	02D4				D0775	40775	0306			
D0726	40726	02D5	1.A1	A1_1 (D4802)	R/W	D0776	40776	0307			
D0727	40727	02D6	1.B1	B1_1 (D4803)	R/W	D0777	40777	0308			
D0728	40728	02D7	1.A2	A2_1 (D4804)	R/W	D0778	40778	0309			
D0729	40729	02D8	1.B2	B2_1 (D4805)	R/W	D0779	40779	030A			
D0730	40730	02D9	1.A3	A3_1 (D4806)	R/W	D0780	40780	030B			
D0731	40731	02DA	1.B3	B3_1 (D4807)	R/W	D0781	40781	030C			
D0732	40732	02DB	1.A4	A4_1 (D4808)	R/W	D0782	40782	030D			
D0733	40733	02DC	1.B4	B4_1 (D4809)	R/W	D0783	40783	030E			
D0734	40734	02DD	1.A5	A5_1 (D4810)	R/W	D0784	40784	030F			
D0735	40735	02DE	1.B5	B5_1 (D4811)	R/W	D0785	40785	0310			
D0736	40736	02DF	1.A6	A6_1 (D4812)	R/W	D0786	40786	0311			
D0737	40737	02E0	1.B6	B6_1 (D4813)	R/W	D0787	40787	0312			
D0738	40738	02E1	1.A7	A7_1 (D4814)	R/W	D0788	40788	0313			
D0739	40739	02E2	1.B7	B7_1 (D4815)	R/W	D0789	40789	0314			
D0740	40740	02E3	1.A8	A8_1 (D4816)	R/W	D0790	40790	0315			
D0741	40741	02E4	1.B8	B8_1 (D4817)	R/W	D0791	40791	0316			
D0742	40742	02E5	1.A9	A9_1 (D4818)	R/W	D0792	40792	0317			
D0743	40743	02E6	1.B9	B9_1 (D4819)	R/W	D0793	40793	0318			
D0744	40744	02E7	1.A10	A10_1 (D4820)	R/W	D0794	40794	0319			
D0745	40745	02E8	1.B10	B10_1 (D4821)	R/W	D0795	40795	031A			
D0746	40746	02E9	1.A11	A11_1 (D4822)	R/W	D0796	40796	031B			
D0747	40747	02EA	1.B11	B11_1 (D4823)	R/W	D0797	40797	031C			
D0748	40748	02EB	1.PMD	PMD_1 (D4824)	R/W	D0798	40798	031D			
D0749	40749	02EC				D0799	40799	031E			
D0750	40750	02ED				D0800	40800	031F			

(Note 1): See the 6.6.15 D Registers Differing Depending on Conditions

6.6 GREEN Series Compatible D Registers

6.6.8 Message (D0801 to D0900)

Configuration map for GREEN Series											
Message											
D-Reg No.	Ref. No.	H No.	Register symbol for GREEN	Register symbol for UTAdvanced	R/W	D-Reg No.	Ref. No.	H No.	Register symbol for GREEN	Register symbol for UTAdvanced	R/W
D0801	40801	0320	MG10 (Note 1)		R	D0851	40851	0352			
D0802	40802	0321	MG11 (Note 1)		R	D0852	40852	0353			
D0803	40803	0322	MG12 (Note 1)		R	D0853	40853	0354			
D0804	40804	0323	MG13 (Note 1)		R	D0854	40854	0355			
D0805	40805	0324	MG14 (Note 1)		R	D0855	40855	0356			
D0806	40806	0325	MG15 (Note 1)		R	D0856	40856	0357			
D0807	40807	0326	MG16 (Note 1)		R	D0857	40857	0358			
D0808	40808	0327	MG17 (Note 1)		R	D0858	40858	0359			
D0809	40809	0328	MG18 (Note 1)		R	D0859	40859	035A			
D0810	40810	0329	MG19 (Note 1)		R	D0860	40860	035B			
D0811	40811	032A	MG20 (Note 1)		R	D0861	40861	035C			
D0812	40812	032B	MG21 (Note 1)		R	D0862	40862	035D			
D0813	40813	032C	MG22 (Note 1)		R	D0863	40863	035E			
D0814	40814	032D	MG23 (Note 1)		R	D0864	40864	035F			
D0815	40815	032E	MG24 (Note 1)		R	D0865	40865	0360			
D0816	40816	032F	MG25 (Note 1)		R	D0866	40866	0361			
D0817	40817	0330	MG26 (Note 1)		R	D0867	40867	0362			
D0818	40818	0331	MG27 (Note 1)		R	D0868	40868	0363			
D0819	40819	0332	MG28 (Note 1)		R	D0869	40869	0364			
D0820	40820	0333	MG29 (Note 1)		R	D0870	40870	0365			
D0821	40821	0334	MG30 (Note 1)		R	D0871	40871	0366			
D0822	40822	0335	MG31 (Note 1)		R	D0872	40872	0367			
D0823	40823	0336	MG32 (Note 1)		R	D0873	40873	0368			
D0824	40824	0337	MG33 (Note 1)		R	D0874	40874	0369			
D0825	40825	0338	MG34 (Note 1)		R	D0875	40875	036A			
D0826	40826	0339	MG35 (Note 1)		R	D0876	40876	036B			
D0827	40827	033A	MG36 (Note 1)		R	D0877	40877	036C			
D0828	40828	033B	MG37 (Note 1)		R	D0878	40878	036D			
D0829	40829	033C	MG38 (Note 1)		R	D0879	40879	036E			
D0830	40830	033D	MG39 (Note 1)		R	D0880	40880	036F			
D0831	40831	033E	MG40 (Note 1)		R	D0881	40881	0370			
D0832	40832	033F	MG41 (Note 1)		R	D0882	40882	0371			
D0833	40833	0340	MG42 (Note 1)		R	D0883	40883	0372			
D0834	40834	0341	MG43 (Note 1)		R	D0884	40884	0373			
D0835	40835	0342	MG44 (Note 1)		R	D0885	40885	0374			
D0836	40836	0343	MG45 (Note 1)		R	D0886	40886	0375			
D0837	40837	0344	MG46 (Note 1)		R	D0887	40887	0376			
D0838	40838	0345	MG47 (Note 1)		R	D0888	40888	0377			
D0839	40839	0346	MG48 (Note 1)		R	D0889	40889	0378			
D0840	40840	0347	MG49 (Note 1)		R	D0890	40890	0379			
D0841	40841	0348	NAME1		R/W	D0891	40891	037A			
D0842	40842	0349	NAME2		R/W	D0892	40892	037B			
D0843	40843	034A	NAME3		R/W	D0893	40893	037C			
D0844	40844	034B	NAME4		R/W	D0894	40894	037D			
D0845	40845	034C	NAME5		R/W	D0895	40895	037E			
D0846	40846	034D	NAME6		R/W	D0896	40896	037F			
D0847	40847	034E	NAME7		R/W	D0897	40897	0380			
D0848	40848	034F	NAME8		R/W	D0898	40898	0381			
D0849	40849	0350	NAME9		R/W	D0899	40899	0382			
D0850	40850	0351	NAME10		R/W	D0900	40900	0383			

(Note 1): For UP550.

6.6.9 Control Action Parameters (D0901 to D1000)

Configuration map for GREEN Series											
Control action parameters											
D-Reg No.	Ref. No.	H No.	Register symbol for GREEN	Register symbol for UTAdvanced	R/W	D-Reg No.	Ref. No.	H No.	Register symbol for GREEN	Register symbol for UTAdvanced	R/W
D0901	40901	0384	RMS.1 (Note 1)	RMS_L1 (D2701)	R/W	D0951	40951	03B6			
D0902	40902	0385	SPT.1	SPT_L1 (D2710)	R/W	D0952	40952	03B7			
D0903	40903	0386	PVT.1 (Note 1)	PVT_L1 (D2711)	R/W	D0953	40953	03B8			
D0904	40904	0387	TMU.1	TMU_L1 (D2707) (Note 3)	R/W	D0954	40954	03B9			
D0905	40905	0388	SEG.T (Note 2)	SEG.T (D5016)	R/W	D0955	40955	03BA	AL1.2 (Note 1)	AL1.T_L2 (D3901)	R/W
D0906	40906	0389	PT2.G (Note 2)	PT2.G (D5018)	R/W	D0956	40956	03BB	AL2.2 (Note 1)	AL2.T_L2 (D3905)	R/W
D0907	40907	038A	EHY1 (Note 2)	EHY1 (D2871)	R/W	D0957	40957	03BC	AL3.2 (Note 1)	AL3.T_L2 (D3909)	R/W
D0908	40908	038B	EHY2 (Note 2)	EHY2 (D2872)	R/W	D0958	40958	03BD	AL4.2 (Note 1)	AL4.T_L2 (D3913)	R/W
D0909	40909	038C	EHY3 (Note 2)	EHY3 (D2873)	R/W	D0959	40959	03BE	HY1.2 (Note 1)	HY1_L2 (D3941)	R/W
D0910	40910	038D	EHY4 (Note 2)	EHY4 (D2874)	R/W	D0960	40960	03BF	HY2.2 (Note 1)	HY2_L2 (D3942)	R/W
D0911	40911	038E	EHY5 (Note 2)	EHY5 (D2875)	R/W	D0961	40961	03C0	HY3.2 (Note 1)	HY3_L2 (D3943)	R/W
D0912	40912	038F	EHY6 (Note 2)	EHY6 (D2876)	R/W	D0962	40962	03C1	HY4.2 (Note 1)	HY4_L2 (D3944)	R/W
D0913	40913	0390	EHY7 (Note 2)	EHY7 (D2877)	R/W	D0963	40963	03C2	AMD.2 (Note 1)	AMD_L2 (D3966)	R/W
D0914	40914	0391	EHY8 (Note 2)	EHY8 (D2878)	R/W	D0964	40964	03C3			
D0915	40915	0392	AL1.1	AL1.T_L1 (D2801)	R/W	D0965	40965	03C4			
D0916	40916	0393	AL2.1	AL2.T_L1 (D2805)	R/W	D0966	40966	03C5	OPR.2	OPR_L2 (D4627)	R/W
D0917	40917	0394	AL3.1	AL3.T_L1 (D2809)	R/W	D0967	40967	03C6	MOD.2	ALG_L2 (D5006)	R/W
D0918	40918	0395	AL4.1	AL4.T_L1 (D2813)	R/W	D0968	40968	03C7	AR.2	AR_L2 (D4626)	R/W
D0919	40919	0396	HY1.1	HY1_L1 (D2841)	R/W	D0969	40969	03C8			
D0920	40920	0397	HY2.1	HY2_L1 (D2842)	R/W	D0970	40970	03C9			
D0921	40921	0398	HY3.1	HY3_L1 (D2843)	R/W	D0971	40971	03CA			
D0922	40922	0399	HY4.1	HY4_L1 (D2844)	R/W	D0972	40972	03CB			
D0923	40923	039A	AMD.1	AMD_L1 (D2866)	R/W	D0973	40973	03CC	SPH.2	SPH_L2 (D5230)	R/W
D0924	40924	039B				D0974	40974	03CD	SPL.2	SPL_L2 (D5231)	R/W
D0925	40925	039C				D0975	40975	03CE	DY1.2 (Note 1)	DYN1_L2 (D3949)	R/W
D0926	40926	039D	OPR.1	OPR_L1 (D3527)	R/W	D0976	40976	03CF	DY2.2 (Note 1)	DYN2_L2 (D3950)	R/W
D0927	40927	039E	MOD.1	ALG_L1 (D5005)	R/W	D0977	40977	03D0	DY3.2 (Note 1)	DYN3_L2 (D3951)	R/W
D0928	40928	039F	AR.1	AR_L1 (D3526)	R/W	D0978	40978	03D1	DY4.2 (Note 1)	DYN4_L2 (D3952)	R/W
D0929	40929	03A0	ZON	ZON (D5012)	R/W	D0979	40979	03D2			
D0930	40930	03A1	R.MD	R.MD (D6401)	R/W	D0980	40980	03D3	M.MD1 (Note 1)	MPON_L1 (D3531)	R/W
D0931	40931	03A2	R.TM	R.TM (D6402)	R/W	D0981	40981	03D4	MPO1 (Note 1)	MPO1_L1 (D3532)	R/W
D0932	40932	03A3				D0982	40982	03D5	M.MD2 (Note 1)	MPON_L2 (D4631)	R/W
D0933	40933	03A4	SPH.1	SPH_L1 (D5210)	R/W	D0983	40983	03D6	MPO2 (Note 1)	MPO1_L2 (D4632)	R/W
D0934	40934	03A5	SPL.1	SPL_L1 (D5211)	R/W	D0984	40984	03D7			
D0935	40935	03A6	DY1.1 (Note 1)	DYN1_L1 (D2849)	R/W	D0985	40985	03D8			
D0936	40936	03A7	DY2.1 (Note 1)	DYN2_L1 (D2850)	R/W	D0986	40986	03D9			
D0937	40937	03A8	DY3.1 (Note 1)	DYN3_L1 (D2851)	R/W	D0987	40987	03DA			
D0938	40938	03A9	DY4.1 (Note 1)	DYN4_L1 (D2852)	R/W	D0988	40988	03DB			
D0939	40939	03AA	PNC (Note 2)	PNC (D2713)	R/W	D0989	40989	03DC			
D0940	40940	03AB	GRP (Note 1)	SPGR. (D5007)	R/W	D0990	40990	03DD			
D0941	40941	03AC	RMS.2 (Note 1)	RMS_L2 (D3801)	R/W	D0991	40991	03DE			
D0942	40942	03AD	SPT.2 (Note 1)	SPT_L2 (D3810)	R/W	D0992	40992	03DF			
D0943	40943	03AE	PVT.2 (Note 1)	PVT_L2 (D3811)	R/W	D0993	40993	03E0			
D0944	40944	03AF	TMU.2 (Note 1)	TMU_L2 (D3807)	R/W	D0994	40994	03E1			
D0945	40945	03B0				D0995	40995	03E2			
D0946	40946	03B1				D0996	40996	03E3			
D0947	40947	03B2				D0997	40997	03E4			
D0948	40948	03B3				D0998	40998	03E5			
D0949	40949	03B4				D0999	40999	03E6			
D0950	40950	03B5				D1000	41000	03E7			

(Note1): Not for UP550.

(Note 2): For UP550.

(Note 3): Note that for the UP550, the register symbols for UTAdvanced are "TMU (D5017)."

6.6 GREEN Series Compatible D Registers

6.6.10 Common Function Parameters (D1001 to D1100)

Configuration map for GREEN Series											
Common function parameters											
D-Reg No.	Ref. No.	H No.	Register symbol for GREEN	Register symbol for UTAdvanced	R/W	D-Reg No.	Ref. No.	H No.	Register symbol for GREEN	Register symbol for UTAdvanced	R/W
D1001	41001	03E8	A.BS1	A.BS (D5112)	R/W	D1051	41051	041A			
D1002	41002	03E9	A.FL1	A.FL (D5113)	R/W	D1052	41052	041B			
D1003	41003	03EA	A.SR1	A.SR (D5114)	R/W	D1053	41053	041C			
D1004	41004	03EB	A.LC1	A.LC (D5115)	R/W	D1054	41054	041D			
D1005	41005	03EC				D1055	41055	041E			
D1006	41006	03ED				D1056	41056	041F			
D1007	41007	03EE				D1057	41057	0420			
D1008	41008	03EF				D1058	41058	0421			
D1009	41009	03F0	A.BS3	A.BS_E1 (D5133)	R/W	D1059	41059	0422			
D1010	41010	03F1	A.FL3	A.FL_E1 (D5134)	R/W	D1060	41060	0423			
D1011	41011	03F2	A.SR3	A.SR_E1 (D5135)	R/W	D1061	41061	0424			
D1012	41012	03F3	A.LC3	A.LC_E1 (D5136)	R/W	D1062	41062	0425			
D1013	41013	03F4	RET1	RTS (D5321)	R/W	D1063	41063	0426			
D1014	41014	03F5	RTH1	RTH (D5322)	R/W	D1064	41064	0427			
D1015	41015	03F6	RTL1	RTL (D5323)	R/W	D1065	41065	0428			
D1016	41016	03F7	RET2	O1RS (D5324)	R/W	D1066	41066	0429			
D1017	41017	03F8	RTH2	O1RH (D5325)	R/W	D1067	41067	042A			
D1018	41018	03F9	RTL2	O1RL (D5326)	R/W	D1068	41068	042B			
D1019	41019	03FA	DVB1 (Note 1)	DVB_L1 (D5711)	R/W	D1069	41069	042C			
D1020	41020	03FB	DVB2 (Note 1)	DVB_L2 (D5712)	R/W	D1070	41070	042D			
D1021	41021	03FC	TSC1 (Note 2)		R	D1071	41071	042E			
D1022	41022	03FD	TSC2 (Note 2)		R	D1072	41072	042F			
D1023	41023	03FE	TTM (Note 2)		R	D1073	41073	0430			
D1024	41024	03FF	▲▼	DATA-L (D5819)	R/W	D1074	41074	0431			
D1025	41025	0400	A/M (Note 1)	A/M-L (D5820)	R/W	D1075	41075	0432			
D1026	41026	0401	PT.NO (Note 2)	PTN-L (D5823)	R/W	D1076	41076	0433			
D1027	41027	0402	RUN (Note 2)	RUN-L (D5821)	R/W	D1077	41077	0434			
D1028	41028	0403	MODE (Note 2)	MODE-L (D5824)	R/W	D1078	41078	0435			
D1029	41029	0404	PRG (Note 2)		R	D1079	41079	0436			
D1030	41030	0405	LP1		R	D1080	41080	0437			
D1031	41031	0406	LP2		R	D1081	41081	0438			
D1032	41032	0407	PID		R	D1082	41082	0439			
D1033	41033	0408	USR		R	D1083	41083	043A			
D1034	41034	0409	PYS1		R	D1084	41084	043B			
D1035	41035	040A	PYS2		R	D1085	41085	043C			
D1036	41036	040B				D1086	41086	043D			
D1037	41037	040C	PCMD.1 (Note 1)	PCMD_L1 (D5713)	R/W	D1087	41087	043E			
D1038	41038	040D	ERJC (Note 1)	ERJC (D5111)	R/W	D1088	41088	043F			
D1039	41039	040E	PCMD.2 (Note 1)	PCMD_L2 (D5716)	R/W	D1089	41089	0440			
D1040	41040	040F				D1090	41090	0441			
D1041	41041	0410				D1091	41091	0442			
D1042	41042	0411				D1092	41092	0443			
D1043	41043	0412				D1093	41093	0444			
D1044	41044	0413				D1094	41094	0445			
D1045	41045	0414				D1095	41095	0446			
D1046	41046	0415				D1096	41096	0447			
D1047	41047	0416				D1097	41097	0448			
D1048	41048	0417				D1098	41098	0449			
D1049	41049	0418				D1099	41099	044A			
D1050	41050	0419				D1100	41100	044B			

(Note1): Not for UP550.

(Note 2): For UP550.

6.6.11 Display and Input / Output Parameters (D1101 to D1200)

Configuration map for GREEN Series											
Display and input / Output parameters											
D-Reg No.	Ref. No.	H No.	Register symbol for GREEN	Register symbol for UTAdvanced	R/W	D-Reg No.	Ref. No.	H No.	Register symbol for GREEN	Register symbol for UTAdvanced	R/W
D1101	41101	044C	C.S1		R/W	D1151	41151	047E	ADV (Note 2)		R
D1102	41102	044D	C.S2		R/W	D1152	41152	047F	A/M.1 (Note 2)		R
D1103	41103	044E	C.S3		R/W	D1153	41153	0480	A/M.2 (Note 2)		R
D1104	41104	044F	C.S4		R/W	D1154	41154	0481	LSP/CAS (Note 2)		R
D1105	41105	0450	C.S5		R/W	D1155	41155	0482	PTNO.b0 (Note 2)		R
D1106	41106	0451	DO1		R/W	D1156	41156	0483	PTNO.b1 (Note 2)		R
D1107	41107	0452	DO2		R/W	D1157	41157	0484	PTNO.b2 (Note 2)		R
D1108	41108	0453	DO3		R/W	D1158	41158	0485	PTNO.b3 (Note 2)		R
D1109	41109	0454	DO4		R	D1159	41159	0486	PTNO.b4 (Note 2)		R
D1110	41110	0455	DO5		R	D1160	41160	0487	PTNO.b5 (Note 2)		R
D1111	41111	0456	DO6		R	D1161	41161	0488	PTNO.b6 (Note 2)		R
D1112	41112	0457	DO7		R	D1162	41162	0489	PTNO.b7 (Note 2)		R
D1113	41113	0458				D1163	41163	048A	PTNO.b8 (Note 2)		R
D1114	41114	0459				D1164	41164	048B	DP1 (Note 2)		R
D1115	41115	045A				D1165	41165	048C	DP2 (Note 2)		R
D1116	41116	045B				D1166	41166	048D	MG1 (Note 2)		R
D1117	41117	045C				D1167	41167	048E	MG2 (Note 2)		R
D1118	41118	045D				D1168	41168	048F	MG3 (Note 2)		R
D1119	41119	045E				D1169	41169	0490	MG4 (Note 2)		R
D1120	41120	045F				D1170	41170	0491	PYA1 (Note 2)		R
D1121	41121	0460				D1171	41171	0492	PYB1 (Note 2)		R
D1122	41122	0461				D1172	41172	0493	PYA2 (Note 2)		R
D1123	41123	0462				D1173	41173	0494	PYB2 (Note 2)		R
D1124	41124	0463				D1174	41174	0495	PID.b0 (Note 1)		R
D1125	41125	0464				D1175	41175	0496	PID.b1 (Note 1)		R
D1126	41126	0465				D1176	41176	0497	PID.b2 (Note 1)		R
D1127	41127	0466				D1177	41177	0498	PID.b3 (Note 1)		R
D1128	41128	0467				D1178	41178	0499	REM1 (Note 1)		R
D1129	41129	0468	A/M.1 (Note 1)		R/W	D1179	41179	049A			
D1130	41130	0469				D1180	41180	049B	LCL_L1 (Note 1)		R
D1131	41131	046A	R/L.1 (Note 1)		R/W	D1181	41181	049C			
D1132	41132	046B				D1182	41182	049D			
D1133	41133	046C	S/R (Note 1)		R/W	D1183	41183	049E			
D1134	41134	046D	CAS (Note 1)		R/W	D1184	41184	049F			
D1135	41135	046E	AUT (Note 1)		R/W	D1185	41185	04A0			
D1136	41136	046F	MAN (Note 1)		R/W	D1186	41186	04A1			
D1137	41137	0470	SP.b0 (Note 1)		R/W	D1187	41187	04A2			
D1138	41138	0471	SP.b1 (Note 1)		R/W	D1188	41188	04A3			
D1139	41139	0472	SP.b2 (Note 1)		R/W	D1189	41189	04A4			
D1140	41140	0473	SP.b3 (Note 1)		R/W	D1190	41190	04A5			
D1141	41141	0474				D1191	41191	04A6			
D1142	41142	0475				D1192	41192	04A7			
D1143	41143	0476				D1193	41193	04A8			
D1144	41144	0477				D1194	41194	04A9			
D1145	41145	0478				D1195	41195	04AA			
D1146	41146	0479				D1196	41196	04AB			
D1147	41147	047A	PROG (Note 2)		R	D1197	41197	04AC			
D1148	41148	047B	RESET (Note 2)		R	D1198	41198	04AD			
D1149	41149	047C	LOCAL (Note 2)		R	D1199	41199	04AE			
D1150	41150	047D	HOLD (Note 2)		R	D1200	41200	04AF			

(Note1): Not for UP550.

(Note 2): For UP550.

6.6 GREEN Series Compatible D Registers

6.6.12 Control Mode, PV Input, and Control Output Parameters (D1201 to D1300)

Configuration map for GREEN Series											
Control mmode, PV input, and Control output parameters											
D-Reg No.	Ref. No.	H No.	Register symbol for GREEN	Register symbol for UTAdvanced	R/W	D-Reg No.	Ref. No.	H No.	Register symbol for GREEN	Register symbol for UTAdvanced	R/W
D1201	41201	04B0	IN1	IN (D5101)	R/W	D1251	41251	04E2	DLN1	Depends on the conditions (Note3)	R/W
D1202	41202	04B1	UNI1	UNI (D5102)	R/W	D1252	41252	04E3	ADR1	Depends on the conditions (Note3)	R/W
D1203	41203	04B2	DP1	DP (D5103)	R	D1253	41253	04E4	RP.T1	Depends on the conditions (Note3)	R/W
D1204	41204	04B3	RH1	RH (D5104)	R/W	D1254	41254	04E5			
D1205	41205	04B4	RL1	RL (D5105)	R/W	D1255	41255	04E6			
D1206	41206	04B5	SDP1	SDP (D5106)	R/W	D1256	41256	04E7			
D1207	41207	04B6	SH1	SH (D5107)	R/W	D1257	41257	04E8			
D1208	41208	04B7	SL1	SL (D5108)	R/W	D1258	41258	04E9			
D1209	41209	04B8	BSL1	BSL (D5109)	R/W	D1259	41259	04EA			
D1210	41210	04B9	RJC1	RJC (D5110)	R/W	D1260	41260	04EB			
D1211	41211	04BA				D1261	41261	04EC	V.RS	V.RS (D5312)	R/W
D1212	41212	04BB				D1262	41262	04ED	V.L	V.L (D5313)	R
D1213	41213	04BC				D1263	41263	04EE	V.H	V.H (D5314)	R
D1214	41214	04BD				D1264	41264	04EF	TR.T	TR.T (D5315)	R/W
D1215	41215	04BE				D1265	41265	04F0	V.MOD	V.MOD (D5316)	R/W
D1216	41216	04BF				D1266	41266	04F1	INI	F.DEF (D6423)	R/W
D1217	41217	04C0				D1267	41267	04F2	V.AT	V.AT (D5311)	R/W
D1218	41218	04C1				D1268	41268	04F3	A1H	OU.H (D5331)	R/W
D1219	41219	04C2				D1269	41269	04F4	A1L	OU.L (D5332)	R/W
D1220	41220	04C3				D1270	41270	04F5	A2H	OU2.H (D5333)	R/W
D1221	41221	04C4	IN3	IN_E1 (D5121)	R/W	D1271	41271	04F6	A2L	OU2.L (D5334)	R/W
D1222	41222	04C5	UNI3	UNI_E1 (D5122)	R/W	D1272	41272	04F7	A3H	RET.H (D5335)	R/W
D1223	41223	04C6	DP3	DP_E1 (D5123)	R	D1273	41273	04F8	A3L	RET.L (D5336)	R/W
D1224	41224	04C7	RH3	RH_E1 (D5124)	R/W	D1274	41274	04F9			
D1225	41225	04C8	RL3	RL_E1 (D5125)	R/W	D1275	41275	04FA			
D1226	41226	04C9	SDP3	SDP_E1 (D5126)	R/W	D1276	41276	04FB			
D1227	41227	04CA	SH3	SH_E1 (D5127)	R/W	D1277	41277	04FC			
D1228	41228	04CB	SL3	SL_E1 (D5128)	R/W	D1278	41278	04FD			
D1229	41229	04CC	BSL3	BSL_E1 (5129)	R/W	D1279	41279	04FE			
D1230	41230	04CD	PUNI1	P.UNI_L1 (D5201)	R/W	D1280	41280	04FF	UTM (Note 2)	CTLM (D5001)	R/W
D1231	41231	04CE	PDP1	P.DP_L1 (D5202)	R/W	D1281	41281	0500	SMP	SMP (D5019)	R/W
D1232	41232	04CF	PRH1	P.RH_L1 (D5203)	R/W	D1282	41282	0501			
D1233	41233	04D0	PRL1	P.RL_L1 (D5204)	R/W	D1283	41283	0502			
D1234	41234	04D1	PUNI2	P.UNI_L2 (D5221)	R/W	D1284	41284	0503			
D1235	41235	04D2	PDP2	P.DP_L2 (D5222)	R/W	D1285	41285	0504			
D1236	41236	04D3	PRH2	P.RH_L2 (D5223)	R/W	D1286	41286	0505			
D1237	41237	04D4	PRL2	P.RL_L2 (D5224)	R/W	D1287	41287	0506			
D1238	41238	04D5	OT1		R	D1288	41288	0507			
D1239	41239	04D6	OT2		R	D1289	41289	0508			
D1240	41240	04D7	CT1	CT (D5303)	R/W	D1290	41290	0509			
D1241	41241	04D8	CT2 (Note 1)		R	D1291	41291	050A			
D1242	41242	04D9	CTc1	CTc (D5304)	R/W	D1292	41292	050B			
D1243	41243	04DA	CTc2 (Note 1)		R	D1293	41293	050C			
D1244	41244	04DB	AO1	OU.A (D5341)	R/W	D1294	41294	050D			
D1245	41245	04DC	AO2	OU2.A (D5342)	R/W	D1295	41295	050E			
D1246	41246	04DD	AO3	RET.A (D5343)	R/W	D1296	41296	050F			
D1247	41247	04DE	PSL1	Depends on the conditions (Note3)	R/W	D1297	41297	0510			
D1248	41248	04DF	BPS1	Depends on the conditions (Note3)	R/W	D1298	41298	0511			
D1249	41249	04E0	PRI1	Depends on the conditions (Note3)	R/W	D1299	41299	0512			
D1250	41250	04E1	STP1	Depends on the conditions (Note3)	R/W	D1300	41300	0513			

(Note 1): For UP550.

(Note 2): When UP550, register symbol is "UPM".

(Note 3): See the 6.6.15 D Registers Differing Depending on Conditions D1301 to D2000: Free area

6.6.13 D Registers Converted for GREEN Series

● Bit Configuration of D0001: AD1.E_G (A/D converter error status for GREEN Series)

Bit	Symbol		Event
	GREEN Series	UTAdvanced	
0	AD1ERR.st	ADERR (I4065)	PV input A/D converter error
1			
2	AD3ERR.st	ADERR_E1 (I4066)	RSP input (E1-terminal area) A/D converter error
3			
4	AD1BO.st	ADBO (I4073)	PV input burnout error
5			
6	AD3BO.st	ADBO_E1 (I4074)	RSP input (E1-terminal area) burnout error
7			
8	RJC1ERR.st	RJCERR (I4070)	PV input RJC error
9			
10			
11	VLV.ATERR.st	VALV_ATERR (I4082)	Valve position automatic adjustment error
12	VLV.BOUT.st	VALVBO (I4081)	Feedback input resistor/current burnout
13 to 15			

● Bit Configuration of D0002: PV1.E_L1_G (Loop-1 PV input error status for GREEN Series)

Bit	Symbol		Event
	GREEN Series	UTAdvanced	
0	PV1ADC.st		(Not used)
1	PV1BO.st	PVBO_L1 (I4097)	Loop-1 PV input burnout error
2	RJC1ERR.st		(Not used)
3			
4	PV1+over.st	PVPOV_L1 (I4101)	Loop-1 PV input over-scale
5	PV1-over.st	PVMOV_L1 (I4102)	Loop-1 PV input under-scale
6 to 7			
8	RSP1ADC.st		(Not used)
9	RSP1BO.st	RSPBO_L1 (I4098)	Loop-1 RSP input burnout error
10 to 11			
12	C.RSP1ADC.st		(Not used)
13	C.RSP1BO.st	CRSPB_L1 (I4099)	Burnout error when the Loop-1 RSP input is used for control.
14	AT1ERR.st	ATERR_L1 (I4111)	Loop-1 auto-tuning timeout error
15			

6.6 GREEN Series Compatible D Registers

● **Bit Configuration of D0008: MOD_L1_G (Loop-1 operation mode status for GREEN Series)**
UT55A/UT52A

Bit	Symbol		Event
	GREEN Series	UTAdvanced	
0	A/M1.st	A.M (I4193)	0: AUTO, 1: MAN *1
1	R/L1.st	R.L_L1 (I4194)	0: Local, 1: Remote
2	R/S1.st	S.R (I4195)	0: Run, 1: Stop
3			
4	CAS.st	CAS_ON (I4197)	1: CAS *2
5	AUT.st	AUTO_ON (I4198)	1: AUTO *2
6	MAN.st	MAN_ON (I4199)	1: MAN *2
7 to 13			
14	AT1.st	AT_L1_ON (I4207)	0: Auto-tuning is OFF, 1: Auto-tuning is ON
15			

*1: Effective for the control modes except for cascade control and cascade secondary-loop control.

*2: Effective for cascade control mode and cascade secondary-loop control mode.

UP55A

Bit	Symbol		Event
	GREEN Series	UTAdvanced	
0	A/M1.st	A.M_L1 (I4177)	0: AUTO, 1: MAN *1
1 to 7			
8	RESET.st	RST_ON (I4181)	1: Program reset
9	PROG.st	PRG_ON (I4182)	1: Program operation
10	LOCAL.st	LOC_ON (I4183)	1: Local operation
11			
12	HOLD.st	HOLD_ON (I4189)	1: Pause
13	WAIT.st	WAITF (I4190)	1: Wait
14	AT1.st	AT_L1 (I4191)	0: Auto-tuning is OFF, 1: Auto-tuning is ON
15			

*1: Effective for the control modes except for cascade control.

● **Bit Configuration of D0011: ALM_G (Alarm status for GREEN Series)**

Bit	Symbol		Event
	GREEN Series	UTAdvanced	
0	ALM11.st	ALM1_L1 (I4321)	'1' when Loop-1 alarm 1 is ON; '0' when OFF
1	ALM12.st	ALM2_L1 (I4322)	'1' when Loop-1 alarm 2 is ON; '0' when OFF
2	ALM13.st	ALM3_L1 (I4323)	'1' when Loop-1 alarm 3 is ON; '0' when OFF
3			
4	ALM14.st	ALM4_L1 (I4325)	'1' when Loop-1 alarm 4 is ON; '0' when OFF
5	OR1.st		(Not used)
6 to 7			
8	ALM21.st	ALM1_L2 (I4337)	'1' when Loop-1 alarm 1 is ON; '0' when OFF
9	ALM22.st	ALM2_L2 (I4338)	'1' when Loop-1 alarm 2 is ON; '0' when OFF
10	ALM23.st	ALM3_L2 (I4339)	'1' when Loop-1 alarm 3 is ON; '0' when OFF
11			
12	ALM24.st	ALM4_L2 (I4341)	'1' when Loop-1 alarm 4 is ON; '0' when OFF
13	OR2.st		(Not used)
14 to 15			

● **Bit Configuration of D0018: PV1.E_L2_G (Loop-2 PV input error status for GREEN Series)**

UT55A/UT52A

Bit	Symbol		Event
	GREEN Series	UTAdvanced	
0	PV2ADC.st		(Not used)
1	PV2BO.st	PVBO_L2 (I4113)	Loop-2 PV input burnout error
2	RJC2ERR.st		(Not used)
3			
4	PV2+over.st	PVPOV_L2 (I4117)	Loop-2 PV input over-scale
5	PV2-over.st	PVMOV_L2 (I4118)	Loop-2 PV input under-scale
6 to 7			
8	RSP2ADC.st		(Not used)
9	RSP2BO.st	RSPBO_L2 (I4114)	Loop-2 RSP input burnout error
10 to 11			
12	C.RSP2ADC.st		(Not used)
13	C.RSP2BO.st	CRSPB_L2 (I4115)	Burnout error when the Loop-2 RSP input is used for control.
14	AT2ERR.st	ATERR_L2 (I4127)	Loop-2 auto-tuning timeout error
15			

UP55A

Bit	Symbol		Event
	GREEN Series	UTAdvanced	
0	PV2ADC.st		(Not used)
1	PV2BO.st	PVBO_L2 (I4113)	Loop-2 PV input burnout error
2	RJC2ERR.st		(Not used)
3			
4	PV2+over.st	PVPOV_L2 (I4117)	Loop-2 PV input over-scale
5	PV2-over.st	PVMOV_L2 (I4118)	Loop-2 PV input under-scale
6 to 13			
14	AT2ERR.st	ATERR_L2 (I4127)	Loop-2 auto-tuning timeout error
15			

● **Bit Configuration of D0024: MOD_L2_G (Loop-2 operation mode status for GREEN Series)**

UT55A/UT52A

Bit	Symbol		Event
	GREEN Series	UTAdvanced	
0 to 13			
14	AT2.st	AT_L2_ON (I4239)	0: Auto-tuning is OFF, 1: Auto-tuning is ON
15			

UP55A

Bit	Symbol		Event
	GREEN Series	UTAdvanced	
0	A/M2.st	A.M (I4225)	0: AUTO, 1: MAN *1
1 to 7			
8	CAS/LSP.st	CL_L2 (I4233)	0: CAS (cascade); 1: LSP (local) *1
14	AT2.st	AT_L2_ON (I4239)	0: Auto-tuning is OFF; 1: Auto-tuning is ON
15			

*1 : Used when the controller mode (UP mode) is cascade control.

6.6 GREEN Series Compatible D Registers

● Bit Configuration of D0035: PA.ER_G (Parameter error status for GREEN Series)

Bit	Symbol		Event
	GREEN Series	UTAdvanced	
0	CALB.E.st	CALB_ERR (I4002)	Calibration value error
1 to 3			
4	UTMD.st	SETPA_ERR (I4005)	Setup parameter error
5	RANGE.st	SETPA_ERR (I4005)	Setup parameter error
6	SETUP.st	SETPA_ERR (I4005)	Setup parameter error
7			
8	PARA.E.st	OPEPA_ERR (I4006)	Operation parameter error
9	MODE.E.st	CTLPA_ERR (I4011)	Control parameter error
10	FILE.st *1	PROG_ERR (I4007)	Program pattern error
11			
12	EEP.E.st	FRAM_ERR (I4009)	Faulty FRAM
13			
14	SYSTEM.E.st	SYSTEM_ERR (I4001)	System data error
15			

*1: For UP550.

● Bit Configuration of D0036: ALO_G (Alarm-1 to alarm-4 output status for GREEN Series)

Bit	Symbol		Event
	GREEN Series	UTAdvanced	
0	ALO11	ALO1_L1 (I4353)	Output status where Loop-1 alarm output 1 is assigned. 0: When the alarm is turned off (alarm type: energized), or the alarm is turned on (alarm type: de-energized). (The relay contact is open.) 1: When the alarm is turned on (alarm type: energized), or the alarm is turned off (alarm type: de-energized). (The relay contact is closed.)
1	ALO12	ALO2_L1 (I4354)	Output status where Loop-1 alarm output 2 is assigned. For bit information, same as bit 0.
2	ALO13	ALO3_L1 (I4355)	Output status where Loop-1 alarm output 3 is assigned. For bit information, same as bit 0.
3			
4	ALO14	ALO4_L1 (I4357)	Output status where Loop-1 alarm output 4 is assigned. For bit information, same as bit 0.
5 to 7			
8	ALO21	ALO1_L2 (I4369)	Output status where Loop-2 alarm output 1 is assigned. For bit information, same as bit 0.
9	ALO22	ALO2_L2 (I4370)	Output status where Loop-2 alarm output 2 is assigned. For bit information, same as bit 0
10	ALO23	ALO3_L2 (I4371)	Output status where Loop-2 alarm output 3 is assigned. For bit information, same as bit 0
11			
12	ALO24	ALO4_L2 (I4373)	Output status where Loop-2 alarm output 4 is assigned. For bit information, same as bit 0
13 to 15			

● D0225: PID_G (PID number for GREEN Series)

Register No.	Symbol		Event																
	GREEN Series	UTAdvanced																	
D0225	PNO	PID_G	<p>Write: If ZON = 3 (SP group number selection 2), then the value written to PID_G is written to PIDN_L1_1 through PIDN_L1_8 and PIDN_L2_1 through PIDN_L2_8, depending on the PIDG setting (number of PID groups).</p> <table border="0"> <tr> <td>PIDN_L1_1 (D2503)</td> <td>PIDN_L2_1 (D3603)</td> </tr> <tr> <td>PIDN_L1_2 (D2523)</td> <td>PIDN_L2_2 (D3623)</td> </tr> <tr> <td>PIDN_L1_3 (D2543)</td> <td>PIDN_L2_3 (D3643)</td> </tr> <tr> <td>PIDN_L1_4 (D2563)</td> <td>PIDN_L2_4 (D3663)</td> </tr> <tr> <td>PIDN_L1_5 (D2583)</td> <td>PIDN_L2_5 (D3683)</td> </tr> <tr> <td>PIDN_L1_6 (D2603)</td> <td>PIDN_L2_6 (D3703)</td> </tr> <tr> <td>PIDN_L1_7 (D2623)</td> <td>PIDN_L2_7 (D3723)</td> </tr> <tr> <td>PIDN_L1_8 (D2643)</td> <td>PIDN_L2_8 (D3743)</td> </tr> </table> <p>Note 1: If ZON ≠ 3, or if the PID number is selected by an external contact, then writing is disabled. Note 2: When the same value as the current value is written to PID_G, the action to write PIDN_L1_1 through PIDN_L1_8 and PIDN_L2_1 through PIDN_L2_8 is performed again. At this time, if different values are set in PIDN_L1_1 through PIDN_L1_8 and PIDN_L2_1 through PIDN_L2_8, they are overwritten by the same value.</p> <p>Read: Read: PID_L1 (D0009). Reads the PID number of the PID currently used.</p>	PIDN_L1_1 (D2503)	PIDN_L2_1 (D3603)	PIDN_L1_2 (D2523)	PIDN_L2_2 (D3623)	PIDN_L1_3 (D2543)	PIDN_L2_3 (D3643)	PIDN_L1_4 (D2563)	PIDN_L2_4 (D3663)	PIDN_L1_5 (D2583)	PIDN_L2_5 (D3683)	PIDN_L1_6 (D2603)	PIDN_L2_6 (D3703)	PIDN_L1_7 (D2623)	PIDN_L2_7 (D3723)	PIDN_L1_8 (D2643)	PIDN_L2_8 (D3743)
PIDN_L1_1 (D2503)	PIDN_L2_1 (D3603)																		
PIDN_L1_2 (D2523)	PIDN_L2_2 (D3623)																		
PIDN_L1_3 (D2543)	PIDN_L2_3 (D3643)																		
PIDN_L1_4 (D2563)	PIDN_L2_4 (D3663)																		
PIDN_L1_5 (D2583)	PIDN_L2_5 (D3683)																		
PIDN_L1_6 (D2603)	PIDN_L2_6 (D3703)																		
PIDN_L1_7 (D2623)	PIDN_L2_7 (D3723)																		
PIDN_L1_8 (D2643)	PIDN_L2_8 (D3743)																		

● D0231: A1_G (Alarm-1 setpoint for GREEN Series) (For UT400 Series)

Register No.	Symbol		Event
	GREEN Series	UTAdvanced	
D0231	A1	A1_G	<p>-19999 to 30000 (Set a value within the input range.)</p> <p>Write: The value written in A1_G will be written in the register of A1_L1_1 to A1_L1_4. A1_L1_1 (D2504) A1_L1_2 (D2524) A1_L1_3 (D2544) A1_L1_4 (D2564)</p> <p>Note: When the same value as the current value is written to A1_G, the action to write A1_L1_1 through A1_L1_4 is performed again. At this time, if different values are set in A1_L1_1 through A1_L1_4, they are overwritten by the same value.</p> <p>Read: The alarm-1 setpoint of the group number being selected in CSPNO.(D0210).</p>

● D0232: A2_G (Alarm-2 setpoint for GREEN Series) (For UT400 Series)

Register No.	Symbol		Event
	GREEN Series	UTAdvanced	
D0232	A2	A2_G	<p>-19999 to 30000 (Set a value within the input range.)</p> <p>Write: The value written in A2_G will be written in the register of A2_L1_1 to A2_L1_4. A2_L1_1 (D2505) A2_L1_2 (D2525) A2_L1_3 (D2545) A2_L1_4 (D2565)</p> <p>Note: When the same value as the current value is written to A2_G, the action to write A2_L1_1 through A2_L1_4 is performed again. At this time, if different values are set in A2_L1_1 through A2_L1_4, they are overwritten by the same value.</p> <p>Read: The alarm-2 setpoint of the group number being selected in CSPNO.(D0210).</p>

● D0233: A3_G (Alarm-3 setpoint for GREEN Series) (For UT400 Series)

Register No.	Symbol		Event
	GREEN Series	UTAdvanced	
D0233	A3	A3_G	<p>-19999 to 30000 (Set a value within the input range.)</p> <p>Write: The value written in A3_G will be written in the register of A3_L1_1 to A3_L1_4. A3_L1_1 (D2506) A3_L1_2 (D2526) A3_L1_3 (D2546) A3_L1_4 (D2566)</p> <p>Note: When the same value as the current value is written to A3_G, the action to write A3_L1_1 through A3_L1_4 is performed again. At this time, if different values are set in A3_L1_1 through A3_L1_4, they are overwritten by the same value.</p> <p>Read: The alarm-3 setpoint of the group number being selected in CSPNO.(D0210).</p>

● D0234: A4_G (Alarm-4 setpoint for GREEN Series) (For UT400 Series)

Register No.	Symbol		Event
	GREEN Series	UTAdvanced	
D0234	A4	A4_G	<p>-19999 to 30000 (Set a value within the input range.)</p> <p>Write: The value written in A4_G will be written in the register of A4_L1_1 to A4_L1_4. A4_L1_1 (D2507) A4_L1_2 (D2527) A4_L1_3 (D2547) A4_L1_4 (D2567)</p> <p>Note: When the same value as the current value is written to A4_G, the action to write A4_L1_1 through A4_L1_4 is performed again. At this time, if different values are set in A4_L1_1 through A4_L1_4, they are overwritten by the same value.</p> <p>Read: The alarm-4 setpoint of the group number being selected in CSPNO.(D0210).</p>

6.6.14 D Registers Differing in Content from GREEN Series

● Bit Configuration of D0033: DI00 (DI1 to DI3 terminal status)

Bit	Symbol		Event
	GREEN Series	UTAdvanced	
0	DI1.st	DI1	0: OFF 1: ON
1	DI2.st	DI2	0: OFF 1: ON
2	DI3.st	DI3	0: OFF 1: ON
3	DI4.st		(Not used)
4	DI5.st		(Not used)
5	DI6.st		(Not used)
6	DI7.st		(Not used)
7	DI8.st		(Not used)
8 to 15			

● D0208 : MODE (Operation mode) (for UP550)

UTAdvanced

Register No.	Description		Range and meaning of value
D0208	MODE	Operation mode	0: RESET (Start of program operation) 1: PROG (Stop of program operation) 2: LOCAL (Start of local-mode operation) 3: REM (Start of remote-mode operation)

GREEN Series

Register No.	Description		Range and meaning of value
D0208	P/R/L	Operation mode	0: RET (Program operation is reset.) 1: PRG (Program operation) 2: LOC (Local operation)

● **D0302 to D0480: A1_L1_1 to A4_L1_8 (Loop-1 Alarm-1 setpoint to Alarm-8 setpoint of Groups 1 to 4) (For UT500 Series)**

When the Loop-1 Alarm-1 setpoint to Alarm-4 setpoint (D0915: AL1.1, D0916: AL2.1, D0917: AL3.1, D0918: AL4.1) are the following values (Deviation low limit alarm), the sign of the alarm setpoint is reversed and is set to UTAdvanced.

AL1.1, AL2.1, AL3.1, AL4.1 = 4, 6, 14, 16, 34, 36, 44, 46

- 4: Deviation low limit (energized, no stand-by action)
- 6: Deviation low limit (de-energized, no stand-by action)
- 14: Deviation low limit (energized, with stand-by action)
- 16: Deviation low limit (de-energized, with stand-by action)
- 34: Deviation low limit for target setpoint (energized, no stand-by action) *
- 36: Deviation low limit for target setpoint (de-energized, no stand-by action) *
- 44: Deviation low limit for target setpoint (energized, with stand-by action) *
- 46: Deviation low limit for target setpoint (de-energized, with stand-by action) *

*: For UT551 only

(If the setting value is other than the above, the alarm setpoint is not changed.)

Loop-1 Alarm-1 setpoint to Alarm-8 setpoint of Groups 1

When D0915 (AL1.1) = 4, 6, 14, 16, 34, 44, 36, 46

	Symbol		Event
	GREEN Series	UTAdvanced	
D0302	1.A1	A1_L1_1 (D2504)	The sign of the alarm setpoint is reversed and is set to UTAdvanced. (Example: 1.A1=10 → 1.A1=-10)
D0327	2.A1	A1_L1_2 (D2524)	
D0352	3.A1	A1_L1_3 (D2544)	
D0377	4.A1	A1_L1_4 (D2564)	
D0402	5.A1	A1_L1_5 (D2584)	
D0427	6.A1	A1_L1_6 (D2604)	
D0452	7.A1	A1_L1_7 (D2624)	
D0477	8.A1	A1_L1_8 (D2644)	

Loop-1 Alarm-1 setpoint to Alarm-8 setpoint of Groups 2

When D0916 (AL2.1) = 4, 6, 14, 16, 34, 44, 36, 46

	Symbol		Event
	GREEN Series	UTAdvanced	
D0303	1.A2	A2_L1_1 (D2505)	The sign of the alarm setpoint is reversed and is set to UTAdvanced. (Example: 1.A2=10 → 1.A2=-10)
D0328	2.A2	A2_L1_2 (D2525)	
D0353	3.A2	A2_L1_3 (D2545)	
D0378	4.A2	A2_L1_4 (D2565)	
D0403	5.A2	A2_L1_5 (D2585)	
D0428	6.A2	A2_L1_6 (D2605)	
D0453	7.A2	A2_L1_7 (D2625)	
D0478	8.A2	A2_L1_8 (D2645)	

Loop-1 Alarm-1 setpoint to Alarm-8 setpoint of Groups 3

When D0917 (AL3.1) = 4, 6, 14, 16, 34, 44, 36, 46

	Symbol		Event
	GREEN Series	UTAdvanced	
D0304	1.A3	A3_L1_1 (D2506)	The sign of the alarm setpoint is reversed and is set to UTAdvanced. (Example: 1.A3=10 → 1.A3=-10)
D0329	2.A3	A3_L1_2 (D2526)	
D0354	3.A3	A3_L1_3 (D2546)	
D0379	4.A3	A3_L1_4 (D2566)	
D0404	5.A3	A3_L1_5 (D2586)	
D0429	6.A3	A3_L1_6 (D2606)	
D0454	7.A3	A3_L1_7 (D2626)	
D0479	8.A3	A3_L1_8 (D2646)	

6.6 GREEN Series Compatible D Registers

Loop-1 Alarm-1 setpoint to Alarm-8 setpoint of Groups 4

When D0918 (AL4.1) = 4, 6, 14, 16, 34, 44, 36, 46

	Symbol		Event
	GREEN Series	UTAdvanced	
D0305	1.A4	A4_L1_1 (D2507)	The sign of the alarm setpoint is reversed and is set to UTAdvanced. (Example: 1.A4=10 → 1.A4=-10)
D0330	2.A4	A4_L1_2 (D2527)	
D0355	3.A4	A4_L1_3 (D2547)	
D0380	4.A4	A4_L1_4 (D2567)	
D0405	5.A4	A4_L1_5 (D2587)	
D0430	6.A4	A4_L1_6 (D2607)	
D0455	7.A4	A4_L1_7 (D2627)	
D0480	8.A4	A4_L1_8 (D2647)	

● D0502 to D0680: A1_L2_1 to A4_L2_8 (Loop-2 Alarm-1 setpoint to Alarm-8 setpoint of Groups 1 to 4) (For UT500 Series)

When the Loop-2 Alarm-1 setpoint to Alarm-4 setpoint (D0955: AL1.2, D0956: AL2.2, D0957: AL3.2, D0958: AL4.2) are the following values (Deviation low limit alarm), the sign of the alarm setpoint is reversed and is set to UTAdvanced.

AL1.2, AL2.2, AL3.2, AL4.2 = 4, 6, 14, 16, 34, 36, 44, 46

(For 4 to 46, refer to "●D0302 to D0480: A1_L1_1 to A4_L1_8" in the previous section.)

(If the setting value is other than the above, the alarm setpoint is not changed.)

Loop-2 Alarm-1 setpoint to Alarm-8 setpoint of Groups 1

When D0955 (AL1.2) = 4, 6, 14, 16, 34, 44, 36, 46

	Symbol		Event
	GREEN Series	UTAdvanced	
D0502	1.A1	A1_L2_1 (D3604)	The sign of the alarm setpoint is reversed and is set to UTAdvanced. (Example: 1.A1=10 → 1.A1=-10)
D0527	2.A1	A1_L2_2 (D3624)	
D0552	3.A1	A1_L2_3 (D3644)	
D0577	4.A1	A1_L2_4 (D3664)	
D0602	5.A1	A1_L2_5 (D3684)	
D0627	6.A1	A1_L2_6 (D3704)	
D0652	7.A1	A1_L2_7 (D3724)	
D0677	8.A1	A1_L2_8 (D3744)	

Loop-2 Alarm-1 setpoint to Alarm-8 setpoint of Groups 2

When D0956 (AL2.2) = 4, 6, 14, 16, 34, 44, 36, 46

	Symbol		Event
	GREEN Series	UTAdvanced	
D0503	1.A2	A2_L2_1 (D3605)	The sign of the alarm setpoint is reversed and is set to UTAdvanced. (Example: 1.A2=10 → 1.A2=-10)
D0528	2.A2	A2_L2_2 (D3625)	
D0553	3.A2	A2_L2_3 (D3645)	
D0578	4.A2	A2_L2_4 (D3665)	
D0603	5.A2	A2_L2_5 (D3685)	
D0628	6.A2	A2_L2_6 (D3705)	
D0653	7.A2	A2_L2_7 (D3725)	
D0678	8.A2	A2_L2_8 (D3745)	

Loop-2 Alarm-1 setpoint to Alarm-8 setpoint of Groups 3

When D0957 (AL3.2) = 4, 6, 14, 16, 34, 44, 36, 46

	Symbol		Event
	GREEN Series	UTAdvanced	
D0504	1.A3	A3_L2_1 (D3606)	The sign of the alarm setpoint is reversed and is set to UTAdvanced. (Example: 1.A3=10 → 1.A3=-10)
D0529	2.A3	A3_L2_2 (D3626)	
D0554	3.A3	A3_L2_3 (D3646)	
D0579	4.A3	A3_L2_4 (D3666)	
D0604	5.A3	A3_L2_5 (D3686)	
D0629	6.A3	A3_L2_6 (D3706)	
D0654	7.A3	A3_L2_7 (D3726)	
D0679	8.A3	A3_L2_8 (D3746)	

Loop-2 Alarm-1 setpoint to Alarm-8 setpoint of Groups 4

When D0958 (AL4.2) = 4, 6, 14, 16, 34, 44, 36, 46

	Symbol		Event
	GREEN Series	UTAdvanced	
D0505	1.A4	A4_L2_1 (D3607)	The sign of the alarm setpoint is reversed and is set to UTAdvanced. (Example: 1.A4=10 → 1.A4=-10)
D0530	2.A4	A4_L2_2 (D3627)	
D0555	3.A4	A4_L2_3 (D3647)	
D0580	4.A4	A4_L2_4 (D3667)	
D0605	5.A4	A4_L2_5 (D3687)	
D0630	6.A4	A4_L2_6 (D3707)	
D0655	7.A4	A4_L2_7 (D3727)	
D0680	8.A4	A4_L2_8 (D3747)	

**● D0915 to D0918: Loop-1 alarm-1 type to alarm-4 type
UTAdvanced**

Register No.	Description		Range and meaning of value
D0915	AL1.T_L1	Loop-1 alarm-1 type	0: Disable 01: PV high limit 02: PV low limit 03: SP high limit 04: SP low limit 05: Deviation high limit 06: Deviation low limit 07: Deviation high and low limits 08: Deviation within high and low limits
D0916	AL2.T_L1	Loop-1 alarm-2 type	09: Target SP high limit 10: Target SP low limit 11: Target SP deviation high limit 12: Target SP deviation low limit 13: Target SP deviation high and low limits 14: Target SP deviation within high and low limits 15: OUT high limit
D0917	AL3.T_L1	Loop-1 alarm-3 type	16: OUT low limit 17: Cooling-side OUT high limit 18: Cooling-side OUT low limit 19: Analog input PV high limit 20: Analog input PV low limit 21: Analog input RSP high limit 22: Analog input RSP low limit 23: Analog input AIN2 high limit
D0918	AL4.T_L1	Loop-1 alarm-4 type	24: Analog input AIN2 low limit 25: Analog input AIN4 high limit 26: Analog input AIN4 low limit 27: Feedback input high limit 28: Feedback input low limit 29: PV velocity 30: Fault diagnosis 31: FAIL

6.6 GREEN Series Compatible D Registers

GREEN Series

Register No.	Description		Range and meaning of value
D0915	AL1.1	Loop-1 alarm-1 type	OFF (0), 1 to 20, 25 to 31, 33 to 38, 43 to 48 1: PV high limit (energized, no stand-by action) 2: PV low limit (energized, no stand-by action) 3: Deviation high limit (energized, no stand-by action) 4: Deviation low limit (energized, no stand-by action) 5: Deviation high limit (de-energized, no stand-by action) 6: Deviation low limit (de-energized, no stand-by action) For other alarm types, see "Changing Alarm Type" of GREEN series (UT551, UT550, UT520) User's manual.
D0916	AL2.1	Loop-1 alarm-2 type	OFF (0), 1 to 20, 25 to 31, 33 to 38, 43 to 48 1: PV high limit (energized, no stand-by action) 2: PV low limit (energized, no stand-by action) 3: Deviation high limit (energized, no stand-by action)
D0917	AL3.1	Loop-1 alarm-3 type	4: Deviation low limit (energized, no stand-by action) 5: Deviation high limit (de-energized, no stand-by action) 6: Deviation low limit (de-energized, no stand-by action)
D0918	AL4.1	Loop-1 alarm-4 type	For other alarm types, see "Changing Alarm Type" of GREEN series (UT551, UT550, UT520) User's manual.

● D0940: SPGR. (Number of SP groups)

UTAdvanced

Register No.	Description		Range and meaning of value
D0940	SPGR.	Number of SP groups	Set a number of SP groups to use. 1 to 8

GREEN Series

Register No.	Description		Range and meaning of value
D0940	GRP	PID group number	Allows you to determine how many groups of setpoint, alarm and PID parameters the controller should show. 1: Show one set. 2: Show two sets. 3: Show three sets. 4: Show four sets. 5 to 8: Show as many groups of parameters as have been set.

● D0955 to D0958: Loop-2 alarm-1 type to alarm-4 type
UTAdvanced

Register No.	Description		Range and meaning of value
D0955	AL1.T_L2	Loop-2 alarm-1 type	00: Disable 01: PV high limit 02: PV low limit 03: SP high limit 04: SP low limit 05: Deviation high limit 06: Deviation low limit 07: Deviation high and low limits
D0956	AL2.T_L2	Loop-2 alarm-2 type	08: Deviation within high and low limits 09: Target SP high limit 10: Target SP low limit 11: Target SP deviation high limit 12: Target SP deviation low limit 13: Target SP deviation high and low limits 14: Target SP deviation within high and low limits 15: OUT high limit
D0957	AL3.T_L2	Loop-2 alarm-2 type	16: OUT low limit 17: Cooling-side OUT high limit 18: Cooling-side OUT low limit 19: Analog input PV high limit 20: Analog input PV low limit 21: Analog input RSP high limit 22: Analog input RSP low limit 23: Analog input AIN2 high limit 24: Analog input AIN2 low limit
D0958	AL4.T_L2	Loop-2 alarm-4 type	25: Analog input AIN4 high limit 26: Analog input AIN4 low limit 27: Feedback input high limit 28: Feedback input low limit 29: PV velocity 30: Fault diagnosis 31: FAIL

GREEN Series

Register No.	Description		Range and meaning of value
D0955	AL1.1	Loop-2 alarm-1 type	OFF (0), 1 to 20, 25 to 31, 33 to 38, 43 to 48 1: PV high limit (energized, no stand-by action) 2: PV low limit (energized, no stand-by action) 3: Deviation high limit (energized, no stand-by action) 4: Deviation low limit (energized, no stand-by action) 5: Deviation high limit (de-energized, no stand-by action) 6: Deviation low limit (de-energized, no stand-by action) For other alarm types, see "Changing Alarm Type" of GREEN series (UT551, UT550, UT520) User's manual.
D0956	AL2.1	Loop-2 alarm-2 type	OFF (0), 1 to 20, 25 to 31, 33 to 38, 43 to 48 1: PV high limit (energized, no stand-by action) 2: PV low limit (energized, no stand-by action) 3: Deviation high limit (energized, no stand-by action)
D0957	AL3.1	Loop-2 alarm-3 type	4: Deviation low limit (energized, no stand-by action) 5: Deviation high limit (de-energized, no stand-by action)
D0958	AL4.1	Loop-2 alarm-4 type	6: Deviation low limit (de-energized, no stand-by action) For other alarm types, see "Changing Alarm Type" of GREEN series (UT551, UT550, UT520) User's manual.

6.6 GREEN Series Compatible D Registers

● D1266: Initialization to factory default value

UTAdvanced

Register No.	Description		Range and meaning of value
D1266	F.DEF	Initialization to factory default value	-12345: Initialization, automatically returned to "0" after initialization.

GREEN Series

Register No.	Description		Range and meaning of value
D1266	INI	Parameter initialization	0: OFF 1: ON (Initialize parameters)

● D1280: Control mode

UTAdvanced

Register No.	Description		Range and meaning of value
D1280	CTLM	Control mode	1: SGL (Single-loop control) 2: CAS1 (Cascade primary-loop control) 3: CAS2 (Cascade secondary-loop control) 4: CAS (Cascade control) 5: BUM (Loop control for backup) 6: PVSW (Loop control with PV switching) 7: PVSEL (Loop control with PV auto-selector) 8: PVHD (Loop control with PV-hold function)

GREEN Series

Register No.	Description		Range and meaning of value
D1280	UTM	Controller mode (UT mode)	1: Single-loop control 2: Cascade primary-loop control 3: Cascade secondary-loop control 4: Cascade control 5: Loop control for backup 6: Loop control with PV switching 7: Loop control with PV auto-selector 8: Loop control with PV-hold function

● D1281: PV input sampling period (control period)

UTAdvanced

Register No.	Description		Range and meaning of value
D1281	SMP	Input sampling period (control period)	0: 50 (50 ms) *1 1: 100 (100 ms) 2: 200 (200 ms)

*1: Not for UP55A.

GREEN Series

Register No.	Description		Range and meaning of value
D1281	SMP	PV sampling period setting	0: 50 (50 ms) 1: 100 (100 ms) 2: 200 (200 ms) 3: 500 (500 ms)

6.6.15 D Registers Differing Depending on Conditions

● D registers differing depending on the setting of the control type (CNT_L1)

Example: When CNT_L1 = 0, 1, 2, 5, 6, or 7, D0310 is D3005 (OL_L1_1) data.

When CNT_L1 = 3 or 4, D0310 is D3016 (OHc_L1_1) data.

Register No.	Name of GREEN	PID	ONOF	ONOF2	2P2L	H/C	S-PI	BATCH	FFPID
		PID control	ON/OFF control (1 point of hysteresis)	ON/OFF control (2 points of hysteresis)	Two-position two-level control	Heating/cooling control	Sample PI control	Batch PID control	Feedforward control
		CNT_L1: 0	CNT_L1: 1	CNT_L1: 2	CNT_L1: 3	CNT_L1: 4	CNT_L1: 5	CNT_L1: 6	CNT_L1: 7
D0310	1.OL	D3005 (OL_L1_1)			D3016 (OHc_L1_1)		D3005 (OL_L1_1)		
D0335	2.OL	D3055 (OL_L1_2)			D3066 (OHc_L1_2)		D3055 (OL_L1_2)		
D0360	3.OL	D3105 (OL_L1_3)			D3116 (OHc_L1_3)		D3105 (OL_L1_3)		
D0385	4.OL	D3155 (OL_L1_4)			D3166 (OHc_L1_4)		D3155 (OL_L1_4)		
D0410	5.OL	D3205 (OL_L1_5)			D3216 (OHc_L1_5)		D3205 (OL_L1_5)		
D0435	6.OL	D3255 (OL_L1_6)			D3266 (OHc_L1_6)		D3255 (OL_L1_6)		
D0460	7.OL	D3305 (OL_L1_7)			D3316 (OHc_L1_7)		D3305 (OL_L1_7)		
D0485	8.OL	D3355 (OL_L1_8)			D3366 (OHc_L1_8)		D3355 (OL_L1_8)		

● D registers differing depending on the setting of the control type (CNT_L2)

Example: When CNT_L2 = 0, D0510 is D4105 (OL_L2_1) data.

When CNT_L2 = 4, D0510 is D4116 (OHc_L2_1) data.

Register No.	Name of GREEN	PID	H/C
		PID control	Heating/cooling control
		CNT_L2: 0	CNT_L2: 4
D0510	1.OL	D4105 (OL_L2_1)	D4116 (OHc_L2_1)
D0535	2.OL	D4155 (OL_L2_2)	D4166 (OHc_L2_2)
D0560	3.OL	D4205 (OL_L2_3)	D4216 (OHc_L2_3)
D0585	4.OL	D4255 (OL_L2_4)	D4266 (OHc_L2_4)
D0610	5.OL	D4305 (OL_L2_5)	D4316 (OHc_L2_5)
D0635	6.OL	D4355 (OL_L2_6)	D4366 (OHc_L2_6)
D0660	7.OL	D4405 (OL_L2_7)	D4416 (OHc_L2_7)
D0685	8.OL	D4455 (OL_L2_8)	D4466 (OHc_L2_8)

● D registers differing depending on the setting of the control mode (CTLM)

Example: When CTLM = 1, 2, 3, 4, or 5, D0701 is 0.

When CTLM = 6, D0701 is PV.HL.

When CTLM = 7, D0701 is PV.AS.

Register No.	Name of GREEN	Single-loop control	Cascade primary-loop control	Cascade secondary-loop control	Cascade control	Loop control for backup	Loop control with PV switching	Loop control with PV auto-selector
		CTLM: 1	CTLM: 2	CTLM: 3	CTLM: 4	CTLM: 5	CTLM: 6	CTLM: 7
D0701	U1	0	0	0	0	0	D5205 (PV.HL)	D5208 (PV.AS)
D0702	U2	0	0	0	0	0	D5206 (PV.LL)	0
D0703	U3	0	0	0	0	0	D5207 (PV.2C)	0

Note: "0" indicates on parameter specification. In communication, "0" is returned.

6.6 GREEN Series Compatible D Registers

- **D registers differing depending on the model**

Example: For UT55A, D1247 is PSL_E4.

For UT52A, D1247 is PSL_E1.

For UP55A, D1247 is PSL_E3.

Register No.	Name of GREEN	UT55A	UT52A	UP55A
D1247	PSL1	D5531 (PSL_E4)	D5501 (PSL_E1)	D5521 (PSL_E3)
D1248	BPS1	D5532 (BPS_E4)	D5502 (BPS_E1)	D5522 (BPS_E3)
D1249	PRI1	D5533 (PRI_E4)	D5503 (PRI_E1)	D5523 (PRI_E3)
D1250	STP1	D5534 (STP_E4)	D5504 (STP_E1)	D5524 (STP_E3)
D1251	DLN1	D5535 (DLN_E4)	D5505 (DLN_E1)	D5525 (DLN_E3)
D1252	ADR1	D5536 (ADR_E4)	D5506 (ADR_E1)	D5526 (ADR_E3)
D1253	RP.T1	D5537 (RP.T_E4)	D5507 (RP.T_E1)	D5527 (RP.T_E3)

7.1 Overview

This chapter describes the functions and applications of the I relays.

I relays are used in ladder program, Modbus communication, PC link communication, and contact input / output functions.

I relays contain status information of errors, operation, and alarms. Contents of I relays can be read only by means of communication using a host computer. (Note that the I relays have the same information as the D registers but with I relays, some of the information is read-only.)

- ▶ [Contact input and output functions: Chapter 12 Contact Input and Output Functions of the UTAdvanced User's Manual](#)

Use of the I relays enables the following:

- Centralized control by the host computer

D registers and I relays on the UTAdvanced are used for parameter settings or ladder program creations of LL50A Parameter Setting Software.

7.2 Classification of I Relays

I relays are classified as shown below.

Classification of I Relay Map

I relay No.	Area and data categories	Description	
1 to 192	GREEN series (See 7.5 I Relays Corresponding to GREEN Series)	Status	Each bit information is the same as that of D register.
193 to 576		Free area	
577 to 640		SP number, PID number, Pattern number, Segment number (Note 1)	Each bit information is the same as that of D register.
641 to 720		Status	Each bit information is the same as that of D register.
721 to 2048		User area	
2049 to 4000	Free area		
4001 to 4064	Function status	System error	Each bit information is the same as that of D register.
4065 to 4128		Input error	Each bit information is the same as that of D register.
4129 to 4192		Free area	
4193 to 4256		Operation Mode	Each bit information of 4193 to 4240 is the same as that of D register. For 4241 to 4256, see the section 7.3.1.
4257 to 4320		Free area	
4321 to 4384		Alarm	Each bit information is the same as that of D register.
4385 to 4528		Alarm latch	Each bit information of 4385 to 4512 is the same as that of D register. For 4385 to 4512, see the section 7.3.1.
4529 to 4576		Heater break alarm	Each bit information is the same as that of D register.
4577 to 4704		SP number, PID number, Pattern number, Segment number (Note 1)	Each bit information is the same as that of D register. For 4673 to 4679, see the section 7.3.1.
4705 to 4768		Key	Each bit information is the same as that of D register. Note: For UP55A, see the section 7.3.1.
4769 to 4784		Display	Each bit information is the same as that of D register.
4784 to 4848		PV event status, Time event status (Note 2)	Each bit information is the same as that of D register.
4849 to 5024		Pattern number status, Segment number status (Note 2)	See the section 7.3.1.
5025 to 5152		Status for ladder program	Input (status) relay
5153 to 5280	Output (status) relay		Each bit information is the same as that of D register.
5281 to 5536	Control (status) relay		Each bit information is the same as that of D register.
5537 to 5600	Special relay		Each bit information of 5409 to 5540 is the same as that of D register. For 5441 to 5472, see the section 7.3.2.
5473 to 5536	Free area		
5537 to 5792	Internal relay		Each bit information is the same as that of D register.
5793 to 6048	Free area		
6049 to 6240	Peer-to-peer communication register		See the section 7.3.2.
6241 to 6304	Free area		

For Ladder

I relay No.	Area and data categories	Description	
6305 to 6432	Input / Output terminal status	DI terminal	Each bit information is the same as that of D register.
6433 to 6560		DO terminal	Each bit information is the same as that of D register.
6561 to 7072		Free area	

Note 1: SP numbers are for UT55A/UT52A, and Pattern numbers and Segment numbers are for UP55A.

Note 2: These are for UP55A.

CAUTION

- Check the model and suffix codes and parameter settings before writing to or read from the registers to be used.
- In the area for I relay numbers 4001 to 6560, it is prohibited to write data to I relays with blank cells in I relay map tables. If you attempt to do so, the UTAdvanced may not operate properly.

Note

- I relay numbers 4001 to 6560 store ON/OFF status information and are normally read for ON/OFF status information.

■ How to Specify I Relay Numbers

When specifying an I relay number for communication, begin the number with the character "I."

Example: Set "I4066" to specify the ADERR_E1 (I relay No.: 4066).

■ I relay symbol

- With regards to some register symbols, the loop number and terminal area are indicated by adding the underline () to the end of the parameter symbols.

□□□□_Ln Ln: Loop numbers (L1 or L2)

□□□□_En En: Terminal area (E1 to E4)

Example : **PVBO_L1** Indicates Loop-1 PVBO.

ADERR_E1 Indicates ADERR in E1-terminal area.

7.3 UT55A/UT52A/UP55A I Relays

7.3.1 Function Status (4001 to 5024)

Note

When specifying an I relay number for communication, begin the number with the character "I."
Example: Set "I4065" to specify the ADERR (I relay No.: 4065).

System error				Input error			
NO.	I relay symbol	R/W		NO.	I relay symbol	R/W	
		UT55A/UT52A	UP55A			UT55A/UT52A	UP55A
4001	SYSTEM_ERR	R		4065	ADERR	R	R
4002	CALB_ERR	R	R	4066	ADERR_E1	R	R
4003	UPARA_ERR	R	R	4067	ADERR_E2	R	R
4004				4068			
4005	SETPA_ERR	R	R	4069	ADERR_E4	R	R
4006	OPEPA_ERR	R	R	4070	RJCERR	R	R
4007	PROG_ERR		R	4071	RJCERR_E1	R	R
4008				4072			
4009	FRAM_ERR	R	R	4073	ADBO	R	R
4010				4074	ADBO_E1	R	R
4011	CTLPA_ERR	R	R	4075	ADBO_E2	R	R
4012				4076			
4013				4077	ADBO_E4	R	R
4014				4078			
4015				4079			
4016				4080			
4017	LAD_ERR	R	R	4081	VALVBO	R	R
4018	LAD_OVER	R	R	4082	VALV_ATERR	R	R
4019	LAD_P_ERR	R	R	4083			
4020				4084			
4021	LD100_OVER	R	R	4085			
4022	LD200_OVER	R	R	4086			
4023				4087			
4024				4088			
4025				4089			
4026				4090			
4027				4091			
4028				4092			
4029				4093			
4030				4094			
4031				4095			
4032				4096			
4033	E1_ERR	R	R	4097	PVBO_L1	R	R
4034	E2_ERR	R	R	4098	RSPBO_L1	R	R
4035	E3_ERR	R	R	4099	CRSPBO_L1	R	R
4036				4100			
4037	E4_ERR	R	R	4101	PVPOVER_L1	R	R
4038				4102	PVMOVER_L1	R	R
4039				4103			
4040				4104			
4041	COM_E1_ERR	R		4105			
4042				4106			
4043	COM_E3_ERR	R	R	4107			
4044				4108			
4045	COM_E4_ERR	R	R	4109			
4046				4110			
4047				4111	ATERR_L1	R	R
4048				4112			
4049				4113	PVBO_L2	R	R
4050				4114	RSPBO_L2	R	
4051				4115	CRSPBO_L2	R	
4052				4116			
4053				4117	PVPOVER_L2	R	R
4054				4118	PVMOVER_L2	R	R
4055				4119			
4056				4120			
4057				4121			
4058				4122			
4059				4123			
4060				4124			
4061				4125			
4062				4126			
4063				4127	ATERR_L2	R	R
4064				4128			

7.3 UT55A/UT52A/UP55A I Relays

Operation mode				Operation mode				Operation mode			
NO.	I relay symbol	R/W		NO.	I relay symbol	R/W		NO.	I relay symbol	R/W	
		UT55A/UT52A	UP55A			UT55A/UT52A	UP55A			UT55A/UT52A	UP55A
4129				4193	A.M *1	R/W		4257	WTEND1		R
4130				4194	R.L_L1	R/W		4258	WTEND3		R
4131				4195	S.R	R/W		4259	WTEND5		R
4132				4196				4260			
4133				4197	CAS_ON *2	R/W		4261	SEG_SYNC		R
4134				4198	AUTO_ON *2	R/W		4262			
4135				4199	MAN_ON *2	R/W		4263			
4136				4200				4264			
4137				4201	TRK_ON_L1	R/W		4265	PTEND1		R
4138				4202				4266	PTEND3		R
4139				4203				4267	PTEND5		R
4140				4204				4268			
4141				4205				4269			
4142				4206				4270			
4143				4207	AT_L1_ON	R/W		4271			
4144				4208				4272			
4145				4209	VALV_AT	R	R	4273			
4146				4210	VALV_GUSS	R	R	4274			
4147				4211				4275			
4148				4212				4276			
4149				4213	VALV_OPEN	R	R	4277			
4150				4214	VALV_CLOSE	R	R	4278			
4151				4215				4279			
4152				4216				4280			
4153				4217				4281			
4154				4218				4282			
4155				4219				4283			
4156				4220				4284			
4157				4221				4285			
4158				4222				4286			
4159				4223				4287			
4160				4224				4288			
4161				4225	A.M_L2		R/W	4289			
4162				4226	R.L_L2	R/W		4290			
4163				4227				4291			
4164				4228				4292			
4165				4229				4293			
4166				4230				4294			
4167				4231				4295			
4168				4232				4296			
4169				4233	L.C		R/W	4297			
4170				4234				4298			
4171				4235				4299			
4172				4236				4300			
4173				4237				4301			
4174				4238				4302			
4175				4239	AT_L2_ON *3	R/W	R/W	4303			
4176				4240				4304			
4177	A.M_L1		R/W	4241	C2_AMS_ON	R		4305			
4178				4242				4306			
4179				4243				4307			
4180				4244				4308			
4181	RST_ON		R/W	4245				4309			
4182	PRG_ON		R/W	4246				4310			
4183	LOC_ON		R/W	4247				4311			
4184				4248				4312			
4185	REM_ON		R/W	4249				4313			
4186	TRK_ON_L1		R/W	4250				4314			
4187	ADV_ON		R/W	4251				4315			
4188				4252				4316			
4189	HOLD_ON		R/W	4253				4317			
4190	WAITF		R/W	4254				4318			
4191	AT_L1_ON		R/W	4255				4319			
4192				4256	FAIL_ALARM	R	R	4320			

*1: Effective for the control modes except for cascade control and cascade secondary-loop control.

*2: Effective for cascade control mode and cascade secondary-loop control mode.

*3: I relay symbol of UP55A is AL_L2.

7.3 UT55A/UT52A/UP55A I Relays

Alarm				Alarm latch				Alarm latch			
NO.	I relay symbol	R/W		NO.	I relay symbol	R/W		NO.	I relay symbol	R/W	
		UT55A/UT52A	UP55A			UT55A/UT52A	UP55A			UT55A/UT52A	UP55A
4321	ALM1_L1	R	R	4385	ALO1LA1_L1	R	R	4449	ALO1LA3_L1	R	R
4322	ALM2_L1	R	R	4386	ALO2LA1_L1	R	R	4450	ALO2LA3_L1	R	R
4323	ALM3_L1	R	R	4387	ALO3LA1_L1	R	R	4451	ALO3LA3_L1	R	R
4324				4388				4452			
4325	ALM4_L1	R	R	4389	ALO4LA1_L1	R	R	4453	ALO4LA3_L1	R	R
4326	ALM5_L1	R	R	4390	ALO5LA1_L1	R	R	4454	ALO5LA3_L1	R	R
4327	ALM6_L1	R	R	4391	ALO6LA1_L1	R	R	4455	ALO6LA3_L1	R	R
4328				4392				4456			
4329	ALM7_L1	R	R	4393	ALO7LA1_L1	R	R	4457	ALO7LA3_L1	R	R
4330	ALM8_L1	R	R	4394	ALO8LA1_L1	R	R	4458	ALO8LA3_L1	R	R
4331				4395				4459			
4332				4396				4460			
4333				4397				4461			
4334				4398				4462			
4335				4399				4463			
4336				4400				4464			
4337	ALM1_L2	R	R	4401	ALO1LA1_L2	R	R	4465	ALO1LA3_L2	R	R
4338	ALM2_L2	R	R	4402	ALO2LA1_L2	R	R	4466	ALO2LA3_L2	R	R
4339	ALM3_L2	R	R	4403	ALO3LA1_L2	R	R	4467	ALO3LA3_L2	R	R
4340				4404				4468			
4341	ALM4_L2	R	R	4405	ALO4LA1_L2	R	R	4469	ALO4LA3_L2	R	R
4342	ALM5_L2	R	R	4406	ALO5LA1_L2	R	R	4470	ALO5LA3_L2	R	R
4343	ALM6_L2	R	R	4407	ALO6LA1_L2	R	R	4471	ALO6LA3_L2	R	R
4344				4408				4472			
4345	ALM7_L2	R	R	4409	ALO7LA1_L2	R	R	4473	ALO7LA3_L2	R	R
4346	ALM8_L2	R	R	4410	ALO8LA1_L2	R	R	4474	ALO8LA3_L2	R	R
4347				4411				4475			
4348				4412				4476			
4349				4413				4477			
4350				4414				4478			
4351				4415				4479			
4352				4416				4480			
4353	ALO1_L1	R	R	4417	ALO1LA2_L1	R	R	4481	ALO1LA4_L1	R	R
4354	ALO2_L1	R	R	4418	ALO2LA2_L1	R	R	4482	ALO2LA4_L1	R	R
4355	ALO3_L1	R	R	4419	ALO3LA2_L1	R	R	4483	ALO3LA4_L1	R	R
4356				4420				4484			
4357	ALO4_L1	R	R	4421	ALO4LA2_L1	R	R	4485	ALO4LA4_L1	R	R
4358	ALO5_L1	R	R	4422	ALO5LA2_L1	R	R	4486	ALO5LA4_L1	R	R
4359	ALO6_L1	R	R	4423	ALO6LA2_L1	R	R	4487	ALO6LA4_L1	R	R
4360				4424				4488			
4361	ALO7_L1	R	R	4425	ALO7LA2_L1	R	R	4489	ALO7LA4_L1	R	R
4362	ALO8_L1	R	R	4426	ALO8LA2_L1	R	R	4490	ALO8LA4_L1	R	R
4363				4427				4491			
4364				4428				4492			
4365				4429				4493			
4366				4430				4494			
4367				4431				4495			
4368				4432				4496			
4369	ALO1_L2	R	R	4433	ALO1LA2_L2	R	R	4497	ALO1LA4_L2	R	R
4370	ALO2_L2	R	R	4434	ALO2LA2_L2	R	R	4498	ALO2LA4_L2	R	R
4371	ALO3_L2	R	R	4435	ALO3LA2_L2	R	R	4499	ALO3LA4_L2	R	R
4372				4436				4500			
4373	ALO4_L2	R	R	4437	ALO4LA2_L2	R	R	4501	ALO4LA4_L2	R	R
4374	ALO5_L2	R	R	4438	ALO5LA2_L2	R	R	4502	ALO5LA4_L2	R	R
4375	ALO6_L2	R	R	4439	ALO6LA2_L2	R	R	4503	ALO6LA4_L2	R	R
4376				4440				4504			
4377	ALO7_L2	R	R	4441	ALO7LA2_L2	R	R	4505	ALO7LA4_L2	R	R
4378	ALO8_L2	R	R	4442	ALO8LA2_L2	R	R	4506	ALO8LA4_L2	R	R
4379				4443				4507			
4380				4444				4508			
4381				4445				4509			
4382				4446				4510			
4383				4447				4511			
4384				4448				4512			

7.3 UT55A/UT52A/UP55A I Relays

Alarm latch and Heater break alarm				SP number and PID number				Pattern number and Segment number			
NO.	I relay symbol	R/W		NO.	I relay symbol	R/W		NO.	I relay symbol	R/W	
		UT55A/UT52A	UP55A			UT55A/UT52A	UP55A			UT55A/UT52A	UP55A
4513	ALOLA_RLS	R/W	R/W	4577	CSPN.B0	R		4641	PTNO.B0		R
4514	ALM_WAIT	R/W	R/W	4578	CSPN.B1	R		4642	PTNO.B1		R
4515				4579	CSPN.B2	R		4643	PTNO.B2		R
4516				4580	CSPN.B3	R		4644	PTNO.B3		R
4517				4581				4645	PTNO.B4		R
4518				4582				4646			
4519				4583				4647			
4520				4584				4648			
4521				4585				4649			
4522				4586				4650			
4523				4587				4651			
4524				4588				4652			
4525				4589				4653			
4526				4590				4654			
4527				4591				4655			
4528				4592				4656			
4529	CT_AL1	R	R	4593				4657	SEGNO.B0		R
4530	CT_AL2	R	R	4594				4658	SEGNO.B1		R
4531				4595				4659	SEGNO.B2		R
4532				4596				4660	SEGNO.B3		R
4533				4597				4661	SEGNO.B4		R
4534				4598				4662	SEGNO.B5		R
4535				4599				4663	SEGNO.B6		R
4536				4600				4664			
4537				4601				4665			
4538				4602				4666			
4539				4603				4667			
4540				4604				4668			
4541				4605				4669			
4542				4606				4670			
4543				4607				4671			
4544				4608				4672			
4545				4609	PIDN.B0_L1	R	R	4673	RAMP_UP_L		R
4546				4610	PIDN.B1_L1	R	R	4674	SOAK_L		R
4547				4611	PIDN.B2_L1	R	R	4675	PAMP_DN_L		R
4548				4612	PIDN.B3_L1	R	R	4676			
4549				4613				4677	RAMP_UP2_L		R
4550				4614				4678	SOAK2_L		R
4551				4615				4679	RAMP_DN2_L		R
4552				4616				4680			R
4553				4617				4681			
4554				4618				4682			
4555				4619				4683			
4556				4620				4684			
4557				4621				4685			
4558				4622				4686			
4559				4623				4687			
4560				4624				4688			
4561				4625	PIDN.B0_L2	R	R	4689			
4562				4626	PIDN.B1_L2	R	R	4690			
4563				4627	PIDN.B2_L2	R	R	4691			
4564				4628	PIDN.B3_L2	R	R	4692			
4565				4629				4693			
4566				4630				4694			
4567				4631				4695			
4568				4632				4696			
4569				4633				4697			
4570				4634				4698			
4571				4635				4699			
4572				4636				4700			
4573				4637				4701			
4574				4638				4702			
4575				4639				4703			
4576				4640				4704			

Key				Display, PV event status and Time event status			
NO.	I relay symbol	R/W		NO.	I relay symbol	R/W	
		UT55A/UT52A	UP55A			UT55A/UT52A	UP55A
4705	PARA_KEY	R		4769	MG1.B	R	R
4706	DISP_KEY	R	R	4770	MG2.B	R	R
4707	RIGHT_KEY	R	R	4771	MG3.B	R	R
4708	DOWN_KEY	R	R	4772			
4709	SET_KEY	R	R	4773	MG4.B	R	R
4710	UP_KEY	R	R	4774			
4711	LEFT_KEY	R	R	4775			
4712	F2_KEY	R		4776			
4713	F1_KEY	R		4777			
4714	A/M_KEY	R		4778			
4715	FN_KEY	R		4779	PVRW_L1	R	R
4716	PTN_KEY		R	4780	PVRW_L2	R	R
4717	RST_KEY		R	4781			
4718	MODE_KEY		R	4782			
4719	RUN_KEY		R	4783			
4720				4784			
4721				4785	PV_EV1		R
4722				4786	PV_EV2		R
4723				4787	PV_EV3		R
4724				4788			
4725				4789	PV_EV4		R
4726				4790	PV_EV5		R
4727				4791	PV_EV6		R
4728				4792			
4729				4793	PV_EV7		R
4730				4794	PV_EV8		R
4731				4795			
4732				4796			
4733				4797			
4734				4798			
4735				4799			
4736				4800			
4737				4801	PV_EV1_OUT		R
4738				4802	PV_EV2_OUT		R
4739				4803	PV_EV3_OUT		R
4740				4804			
4741				4805	PV_EV4_OUT		R
4742				4806	PV_EV5_OUT		R
4743				4807	PV_EV6_OUT		R
4744				4808			
4745				4809	PV_EV7_OUT		R
4746				4810	PV_EV8_OUT		R
4747				4811			
4748				4812			
4749				4813			
4750				4814			
4751				4815			
4752				4816			
4753				4817	TIME_EV1		R
4754				4818	TIME_EV2		R
4755				4819	TIME_EV3		R
4756				4820			
4757				4821	TIME_EV4		R
4758				4822	TIME_EV5		R
4759				4823	TIME_EV6		R
4760				4824			
4761				4825	TIME_EV7		R
4762				4826	TIME_EV8		R
4763				4827			
4764				4828			
4765				4829			
4766				4830			
4767				4831			
4768				4832			

7.3 UT55A/UT52A/UP55A I Relays

Pattern number status and Segment number status				Pattern number status and Segment number status				Pattern number status and Segment number status			
NO.	I relay symbol	R/W		NO.	I relay symbol	R/W		NO.	I relay symbol	R/W	
		UT55A/UT52A	UP55A			UT55A/UT52A	UP55A			UT55A/UT52A	UP55A
4833	TIME_EV9		R	4897	SEG1		R	4961	SEG65		R
4834	TIME_EV10		R	4898	SEG2		R	4962	SEG66		R
4835	TIME_EV11		R	4899	SEG3		R	4963	SEG67		R
4836				4900	SEG4		R	4964	SEG68		R
4837	TIME_EV12		R	4901	SEG5		R	4965	SEG69		R
4838	TIME_EV13		R	4902	SEG6		R	4966	SEG70		R
4839	TIME_EV14		R	4903	SEG7		R	4967	SEG71		R
4840				4904	SEG8		R	4968	SEG72		R
4841	TIME_EV15		R	4905	SEG9		R	4969	SEG73		R
4842	TIME_EV16		R	4906	SEG10		R	4970	SEG74		R
4843				4907	SEG11		R	4971	SEG75		R
4844				4908	SEG12		R	4972	SEG76		R
4845				4909	SEG13		R	4973	SEG77		R
4846				4910	SEG14		R	4974	SEG78		R
4847				4911	SEG15		R	4975	SEG79		R
4848				4912	SEG16		R	4976	SEG80		R
4849	PT1		R	4913	SEG17		R	4977	SEG81		R
4850	PT2		R	4914	SEG18		R	4978	SEG82		R
4851	PT3		R	4915	SEG19		R	4979	SEG83		R
4852	PT4		R	4916	SEG20		R	4980	SEG84		R
4853	PT5		R	4917	SEG21		R	4981	SEG85		R
4854	PT6		R	4918	SEG22		R	4982	SEG86		R
4855	PT7		R	4919	SEG23		R	4983	SEG87		R
4856	PT8		R	4920	SEG24		R	4984	SEG88		R
4857	PT9		R	4921	SEG25		R	4985	SEG89		R
4858	PT10		R	4922	SEG26		R	4986	SEG90		R
4859	PT11		R	4923	SEG27		R	4987	SEG91		R
4860	PT12		R	4924	SEG28		R	4988	SEG92		R
4861	PT13		R	4925	SEG29		R	4989	SEG93		R
4862	PT14		R	4926	SEG30		R	4990	SEG94		R
4863	PT15		R	4927	SEG31		R	4991	SEG95		R
4864	PT16		R	4928	SEG32		R	4992	SEG96		R
4865	PT17		R	4929	SEG33		R	4993	SEG97		R
4866	PT18		R	4930	SEG34		R	4994	SEG98		R
4867	PT19		R	4931	SEG35		R	4995	SEG99		R
4868	PT20		R	4932	SEG36		R	4996			
4869	PT21		R	4933	SEG37		R	4997			
4870	PT22		R	4934	SEG38		R	4998			
4871	PT23		R	4935	SEG39		R	4999			
4872	PT24		R	4936	SEG40		R	5000			
4873	PT25		R	4937	SEG41		R	5001			
4874	PT26		R	4938	SEG42		R	5002			
4875	PT27		R	4939	SEG43		R	5003			
4876	PT28		R	4940	SEG44		R	5004			
4877	PT29		R	4941	SEG45		R	5005			
4878	PT30		R	4942	SEG46		R	5006			
4879				4943	SEG47		R	5007			
4880				4944	SEG48		R	5008			
4881				4945	SEG49		R	5009			
4882				4946	SEG50		R	5010			
4883				4947	SEG51		R	5011			
4884				4948	SEG52		R	5012			
4885				4949	SEG53		R	5013			
4886				4950	SEG54		R	5014			
4887				4951	SEG55		R	5015			
4888				4952	SEG56		R	5016			
4889				4953	SEG57		R	5017			
4890				4954	SEG58		R	5018			
4891				4955	SEG59		R	5019			
4892				4956	SEG60		R	5020			
4893				4957	SEG61		R	5021			
4894				4958	SEG62		R	5022			
4895				4959	SEG63		R	5023			
4896				4960	SEG64		R	5024			

System Error, Input Error, and Operation Mode (4001 to 4320)

UT55A/UT52A

I relay No.	Symbol	Event	
4001 to 4016	SYSTEM_ERR to CTLPA_ERR	Parameter error status (Same as D2068)	
4017 to 4032	LAD_ERR to LD200_OVER	Ladder error status (Same as D2012)	
4033 to 4048	E1_ERR to COM_E4_ERR	Option error status (Same as D2070)	
4049 to 4064			
4065 to 4128	ADERR to ADBO	A/D converter error status 1 (Same as D2001)	
	VALVBO to VALV_ATERR	A/D converter error status 2 (Same as D2065)	
	PVBO_L1 to ATERR_L1	Loop-1 PV input error status (Same as D2002)	
	PVBO_L2 to ATERR_L2	Loop-2 PV input error status (Same as D2018)	
4129 to 4192	Free Area		
4193 to 4208	A.M_L1 to AT_L1_ON	Loop-1 operation mode status (Same as D2008)	
4209 to 4224	VALV_AT to VALV_CLOSE	Valve status (Same as D2064)	
4225 to 4240	R.L_L2 to AT_L2_ON	Loop-2 operation mode status (Same as D2024)	
4241	C2_AMS_ON	AUTO/MAN/STOP status (Cascade secondary-loop)	0: OFF 1: ON
4256	FAIL_ALARM	FAIL alarm status (For contact output. Not available for the communication or the ladder program.)	0: FAIL alarm 1: OFF (Normal)
4257 to 4320	Free area		

UP55A

I relay No.	Symbol	Event	
4001 to 4016	SYSTEM_ERR to CTLPA_ERR	Parameter error status (Same as D2068)	
4017 to 4032	LAD_ERR to LD200_OVER	Ladder error status (Same as D2012)	
4033 to 4048	E1_ERR to COM_E4_ERR	Option error status (Same as D2070)	
4049 to 4064			
4065 to 4128	ADERR to ADBO_E4	A/D converter error status 1 (Same as D2001)	
	VALVBO to VALV_ATERR	A/D converter error status 2 (Same as D2065)	
	PVBO_L1 to ATERR_L1	Loop-1 PV input error status (Same as D2002)	
	PVBO_L2 to ATERR_L2	Loop-2 PV input error status (Same as D2018)	
4129 to 476			
4177 to 4192	A.M_L1 to AT_L1_ON	Loop-1 operation mode status (Same as D2008)	
4193 to 4208			
4209 to 4224	VALV_AT to VALV_CLOSE	Valve status (Same as D2064)	
4225 to 4240	A.M_L1 to AT_L2_ON	Loop-2 operation mode status (Same as D2024)	
4241	C2_AMS_ON	AUTO/MAN/STOP status (Cascade secondary-loop)	0: OFF 1: ON
4256	FAIL_ALARM	FAIL alarm status (For contact output. Not available for the communication or the ladder program.)	0: FAIL alarm 1: OFF (Normal)
4257 to 4320	WTEND1	Wait end signal (1 second)	0: OFF 1: ON
	WTEND3	Wait end signal (3 seconds)	
	WTEND5	Wait end signal (5 seconds)	
	SEG_SYNC	Control flag for segment transition	
	PTEND1	Pattern end signal (1 second)	
	PTEND3	Pattern end signal (3 seconds)	
PTEND5	Pattern end signal (5 seconds)		
4273 to 4320			

7.3 UT55A/UT52A/UP55A I Relays

Alarm, Alarm Latch, and Heater Break Alarm (4321 to 4576)

I relay No.	Symbol	Event	
4321 to 4336	ALM1_L1~ALM8_L1	Loop-1 alarm-1 to alarm-8 status (Same as D2011)	
4337 to 4352	ALM1_L2~ALM8_L2	Loop-2 alarm-1 to alarm-8 status (Same as D2013)	
4353 to 4368	ALO1_L1 to ALO8_L1	Loop-1 alarm-1 to alarm-8 output status (Same as D2037)	
4369 to 4384	ALO1_L2 to ALO8_L2	Loop-2 alarm-1 to alarm-8 output status (Same as D2038)	
4385 to 4400	ALO1LA1_L1 to ALO8LA1_L1	Loop-1 alarm-1 to alarm-8 latch output status (Same as D2071)	
4401 to 4416	ALO1LA1_L2 to ALO8LA1_L2	Loop-2 alarm-1 to alarm-8 latch output status (Same as D2072)	
4417 to 4432	ALO1LA2_L1 to ALO8LA2_L1	Loop-1 alarm-1 to alarm-8 latch-2 output status (Same as D2073)	
4433 to 4448	ALO1LA2_L2 to ALO8LA2_L2	Loop-2 alarm-1 to alarm-8 latch-2 output status (Same as D2074)	
4449 to 4464	ALO1LA3_L1 to ALO8LA3_L1	Loop-1 alarm-1 to alarm-8 latch-3 output status (Same as D2075)	
4465 to 4480	ALO1LA3_L2 to ALO8LA3_L2	Loop-2 alarm-1 to alarm-8 latch-3 output status (Same as D2076)	
4481 to 4496	ALO1LA4_L1 to ALO8LA4_L1	Loop-1 alarm-1 to alarm-8 latch-4 output status (Same as D2077)	
4497 to 4512	ALO1LA4_L2 to ALO8LA4_L2	Loop-2 alarm-1 to alarm-8 latch-4 output status (Same as D2078)	
4513	ALOLA_RLS	Alarm latch release flag	0: OFF 1: Latch release Automatically returned to "0".
4514	ALM_WAIT	Forced stand-by alarm flag	0: OFF 1: Forced stand-by Automatically returned to "0".
4529 to 4544	CT_AL1 to CT_AL2	Heater break alarm status (Same as D2063)	
4545 to 4576			

SP Number, PID Number, Pattern Number and Segment Number (4577 to 4704)

UT55A/UT52A

I relay No.	Symbol	Event
4577 to 4592 *1	CSPN.B0 to CSPN.B3	SP number (Same as D2312)
4593 to 4608		
4609 to 4624 *1	PIDN.B0_L1 to PIDN.B3_L1	Loop-1 PID number (Same as D2009)
4625 to 4640 *1	PIDN.B0_L2 to PIDN.B3_L2	Loop-2 PID number (Same as D2025)
4641 to 4704	Free area	

*1: The information of I relays 4577 to 4592 and 4609 to 4640 is represented by 4-digit binary codes, from 0000 (0 in decimal) to 1000 (8 in decimal), which are formed by the bit combination of four I relays. The lowest-numbered I relay in each set signifies the LSB.

UP55A

I relay No.	Symbol	Event
4577 to 4608		
4609 to 4624 *1	PIDN.B0_L1 to PIDN.B3_L1	Loop-1 PID number (Same as D2009)
4625 to 4640 *1	PIDN.B0_L2 to PIDN.B3_L2	Loop-2 PID number (Same as D2025)
4641 to 4656	PTNO.B0 to PTNO.B4	Pattern number (Same as D2015)
4657 to 4672	SEGNO.B0 to SEGNO.B6	Segment number (Same as D2016)
4673	RAMP_UP_L	Ramp-up status lamp
4674	SOAK_L	Soak status lamp
4675	PAMP_DN_L	Ramp-down status lamp
4677	RAMP_UP2_L	Ramp-up status lamp (Program pattern-2 retransmission)
4678	SOAK2_L	Soak status lamp (Program pattern-2 retransmission)
4679	PAMP_DN2_L	Ramp-down status lamp (Program pattern-2 retransmission)
4689 to 4704		

*1: The information of I relays 4577 to 4592 and 4609 to 4640 is represented by 4-digit binary codes, from 0000 (0 in decimal) to 1000 (8 in decimal), which are formed by the bit combination of four I relays. The lowest-numbered I relay in each set signifies the LSB.

Key (4705 to 4768)

UT55A/UT52A

I relay No.	Symbol	Event
4705 to 4720	PARA_KEY to FN_KEY	Key status (Same as D6301)
4721 to 4768		

UP55A

I relay No.	Symbol	Event
4705 to 4720	PARA_KEY to RUN_KEY	Key status (Same as D6301)
4721 to 4768		

7.3 UT55A/UT52A/UP55A I Relays

Display, PV Event Status and Time Event Status (4769 to 5024)

UT55A/UT52A

I relay No.	Symbol	Event	
4769 to 4773	MG1.B to MG4.B	Message display interruption status (Same as D2066)	
4779	PVRW_L1	Loop-1 PV red/white switch	0: White color
4780	PVRW_L2	Loop-2 PV red/white switch	1: Red color
4758 to 4832			
4833 to 5024	Free area		

UP55A

I relay No.	Symbol	Event	
4769 to 4773	MG1.B to MG4.B	Message display interruption status (Same as D2066)	
4779	PVRW_L1	Loop-1 PV red/white switch	0: White color
4780	PVRW_L2	Loop-2 PV red/white switch	1: Red color
4785 to 4800	PV_EV1 to PV_EV8	PV event status (D2039)	
4801 to 4816	PV_EV1_OUT to PV_EV8_OUT	PV event output status (D2050)	
4817 to 4832	TIME_EV1 to TIME_EV8	Time event status 1 (D2040)	
4833 to 4848	TIME_EV9 to TIME_EV16	Time event status 2 (D2041)	

Pattern Number Status and Segment Number Status (4849 to 5024)

UP55A

I relay No.	Symbol	Event
4849 to 4864	PT1 to PT16	Pattern 1-16 running status
4865 to 4880	PT17 to PT30	Pattern 17-30 running status
4881 to 4896		
4897 to 4912	SEG1 to SEG16	Segment 1-16 running status
4913 to 4928	SEG17 to SEG32	Segment 17-32 running status
4929 to 4944	SEG33 to SEG48	Segment 33-48 running status
4945 to 4960	SEG49 to SEG64	Segment 49-64 running status
4961 to 4976	SEG65 to SEG80	Segment 65-80 running status
4977 to 4992	SEG81 to SEG96	Segment 81-96 running status
4993 to 5008	SEG97 to SEG99	Segment 97-99 running status
5009 to 5024		

7.3.2 Status for Ladder Program (5025 to 5664)

Note

When specifying an I relay number for communication, begin the number with the character "I."
Example: Set "I5025" to specify the X_D11 (I relay No.: 5025).

7.3 UT55A/UT52A/UP55A I Relays

Input (status) relay				Input (status) relay			
NO.	I relay symbol	R/W		NO.	I relay symbol	R/W	
		UT55A/UT52A	UP55A			UT55A/UT52A	UP55A
5025	X_DI1	R	R	5089	X_DI41	R	R
5026	X_DI2	R	R	5090	X_DI42	R	R
5027	X_DI3	R	R	5091	X_DI43	R	R
5028				5092	X_DI44	R	R
5029				5093	X_DI45	R	R
5030				5094	X_DI46	R	R
5031				5095			
5032				5096			
5033				5097			
5034				5098			
5035				5099			
5036				5100			
5037				5101			
5038				5102			
5039				5103			
5040				5104			
5041	X_DI11	R	R	5105			
5042	X_DI12	R	R	5106			
5043	X_DI13	R	R	5107			
5044	X_DI14	R	R	5108			
5045	X_DI15	R	R	5109			
5046	X_DI16	R	R	5110			
5047				5111			
5048				5112			
5049				5113			
5050				5114			
5051				5115			
5052				5116			
5053				5117			
5054				5118			
5055				5119			
5056				5120			
5057	X_DI21	R	R	5121			
5058	X_DI22	R	R	5122			
5059	X_DI23	R	R	5123			
5060	X_DI24	R	R	5124			
5061	X_DI25	R	R	5125			
5062	X_DI26	R	R	5126			
5063				5127			
5064				5128			
5065				5129			
5066				5130			
5067				5131			
5068				5132			
5069				5133			
5070				5134			
5071				5135			
5072				5136			
5073	X_DI31	R	R	5137			
5074	X_DI32	R	R	5138			
5075	X_DI33	R	R	5139			
5076	X_DI34	R	R	5140			
5077	X_DI35	R	R	5141			
5078				5142			
5079				5143			
5080				5144			
5081				5145			
5082				5146			
5083				5147			
5084				5148			
5085				5149			
5086				5150			
5087				5151			
5088				5152			

Output (status) relay				Output (status) relay			
NO.	I relay symbol	R/W		NO.	I relay symbol	R/W	
		UT55A/UT52A	UP55A			UT55A/UT52A	UP55A
5153	Y_AL1	R/W	R/W	5217	Y_DO41	R/W	R/W
5154	Y_AL2	R/W	R/W	5218	Y_DO42	R/W	R/W
5155	Y_AL3	R/W	R/W	5219	Y_DO43	R/W	R/W
5156				5220	Y_DO44	R/W	R/W
5157				5221	Y_DO45	R/W	R/W
5158				5222			
5159				5223			
5160				5224			
5161				5225			
5162				5226			
5163				5227			
5164				5228			
5165				5229			
5166				5230			
5167				5231			
5168				5232			
5169	Y_DO11	R/W	R/W	5233			
5170	Y_DO12	R/W	R/W	5234			
5171	Y_DO13	R/W	R/W	5235			
5172	Y_DO14	R/W	R/W	5236			
5173	Y_DO15	R/W	R/W	5237			
5174				5238			
5175				5239			
5176				5240			
5177				5241			
5178				5242			
5179				5243			
5180				5244			
5181				5245			
5182				5246			
5183				5247			
5184				5248			
5185	Y_DO21	R/W	R/W	5249			
5186	Y_DO22	R/W	R/W	5250			
5187	Y_DO23	R/W	R/W	5251			
5188	Y_DO24	R/W	R/W	5252			
5189	Y_DO25	R/W	R/W	5253			
5190				5254			
5191				5255			
5192				5256			
5193				5257			
5194				5258			
5195				5259			
5196				5260			
5197				5261			
5198				5262			
5199				5263			
5200				5264			
5201	Y_DO31	R/W	R/W	5265			
5202	Y_DO32	R/W	R/W	5266			
5203	Y_DO33	R/W	R/W	5267			
5204	Y_DO34	R/W	R/W	5268			
5205	Y_DO35	R/W	R/W	5269			
5206				5270			
5207				5271			
5208				5272			
5209				5273			
5210				5274			
5211				5275			
5212				5276			
5213				5277			
5214				5278			
5215				5279			
5216				5280			

7.3 UT55A/UT52A/UP55A I Relays

Control (status) relay				Control (status) relay			
NO.	I relay symbol	R/W		NO.	I relay symbol	R/W	
		UT55A/UT52A	UP55A			UT55A/UT52A	UP55A
5281	AL1_CTL	R	R	5345	DO41_CTL	R	R
5282	AL2_CTL	R	R	5346	DO42_CTL	R	R
5283	AL3_CTL	R	R	5347	DO43_CTL	R	R
5284				5348	DO44_CTL	R	R
5285				5349	DO45_CTL	R	R
5286				5350			
5287				5351			
5288				5352			
5289				5353			
5290				5354			
5291				5355			
5292				5356			
5293				5357			
5294				5358			
5295				5359			
5296				5360			
5297	DO11_CTL	R	R	5361			
5298	DO12_CTL	R	R	5362			
5299	DO13_CTL	R	R	5363			
5300	DO14_CTL	R	R	5364			
5301	DO15_CTL	R	R	5365			
5302				5366			
5303				5367			
5304				5368			
5305				5369			
5306				5370			
5307				5371			
5308				5372			
5309				5373			
5310				5374			
5311				5375			
5312				5376			
5313	DO21_CTL	R	R	5377			
5314	DO22_CTL	R	R	5378			
5315	DO23_CTL	R	R	5379			
5316	DO24_CTL	R	R	5380			
5317	DO25_CTL	R	R	5381			
5318				5382			
5319				5383			
5320				5384			
5321				5385			
5322				5386			
5323				5387			
5324				5388			
5325				5389			
5326				5390			
5327				5391			
5328				5392			
5329	DO31_CTL	R	R	5393			
5330	DO32_CTL	R	R	5394			
5331	DO33_CTL	R	R	5395			
5332	DO34_CTL	R	R	5396			
5333	DO35_CTL	R	R	5397			
5334				5398			
5335				5399			
5336				5400			
5337				5401			
5338				5402			
5339				5403			
5340				5404			
5341				5405			
5342				5406			
5343				5407			
5344				5408			

Special relay				Free area			
NO.	I relay symbol	R/W		NO.	I relay symbol	R/W	
		UT55A/UT52A	UP55A			UT55A/UT52A	UP55A
5409	TIM1	R	R	5473			
5410	TIM2	R	R	5474			
5411	TIM3	R	R	5475			
5412	TIM4	R	R	5476			
5413				5477			
5414				5478			
5415				5479			
5416				5480			
5417				5481			
5418				5482			
5419				5483			
5420				5484			
5421				5485			
5422				5486			
5423				5487			
5424				5488			
5425	CNT1	R	R	5489			
5426	CNT2	R	R	5490			
5427	CNT3	R	R	5491			
5428	CNT4	R	R	5492			
5429				5493			
5430				5494			
5431				5495			
5432				5496			
5433				5497			
5434				5498			
5435				5499			
5436				5500			
5437				5501			
5438				5502			
5439				5503			
5440				5504			
5441	SMPCLK	R	R	5505			
5442	CLK1	R	R	5506			
5443	CLK2	R	R	5507			
5444	CLK10	R	R	5508			
5445	CLK60	R	R	5509			
5446				5510			
5447	CLK1P	R	R	5511			
5448	CLK2P	R	R	5512			
5449	CLK10P	R	R	5513			
5450	CLK60P	R	R	5514			
5451				5515			
5452				5516			
5453				5517			
5454				5518			
5455				5519			
5456				5520			
5457	PON	R	R	5521			
5458	PLS1	R	R	5522			
5459	ZERO	R	R	5523			
5460				5524			
5461	PDLVL	R	R	5525			
5462				5526			
5463				5527			
5464				5528			
5465				5529			
5466				5530			
5467				5531			
5468				5532			
5469				5533			
5470				5534			
5471				5535			
5472				5536			

7.3 UT55A/UT52A/UP55A I Relays

Internal relay			Internal relay		
NO.	I relay symbol	R/W	NO.	I relay symbol	R/W
5537	M01	R/W	5601	M65	R/W
5538	M02	R/W	5602	M66	R/W
5539	M03	R/W	5603	M67	R/W
5540	M04	R/W	5604	M68	R/W
5541	M05	R/W	5605	M69	R/W
5542	M06	R/W	5606	M70	R/W
5543	M07	R/W	5607	M71	R/W
5544	M08	R/W	5608	M72	R/W
5545	M09	R/W	5609	M73	R/W
5546	M10	R/W	5610	M74	R/W
5547	M11	R/W	5611	M75	R/W
5548	M12	R/W	5612	M76	R/W
5549	M13	R/W	5613	M77	R/W
5550	M14	R/W	5614	M78	R/W
5551	M15	R/W	5615	M79	R/W
5552	M16	R/W	5616	M80	R/W
5553	M17	R/W	5617	M81	R/W
5554	M18	R/W	5618	M82	R/W
5555	M19	R/W	5619	M83	R/W
5556	M20	R/W	5620	M84	R/W
5557	M21	R/W	5621	M85	R/W
5558	M22	R/W	5622	M86	R/W
5559	M23	R/W	5623	M87	R/W
5560	M24	R/W	5624	M88	R/W
5561	M25	R/W	5625	M89	R/W
5562	M26	R/W	5626	M90	R/W
5563	M27	R/W	5627	M91	R/W
5564	M28	R/W	5628	M92	R/W
5565	M29	R/W	5629	M93	R/W
5566	M30	R/W	5630	M94	R/W
5567	M31	R/W	5631	M95	R/W
5568	M32	R/W	5632	M96	R/W
5569	M33	R/W	5633	M97	R/W
5570	M34	R/W	5634	M98	R/W
5571	M35	R/W	5635	M99	R/W
5572	M36	R/W	5636	M100	R/W
5573	M37	R/W	5637	M101	R/W
5574	M38	R/W	5638	M102	R/W
5575	M39	R/W	5639	M103	R/W
5576	M40	R/W	5640	M104	R/W
5577	M41	R/W	5641	M105	R/W
5578	M42	R/W	5642	M106	R/W
5579	M43	R/W	5643	M107	R/W
5580	M44	R/W	5644	M108	R/W
5581	M45	R/W	5645	M109	R/W
5582	M46	R/W	5646	M110	R/W
5583	M47	R/W	5647	M111	R/W
5584	M48	R/W	5648	M112	R/W
5585	M49	R/W	5649	M113	R/W
5586	M50	R/W	5650	M114	R/W
5587	M51	R/W	5651	M115	R/W
5588	M52	R/W	5652	M116	R/W
5589	M53	R/W	5653	M117	R/W
5590	M54	R/W	5654	M118	R/W
5591	M55	R/W	5655	M119	R/W
5592	M56	R/W	5656	M120	R/W
5593	M57	R/W	5657	M121	R/W
5594	M58	R/W	5658	M122	R/W
5595	M59	R/W	5659	M123	R/W
5596	M60	R/W	5660	M124	R/W
5597	M61	R/W	5661	M125	R/W
5598	M62	R/W	5662	M126	R/W
5599	M63	R/W	5663	M127	R/W
5600	M64	R/W	5664	M128	R/W

Internal relay				Internal relay			
NO.	I relay symbol	R/W		NO.	I relay symbol	R/W	
		UT55A/UT52A	UP55A			UT55A/UT52A	UP55A
5665	M01_B	R/W	R/W	5729	M65_B	R/W	R/W
5666	M02_B	R/W	R/W	5730	M66_B	R/W	R/W
5667	M03_B	R/W	R/W	5731	M67_B	R/W	R/W
5668	M04_B	R/W	R/W	5732	M68_B	R/W	R/W
5669	M05_B	R/W	R/W	5733	M69_B	R/W	R/W
5670	M06_B	R/W	R/W	5734	M70_B	R/W	R/W
5671	M07_B	R/W	R/W	5735	M71_B	R/W	R/W
5672	M08_B	R/W	R/W	5736	M72_B	R/W	R/W
5673	M09_B	R/W	R/W	5737	M73_B	R/W	R/W
5674	M10_B	R/W	R/W	5738	M74_B	R/W	R/W
5675	M11_B	R/W	R/W	5739	M75_B	R/W	R/W
5676	M12_B	R/W	R/W	5740	M76_B	R/W	R/W
5677	M13_B	R/W	R/W	5741	M77_B	R/W	R/W
5678	M14_B	R/W	R/W	5742	M78_B	R/W	R/W
5679	M15_B	R/W	R/W	5743	M79_B	R/W	R/W
5680	M16_B	R/W	R/W	5744	M80_B	R/W	R/W
5681	M17_B	R/W	R/W	5745	M81_B	R/W	R/W
5682	M18_B	R/W	R/W	5746	M82_B	R/W	R/W
5683	M19_B	R/W	R/W	5747	M83_B	R/W	R/W
5684	M20_B	R/W	R/W	5748	M84_B	R/W	R/W
5685	M21_B	R/W	R/W	5749	M85_B	R/W	R/W
5686	M22_B	R/W	R/W	5750	M86_B	R/W	R/W
5687	M23_B	R/W	R/W	5751	M87_B	R/W	R/W
5688	M24_B	R/W	R/W	5752	M88_B	R/W	R/W
5689	M25_B	R/W	R/W	5753	M89_B	R/W	R/W
5690	M26_B	R/W	R/W	5754	M90_B	R/W	R/W
5691	M27_B	R/W	R/W	5755	M91_B	R/W	R/W
5692	M28_B	R/W	R/W	5756	M92_B	R/W	R/W
5693	M29_B	R/W	R/W	5757	M93_B	R/W	R/W
5694	M30_B	R/W	R/W	5758	M94_B	R/W	R/W
5695	M31_B	R/W	R/W	5759	M95_B	R/W	R/W
5696	M32_B	R/W	R/W	5760	M96_B	R/W	R/W
5697	M33_B	R/W	R/W	5761	M97_B	R/W	R/W
5698	M34_B	R/W	R/W	5762	M98_B	R/W	R/W
5699	M35_B	R/W	R/W	5763	M99_B	R/W	R/W
5700	M36_B	R/W	R/W	5764	M100_B	R/W	R/W
5701	M37_B	R/W	R/W	5765	M101_B	R/W	R/W
5702	M38_B	R/W	R/W	5766	M102_B	R/W	R/W
5703	M39_B	R/W	R/W	5767	M103_B	R/W	R/W
5704	M40_B	R/W	R/W	5768	M104_B	R/W	R/W
5705	M41_B	R/W	R/W	5769	M105_B	R/W	R/W
5706	M42_B	R/W	R/W	5770	M106_B	R/W	R/W
5707	M43_B	R/W	R/W	5771	M107_B	R/W	R/W
5708	M44_B	R/W	R/W	5772	M108_B	R/W	R/W
5709	M45_B	R/W	R/W	5773	M109_B	R/W	R/W
5710	M46_B	R/W	R/W	5774	M110_B	R/W	R/W
5711	M47_B	R/W	R/W	5775	M111_B	R/W	R/W
5712	M48_B	R/W	R/W	5776	M112_B	R/W	R/W
5713	M49_B	R/W	R/W	5777	M113_B	R/W	R/W
5714	M50_B	R/W	R/W	5778	M114_B	R/W	R/W
5715	M51_B	R/W	R/W	5779	M115_B	R/W	R/W
5716	M52_B	R/W	R/W	5780	M116_B	R/W	R/W
5717	M53_B	R/W	R/W	5781	M117_B	R/W	R/W
5718	M54_B	R/W	R/W	5782	M118_B	R/W	R/W
5719	M55_B	R/W	R/W	5783	M119_B	R/W	R/W
5720	M56_B	R/W	R/W	5784	M120_B	R/W	R/W
5721	M57_B	R/W	R/W	5785	M121_B	R/W	R/W
5722	M58_B	R/W	R/W	5786	M122_B	R/W	R/W
5723	M59_B	R/W	R/W	5787	M123_B	R/W	R/W
5724	M60_B	R/W	R/W	5788	M124_B	R/W	R/W
5725	M61_B	R/W	R/W	5789	M125_B	R/W	R/W
5726	M62_B	R/W	R/W	5790	M126_B	R/W	R/W
5727	M63_B	R/W	R/W	5791	M127_B	R/W	R/W
5728	M64_B	R/W	R/W	5792	M128_B	R/W	R/W

5793 to 6048: Free area

7.3 UT55A/UT52A/UP55A I Relays

Peer-to-peer communication register				Peer-to-peer communication register			
NO.	I relay symbol	R/W		NO.	I relay symbol	R/W	
		UT55A/UT52A	UP55A			UT55A/UT52A	UP55A
6049	CF01	R	R	6113	CI01	R	R
6050	CF02	R	R	6114	CI02	R	R
6051	CF03	R	R	6115	CI03	R	R
6052	CF04	R	R	6116	CI04	R	R
6053				6117	CI05	R	R
6054				6118	CI06	R	R
6055				6119	CI07	R	R
6056				6120	CI08	R	R
6057				6121	CI09	R	R
6058				6122	CI10	R	R
6059				6123	CI11	R	R
6060				6124	CI12	R	R
6061				6125	CI13	R	R
6062				6126	CI14	R	R
6063				6127	CI15	R	R
6064				6128	CI16	R	R
6065	CE01	R	R	6129	CI17	R	R
6066	CE02	R	R	6130	CI18	R	R
6067	CE03	R	R	6131	CI19	R	R
6068	CE04	R	R	6132	CI20	R	R
6069				6133	CI21	R	R
6070				6134	CI22	R	R
6071				6135	CI23	R	R
6072				6136	CI24	R	R
6073				6137	CI25	R	R
6074				6138	CI26	R	R
6075				6139	CI27	R	R
6076				6140	CI28	R	R
6077				6141	CI29	R	R
6078				6142	CI30	R	R
6079				6143	CI31	R	R
6080				6144	CI32	R	R
6081	CTL_STOP	R *	R *	6145	CI33	R	R
6082				6146	CI34	R	R
6083				6147	CI35	R	R
6084				6148	CI36	R	R
6085				6149	CI37	R	R
6086				6150	CI38	R	R
6087				6151	CI39	R	R
6088				6152	CI40	R	R
6089				6153	CI41	R	R
6090				6154	CI42	R	R
6091				6155	CI43	R	R
6092				6156	CI44	R	R
6093				6157	CI45	R	R
6094				6158	CI46	R	R
6095				6159	CI47	R	R
6096				6160	CI48	R	R
6097				6161	CI49	R	R
6098				6162	CI50	R	R
6099				6163	CI51	R	R
6100				6164	CI52	R	R
6101				6165	CI53	R	R
6102				6166	CI54	R	R
6103				6167	CI55	R	R
6104				6168	CI56	R	R
6105				6169	CI57	R	R
6106				6170	CI58	R	R
6107				6171	CI59	R	R
6108				6172	CI60	R	R
6109				6173	CI61	R	R
6110				6174	CI62	R	R
6111				6175	CI63	R	R
6112				6176	CI64	R	R

*: R/W when the LL50A Parameter Setting Software is used.

Peer-to-peer communication register				Free area			
NO.	I relay symbol	R/W		NO.	I relay symbol	R/W	
		UT55A/UT52A	UP55A			UT55A/UT52A	UP55A
6177	CO01	R *	R *	6241			
6178	CO02	R *	R *	6242			
6179	CO03	R *	R *	6243			
6180	CO04	R *	R *	6244			
6181	CO05	R *	R *	6245			
6182	CO06	R *	R *	6246			
6183	CO07	R *	R *	6247			
6184	CO08	R *	R *	6248			
6185	CO09	R *	R *	6249			
6186	CO10	R *	R *	6250			
6187	CO11	R *	R *	6251			
6188	CO12	R *	R *	6252			
6189	CO13	R *	R *	6253			
6190	CO14	R *	R *	6254			
6191	CO15	R *	R *	6255			
6192	CO16	R *	R *	6256			
6193				6257			
6194				6258			
6195				6259			
6196				6260			
6197				6261			
6198				6262			
6199				6263			
6200				6264			
6201				6265			
6202				6266			
6203				6267			
6204				6268			
6205				6269			
6206				6270			
6207				6271			
6208				6272			
6209				6273			
6210				6274			
6211				6275			
6212				6276			
6213				6277			
6214				6278			
6215				6279			
6216				6280			
6217				6281			
6218				6282			
6219				6283			
6220				6284			
6221				6285			
6222				6286			
6223				6287			
6224				6288			
6225				6289			
6226				6290			
6227				6291			
6228				6292			
6229				6293			
6230				6294			
6231				6295			
6232				6296			
6233				6297			
6234				6298			
6235				6299			
6236				6300			
6237				6301			
6238				6302			
6239				6303			
6240				6304			

*: R/W when the LL50A Parameter Setting Software is used.

7.3 UT55A/UT52A/UP55A I Relays

Input (Status) Relay and Output (Status) Relay (5025 to 5280)

I relay No.	Symbol	Description
5025 to 5040	X_DI1 to X_DI3	DI1-DI3 status (Same as D7011)
5041 to 5056	X_DI11 to X_DI16	DI11-DI16 status (Same as D7012)
5057 to 5072	X_DI21 to X_DI26	DI21-DI26 status (Same as D7013)
5073 to 5088	X_DI31 to X_DI36	DI31-DI36 status (Same as D7014)
5089 to 5104	X_DI41 to X_DI46	DI41-DI46 status (Same as D7015)
5105 to 5152		
5153 to 5168	Y_AL1 to Y_AL3	AL1-AL3 status (Same as D7161)
5169 to 5184	Y_DO11 to Y_DO15	DO11-DO15 status (Same as D7162)
5185 to 5200	Y_DO21 to Y_DO25	DO21-DO25 status (Same as D7163)
5201 to 5216	Y_DO31 to Y_DO35	DO31-DO35 status (Same as D7164)
5217 to 5232	Y_DO41 to Y_DO45	DO41-DO45 status (Same as D7165)
5233 to 5280		

Control (Status) Relay (5281 to 5408)

I relay No.	Symbol	Description
5281 to 5296	AL1_CTL to AL3_CTL	Control AL1-AL3 status (Same as D7111)
5297 to 5312	DO11_CTL to DO15_CTL	Control DO11-DO15 status (Same as D7112)
5313 to 5328	DO21_CTL to DO25_CTL	Control DO21-DO25 status (Same as D7113)
5329 to 5344	DO31_CTL to DO35_CTL	Control DO31-DO35 status (Same as D7114)
5345 to 5360	DO41_CTL to DO45_CTL	Control DO41-DO45 status (Same as D7115)
5361 to 5408		

Special Relay (5409 to 5536)

I relay No.	Symbol	Description
5409 to 5424	TIM1 to TIM4	Time out flag (Same as D7221)
5425 to 5440	CNT1 to CNT4	Time out flag (Same as D7222)
5441	SMPCLK	Input sampling period (control period) clock
5442	CLK1	1-second clock
5443	CLK2	2-second clock
5444	CLK10	10-second clock
5445	CLK60	60-second clock
5447	CLK1P	1-second clock pulse
5448	CLK2P	2-second clock pulse
5449	CLK10P	10-second clock pulse
5450	CLK60P	60-second clock pulse
5457	PON	Power on flag 0: Power-on and initializing 1: During operation
5458	PLS1	Always ON 1: ON
5459	ZERO	Always OFF 0: OFF
5461	PDLVL	Power failure detection level *1 0: Power failure of about 5 seconds or more 1: Power failure of about less than 5 seconds
5473 to 5536	Free area	

- *1: No power failure is detected in the following cases, and the unit maintains normal operations.
- A momentary power failure of 20 ms or less in the case of 100 – 240 V AC
 - A momentary power failure of 1 ms in the case of 24 V AC/DC

Internal Relay (5537 to 5792)

I relay No.	Symbol	Description
5537 to 5664	M01 to M128	You can read/write data from/to the area via communication. (Same as D7201 to D7208) That is, you can use the area freely without affecting the control function of the UTAdvanced
5665 to 5696	M01_B to M32_B	You can read/write data from/to the area via communication. (Same as D7211 to D7212) That is, you can use the area freely without affecting the control function of the UTAdvanced
5697 to 5792	M33_B to M128_B	You can read/write data from/to the area via communication. (Same as D7213 to D7218) That is, you can use the area freely without affecting the control function of the UTAdvanced
5793 to 6048		

Peer-to-peer Communication Register (6049 to 6304)

I relay No.	Symbol	Description
6049 to 6064	CF01 to CF04	Reception timeout flag-1 for peer-to-peer communication to Reception timeout flag-4 for peer-to-peer communication 0: OFF 1: ON
6065 to 6080	CE01 to CE04	End of data reception flag-1 for peer-to-peer communication to End of data reception flag-4 for peer-to-peer communication 0: OFF 1: ON
6081	CTL_STOP	Control computation start/stop flag for peer-to-peer communication 0: Normal operation 1: Stop control computation
6097 to 6112		
6113 to 6176	CI01 to CI64	Status input relay-1 for peer-to-peer communication to Status input relay-64 for peer-to-peer communication 0: OFF 1: ON
6177 to 6192	CO01 to CO16	Status output relay-1 for peer-to-peer communication to Status output relay-16 for peer-to-peer communication 0: OFF 1: ON
6193 to 6240		
6241 to 6304	Free area	

7.3.3 Input / Output Terminal Status (6305 to 6560)

Note

When specifying an I relay number for communication, begin the number with the character "I."
Example: Set "I6305" to specify the DI1 (I relay No.: 6305).

DI terminals				DI terminals			
NO.	I relay symbol	R/W		NO.	I relay symbol	R/W	
		UT55A/UT52A	UP55A			UT55A/UT52A	UP55A
6305	DI1	R	R	6369	DI41	R	R
6306	DI2	R	R	6370	DI42	R	R
6307	DI3	R	R	6371	DI43	R	R
6308				6372	DI44	R	R
6309				6373	DI45	R	R
6310				6374	DI46	R	R
6311				6375			
6312				6376			
6313				6377			
6314				6378			
6315				6379			
6316				6380			
6317				6381			
6318				6382			
6319				6383			
6320				6384			
6321	DI11	R	R	6385			
6322	DI12	R	R	6386			
6323	DI13	R	R	6387			
6324	DI14	R	R	6388			
6325	DI15	R	R	6389			
6326	DI16	R	R	6390			
6327				6391			
6328				6392			
6329				6393			
6330				6394			
6331				6395			
6332				6396			
6333				6397			
6334				6398			
6335				6399			
6336				6400			
6337	DI21	R	R	6401			
6338	DI22	R	R	6402			
6339	DI23	R	R	6403			
6340	DI24	R	R	6404			
6341	DI25	R	R	6405			
6342	DI26	R	R	6406			
6343				6407			
6344				6408			
6345				6409			
6346				6410			
6347				6411			
6348				6412			
6349				6413			
6350				6414			
6351				6415			
6352				6416			
6353	DI31	R	R	6417			
6354	DI32	R	R	6418			
6355	DI33	R	R	6419			
6356	DI34	R	R	6420			
6357	DI35	R	R	6421			
6358				6422			
6359				6423			
6360				6424			
6361				6425			
6362				6426			
6363				6427			
6364				6428			
6365				6429			
6366				6430			
6367				6431			
6368				6432			

7.3 UT55A/UT52A/UP55A I Relays

DO terminals				DO terminals			
NO.	I relay symbol	R/W		NO.	I relay symbol	R/W	
		UT55A/UT52A	UP55A			UT55A/UT52A	UP55A
6433	OUT_AL1	R	R	6497	OUT_DO41	R	R
6434	OUT_AL2	R	R	6498	OUT_DO42	R	R
6435	OUT_AL3	R	R	6499	OUT_DO43	R	R
6436				6500	OUT_DO44	R	R
6437				6501	OUT_DO45	R	R
6438				6502			
6439				6503			
6440				6504			
6441				6505			
6442				6506			
6443				6507			
6444				6508			
6445				6509			
6446				6510			
6447				6511			
6448				6512			
6449	OUT_DO11	R	R	6513			
6450	OUT_DO12	R	R	6514			
6451	OUT_DO13	R	R	6515			
6452	OUT_DO14	R	R	6516			
6453	OUT_DO15	R	R	6517			
6454				6518			
6455				6519			
6456				6520			
6457				6521			
6458				6522			
6459				6523			
6460				6524			
6461				6525			
6462				6526			
6463				6527			
6464				6528			
6465	OUT_DO21	R	R	6529			
6466	OUT_DO22	R	R	6530			
6467	OUT_DO23	R	R	6531			
6468	OUT_DO24	R	R	6532			
6469	OUT_DO25	R	R	6533			
6470				6534			
6471				6535			
6472				6536			
6473				6537			
6474				6538			
6475				6539			
6476				6540			
6477				6541			
6478				6542			
6479				6543			
6480				6544			
6481	OUT_DO31	R	R	6545			
6482	OUT_DO32	R	R	6546			
6483	OUT_DO33	R	R	6547			
6484	OUT_DO34	R	R	6548			
6485	OUT_DO35	R	R	6549			
6486				6550			
6487				6551			
6488				6552			
6489				6553			
6490				6554			
6491				6555			
6492				6556			
6493				6557			
6494				6558			
6495				6559			
6496				6560			

6561 to 7072: Free area

DI Terminals and DO Terminals (6305 to 6560)

I relay No.	Symbol	Description
6305 to 6320	DI1 to DI3	DI1-DI3 status (Same as D7601)
6321 to 6336	DI11 to DI16	DI11-DI16 status (Same as D7602)
6337 to 6352	DI21 to DI26	DI21-DI26 status (Same as D7603)
6353 to 6368	DI31 to DI35	DI31-DI35 status (Same as D7604)
6369 to 6384	DI41 to DI46	DI41-DI46 status (Same as D7605)
6385 to 6432		
6433 to 6448	OUT_AL1 to OUT_AL3	AL1-AL3 status (Same as D7611)
6449 to 6464	OUT_DO11 to OUT_DO15	DO11-DO15 status (Same as D7612)
6465 to 6480	OUT_DO21 to OUT_DO25	DO21-DO25 status (Same as D7613)
6481 to 6496	OUT_DO31 to OUT_DO35	DO31-DO35 status (Same as D7614)
6497 to 6512	OUT_DO41 to OUT_DO45	DO41-DO45 status (Same as D7615)
6513 to 6560		

7.4 Reading via Communication

■ When reading the alarm status

Read I relay numbers 4321 to 4336 for Loop-1 alarm-1 to alarm-8 status.

I relay No.	Symbol	Event
4321 to 4336	ALM1_L1~ALM8_L1	Loop-1 alarm-1 to alarm-8 status (Same as D2011) *
4337 to 4352	ALM1_L2~ALM8_L2	Loop-2 alarm-1 to alarm-8 status (Same as D2013)
⋮	⋮	⋮
4545 to 4576		

*: The contents of Loop-1 alarm-1 to alarm-8 status (I relay numbers 4321 to 4336: ALM1_L1 to ALM8_L1) are the same as the bit configuration of D register number D2011 (Loop-1 alarm-1 to alarm-8 status). Refer to the bit configuration of D2011 described in “Chapter 6 Functions and Applications of D Registers (for UT55A/UT52A/UP55A).”

The following shows the bit configuration of D2011 described in “Chapter 6 Functions and Applications of D Registers (for UT55A/UT52A/UP55A).”

● Bit Configuration of D2011: ALM_L1 (Loop-1 alarm-1 to alarm-8 status)

Bit	Symbol	Event
0	ALM1_L1	'1' when Loop-1 alarm 1 is ON; '0' when OFF
1	ALM2_L1	'1' when Loop-1 alarm 2 is ON; '0' when OFF
2	ALM3_L1	'1' when Loop-1 alarm 3 is ON; '0' when OFF
3		
4	ALM4_L1	'1' when Loop-1 alarm 4 is ON; '0' when OFF
5	ALM5_L1	'1' when Loop-1 alarm 5 is ON; '0' when OFF
6	ALM6_L1	'1' when Loop-1 alarm 6 is ON; '0' when OFF
7		
8	ALM7_L1	'1' when Loop-1 alarm 7 is ON; '0' when OFF
9	ALM8_L1	'1' when Loop-1 alarm 7 is ON; '0' when OFF
10 to 15		

Note

When specifying an I relay number for communication, begin the number with the character “I.”
Example: Set “I4321” to specify the ALM1_L1 (I relay No.: 4321).

7.5 GREEN Series Compatible I Relays

7.5.1 Compatibility with GREEN Series Controllers

The map configuration from 1 to 2048 of the I relay map is the same as that of the GREEN Series (UT500 Series/UP550) controllers.

If existing programs created in the GREEN Series controllers are used, communication is performed using the area from 0001 to 2048.

The I relay map after 4001 is allocated for the UTAdvanced.

If you want to newly perform communication, be sure to use the registers after 4001.

7.5.2 Conventions Used in I Relay Tables

■ How to Specify I Relay Numbers

When specifying an I relay number for communication, begin the number with the character "I."

Example: Set "I0003" to specify the ADERR_E1 (I relay No.: 0003).

■ Interpretation of Cell

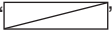
A cell marked with a diagonal line () indicates that it is not supported by the UTAdvanced.

■ I relay symbol

- With regards to some register symbols, the loop number and terminal area are indicated by adding the underline () to the end of the parameter symbols.

□□□□_Ln Ln: Loop numbers (L1 or L2)
□□□□_En En: Terminal area (E1 to E4)

Example : **PVBO_L1** Indicates Loop-1 PVBO.
ADERR_E1 Indicates ADERR in E1-terminal area.

- Numbers in parentheses after the register symbols of the UTAdvanced indicate the same I relay after I4001.

Note

- I relay numbers 1 to 192 store ON/OFF status information and are normally read for ON/OFF status information. I relay numbers 1 to 192 also exists in D registers. They have the same function data as D registers.
- In the area for I relay numbers 1 to 720, it is prohibited to write data to I relays with blank cells in I relay map tables. If you attempt to do so, the UTAdvanced may not operate properly.

7.5 I Relays Corresponding to GREEN Series

7.5.3 Status (0001 to 0192)
UT55A/UT52A

Status								
NO.	I relay symbol		NO.	I relay symbol		NO.	I relay symbol	
	GREEN	UTAdvanced		GREEN	UTAdvanced		GREEN	UTAdvanced
1	AD1 ERR	ADERR (4065)	65	A/M1	A.M (4193) *1	129		
2			66	R/L1	R.L_L1 (4194)	130		
3	AD3 ERR	ADERR_E1 (4066)	67	R/S1	S.R (4193)	131		
4			68			132		
5	AD1 BO	ADBO (4073)	69	CAS	CAS_ON (4197) *2	133		
6			70	AUT	AUTO_ON (4198) *2	134		
7	AD3 BO	ADBO_E1 (4074)	71	MAN	MAN_ON (4199) *2	135		
8			72			136		
9	RJC1 ERR	RJCERR (4070)	73			137		
10			74			138		
11			75			139		
12	VLV.AT ERR	VALV_ATERR (4082)	76			140		
13	VLV.BOUT	VALVBO (4081)	77			141		
14			78			142		
15			79	AT1	AT_L1_ON (4207)	143		
16			80			144		
17	PV1 ADC		81			145		
18	PV1 BO	PVBO_L1 (4097)	82			146		
19	RJC1 ERR		83			147		
20			84			148		
21	PV1+over	PVPOVER_L1 (4101)	85			149		
22	PV1-over	PVMOVER_L1 (4102)	86			150		
23			87			151		
24			88			152		
25	RSP1 ADC		89			153		
26	RSP1 BO	RSPBO_L1 (4098)	90			154		
27			91			155		
28			92			156		
29	C.RSP1 ADC		93			157		
30	C.RSP1 BO	CRSPBO_L1 (4099)	94			158		
31	AT1 ERR	ATERR_L1 (4111)	95	AT2	AT_L2_ON (4239)	159		
32			96			160		
33	PV2 ADC		97	ALM11	ALM1_L1 (4321)	161	DI1	X_DI1 (5025)
34	PV2 BO	PVBO_L2 (4113)	98	ALM12	ALM2_L1 (4322)	162	DI2	X_DI2 (5026)
35	RJC2 ERR		99	ALM13	ALM3_L1 (4323)	163	DI3	X_DI3 (5027)
36			100			164	DI4	
37	PV2+over	PVPOVER_L2 (4117)	101	ALM14	ALM4_L1 (4325)	165	DI5	
38	PV2-over	PVMOVER_L2 (4118)	102	OR1		166	DI6	
39			103			167	DI7	
40			104			168	DI8	
41	RSP2 ADC		105	ALM21	ALM1_L2 (4337)	169		
42	RSP2 BO	RSPBO_L2 (4114)	106	ALM22	ALM2_L2 (4338)	170		
43			107	ALM23	ALM3_L2 (4339)	171		
44			108			172		
45	C.RSP2 ADC		109	ALM24	ALM4_L2 (4341)	173		
46	C.RSP2 BO	CRSPBO_L2 (4115)	110	OR2		174		
47	AT2 ERR	ATERR_L2 (4127)	111			175		
48			112			176		
49	CALB.E	CALB_ERR (4002)	113			177		
50	UCALB.E		114			178		
51	USER.E		115			179		
52			116			180		
53	UTMD	SETPA_ERR (4005)	117			181		
54	RANGE	SETPA_ERR (4005)	118			182		
55	SETUP	SETPA_ERR (4005)	119			183		
56			120			184		
57	PARA.E	OPEPA_ERR (4006)	121			185		
58	MODE.E	CTLPA_ERR (4011)	122			186		
59	FILE.E		123			187		
60			124			188		
61	EEP.E	FRAM_ERR (4009)	125			189		
62			126			190		
63	SYSTEM.E	SYSTEM_ERR (4001)	127			191		
64			128			192		

193 to 576: Free area

See the next page regarding “*1” and “*2.”

7.5 I Relays Corresponding to GREEN Series

*1: Effective for the control modes except for cascade control and cascade secondary-loop control.

*2: Effective for cascade control mode and cascade secondary-loop control mode.

I relay No.	Symbol	Description
1 to 16	ADERR to VALVBO	A/D converter error status for GREEN Series (Same as D0001)
17 to 32	PVBO_L1 to ATERR_L1	Loop-1 PV input error status for GREEN Series (Same as D0002)
33 to 48	PVBO_L2 to ATERR_L2	Loop-2 PV input error status for GREEN Series (Same as D0018)
49 to 64	CALB_ERR to SYSTEM_ERR	Parameter error status for GREEN Series (Same as D0035)
65 to 80	A.M to AT_L1_ON	Loop-1 operation mode status for GREEN Series (Same as D0008)
81 to 96	AT_L2_ON	Loop-2 operation mode status for GREEN Series (Same as D0024)
97 to 112	ALM1_L1 to ALM4_L2	Alarm status for GREEN Series (Same as D0011)
113 to 160		
161 to 176	X_DI to X_DI3	DI1-DI3 status (D0033)
177 to 192		

193 to 576: Free area

7.5 I Relays Corresponding to GREEN Series

UP55A

Status								
NO.	I relay symbol		NO.	I relay symbol		NO.	I relay symbol	
	GREEN	UTAdvanced		GREEN	UTAdvanced		GREEN	UTAdvanced
1	AD1ERR	ADERR (4065)	65	A/M1	A.M_L1 (4177)	129	TIME1	TIME_EV1 (4817)
2			66			130	TIME2	TIME_EV2 (4818)
3	AD3ERR	ADERR_E1 (4066)	67			131	TIME3	TIME_EV3 (4819)
4			68			132		
5	AD1BO	ADBO (4073)	69			133	TIME4	TIME_EV4 (4821)
6			70			134	TIME5	TIME_EV5 (4822)
7	AD3BO	ADBO_E1 (4074)	71			135	TIME6	TIME_EV6 (4823)
8			72			136		
9	RJC1ERR	RJCERR (4070)	73	RESET	RST_ON (4181)	137	TIME7	TIME_EV7 (4825)
10			74	PROG	PRG_ON (4182)	138	TIME8	TIME_EV8 (4826)
11			75	LOCAL	LOC_ON (4183)	139		
12	VLV.ATERR	VALV_ATERR (4082)	76			140		
13	VLV.BOUT	VALVBO (4081)	77	HOLD	HOLD_ON (4189)	141		
14			78	WAIT	WAITF (4190)	142		
15			79	AT1	AT_L1_ON (4191)	143		
16			80			144		
17	PV1ADC		81	A/M2	A.M_L2 (4225)	145		
18	PV1BO	PVBO_L1 (4097)	82			146		
19	RJC1ERR		83			147		
20			84			148		
21	PV1+over	PVPOVER_L1 (4101)	85			149		
22	PV1-over	PVMOVER_L1 (4102)	86			150		
23			87			151		
24			88			152		
25			89	CAS/LSP	L.C (4233)	153		
26			90			154		
27			91			155	WEND	WTEND1 (4257)
28			92			156		
29			93			157	PTEND	PTEND1 (4265)
30			94			158	PTEND3	PTEND3 (4266)
31	AT1ERR	ATERR_L1 (4111)	95	AT2	AT_L2_ON (4239)	159	PTEND5	PTEND5 (4267)
32			96			160		
33	PV2ADC		97	ALM11	ALM1_L1 (4321)	161	DI1	X_DI1 (5025)
34	PV2BO	PVBO_L2 (4113)	98	ALM12	ALM2_L1 (4322)	162	DI2	X_DI2 (5026)
35	RJC2ERR		99	ALM13	ALM3_L1 (4323)	163	DI3	X_DI3 (5027)
36			100			164	DI4	X_DI41 (5089)
37	PV2+over	PVPOVER_L2 (4117)	101	ALM14	ALM4_L1 (4325)	165	DI5	X_DI42 (5090)
38	PV2-over	PVMOVER_L2 (4118)	102	OR1		166	DI6	X_DI43 (5091)
39			103			167	DI7	X_DI44 (5092)
40			104			168	DI8	X_DI45 (5093)
41			105			169	DP1	
42			106			170	DP2	
43			107			171	MG1	MG1.B (4769)
44			108			172	MG2	MG2.B (4770)
45			109			173	MG3	MG3.B (4771)
46			110	OR2		174	MG4	MG4.B (4773)
47	AT2ERR	ATERR_L2 (4127)	111			175		
48			112			176		
49	CALB.E	CALB_ERR (4002)	113	PVE1	PV_EV1 (4785)	177		
50	UCALB.E		114	PVE2	PV_EV2 (4786)	178		
51	USER.E		115	PVE3	PV_EV3 (4787)	179		
52			116			180		
53	UTMD	SETPA_ERR (4005)	117	PVE4	PV_EV4 (4789)	181		
54	RANGE	SETPA_ERR (4005)	118	PVE5	PV_EV5 (4790)	182		
55	SETUP	SETPA_ERR (4005)	119	PVE6	PV_EV6 (4791)	183		
56			120			184		
57	PARA.E	OPEPA_ERR (4006)	121	PVE7	PV_EV7 (4793)	185		
58	MODE.E	CTLPA_ERR (4011)	122	PVE8	PV_EV8 (4794)	186		
59	FILE.E	PROG_ERR (4007)	123			187		
60			124			188		
61			125			189		
62			126			190		
63	SYSTEM.E	SYSTEM_ERR (4001)	127			191		
64			128			192		

193 to 576: Free area

See the next page regarding “*1” and “*2.”

7.5 I Relays Corresponding to GREEN Series

*1: Effective for the control modes except for cascade control and cascade secondary-loop control.

*2: Effective for cascade control mode and cascade secondary-loop control mode.

I relay No.	Symbol	Description
1 to 16	ADERR to VALVBO	A/D converter error status for GREEN Series (Same as D0001)
17 to 32	PVBO_L1 to ATERR_L1	Loop-1 PV input error status for GREEN Series (Same as D0002)
33 to 48	PVBO_L2 to ATERR_L2	Loop-2 PV input error status for GREEN Series (Same as D0018)
49 to 64	CALB_ERR to SYSTEM_ERR	Parameter error status for GREEN Series (Same as D0035)
65 to 80	A.M to AT_L1_ON	Loop-1 operation mode status for GREEN Series (Same as D0008)
81 to 96	AT_L2_ON	Loop-2 operation mode status for GREEN Series (Same as D0024)
97 to 112	ALM1_L1 to ALM4_L2	Alarm status for GREEN Series (Same as D0011)
113 to 128	PV_EV1 to PV_EV8	PV event 1-8 status for GREEN Series (Same as D0012)
129 to 144	TIME_EV1 to TIME_EV8	Time event 1-8 status for GREEN Series (Same as D0013)
145 to 160	WTEND1	Wait end signal (1 second)
	PTEND1	Pattern end signal (1 second)
	PTEND3	Pattern end signal (3 seconds)
	PTEND5	Pattern end signal (5 seconds)
161 to 174	X_DI to MG4.B	DI1-DI3 status (D0033)
177 to 192		

193 to 576: Free area

7.5 I Relays Corresponding to GREEN Series

7.5.4 SP Number, PID Number, and Status (0577 to 0720)

UT55A/UP55A

SP number, PID number, and status					
NO.	I relay symbol		NO.	I relay symbol	
	GREEN	UTAdvanced		GREEN	UTAdvanced
577	CSPNO.0	CSPN.B0 (4577)	641		
578	CSPNO.1	CSPN.B1 (4578)	642		
579	CSPNO.2	CSPN.B2 (4579)	643		
580	CSPNO.3	CSPN.B3 (4580)	644		
581			645		
582			646		
583			647		
584			648		
585			649		
586			650		
587			651		
588			652		
589			653		
590			654		
591			655		
592			656		
593	PIDNO1.0	PIDN.B0_L1 (4609)	657		
594	PIDNO1.1	PIDN.B1_L1 (4610)	658		
595	PIDNO1.2	PIDN.B2_L1 (4611)	659		
596	PIDNO1.3	PIDN.B3_L1 (4612)	660		
597			661		
598			662	/DI1 (Note)	INV_DI1
599			663	/DI2 (Note)	INV_DI2
600			664	/DI3 (Note)	INV_DI3
601			665	V.GUE	VALV_GUSS (4210)
602			666		
603			667		
604			668		
605			669		
606			670		
607			671		
608			672		
609	PIDNO2.0	PIDN.B0_L2 (4625)	673		
610	PIDNO2.1	PIDN.B1_L2 (4626)	674	LP2	LP2_LAMP
611	PIDNO2.2	PIDN.B2_L2 (4627)	675	/DI4 (Note)	
612	PIDNO2.3	PIDN.B3_L2 (4628)	676	/DI5 (Note)	
613			677	/DI6 (Note)	
614			678	/DI7 (Note)	
615			679	/DI8 (Note)	
616			680		
617			681	DEV1-	DEV1M
618			682	DEV1Z	DEV1Z
619			683	DEV1+	DEV1P
620			684		
621			685	DEV2-	DEV2M
622			686	DEV2Z	DEV2Z
623			687	DEV2+	DEV2P
624			688		
625			689	ALO11	ALO1_L1 (4353)
626			690	ALO12	ALO2_L1 (4354)
627			691	ALO13	ALO3_L1 (4355)
628			692		
629			693	ALO14	ALO4_L1 (4357)
630			694		
631			695		
632			696		
633			697	ALO21	ALO1_L2 (4369)
634			698	ALO22	ALO2_L2 (4370)
635			699	ALO23	ALO3_L2 (4371)
636			700		
637			701	ALO24	ALO4_L2 (4373)
638			702		
639			703		
640			704		

(Note): For UT551 only

7.5 I Relays Corresponding to GREEN Series

I relay No.	Symbol	Description	
577 to 592	CSPN.B0 to CSPN.B3	SPnumber (Same as 2010)	
593 to 608	PIDN.B0_L1 to PIDN.B3_L1	Loop-1 PID number (Same as 2009)	
609 to 624	PIDN.B0_L2 to PIDN.B3_L2	Loop-2 PID number (Same as 2025)	
625 to 656			
662	INV_DI1	DI1 status for GREEN	0: OFF 1: ON
663	INV_DI2	DI2 status for GREEN	
664	INV_DI3	DI3 status for GREEN	
665	VALV_GUSS	Valve position estimating	0: Operation by feedback input 1: Operation by estimating type
674	LP2_LAMP	LP2 lamp	0: Unlit 1: Lit
681	DEV1M	Loop-1 Deviation low limit indicator lamp	
682	DEV1Z	Loop-1 deviation within high and low limits indicator lamp	
683	DEV1P	Loop-1 Deviation high limit indicator lamp	
685	DEV2M	Loop-2 Deviation low limit indicator lamp	
686	DEV2Z	Loop-2 deviation within high and low limits indicator lamp	
687	DEV2P	Loop-2 Deviation high limit indicator lamp	
689 to 704	ALO1_L1 to ALO4_L2	Alarm-1 to alarm-4 output status for GREEN Serieese (Same as D0036)	
705 to 720			

7.5 I Relays Corresponding to GREEN Series

UP55A

SP number, PID number, and status								
NO.	I relay symbol		NO.	I relay symbol		NO.	I relay symbol	
	GREEN	UTAdvanced		GREEN	UTAdvanced		GREEN	UTAdvanced
577			641	SEGNO.0	SEGNO.B0 (4657)	705	PVE01	PV_EV1_OUT (4801)
578			642	SEGNO.1	SEGNO.B1 (4658)	706	PVE02	PV_EV2_OUT (4802)
579			643	SEGNO.2	SEGNO.B2 (4659)	707	PVE03	PV_EV3_OUT (4803)
580			644	SEGNO.3	SEGNO.B3 (4660)	708		
581			645	SEGNO.4	SEGNO.B4 (4661)	709	PVE04	PV_EV4_OUT (4805)
582			646	SEGNO.5	SEGNO.B5 (4662)	710	PVE05	PV_EV5_OUT (4806)
583			647	SEGNO.6	SEGNO.B6 (4663)	711	PVE06	PV_EV6_OUT (4807)
584			648			712		
585			649			713	PVE07	PV_EV7_OUT (4809)
586			650			714	PVE08	PV_EV8_OUT (4810)
587			651			715		
588			652			716		
589			653			717		
590			654			718		
591			655			719		
592			656			720		
593	PIDNO1.0	PIDN.B0_L1 (4609)	657	TIM.1S		721		
594	PIDNO1.1	PIDN.B1_L1 (4610)	658	TIM.5S		722		
595	PIDNO1.2	PIDN.B2_L1 (4611)	659	TIM.10S		723		
596	PIDNO1.3	PIDN.B3_L1 (4612)	660			724		
597			661	TIM.1M		725		
598			662			726		
599			663			727		
600			664			728		
601			665	V.GUE	VALV_GUSS (4210)	729		
602			666			730		
603			667			731		
604			668			732		
605			669			733		
606			670			734		
607			671			735		
608			672	PON		736		
609	PIDNO2.0	PIDN.B0_L2 (4625)	673	PV2		737		
610	PIDNO2.1	PIDN.B1_L2 (4626)	674			738		
611	PIDNO2.2	PIDN.B2_L2 (4627)	675			739		
612	PIDNO2.3	PIDN.B3_L2 (4628)	676			740		
613			677			741		
614			678			742		
615			679			743		
616			680			744		
617			681			745		
618			682			746		
619			683			747		
620			684			748		
621			685			749		
622			686			750		
623			687			751		
624			688			752		
625	PTNO.0	PTNO.B0 (4641)	689	ALO11	ALO1_L1 (4353)	753		
626	PTNO.1	PTNO.B1 (4642)	690	ALO12	ALO2_L1 (4354)	754		
627	PTNO.2	PTNO.B2 (4643)	691	ALO13	ALO3_L1 (4355)	755		
628	PTNO.3	PTNO.B3 (4644)	692			756		
629	PTNO.4	PTNO.B4 (4645)	693	ALO14	ALO4_L1 (4357)	757		
630			694			758		
631			695			759		
632			696			760		
633			697			761		
634			698			762		
635			699			763		
636			700			764		
637			701			765		
638			702			766		
639			703			767		
640			704			768		

I relay No.	Symbol	Description	
577 to 592			
593 to 608	PIDN.B0_L1 to PIDN.B3_L1	Loop-1 PID number (Same as 2009)	
609 to 624	PIDN.B0_L2 to PIDN.B3_L2	Loop-2 PID number (Same as 2025)	
625 to 640	PTNO.B0 to PTNO.B4	Pattern number (Same as D2015)	
641 to 656	SEGNO.B0 to SEGNO.B6	Segment number (Same as D202016)	
625 to 664			
665	VALV_GUSS	Valve position estimating	0: Operation by feedback input 1: Operation by estimating type
666 to 688			
689 to 704	ALO1_L1 to ALO4_L1	Alarm-1 to alarm-4 output status for GREEN Series (Same as D0036)	
705 to 720	PV_EV1_OUT to PV_EV8_OUT	PV event output status (D2050)	

7.5.5 User Area (0721 to 2048)

I relay No.	I relay symbol	Description	
721 to 2048	USER	User area	You can read/write data from/to the area for I relays 721 to 2048 via communication. That is, you can use the area freely without affecting the control function of the UTAdvanced. However, the data cannot be saved.

Blank Page

8.1 Overview

This chapter describes the functions and applications of the D registers. D registers are used in Modbus, PC link, ladder, Ethernet communications, or Open Network communication (network profile creating function of LL50A) and are used for storing UTAdvanced parameter data, flag data, process data, and other data and values. The host computer can utilize these data by reading from and writing to the D registers. When you newly perform communication with the UTAdvanced, the D registers after D2001 are used.

Use of the D registers enables the following:

- Centralized control by the host computer
- Reading and writing of data between the UTAdvanced and the host computer

Note

The D registers available vary depending on the model and suffix codes of the UTAdvanced or parameter settings. For details, refer to the respective UTAdvanced User's Manual.

D registers and I relays on the UTAdvanced are used for parameter settings or ladder program creations of LL50A Parameter Setting Software.

8.2 Conventions Used in D Register Tables

This section describes the conventions used in the D register map tables.

The numerical values arranged vertically in the leftmost column of the table represent (1) D register numbers. 5-digit numbers in the column next to it show (2) reference numbers for Modbus communication. The third column from the left provides (3) register numbers (hexadecimal) for Modbus communication.

Alphabet characters in the register map represent process data, operation parameters, setup parameters, and other flag register names. For details on operation parameters and setup parameters, refer to the respective UTAdvanced Operation Guide and User's Manual.

Register map (Categories)						
Register contents						
D-Reg No.	Ref. No.	H No.	Register symbol	R/W		
				UT35A	UT32A	UM33A
D2001	42001	07D0	AD1.E *1	R	R	R
D2002	42002	07D1	PV1.E_L1 *1	R	R	R
D2003	40003	07D2	PV_L1 *1	R	R	R
D2004	40004	07D3	CSP_L1	R	R	R
D2005	40005	07D4	OUT_L1	R	R	R
.
:	:	:	:	:	:	:
.

(1) D register numbers (2) Reference numbers (for Modbus communication) (3) Hexadecimal numbers (for Modbus communication) Read/write by communication

R: Read enabled
 W: Write enabled
 : No register

*1: Register symbols listed in blue-color boldface (e.g., **AD1.E**) indicates the parameters of the UTAdvanced.

■ D Register Symbols

- With regards to some D register symbols, the loop number, terminal area, and group number are indicated by adding the underline () to the end of the parameter symbols.

If both the loop number and group number are added to the parameter symbols, they are added in the order of loop number and group number.

Note

Since the UT35A/UT32A is a single-loop controller, it has no distinction between Loop-1 and Loop-2.

However, the register symbol has "L1" which indicates Loop-1.

□□□□_L1_Y	L1 : Loop numbers Y : Group numbers (1 to 4 or R)
□□□□_En	En : Terminal area (E1 to E4)
□□□□_Sn	Sn : Segment Number (S1 to S40)

Example : **SP_L1_3** SP of group 3.
A2_2 Indicates A2 of group 2.
DI1.D_E1 Indicates DI1.D in E1-terminal area.
TSP_L1_S20 Indicates TSP of Segment Number 20.

8.3 Classification of D Registers

■ Classification of D Register Map Tables

The table on next page outlines how the D registers are classified by their numbers in the D register map tables.

When you newly perform communication with the UTAdvanced, the D registers after D2001 are used.

CAUTION

- Check the model and suffix codes and parameter settings before writing to or read from the registers to be used.
- No data can be written to or read from blank parts of the data storage area by communication.
The UTAdvanced sometimes does not operate properly if an attempt is made to write to or read from blank parts of the data storage area.

■ Setting a Value with a Decimal Point

When setting a value with a decimal point from the host computer, set a value excluding the decimal point (hexadecimal)*.

Note

The UTAdvanced determine the decimal point position by the parameter setting.

Example: When setting a target setpoint "50.0" from the host computer

Set "1F4" which is a hexadecimal value of "500" (50.0 excluding the decimal point) (this is also true for setting 5.00 or 500).

Target setpoint "50.0": P.DP = 1

Target setpoint "5.00": P.DP = 2

Target setpoint "500": P.DP = 0

*: For ladder operation, set the BCD value excluding the decimal point.

8.3 Classification of D Registers

Classification of D Registers

Register No.	Area and data categories	Description	Reference		
D0001 to D0049	(See 8.6 GREEN Series Compatible D Registers)	Process data	Sections 8.6.3		
D0050 to D0100		User area	Sections 8.6.3		
D0101 to D0200		Program setting parameter (for UP35A only)	Sections 8.6.3		
D0201 to D0230		Operation mode parameter	Sections 8.6.4		
D0231 to D0300		Operation-related parameter	Sections 8.6.4		
D0301 to D0500		PID parameter	Sections 8.6.5		
D0501 to D0900		Free area			
D0901 to D1000		Control action parameter	Sections 8.6.6		
D1001 to D1100		Common function parameter	Sections 8.6.7		
D1101 to D1200		Display and I/O configuration parameter	Sections 8.6.8		
D1201 to D1300		Controller mode, PV input, and control output parameter	Sections 8.6.9		
D1301 to D2000		Free area			
D2001 to D2100	Process monitoring	Process data	Sections 8.4.1		
D2101 to D2200		Current SP group and PID group			
D2201 to D2300	Program pattern parameter (for UP35A only)	Local-mode operation setting			
D2301 to D2400	Operation mode parameter, Operation parameter (for UP35A only)	Operation mode, Alarm setpoint setting (for UP35A only)	Sections 8.4.2		
D2401 to D2500		Free area			
D2501 to D2700	Operation parameter	SP and alarm setpoint setting (for UT35A/UT32A only)	Sections 8.4.3		
D2701 to D2800		SP-related setting			
D2801 to D2900		Alarm function setting			
D2901 to D3000		PV-related setting			
D3001 to D3500		PID setting			
D3501 to D3600		Control action-related setting			
D3601 to D4700	Free area	Free area			
D4701 to D4800	P parameter	P parameter	Sections 8.4.4		
D4801 to D5000	Free area	Free area			
D5001 to D5100	Setup parameter	Control function setting	Sections 8.4.5		
D5101 to D5300		Input setting			
D5301 to D5400		Output setting			
D5401 to D5500		Heater break alarm setting			
D5501 to D5700		Communication setting			
D5701 to D5800		Key action setting / Display function setting / SELECT display setting			
D5801 to D5900		Lock setting (Key lock / menu lock)			
D5901 to D6200		DI function setting			
D6201 to D6300		DO function setting			
D6301 to D6400		I/O display			
D6401 to D6500		System setting			
D6501 to D7000		Free area			
D7001 to D7100		Registers for ladder program		For input ladder calculation	Sections 8.4.6
D7101 to D7200				For output ladder calculation	
D7201 to D7300				Status register	
D7301 to D7500	Constant register				
D7501 to D7600	Input range / scale				
D7601 to D7700	Terminal status register		Input / Output terminal status register	Sections 8.4.7	
D8001 to D8100	Program pattern parameter (for UP35A only)	Pattern data setting	Sections 8.4.10		
D8101 to D8200		Segment data setting			
D8201 to D8600		Final target setpoint setting for batch writing			
D8601 to D9000		Segment time setting / Segment ramp-rate setting for batch writing			

Note 1: Data in the process values, operation parameters, and setup parameters is stored in the format (data excluding the decimal point of PV input range, PV input range span, %, or ABS) described in “Lists of Operation Parameters” and “Lists of Setup Parameters” in the UTAdvanced Operation Guide or User’s Manual.

The OFF status of data is indicated by “0” and the ON status is indicated by “1.”

D registers D2001 to D2100 are read-only.

8.4 UT35A/UT32A/UP35A D Registers

8.4.1 Process Monitoring and Program Pattern for UP35A (D2001 to D2300)

Process monitoring area													
Process data													
D-Reg No.	Ref. No.	H No.	Register symbol	R/W			D-Reg No.	Ref. No.	H No.	Register symbol	R/W		
				UT 35A	UT 32A	UP 35A					UT 35A	UT 32A	UP 35A
D2001	42001	07D0	AD1.E	R	R	R	D2051	42051	0802				
D2002	42002	07D1	PV1.E_L1	R	R	R	D2052	42052	0803				
D2003	42003	07D2	PV_L1	R	R	R	D2053	42053	0804				
D2004	42004	07D3	CSP_L1	R	R	R	D2054	42054	0805				
D2005	42005	07D4	OUT_L1	R	R	R	D2055	42055	0806				
D2006	42006	07D5	H.OUT_L1	R	R	R	D2056	42056	0807				
D2007	42007	07D6	C.OUT_L1	R	R	R	D2057	42057	0808				
D2008	42008	07D7	MOD_L1	R	R	R	D2058	42058	0809				
D2009	42009	07D8	PID_L1	R	R	R	D2059	42059	080A				
D2010	42010	07D9	CSPNO.	R	R		D2060	42060	080B				
D2011	42011	07DA	ALM_L1	R	R	R	D2061	42061	080C	HC1	R	R	R
D2012	42012	07DB	LA.ER	R	R	R	D2062	42062	080D	HC2	R	R	R
D2013	42013	07DC					D2063	42063	080E	CT_AL	R	R	R
D2014	42014	07DD					D2064	42064	080F	VALV	R	R	R
D2015	42015	07DE	C.PTNO.			R	D2065	42065	0810	AD2.E	R	R	R
D2016	42016	07DF	SEG.N			R	D2066	42066	0811	DIMG	R	R	R
D2017	42017	07E0	SEG_RUNTIME			R	D2067	42067	0812				
D2018	42018	07E1					D2068	42068	0813	PA.ER	R	R	R
D2019	42019	07E2					D2069	42069	0814				
D2020	42020	07E3					D2070	42070	0815	OP.ER	R	R	R
D2021	42021	07E4					D2071	42071	0816	ALOLA1_L1	R	R	R
D2022	42022	07E5					D2072	42072	0817				
D2023	42023	07E6					D2073	42073	0818	ALOLA2_L1	R	R	R
D2024	42024	07E7					D2074	42074	0819				
D2025	42025	07E8					D2075	42075	081A	ALOLA3_L1	R	R	R
D2026	42026	07E9					D2076	42076	081B				
D2027	42027	07EA					D2077	42077	081C	ALOLA4_L1	R	R	R
D2028	42028	07EB					D2078	42078	081D				
D2029	42029	07EC					D2079	42079	081E				
D2030	42030	07ED					D2080	42080	081F				
D2031	42031	07EE					D2081	42081	0820				
D2032	42032	07EF					D2082	42082	0821				
D2033	42033	07F0	CTSP_L1			R	D2083	42083	0822				
D2034	42034	07F1					D2084	42084	0823				
D2035	42035	07F2	DEV_L1	R	R	R	D2085	42085	0824				
D2036	42036	07F3					D2086	42086	0825				
D2037	42037	07F4	ALO_L1	R	R	R	D2087	42087	0826				
D2038	42038	07F5					D2088	42088	0827				
D2039	42039	07F6	PV_EV			R	D2089	42089	0828				
D2040	42040	07F7	TIME_EV_1			R	D2090	42090	0829				
D2041	42041	07F8					D2091	42091	082A				
D2042	42042	07F9					D2092	42092	082B				
D2043	42043	07FA					D2093	42093	082C				
D2044	42044	07FB	SEG_USE			R	D2094	42094	082D				
D2045	42045	07FC	NOW_RCY			R	D2095	42095	082E				
D2046	42046	07FD	REM_RCY			R	D2096	42096	082F				
D2047	42047	07FE	ALL_RCY			R	D2097	42097	0830				
D2048	42048	07FF	NOW_RST			R	D2098	42098	0831				
D2049	42049	0800	NOW_REN			R	D2099	42099	0832				
D2050	42050	0801	PV_EV_OUT			R	D2100	42100	0833				

8.4 UT35A/UT32A/UP35A D Registers

Process monitoring area													
Current SP group and PID group													
D-Reg No.	Ref. No.	H No.	Register symbol	R/W			D-Reg No.	Ref. No.	H No.	Register symbol	R/W		
				UT 35A	UT 32A	UP 35A					UT 35A	UT 32A	UP 35A
D2101	42101	0834	SP_L1_*	R/W	R/W		D2151	42151	0866				
D2102	42102	0835	SUB_*	R/W	R/W		D2152	42152	0867				
D2103	42103	0836	PIDN_L1_*	R/W	R/W		D2153	42153	0868				
D2104	42104	0837	A1_L1_*	R/W	R/W		D2154	42154	0869				
D2105	42105	0838	A2_L1_*	R/W	R/W		D2155	42155	086A				
D2106	42106	0839	A3_L1_*	R/W	R/W		D2156	42156	086B				
D2107	42107	083A	A4_L1_*	R/W	R/W		D2157	42157	086C				
D2108	42108	083B					D2158	42158	086D				
D2109	42109	083C					D2159	42159	086E				
D2110	42110	083D					D2160	42160	086F				
D2111	42111	083E					D2161	42161	0870				
D2112	42112	083F					D2162	42162	0871				
D2113	42113	0840					D2163	42163	0872				
D2114	42114	0841	P_L1_*	R/W	R/W	R/W	D2164	42164	0873				
D2115	42115	0842	I_L1_*	R/W	R/W	R/W	D2165	42165	0874				
D2116	42116	0843	D_L1_*	R/W	R/W	R/W	D2166	42166	0875				
D2117	42117	0844	OH_L1_*	R/W	R/W	R/W	D2167	42167	0876				
D2118	42118	0845	OL_L1_*	R/W	R/W	R/W	D2168	42168	0877				
D2119	42119	0846	MR_L1_*	R/W	R/W	R/W	D2169	42169	0878				
D2120	42120	0847	HYS_L1_*	R/W	R/W	R/W	D2170	42170	0879				
D2121	42121	0848	SU.HY_L1_*	R/W	R/W		D2171	42171	087A				
D2122	42122	0849	HY.ON_L1_*	R/W	R/W	R/W	D2172	42172	087B				
D2123	42123	084A	HY.OF_L1_*	R/W	R/W	R/W	D2173	42173	087C				
D2124	42124	084B	DR_L1_*	R/W	R/W	R/W	D2174	42174	087D				
D2125	42125	084C	SU.DR_*	R/W	R/W		D2175	42175	087E				
D2126	42126	084D	Pc_L1_*	R/W	R/W	R/W	D2176	42176	087F				
D2127	42127	084E	Ic_L1_*	R/W	R/W	R/W	D2177	42177	0880				
D2128	42128	084F	Dc_L1_*	R/W	R/W	R/W	D2178	42178	0881				
D2129	42129	0850	OHc_L1_*	R/W	R/W	R/W	D2179	42179	0882				
D2130	42130	0851	OLc_L1_*	R/W	R/W	R/W	D2180	42180	0883				
D2131	42131	0852	HYSc_L1_*	R/W	R/W	R/W	D2181	42181	0884				
D2132	42132	0853	DB_L1_*	R/W	R/W	R/W	D2182	42182	0885				
D2133	42133	0854	PO_L1_*	R/W	R/W	R/W	D2183	42183	0886				
D2134	42134	0855	SU.PO_*	R/W	R/W		D2184	42184	0887				
D2135	42135	0856	POc_L1_*	R/W	R/W	R/W	D2185	42185	0888				
D2136	42136	0857					D2186	42186	0889				
D2137	42137	0858					D2187	42187	088A				
D2138	42138	0859					D2188	42188	088B				
D2139	42139	085A					D2189	42189	088C				
D2140	42140	085B					D2190	42190	088D				
D2141	42141	085C					D2191	42191	088E				
D2142	42142	085D					D2192	42192	088F				
D2143	42143	085E					D2193	42193	0890				
D2144	42144	085F					D2194	42194	0891				
D2145	42145	0860					D2195	42195	0892				
D2146	42146	0861					D2196	42196	0893				
D2147	42147	0862					D2197	42197	0894				
D2148	42148	0863					D2198	42198	0895				
D2149	42149	0864					D2199	42199	0896				
D2150	42150	0865					D2200	42200	0897				

See the next page regarding “*.”

- *: The group number to be displayed varies depending on the currently used SP number selection (D2312) and PID number (D2009). Either 1 to 4 or R (the currently used group number) is written. However, only 1 to 4 is written in D2101 to D2107.

8.4 UT35A/UT32A/UP35A D Registers

Program pattern													
Local-mode Operation Setting (Menu: LOC)													
D-Reg No.	Ref. No.	H No.	Register symbol	R/W			D-Reg No.	Ref. No.	H No.	Register symbol	R/W		
				UT 35A	UT 32A	UP 35A					UT 35A	UT 32A	UP 35A
D2201	42201	0898	LSP_L1			R/W	D2251	42251	08CA				
D2202	42202	0899					D2252	42252	08CB				
D2203	42203	089A	L.PID			R/W	D2253	42253	08CC				
D2204	42204	089B	L.TY1			R/W	D2254	42254	08CD				
D2205	42205	089C	L.LEV1			R/W	D2255	42255	08CE				
D2206	42206	089D	L.TY2			R/W	D2256	42256	08CF				
D2207	42207	089E	L.LEV2			R/W	D2257	42257	08D0				
D2208	42208	089F					D2258	42258	08D1				
D2209	42209	08A0					D2259	42259	08D2				
D2210	42210	08A1					D2260	42260	08D3				
D2211	42211	08A2					D2261	42261	08D4				
D2212	42212	08A3					D2262	42262	08D5				
D2213	42213	08A4					D2263	42263	08D6				
D2214	42214	08A5					D2264	42264	08D7				
D2215	42215	08A6					D2265	42265	08D8				
D2216	42216	08A7					D2266	42266	08D9				
D2217	42217	08A8					D2267	42267	08DA				
D2218	42218	08A9					D2268	42268	08DB				
D2219	42219	08AA					D2269	42269	08DC				
D2220	42220	08AB					D2270	42270	08DD				
D2221	42221	08AC					D2271	42271	08DE				
D2222	42222	08AD					D2272	42272	08DF				
D2223	42223	08AE					D2273	42273	08E0				
D2224	42224	08AF					D2274	42274	08E1				
D2225	42225	08B0					D2275	42275	08E2				
D2226	42226	08B1					D2276	42276	08E3				
D2227	42227	08B2					D2277	42277	08E4				
D2228	42228	08B3					D2278	42278	08E5				
D2229	42229	08B4					D2279	42279	08E6				
D2230	42230	08B5					D2280	42280	08E7				
D2231	42231	08B6					D2281	42281	08E8				
D2232	42232	08B7					D2282	42282	08E9				
D2233	42233	08B8					D2283	42283	08EA				
D2234	42234	08B9					D2284	42284	08EB				
D2235	42235	08BA					D2285	42285	08EC				
D2236	42236	08BB					D2286	42286	08ED				
D2237	42237	08BC					D2287	42287	08EE				
D2238	42238	08BD					D2288	42288	08EF				
D2239	42239	08BE					D2289	42289	08F0				
D2240	42240	08BF					D2290	42290	08F1				
D2241	42241	08C0					D2291	42291	08F2				
D2242	42242	08C1					D2292	42292	08F3				
D2243	42243	08C2					D2293	42293	08F4				
D2244	42244	08C3					D2294	42294	08F5				
D2245	42245	08C4					D2295	42295	08F6				
D2246	42246	08C5					D2296	42296	08F7				
D2247	42247	08C6					D2297	42297	08F8				
D2248	42248	08C7					D2298	42298	08F9				
D2249	42249	08C8					D2299	42299	08FA				
D2250	42250	08C9					D2300	42300	08FB				

Process Data Area

Some of the D registers represent multiple events such as errors and status depending on combinations of bits in the register.

In the following tables, if an event indicated by a specific bit occurs, the state of that bit changes to “1.”

If no event occurs, the state of that bit is “0.” Blank lines in each table indicate unused bits.

Process Data (D2001 to D2100)

● Bit Configuration of D2001: AD1.E (A/D converter error status 1)

Bit	Symbol	Event
0	ADERR	PV input A/D converter error
1 to 4		
5	RJCERR	PV input RJC error
6 to 7		
8	ADBO	PV input burnout error
9 to 15		

● Bit Configuration of D2002: PV1.E_L1 (PV input error status)

Bit	Symbol	Event
0	PVBO_L1	PV input burnout error
1 to 3		
4	PVPOVER_L1	PV input over-scale
5	PVMOVER_L1	PV input under-scale
6 to 13		
14	ATERR_L1	Auto-tuning timeout error
15		

● D2003 to D2007

Register No.	Description		Range and meaning of value
D2003	PV_L1	Measurement value	-5.0 to 105.0% of PV input range (EU)
D2004	CSP_L1	Control setpoint	0.0 to 100.0% of PV input range (EU) (Setting range: SPL to SPH)
D2005	OUT_L1	Control output	-5.0 to 105.0%
D2006	H.OUT_L1	Heating-side control output	-5.0 to 105.0% (In Heating/cooling control: 0.0 to 105.0%)
D2007	C.OUT_L1	Cooling-side control output	0.0 to 105.0%

● Bit Configuration of D2008: MOD_L1 (Operation mode status)

UT35A/UT32A

Bit	Symbol	Event
0	A.M	0: AUTO, 1: MAN
1	R.L_L1	0: Local, 1: Remote
2	S.R	0: Run, 1: Stop
3 to 7		
8	TRK_ON_L1	1: Output tracking
9 to 13		
14	AT_L1_ON	0: Auto-tuning is OFF, 1: Auto-tuning is ON
15		

8.4 UT35A/UT32A/UP35A D Registers

UP35A

Bit	Symbol	Event
0	A.M	0: AUTO, 1: MAN *1
1 to 3		
4	RST_ON	1: Program reset
5	PRG_ON	1: Program operation
6	LOC_ON	1: Local operation
7		
8		
9		
10	ADV_ON	1: Advance of segment
11		
12	HOLD_ON	1: Pause
13	WAITF	1: Wait
14	AT_L1_ON	0: Auto-tuning is OFF, 1: Auto-tuning is ON
15		

● Bit Configuration of D2009: PID_L1 (Current PID number)

Bit	Symbol	Event
0	PIDN.B0_L1	Bit-0 of the PID number
1	PIDN.B1_L1	Bit-1 of the PID number
2	PIDN.B2_L1	Bit-2 of the PID number
3 to 15		

● Bit Configuration of D2010: CSPNO. (Current control setpoint number)

Bit	Symbol	Event
0	CCSPN.B0	Bit-0 of control setpoint number
1	CCSPN.B1	Bit-1 of control setpoint number
2	CCSPN.B2	Bit-2 of control setpoint number
3 to 15		

● Bit Configuration of D2011: ALM_L1 (Alarm-1 to alarm-4 status)

Bit	Symbol	Event
0	ALM1_L1	'1' when Alarm 1 is ON; '0' when OFF
1	ALM2_L1	'1' when Alarm 2 is ON; '0' when OFF
2	ALM3_L1 *	'1' when Alarm 3 is ON; '0' when OFF
3		
4	ALM4_L1 *	'1' when Alarm 4 is ON; '0' when OFF
5 to 15		

*: Only for UT35A/UT32A.

● Bit Configuration of D2012: LA.ER (Ladder error status)

Bit	Symbol	Event
0	LAD_ERR	Corrupted ladder program
1	LAD_OVER	Ladder calculation overflow
2	LAD_P_ERR	Ladder program error
3		
4	LD100_OVER	Load factor over 100%
5	LD200_OVER	Load factor over 200% (Forced end)
6 to 15		

● D2035

Register No.	Description		Range and meaning of value
D2015	C.PTNO.	Current program pattern number	0 to 2 (4 when the option "/AP" is specified.)
D2016	SEG.N	Current segment number currently in operation	0: Not executing. 1 to 20 (40 when the option "/AP" is specified.)
D2017	SEG_RTIME	Remaining segment-time during operation/Elapsed time during wait.	0 to 59999 (minute or second) * Use the parameter TMU to set the time unit.
D2018 to D2032			
D2033	CTSP_L1	Final target setpoint	0.0 to 100.0% of PV input range (EU) (Setting range: P.RL to P.RH)
D2034			
D2035	DEV_L1	Deviation	-105.0 to 105.0% of PV input range span (EUS)

● Bit Configuration of D2037: ALO_L1 (Alarm-1 to alarm-4 output status)

Bit	Symbol	Event
0	ALO1_L1	Output status where Alarm output 1 is assigned. 0: When the alarm is turned off (alarm type: energized), or the alarm is turned on (alarm type: de-energized). (The relay contact is open.) 1: When the alarm is turned on (alarm type: energized), or the alarm is turned off (alarm type: de-energized). (The relay contact is closed.)
1	ALO2_L1	Output status where Alarm output 2 is assigned. For bit information, same as bit 0.
2	ALO3_L1 *	Output status where Alarm output 3 is assigned. For bit information, same as bit 0.
3		
4	ALO4_L1 *	Output status where Alarm output 4 is assigned. For bit information, same as bit 0.
5 to 15		

*: Only for UT35A/UT32A.

● Bit Configuration of D2039: PV_EV (PV event status)

Bit	Symbol	Event
0	PV_EV1	0: PV event is OFF
1	PV_EV2	1: PV event is ON
2 to 15		

● Bit Configuration of D2040: TIME_EV_1 (Time event status 1)

Bit	Symbol	Event
0	TIME_EV1	0: Time event is OFF 1: Time event is ON
1	TIME_EV2	
2	TIME_EV3	
3		
4	TIME_EV4	0: Time event is OFF 1: Time event is ON
5 to 15		

● D2044 to D2049

Register No.	Description		Range and meaning of value
D2044	SEG_USE	Number of segments contained in the selected pattern	0 to 20 (40 when the option "/AP" is specified.)
D2045	NOW_RCY	Number of repetitions of the pattern in operation	0 to 999
D2046	REM_RCY	Number of repetitions of the pattern in operation	0 to 999
D2047	ALL_RCY	Remaining number of repetitions of the pattern in operation	0 to 1000
D2048	NOW_RST	Repeat Start number of the current segment	1 to 20 (40 when the option "/AP" is specified.)
D2049	NOW_REN	Repeat End number of the current segment	1 to 20 (40 when the option "/AP" is specified.)

8.4 UT35A/UT32A/UP35A D Registers

● Bit Configuration of D2050: PV_EV_OUT (PV event output status)

Bit	Symbol	Event
0	PV_EV1_OUT	0: PV event output is OFF
1	PV_EV2_OUT	1: PV event output is ON
2 to 15		

● D2061, D2062

Register No.	Description		Range and meaning of value
D2061	HC1	Heter break alarm-1 current value display	0.0 to 360.0 Arms
D2062	HC2	Heter break alarm-2 current value display	0.0 to 360.0 Arms

● Bit Configuration of D2063: CT_AL (Heater break alarm status)

Bit	Symbol	Event
0	CT_AL1	'1' when heter break alarm-1 is ON; '0' when OFF
1	CT_AL2	'1' when heter break alarm-2 is ON; '0' when OFF
2 to 15		

● Bit Configuration of D2064: VALV (Valve status)

Bit	Symbol	Event
0	VALV_GUSS	0: Operation by feedback input 1: Operation by estimating type
1	VALV_OPEN	0: Output off, 1: Output on
2	VALV_CLOSE	0: Output off, 1: Output on
3	VALV_AT	0: Stop automatic valve position adjustment 1: Automatic valve position adjustment
4 to 15		

● Bit Configuration of D2065: AD2.E (A/D converter error status 2)

Bit	Symbol	Event
0	VALVBO	Feedback input resistor/current burnout
1	VALV_ATERR	Valve position automatic adjustment error
2 to 15		

● Bit Configuration of D2066: DIMG (Message display interruption status)

Bit	Symbol	Event
0	MG1.B	Message display interruption 1 (1: displayed, 0: not displayed)
1	MG2.B	Message display interruption 2 (1: displayed, 0: not displayed)
2	MG3.B	Message display interruption 3 (1: displayed, 0: not displayed)
3		
4	MG4.B	Message display interruption 4 (1: displayed, 0: not displayed)
5 to 15		

● **Bit Configuration of D2068: PA.ER (Parameter error status)**

Bit	Symbol	Event
0	SYSTEM_ERR	System data error
1	CALB_ERR	Calibration value error
2	UPARA_ERR	User (parameter) default value error
3		
4	SETPA_ERR	Setup parameter error
5	OPEPA_ERR	Operation parameter error
6	PROG_ERR *	Program pattern error
7		
8	FRAM_ERR	Faulty FRAM
9		
10	CTLPA_ERR	Control parameter error
11 to 15		

*: For UP35A only

● **Bit Configuration of D2070: OP.ER (Option error status)**

Bit	Symbol	Event
0	E1_ERR	Nonresponding hardware of E1 terminal area
1		
2	E3_ERR	Nonresponding hardware of E3 terminal area
3		
4	E4_ERR	Nonresponding hardware of E4 terminal area
5 to 7		
8	COM_E1_ERR *1	Communication error E1 terminal area
9		
10	COM_E3_ERR *2	Communication error E3 terminal area
11 to 15		

*1: For UT32A only

*2: For UT35A/UP35A only

● **Bit Configuration of D2071: ALOLA1_L1 (Alarm-1 to alarm-4 latch output status)**

Bit	Symbol	Event
0	ALO1LA1_L1	Alarm-1 latch-1 output status
1	ALO2LA1_L1	Alarm-2 latch-1 output status
2	ALO3LA1_L1 *	Alarm-3 latch-1 output status
3		
4	ALO4LA1_L1 *	Alarm-4 latch-1 output status
5 to 15		

*: For UT35A/UT32A only

● **Bit Configuration of D2073: ALOLA2_L1 (Alarm-1 to alarm-4 latch-2 output status)**

Bit	Symbol	Event
0	ALO1LA2_L1	Alarm-1 latch-2 output status
1	ALO2LA2_L1	Alarm-2 latch-2 output status
2	ALO3LA2_L1 *	Alarm-3 latch-2 output status
3		
4	ALO4LA2_L1 *	Alarm-4 latch-2 output status
5 to 15		

*: For UT35A/UT32A only

8.4 UT35A/UT32A/UP35A D Registers

● **Bit Configuration of D2075: ALOLA3_L1 (Alarm-1 to alarm-4 latch-3 output status)**

Bit	Symbol	Event
0	ALO1LA3_L1	Alarm-1 latch-3 output status
1	ALO2LA3_L1	Alarm-2 latch-3 output status
2	ALO3LA3_L1 *	Alarm-3 latch-3 output status
3		
4	ALO4LA3_L1 *	Alarm-4 latch-3 output status
5 to 15		

*: For UT35A/UT32A only

● **Bit Configuration of D2077: ALOLA4_L1 (Alarm-1 to alarm-4 latch-4 output status)**

Bit	Symbol	Event
0	ALO1LA4_L1	Alarm-1 latch-4 output status
1	ALO2LA4_L1	Alarm-2 latch-4 output status
2	ALO3LA4_L1 *	Alarm-3 latch-4 output status
3		
4	ALO4LA4_L1 *	Alarm-4 latch-4 output status
5 to 15		

*: For UT35A/UT32A only

Current SP Group and PID Group (D2101 to D2200)

Register No.	Description		Range and meaning of value
D2101	SP_L1_*	Target setpoint	0.0 to 100.0% of PV input range (EU) (Setting range: SPL to SPH)
D2102	SUB_*	Sub-target setpoint (in Two-position two-level control)	Set the offset from SP. -100.0 to 100.0% of PV input range span (EUS)
D2103	PIDN_L1_*	PID number selection	Set a PID group number to use. 1 to 4 (Depends on the PIDG. setting.)
D2104	A1_L1_*	Alarm-1 setpoint	Set a display value of setpoint of PV alarm, SP alarm, deviation alarm, output alarm, or velocity alarm. -19999 to 30000 (Set a value within the input range.) Decimal point position depends on the input type.
D2105	A2_L1_*	Alarm-2 setpoint	
D2106	A3_L1_*	Alarm-3 setpoint	
D2107	A4_L1_*	Alarm-4 setpoint	
D2108 to D2113			
D2114	P_L1_*	Proportional band Heating-side proportional band (in Heating/cooling control)	0.0 to 999.9% When 0.0 is set, it operates as 0.1. Heating-side ON/OFF control applies when 0.0 in Heating/cooling control
D2115	I_L1_*	Integral time Heating-side integral time (in Heating/cooling control)	0: OFF (Disable) 1 to 6000 s
D2116	D_L1_*	Derivative time Heating-side derivative time (in Heating/cooling control)	0: OFF (Disable) 1 to 6000 s
D2117	OH_L1_*	Control output high limit Heating-side control output high limit (in Heating/cooling control)	-4.9 to 105.0%, (OL<OH) In Heating/cooling control: 0.1 to 105.0% (OL<OH)
D2118	OL_L1_*	Control output low limit Heating-side control output low limit (in Heating/cooling control)	-5.0 to 104.9%, (OL<OH), SD: Tight shut In Heating/cooling control: 0.0 to 104.9% (OL<OH)
D2119	MR_L1_*	Manual reset	Enabled when integral time is OFF. The manual reset value equals the output value when PV = SP. -5.0 to 105.0%
D2120	HYS_L1_*	Hysteresis (in ON/OFF control, Position proportional control, or Two-position two-level control) Heating-side ON/OFF control hysteresis (in Heating/cooling control)	In ON/OFF control or Two-position two-level control: 0.0 to 100.0% of PV input range span (EUS) In Heating/cooling control or Position proportional control: 0.0 to 100.0%
D2121	SU.HY_L1_*	Sub-hysteresis (in Two-position two-level control)	0.0 to 100.0% of PV input range span (EUS)
D2122	HY.UP_L1_*	Upper-side hysteresis (in ON/OFF control)	0.0 to 100.0% of PV input range span (EUS)
D2123	HY.LO_L1_*	Lower-side hysteresis (in ON/OFF control)	
D2124	DR_L1_*	Direct/reverse action switch	0: RVS (Reverse action) 1: DIR (Direct action)
D2125	SU.DR_*	Sub-direct/reverse action switch (in Two-position two-level control)	
D2126	Pc_L1_*	Cooling-side proportional band	0.0 to 999.9% (Cooling-side ON/OFF control applies when 0.0 in Heating/cooling control)
D2127	Ic_L1_*	Cooling-side integral time	0: OFF (Disable) 1 to 6000 s
D2128	Dc_L1_*	Cooling-side derivative time	0: OFF (Disable) 1 to 6000 s
D2129	OHc_L1_*	Cooling-side control output high limit	0.1 to 105.0%, (OLc<OHc)

*: 1 to 4, or R

8.4 UT35A/UT32A/UP35A D Registers

Register No.	Description		Range and meaning of value
D2130	OLc_L1_*	Cooling-side control output low limit	0.0 to 104.9%, (OLc<OHc)
D2131	HYSc_L1_*	Cooling-side ON/OFF control hysteresis	0.0 to 100.0%
D2132	DB_L1_*	Output dead band (in Heating/cooling control or Position proportional control)	In Heating/cooling control: -100.0 to 50.0% In Position proportional control: 1.0 to 10.0%
D2133	PO_L1_*	Preset output Heating-side preset output (in Heating/cooling control)	In STOP mode, fixed control output can be generated. In Position proportional control, Valve opening can be set -5.0 to 105.0%
D2134	SU.PO_*	Sub-preset output (in Two-position two-level control)	In STOP mode, fixed sub-control output can be generated. 0%, 100%
D2135	POc_L1_*	Cooling-side preset output	In STOP mode, cooling-side fixed control output can be generated. -5.0 to 105.0%
D2136 to D2200			

*: 1 to 4, or R

Local-mode Operation Setting for UP35A (D2201 to D2300)

Register No.	Description		Range and meaning of value
D2201	LSP_L1	Local target setpoint	0.0 to 100.0% of PV input range (EU) (Setting range: P.RL to P.RH)
D2202			
D2203	L.PID	PID number selection for local-mode operation	Set a PID group number to use. 1 to 4 * Available only for the L.PID when ZON = 0 or 5. * If set to "Local PID selection," local PID is selected irrespective of the operation modes.
D2204	L.TY1	Local event-1 type	OFF: Disable (Energized) 01: PV high limit, 02: PV low limit, 03: SP high limit, 04: SP low limit, 05: Deviation high limit, 06: Deviation low limit, 07: Deviation high and low limits, 08: Deviation within high and low limits, 09: Target SP high limit, 10: Target SP low limit, 11: Target SP deviation high limit, 12: Target SP deviation low limit, 13: Target SP deviation high and low limits, 14: Target SP deviation within high and low limits, 15: OUT high limit, 16: OUT low limit, 17: Cooling-side OUT high limit, 18: Cooling-side OUT low limit * Add 100 for "de-energized". For example, when the PV high limit is de-energized, the setting is 101.
D2205	L.EV1	Local event-1 setpoint	Set a display value of setpoint of PV alarm, SP alarm, deviation alarm, or output alarm. -19999 to 30000 (Set a value within the input range.) Decimal point position depends on the input type
D2206	L.TY2	Local event-2 type	Same as D2204
D2207	L.EV2	Local event-2 setpoint	Same as D2205
D2208 to D2300			

8.4.2 Operation Mode Parameter and Operation Parameter for UP35A (D2301 to D2500)

Operation mode parameters													
Operation mode (Menu: MODE), Alarm setpoint setting (Menu:AL)													
D-Reg No.	Ref. No.	H No.	Register Symbol	R/W			D-Reg No.	Ref. No.	H No.	Register Symbol	R/W		
				UT 35A	UT 32A	UP 35A					UT 35A	UT 32A	UP 35A
D2301	42301	08FC	A.M	R/W	R/W		D2351	42351	092E	A1_L1			R/W
D2302	42302	08FD					D2352	42352	092F	A2_L1			R/W
D2303	42303	08FE					D2353	42353	0930				
D2304	42304	08FF	S.R	R/W	R/W		D2354	42354	0931				
D2305	42305	0900					D2355	42355	0932				
D2306	42306	0901	R.L_L1	R/W	R/W		D2356	42356	0933				
D2307	42307	0902					D2357	42357	0934				
D2308	42308	0903	AT_L1	R/W	R/W		D2358	42358	0935				
D2309	42309	0904					D2359	42359	0936				
D2310	42310	0905					D2360	42360	0937				
D2311	42311	0906					D2361	42361	0938				
D2312	42312	0907	SPNO.	R/W	R/W		D2362	42362	0939				
D2313	42313	0908					D2363	42363	093A				
D2314	42314	0909	TRK_ON_L1	R/W	R/W	R/W	D2364	42364	093B				
D2315	42315	090A					D2365	42365	093C				
D2316	42316	090B	MODE			R/W	D2366	42366	093D				
D2317	42317	090C	HOLD			R/W	D2367	42367	093E				
D2318	42318	090D	ADV			R/W	D2368	42368	093F				
D2319	42319	090E	A.M_L1			R/W	D2369	42369	0940				
D2320	42320	090F					D2370	42370	0941				
D2321	42321	0910					D2371	42371	0942				
D2322	42322	0911	PTNO.			R/W	D2372	42372	0943				
D2323	42323	0912					D2373	42373	0944				
D2324	42324	0913					D2374	42374	0945				
D2325	42325	0914					D2375	42375	0946				
D2326	42326	0915					D2376	42376	0947				
D2327	42327	0916					D2377	42377	0948				
D2328	42328	0917					D2378	42378	0949				
D2329	42329	0918					D2379	42379	094A				
D2330	42330	0919					D2380	42380	094B				
D2331	42331	091A	C.RSP_L1	R/W	R/W		D2381	42381	094C				
D2332	42332	091B					D2382	42382	094D				
D2333	42333	091C	MOUT_L1	R/W	R/W	R/W	D2383	42383	094E				
D2334	42334	091D	MOUTc_L1	R/W	R/W	R/W	D2384	42384	094F				
D2335	42335	091E					D2385	42385	0950				
D2336	42336	091F					D2386	42386	0951				
D2337	42337	0920	H.SP_L1			R/W	D2387	42387	0952				
D2338	42338	0921					D2388	42388	0953				
D2339	42339	0922	H.TSP_L1			R/W	D2389	42389	0954				
D2340	42340	0923					D2390	42390	0955				
D2341	42341	0924	H.TM			R/W	D2391	42391	0956				
D2342	42342	0925	SST			R/W	D2392	42392	0957				
D2343	42343	0926	P.FWD			R/W	D2393	42393	0958				
D2344	42344	0927					D2394	42394	0959				
D2345	42345	0928					D2395	42395	095A				
D2346	42346	0929					D2396	42396	095B				
D2347	42347	092A					D2397	42397	095C				
D2348	42348	092B					D2398	42398	095D				
D2349	42349	092C					D2399	42399	095E				
D2350	42350	092D					D2400	42400	095F				

D2401 to D2500: Free area

8.4 UT35A/UT32A/UP35A D Registers

Operation Mode and Alarm Setpoint Setting for UP35A (D2301 to D2400)

Register No.		Description	Range and meaning of value
D2301	A.M	AUTO/MAN switch	0: AUTO (Automatic mode) 1: MAN (Manual mode)
D2302 to D2303			
D2304	S.R	STOP/RUN switch	0: RUN (Run mode) 1: STOP (Stop mode) Preset output (PO) is generated in STOP mode. Default: Not displayed. STOP/RUN switch is assigned to contact input.
D2305			
D2306	R.L_L1	REMOTE/LOCAL switch	0: LCL (Local mode) 1: REM (Remote mode) (Displayed only in cases where the communication is specified.)
D2307			
D2308	AT_L1	Auto-tuning switch	0: OFF (Disable) 1 to 4: Perform auto-tuning. Tuning result is stored in the specified numbered PID. 9: R (Tuning result is stored in the PID for reference deviation.)
D2309 to D2311			
D2312	SPNO.	SP number selection	1 to 4 (Depends on the setup parameter SPGR. setting.)
D2313			
D2314	TRK_ON_L1	Output tracking status	0: OFF 1: ON
D2315			
D2316	MODE	Operation mode (Start/stop of program operation / start of local-mode operation / start of remote-mode operation)	0: RESET (Stop of program operation) 1: PROG (Start of program operation) 2: LOCAL (Start of local-mode operation)
D2317	HOLD	Pause/cancel release of program operation	Display during program operation. 0: OFF (Cancel release (Program operation restart)) 1: ON (Pause)
D2318	ADV	Advance of segment	Display during program operation. Set as "ADV = 1 (ON)" to advance from the current segment to the next segment.
D2319	A.M_L1	AUTO/MAN switch	0: AUTO (Automatic mode) 1: MAN (Manual mode)
D2320 to D2321			
D2322	PTNO.	Program pattern number selection	0: Not select program pattern 1 to 2 (4 when the option "/AP" is specified.)
D2323 to D2330			
D2331	C.RSP_L1	Communication remote setpoint	0.0 to 100.0% of PV input range (EU)
D2332			
D2333	MOUT_L1	Heating-side control output in MAN mode	0.0 to 105.0% (Standard type: -5.0 to 105.0%)
D2334	MOUTc_L1	Cooling-side control output in MAN mode	0.0 to 105.0%
D2335 to D2400			
D2337	H.SP_L1	SP for HOLD state	0.0 to 100.0% of PV input range (EU)
D2338			
D2339	H.TSP_L1	TSP for HOLD state	0.0 to 100.0% of PV input range (EU)
D2340			
D2341	H.TM	HOLD time	0 to 59999 (minute or second) * Use the parameter TMU to set the time unit.
D2343	SST	Start-of-program segment number	1 to 20 (40 when the option "/AP" is specified.) The setting value returns to "1" when the program operation (PROG) changes into RESET, LOCAL, or REM.

8.4 UT35A/UT32A/UP35A D Registers

Register No.	Description		Range and meaning of value
D2343	P.FWD	Fast-forwarding of program operation	1: Normal 2: Twice 5: Five times 10: Ten times 20: Twenty times * Use this function when checking the program pattern setting. Only Segment time and Time event can be faster. * The operation returns to the normal speed after fast-forwarding.
D2344 to D2350			
D2351	A1_L1_1	Alarm-1 setpoint	These alarms work irrespective of the operation mode. Set a display value of setpoint of PV alarm, SP alarm, deviation alarm, output alarm, or velocity alarm. -19999 to 30000 (Set a value within the input range.) Decimal point position depends on the input type.
D2352	A2_L1_1	Alarm-2 setpoint	
D2335 to D2400			

Free Area (D2401 to D2500)

Register No.	Description		Range and meaning of value
D2401 to D2500		Free area	

8.4 UT35A/UT32A/UP35A D Registers

8.4.3 Operation Parameter (D2501 to D4700)

Operation parameter													
SP and alarm setpoint setting (Menu: SP)													
D-Reg No.	Ref. No.	H No.	Register symbol	R/W			D-Reg No.	Ref. No.	H No.	Register symbol	R/W		
				UT 35A	UT 32A	UP 35A					UT 35A	UT 32A	UP 35A
D2501	42501	09C4	SP_L1_1	R/W	R/W		D2551	42551	09F6				
D2502	42502	09C5	SUB_1	R/W	R/W		D2552	42552	09F7				
D2503	42503	09C6	PIDN_L1_1	R/W	R/W		D2553	42553	09F8				
D2504	42504	09C7	A1_L1_1	R/W	R/W		D2554	42554	09F9				
D2505	42505	09C8	A2_L1_1	R/W	R/W		D2555	42555	09FA				
D2506	42506	09C9	A3_L1_1	R/W	R/W		D2556	42556	09FB				
D2507	42507	09CA	A4_L1_1	R/W	R/W		D2557	42557	09FC				
D2508	42508	09CB					D2558	42558	09FD				
D2509	42509	09CC					D2559	42559	09FE				
D2510	42510	09CD					D2560	42560	09FF				
D2511	42511	09CE					D2561	42561	0A00	SP_L1_4	R/W	R/W	
D2512	42512	09CF					D2562	42562	0A01	SUB_4	R/W	R/W	
D2513	42513	09D0					D2563	42563	0A02	PIDN_L1_4	R/W	R/W	
D2514	42514	09D1					D2564	42564	0A03	A1_L1_4	R/W	R/W	
D2515	42515	09D2					D2565	42565	0A04	A2_L1_4	R/W	R/W	
D2516	42516	09D3					D2566	42566	0A05	A3_L1_4	R/W	R/W	
D2517	42517	09D4					D2567	42567	0A06	A4_L1_4	R/W	R/W	
D2518	42518	09D5					D2568	42568	0A07				
D2519	42519	09D6					D2569	42569	0A08				
D2520	42520	09D7					D2570	42570	0A09				
D2521	42521	09D8	SP_L1_2	R/W	R/W		D2571	42571	0A0A				
D2522	42522	09D9	SUB_2	R/W	R/W		D2572	42572	0A0B				
D2523	42523	09DA	PIDN_L1_2	R/W	R/W		D2573	42573	0A0C				
D2524	42524	09DB	A1_L1_2	R/W	R/W		D2574	42574	0A0D				
D2525	42525	09DC	A2_L1_2	R/W	R/W		D2575	42575	0A0E				
D2526	42526	09DD	A3_L1_2	R/W	R/W		D2576	42576	0A0F				
D2527	42527	09DE	A4_L1_2	R/W	R/W		D2577	42577	0A10				
D2528	42528	09DF					D2578	42578	0A11				
D2529	42529	09E0					D2579	42579	0A12				
D2530	42530	09E1					D2580	42580	0A13				
D2531	42531	09E2					D2581	42581	0A14				
D2532	42532	09E3					D2582	42582	0A15				
D2533	42533	09E4					D2583	42583	0A16				
D2534	42534	09E5					D2584	42584	0A17				
D2535	42535	09E6					D2585	42585	0A18				
D2536	42536	09E7					D2586	42586	0A19				
D2537	42537	09E8					D2587	42587	0A1A				
D2538	42538	09E9					D2588	42588	0A1B				
D2539	42539	09EA					D2589	42589	0A1C				
D2540	42540	09EB					D2590	42590	0A1D				
D2541	42541	09EC	SP_L1_3	R/W	R/W		D2591	42591	0A1E				
D2542	42542	09ED	SUB_3	R/W	R/W		D2592	42592	0A1F				
D2543	42543	09EE	PIDN_L1_3	R/W	R/W		D2593	42593	0A20				
D2544	42544	09EF	A1_L1_3	R/W	R/W		D2594	42594	0A21				
D2545	42545	09F0	A2_L1_3	R/W	R/W		D2595	42595	0A22				
D2546	42546	09F1	A3_L1_3	R/W	R/W		D2596	42596	0A23				
D2547	42547	09F2	A4_L1_3	R/W	R/W		D2597	42597	0A24				
D2548	42548	09F3					D2598	42598	0A25				
D2549	42549	09F4					D2599	42599	0A26				
D2550	42550	09F5					D2600	42600	0A27				

D2601 to D2700: Free area

Operation parameter													
SP-related setting (Menu: SPS)													
D-Reg No.	Ref. No.	H No.	Register symbol	R/W			D-Reg No.	Ref. No.	H No.	Register symbol	R/W		
				UT 35A	UT 32A	UP 35A					UT 35A	UT 32A	UP 35A
D2701	42701	0A8C					D2751	42751	0ABE				
D2702	42702	0A8D					D2752	42752	0ABF				
D2703	42703	0A8E	RT_L1	R/W	R/W	/	D2753	42753	0AC0				
D2704	42704	0A8F	RBS_L1	R/W	R/W	/	D2754	42754	0AC1				
D2705	42705	0A90	UPR_L1	R/W	R/W	/	D2755	42755	0AC2				
D2706	42706	0A91	DNR_L1	R/W	R/W	/	D2756	42756	0AC3				
D2707	42707	0A92	TMU_L1	R/W	R/W	/	D2757	42757	0AC4				
D2708	42708	0A93					D2758	42758	0AC5				
D2709	42709	0A94					D2759	42759	0AC6				
D2710	42710	0A95	SPT_L1	R/W	R/W	R/W	D2760	42760	0AC7				
D2711	42711	0A96	PVT_L1	R/W	R/W	/	D2761	42761	0AC8				
D2712	42712	0A97	S.TM	/	/	R/W	D2762	42762	0AC9				
D2713	42713	0A98	PNC	/	/	R/W	D2763	42763	0ACA				
D2714	42714	0A99					D2764	42764	0ACB				
D2715	42715	0A9A					D2765	42765	0ACC				
D2716	42716	0A9B					D2766	42766	0ACD				
D2717	42717	0A9C					D2767	42767	0ACE				
D2718	42718	0A9D					D2768	42768	0ACF				
D2719	42719	0A9E					D2769	42769	0AD0				
D2720	42720	0A9F					D2770	42770	0AD1				
D2721	42721	0AA0					D2771	42771	0AD2				
D2722	42722	0AA1					D2772	42772	0AD3				
D2723	42723	0AA2					D2773	42773	0AD4				
D2724	42724	0AA3					D2774	42774	0AD5				
D2725	42725	0AA4					D2775	42775	0AD6				
D2726	42726	0AA5					D2776	42776	0AD7				
D2727	42727	0AA6					D2777	42777	0AD8				
D2728	42728	0AA7					D2778	42778	0AD9				
D2729	42729	0AA8					D2779	42779	0ADA				
D2730	42730	0AA9					D2780	42780	0ADB				
D2731	42731	0AAA					D2781	42781	0ADC				
D2732	42732	0AAB					D2782	42782	0ADD				
D2733	42733	0AAC					D2783	42783	0ADE				
D2734	42734	0AAD					D2784	42784	0ADF				
D2735	42735	0AAE					D2785	42785	0AE0				
D2736	42736	0AAF					D2786	42786	0AE1				
D2737	42737	0AB0					D2787	42787	0AE2				
D2738	42738	0AB1					D2788	42788	0AE3				
D2739	42739	0AB2					D2789	42789	0AE4				
D2740	42740	0AB3					D2790	42790	0AE5				
D2741	42741	0AB4					D2791	42791	0AE6				
D2742	42742	0AB5					D2792	42792	0AE7				
D2743	42743	0AB6					D2793	42793	0AE8				
D2744	42744	0AB7					D2794	42794	0AE9				
D2745	42745	0AB8					D2795	42795	0AEA				
D2746	42746	0AB9					D2796	42796	0AEB				
D2747	42747	0ABA					D2797	42797	0AEC				
D2748	42748	0ABB					D2798	42798	0AED				
D2749	42749	0ABC					D2799	42799	0AEE				
D2750	42750	0ABD					D2800	42800	0AEF				

8.4 UT35A/UT32A/UP35A D Registers

Operation parameter													
Alarm function setting (Menu: ALRM)													
D-Reg No.	Ref. No.	H No.	Register symbol	R/W			D-Reg No.	Ref. No.	H No.	Register symbol	R/W		
				UT 35A	UT 32A	UT 32A					UT 35A	UT 32A	UO 35A
D2801	42801	0AF0	AL1.T_L1	R/W	R/W	R/W	D2851	42851	0B22	DYN3_L1	R/W	R/W	
D2802	42802	0AF1	AL1.W_L1	R/W	R/W	R/W	D2852	42852	0B23	DYN4_L1	R/W	R/W	
D2803	42803	0AF2	AL1.D_L1	R/W	R/W	R/W	D2853	42853	0B24				
D2804	42804	0AF3	AL1.L_L1	R/W	R/W	R/W	D2854	42854	0B25				
D2805	42805	0AF4	AL2.T_L1	R/W	R/W	R/W	D2855	42855	0B26				
D2806	42806	0AF5	AL2.W_L1	R/W	R/W	R/W	D2856	42856	0B27				
D2807	42807	0AF6	AL2.D_L1	R/W	R/W	R/W	D2857	42857	0B28	DYF1_L1	R/W	R/W	R/W
D2808	42808	0AF7	AL2.L_L1	R/W	R/W	R/W	D2858	42858	0B29	DYF2_L1	R/W	R/W	R/W
D2809	42809	0AF8	AL3.T_L1	R/W	R/W		D2859	42859	0B2A	DYF3_L1	R/W	R/W	
D2810	42810	0AF9	AL3.W_L1	R/W	R/W		D2860	42860	0B2B	DYF4_L1	R/W	R/W	
D2811	42811	0AFA	AL3.D_L1	R/W	R/W		D2861	42861	0B2C				
D2812	42812	0AFB	AL3.L_L1	R/W	R/W		D2862	42862	0B2D				
D2813	42813	0AFC	AL4.T_L1	R/W	R/W		D2863	42863	0B2E				
D2814	42814	0AFD	AL4.W_L1	R/W	R/W		D2864	42864	0B2F				
D2815	42815	0AFE	AL4.D_L1	R/W	R/W		D2865	42865	0B30				
D2816	42816	0AFF	AL4.L_L1	R/W	R/W		D2866	42866	0B31	AMD_L1	R/W	R/W	R/W
D2817	42817	0B00					D2867	42867	0B32				
D2818	42818	0B01					D2868	42868	0B33				
D2819	42819	0B02					D2869	42869	0B34				
D2820	42820	0B03					D2870	42870	0B35				
D2821	42821	0B04					D2871	42871	0B36	EHY1			R/W
D2822	42822	0B05					D2872	42872	0B37	EHY2			R/W
D2823	42823	0B06					D2873	42873	0B38				
D2824	42824	0B07					D2874	42874	0B39				
D2825	42825	0B08					D2875	42875	0B3A				
D2826	42826	0B09					D2876	42876	0B3B				
D2827	42827	0B0A					D2877	42877	0B3C				
D2828	42828	0B0B					D2878	42878	0B3D				
D2829	42829	0B0C					D2879	42879	0B3E				
D2830	42830	0B0D					D2880	42880	0B3F				
D2831	42831	0B0E					D2881	42881	0B40				
D2832	42832	0B0F					D2882	42882	0B41				
D2833	42833	0B10	VT1_L1	R/W	R/W	R/W	D2883	42883	0B42				
D2834	42834	0B11	VT2_L1	R/W	R/W	R/W	D2884	42884	0B43				
D2835	42835	0B12	VT3_L1	R/W	R/W		D2885	42885	0B44				
D2836	42836	0B13	VT4_L1	R/W	R/W		D2886	42886	0B45				
D2837	42837	0B14					D2887	42887	0B46				
D2838	42838	0B15					D2888	42888	0B47				
D2839	42839	0B16					D2889	42889	0B48				
D2840	42840	0B17					D2890	42890	0B49				
D2841	42841	0B18	HY1_L1	R/W	R/W	R/W	D2891	42891	0B4A				
D2842	42842	0B19	HY2_L1	R/W	R/W	R/W	D2892	42892	0B4B				
D2843	42843	0B1A	HY3_L1	R/W	R/W		D2893	42893	0B4C				
D2844	42844	0B1B	HY4_L1	R/W	R/W		D2894	42894	0B4D				
D2845	42845	0B1C					D2895	42895	0B4E				
D2846	42846	0B1D					D2896	42896	0B4F				
D2847	42847	0B1E					D2897	42897	0B50				
D2848	42848	0B1F					D2898	42898	0B51				
D2849	42849	0B20	DYN1_L1	R/W	R/W	R/W	D2899	42899	0B52				
D2850	42850	0B21	DYN2_L1	R/W	R/W	R/W	D2900	42900	0B53				

Operation parameter													
PV-related setting (Menu: PVS)													
D-Reg No.	Ref. No.	H No.	Register symbol	R/W			D-Reg No.	Ref. No.	H No.	Register symbol	R/W		
				UT 35A	UT 32A	UP 35A					UT 35A	UT 32A	UT 32A
D2901	42901	0B54	BS_L1	R/W	R/W	R/W	D2951	42951	0B86				
D2902	42902	0B55	FL_L1	R/W	R/W	R/W	D2952	42952	0B87				
D2903	42903	0B56					D2953	42953	0B88				
D2904	42904	0B57					D2954	42954	0B89				
D2905	42905	0B58					D2955	42955	0B8A				
D2906	42906	0B59					D2956	42956	0B8B				
D2907	42907	0B5A					D2957	42957	0B8C				
D2908	42908	0B5B					D2958	42958	0B8D				
D2909	42909	0B5C					D2959	42959	0B8E				
D2910	42910	0B5D					D2960	42960	0B8F				
D2911	42911	0B5E					D2961	42961	0B90				
D2912	42912	0B5F					D2962	42962	0B91				
D2913	42913	0B60					D2963	42963	0B92				
D2914	42914	0B61					D2964	42964	0B93				
D2915	42915	0B62					D2965	42965	0B94				
D2916	42916	0B63					D2966	42966	0B95				
D2917	42917	0B64					D2967	42967	0B96				
D2918	42918	0B65					D2968	42968	0B97				
D2919	42919	0B66					D2969	42969	0B98				
D2920	42920	0B67					D2970	42970	0B99				
D2921	42921	0B68					D2971	42971	0B9A				
D2922	42922	0B69					D2972	42972	0B9B				
D2923	42923	0B6A					D2973	42973	0B9C				
D2924	42924	0B6B					D2974	42974	0B9D				
D2925	42925	0B6C					D2975	42975	0B9E				
D2926	42926	0B6D					D2976	42976	0B9F				
D2927	42927	0B6E					D2977	42977	0BA0				
D2928	42928	0B6F					D2978	42978	0BA1				
D2929	42929	0B70					D2979	42979	0BA2				
D2930	42930	0B71					D2980	42980	0BA3				
D2931	42931	0B72					D2981	42981	0BA4				
D2932	42932	0B73					D2982	42982	0BA5				
D2933	42933	0B74					D2983	42983	0BA6				
D2934	42934	0B75					D2984	42984	0BA7				
D2935	42935	0B76					D2985	42985	0BA8				
D2936	42936	0B77					D2986	42986	0BA9				
D2937	42937	0B78					D2987	42987	0BAA				
D2938	42938	0B79					D2988	42988	0BAB				
D2939	42939	0B7A					D2989	42989	0BAC				
D2940	42940	0B7B					D2990	42990	0BAD				
D2941	42941	0B7C					D2991	42991	0BAE				
D2942	42942	0B7D					D2992	42992	0BAF				
D2943	42943	0B7E					D2993	42993	0BB0				
D2944	42944	0B7F					D2994	42994	0BB1				
D2945	42945	0B80					D2995	42995	0BB2				
D2946	42946	0B81					D2996	42996	0BB3				
D2947	42947	0B82					D2997	42997	0BB4				
D2948	42948	0B83					D2998	42998	0BB5				
D2949	42949	0B84					D2999	42999	0BB6				
D2950	42950	0B85					D3000	43000	0BB7				

8.4 UT35A/UT32A/UP35A D Registers

Operation parameter													
PID setting (Menu: PID)													
D-Reg No.	Ref. No.	H No.	Register symbol	R/W			D-Reg No.	Ref. No.	H No.	Register symbol	R/W		
				UT 35A	UT 32A	UP 35A					UT 35A	UT 32A	UP 35A
D3001	43001	0BB8	P_L1_1	R/W	R/W	R/W	D3051	43051	0BEA	P_L1_2	R/W	R/W	R/W
D3002	43002	0BB9	I_L1_1	R/W	R/W	R/W	D3052	43052	0BEB	I_L1_2	R/W	R/W	R/W
D3003	43003	0BBA	D_L1_1	R/W	R/W	R/W	D3053	43053	0BEC	D_L1_2	R/W	R/W	R/W
D3004	43004	0BBB	OH_L1_1	R/W	R/W	R/W	D3054	43054	0BED	OH_L1_2	R/W	R/W	R/W
D3005	43005	0BBC	OL_L1_1	R/W	R/W	R/W	D3055	43055	0BEE	OL_L1_2	R/W	R/W	R/W
D3006	43006	0BBD	MR_L1_1	R/W	R/W	R/W	D3056	43056	0BEF	MR_L1_2	R/W	R/W	R/W
D3007	43007	0BBE	HYS_L1_1	R/W	R/W	R/W	D3057	43057	0BF0	HYS_L1_2	R/W	R/W	R/W
D3008	43008	0BBF	SU.HY_1	R/W	R/W		D3058	43058	0BF1	SU.HY_2	R/W	R/W	
D3009	43009	0BC0	HY.UP_L1_1	R/W	R/W	R/W	D3059	43059	0BF2	HY.UP_L1_2	R/W	R/W	R/W
D3010	43010	0BC1	HY.LO_L1_1	R/W	R/W	R/W	D3060	43060	0BF3	HY.LO_L1_2	R/W	R/W	R/W
D3011	43011	0BC2	DR_L1_1	R/W	R/W	R/W	D3061	43061	0BF4	DR_L1_2	R/W	R/W	R/W
D3012	43012	0BC3	SU.DR_1	R/W	R/W		D3062	43062	0BF5	SU.DR_2	R/W	R/W	
D3013	43013	0BC4	Pc_L1_1	R/W	R/W	R/W	D3063	43063	0BF6	Pc_L1_2	R/W	R/W	R/W
D3014	43014	0BC5	Ic_L1_1	R/W	R/W	R/W	D3064	43064	0BF7	Ic_L1_2	R/W	R/W	R/W
D3015	43015	0BC6	Dc_L1_1	R/W	R/W	R/W	D3065	43065	0BF8	Dc_L1_2	R/W	R/W	R/W
D3016	43016	0BC7	OHc_L1_1	R/W	R/W	R/W	D3066	43066	0BF9	OHc_L1_2	R/W	R/W	R/W
D3017	43017	0BC8	OLc_L1_1	R/W	R/W	R/W	D3067	43067	0BFA	OLc_L1_2	R/W	R/W	R/W
D3018	43018	0BC9	HYSc_L1_1	R/W	R/W	R/W	D3068	43068	0BFB	HYSc_L1_2	R/W	R/W	R/W
D3019	43019	0BCA	DB_L1_1	R/W	R/W	R/W	D3069	43069	0BFC	DB_L1_2	R/W	R/W	R/W
D3020	43020	0BCB	PO_L1_1	R/W	R/W	R/W	D3070	43070	0BFD	PO_L1_2	R/W	R/W	R/W
D3021	43021	0BCC	SU.PO_1	R/W	R/W		D3071	43071	0BFE	SU.PO_2	R/W	R/W	
D3022	43022	0BCD	POc_L1_1	R/W	R/W	R/W	D3072	43072	0BFF	POc_L1_2	R/W	R/W	R/W
D3023	43023	0BCE					D3073	43073	0C00				
D3024	43024	0BCF					D3074	43074	0C01				
D3025	43025	0BD0					D3075	43075	0C02				
D3026	43026	0BD1					D3076	43076	0C03				
D3027	43027	0BD2					D3077	43077	0C04				
D3028	43028	0BD3					D3078	43078	0C05				
D3029	43029	0BD4					D3079	43079	0C06				
D3030	43030	0BD5					D3080	43080	0C07				
D3031	43031	0BD6					D3081	43081	0C08				
D3032	43032	0BD7					D3082	43082	0C09				
D3033	43033	0BD8					D3083	43083	0C0A				
D3034	43034	0BD9					D3084	43084	0C0B				
D3035	43035	0BDA					D3085	43085	0C0C				
D3036	43036	0BDB					D3086	43086	0C0D				
D3037	43037	0BDC					D3087	43087	0C0E				
D3038	43038	0BDD					D3088	43088	0C0F				
D3039	43039	0BDE					D3089	43089	0C10				
D3040	43040	0BDF					D3090	43090	0C11				
D3041	43041	0BE0					D3091	43091	0C12				
D3042	43042	0BE1					D3092	43092	0C13				
D3043	43043	0BE2					D3093	43093	0C14				
D3044	43044	0BE3					D3094	43094	0C15				
D3045	43045	0BE4					D3095	43095	0C16				
D3046	43046	0BE5					D3096	43096	0C17				
D3047	43047	0BE6					D3097	43097	0C18				
D3048	43048	0BE7					D3098	43098	0C19				
D3049	43049	0BE8					D3099	43099	0C1A				
D3050	43050	0BE9					D3100	43100	0C1B				

Operation parameter													
PID setting (Menu: PID)													
D-Reg No.	Ref. No.	H No.	Register symbol	R/W			D-Reg No.	Ref. No.	H No.	Register symbol	R/W		
				UT 35A	UT 32A	UP 35A					UT 35A	UT 32A	UP 35A
D3101	43101	0C1C	P_L1_3	R/W	R/W	R/W	D3151	43151	0C4E	P_L1_4	R/W	R/W	R/W
D3102	43102	0C1D	I_L1_3	R/W	R/W	R/W	D3152	43152	0C4F	I_L1_4	R/W	R/W	R/W
D3103	43103	0C1E	D_L1_3	R/W	R/W	R/W	D3153	43153	0C50	D_L1_4	R/W	R/W	R/W
D3104	43104	0C1F	OH_L1_3	R/W	R/W	R/W	D3154	43154	0C51	OH_L1_4	R/W	R/W	R/W
D3105	43105	0C20	OL_L1_3	R/W	R/W	R/W	D3155	43155	0C52	OL_L1_4	R/W	R/W	R/W
D3106	43106	0C21	MR_L1_3	R/W	R/W	R/W	D3156	43156	0C53	MR_L1_4	R/W	R/W	R/W
D3107	43107	0C22	HYS_L1_3	R/W	R/W	R/W	D3157	43157	0C54	HYS_L1_4	R/W	R/W	R/W
D3108	43108	0C23	SU.HY_3	R/W	R/W	/	D3158	43158	0C55	SU.HY_4	R/W	R/W	/
D3109	43109	0C24	HY.UP_L1_3	R/W	R/W	R/W	D3159	43159	0C56	HY.UP_L1_4	R/W	R/W	R/W
D3110	43110	0C25	HY.LO_L1_3	R/W	R/W	R/W	D3160	43160	0C57	HY.LO_L1_4	R/W	R/W	R/W
D3111	43111	0C26	DR_L1_3	R/W	R/W	R/W	D3161	43161	0C58	DR_L1_4	R/W	R/W	R/W
D3112	43112	0C27	SU.DR_3	R/W	R/W	/	D3162	43162	0C59	SU.DR_4	R/W	R/W	/
D3113	43113	0C28	Pc_L1_3	R/W	R/W	R/W	D3163	43163	0C5A	Pc_L1_4	R/W	R/W	R/W
D3114	43114	0C29	Ic_L1_3	R/W	R/W	R/W	D3164	43164	0C5B	Ic_L1_4	R/W	R/W	R/W
D3115	43115	0C2A	Dc_L1_3	R/W	R/W	R/W	D3165	43165	0C5C	Dc_L1_4	R/W	R/W	R/W
D3116	43116	0C2B	OHc_L1_3	R/W	R/W	R/W	D3166	43166	0C5D	OHc_L1_4	R/W	R/W	R/W
D3117	43117	0C2C	OLc_L1_3	R/W	R/W	R/W	D3167	43167	0C5E	OLc_L1_4	R/W	R/W	R/W
D3118	43118	0C2D	HYS_L1_3	R/W	R/W	R/W	D3168	43168	0C5F	HYS_L1_4	R/W	R/W	R/W
D3119	43119	0C2E	DB_L1_3	R/W	R/W	R/W	D3169	43169	0C60	DB_L1_4	R/W	R/W	R/W
D3120	43120	0C2F	PO_L1_3	R/W	R/W	R/W	D3170	43170	0C61	PO_L1_4	R/W	R/W	R/W
D3121	43121	0C30	SU.PO_3	R/W	R/W	/	D3171	43171	0C62	SU.PO_4	R/W	R/W	/
D3122	43122	0C31	POc_L1_2	R/W	R/W	R/W	D3172	43172	0C63	POc_L1_4	R/W	R/W	R/W
D3123	43123	0C32					D3173	43173	0C64				
D3124	43124	0C33					D3174	43174	0C65				
D3125	43125	0C34					D3175	43175	0C66				
D3126	43126	0C35					D3176	43176	0C67				
D3127	43127	0C36					D3177	43177	0C68				
D3128	43128	0C37					D3178	43178	0C69				
D3129	43129	0C38					D3179	43179	0C6A				
D3130	43130	0C39					D3180	43180	0C6B				
D3131	43131	0C3A					D3181	43181	0C6C				
D3132	43132	0C3B					D3182	43182	0C6D				
D3133	43133	0C3C					D3183	43183	0C6E				
D3134	43134	0C3D					D3184	43184	0C6F				
D3135	43135	0C3E					D3185	43185	0C70				
D3136	43136	0C3F					D3186	43186	0C71				
D3137	43137	0C40					D3187	43187	0C72				
D3138	43138	0C41					D3188	43188	0C73				
D3139	43139	0C42					D3189	43189	0C74				
D3140	43140	0C43					D3190	43190	0C75				
D3141	43141	0C44					D3191	43191	0C76				
D3142	43142	0C45					D3192	43192	0C77				
D3143	43143	0C46					D3193	43193	0C78				
D3144	43144	0C47					D3194	43194	0C79				
D3145	43145	0C48					D3195	43195	0C7A				
D3146	43146	0C49					D3196	43196	0C7B				
D3147	43147	0C4A					D3197	43197	0C7C				
D3148	43148	0C4B					D3198	43198	0C7D				
D3149	43149	0C4C					D3199	43199	0C7E				
D3150	43150	0C4D					D3200	43200	0C7F				

D3201 to D3400: Free area

8.4 UT35A/UT32A/UP35A D Registers

Operation parameter													
PID setting (Menu: PID)													
D-Reg No.	Ref. No.	H No.	Register symbol	R/W			D-Reg No.	Ref. No.	H No.	Register symbol	R/W		
				UT 35A	UT 32A	UP 35A					UT 35A	UT 32A	UP 35A
D3401	43401	0D48	P_L1_R	R/W	R/W	R/W	D3451	43451	0D7A				
D3402	43402	0D49	I_L1_R	R/W	R/W	R/W	D3452	43452	0D7B				
D3403	43403	0D4A	D_L1_R	R/W	R/W	R/W	D3453	43453	0D7C				
D3404	43404	0D4B	OH_L1_R	R/W	R/W	R/W	D3454	43454	0D7D				
D3405	43405	0D4C	OL_L1_R	R/W	R/W	R/W	D3455	43455	0D7E				
D3406	43406	0D4D	MR_L1_R	R/W	R/W	R/W	D3456	43456	0D7F				
D3407	43407	0D4E	HYS_L1_R	R/W	R/W	R/W	D3457	43457	0D80				
D3408	43408	0D4F	SU.HY_R	R/W	R/W		D3458	43458	0D81				
D3409	43409	0D50	HY.UP_L1_R	R/W	R/W	R/W	D3459	43459	0D82				
D3410	43410	0D51	HY.LO_L1_R	R/W	R/W	R/W	D3460	43460	0D83				
D3411	43411	0D52	DR_L1_R	R/W	R/W	R/W	D3461	43461	0D84				
D3412	43412	0D53	SU.DR_R	R/W	R/W		D3462	43462	0D85				
D3413	43413	0D54	Pc_L1_R	R/W	R/W	R/W	D3463	43463	0D86				
D3414	43414	0D55	lc_L1_R	R/W	R/W	R/W	D3464	43464	0D87				
D3415	43415	0D56	Dc_L1_R	R/W	R/W	R/W	D3465	43465	0D88				
D3416	43416	0D57	OHc_L1_R	R/W	R/W	R/W	D3466	43466	0D89				
D3417	43417	0D58	OLc_L1_R	R/W	R/W	R/W	D3467	43467	0D8A				
D3418	43418	0D59	HYSc_L1_R	R/W	R/W	R/W	D3468	43468	0D8B				
D3419	43419	0D5A	DB_L1_R	R/W	R/W	R/W	D3469	43469	0D8C				
D3420	43420	0D5B	PO_L1_R	R/W	R/W	R/W	D3470	43470	0D8D				
D3421	43421	0D5C	SU.PO_R	R/W	R/W		D3471	43471	0D8E				
D3422	43422	0D5D	POc_L1_R	R/W	R/W	R/W	D3472	43472	0D8F				
D3423	43423	0D5E					D3473	43473	0D90				
D3424	43424	0D5F					D3474	43474	0D91				
D3425	43425	0D60					D3475	43475	0D92				
D3426	43426	0D61					D3476	43476	0D93				
D3427	43427	0D62					D3477	43477	0D94				
D3428	43428	0D63					D3478	43478	0D95				
D3429	43429	0D64					D3479	43479	0D96				
D3430	43430	0D65					D3480	43480	0D97				
D3431	43431	0D66					D3481	43481	0D98				
D3432	43432	0D67					D3482	43482	0D99				
D3433	43433	0D68					D3483	43483	0D9A				
D3434	43434	0D69					D3484	43484	0D9B				
D3435	43435	0D6A					D3485	43485	0D9C				
D3436	43436	0D6B					D3486	43486	0D9D				
D3437	43437	0D6C					D3487	43487	0D9E				
D3438	43438	0D6D					D3488	43488	0D9F				
D3439	43439	0D6E					D3489	43489	0DA0				
D3440	43440	0D6F					D3490	43490	0DA1				
D3441	43441	0D70					D3491	43491	0DA2				
D3442	43442	0D71					D3492	43492	0DA3				
D3443	43443	0D72					D3493	43493	0DA4				
D3444	43444	0D73					D3494	43494	0DA5				
D3445	43445	0D74					D3495	43495	0DA6				
D3446	43446	0D75					D3496	43496	0DA7				
D3447	43447	0D76					D3497	43497	0DA8				
D3448	43448	0D77					D3498	43498	0DA9				
D3449	43449	0D78					D3499	43499	0DAA				
D3450	43450	0D79					D3500	43500	0DAB				

Operation parameter													
Control action-related setting (Tuning menu: TUNE) (Zone control menu: ZONE)													
D-Reg No.	Ref. No.	H No.	Register symbol	R/W			D-Reg No.	Ref. No.	H No.	Register symbol	R/W		
				UT 35A	UT 32A	UP 35A					UT 35A	UT 32A	UP 35A
D3501	43501	0DAC	SC_L1	R/W	R/W	R/W	D3551	43551	0DDE	RP1_L1	R/W	R/W	R/W
D3502	43502	0DAD					D3552	43552	0DDF	RP2_L1	R/W	R/W	R/W
D3503	43503	0DAE	AT.TY_L1	R/W	R/W	R/W	D3553	43553	0DE0	RP3_L1	R/W	R/W	R/W
D3504	43504	0DAF	AT.OH_L1	R/W	R/W	R/W	D3554	43554	0DE1	RP4_L1	R/W	R/W	R/W
D3505	43505	0DB0	AT.OL_L1	R/W	R/W	R/W	D3555	43555	0DE2				
D3506	43506	0DB1	AT.BS_L1	R/W	R/W	R/W	D3556	43556	0DE3				
D3507	43507	0DB2					D3557	43557	0DE4				
D3508	43508	0DB3					D3558	43558	0DE5	RHY_L1	R/W	R/W	R/W
D3509	43509	0DB4					D3559	43559	0DE6	RDV_L1	R/W	R/W	R/W
D3510	43510	0DB5					D3560	43560	0DE7				
D3511	43511	0DB6					D3561	43561	0DE8				
D3512	43512	0DB7					D3562	43562	0DE9				
D3513	43513	0DB8					D3563	43563	0DEA				
D3514	43514	0DB9					D3564	43564	0DEB				
D3515	43515	0DBA					D3565	43565	0DEC				
D3516	43516	0DBB					D3566	43566	0DED				
D3517	43517	0DBC					D3567	43567	0DEE				
D3518	43518	0DBD					D3568	43568	0DEF				
D3519	43519	0DBE					D3569	43569	0DF0				
D3520	43520	0DBF					D3570	43570	0DF1				
D3521	43521	0DC0					D3571	43571	0DF2				
D3522	43522	0DC1					D3572	43572	0DF3				
D3523	43523	0DC2					D3573	43573	0DF4				
D3524	43524	0DC3					D3574	43574	0DF5				
D3525	43525	0DC4					D3575	43575	0DF6				
D3526	43526	0DC5	AR_L1	R/W	R/W	R/W	D3576	43576	0DF7				
D3527	43527	0DC6	OPR_L1	R/W	R/W	R/W	D3577	43577	0DF8				
D3528	43528	0DC7	OLMT_L1	R/W	R/W	R/W	D3578	43578	0DF9				
D3529	43529	0DC8					D3579	43579	0DFA				
D3530	43530	0DC9					D3580	43580	0DFB				
D3531	43531	0DCA	MPON_L1	R/W	R/W	R/W	D3581	43581	0DFC				
D3532	43532	0DCB	MPO1_L1	R/W	R/W	R/W	D3582	43582	0DFD				
D3533	43533	0DCC	MPO2_L1	R/W	R/W	R/W	D3583	43583	0DFE				
D3534	43534	0DCD	MPO3_L1	R/W	R/W	R/W	D3584	43584	0DFE				
D3535	43535	0DCE	MPO4_L1	R/W	R/W	R/W	D3585	43585	0E00				
D3536	43536	0DCF	MPO5_L1	R/W	R/W	R/W	D3586	43586	0E01				
D3537	43537	0DD0					D3587	43587	0E02				
D3538	43538	0DD1					D3588	43588	0E03				
D3539	43539	0DD2					D3589	43589	0E04				
D3540	43540	0DD3					D3590	43590	0E05				
D3541	43541	0DD4					D3591	43591	0E06				
D3542	43542	0DD5					D3592	43592	0E07				
D3543	43543	0DD6					D3593	43593	0E08				
D3544	43544	0DD7					D3594	43594	0E09				
D3545	43545	0DD8					D3595	43595	0E0A				
D3546	43546	0DD9					D3596	43596	0E0B				
D3547	43547	0DDA					D3597	43597	0E0C				
D3548	43548	0DDB					D3598	43598	0E0D				
D3549	43549	0DDC					D3599	43599	0E0E				
D3550	43550	0DDD					D3600	43600	0E0F				

D3601 to D4700: Free area

8.4 UT35A/UT32A/UP35A D Registers

SP and Alarm Setpoint Setting of Groups 1 to 4 (D2501 to D2700)

Register No.	Description	Range and meaning of value
D2501	SP_L1_1	Target setpoint of group 1 0.0 to 100.0% of PV input range (EU) (Setting range: SPL to SPH)
D2502	SUB_1	Sub-target setpoint (in Two-position two-level control) of group 1 Set the offset from SP. -100.0 to 100.0% of PV input range span (EUS)
D2503	PIDN_L1_1	PID number selection of group 1 Set a PID group number to use. 1 to 4 (Depends on the PIDG. setting.)
D2504	A1_L1_1	Alarm-1 setpoint of group 1
D2505	A2_L1_1	Alarm-2 setpoint of group 1
D2506	A3_L1_1	Alarm-3 setpoint of group 1 -19999 to 30000 (Set a value within the input range.)
D2507	A4_L1_1	Alarm-4 setpoint of group 1 Decimal point position depends on the input type.
D2508 to D2520		
D2521 to D2527	SP_L1_2 to A4_L1_2	Target setpoint of group 2 to Alarm-4 setpoint of group 2 Same as 2501 to D2507
D2528 to D2540		
D2541 to D2547	SP_L1_3 to A4_L1_3	Target setpoint of group 2 to Alarm-4 setpoint of group 2 Same as D2501 to D2507
D2548 to D2560		
D2561 to D2567	SP_L1_4 to A4_L1_4	Target setpoint of group 2 to Alarm-4 setpoint of group 2 Same as D2501 to D2507
D2568 to D2700		

SP-related Setting (D2701 to D2800)

Register No.	Description	Range and meaning of value
D2701 to D2702		
D2703	RT_L1	Remote input ratio SP = Remote input x RT + Remote input bias 0.001 to 9.999
D2704	RBS_L1	Remote input bias -100.0 to 100.0% of PV input range span (EUS)
D2705	UPR_L1	SP ramp-up rate Used to prevent SP from changing suddenly. Set a ramp-up rate or ramp-down rate per hour or minute. Set a time unit using the parameter TMU.
D2706	DNR_L1	SP ramp-down rate 0: OFF (Disable) 0.0 + 1 digit to 100.0% of PV input range span (EUS)
D2707	TMU_L1	SP ramp-rate time unit 0: HOUR (Ramp-up rate or ramp-down rate per hour) 1: MIN (Ramp-up rate or ramp-down rate per minute)
D2708 to D2709		
D2710	SPT_L1	SP tracking selection Tracking is performed when the mode changes from Remote to Local. (The local setpoint keeps track of the remote setpoint.) 0: OFF (Disable) 1: ON (Enable)
D2711	PVT_L1	PV tracking selection Causes the setpoint to keep track of the PV so the setpoint automatically reverts to its original value at a preset rate of change. The UPR, DNR, and TMU are used in combination. Operating conditions: 1) MAN → AUTO, 2) STOP → AUTO, 3) Power-on, 4) SP number change, 5) SP change 0: OFF (Disable) 1: ON (Enable)
D2712	S.TM	Starting time of program operation 0 to 59999 (minute or second) * Use the parameter TMU to set the time unit.
D2713	PNC	Program pattern number clearance 0: OFF (Not cleared) 1: ON (Cleared. (Set the program No.) before restart program operation) * The controller resets (clears) the program pattern number on the operating display to "0" at the end of program operation.
D2712 to D2800		

Alarm Function Setting (D2801 to D2900)

Register No.	Description		Range and meaning of value	
D2801	AL1.T_L1	Alarm-1 type	AL1.T_L1 to AL8.T_L1 0: Disable 1: PV high limit 2: PV low limit 3: SP high limit 4: SP low limit 5: Deviation high limit 6: Deviation low limit 7: Deviation high and low limits 8: Deviation within high and low limits 9: Target SP high limit 10: Target SP low limit 11: Target SP deviation high limit 12: Target SP deviation low limit 13: Target SP deviation high and low limits 14: Target SP deviation within high and low limits 15: OUT high limit 16: OUT low limit 17: Cooling-side OUT high limit 18: Cooling-side OUT low limit 19: Analog input PV high limit 20: Analog input PV low limit 27: Feedback input high limit 28: Feedback input low limit 29: PV velocity 30: Fault diagnosis 31: FAIL	
D2802	AL1.W_L1	Alarm-1 stand-by action		
D2803	AL1.D_L1	Alarm-1 energized/de-energized		
D2804	AL1.L_L1	Alarm-1 latch		
D2805	AL2.T_L1	Alarm-2 type		
D2806	AL2.W_L1	Alarm-2 stand-by action		
D2807	AL2.D_L1	Alarm-2 energized/de-energized		
D2808	AL2.L_L1	Alarm-2 latch		
D2809	AL3.T_L1	Alarm-3 type		
D2810	AL3.W_L1	Alarm-3 stand-by action		
D2811	AL3.D_L1	Alarm-3 energized/de-energized		AL1.W_L1 to AL4.W_L1 0: Without Stand-by action 1: With Stand-by action
D2812	AL3.L_L1	Alarm-3 latch		AL1.D_L1 to AL4.D_L1 0: Alarm output: Energized 1: Alarm output: De-energized
D2813	AL4.T_L1	Alarm-4 type		AL1.L_L1 to AL4.L_L1 0: OFF 1: Latch 1 2: Latch 2 3: Latch 3 4: Latch 4
D2814	AL4.W_L1	Alarm-4 stand-by action		
D2815	AL4.D_L1	Alarm-4 energized/de-energized		
D2816	AL4.L_L1	Alarm-4 latch		When the UTAdvanced parameter is set by key stroke, the alarm type, stand-by action, energized/de-energized, and latch comprise one parameter.
D2817 to D2832				
D2833	VT1_L1	PV velocity alarm time setpoint 1	1 to 5999 (second)	
D2834	VT2_L1	PV velocity alarm time setpoint 2		
D2835	VT3_L1	PV velocity alarm time setpoint 3		
D2836	VT4_L1	PV velocity alarm time setpoint 4		
D2837 to D2840				

8.4 UT35A/UT32A/UP35A D Registers

Register No.	Description	Range and meaning of value
D2841	HY1_L1	Alarm-1 hysteresis
D2842	HY2_L1	Alarm-2 hysteresis
D2843	HY3_L1	Alarm-3 hysteresis
D2844	HY4_L1	Alarm-4 hysteresis
D2845 to D2848		
D2849	DYN1_L1	Alarm-1 On-delay timer
D2850	DYN2_L1	Alarm-2 On-delay timer
D2851	DYN3_L1	Alarm-3 On-delay timer
D2852	DYN4_L1	Alarm-4 On-delay timer
D2853 to D2856		
D2857	DYF1_L1	Alarm-1 Off-delay timer
D2858	DYF2_L1	Alarm-2 Off-delay timer
D2859	DYF3_L1	Alarm-3 Off-delay timer
D2860	DYF4_L1	Alarm-4 Off-delay timer
D2861 to D2865		
D2866	AMD_L1	Alarm mode
UT35A/UT32A 0: Always active 1: Not active in STOP mode 2: Not active in STOP or MAN mode UP35A 0: Always active 1: Not active in RESET mode 2: Not active in RESET or MAN mode		
D2867 to D2870		
D2871	EHY1	Event-1 hysteresis
D2872	EHY2	Event-2 hysteresis
D2873 to D2900		

PV-related Setting (D2901 to D3000)

Register No.	Description	Range and meaning of value
D2901	BS_L1	PV input bias
-100.0 to 100.0% of PV input range span (EUS)		
D2902	FL_L1	PV input filter
0: OFF (Disable) 1 to 120 s		
D2903 to D2900		

PID Setting of Groups 1 to 4 and R (D3001 to D3500)

Register No.		Description	Range and meaning of value
D3001	P_L1_1	Proportional band of group 1 Heating-side proportional band (in Heating/cooling control) of group 1	0.0 to 999.9% When 0.0% is set, it operates as 0.1%. Heating-side ON/OFF control applies when 0.0% in Heating/cooling control
D3002	I_L1_1	Integral time of group 1 Heating-side integral time (in Heating/cooling control) of group 1	0: OFF (Disable) 1 to 6000 s
D3003	D_L1_1	Derivative time of group 1 Heating-side derivative time (in Heating/cooling control) of group 1	0: OFF (Disable) 1 to 6000 s
D3004	OH_L1_1	Control output high limit of group 1 Heating-side control output high limit (in Heating/cooling control) of group 1	-4.9 to 105.0%, (OL<OH) In Heating/cooling control: 0.1 to 105.0% (OL<OH)
D3005	OL_L1_1	Control output low limit of group 1 Heating-side control output low limit (in Heating/cooling control) of group 1	-5.0 to 104.9%, (OL<OH), SD: Tight shut In Heating/cooling control: 0.0 to 104.9% (OL<OH)
D3006	MR_L1_1	Manual reset of group 1	Enabled when integral time is OFF. The manual reset value equals the output value when PV = SP. -5.0 to 105.0%
D3007	HYS_L1_1	Hysteresis (in ON/OFF control, Position proportional control, or Two-position two-level control) Heating-side ON/OFF control hysteresis (in Heating/cooling control)	In ON/OFF control or Two-position two-level control: 0.0 to 100.0% of PV input range span (EUS) In Heating/cooling control or Position proportional control: 0.0 to 100.0%
D3008	SU.HY_1	Sub-hysteresis (in Two-position two-level control) of group 1	0.0 to 100.0% of PV input range span (EUS)
D3009	HY.UP_L1_1	Upper-side hysteresis (in ON/OFF control) of group 1	0.0 to 100.0% of PV input range span (EUS)
D3010	HY.LO_L1_1	Lower-side hysteresis (in ON/OFF control) of group 1	
D3011	DR_L1_1	Direct/reverse action switch of group 1	0: RVS: Reverse action 1: DIR: Direct action
D3012	SU.DR_1	Sub-direct/reverse action switch (in Two-position two-level control) of group 1	
D3013	Pc_L1_1	Cooling-side proportional band of group 1	0.0 to 999.9% (Cooling-side ON/OFF control applies when 0.0% in Heating/cooling control)
D3014	Ic_L1_1	Cooling-side integral time of group 1	0: OFF (Disable) 1 to 6000 s
D3015	Dc_L1_1	Cooling-side derivative time of group 1	0: OFF (Disable) 1 to 6000 s
D3016	OHc_L1_1	Cooling-side control output high limit of group 1	0.1 to 105.0%, (OLc<OHc)
D3017	OLc_L1_1	Cooling-side control output low limit of group 1	0.0 to 104.9%, (OLc<OHc)
D3018	HYSc_L1_1	Cooling-side ON/OFF control hysteresis of group 1	0.0 to 100.0%
D3019	DB_L1_1	Output dead band (in Heating/cooling control or Position proportional control)	In Heating/cooling control: -100.0 to 50.0% In Position proportional control: 1.0 to 10.0%
D3020	PO_L1_1	Preset output of group 1 Heating-side preset output (in Heating/cooling control) of group 1	In STOP mode, fixed control output can be generated. In Position proportional control, Valve opening can be set -5.0 to 105.0%
D3021	SU.PO_1	Sub-preset output (in Two-position two-level control) of group 1	In STOP mode, fixed sub-control output can be generated. 0%, 100%
D3022	POc_L1_1	Cooling-side preset output of group 1	In STOP mode, cooling-side fixed control output can be generated. -5.0 to 105.0%
D3023 to D3050			

8.4 UT35A/UT32A/UP35A D Registers

Register No.	Description	Range and meaning of value
D3051 to D3072	P_L1_2 to POc_L1_2 Proportional band of group 2 Heating-side proportional band (in Heating/cooling control) of group 2 to Cooling-side preset output of group 2	Same as D3001 to D3022
D3073 to D3100		
D3101 to D3122	P_L1_3 to POc_L1_3 Proportional band of group 3 Heating-side proportional band (in Heating/cooling control) of group 3 to Cooling-side preset output of group 3	Same as D3001 to D3022
D3123 to D3150		
D3151 to D3172	P_L1_4 to POc_L1_4 Proportional band of group 4 Heating-side proportional band (in Heating/cooling control) of group 4 to Cooling-side preset output of group 4	Same as D3001 to D3022
D3173 to D3400		
D3401 to D3422	P_L1_R to POc_L1_R Proportional band of group R Heating-side proportional band (in Heating/cooling control) of group R to Cooling-side preset output of group R	Same as D3001 to D3022
D3423 to D3500		

Control Action-related Setting (D3501 to D3600)

Register No.	Description		Range and meaning of value
D3501	SC_L1	Super function	0: OFF (Disable) 1: Overshoot suppressing function (normal mode) 2: Hunting suppressing function (stable mode) Enables to answer the wider characteristic changes compared with response mode. 3: Hunting suppressing function (response mode) Enables quick follow-up and short converging time of PV for the changed SP. 4: Overshoot suppressing function (strong suppressing mode) Note: Setpoints 2 and 3 must be used in PID control or PI control. Disabled in the following controls: 1) ON/OFF control, 2) PD control, 3) P control, 4) Heating/cooling control Do not use the function for the control processes with response such as flow or pressure control.
D3502			
D3503	AT.TY_L1	Auto-tuning type	0: Normal 1: Stability
D3504	AT.OH_L1	Output high limit in auto-tuning	-5.0 to 105.0% (Disabled in Heating/cooling control)
D3505	AT.OL_L1	Output low limit in auto-tuning	
D3506	AT.BS_L1	SP bias in auto-tuning	-100.0 to 100.0% of PV input range span (EUS)
D3507 to D3525			
D3526	AR_L1	Anti-reset windup (excess integration prevention)	0: AUTO, 50.0 to 200.0%
D3527	OPR_L1	Output velocity limiter	0: OFF (Disable), 0.1 to 100.0%/s
D3528	OLMT_L1	Output limiter switch	0: OFF (Disable output limiter in MAN mode) 1: ON (Enable output limiter in MAN mode)
D3529 to D3530			
D3531	MPON_L1	Manual preset output number selection	Select the output used in MAN mode when switched from AUTO to MAN mode. 0: OFF (Hold the control output in AUTO mode (bumpless)) 1: Use manual preset output 1 (output bump) 2: Use manual preset output 2 (output bump) 3: Use manual preset output 3 (output bump) 4: Use manual preset output 4 (output bump) 5: Use manual preset output 5 (output bump)
D3532	MPO1_L1	Manual preset output 1	-5.0 to 105.0% However, output is limited to the output high limit and low limit.
D3533	MPO2_L1	Manual preset output 2	
D3534	MPO3_L1	Manual preset output 3	
D3535	MPO4_L1	Manual preset output 4	
D3536	MPO5_L1	Manual preset output 5	
D3537 to D3550			

8.4 UT35A/UT32A/UP35A D Registers

Register No.	Description		Range and meaning of value
D3551	RP1_L1	Reference point 1	Set reference points at which switching is carried out between groups of PID constants according to the given temperature zone. 0.0 to 100.0% of PV input range (EU) ($RP1 \leq RP2 \leq RP3$)
D3552	RP2_L1	Reference point 2	
D3553	RP3_L1	Reference point 3	
D3554 to D3557			
D3558	RHY_L1	Zone PID switching hysteresis	Hysteresis can be set for switching at a reference point. 0.0 to 10.0% of PV input range span (EUS)
D3559	RDV_L1	Reference deviation	Set a deviation from SP. The PID for reference deviation is used if there is a larger deviation than the preset reference deviation. 0: OFF (Disable) 0.0 + 1 digit to 100.0% of PV input range span (EUS)
D3560 to D3600			

Free Area (D3601 to D4700)

Register No.	Description		Range and meaning of value
D3601 to D4700		Free area	

8.4.4 P Parameter (D4701 to D4800)

P parameter													
P parameter (Menu: PPAR)													
D-Reg No.	Ref. No.	H No.	Register symbol	R/W			D-Reg No.	Ref. No.	H No.	Register symbol	R/W		
				UT 35A	UT 32A	UP 35A					UT 35A	UT 32A	UP 35A
D4701	44701	125C	P01D	R/W	R/W	R/W	D4751	44751	128E				
D4702	44702	125D	P02D	R/W	R/W	R/W	D4752	44752	128F				
D4703	44703	125E	P03D	R/W	R/W	R/W	D4753	44753	1290				
D4704	44704	125F	P04D	R/W	R/W	R/W	D4754	44754	1291				
D4705	44705	1260	P05D	R/W	R/W	R/W	D4755	44755	1292				
D4706	44706	1261	P06D	R/W	R/W	R/W	D4756	44756	1293				
D4707	44707	1262	P07D	R/W	R/W	R/W	D4757	44757	1294				
D4708	44708	1263	P08D	R/W	R/W	R/W	D4758	44758	1295				
D4709	44709	1264	P09D	R/W	R/W	R/W	D4759	44759	1296				
D4710	44710	1265	P10D	R/W	R/W	R/W	D4760	44760	1297				
D4711	44711	1266					D4761	44761	1298				
D4712	44712	1267					D4762	44762	1299				
D4713	44713	1268					D4763	44763	129A				
D4714	44714	1269					D4764	44764	129B				
D4715	44715	126A					D4765	44765	129C				
D4716	44716	126B					D4766	44766	129D				
D4717	44717	126C					D4767	44767	129E				
D4718	44718	126D					D4768	44768	129F				
D4719	44719	126E					D4769	44769	12A0				
D4720	44720	126F					D4770	44770	12A1				
D4721	44721	1270	P01	R/W	R/W	R/W	D4771	44771	12A2				
D4722	44722	1271	P02	R/W	R/W	R/W	D4772	44772	12A3				
D4723	44723	1272	P03	R/W	R/W	R/W	D4773	44773	12A4				
D4724	44724	1273	P04	R/W	R/W	R/W	D4774	44774	12A5				
D4725	44725	1274	P05	R/W	R/W	R/W	D4775	44775	12A6				
D4726	44726	1275	P06	R/W	R/W	R/W	D4776	44776	12A7				
D4727	44727	1276	P07	R/W	R/W	R/W	D4777	44777	12A8				
D4728	44728	1277	P08	R/W	R/W	R/W	D4778	44778	12A9				
D4729	44729	1278	P09	R/W	R/W	R/W	D4779	44779	12AA				
D4730	44730	1279	P10	R/W	R/W	R/W	D4780	44780	12AB				
D4731	44731	127A					D4781	44781	12AC				
D4732	44732	127B					D4782	44782	12AD				
D4733	44733	127C					D4783	44783	12AE				
D4734	44734	127D					D4784	44784	12AF				
D4735	44735	127E					D4785	44785	12B0				
D4736	44736	127F					D4786	44786	12B1				
D4737	44737	1280					D4787	44787	12B2				
D4738	44738	1281					D4788	44788	12B3				
D4739	44739	1282					D4789	44789	12B4				
D4740	44740	1283					D4790	44790	12B5				
D4741	44741	1284					D4791	44791	12B6				
D4742	44742	1285					D4792	44792	12B7				
D4743	44743	1286					D4793	44793	12B8				
D4744	44744	1287					D4794	44794	12B9				
D4745	44745	1288					D4795	44795	12BA				
D4746	44746	1289					D4796	44796	12BB				
D4747	44747	128A					D4797	44797	12BC				
D4748	44748	128B					D4798	44798	12BD				
D4749	44749	128C					D4799	44799	12BE				
D4750	44750	128D					D4800	44800	12BF				

D4801 to D5000: Free area

8.4 UT35A/UT32A/UP35A D Registers

P parameter (D4701 to D4800)

Register No.	Description	Range and meaning of value
D4701	P01D	0: No decimal place 1: One decimal place 2: Two decimal places 3: Three decimal places 4: Four decimal places
D4702	P02D	
D4703	P03D	
D4704	P04D	
D4705	P05D	
D4706	P06D	
D4707	P07D	
D4708	P08D	
D4709	P09D	
D4710	P10D	
D4711 to D4720		
D4721	P01	-19999 to 30000 (Set a decimal point position using LL50A Parameter Setting Software.)
D4722	P02	
D4723	P03	
D4724	P04	
D4725	P05	
D4726	P06	
D4727	P07	
D4728	P08	
D4729	P09	
D4730	P10	
D4731 to D4800		

Free Area (D4801 to D5000)

Register No.	Description	Range and meaning of value
D4801 to 5000	Free area	

8.4.5 Setup Parameters (D5001 to D7000)

Setup parameter													
Control function setting (Menu: CTL)													
D-Reg No.	Ref. No.	H No.	Register symbol	R/W			D-Reg No.	Ref. No.	H No.	Register symbol	R/W		
				UT 35A	UT 32A	UT 32A					UT 35A	UT 32A	UP 35A
D5001	45001	1388					D5051	45051	13BA				
D5002	45002	1389					D5052	45052	13BB				
D5003	45003	138A	CNT_L1	R/W	R/W	R/W	D5053	45053	13BC				
D5004	45004	138B					D5054	45054	13BD				
D5005	45005	138C	ALG_L1	R/W	R/W	R/W	D5055	45055	13BE				
D5006	45006	138D					D5056	45056	13BF				
D5007	45007	138E	SPGR.	R/W	R/W		D5057	45057	13C0				
D5008	45008	138F					D5058	45058	13C1				
D5009	45009	1390	ALNO_L1	R/W	R/W	R/W	D5059	45059	13C2				
D5010	45010	1391					D5060	45060	13C3				
D5011	45011	1392					D5061	45061	13C4				
D5012	45012	1393	ZON	R/W	R/W	R/W	D5062	45062	13C5				
D5013	45013	1394					D5063	45063	13C6				
D5014	45014	1395	PIDG.	R/W	R/W		D5064	45064	13C7				
D5015	45015	1396					D5065	45065	13C8				
D5016	45016	1397	SEG.T			R/W	D5066	45066	13C9				
D5017	45017	1398	TMU			R/W	D5067	45067	13CA				
D5018	45018	1399					D5068	45068	13CB				
D5019	45019	139A					D5069	45069	13CC				
D5020	45020	139B					D5070	45070	13CD				
D5021	45021	139C					D5071	45071	13CE				
D5022	45022	139D					D5072	45072	13CF				
D5023	45023	139E					D5073	45073	13D0				
D5024	45024	139F					D5074	45074	13D1				
D5025	45025	13A0					D5075	45075	13D2				
D5026	45026	13A1					D5076	45076	13D3				
D5027	45027	13A2					D5077	45077	13D4				
D5028	45028	13A3					D5078	45078	13D5				
D5029	45029	13A4					D5079	45079	13D6				
D5030	45030	13A5					D5080	45080	13D7				
D5031	45031	13A6					D5081	45081	13D8				
D5032	45032	13A7					D5082	45082	13D9				
D5033	45033	13A8					D5083	45083	13DA				
D5034	45034	13A9					D5084	45084	13DB				
D5035	45035	13AA					D5085	45085	13DC				
D5036	45036	13AB					D5086	45086	13DD				
D5037	45037	13AC					D5087	45087	13DE				
D5038	45038	13AD					D5088	45088	13DF				
D5039	45039	13AE					D5089	45089	13E0				
D5040	45040	13AF					D5090	45090	13E1				
D5041	45041	13B0					D5091	45091	13E2				
D5042	45042	13B1					D5092	45092	13E3				
D5043	45043	13B2					D5093	45093	13E4				
D5044	45044	13B3					D5094	45094	13E5				
D5045	45045	13B4					D5095	45095	13E6				
D5046	45046	13B5					D5096	45096	13E7				
D5047	45047	13B6					D5097	45097	13E8				
D5048	45048	13B7					D5098	45098	13E9				
D5049	45049	13B8					D5099	45099	13EA				
D5050	45050	13B9					D5100	45100	13EB				

8.4 UT35A/UT32A/UP35A D Registers

Setup parameter													
Input setting (PV input setting menu: PV)													
D-Reg No.	Ref. No.	H No.	Register symbol	R/W			D-Reg No.	Ref. No.	H No.	Register symbol	R/W		
				UT 35A	UT 32A	UP 35A					UT 35A	UT 32A	UP 35A
D5101	45101	13EC	IN	R/W	R/W	R/W	D5151	45151	141E				
D5102	45102	13ED	UNIT	R/W	R/W	R/W	D5152	45152	141F				
D5103	45103	13EE	DP	R	R	R	D5153	45153	1420				
D5104	45104	13EF	RH	R/W	R/W	R/W	D5154	45154	1421				
D5105	45105	13F0	RL	R/W	R/W	R/W	D5155	45155	1422				
D5106	45106	13F1	SDP	R/W	R/W	R/W	D5156	45156	1423				
D5107	45107	13F2	SH	R/W	R/W	R/W	D5157	45157	1424				
D5108	45108	13F3	SL	R/W	R/W	R/W	D5158	45158	1425				
D5109	45109	13F4	BSL	R/W	R/W	R/W	D5159	45159	1426				
D5110	45110	13F5	RJC	R/W	R/W	R/W	D5160	45160	1427				
D5111	45111	13F6	ERJC	R/W	R/W	R/W	D5161	45161	1428				
D5112	45112	13F7	A.BS	R/W	R/W	R/W	D5162	45162	1429				
D5113	45113	13F8	A.FL	R/W	R/W	R/W	D5163	45163	142A				
D5114	45114	13F9					D5164	45164	142B				
D5115	45115	13FA					D5165	45165	142C				
D5116	45116	13FB					D5166	45166	142D				
D5117	45117	13FC					D5167	45167	142E				
D5118	45118	13FD					D5168	45168	142F				
D5119	45119	13FE					D5169	45169	1430				
D5120	45120	13FF					D5170	45170	1431				
D5121	45121	1400					D5171	45171	1432				
D5122	45122	1401					D5172	45172	1433				
D5123	45123	1402					D5173	45173	1434				
D5124	45124	1403					D5174	45174	1435				
D5125	45125	1404					D5175	45175	1436				
D5126	45126	1405					D5176	45176	1437				
D5127	45127	1406					D5177	45177	1438				
D5128	45128	1407					D5178	45178	1439				
D5129	45129	1408					D5179	45179	143A				
D5130	45130	1409					D5180	45180	143B				
D5131	45131	140A					D5181	45181	143C				
D5132	45132	140B					D5182	45182	143D				
D5133	45133	140C					D5183	45183	143E				
D5134	45134	140D					D5184	45184	143F				
D5135	45135	140E					D5185	45185	1440				
D5136	45136	140F					D5186	45186	1441				
D5137	45137	1410					D5187	45187	1442				
D5138	45138	1411					D5188	45188	1443				
D5139	45139	1412					D5189	45189	1444				
D5140	45140	1413					D5190	45190	1445				
D5141	45141	1414					D5191	45191	1446				
D5142	45142	1415					D5192	45192	1447				
D5143	45143	1416					D5193	45193	1448				
D5144	45144	1417					D5194	45194	1449				
D5145	45145	1418					D5195	45195	144A				
D5146	45146	1419					D5196	45196	144B				
D5147	45147	141A					D5197	45197	144C				
D5148	45148	141B					D5198	45198	144D				
D5149	45149	141C					D5199	45199	144E				
D5150	45150	141D					D5200	45200	144F				

Setup parameter													
Input setting (Input range-SP limiter setting parameters menu: MPV)													
D-Reg No.	Ref. No.	H No.	Register symbol	R/W			D-Reg No.	Ref. No.	H No.	Register symbol	R/W		
				UT 35A	U 32A	UP 35A					UT 35A	UT 32A	UP 35A
D5201	45201	1450	P.UNI_L1	R/W	R/W	R/W	D5251	45251	1482				
D5202	45202	1451	P.DP_L1	R/W	R/W	R/W	D5252	45252	1483				
D5203	45203	1452	P.RH_L1	R/W	R/W	R/W	D5253	45253	1484				
D5204	45204	1453	P.RL_L1	R/W	R/W	R/W	D5254	45254	1485				
D5205	45205	1454					D5255	45255	1486				
D5206	45206	1455					D5256	45256	1487				
D5207	45207	1456					D5257	45257	1488				
D5208	45208	1457					D5258	45258	1489				
D5209	45209	1458					D5259	45259	148A				
D5210	45210	1459	SPH_L1	R/W	R/W	R/W	D5260	45260	148B				
D5211	45211	145A	SPL_L1	R/W	R/W	R/W	D5261	45261	148C				
D5212	45212	145B					D5262	45262	148D				
D5213	45213	145C					D5263	45263	148E				
D5214	45214	145D					D5264	45264	148F				
D5215	45215	145E					D5265	45265	1490				
D5216	45216	145F					D5266	45266	1491				
D5217	45217	1460					D5267	45267	1492				
D5218	45218	1461					D5268	45268	1493				
D5219	45219	1462					D5269	45269	1494				
D5220	45220	1463					D5270	45270	1495				
D5221	45221	1464					D5271	45271	1496				
D5222	45222	1465					D5272	45272	1497				
D5223	45223	1466					D5273	45273	1498				
D5224	45224	1467					D5274	45274	1499				
D5225	45225	1468					D5275	45275	149A				
D5226	45226	1469					D5276	45276	149B				
D5227	45227	146A					D5277	45277	149C				
D5228	45228	146B					D5278	45278	149D				
D5229	45229	146C					D5279	45279	149E				
D5230	45230	146D					D5280	45280	149F				
D5231	45231	146E					D5281	45281	14A0				
D5232	45232	146F					D5282	45282	14A1				
D5233	45233	1470					D5283	45283	14A2				
D5234	45234	1471					D5284	45284	14A3				
D5235	45235	1472					D5285	45285	14A4				
D5236	45236	1473					D5286	45286	14A5				
D5237	45237	1474					D5287	45287	14A6				
D5238	45238	1475					D5288	45288	14A7				
D5239	45239	1476					D5289	45289	14A8				
D5240	45240	1477					D5290	45290	14A9				
D5241	45241	1478					D5291	45291	14AA				
D5242	45242	1479					D5292	45292	14AB				
D5243	45243	147A					D5293	45293	14AC				
D5244	45244	147B					D5294	45294	14AD				
D5245	45245	147C					D5295	45295	14AE				
D5246	45246	147D					D5296	45296	14AF				
D5247	45247	147E					D5297	45297	14B0				
D5248	45248	147F					D5298	45298	14B1				
D5249	45249	1480					D5299	45299	14B2				
D5250	45250	1481					D5300	45300	14B3				

8.4 UT35A/UT32A/UP35A D Registers

Setup parameter													
Output setting (Menu: OUT)													
D-Reg No.	Ref. No.	H No.	Register symbol	R/W			D-Reg No.	Ref. No.	H No.	Register symbol	R/W		
				UT 35A	UT 32A	UP 35A					UT 35A	UT 32A	UP 35A
D5301	45301	14B4	OT.H	R/W	R/W	R/W	D5351	45351	14E6				
D5302	45302	14B5	OT.C	R/W	R/W	R/W	D5352	45352	14E7				
D5303	45303	14B6	CT	R/W	R/W	R/W	D5353	45353	14E8				
D5304	45304	14B7	CTc	R/W	R/W	R/W	D5354	45354	14E9				
D5305	45305	14B8					D5355	45355	14EA				
D5306	45306	14B9					D5356	45356	14EB				
D5307	45307	14BA					D5357	45357	14EC				
D5308	45308	14BB					D5358	45358	14ED				
D5309	45309	14BC					D5359	45359	14EE				
D5310	45310	14BD					D5360	45360	14EF				
D5311	45311	14BE	V.AT	R/W	R/W	R/W	D5361	45361	14F0				
D5312	45312	14BF	V.RS	R/W	R/W	R/W	D5362	45362	14F1				
D5313	45313	14C0	V.L	R	R	R	D5363	45363	14F2				
D5314	45314	14C1	V.H	R	R	R	D5364	45364	14F3				
D5315	45315	14C2	TR.T	R/W	R/W	R/W	D5365	45365	14F4				
D5316	45316	14C3	V.MOD	R/W	R/W	R/W	D5366	45366	14F5				
D5317	45317	14C4					D5367	45367	14F6				
D5318	45318	14C5					D5368	45368	14F7				
D5319	45319	14C6					D5369	45369	14F8				
D5320	45320	14C7					D5370	45370	14F9				
D5321	45321	14C8	RTS	R/W	R/W	R/W	D5371	45371	14FA				
D5322	45322	14C9	RTH	R/W	R/W	R/W	D5372	45372	14FB				
D5323	45323	14CA	RTL	R/W	R/W	R/W	D5373	45373	14FC				
D5324	45324	14CB	O1RS	R/W	R/W	R/W	D5374	45374	14FD				
D5325	45325	14CC	O1RH	R/W	R/W	R/W	D5375	45375	14FE				
D5326	45326	14CD	O1RL	R/W	R/W	R/W	D5376	45376	14FF				
D5327	45327	14CE					D5377	45377	1500				
D5328	45328	14CF					D5378	45378	1501				
D5329	45329	14D0					D5379	45379	1502				
D5330	45330	14D1					D5380	45380	1503				
D5331	45331	14D2					D5381	45381	1504				
D5332	45332	14D3					D5382	45382	1505				
D5333	45333	14D4					D5383	45383	1506				
D5334	45334	14D5					D5384	45384	1507				
D5335	45335	14D6					D5385	45385	1508				
D5336	45336	14D7					D5386	45386	1509				
D5337	45337	14D8					D5387	45387	150A				
D5338	45338	14D9					D5388	45388	150B				
D5339	45339	14DA					D5389	45389	150C				
D5340	45340	14DB					D5390	45390	150D				
D5341	45341	14DC	OU.A	R/W	R/W	R/W	D5391	45391	150E				
D5342	45342	14DD					D5392	45392	150F				
D5343	45343	14DE	RET.A	R/W	R/W	R/W	D5393	45393	1510				
D5344	45344	14DF					D5394	45394	1511				
D5345	45345	14E0					D5395	45395	1512				
D5346	45346	14E1					D5396	45396	1513				
D5347	45347	14E2					D5397	45397	1514				
D5348	45348	14E3					D5398	45398	1515				
D5349	45349	14E4					D5399	45399	1516				
D5350	45350	14E5					D5400	45400	1517				

Setup parameter													
Heater break alarm setting (Menu: HBA)													
D-Reg No.	Ref. No.	H No.	Register symbol	R/W			D-Reg No.	Ref. No.	H No.	Register symbol	R/W		
				UT 35A	UT 32A	UP 35A					UT 35A	UT 32A	UP 35A
D5401	45401	1518	HB1.S	R/W	R/W	R/W	D5451	45451	154A				
D5402	45402	1519	HB2.S	R/W	R/W	R/W	D5452	45452	154B				
D5403	45403	151A	HB1	R/W	R/W	R/W	D5453	45453	154C				
D5404	45404	151B	HB2	R/W	R/W	R/W	D5454	45454	154D				
D5405	45405	151C	CT1.T	R/W	R/W	R/W	D5455	45455	154E				
D5406	45406	151D	CT2.T	R/W	R/W	R/W	D5456	45456	154F				
D5407	45407	151E	HDN1	R/W	R/W	R/W	D5457	45457	1550				
D5408	45408	151F	HDN2	R/W	R/W	R/W	D5458	45458	1551				
D5409	45409	1520	HDF1	R/W	R/W	R/W	D5459	45459	1552				
D5410	45410	1521	HDF2	R/W	R/W	R/W	D5460	45460	1553				
D5411	45411	1522	HB1.D	R/W	R/W	R/W	D5461	45461	1554				
D5412	45412	1523	HB2.D	R/W	R/W	R/W	D5462	45462	1555				
D5413	45413	1524					D5463	45463	1556				
D5414	45414	1525					D5464	45464	1557				
D5415	45415	1526					D5465	45465	1558				
D5416	45416	1527					D5466	45466	1559				
D5417	45417	1528					D5467	45467	155A				
D5418	45418	1529					D5468	45468	155B				
D5419	45419	152A					D5469	45469	155C				
D5420	45420	152B					D5470	45470	155D				
D5421	45421	152C					D5471	45471	155E				
D5422	45422	152D					D5472	45472	155F				
D5423	45423	152E					D5473	45473	1560				
D5424	45424	152F					D5474	45474	1561				
D5425	45425	1530					D5475	45475	1562				
D5426	45426	1531					D5476	45476	1563				
D5427	45427	1532					D5477	45477	1564				
D5428	45428	1533					D5478	45478	1565				
D5429	45429	1534					D5479	45479	1566				
D5430	45430	1535					D5480	45480	1567				
D5431	45431	1536					D5481	45481	1568				
D5432	45432	1537					D5482	45482	1569				
D5433	45433	1538					D5483	45483	156A				
D5434	45434	1539					D5484	45484	156B				
D5435	45435	153A					D5485	45485	156C				
D5436	45436	153B					D5486	45486	156D				
D5437	45437	153C					D5487	45487	156E				
D5438	45438	153D					D5488	45488	156F				
D5439	45439	153E					D5489	45489	1570				
D5440	45440	153F					D5490	45490	1571				
D5441	45441	1540					D5491	45491	1572				
D5442	45442	1541					D5492	45492	1573				
D5443	45443	1542					D5493	45493	1574				
D5444	45444	1543					D5494	45494	1575				
D5445	45445	1544					D5495	45495	1576				
D5446	45446	1545					D5496	45496	1577				
D5447	45447	1546					D5497	45497	1578				
D5448	45448	1547					D5498	45498	1579				
D5449	45449	1548					D5499	45499	157A				
D5450	45450	1549					D5500	45500	157B				

8.4 UT35A/UT32A/UP35A D Registers

Setup parameter													
Communication setting (RS-485 communication setting menu: R485) (Ethernet communication setting menu: ETHR) (Error and version confirmation menu: VER) (CC-Link communication setting menu: CC-L) (DeviceNet communication setting menu: DNET)													
D-Reg No.	Ref. No.	H No.	Register symbol	R/W			D-Reg No.	Ref. No.	H No.	Register symbol	R/W		
				UT 35A	UT 32A	UP 35A					UT 35A	UT 32A	UP 35A
D5501	45501	157C	PSL_E1		R/W		D5551	45551	15AE	SM4_E3	R/W		R/W
D5502	45502	157D	BPS_E1		R/W		D5552	45552	15AF	DG1_E3	R/W		R/W
D5503	45503	157E	PRI_E1		R/W		D5553	45553	15B0	DG2_E3	R/W		R/W
D5504	45504	157F	STP_E1		R/W		D5554	45554	15B1	DG3_E3	R/W		R/W
D5505	45505	1580	DLN_E1		R/W		D5555	45555	15B2	DG4_E3	R/W		R/W
D5506	45506	1581	ADR_E1		R/W		D5556	45556	15B3	PRT_E3	R/W		R/W
D5507	45507	1582	RP.T_E1		R/W		D5557	45557	15B4	IPAR_E3	R/W		R/W
D5508	45508	1583					D5558	45558	15B5	1.IP1_E3	R/W		R/W
D5509	45509	1584					D5559	45559	15B6	1.IP2_E3	R/W		R/W
D5510	45510	1585					D5560	45560	15B7	1.IP3_E3	R/W		R/W
D5511	45511	1586					D5561	45561	15B8	1.IP4_E3	R/W		R/W
D5512	45512	1587					D5562	45562	15B9	2.IP1_E3	R/W		R/W
D5513	45513	1588					D5563	45563	15BA	2.IP2_E3	R/W		R/W
D5514	45514	1589					D5564	45564	15BB	2.IP3_E3	R/W		R/W
D5515	45515	158A					D5565	45565	15BC	2.IP4_E3	R/W		R/W
D5516	45516	158B					D5566	45566	15BD	ESW_E3	R/W		R/W
D5517	45517	158C					D5567	45567	15BE				
D5518	45518	158D					D5568	45568	15BF				
D5519	45519	158E					D5569	45569	15C0				
D5520	45520	158F					D5570	45570	15C1				
D5521	45521	1590	PSL_E3	R/W		R/W	D5571	45571	15C2	MAC1_E3	R		R
D5522	45522	1591	BPS_E3	R/W		R/W	D5572	45572	15C3	MAC2_E3	R		R
D5523	45523	1592	PRI_E3	R/W		R/W	D5573	45573	15C4	MAC3_E3	R		R
D5524	45524	1593	STP_E3	R/W		R/W	D5574	45574	15C5				
D5525	45525	1594	DLN_E3	R/W		R/W	D5575	45575	15C6				
D5526	45526	1595	ADR_E3	R/W		R/W	D5576	45576	15C7				
D5527	45527	1596	RP.T_E3	R/W		R/W	D5577	45577	15C8				
D5528	45528	1597					D5578	45578	15C9				
D5529	45529	1598					D5579	45579	15CA				
D5530	45530	1599					D5580	45580	15CB				
D5531	45531	159A					D5581	45581	15CC	BR_E3-C *1	R/W		R/W
D5532	45532	159B					D5582	45582	15CD	ADR_E3-C *1	R/W		R/W
D5533	45533	159C					D5583	45583	15CE	BPS_E3-C *1	R/W		R/W
D5534	45534	159D					D5584	45584	15CF	FILE_E3-C *1	R/W		R/W
D5535	45535	159E					D5585	45585	15D0	SCAN_E3-C *1	R/W		R/W
D5536	45536	159F					D5586	45586	15D1				
D5537	45537	15A0					D5587	45587	15D2				
D5538	45538	15A1					D5588	45588	15D3				
D5539	45539	15A2					D5589	45589	15D4				
D5540	45540	15A3					D5590	45590	15D5				
D5541	45541	15A4	HSR_E3	R/W		R/W	D5591	45591	15D6	BR_E3-D *1	R/W		R/W
D5542	45542	15A5	BPS_E3	R/W		R/W	D5592	45592	15D7	ADR_E3-D *1	R/W		R/W
D5543	45543	15A6	PRI_E3	R/W		R/W	D5593	45593	15D8	BPS_E3-D *1	R/W		R/W
D5544	45544	15A7	IP1_E3	R/W		R/W	D5594	45594	15D9	FILE_E3-D *1	R/W		R/W
D5545	45545	15A8	IP2_E3	R/W		R/W	D5595	45595	15DA	SCAN_E3-D *1	R/W		R/W
D5546	45546	15A9	IP3_E3	R/W		R/W	D5596	45596	15DB				
D5547	45547	15AA	IP4_E3	R/W		R/W	D5597	45597	15DC				
D5548	45548	15AB	SM1_E3	R/W		R/W	D5598	45598	15DD				
D5549	45549	15AC	SM2_E3	R/W		R/W	D5599	45599	15DE				
D5550	45550	15AD	SM3_E3	R/W		R/W	D5600	45600	15DF				

*1: Same parameter exists in other menu. "-C" is added to the end of the parameter in CC-L menu (for CC-Link communication), and "-D" is added to the end of the parameter in DNET menu (for DeviceNet communication).

Setup parameter													
Communication setting (PROFIBUS-DP communication setting menu: PROF)													
D-Reg No.	Ref. No.	H No.	Register symbol	R/W			D-Reg No.	Ref. No.	H No.	Register symbol	R/W		
				UT 35A	UT 32A	UP 35A					UT 35A	UT 32A	UP 35A
D5601	45601	15E0	BR_E3-P *1	R/W		R/W	D5651	45651	1612				
D5602	45602	15E1	ADR_E3-P *1	R/W		R/W	D5652	45652	1613				
D5603	45603	15E2	BPS_E3-P *1	R/W		R/W	D5653	45653	1614				
D5604	45604	15E3	FILE_E3-P *1	R/W		R/W	D5654	45654	1615				
D5605	45605	15E4	SCAN_E3-P *1	R/W		R/W	D5655	45655	1616				
D5606	45606	15E5					D5656	45656	1617				
D5607	45607	15E6					D5657	45657	1618				
D5608	45608	15E7					D5658	45658	1619				
D5609	45609	15E8					D5659	45659	161A				
D5610	45610	15E9					D5660	45660	161B				
D5611	45611	15EA					D5661	45661	161C				
D5612	45612	15EB					D5662	45662	161D				
D5613	45613	15EC					D5663	45663	161E				
D5614	45614	15ED					D5664	45664	161F				
D5615	45615	15EE					D5665	45665	1620				
D5616	45616	15EF					D5666	45666	1621				
D5617	45617	15F0					D5667	45667	1622				
D5618	45618	15F1					D5668	45668	1623				
D5619	45619	15F2					D5669	45669	1624				
D5620	45620	15F3					D5670	45670	1625				
D5621	45621	15F4					D5671	45671	1626				
D5622	45622	15F5					D5672	45672	1627				
D5623	45623	15F6					D5673	45673	1628				
D5624	45624	15F7					D5674	45674	1629				
D5625	45625	15F8					D5675	45675	162A				
D5626	45626	15F9					D5676	45676	162B				
D5627	45627	15FA					D5677	45677	162C				
D5628	45628	15FB					D5678	45678	162D				
D5629	45629	15FC					D5679	45679	162E				
D5630	45630	15FD					D5680	45680	162F				
D5631	45631	15FE					D5681	45681	1630				
D5632	45632	15FF					D5682	45682	1631				
D5633	45633	1600					D5683	45683	1632				
D5634	45634	1601					D5684	45684	1633				
D5635	45635	1602					D5685	45685	1634				
D5636	45636	1603					D5686	45686	1635				
D5637	45637	1604					D5687	45687	1636				
D5638	45638	1605					D5688	45688	1637				
D5639	45639	1606					D5689	45689	1638				
D5640	45640	1607					D5690	45690	1639				
D5641	45641	1608					D5691	45691	163A				
D5642	45642	1609					D5692	45692	163B				
D5643	45643	160A					D5693	45693	163C				
D5644	45644	160B					D5694	45694	163D				
D5645	45645	160C					D5695	45695	163E				
D5646	45646	160D					D5696	45696	163F				
D5647	45647	160E					D5697	45697	1640				
D5648	45648	160F					D5698	45698	1641				
D5649	45649	1610					D5699	45699	1642				
D5650	45650	1611					D5700	45700	1643				

*1: Same parameter exists in other menu. "-P" is added to the end of the parameter in PROF menu (for PROFIBUS-DP communication).

8.4 UT35A/UT32A/UP35A D Registers

Setup parameter													
Key operation setting (Menu: KEY), Display function setting (Menu: DISP), SELECT Display setting (Menu: CSEL)													
D-Reg No.	Ref. No.	H No.	Register symbol	R/W			D-Reg No.	Ref. No.	H No.	Register symbol	R/W		
				UT 35A	UT 32A	UP 35A					UT 35A	UT 32A	UP 35A
D5701	45701	1644	F1-K *1	R/W			D5751	45751	1676	B.STS	R/W	R/W	R/W
D5702	45702	1645	F2-K *1	R/W			D5752	45752	1677				
D5703	45703	1646	Fn-K *1	R/W	R/W	R/W	D5753	45753	1678	D.CYC	R/W	R/W	R/W
D5704	45704	1647	A/M-K *1	R/W	R/W	R/W	D5754	45754	1679	OP.JP	R/W	R/W	R/W
D5705	45705	1648	RUN-K *1			R/W	D5755	45755	167A	MLSD	R/W	R/W	R/W
D5706	45706	1649	RST-K *1			R/W	D5756	45756	167B	PTSL			R/W
D5707	45707	164A	PTN-K *1			R/W	D5757	45757	167C				
D5708	45708	164B	MODE-K *1			R/W	D5758	45758	167D				
D5709	45709	164C					D5759	45759	167E				
D5710	45710	164D					D5760	45760	167F				
D5711	45711	164E					D5761	45761	1680	CS1	R/W	R/W	R/W
D5712	45712	164F					D5762	45762	1681	CS2	R/W	R/W	R/W
D5713	45713	1650	PCMD_L1	R/W	R/W	R/W	D5763	45763	1682	CS3	R/W	R/W	R/W
D5714	45714	1651	PCH_L1	R/W	R/W	R/W	D5764	45764	1683	CS4	R/W	R/W	R/W
D5715	45715	1652	PCL_L1	R/W	R/W	R/W	D5765	45765	1684	CS5	R/W	R/W	R/W
D5716	45716	1653					D5766	45766	1685				
D5717	45717	1654					D5767	45767	1686				
D5718	45718	1655					D5768	45768	1687				
D5719	45719	1656	BAR1	R/W	R/W	R/W	D5769	45769	1688				
D5720	45720	1657					D5770	45770	1689	CS10	R/W	R/W	R/W
D5721	45721	1658	BDV_L1	R/W	R/W	R/W	D5771	45771	168A	CS11	R/W	R/W	R/W
D5722	45722	1659					D5772	45772	168B	CS12	R/W	R/W	R/W
D5723	45723	165A	EV1_L1	R/W	R/W	R/W	D5773	45773	168C	CS13	R/W	R/W	R/W
D5724	45724	165B	EV2_L1	R/W	R/W	R/W	D5774	45774	168D	CS14	R/W	R/W	R/W
D5725	45725	165C	EV3_L1	R/W	R/W		D5775	45775	168E	CS15	R/W	R/W	R/W
D5726	45726	165D	EV4_L1	R/W	R/W		D5776	45776	168F	CS16	R/W	R/W	R/W
D5727	45727	165E					D5777	45777	1690	CS17	R/W	R/W	R/W
D5728	45728	165F					D5778	45778	1691	CS18	R/W	R/W	R/W
D5729	45729	1660					D5779	45779	1692	CS19	R/W	R/W	R/W
D5730	45730	1661					D5780	45780	1693				
D5731	45731	1662					D5781	45781	1694				
D5732	45732	1663					D5782	45782	1695				
D5733	45733	1664					D5783	45783	1696				
D5734	45734	1665					D5784	45784	1697				
D5735	45735	1666					D5785	45785	1698				
D5736	45736	1667					D5786	45786	1699				
D5737	45737	1668					D5787	45787	169A				
D5738	45738	1669					D5788	45788	169B				
D5739	45739	166A	PV.D	R/W	R/W	R/W	D5789	45789	169C				
D5740	45740	166B	SP.D	R/W	R/W	R/W	D5790	45790	169D				
D5741	45741	166C	STS.D	R/W	R/W	R/W	D5791	45791	169E				
D5742	45742	166D	SPD	R/W	R/W	R/W	D5792	45792	169F				
D5743	45743	166E	GUID	R/W	R/W	R/W	D5793	45793	16A0				
D5744	45744	166F	HOME	R/W	R/W	R/W	D5794	45794	16A1				
D5745	45745	1670	ECO	R/W	R/W	R/W	D5795	45795	16A2				
D5746	45746	1671	BRI	R/W	R/W	R/W	D5796	45796	16A3				
D5747	45747	1672	B.PVW	R/W	R/W	R/W	D5797	45797	16A4				
D5748	45748	1673	B.PVR	R/W	R/W	R/W	D5798	45798	16A5				
D5749	45749	1674	B.SP	R/W	R/W	R/W	D5799	45799	16A6				
D5750	45750	1675	B.BAR	R/W	R/W	R/W	D5800	45800	16A7				

*1: Same parameter exists in other menu. "-K" is added to the end of the parameter in KEY menu.

Setup parameter													
Lock setting (Key lock setting menu: KLOC) (Menu lock setting menu: MLOC)													
D-Reg No.	Ref. No.	H No.	Register symbol	R/W			D-Reg No.	Ref. No.	H No.	Register symbol	R/W		
				UT 35A	UT 32A	UP 35A					UT 35A	UT 32A	UP 35A
D5801	45801	16A8	U.SP_L1	R/W	R/W	R/W	D5851	45851	16DA	DI.SL-L *1	R/W	R/W	R/W
D5802	45802	16A9					D5852	45852	16DB	DI.NU-L *1	R/W	R/W	R/W
D5803	45803	16AA	U.OUT_L1	R/W	R/W	R/W	D5853	45853	16DC	DI.D-L *1	R/W	R/W	R/W
D5804	45804	16AB					D5854	45854	16DD	DI.D_E1-L *1	R/W	R/W	R/W
D5805	45805	16AC	U.HCO	R/W	R/W	R/W	D5855	45855	16DE				
D5806	45806	16AD	U.VP	R/W	R/W	R/W	D5856	45856	16DF				
D5807	45807	16AE	U.MV	R/W	R/W	R/W	D5857	45857	16E0	DI.D_E4-L *1	R/W		
D5808	45808	16AF					D5858	45858	16E1	ALM-L *1	R/W	R/W	R/W
D5809	45809	16B0	U.PID_L1	R/W	R/W	R/W	D5859	45859	16E2	DO_E1-L *1	R/W	R/W	R/W
D5810	45810	16B1					D5860	45860	16E3				
D5811	45811	16B2	U.HC	R/W	R/W	R/W	D5861	45861	16E4				
D5812	45812	16B3					D5862	45862	16E5	DO_E4-L *1	R/W		
D5813	45813	16B4					D5863	45863	16E6	I/O-L *1	R/W	R/W	R/W
D5814	45814	16B5	U.PV	R/W	R/W	R/W	D5864	45864	16E7	SYS-L *1	R/W	R/W	R/W
D5815	45815	16B6					D5865	45865	16E8	INIT-L *1	R/W	R/W	R/W
D5816	45816	16B7					D5866	45866	16E9	VER-L *1	R/W	R/W	R/W
D5817	45817	16B8					D5867	45867	16EA	LVL-L *1	R/W	R/W	R/W
D5818	45818	16B9	COM.W	R/W	R/W	R/W	D5868	45868	16EB	MODE-L *1	R/W	R/W	R/W
D5819	45819	16BA	DATA-L *1	R/W	R/W	R/W	D5869	45869	16EC	CS-L *1	R/W	R/W	R/W
D5820	45820	16BB	A/M-L *1	R/W	R/W	R/W	D5870	45870	16ED	SP_L1-L *1	R/W	R/W	R/W
D5821	45821	16BC	RUN-L *1			R/W	D5871	45871	16EE	SPS_L1-L *1	R/W	R/W	R/W
D5822	45822	16BD	RST-L *1			R/W	D5872	45872	16EF	ALRM_L1-L *1	R/W	R/W	R/W
D5823	45823	16BE	PTN-L *1			R/W	D5873	45873	16F0	PROG-L *1			R/W
D5824	45824	16BF	MODE-L *1			R/W	D5874	45874	16F1	PVS_L1-L *1	R/W	R/W	R/W
D5825	45825	16C0	U.TSP			R/W	D5875	45875	16F2	PID_L1-L *1	R/W	R/W	R/W
D5826	45826	16C1	U.TM			R/W	D5876	45876	16F3	TUNE_L1-L *1	R/W	R/W	R/W
D5827	45827	16C2	U.SEG			R/W	D5877	45877	16F4	ZONE_L1-L *1	R/W	R/W	R/W
D5828	45828	16C3	U.RCY			R/W	D5878	45878	16F5				
D5829	45829	16C4	U.PTN			R/W	D5879	45879	16F6				
D5830	45830	16C5					D5880	45880	16F7				
D5831	45831	16C6	CTL-L *1	R/W	R/W	R/W	D5881	45881	16F8				
D5832	45832	16C7	PV-L *1	R/W	R/W	R/W	D5882	45882	16F9				
D5833	45833	16C8					D5883	45883	16FA				
D5834	45834	16C9					D5884	45884	16FB				
D5835	45835	16CA					D5885	45885	16FC	PPAR-L *1	R/W	R/W	R/W
D5836	45836	16CB	MPV_L1-L *1	R/W	R/W	R/W	D5886	45886	16FD				
D5837	45837	16CC					D5887	45887	16FE				
D5838	45838	16CD	OUT-L *1	R/W	R/W	R/W	D5888	45888	16FF				
D5839	45839	16CE	HBA-L *1	R/W	R/W	R/W	D5889	45889	1700				
D5840	45840	16CF	R485_E1-L *1		R/W		D5890	45890	1701	LOC-L *1			R/W
D5841	45841	16D0	R485_E3-L *1	R/W		R/W	D5891	45891	1702	EDIT-L *1			R/W
D5842	45842	16D1					D5892	45892	1703	AL_L1-L *1			R/W
D5843	45843	16D2	ETHR_E3-L *1	R/W		R/W	D5893	45893	1704				
D5844	45844	16D3	PROF_E3-L *1	R/W		R/W	D5894	45894	1705				
D5845	45845	16D4	DNET_E3-L *1	R/W		R/W	D5895	45895	1706				
D5846	45846	16D5	CC-L_E3-L *1	R/W		R/W	D5896	45896	1707				
D5847	45847	16D6	KEY-L *1	R/W	R/W	R/W	D5897	45897	1708				
D5848	45848	16D7	DISP-L *1	R/W	R/W	R/W	D5898	45898	1709				
D5849	45849	16D8	CSEL-L *1	R/W	R/W	R/W	D5899	45899	170A				
D5850	45850	16D9	KLOC-L *1	R/W	R/W	R/W	D5900	45900	170B				

*1: Same parameter exists in other menu. "-L" is added to the end of the parameter in KLOC menu or MLOC menu.

8.4 UT35A/UT32A/UP35A D Registers

Setup parameter													
DI function setting (DI function registration menu: DI.SL) (DI function numbering menu: DI.NU)													
D-Reg No.	Ref. No.	H No.	Register symbol	R/W			D-Reg No.	Ref. No.	H No.	Register symbol	R/W		
				UT 35A	UT 32A	UP 35A					UT 35A	UT 32A	UP 35A
D5901	45901	170C	A/M-D *1	R/W	R/W		D5951	45951	173E				
D5902	45902	170D	R/L_L1-D *1	R/W	R/W		D5952	45952	173F				
D5903	45903	170E					D5953	45953	1740	PT.BC-D		R/W	
D5904	45904	170F	S/R-D *1	R/W	R/W		D5954	45954	1741	PT.B0-D		R/W	
D5905	45905	1710					D5955	45955	1742	PT.B1D		R/W	
D5906	45906	1711	AUTO-D *1	R/W	R/W		D5956	45956	1743	PT.B2-D		R/W	
D5907	45907	1712	MAN-D *1	R/W	R/W		D5957	45957	1744				
D5908	45908	1713	REM_L1-D *1	R/W	R/W		D5958	45958	1745				
D5909	45909	1714	LCL_L1-D *1	R/W	R/W		D5959	45959	1746				
D5910	45910	1715					D5960	45960	1747	MP.BC_L1	R/W	R/W	
D5911	45911	1716					D5961	45961	1748	MP.B0_L1	R/W	R/W	
D5912	45912	1717	ADV-D			R/W	D5962	45962	1749	MP.B1_L1	R/W	R/W	
D5913	45913	1718	HOLD-D			R/W	D5963	45963	174A	MP.B2_L1	R/W	R/W	
D5914	45914	1719	AT-D *1	R/W	R/W	R/W	D5964	45964	174B				
D5915	45915	171A					D5965	45965	174C				
D5916	45916	171B					D5966	45966	174D				
D5917	45917	171C					D5967	45967	174E				
D5918	45918	171D					D5968	45968	174F				
D5919	45919	171E					D5969	45969	1750				
D5920	45920	171F	LAT-D *1	R/W	R/W	R/W	D5970	45970	1751				
D5921	45921	1720	LCD-D *1	R/W	R/W	R/W	D5971	45971	1752				
D5922	45922	1721	MG1-D *1	R/W	R/W	R/W	D5972	45972	1753				
D5923	45923	1722	MG2-D *1	R/W	R/W	R/W	D5973	45973	1754				
D5924	45924	1723	MG3-D *1	R/W	R/W	R/W	D5974	45974	1755				
D5925	45925	1724	MG4-D *1	R/W	R/W	R/W	D5975	45975	1756				
D5926	45926	1725	PRG-D *1			R/W	D5976	45976	1757				
D5927	45927	1726	RST-D *1			R/W	D5977	45977	1758				
D5928	45928	1727	LOC-D *1			R/W	D5978	45978	1759				
D5929	45929	1728					D5979	45979	175A				
D5930	45930	1729	P/R-D *1			R/W	D5980	45980	175B				
D5931	45931	172A	P/L-D *1			R/W	D5981	45981	175C				
D5932	45932	172B	WAIT-D *1			R/W	D5982	45982	175D				
D5933	45933	172C	A/M_L1-D *1			R/W	D5983	45983	175E				
D5934	45934	172D					D5984	45984	175F				
D5935	45935	172E					D5985	45985	1760				
D5936	45936	172F	P/H-D *1			R/W	D5986	45986	1761				
D5937	45937	1730	PVRW_L1-D *1	R/W	R/W	R/W	D5987	45987	1762				
D5938	45938	1731					D5988	45988	1763				
D5939	45939	1732	S.HLD-D *1			R/W	D5989	45989	1764				
D5940	45940	1733					D5990	45990	1765				
D5941	45941	1734	SP.BC	R/W	R/W		D5991	45991	1766				
D5942	45942	1735	SP.B0	R/W	R/W		D5992	45992	1767				
D5943	45943	1736	SP.B1	R/W	R/W		D5993	45993	1768				
D5944	45944	1737	SP.B2	R/W	R/W		D5994	45994	1769				
D5945	45945	1738					D5995	45995	176A				
D5946	45946	1739					D5996	45996	176B				
D5947	45947	173A	PN.BC	R/W	R/W	R/W	D5997	45997	176C				
D5948	45948	173B	PN.B0	R/W	R/W	R/W	D5998	45998	176D				
D5949	45949	173C	PN.B1	R/W	R/W	R/W	D5999	45999	176E				
D5950	45950	173D	PN.B2	R/W	R/W	R/W	D6000	46000	176F				

*1: Same parameter exists in other menu. "-D" is added to the end of the parameter in DI.SL menu.

Setup parameter													
DI function setting (Message)													
D-Reg No.	Ref. No.	H No.	Register symbol	R/W			D-Reg No.	Ref. No.	H No.	Register symbol	R/W		
				UT 35A	UT 32A	UP 35A					UT 35A	UT 32A	UP 35A
D6001	46001	1770	MSG1	R/W	R/W	R/W	D6051	46051	17A2	MSG3	R/W	R/W	R/W
D6002	46002	1771	MSG1	R/W	R/W	R/W	D6052	46052	17A3				
D6003	46003	1772	MSG1	R/W	R/W	R/W	D6053	46053	17A4				
D6004	46004	1773	MSG1	R/W	R/W	R/W	D6054	46054	17A5				
D6005	46005	1774	MSG1	R/W	R/W	R/W	D6055	46055	17A6				
D6006	46006	1775	MSG1	R/W	R/W	R/W	D6056	46056	17A7				
D6007	46007	1776	MSG1	R/W	R/W	R/W	D6057	46057	17A8				
D6008	46008	1777	MSG1	R/W	R/W	R/W	D6058	46058	17A9				
D6009	46009	1778	MSG1	R/W	R/W	R/W	D6059	46059	17AA				
D6010	46010	1779	MSG1	R/W	R/W	R/W	D6060	46060	17AB				
D6011	46011	177A	MSG1	R/W	R/W	R/W	D6061	46061	17AC	MSG4	R/W	R/W	R/W
D6012	46012	177B					D6062	46062	17AD	MSG4	R/W	R/W	R/W
D6013	46013	177C					D6063	46063	17AE	MSG4	R/W	R/W	R/W
D6014	46014	177D					D6064	46064	17AF	MSG4	R/W	R/W	R/W
D6015	46015	177E					D6065	46065	17B0	MSG4	R/W	R/W	R/W
D6016	46016	177F					D6066	46066	17B1	MSG4	R/W	R/W	R/W
D6017	46017	1780					D6067	46067	17B2	MSG4	R/W	R/W	R/W
D6018	46018	1781					D6068	46068	17B3	MSG4	R/W	R/W	R/W
D6019	46019	1782					D6069	46069	17B4	MSG4	R/W	R/W	R/W
D6020	46020	1783					D6070	46070	17B5	MSG4	R/W	R/W	R/W
D6021	46021	1784	MSG2	R/W	R/W	R/W	D6071	46071	17B6	MSG4	R/W	R/W	R/W
D6022	46022	1785	MSG2	R/W	R/W	R/W	D6072	46072	17B7				
D6023	46023	1786	MSG2	R/W	R/W	R/W	D6073	46073	17B8				
D6024	46024	1787	MSG2	R/W	R/W	R/W	D6074	46074	17B9				
D6025	46025	1788	MSG2	R/W	R/W	R/W	D6075	46075	17BA				
D6026	46026	1789	MSG2	R/W	R/W	R/W	D6076	46076	17BB				
D6027	46027	178A	MSG2	R/W	R/W	R/W	D6077	46077	17BC				
D6028	46028	178B	MSG2	R/W	R/W	R/W	D6078	46078	17BD				
D6029	46029	178C	MSG2	R/W	R/W	R/W	D6079	46079	17BE				
D6030	46030	178D	MSG2	R/W	R/W	R/W	D6080	46080	17BF				
D6031	46031	178E	MSG2	R/W	R/W	R/W	D6081	46081	17C0				
D6032	46032	178F					D6082	46082	17C1				
D6033	46033	1790					D6083	46083	17C2				
D6034	46034	1791					D6084	46084	17C3				
D6035	46035	1792					D6085	46085	17C4				
D6036	46036	1793					D6086	46086	17C5				
D6037	46037	1794					D6087	46087	17C6				
D6038	46038	1795					D6088	46088	17C7				
D6039	46039	1796					D6089	46089	17C8				
D6040	46040	1797					D6090	46090	17C9				
D6041	46041	1798	MSG3	R/W	R/W	R/W	D6091	46091	17CA				
D6042	46042	1799	MSG3	R/W	R/W	R/W	D6092	46092	17CB				
D6043	46043	179A	MSG3	R/W	R/W	R/W	D6093	46093	17CC				
D6044	46044	179B	MSG3	R/W	R/W	R/W	D6094	46094	17CD				
D6045	46045	179C	MSG3	R/W	R/W	R/W	D6095	46095	17CE				
D6046	46046	179D	MSG3	R/W	R/W	R/W	D6096	46096	17CF				
D6047	46047	179E	MSG3	R/W	R/W	R/W	D6097	46097	17D0				
D6048	46048	179F	MSG3	R/W	R/W	R/W	D6098	46098	17D1				
D6049	46049	17A0	MSG3	R/W	R/W	R/W	D6099	46099	17D2				
D6050	46050	17A1	MSG3	R/W	R/W	R/W	D6100	46100	17D3				

8.4 UT35A/UT32A/UP35A D Registers

Setup parameter													
DI function setting (DI1-DI2 contact type setting menu: DI.D) (DI setting menu (E1, E4): DI.D)													
D-Reg No.	Ref. No.	H No.	Register symbol	R/W			D-Reg No.	Ref. No.	H No.	Register symbol	R/W		
				UT 35A	UT 32A	UP 35A					UT 35A	UT 32A	UP 35A
D6101	46101	17D4	DI1.D	R/W	R/W	R/W	D6151	46151	1806				
D6102	46102	17D5	DI2.D	R/W	R/W	R/W	D6152	46152	1807				
D6103	46103	17D6	DI3.D	R/W	R/W	R/W	D6153	46153	1808				
D6104	46104	17D7					D6154	46154	1809				
D6105	46105	17D8					D6155	46155	180A				
D6106	46106	17D9					D6156	46156	180B				
D6107	46107	17DA					D6157	46157	180C				
D6108	46108	17DB					D6158	46158	180D				
D6109	46109	17DC					D6159	46159	180E				
D6110	46110	17DD					D6160	46160	180F				
D6111	46111	17DE					D6161	46161	1810				
D6112	46112	17DF					D6162	46162	1811				
D6113	46113	17E0					D6163	46163	1812				
D6114	46114	17E1					D6164	46164	1813				
D6115	46115	17E2					D6165	46165	1814				
D6116	46116	17E3					D6166	46166	1815				
D6117	46117	17E4					D6167	46167	1816				
D6118	46118	17E5					D6168	46168	1817				
D6119	46119	17E6					D6169	46169	1818				
D6120	46120	17E7					D6170	46170	1819				
D6121	46121	17E8	DI1.D_E1	R/W	R/W	R/W	D6171	46171	181A				
D6122	46122	17E9	DI2.D_E1	R/W	R/W	R/W	D6172	46172	181B				
D6123	46123	17EA	DI3.D_E1	R/W	R/W	R/W	D6173	46173	181C				
D6124	46124	17EB	DI4.D_E1	R/W	R/W	R/W	D6174	46174	181D				
D6125	46125	17EC	DI5.D_E1	R/W	R/W	R/W	D6175	46175	181E				
D6126	46126	17ED					D6176	46176	181F				
D6127	46127	17EE					D6177	46177	1820				
D6128	46128	17EF					D6178	46178	1821				
D6129	46129	17F0					D6179	46179	1822				
D6130	46130	17F1					D6180	46180	1823				
D6131	46131	17F2					D6181	46181	1824	DI1.D_E4	R/W	R/W	
D6132	46132	17F3					D6182	46182	1825	DI2.D_E4	R/W	R/W	
D6133	46133	17F4					D6183	46183	1826	DI3.D_E4	R/W	R/W	
D6134	46134	17F5					D6184	46184	1827	DI4.D_E4	R/W	R/W	
D6135	46135	17F6					D6185	46185	1828	DI5.D_E4	R/W	R/W	
D6136	46136	17F7					D6186	46186	1829				
D6137	46137	17F8					D6187	46187	182A				
D6138	46138	17F9					D6188	46188	182B				
D6139	46139	17FA					D6189	46189	182C				
D6140	46140	17FB					D6190	46190	182D				
D6141	46141	17FC					D6191	46191	182E				
D6142	46142	17FD					D6192	46192	182F				
D6143	46143	17FE					D6193	46193	1830				
D6144	46144	17FF					D6194	46194	1831				
D6145	46145	1800					D6195	46195	1832				
D6146	46146	1801					D6196	46196	1833				
D6147	46147	1802					D6197	46197	1834				
D6148	46148	1803					D6198	46198	1835				
D6149	46149	1804					D6199	46199	1836				
D6150	46150	1805					D6200	46200	1837				

Setup parameter													
DO function setting (AL1-AL3 function registration menu: ALM) (DO setting menu (E1 to E4): DO)													
D-Reg No.	Ref. No.	H No.	Register symbol	R/W			D-Reg No.	Ref. No.	H No.	Register symbol	R/W		
				UT 35A	UT 32A	UP 35A					UT 35A	UT 32A	UP 35A
D6201	46201	1838	AL1.S	R/W	R/W	R/W	D6251	46251	186A				
D6202	46202	1839	AL2.S	R/W	R/W	R/W	D6252	46252	186B				
D6203	46203	183A	AL3.S	R/W	R/W	R/W	D6253	46253	186C				
D6204	46204	183B	OR.S	R/W	R/W	R/W	D6254	46254	186D				
D6205	46205	183C	OR2.S	R/W	R/W	R/W	D6255	46255	186E				
D6206	46206	183D	AL1.D	R/W	R/W	R/W	D6256	46256	186F				
D6207	46207	183E	AL2.D	R/W	R/W	R/W	D6257	46257	1870				
D6208	46208	183F	AL3.D	R/W	R/W	R/W	D6258	46258	1871				
D6209	46209	1840	OR.D	R/W	R/W	R/W	D6259	46259	1872				
D6210	46210	1841	OR2.D	R/W	R/W	R/W	D6260	46260	1873				
D6211	46211	1842					D6261	46261	1874				
D6212	46212	1843					D6262	46262	1875				
D6213	46213	1844					D6263	46263	1876				
D6214	46214	1845					D6264	46264	1877				
D6215	46215	1846					D6265	46265	1878				
D6216	46216	1847					D6266	46266	1879				
D6217	46217	1848					D6267	46267	187A				
D6218	46218	1849					D6268	46268	187B				
D6219	46219	184A					D6269	46269	187C				
D6220	46220	184B					D6270	46270	187D				
D6221	46221	184C	DO1.S_E1	R/W	R/W	R/W	D6271	46271	187E				
D6222	46222	184D	DO2.S_E1	R/W	R/W	R/W	D6272	46272	187F				
D6223	46223	184E	DO3.S_E1	R/W	R/W	R/W	D6273	46273	1880				
D6224	46224	184F	DO4.S_E1	R/W	R/W	R/W	D6274	46274	1881				
D6225	46225	1850	DO5.S_E1	R/W	R/W	R/W	D6275	46275	1882				
D6226	46226	1851	DO1.D_E1	R/W	R/W	R/W	D6276	46276	1883				
D6227	46227	1852	DO2.D_E1	R/W	R/W	R/W	D6277	46277	1884				
D6228	46228	1853	DO3.D_E1	R/W	R/W	R/W	D6278	46278	1885				
D6229	46229	1854	DO4.D_E1	R/W	R/W	R/W	D6279	46279	1886				
D6230	46230	1855	DO5.D_E1	R/W	R/W	R/W	D6280	46280	1887				
D6231	46231	1856					D6281	46281	1888	DO1.S_E4	R/W	R/W	
D6232	46232	1857					D6282	46282	1889	DO2.S_E4	R/W	R/W	
D6233	46233	1858					D6283	46283	188A	DO3.S_E4	R/W	R/W	
D6234	46234	1859					D6284	46284	188B	DO4.S_E4	R/W	R/W	
D6235	46235	185A					D6285	46285	188C	DO5.S_E4	R/W	R/W	
D6236	46236	185B					D6286	46286	188D	DO1.D_E4	R/W	R/W	
D6237	46237	185C					D6287	46287	188E	DO2.D_E4	R/W	R/W	
D6238	46238	185D					D6288	46288	188F	DO3.D_E4	R/W	R/W	
D6239	46239	185E					D6289	46289	1890	DO4.D_E4	R/W	R/W	
D6240	46240	185F					D6290	46290	1891	DO5.D_E4	R/W	R/W	
D6241	46241	1860					D6291	46291	1892				
D6242	46242	1861					D6292	46292	1893				
D6243	46243	1862					D6293	46293	1894				
D6244	46244	1863					D6294	46294	1895				
D6245	46245	1864					D6295	46295	1896				
D6246	46246	1865					D6296	46296	1897				
D6247	46247	1866					D6297	46297	1898				
D6248	46248	1867					D6298	46298	1899				
D6249	46249	1868					D6299	46299	189A				
D6250	46250	1869					D6300	46300	189B				

8.4 UT35A/UT32A/UP35A D Registers

Setup parameter													
I/O display (Menu: I/O)													
D-Reg No.	Ref. No.	H No.	Register symbol	R/W			D-Reg No.	Ref. No.	H No.	Register symbol	R/W		
				UT 35A	UT 32A	UP 35A					UT 35A	UT 32A	UP 35A
D6301	46301	189C	KEY-IO *1	R	R	R	D6351	46351	18CE				
D6302	46302	189D					D6352	46352	18CF				
D6303	46303	189E					D6353	46353	18D0				
D6304	46304	189F					D6354	46354	18D1				
D6305	46305	18A0					D6355	46355	18D2				
D6306	46306	18A1					D6356	46356	18D3				
D6307	46307	18A2					D6357	46357	18D4				
D6308	46308	18A3					D6358	46358	18D5				
D6309	46309	18A4					D6359	46359	18D6				
D6310	46310	18A5					D6360	46360	18D7				
D6311	46311	18A6					D6361	46361	18D8				
D6312	46312	18A7					D6362	46362	18D9				
D6313	46313	18A8					D6363	46363	18DA				
D6314	46314	18A9					D6364	46364	18DB				
D6315	46315	18AA					D6365	46365	18DC				
D6316	46316	18AB					D6366	46366	18DD				
D6317	46317	18AC					D6367	46367	18DE				
D6318	46318	18AD					D6368	46368	18DF				
D6319	46319	18AE					D6369	46369	18E0				
D6320	46320	18AF					D6370	46370	18E1				
D6321	46321	18B0					D6371	46371	18E2				
D6322	46322	18B1					D6372	46372	18E3				
D6323	46323	18B2					D6373	46373	18E4				
D6324	46324	18B3					D6374	46374	18E5				
D6325	46325	18B4					D6375	46375	18E6				
D6326	46326	18B5					D6376	46376	18E7				
D6327	46327	18B6					D6377	46377	18E8				
D6328	46328	18B7					D6378	46378	18E9				
D6329	46329	18B8					D6379	46379	18EA				
D6330	46330	18B9					D6380	46380	18EB				
D6331	46331	18BA					D6381	46381	18EC				
D6332	46332	18BB					D6382	46382	18ED				
D6333	46333	18BC					D6383	46383	18EE				
D6334	46334	18BD					D6384	46384	18EF				
D6335	46335	18BE					D6385	46385	18F0				
D6336	46336	18BF					D6386	46386	18F1				
D6337	46337	18C0					D6387	46387	18F2				
D6338	46338	18C1					D6388	46388	18F3				
D6339	46339	18C2					D6389	46389	18F4				
D6340	46340	18C3					D6390	46390	18F5				
D6341	46341	18C4					D6391	46391	18F6				
D6342	46342	18C5					D6392	46392	18F7				
D6343	46343	18C6					D6393	46393	18F8				
D6344	46344	18C7					D6394	46394	18F9				
D6345	46345	18C8					D6395	46395	18FA				
D6346	46346	18C9					D6396	46396	18FB				
D6347	46347	18CA					D6397	46397	18FC				
D6348	46348	18CB					D6398	46398	18FD				
D6349	46349	18CC					D6399	46399	18FE				
D6350	46350	18CD					D6400	46400	18FF				

*1: Same parameter exists in other menu. "-IO" is added to the end of the parameter in I/O menu.

Setup parameter													
System setting (Menu: SYS)													
D-Reg No.	Ref. No.	H No.	Register symbol	R/W			D-Reg No.	Ref. No.	H No.	Register symbol	R/W		
				UT 35A	UT 32A	UP 35A					UT 35A	UT 32A	UP 35A
D6401	46401	1900	R.MD	R/W	R/W	R/W	D6451	46451	1932				
D6402	46402	1901	R.TM	R/W	R/W	R/W	D6452	46452	1933				
D6403	46403	1902					D6453	46453	1934				
D6404	46404	1903					D6454	46454	1935				
D6405	46405	1904					D6455	46455	1936				
D6406	46406	1905					D6456	46456	1937				
D6407	46407	1906					D6457	46457	1938				
D6408	46408	1907	EPO	R/W	R/W	R/W	D6458	46458	1939				
D6409	46409	1908	C.GRN	R/W	R/W	R/W	D6459	46459	193A				
D6410	46410	1909	FREQ	R/W	R/W	R/W	D6460	46460	193B				
D6411	46411	190A					D6461	46461	193C				
D6412	46412	190B					D6462	46462	193D				
D6413	46413	190C					D6463	46463	193E				
D6414	46414	190D					D6464	46464	193F				
D6415	46415	190E					D6465	46465	1940				
D6416	46416	190F					D6466	46466	1941				
D6417	46417	1910	QSM	R/W	R/W	R/W	D6467	46467	1942				
D6418	46418	1911	LANG	R/W	R/W	R/W	D6468	46468	1943				
D6419	46419	1912					D6469	46469	1944				
D6420	46420	1913					D6470	46470	1945				
D6421	46421	1914	U.DEF	R/W	R/W	R/W	D6471	46471	1946				
D6422	46422	1915					D6472	46472	1947				
D6423	46423	1916	F.DEF	R/W	R/W	R/W	D6473	46473	1948				
D6424	46424	1917					D6474	46474	1949				
D6425	46425	1918	P.DEF	/	/	R/W	D6475	46475	194A				
D6426	46426	1919					D6476	46476	194B				
D6427	46427	191A					D6477	46477	194C				
D6428	46428	191B					D6478	46478	194D				
D6429	46429	191C					D6479	46479	194E				
D6430	46430	191D					D6480	46480	194F				
D6431	46431	191E	LEVL	R/W	R/W	R/W	D6481	46481	1950				
D6432	46432	191F					D6482	46482	1951				
D6433	46433	1920					D6483	46483	1952				
D6434	46434	1921					D6484	46484	1953				
D6435	46435	1922					D6485	46485	1954				
D6436	46436	1923					D6486	46486	1955				
D6437	46437	1924					D6487	46487	1956				
D6438	46438	1925					D6488	46488	1957				
D6439	46439	1926					D6489	46489	1958				
D6440	46440	1927					D6490	46490	1959				
D6441	46441	1928					D6491	46491	195A				
D6442	46442	1929					D6492	46492	195B				
D6443	46443	192A					D6493	46493	195C				
D6444	46444	192B					D6494	46494	195D				
D6445	46445	192C					D6495	46495	195E				
D6446	46446	192D					D6496	46496	195F				
D6447	46447	192E					D6497	46497	1960				
D6448	46448	192F					D6498	46498	1961				
D6449	46449	1930					D6499	46499	1962				
D6450	46450	1931					D6500	46500	1963				

D6501 to D7000: Free area

8.4 UT35A/UT32A/UP35A D Registers

Control Function Setting (D5001 to D5100)

Register No.		Description	Range and meaning of value
D5001 to D5002			
D5003	CNT_L1	Control type	0: PID (PID control) 1: ONOF (ON/OFF control (1 point of hysteresis)) 2: ONOF2 (ON/OFF control (2 points of hysteresis)) 3: 2P2L (Two-position two-level control) * 4: H/C (Heating/cooling control) *: For UT35A/UT32A only.
D5004			
D5005	ALG_L1	PID control mode	0: Standard PID control mode 1: Fixed-point control mode Select "Fixed-point control mode" for pressure or flow rate control.
D5006			
D5007	SPGR.	Number of SP groups	Set a number of SP groups to use. 1 to 4
D5008			
D5009	ALNO_L1	Number of alarms	1 to 4
D5010 to D5011			
D5012	ZON	Zone PID selection	<p>UT35A/UT32A</p> <p>If set to "SP group number selection," allows PID constants to be selected for each SP group. If set to "Zone PID selection," automatically selects PID constants according to the range set in the Reference point.</p> <p>0: SP group number selection 1 1: Zone PID selection (selection by PV) 2: Zone PID selection (selection by target SP) 3: SP group number selection 2 4: Zone PID selection (selection by SP)</p> <p>UP35A</p> <p>0: Segment PID selection 1: Zone PID selection (selection by PV) 2: Zone PID selection (selection by target SP) 4: Zone PID selection (selection by SP) 5: Local PID selection</p> <p>* If set to "Segment PID selection," allows PID constants to be selected for each segments. * If set to "Zone PID selection," automatically selects PID constants according to the range set in the Reference point. * If set to "Local PID selection," local PID is selected irrespective of the operation modes.</p>
D5013			
D5014	PIDG.	Number of PID groups	Set a number of PID groups to use. 1 to 4
D5015			
D5016	SEG.T	Segment setting method	0: TIME (Segment time setting) 1: TM.RT (Segment ramp-rate setting) * Note: A change of setting deletes a program pattern.
D5017	TMU	Program time unit	0: HH.MM (hour.minute) 1: MM.SS (minute.second)
D5018 to D5100			

Input Setting (D5101 to D5300)

Register No.		Description	Range and meaning of value
D5101	IN	PV input type	0: OFF (Disable) 1: K1 (-270.0 to 1370.0°C / -450.0 to 2500.0 F) 2: K2 (-270.0 to 1000.0°C / -450.0 to 2300.0 F) 3: K3 (-200.0 to 500.0°C / -200.0 to 1000.0 F) 4: J (-200.0 to 1200.0°C / -300.0 to 2300.0 F) 5: T1 (-270.0 to 400.0°C / -450.0 to 750.0 F) 6: T2 (0.0 to 400.0°C / -200.0 to 750.0 F) 7: B (0.0 to 1800.0°C / 32 to 3300 F) 8: S (0.0 to 1700.0°C / 32 to 3100 F) 9: R (0.0 to 1700.0°C / 32 to 3100 F) 10: N (-200.0 to 1300.0°C / -300.0 to 2400.0 F) 11: E (-270.0 to 1000.0°C / -450.0 to 1800.0 F) 12: L (-200.0 to 900.0°C / -300.0 to 1600.0 F) 13: U1 (-200.0 to 400.0°C / -300.0 to 750.0 F) 14: U2 (0.0 to 400.0°C / -200.0 to 1000.0 F) 15: W (0.0 to 2300.0°C / 32 to 4200 F) 16: PL2 (0.0 to 1390.0°C / 32.0 to 2500.0 F) 17: P2040 (0.0 to 1900.0°C / 32 to 3400 F) 18: WRE (0.0 to 2000.0°C / 32 to 3600 F) 30: JPT1 (-200.0 to 500.0°C / -300.0 to 1000.0 F) 31: JPT2 (-150.00 to 150.00°C / -200.0 to 300.0 F) 35: PT1 (-200.0 to 850.0°C / -300.0 to 1560.0 F) 36: PT2 (-200.0 to 500.0°C / -300.0 to 1000.0 F) 37: PT3 (-150.00 to 150.00°C / -200.0 to 300.0 F) 40: 0.4-2V (0.400 to 2.000 V) 41: 1-5V (1.000 to 5.000 V) 42: 4-20 (4.00 to 20.00 mA) 50: 0-2V (0.000 to 2.000 V) 51: 0-10V (0.00 to 10.00 V) 52: 0-20 (0.00 to 20.00 mA) 55: -1020 (-10.00 to 20.00 mV) 56: 0-100 (0.0 to 100.0 mV) *W: W-5% Re/W-26% Re(Hoskins Mfg. Co.), ASTM E988 WRE: W97Re3-W75Re25
D5102	UNIT	PV input unit	0, 2, 3, 4: - (No unit) 1: C (Degree Celsius) 5: F (Degree Fahrenheit)
D5103	DP	PV input decimal point position	0: No decimal place 1: One decimal place 2: Two decimal places 3: Three decimal places 4: Four decimal places
D5104	RH	Maximum value of PV input range	Depends on the input type. - For temperature input - Set the temperature range that is actually controlled. (RL<RH) - For voltage / current input - Set the range of a voltage / current signal that is applied. The scale across which the voltage / current signal is actually controlled should be set using the maximum value of input scale (SH) and minimum value of input scale (SL). (Input is always 0% when RL = RH.)
D5105	RL	Minimum value of PV input range	
D5106	SDP	PV input scale decimal point position	Same as D5103
D5107	SH	Maximum value of PV input scale	
D5108	SL	Minimum value of PV input scale	-19999 to 30000, (SL<SH), SH - SL ≤ 30000
D5109	BSL	PV input burnout action	0: OFF (Disable) 1: UP (Upscale) 2: DOWN (Downscale)
D5110	RJC	PV input reference junction compensation	0: OFF (RJC OFF) 1: ON (RJC ON)
D5111	ERJC	PV input external RJC setpoint	-10.0 to 60.0°C
D5112	A.BS	PV analog input bias	-100.0 to 100.0% of PV input range span (EUS)
D5113	A.FL	PV analog input filter	0: OFF 1 to 120 s
D5114 to D5200			

8.4 UT35A/UT32A/UP35A D Registers

Register No.	Description		Range and meaning of value
D5201	P.UNI_L1	Control PV input unit	0, 2, 3, 4: - (No unit) 1: C (Degree Celsius) 5: F (Degree Fahrenheit)
D5202	P.DP_L1	Control PV input decimal point position	0: No decimal place 1: One decimal place 2: Two decimal places 3: Three decimal places 4: Four decimal places
D5203	P.RH_L1	Maximum value of control PV input range	-19999 to 30000, (P.RL<P.RH), P.RH - P.RL ≤ 30000
D5204	P.RL_L1	Minimum value of control PV input range	
D5205 to D5209			
D5210	SPH_L1	SP high limit	0.0 to 100.0% of PV input range (EU), (SPL<SPH)
D5211	SPL_L1	SP low limit	
D5210 to D5300			

Output Setting (D5301 to D5400)

Register No.	Description		Range and meaning of value
D5301	OT.H	Heating-side control output selection	0: OFF 1: OUT terminals (voltage pulse) 2: OUT terminals (current) 3: OUT terminals (relay) 6: OUT2 terminals (relay)
D5302	OT.C	Cooling-side control output selection	7: RET/OUT2 terminals (voltage pulse) 8: RET/OUT2 terminals (current) When the UTAdvanced parameter is set by key stroke, the heating-side control output selection, and cooling-side control output selection comprise one parameter.
D5303	CT	Control output cycle time Heating-side control output cycle time (in Heating/cooling control)	0.5 to 1000.0 s
D5304	CTc	Cooling-side control output cycle time	
D5305 to D5310			
D5311	V.AT	Automatic valve position adjustment	0: OFF (Stop automatic adjustment) 1: ON (Start automatic adjustment)
D5312	V.RS	Valve position setting reset	0: OFF 1: ON (Resets the valve adjustment settings and causes the indication "V.RS" to blink.)
D5313	V.L	Fully-closed valve position setting	Pressing the SET/ENTER key with valve position set to the fully-closed position by Down arrow key causes the adjusted value to be stored. When V.L adjustment is complete, V.L stops blinking.
D5314	V.H	Fully-opened valve position setting	Pressing the SET/ENTER key with valve position set to the fully-opened position by Up arrow key causes the adjusted value to be stored. When V.H adjustment is complete, V.H stops blinking.
D5315	TR.T	Valve traveling time	5 to 300 s
D5316	V.MOD	Valve adjusting mode	0: Valve position feedback type 1: Valve position feedback type (moves to the estimating type if a feedback input error or break occurs.) 2: Valve position estimating type
D5317 to D5320			
D5321	RTS	Retransmission output type of RET	0: OFF (Disable) 1: PV1 (PV) 2: SP1 (SP) 3: OUT1 (OUT (Valve opening: 0 to 100 % in Position proportional control)) 4: LPS (15 V DC loop power supply) 8: TSP1 (Target SP) 9: HOUT1 (Heating-side OUT) 10: COUT1 (Cooling-side OUT) 11: MV1 (Position proportional output (internal computed value)) 16: PV (PV terminals analog input)

8.4 UT35A/UT32A/UP35A D Registers

Register No.		Description	Range and meaning of value
D5322	RTH	Maximum value of retransmission output scale of RET	When RTS=1 (PV1), 2 (SP1), 8 (TSP1), or 16 (PV), RTL+1digit to 30000 Decimal point position: RTS=1 (PV1), 2 (SP1), or 8 (TSP1): decimal point position is same as that of PV input. RTS=16 (PV): decimal point position is same as that of PV input scale.
D5323	RTL	Minimum value of retransmission output scale of RET	When RTS=1 (PV1), 2 (SP1), 8 (TSP1), or 16 (PV), -19999 to RTH-1digit Decimal point position: RTS=1 (PV1), 2 (SP1), 8 (TSP1): decimal point position is same as that of AIN4 scale. RTS=16 (PV): decimal point position is same as that of PV input scale.
D5324	O1RS	Retransmission output type of OUT current output	Same as D5321
D5325	O1RH	Maximum value of retransmission output scale of OUT current output	When O1RS=1 (PV1), 2 (SP1), 8 (TSP1), or 16 (PV), O1RL+1digit to 30000 Decimal point position: O1RS=1 (PV1), 2 (SP1), 8 (TSP1): decimal point position is same as that of PV input. O1RS=16 (PV): decimal point position is same as that of PV input scale.
D5326	O1RL	Minimum value of retransmission output scale of OUT current output	When O1RS=1 (PV1), 2 (SP1), 8 (TSP1), or 16 (PV), -19999 to O1RH-1digit O1RS=1 (PV1), 2 (SP1), 8 (TSP1): decimal point position is same as that of PV input. O1RS=16 (PV): decimal point position is same as that of PV input scale.
D5327 to D5340			
D5341	OU.A	OUT current output range	0: 4-20 (4 to 20 mA) 1: 0-20 (0 to 20 mA) 2: 20-4 (20 to 4 mA) 3: 20-0 (20 to 0 mA)
D5342			
D5343	RET.A	RET current output range	Same as D5341
D5344 to D5400			

8.4 UT35A/UT32A/UP35A D Registers

Heater Break Alarm Setting (D5401 to D5500)

Register No.		Description	Range and meaning of value
D5401	HB1.S	Heater break alarm-1 function selection	0: Heater current measurement 1: Heater break alarm (Heating-side) 2: Cooling-side heater break alarm
D5402	HB2.S	Heater break alarm-2 function selection	
D5403	HB1	Heater break alarm-1 current setpoint	0: OFF 0.1 to 300.0 Arms
D5404	HB2	Heater break alarm-2 current setpoint	
D5405	CT1.T	CT1 coil winding number ratio	1 to 3300
D5406	CT2.T	CT2 coil winding number ratio	
D5407	HDN1	Heater break alarm-1 On-delay timer	0 to 5999 (second)
D5408	HDN2	Heater break alarm-2 On-delay timer	
D5409	HDF1	Heater break alarm-1 Off-delay timer	0 to 5999 (second)
D5410	HDF2	Heater break alarm-2 Off-delay timer	
D5411	HB1.D	Heater break alarm-1 contact type	0: CLS (When the event occurs, the contact is closed.) 1: OPN (When the event occurs, the contact is opened.)
D5412	HB2.D	Heater break alarm-2 contact type	
D5413 to D5500			

Communication Setting (D5501 to D5700)

Register No.	Description		Range and meaning of value
D5501	PSL_E1	Protocol selection	0: PCL (PC link communication) 1: PCLSM (PC link communication (with checksum)) 2: LADR (Ladder communication) 3: CO-M (Coordinated master station) 4: CO-S (Coordinated slave station) 7: MBASC (Modbus (ASCII)) 8: MBRTU (Modbus (RTU)) 10: CO-S1 (Coordinated slave station (Loop-1 mode)) 11: CO-S2 (Coordinated slave station (Loop-2 mode)) 12: P-P (Peer-to-peer communication)
D5502	BPS_E1	Baud rate	0: 600 (600 bps) 1: 1200 (1200 bps) 2: 2400 (2400 bps) 3: 4800 (4800 bps) 4: 9600 (9600 bps) 5: 19200 (19.2k bps) 6: 38400 (38.4k bps) (except for communication of E4-terminal areas)
D5503	PRI_E1	Parity	0: NONE (None) 1: EVEN (Even) 2: ODD (Odd)
D5504	STP_E1	Stop bit	1: 1 bit, 2: 2 bit
D5505	DLN_E1	Data length	7: 7 bit, 8: 8bit
D5506	ADR_E1	Address	1 to 99
D5507	RPT_E1	Minimum response time	0 to 10 (x10ms)
D5508 ro D5520			
D5521	PSL_E3	Protocol selection	0: PCL (PC link communication) 1: PCLSM (PC link communication (with checksum)) 2: LADR (Ladder communication) 3: CO-M (Coordinated master station) 4: CO-S (Coordinated slave station) * 7: MBASC (Modbus (ASCII)) 8: MBRTU (Modbus (RTU)) 10: CO-S1 (Coordinated slave station (Loop-1 mode)) * 11: CO-S2 (Coordinated slave station (Loop-2 mode)) * 12: P-P (Peer-to-peer communication) *: Only for UT35A
D5522	BPS_E3	Baud rate	Same as D5502
D5523	PRI_E3	Parity	Same as D5503
D5524	STP_E3	Stop bit	1: 1 bit, 2: 2 bit
D5525	DLN_E3	Data length	7: 7 bit, 8: 8 bit
D5526	ADR_E3	Address	1 to 99
D5527	RPT_E3	Minimum response time	0 to 10 (x10ms)
D5528 to D5540			
D5541	HSR_E3	High-speed response mode	0: OFF, 1 to 8
D5542	BPS_E3	Baud rate	4: 9600 (9600 bps) 5: 19200 (19.2k bps) 6: 38400 (38.4k bps)
D5543	PRI_E3	Parity	0: NONE (None) 1: EVEN (Even) 2: ODD (Odd)
D5544	IP1_E3	IP address 1	0 to 255 Address : D5542.D5543.D5544.D5545
D5545	IP2_E3	IP address 2	
D5546	IP3_E3	IP address 3	
D5547	IP4_E3	IP address 4	
D5548	SM1_E3	Subnet mask 1	0 to 255 Address : D5546.D5547.D5548.D5549
D5549	SM2_E3	Subnet mask 2	
D5550	SM3_E3	Subnet mask 3	
D5551	SM4_E3	Subnet mask 4	

8.4 UT35A/UT32A/UP35A D Registers

Register No.	Description		Range and meaning of value
D5552	DG1_E3	Default gateway 1	0 to 255 Address : D5550.D5551.D5552.D5553
D5553	DG2_E3	Default gateway 2	
D5554	DG3_E3	Default gateway 3	
D5555	DG4_E3	Default gateway 4	
D5556	PRT_E3	Port number	502, 1024 to 65535
D5557	IPAR_E3	IP access restriction	0: OFF (Disable) 1: ON (Enable)
D5558	1.IP1_E3	Permitted IP address 1-1	0 to 255 Address : D5556.D5557.D5558.D5559
D5559	1.IP2_E3	Permitted IP address 1-2	
D5560	1.IP3_E3	Permitted IP address 1-3	
D5561	1.IP4_E3	Permitted IP address 1-4	
D5562	2.IP1_E3	Permitted IP address 2-1	0 to 255 Address : D5560.D5561.D5562.D5563
D5563	2.IP2_E3	Permitted IP address 2-2	
D5564	2.IP3_E3	Permitted IP address 2-3	
D5565	2.IP4_E3	Permitted IP address 2-4	
D5566	ESW_E3	Ethernet setting switch	0: OFF 1: ON (Enable) Setting this parameter to "1: ON" enables the Ethernet communication parameter settings. * The parameter ESW automatically returns to "0: OFF" after "1: ON" is set.
D5567 to D5570			
D5571	MAC1_E3	MAC address 1 *1	0000 to FFFF (Hex) Arrangement: D5771, D5772, D5773
D5572	MAC2_E3	MAC address 2 *1	
D5573	MAC3_E3	MAC address 3 *1	
D5574 to D5580			
D5581	BR_E3-C *2	Baud rate (for CC-link communication)	0: 156K (156k bps) 1: 625K (625k bps) 2: 2.5M (2.5M bps) 3: 5M (5M bps) 4: 10M (10M bps)
D5582	ADR_E3-C *2	Address (for CC-link communication)	1 to 64
D5583	BPS_E3-C *2	Baud rate (for CC-link communication)	4: 9600 (9600 bps) 5: 19200 (19.2k bps) 6: 38400 (38.4k bps)
D5584	FILE_E3-C *2	Profile number (for CC-link communication)	UT35A: 0 to 3 UP35A: 0, 11 to 13
D5585	SCAN_E3-C *2	Automatic rescan time (for CC-link communication)	0: OFF 1: 1M (1 minute) 2: 10M (10 minutes) 3: 30M (30 minutes) 4: 60M (60 minutes)
D5586 to D5590			
D5591	BR_E3-D *2	Baud rate (for DeviceNet communication)	0: 125K (125k bps) 1: 250K (250k bps) 2: 500K (500k bps)
D5592	ADR_E3-D *2	Address (for DeviceNet communication)	0 to 63
D5593	BPS_E3-D *2	Baud rate (for DeviceNet communication)	Same as D5583
D5594	FILE_E3-D *2	Profile number (for DeviceNet communication)	Same as D5584
D5595	SCAN_E3-C *2	Automatic rescan time (for DeviceNet communication)	Same as D5585
D5596 to D5600			

*1: With regards to the information on D5571 to D5573, three D registers comprise one parameter data.

*2: Same parameter exists in other menu. "-C" is added to the end of the parameter in CC-L menu (for CC-Link communication), and "-D" is added to the end of the parameter in DNET menu (for DeviceNet communication).

8.4 UT35A/UT32A/UP35A D Registers

Register No.	Description		Range and meaning of value
D5601	BR_E3-P *1	Baud rate (for PROFIBUS-DP communication)	0: 9.6K (9.6k bps) 1: .2K (19.2k bps) 2: 93.75K (93.75k bps) 3: 187.5K (187.5k bps) 4: 0.5M (0.5M bps) 5: 1.5M (1.5M bps) 6: 3M (3M bps) 7: 6M (6M bps) 8: 12M (12M bps) 9: AUTO 10: 45.45K (45.45k bps)
D5602	ADR_E3-P *1	Address (for PROFIBUS-DP communication)	0 to 125
D5603	BPS_E3-P *1	Baud rate (for PROFIBUS-DP communication)	Same as D5583
D5604	FILE_E3-P *1	Profile number (for PROFIBUS-DP communication)	Same as D5584
D5605	SCAN_E3-P *1	Automatic rescan time (for PROFIBUS-DP communication)	Same as D5585
D5606 to D5700			

*1: Same parameter exists in other menu. "-P" is added to the end of the parameter in PROF menu (for PROFIBUS-DP communication).

8.4 UT35A/UT32A/UP35A D Registers

Key Operation Setting, Display Function Setting, and SELECT Display Setting (D5701 to D5800)

Register No.		Description	Range and meaning of value
D5701	F1 *1	User function key-1 action setting	0: OFF (Disable) 1: A/M (AUTO/MAN switch) 3: R/L1 (REM/LCL switch) 5: S/R (STOP/RUN switch) 7: AUTO (Switch to AUTO) 8: MAN (Switch to MAN) 9: REM1 (Switch to REM) 10: LCL1 (Switch to LCL) 13: STOP (Switch to STOP) 14: RUN (Switch to RUN) 17: AT (Auto-tuning) 18: LTUP (LCD brightness UP) 19: LTDN (LCD brightness DOWN) 20: BRI (Adjust LCD brightness) 21: LCD (LCD backlight ON/OFF switch) 22: LAT (Latch release) 23: PID (PID tuning switch)
D5702	F2 *1	User function key-2 action setting	0: OFF (Disable) 1: A/M (AUTO/MAN switch) 3: R/L1 (REM/LCL switch) 5: S/R (STOP/RUN switch) 7: AUTO (Switch to AUTO) 8: MAN (Switch to MAN) 9: REM1 (Switch to REM) 10: LCL1 (Switch to LCL) 13: STOP (Switch to STOP) 14: RUN (Switch to RUN) 17: AT (Auto-tuning) 18: LTUP (LCD brightness UP) 19: LTDN (LCD brightness DOWN) 20: BRI (Adjust LCD brightness) 21: LCD (LCD backlight ON/OFF switch) 22: LAT (Latch release) 23: PID (PID tuning switch)
D5703	Fn *1	User function key-n action setting	0: OFF (Disable) 1: A/M (AUTO/MAN switch) 3: R/L1 (REM/LCL switch) 5: S/R (STOP/RUN switch) 7: AUTO (Switch to AUTO) 8: MAN (Switch to MAN)
D5704	A/M-K *1	A/M key action setting	0: OFF (Disable) 1: A/M (AUTO/MAN switch) 3: R/L1 (REM/LCL switch) 5: S/R (STOP/RUN switch) 7: AUTO (Switch to AUTO) 8: MAN (Switch to MAN)
D5705	RUN-K *1	RUN key action setting	0: OFF (Disable) 1: PROG (Switch to PROG (Start of program operation)) 2: RESET (Switch to RESET (Stop of program operation)) 3: LOCAL (Switch to LOCAL(LSP) (Start of local-mode operation)) 5: P/R (PROG/RESET switch) 6: P/H (PROG/HOLD switch) 7: P/L (PROG/LOCAL(LSP) switch) 9: HLD (Switch to HOLD (Start of hold-mode operation)) 10: ADV (Advance of segment) 11: A/M (AUTO/MAN switch) 13: PRG1 (Switch to PROG1 (Start of program-1 operation)) 14: PRG2 (Switch to PROG2 (Start of program-2 operation)) 17: AT (Auto-tuning) 18: LTUP (LCD brightness UP) 19: LTDN (LCD brightness DOWN) 20: BRI (Adjust LCD brightness) 21: LCD (LCD backlight ON/OFF switch) 22: LAT (Latch release) 23: PID (PID tuning switch) 24: PTN (Program pattern number switch) 25: MODE (Operation mode)
D5706	RST-K *1	RST key action setting	0: OFF (Disable) 1: A/M (AUTO/MAN switch) 3: R/L1 (REM/LCL switch) 5: S/R (STOP/RUN switch) 7: AUTO (Switch to AUTO) 8: MAN (Switch to MAN)
D5707	PTN-K *1	PTN Key action setting	0: OFF (Disable) 1: A/M (AUTO/MAN switch) 3: R/L1 (REM/LCL switch) 5: S/R (STOP/RUN switch) 7: AUTO (Switch to AUTO) 8: MAN (Switch to MAN)
D5708	MODE-K *1	MODE key action setting	0: OFF (Disable) 1: A/M (AUTO/MAN switch) 3: R/L1 (REM/LCL switch) 5: S/R (STOP/RUN switch) 7: AUTO (Switch to AUTO) 8: MAN (Switch to MAN)
D5709 to D5712			
D5713	PCMD_L1	Active color PV display switch	0: Fixed in white 1: Fixed in red 2: Link to alarm 1 (Alarm OFF: white, Alarm ON: red) 3: Link to alarm 1 (Alarm OFF: red, Alarm ON: white) 4: Link to alarm 1 or 2 (Alarm OFF: white, Alarm ON: red) 5: Link to alarm 1 or 2 (Alarm OFF: red, Alarm ON: white) 6: PV limit (Within range: white, Out of range: red) 7: PV limit (Within range: red, Out of range: white) 8: SP deviation (Within deviation: white, Out of deviation: red) 9: SP deviation (Within deviation: red, Out of deviation: white) 10: Link to DI (ON: red, OFF: white)
D5714	PCH_L1	PV color change high limit	Set a display value when in PV limit or SP deviation. -19999 to 30000 (Set a value within the input range.) Decimal point position depends on the input type.
D5715	PCL_L1	PV color change low limit	Set a display value when in PV limit or SP deviation. -19999 to 30000 (Set a value within the input range.) Decimal point position depends on the input type.
D5716 to D5718			

*1: Same parameter exists in other menu. "-K" is added to the end of the parameter in KEY menu.

Register No.	Description		Range and meaning of value
D5719	BAR1	Bar-graph display registration	0: Disable 1: OUT, Heating-side OUT, Internal value in Position proportional control 2: Cooling-side OUT 3: PV 4: SP 5: Deviation 6 to 16: Disable 17: Feedback input (valve opening) 18: PV terminals analog input 19 to 22: Disable 23: Time event and alarm status
D5720			
D5721	BDV_L1	Bar-graph deviation display band	0.0 to 100.0% of PV input range span (EUS)
D5722			
D5723	EV1_L1	EV1 display condition registration	Setting range: 4001 to 6304 OFF: Disable 4321: Link to alarm 1 (Lit when the alarm occurs) 4322: Link to alarm 2 (Lit when the alarm occurs) 4323: Link to alarm 3 (Lit when the alarm occurs) 4325: Link to alarm 4 (Lit when the alarm occurs)
D5724	EV2_L1	EV2 display condition registration	4529: Heater break alarm 1 (Lit when the alarm occurs) 4530: Heater break alarm 2 (Lit when the alarm occurs) 5025 to 5026: Link to DI1-DI2 (Lit when the contact is closed)* 5041 to 5045: Link to DI11-DI15 (E1-terminal area) (Lit when the contact is closed)* 5089 to 5093: Link to DI41-DI45 (E4-terminal area) (Lit when the contact is closed)*
D5725	EV3_L1	EV3 display condition registration	5153 to 5155: Link to AL1-AL3 (Lit when the contact is closed)* 5169 to 5173: Link to DO11-DO15 (E1-terminal area) (Lit when the contact is closed)* 5217 to 5221: Link to DO41-DO45 (E4-terminal area) (Lit when the contact is closed)* *: Initial value. The contact action changes by the setting of each "contact type" parameter.
D5726	EV4_L1	EV4 display condition registration	4785: Link to PV event 1/local event-1 (Lit when occurs) ** 4786: Link to PV event 2/local event-2 (Lit when occurs) ** 4817: Link to time event 1 (Lit when occurs) ** 4818: Link to time event 2 (Lit when occurs) ** 4819: Link to time event 3 (Lit when occurs) ** 4821: Link to time event 4 (Lit when occurs) ** **: For UP35A only For other functions, see the Chapter 9 Functions and Applications of I Relays (for UT35A/UT32A/UP35A).
D5727 to D5738			
D5739	PV.D	PV display area ON/OFF	
D5740	SP.D	Setpoint display area ON/OFF	0: OFF (Nondisplay) 1: ON (Display)
D5741	STS.D	Status display area ON/OFF	
D5742	SPD	Scroll speed	(Slow) 1 to 8 (Quick)
D5743	GUID	Guide display ON/OFF	0: OFF (Nondisplay) 1: ON (Display)

8.4 UT35A/UT32A/UP35A D Registers

Register No.		Description	Range and meaning of value
D5744	HOME	Home Operation Display setting	0: SP1 (SP Display) 2: OUT1 (OUT Display) 4: HCO (Heating/cooling OUT Display) 5: VP (Valve Position Display) 6: MV (Position Proportional Computation Output Display) 8: PID1 (PID Number Display) 10: HC1 (Heater Break Alarm-1 Current Display) 11: HC2 (Heater Break Alarm-2 Current Display) 14: PV (PV Analog Input Display) 18: CS1 (SELECT Display 1) 19: CS2 (SELECT Display 2) 20: CS3 (SELECT Display 3) 21: CS4 (SELECT Display 4) 22: CS5 (SELECT Display 5) 23: TSP (TSP Display) * 25: R.TIM (Remaining Segment-tim Display) * 26: SEG.N (Segment Number Dispaly) * 27: R.CYC (Remaining Repetition Display) * 28: PTN (Program Pattern Display) * *: For UP35A only
D5745	ECO	Economy mode	0: OFF (Disable) 1: Economy mode ON (All indications except PV display OFF) 2: Economy mode ON (All indications OFF) 3: Brightness 10 % (whole indication)
D5746	BRI	Brightness	(Dark) 1 to 5 (Bright)
D5747	B.PVW	White brightness adjustment of PV display	Adjusts the white brightness of PV display. (Dark) -4 to 4 (Bright)
D5748	B.PVR	Red brightness adjustment of PV display	Adjusts the red brightness of PV display. (Dark) -4 to 4 (Bright)
D5749	B.SP	Brightness adjustment of Setpoint display	Adjusts the brightness of SP display. (Dark) -4 to 4 (Bright)
D5750	B.BAR	Brightness adjustment of Bar-graph display	Adjusts the brightness of SP display. (Dark) -4 to 4 (Bright)
D5751	B.STS	Brightness adjustment of Status indicator	Adjusts the brightness of Status display. (Dark) -4 to 4 (Bright)
D5752	CTRS	Contrast	(Low) 1 to 6 (High)
D5753	D.CYC	Display update cycle	1: 100 ms 2: 200 ms 3: 500 ms 4: 1 s 5: 2 s
D5754	OP.JP	AUTORETURN TO OPERATION DISPLAY	Automatically returned to the Operation Display when there has been no keystroke operation for 5 minutes. 0: OFF (Not automatically returned) 1: ON (Automatically returned)
D5755	MLSD	Least significant digital mask of PV display	0: OFF (With least significant digit) 1: ON (Without least significant digit)
D5756	PTSL	Program display pattern selection	0: PTN (Pattern display) 1: SK.RP (Ramp and soak display)
D5757 to D5760			
D5761	CS1	SELECT Display-1 registration	Register the operation parameter (except the Operation Mode) that is frequently modified to display it in the Operation Display. (Register the register number of the parameter)
D5762	CS2	SELECT Display-2 registration	
D5763	CS3	SELECT Display-3 registration	UT35A/UT32A 0: OFF (No registration) 2301 to 5000
D5764	CS4	SELECT Display-4 registration	
D5765	CS5	SELECT Display-5 registration	UP35A 0: OFF (No registration) 2201 to 5000
D5766 to D5770			

8.4 UT35A/UT32A/UP35A D Registers

Register No.	Description		Range and meaning of value	
D5770	CS10	SELECT parameter-10 registration	Register the parameter that is frequently modified in the Operation Parameter Setting Display. (Register the register number of the parameter)	
D5771	CS11	SELECT parameter-11 registration		
D5772	CS12	SELECT parameter-12 registration		
D5773	CS13	SELECT parameter-13 registration		
D5774	CS14	SELECT parameter-14 registration		
D5775	CS15	SELECT parameter-15 registration		
D5776	CS16	SELECT parameter-16 registration		
D5777	CS17	SELECT parameter-17 registration		
D5778	CS18	SELECT parameter-18 registration		
D5779	CS19	SELECT parameter-19 registration		
D5780 to D5800				UT35A/UT32A 0: OFF (No registration) 2301 to 5000
				UP35A 0: OFF (No registration) 2201 to 5000

8.4 UT35A/UT32A/UP35A D Registers

Lock Setting (Key Lock/Menu Lock) (D5801 to D5900)

Register No.	Description		Range and meaning of value
D5801	U.SP_L1	SP Display lock	0: OFF (Display) 1: ON (Nondisplay)
D5802			
D5803	U.OUT_L1	OUT Display lock	
D5804			
D5805	U.HCO	Heating/cooling OUT Display lock	
D5806	U.VP	Valve Position Display lock	
D5807	U.MV	Position Proportional Computation Output Display lock	
D5808			
D5809	U.PID_L1	PID Number Display lock	
D5810			
D5811	U.HC	Heater Break Alarm Current Value Display lock	
D5812 to D5813			
D5814	U.PV	PV Analog Input Display lock	
D5815 to D5817			
D5818	COM.W	Communication write enable/disable	0: OFF (Enable) 1: ON (Disable)
D5819	DATA-L *1	Front panel parameter data key lock	0: OFF (Unlock) 1: ON (Lock)
D5820	A/M-L *1	Front panel A/M key lock	
D5821	RUN-L *1	Front panel RUN key lock	
D5822	RST-L *1	Front panel RST key lock	
D5823	PTN-L *1	Front panel PTN key lock	
D5824	MODE-L *1	Front panel MODE key lock	
D5825	U.TSP	TSP TSP Display lock	0: OFF (Display) 1: ON (Nondisplay)
D5826	U.TM	Remaining Segment-tim Display lock	
D5827	U.SEG	Segment Number Display lock	
D5828	U.RCY	Remaining Repetition Display lock	
D5829	U.PTN	Program Pattern Display lock	
D5830			
D5831	CTL-L *1	[CTL] menu lock	
D5832	PV-L *1	[PV] menu lock	
D5833 to D5835			
D5836	MPV_L1-L *1	[MPV] menu lock	
D5837			
D5838	OUT-L *1	[OUT] menu lock	
D5839	HBA-L *1	[HBA] menu lock	
D5840	R485_E1-L *1	[R485] menu lock (E1-terminal area)	
D5841	R485_E3-L *1	[R485] menu lock (E3-terminal area)	
D5842			
D5843	ETHR_E3-L *1	[ETHR] menu lock (E3-terminal area)	
D5844	PROF_E3-L *1	[PROF] menu lock (E3-terminal area)	
D5845	DNET_E3-L *1	[DNET] menu lock (E3-terminal area)	
D5846	CC-L_E3-L *1	[CC-L] menu lock (E3-terminal area)	
D5847	KEY-L *1	[KEY] menu lock	
D5848	DISP-L *1	[DISP] menu lock	
D5849	CSEL-L *1	[CSEL] menu lock	
D5850	KLOC-L *1	[KLOC] menu lock	
D5851	DI.SL-L *1	[DI.SL] menu lock	
D5852	DI.NU-L *1	[DI.NU] menu lock	
D5853	DI.D *1	[DI.D] menu lock	
D5854	DI.D_E1-L *1	[DI.D] menu lock (E1-terminal area)	
D5855 to D5856			

*1: Same parameter exists in other menu. "-L" is added to the end of the parameter in KLOC menu or MLOC menu.

Register No.	Description		Range and meaning of value	
D5857	DI_D_E4-L *1	[DI.D] menu lock (E4-terminal area)	0: OFF (Display) 1: ON (Nondisplay)	
D5858	ALM-L *1	[ALM] menu lock		
D5859	DO_E1-L *1	[DO] menu lock (E1-terminal area)		
D5860 to D5861				
D5862	DO_E4-L *1	[DO] menu lock (E4-terminal area)	0: OFF (Display) 1: ON (Nondisplay)	
D5863	I/O-L *1	[I/O] menu lock		
D5864	SYS-L *1	[SYS] menu lock		
D5865	INIT-L *1	[INIT] menu lock		
D5866	VER-L *1	[VER] menu lock		
D5867	LVL-L *1	[LVL] menu lock		
D5868	MODE-L *1	[MODE] menu lock		
D5869	CS-L *1	[CS] menu lock		
D5870	SP_L1-L *1	[SP] menu lock		
D5871	SPS_L1-L *1	[SPS] menu lock		
D5872	ALRM_L1-L *1	[ALRM] menu lock		
D5873	PROG-L	[PROG] menu lock		
D5874	PVS_L1-L *1	[PVS] menu lock		
D5875	PID_L1-L *1	[PID] menu lock		
D5876	TUNE_L1-L *1	[TUNE] menu lock		
D5877	ZONE_L1-L *1	[ZONE] menu lock		
D5878 to D5884				
D5885	PPAR-L *1	[PPAR] menu lock		
D5886 to D5889				
D5890	LOC-L *1	[LOC] menu lock		
D5891	EDIT-L *1	[EDIT] menu lock		
D5892	AL_L1-L *1	[AL] menu lock		
D5893 to D5900				

*1: Same parameter exists in other menu. "-L" is added to the end of the parameter in KLOC menu or MLOC menu.

8.4 UT35A/UT32A/UP35A D Registers

DI Function Setting (D5901 to D6200)

Register No.	Description		Range and meaning of value
D5901	A/M-D *1	AUTO/MAN switch	Set an I relay number of contact input. 0: OFF (Disable) Standard terminals DI1: 5025, DI2: 5026 E1-terminal area DI11: 5041, DI12: 5042, DI13: 5043, DI14: 5044, DI15: 5045 E4-terminal area DI41: 5089, DI42: 5090, DI43: 5091, DI44: 5092, DI45: 5093
D5902	R/L_L1-D *1	REMOTE/LOCAL switch	
D5903			
D5904	S/R-D *1	STOP/RUN switch	
D5905			
D5906	AUTO-D *1	Switch to AUTO	
D5907	MAN-D *1	Switch to MAN	
D5908	REM_L1-D *1	Switch to REMOTE	
D5909	LCL_L1-D *1	Switch to LOCAL	
D5910 to D5911			
D5912	ADV-D *1	Advance of segment	
D5913	HOLD-D *1	Switch to HOLD (Start of hold-mode operation)	
D5914	AT-D *1	Auto-tuning START/STOP switch	
D5915 to D5919			
D5920	LAT-D *1	Latch release	
D5921	LCD-D *1	LCD backlight ON/OFF switch	
D5922	MG1-D *1	Message display interruption 1	
D5923	MG2-D *1	Message display interruption 2	
D5924	MG3-D *1	Message display interruption 3	
D5925	MG4-D *1	Message display interruption 4	
D5926	PRG-D *1	Switch to PROG (Start of program operation)	
D5927	RST-D *1	Switch to RESET (Stop of program operation)	
D5928	LOC-D *1	Switch to LOCAL (LSP) (Start of local-mode operation)	
D5929			
D5930	P/R-D *1	PROG/RESET switch	
D5931	P/L-D *1	PROG/LOCAL (LSP) switch	
D5932	WAIT-D *1	Wait ON/OFF switch	
D5933	A/M_L1-D *1	AUTO/MAN switch	
D5934 to D5935			
D5936	P/H-D *1	PROG/HOLD switch	
D5937	PVRW_L1-D *1	PV red/white switch	
D5938			
D5939	S.HLD-D *1	Switch to HOLD for synchronized program operation	
D5940 to D5940			
D5941	SP.BC	Bit changing method of SP number	0: Status switch 1 (Operation by key keystrokes or via communication is enabled according to the conditions.) 1: Status switch 2 (Operation by key keystrokes or via communication is disabled.)
D5942	SP.B0	Bit-0 of SP number	Set an I relay number of contact input. 0: OFF (Disable) Standard terminals DI1: 5025, DI2: 5026
D5943	SP.B1	Bit-1 of SP number	E1-terminal area DI11: 5041, DI12: 5042, DI13: 5043, DI14: 5044, DI15: 5045
D5944	SP.B2	Bit-2 of SP number	E4-terminal area DI41: 5089, DI42: 5090, DI43: 5091, DI44: 5092, DI45: 5093
D5945 to D5946			

*1: Same parameter exists in other menu. "-D" is added to the end of the parameter in DI.SL menu.

8.4 UT35A/UT32A/UP35A D Registers

Register No.	Description		Range and meaning of value
D5947	PN.BC	Bit changing method of PID number	Same as D5941
D5948	PN.B0	Bit-0 of PID number	Same as D5942
D5949	PN.B1	Bit-1 of PID number	
D5950	PN.B2	Bit-2 of PID number	
D5951 to D5952			
D5953	PT.BC-D *1	Bit changing method of program pattern number	Same as D5941
D5954	PT.B0-D *1	Bit-0 of program pattern number	Same as D5942
D5955	PT.B1-D *1	Bit-1 of program pattern number	
D5956	PT.B2-D *1	Bit-2 of program pattern number	
D5957 to D5959			
D5960	MP.BC_L1	Bit changing method of manual preset output number	Same as D5941
D5961	MP.B0_L1	Bit-0 of manual preset output number	Same as D5942
D5962	MP.B1_L1	Bit-1 of manual preset output number	
D5963	MP.B2_L1	Bit-2 of manual preset output number	
D5964 to D6000			
D6001	MSG1	Messege-1 *2	20-digit value of alphanumeric characters can be set. Arrangement: D6001, D6002, D6003, D6004, D6005, D6006, D6007, DD6008, D6009, D6010, D6011 Write "0x00" to the register after the character string.
D6002	MSG1		
D6003	MSG1		
D6004	MSG1		
D6005	MSG1		
D6006	MSG1		
D6007	MSG1		
D6008	MSG1		
D6009	MSG1		
D6010	MSG1		
D6011	MSG1		
D6012 to D6020			
D6021	MSG2	Messege-2 *2	20-digit value of alphanumeric characters can be set. Arrangement: D6021, D6022, D6023, D6024, D6025, D6026, D6027, D6028, D6029, D6030, D6031 Write "0x00" to the register after the character string.
D6022	MSG2		
D6023	MSG2		
D6024	MSG2		
D6025	MSG2		
D6026	MSG2		
D6027	MSG2		
D6028	MSG2		
D6029	MSG2		
D6030	MSG2		
D6031	MSG2		
D6032 to D6040			

*1: Same parameter exists in other menu. "-D" is added to the end of the parameter in DI.SL menu.

*2: With regards to the information on D6001 to D6011, D6021 to D6031, D6041 to D6051, and D6061 to D6071, 11 D registers comprise one message.

8.4 UT35A/UT32A/UP35A D Registers

Register No.	Description		Range and meaning of value
D6041	MSG3	Message-3 *2	20-digit value of alphanumeric characters can be set. Arrangement: D6041, D6042, D6043, D6044, D6045, D6046, D6047, D6048, D6049, D6050, D6051 Write "0x00" to the register after the character string.
D6042	MSG3		
D6043	MSG3		
D6044	MSG3		
D6045	MSG3		
D6046	MSG3		
D6047	MSG3		
D6048	MSG3		
D6049	MSG3		
D6050	MSG3		
D6051	MSG3		
D6052 to D6060			
D6061	MSG4	Message-4 *2	20-digit value of alphanumeric characters can be set. Arrangement: D6061, D6062, D6063, D6064, D6065, D6066, D6067, D6068, D6069, D6070, D6071 Write "0x00" to the register after the character string.
D6062	MSG4		
D6063	MSG4		
D6064	MSG4		
D6065	MSG4		
D6066	MSG4		
D6067	MSG4		
D6068	MSG4		
D6069	MSG4		
D6070	MSG4		
D6071	MSG4		
D6072 to D6100			
D6101	DI1.D	DI1 contact type	0: The assigned function is enabled when the contact is closed. 1: The assigned function is enabled when the contact is opened.
D6102	DI2.D	DI2 contact type	
D6103	DI3.D	DI3 contact type	
D6104 to D6120			
D6121	DI1.D_E1	DI11 contact type	0: The assigned function is enabled when the contact is closed. 1: The assigned function is enabled when the contact is opened.
D6122	DI2.D_E1	DI12 contact type	
D6123	DI3.D_E1	DI13 contact type	
D6124	DI4.D_E1	DI14 contact type	
D6125	DI5.D_E1	DI15 contact type	
D6126 to D6180			
D6181	DI1.D_E4	DI41 contact type	0: The assigned function is enabled when the contact is closed. 1: The assigned function is enabled when the contact is opened.
D6182	DI2.D_E4	DI42 contact type	
D6183	DI3.D_E4	DI43 contact type	
D6184	DI4.D_E4	DI44 contact type	
D6185	DI5.D_E4	DI45 contact type	
D6186 to D6200			

*2: With regards to the information on D6001 to D6011, D6021 to D6031, D6041 to D6051, and D6061 to D6071, 11 D registers comprise one message.

8.4 UT35A/UT32A/UP35A D Registers

Register No.		Description	Range and meaning of value
D6201	AL1.S	AL1 function selection	Set an I relay number (Setting range: 4001 to 6000, UP35A: 4001 to 6304). Ex.) Set the number 4353 for AL1.S to use the alarm 1. 0: OFF (No function)
D6202	AL2.S	AL2 function selection	UT35A/UT32A Alarm 1: 4353 Alarm 2: 4354
D6203	AL3.S	AL3 function selection	Alarm 3: 4355 Alarm 4: 4357 AUTO (ON) / MAN (OFF) status: 4193 REM (ON) / LCL (OFF) status: 4194 STOP (ON) / RUN (OFF) status: 4195
D6204	OR.S	OUT relay function selection	
D6205	OR2.S	OUT2 relay function selection	UP35A 0: OFF (No function) PV event-1: 4801 PV event-2: 4802, Time event 1: 4817, Time event 2: 4818, Time event 3: 4819, Time event 4: 4821, Alarm 1: 4353, Alarm 2: 4354, AUTO (ON) / MAN (OFF) status: 4177, Program RESET status: 4181, Program RUN status: 4182, Local operation status: 4183, HOLD mode status: 4189, Program advance status: 4187, Pattern end signal (1 second): 4265, Pattern end signal (3 seconds): 4266, Pattern end signal (5 seconds): 4267, Wait end signal (1 second) : 4257, Wait end signal (3 seconds) : 4258, Wait end signal (5 seconds) : 4259, For the items other than below, see the Chapter 9 Functions and Applications of I Relays (for UT35A/UT32A/UP35A).
D6206	AL1.D	AL1 contact type	0: When the event of assigned function occurs, the contact is closed. 1: When the event of assigned function occurs, the contact is opened.
D6207	AL2.D	AL2 contact type	
D6208	AL3.D	AL3 contact type	
D6209	OR.D	OUT relay contact type	Same as D6206
D6210	OR2.D	OUT2 relay contact type	
D6211 to D6220			
D6221	DO1.S_E1	DO11 function selection	Same as D6201
D6222	DO2.S_E1	DO12 function selection	
D6223	DO3.S_E1	DO13 function selection	
D6224	DO4.S_E1	DO14 function selection	
D6225	DO5.S_E1	DO15 function selection	
D6226	DO1.D_E1	DO11 contact type	Same as D6206
D6227	DO2.D_E1	DO12 contact type	
D6228	DO3.D_E1	DO13 contact type	
D6229	DO4.D_E1	DO14 contact type	
D6230	DO5.D_E1	DO15 contact type	
D6231 to D6280			
D6281	DO1.S_E4	DO41 function selection	Same as D6201
D6282	DO2.S_E4	DO42 function selection	
D6283	DO3.S_E4	DO43 function selection	
D6284	DO4.S_E4	DO44 function selection	
D6285	DO5.S_E4	DO45 function selection	

8.4 UT35A/UT32A/UP35A D Registers

Register No.	Description		Range and meaning of value
D6286	DO1.D_E4	DO41 contact type	Same as D6206
D6287	DO2.D_E4	DO42 contact type	
D6288	DO3.D_E4	DO43 contact type	
D6289	DO4.D_E4	DO44 contact type	
D6290	DO5.D_E4	DO45 contact type	
D6291 to D6300			

I/O Display (D6301 to D6400)

● Bit Configuration of D6301: KEY-IO*1 (Key status)

Bit	Symbol	Event
0	PARA_KEY	PARAMETER (PARA) key (0: OFF 1: ON)
1	DISP_KEY	DISPLAY (DISP) key (0: OFF 1: ON)
2	RIGHT_KEY	RIGHT key (0: OFF 1: ON)
3	DOWN_KEY	DOWN key (0: OFF 1: ON)
4	SET_KEY	SET/ENTER key (0: OFF 1: ON)
5	UP_KEY	UP key (0: OFF 1: ON)
6	LEFT_KEY	LEFT key (0: OFF 1: ON)
7 *2	F2_KEY	F2 key (0: OFF 1: ON)
8 *2	F1_KEY	F1 key (0: OFF 1: ON)
9 *3	A/M_KEY	A/M key (0: OFF 1: ON)
10 *3	FN_KEY	Fn key (0: OFF 1: ON)
11 *4	PTN_KEY	PNT key (0: OFF 1: ON)
12 *4	RST_KEY	RST key (0: OFF 1: ON)
13 *4	MODE_KEY	MODE key (0: OFF 1: ON)
14 *4	RUN_KEY	RUN key (0: OFF 1: ON)
15		

*1: Same parameter exists in other menu. "-IO" is added to the end of the parameter in I/O menu.

*2: For UT35A only

*3: For UT35A/UT32A only

*4: For UP35A only

● D6302 to D6400

Register No.	Description	Range and meaning of value
D6302 to D6400	Free area	

8.4 UT35A/UT32A/UP35A D Registers

System Setting (D6401 to D6500)

Register No.		Description	Range and meaning of value
D6401	R.MD	Restart mode	Set how the controller should recover from a power failure of 5 seconds or more. UT35A/UT32A 0: CONT (Continue action set before power failure.) 1: MAN (Start from MAN.) 2: AUTO (Start from AUTO.) UP35A 0: CONT (Continue action set before power failure.) 1: MAN (Start from MAN.) 2: RESET (Start from AUTO and RESET. The preset output value is outputted.)
D6402	R.TM	Restart timer	Set time between power on and the instant where controller starts computation. 0 to 10 s
D6403 to D6407			
D6408	EPO	Input error preset output	Set preset output value when the input burnout or ADC error occurs. Manual output is prioritized when input burnout occurs in MAN. 0: Preset output 1: 0% output 2: 100% output
D6409	C.GRN	Response as GREEN Series	0: OFF (Works as UT35A/UT32A/UP35A in communication of device information response or broadcasting.) 1: ON (Works as GREEN Series in communication of device information response or broadcasting.)
D6410	FREQ	Power frequency	0: AUTO 1: 60 Hz 2: 50 Hz
D6411 to D6416			
D6417	QSM	Quick setting mode	0: OFF (Disable) 1: ON (Enable)
D6418	LANG	Guide display language	0: ENG (English) 1: FRA (French) 2: GER (German) 3: SPA (Spanish)
D6419 to D6420			
D6421	U.DEF	Initialization to user default value	12345: Initialization, automatically returned to "0" after initialization.
D6422			
D6423	F.DEF	Initialization to factory default value	-12345: Initialization, automatically returned to "0" after initialization. *
D6424			
D6425	P.DEF	Clearing all program pattern data	13579: Initialization, automatically returned to "0" after initialization. * Data all deletions in menu [PROG]
D6426 to D6430			
D6431	LEVL	Parameter display level	1: EASY (Easy setting mode) 2: STD (Standard setting mode) 3: PRO (Professional setting mode)
D6432 to D6500			

*: UP35A does not respond for the initialization command via Ethernet communication.

Free Area (D6501 to D7000)

Register No.	Description	Range and meaning of value
D6501 to D7000	Free area	

8.4.6 Registers for Ladder Program (D7001 to D7600)

Registers for ladder program													
For input ladder calculation													
D-Reg No.	Ref. No.	H No.	Register symbol	R/W			D-Reg No.	Ref. No.	H No.	Register symbol	R/W		
				UT 35A	UT 32A	UP 35A					UT 35A	UT 32A	UP 35A
D7001	47001	1B58	X_PV	R	R	R	D7051	47051	1B8A	PVIN_CTL	R *	R *	R *
D7002	47002	1B59					D7052	47052	1B8B				
D7003	47003	1B5A					D7053	47053	1B8C				
D7004	47004	1B5B					D7054	47054	1B8D				
D7005	47005	1B5C					D7055	47055	1B8E				
D7006	47006	1B5D					D7056	47056	1B8F				
D7007	47007	1B5E					D7057	47057	1B90	TRK_CTL	R *	R *	R *
D7008	47008	1B5F					D7058	47058	1B91				
D7009	47009	1B60					D7059	47059	1B92				
D7010	47010	1B61					D7060	47060	1B93				
D7011	47011	1B62	X000	R	R	R	D7061	47061	1B94				
D7012	47012	1B63	X100_E1	R	R	R	D7062	47062	1B95				
D7013	47013	1B64					D7063	47063	1B96				
D7014	47014	1B65					D7064	47064	1B97				
D7015	47015	1B66	X400_E4	R		R	D7065	47065	1B98				
D7016	47016	1B67					D7066	47066	1B99				
D7017	47017	1B68					D7067	47067	1B9A				
D7018	47018	1B69					D7068	47068	1B9B				
D7019	47019	1B6A					D7069	47069	1B9C				
D7020	47020	1B6B					D7070	47070	1B9D				
D7021	47021	1B6C					D7071	47071	1B9E				
D7022	47022	1B6D					D7072	47072	1B9F				
D7023	47023	1B6E					D7073	47073	1BA0				
D7024	47024	1B6F					D7074	47074	1BA1				
D7025	47025	1B70					D7075	47075	1BA2				
D7026	47026	1B71					D7076	47076	1BA3				
D7027	47027	1B72					D7077	47077	1BA4				
D7028	47028	1B73					D7078	47078	1BA5				
D7029	47029	1B74					D7079	47079	1BA6				
D7030	47030	1B75					D7080	47080	1BA7				
D7031	47031	1B76					D7081	47081	1BA8				
D7032	47032	1B77					D7082	47082	1BA9				
D7033	47033	1B78					D7083	47083	1BAA				
D7034	47034	1B79					D7084	47084	1BAB				
D7035	47035	1B7A					D7085	47085	1BAC				
D7036	47036	1B7B					D7086	47086	1BAD				
D7037	47037	1B7C					D7087	47087	1BAE				
D7038	47038	1B7D					D7088	47088	1BAF				
D7039	47039	1B7E					D7089	47089	1BB0				
D7040	47040	1B7F					D7090	47090	1BB1				
D7041	47041	1B80					D7091	47091	1BB2				
D7042	47042	1B81					D7092	47092	1BB3				
D7043	47043	1B82					D7093	47093	1BB4				
D7044	47044	1B83					D7094	47094	1BB5				
D7045	47045	1B84					D7095	47095	1BB6				
D7046	47046	1B85					D7096	47096	1BB7				
D7047	47047	1B86					D7097	47097	1BB8				
D7048	47048	1B87					D7098	47098	1BB9				
D7049	47049	1B88					D7099	47099	1BBA				
D7050	47050	1B89					D7100	47100	1BBB				

*: R/W when the LL50A Parameter Setting Software is used.

8.4 UT35A/UT32A/UP35A D Registers

Registers for ladder program													
For output ladder calculation													
D-Reg No.	Ref. No.	H No.	Register symbol	R/W			D-Reg No.	Ref. No.	H No.	Register symbol	R/W		
				UT 35A	UT 32A	UP 35A					UT 35A	UT 32A	UP 35A
D7101	47101	1BBC	OUT_CTL	R	R	R	D7151	47151	1BEE	Y_OUT	R *	R *	R *
D7102	47102	1BBD					D7152	47152	1BEF				
D7103	47103	1BBE	RET_CTL	R	R	R	D7153	47153	1BF0	Y_RET	R *	R *	R *
D7104	47104	1BBF	OUT2R_CTL	R	R	R	D7154	47154	1BF1	Y_OUT2R	R *	R *	R *
D7105	47105	1BC0	OUTR_CTL	R	R	R	D7155	47155	1BF2	Y_OUTR	R *	R *	R *
D7106	47106	1BC1					D7156	47156	1BF3				
D7107	47107	1BC2					D7157	47157	1BF4				
D7108	47108	1BC3					D7158	47158	1BF5				
D7109	47109	1BC4					D7159	47159	1BF6				
D7110	47110	1BC5					D7160	47160	1BF7				
D7111	47111	1BC6	DOAL	R	R	R	D7161	47161	1BF8	Y000	R *	R *	R *
D7112	47112	1BC7	DO10_E1	R	R	R	D7162	47162	1BF9	Y100_E1	R *	R *	R *
D7113	47113	1BC8					D7163	47163	1BFA				
D7114	47114	1BC9					D7164	47164	1BFB				
D7115	47115	1BCA	DO40_E4	R		R	D7165	47165	1BFC	Y400_E4	R *		R *
D7116	47116	1BCB					D7166	47166	1BFD				
D7117	47117	1BCC					D7167	47167	1BFE				
D7118	47118	1BCD					D7168	47168	1BFF				
D7119	47119	1BCE					D7169	47169	1C00				
D7120	47120	1BCF					D7170	47170	1C01				
D7121	47121	1BD0					D7171	47171	1C02				
D7122	47122	1BD1					D7172	47172	1C03				
D7123	47123	1BD2					D7173	47173	1C04				
D7124	47124	1BD3					D7174	47174	1C05				
D7125	47125	1BD4					D7175	47175	1C06				
D7126	47126	1BD5					D7176	47176	1C07				
D7127	47127	1BD6					D7177	47177	1C08				
D7128	47128	1BD7					D7178	47178	1C09				
D7129	47129	1BD8					D7179	47179	1C0A				
D7130	47130	1BD9					D7180	47180	1C0B				
D7131	47131	1BDA					D7181	47181	1C0C				
D7132	47132	1BDB					D7182	47182	1C0D				
D7133	47133	1BDC					D7183	47183	1C0E				
D7134	47134	1BDD					D7184	47184	1C0F				
D7135	47135	1BDE					D7185	47185	1C10				
D7136	47136	1BDF					D7186	47186	1C11				
D7137	47137	1BE0					D7187	47187	1C12				
D7138	47138	1BE1					D7188	47188	1C13				
D7139	47139	1BE2					D7189	47189	1C14				
D7140	47140	1BE3					D7190	47190	1C15				
D7141	47141	1BE4					D7191	47191	1C16				
D7142	47142	1BE5					D7192	47192	1C17				
D7143	47143	1BE6					D7193	47193	1C18				
D7144	47144	1BE7					D7194	47194	1C19				
D7145	47145	1BE8					D7195	47195	1C1A				
D7146	47146	1BE9					D7196	47196	1C1B				
D7147	47147	1BEA					D7197	47197	1C1C				
D7148	47148	1BEB					D7198	47198	1C1D				
D7149	47149	1BEC					D7199	47199	1C1E				
D7150	47150	1BED					D7200	47200	1C1F				

*: R/W when the LL50A Parameter Setting Software is used.

Registers for ladder program													
Status register													
D-Reg No.	Ref. No.	H No.	Register symbol	R/W			D-Reg No.	Ref. No.	H No.	Register symbol	R/W		
				UT 35A	UT 32A	UP 35A					UT 35A	UT 32A	UP 35A
D7201	47201	1C20	M1_16	R/W	R/W	R/W	D7251	47251	1C52				
D7202	47202	1C21	M17_32	R/W	R/W	R/W	D7252	47252	1C53				
D7203	47203	1C22	M33_48	R/W	R/W	R/W	D7253	47253	1C54				
D7204	47204	1C23	M49_64	R/W	R/W	R/W	D7254	47254	1C55				
D7205	47205	1C24	M65_80	R/W	R/W	R/W	D7255	47255	1C56				
D7206	47206	1C25	M81_96	R/W	R/W	R/W	D7256	47256	1C57				
D7207	47207	1C26	M97_112	R/W	R/W	R/W	D7257	47257	1C58				
D7208	47208	1C27	M113_128	R/W	R/W	R/W	D7258	47258	1C59				
D7209	47209	1C28					D7259	47259	1C5A				
D7210	47210	1C29					D7260	47260	1C5B				
D7211	47211	1C2A	M1_16_B	R/W	R/W	R/W	D7261	47261	1C5C				
D7212	47212	1C2B	M17_32_B	R/W	R/W	R/W	D7262	47262	1C5D				
D7213	47213	1C2C	M33_48_B	R/W	R/W	R/W	D7263	47263	1C5E				
D7214	47214	1C2D	M49_64_B	R/W	R/W	R/W	D7264	47264	1C5F				
D7215	47215	1C2E	M65_80_B	R/W	R/W	R/W	D7265	47265	1C60				
D7216	47216	1C2F	M81_96_B	R/W	R/W	R/W	D7266	47266	1C61				
D7217	47217	1C30	M97_112_B	R/W	R/W	R/W	D7267	47267	1C62				
D7218	47218	1C31	M113_128_B	R/W	R/W	R/W	D7268	47268	1C63				
D7219	47219	1C32					D7269	47269	1C64				
D7220	47220	1C33					D7270	47270	1C65				
D7221	47221	1C34	TIM_RELAY	R	R	R	D7271	47271	1C66				
D7222	47222	1C35	CNT_RELAY	R	R	R	D7272	47272	1C67				
D7223	47223	1C36					D7273	47273	1C68				
D7224	47224	1C37					D7274	47274	1C69				
D7225	47225	1C38					D7275	47275	1C6A				
D7226	47226	1C39					D7276	47276	1C6B				
D7227	47227	1C3A					D7277	47277	1C6C				
D7228	47228	1C3B					D7278	47278	1C6D				
D7229	47229	1C3C					D7279	47279	1C6E				
D7230	47230	1C3D					D7280	47280	1C6F				
D7231	47231	1C3E					D7281	47281	1C70				
D7232	47232	1C3F					D7282	47282	1C71				
D7233	47233	1C40					D7283	47283	1C72				
D7234	47234	1C41					D7284	47284	1C73				
D7235	47235	1C42					D7285	47285	1C74				
D7236	47236	1C43					D7286	47286	1C75				
D7237	47237	1C44					D7287	47287	1C76				
D7238	47238	1C45					D7288	47288	1C77				
D7239	47239	1C46					D7289	47289	1C78				
D7240	47240	1C47					D7290	47290	1C79				
D7241	47241	1C48					D7291	47291	1C7A				
D7242	47242	1C49					D7292	47292	1C7B				
D7243	47243	1C4A					D7293	47293	1C7C				
D7244	47244	1C4B					D7294	47294	1C7D				
D7245	47245	1C4C					D7295	47295	1C7E				
D7246	47246	1C4D					D7296	47296	1C7F				
D7247	47247	1C4E					D7297	47297	1C80				
D7248	47248	1C4F					D7298	47298	1C81				
D7249	47249	1C50					D7299	47299	1C82				
D7250	47250	1C51					D7300	47300	1C83				

8.4 UT35A/UT32A/UP35A D Registers

Registers for ladder program													
Constant register													
D-Reg No.	Ref. No.	H No.	Register symbol	R/W			D-Reg No.	Ref. No.	H No.	Register symbol	R/W		
				UT 35A	UT 32A	UP 35A					UT 35A	UT 32A	UP 35A
D7301	47301	1C84	K01	R/W	R/W	R/W	D7351	47351	1CB6				
D7302	47302	1C85	K02	R/W	R/W	R/W	D7352	47352	1CB7				
D7303	47303	1C86	K03	R/W	R/W	R/W	D7353	47353	1CB8				
D7304	47304	1C87	K04	R/W	R/W	R/W	D7354	47354	1CB9				
D7305	47305	1C88	K05	R/W	R/W	R/W	D7355	47355	1CBA				
D7306	47306	1C89	K06	R/W	R/W	R/W	D7356	47356	1CBB				
D7307	47307	1C8A	K07	R/W	R/W	R/W	D7357	47357	1CBC				
D7308	47308	1C8B	K08	R/W	R/W	R/W	D7358	47358	1CBD				
D7309	47309	1C8C	K09	R/W	R/W	R/W	D7359	47359	1CBE				
D7310	47310	1C8D	K10	R/W	R/W	R/W	D7360	47360	1CBF				
D7311	47311	1C8E	K11	R/W	R/W	R/W	D7361	47361	1CC0				
D7312	47312	1C8F	K12	R/W	R/W	R/W	D7362	47362	1CC1				
D7313	47313	1C90	K13	R/W	R/W	R/W	D7363	47363	1CC2				
D7314	47314	1C91	K14	R/W	R/W	R/W	D7364	47364	1CC3				
D7315	47315	1C92	K15	R/W	R/W	R/W	D7365	47365	1CC4				
D7316	47316	1C93	K16	R/W	R/W	R/W	D7366	47366	1CC5				
D7317	47317	1C94	K17	R/W	R/W	R/W	D7367	47367	1CC6				
D7318	47318	1C95	K18	R/W	R/W	R/W	D7368	47368	1CC7				
D7319	47319	1C96	K19	R/W	R/W	R/W	D7369	47369	1CC8				
D7320	47320	1C97	K20	R/W	R/W	R/W	D7370	47370	1CC9				
D7321	47321	1C98	K21	R/W	R/W	R/W	D7371	47371	1CCA				
D7322	47322	1C99	K22	R/W	R/W	R/W	D7372	47372	1CCB				
D7323	47323	1C9A	K23	R/W	R/W	R/W	D7373	47373	1CCC				
D7324	47324	1C9B	K24	R/W	R/W	R/W	D7374	47374	1CCD				
D7325	47325	1C9C	K25	R/W	R/W	R/W	D7375	47375	1CCE				
D7326	47326	1C9D	K26	R/W	R/W	R/W	D7376	47376	1CCF				
D7327	47327	1C9E	K27	R/W	R/W	R/W	D7377	47377	1CD0				
D7328	47328	1C9F	K28	R/W	R/W	R/W	D7378	47378	1CD1				
D7329	47329	1CA0	K29	R/W	R/W	R/W	D7379	47379	1CD2				
D7330	47330	1CA1	K30	R/W	R/W	R/W	D7380	47380	1CD3				
D7331	47331	1CA2					D7381	47381	1CD4				
D7332	47332	1CA3					D7382	47382	1CD5				
D7333	47333	1CA4					D7383	47383	1CD6				
D7334	47334	1CA5					D7384	47384	1CD7				
D7335	47335	1CA6					D7385	47385	1CD8				
D7336	47336	1CA7					D7386	47386	1CD9				
D7337	47337	1CA8					D7387	47387	1CDA				
D7338	47338	1CA9					D7388	47388	1CDB				
D7339	47339	1CAA					D7389	47389	1CDC				
D7340	47340	1CAB					D7390	47390	1CDD				
D7341	47341	1CAC					D7391	47391	1CDE				
D7342	47342	1CAD					D7392	47392	1CDF				
D7343	47343	1CAE					D7393	47393	1CE0				
D7344	47344	1CAF					D7394	47394	1CE1				
D7345	47345	1CB0					D7395	47395	1CE2				
D7346	47346	1CB1					D7396	47396	1CE3				
D7347	47347	1CB2					D7397	47397	1CE4				
D7348	47348	1CB3					D7398	47398	1CE5				
D7349	47349	1CB4					D7399	47399	1CE6				
D7350	47350	1CB5					D7400	47400	1CE7				

Registers for ladder program													
Constant register													
D-Reg No.	Ref. No.	H No.	Register symbol	R/W			D-Reg No.	Ref. No.	H No.	Register symbol	R/W		
				UT 35A	UT 32A	UP 35A					UT 35A	UT 32A	UP 35A
D7401	47401	1CE8					D7451	47451	1D1A				
D7402	47402	1CE9					D7452	47452	1D1B				
D7403	47403	1CEA					D7453	47453	1D1C				
D7404	47404	1CEB					D7454	47454	1D1D				
D7405	47405	1CEC					D7455	47455	1D1E				
D7406	47406	1CED					D7456	47456	1D1F				
D7407	47407	1CEE					D7457	47457	1D20				
D7408	47408	1CEF					D7458	47458	1D21				
D7409	47409	1CF0					D7459	47459	1D22				
D7410	47410	1CF1	C_1	R	R	R	D7460	47460	1D23				
D7411	47411	1CF2	C0	R	R	R	D7461	47461	1D24				
D7412	47412	1CF3	C1	R	R	R	D7462	47462	1D25				
D7413	47413	1CF4	C2	R	R	R	D7463	47463	1D26				
D7414	47414	1CF5	C3	R	R	R	D7464	47464	1D27				
D7415	47415	1CF6	C5	R	R	R	D7465	47465	1D28				
D7416	47416	1CF7	C10	R	R	R	D7466	47466	1D29				
D7417	47417	1CF8	C50	R	R	R	D7467	47467	1D2A				
D7418	47418	1CF9	C60	R	R	R	D7468	47468	1D2B				
D7419	47419	1CFA	C100	R	R	R	D7469	47469	1D2C				
D7420	47420	1CFB	C1000	R	R	R	D7470	47470	1D2D				
D7421	47421	1CFC	C10000	R	R	R	D7471	47471	1D2E				
D7422	47422	1CFD					D7472	47472	1D2F				
D7423	47423	1CFE					D7473	47473	1D30				
D7424	47424	1CFF					D7474	47474	1D31				
D7425	47425	1D00					D7475	47475	1D32				
D7426	47426	1D01					D7476	47476	1D33				
D7427	47427	1D02					D7477	47477	1D34				
D7428	47428	1D03					D7478	47478	1D35				
D7429	47429	1D04					D7479	47479	1D36				
D7430	47430	1D05					D7480	47480	1D37				
D7431	47431	1D06					D7481	47481	1D38				
D7432	47432	1D07					D7482	47482	1D39				
D7433	47433	1D08					D7483	47483	1D3A				
D7434	47434	1D09					D7484	47484	1D3B				
D7435	47435	1D0A					D7485	47485	1D3C				
D7436	47436	1D0B					D7486	47486	1D3D				
D7437	47437	1D0C					D7487	47487	1D3E				
D7438	47438	1D0D					D7488	47488	1D3F				
D7439	47439	1D0E					D7489	47489	1D40				
D7440	47440	1D0F					D7490	47490	1D41				
D7441	47441	1D10					D7491	47491	1D42				
D7442	47442	1D11					D7492	47492	1D43				
D7443	47443	1D12					D7493	47493	1D44				
D7444	47444	1D13					D7494	47494	1D45				
D7445	47445	1D14					D7495	47495	1D46				
D7446	47446	1D15					D7496	47496	1D47				
D7447	47447	1D16					D7497	47497	1D48				
D7448	47448	1D17					D7498	47498	1D49				
D7449	47449	1D18					D7499	47499	1D4A				
D7450	47450	1D19					D7500	47500	1D4B				

8.4 UT35A/UT32A/UP35A D Registers

Registers for ladder program													
Input range / scale													
D-Reg No.	Ref. No.	H No.	Register symbol	R/W			D-Reg No.	Ref. No.	H No.	Register symbol	R/W		
				UT 35A	UT 32A	UP 35A					UT 35A	UT 32A	UP 35A
D7501	47501	1D4C	DP_R	R	R	R	D7551	47551	1D7E				
D7502	47502	1D4D	RH_R	R	R	R	D7552	47552	1D7F				
D7503	47503	1D4E	RL_R	R	R	R	D7553	47553	1D80				
D7504	47504	1D4F					D7554	47554	1D81				
D7505	47505	1D50	SDP_R	R	R	R	D7555	47555	1D82				
D7506	47506	1D51	SH_R	R	R	R	D7556	47556	1D83				
D7507	47507	1D52	SL_R	R	R	R	D7557	47557	1D84				
D7508	47508	1D53					D7558	47558	1D85				
D7509	47509	1D54					D7559	47559	1D86				
D7510	47510	1D55					D7560	47560	1D87				
D7511	47511	1D56					D7561	47561	1D88				
D7512	47512	1D57					D7562	47562	1D89				
D7513	47513	1D58					D7563	47563	1D8A				
D7514	47514	1D59					D7564	47564	1D8B				
D7515	47515	1D5A					D7565	47565	1D8C				
D7516	47516	1D5B					D7566	47566	1D8D				
D7517	47517	1D5C					D7567	47567	1D8E				
D7518	47518	1D5D					D7568	47568	1D8F				
D7519	47519	1D5E					D7569	47569	1D90				
D7520	47520	1D5F					D7570	47570	1D91				
D7521	47521	1D60					D7571	47571	1D92				
D7522	47522	1D61					D7572	47572	1D93				
D7523	47523	1D62					D7573	47573	1D94				
D7524	47524	1D63					D7574	47574	1D95				
D7525	47525	1D64					D7575	47575	1D96				
D7526	47526	1D65					D7576	47576	1D97				
D7527	47527	1D66					D7577	47577	1D98				
D7528	47528	1D67					D7578	47578	1D99				
D7529	47529	1D68					D7579	47579	1D9A				
D7530	47530	1D69					D7580	47580	1D9B				
D7531	47531	1D6A					D7581	47581	1D9C				
D7532	47532	1D6B					D7582	47582	1D9D				
D7533	47533	1D6C	P.DP_L1_R	R	R	R	D7583	47583	1D9E				
D7534	47534	1D6D	P.RH_L1_R	R	R	R	D7584	47584	1D9F				
D7535	47535	1D6E	P.RL_L1_R	R	R	R	D7585	47585	1DA0				
D7536	47536	1D6F					D7586	47586	1DA1				
D7537	47537	1D70					D7587	47587	1DA2				
D7538	47538	1D71					D7588	47588	1DA3				
D7539	47539	1D72					D7589	47589	1DA4				
D7540	47540	1D73					D7590	47590	1DA5				
D7541	47541	1D74					D7591	47591	1DA6				
D7542	47542	1D75					D7592	47592	1DA7				
D7543	47543	1D76					D7593	47593	1DA8				
D7544	47544	1D77					D7594	47594	1DA9				
D7545	47545	1D78					D7595	47595	1DAA				
D7546	47546	1D79					D7596	47596	1DAB				
D7547	47547	1D7A					D7597	47597	1DAC				
D7548	47548	1D7B					D7598	47598	1DAD				
D7549	47549	1D7C					D7599	47599	1DAE				
D7550	47550	1D7D					D7600	47600	1DAF				

For Input Ladder Calculation (D7001 to D7100)

● D7001 to D7010

Register No.	Description		Range and meaning of value
D7001	X_PV	PV analog input	-5.0 to 105.0%
D7002 to D7010			

● Bit Configuration of D7011: X000 (DI1-DI2 status: equipped as standard)

Bit	Symbol	Event	
0	X_DI1	DI1 status	(0: OFF 1: ON)
1	X_DI2	DI2 status	(0: OFF 1: ON)
2	X_DI3 *	DI3 status	(0: OFF 1: ON)
3 to 15			

*: Only for UP35A.

● Bit Configuration of D7012: X100_E1 (DI11-DI15 status: E1-terminal area)

Bit	Symbol	Event	
0	X_DI11	DI11 status	(0: OFF 1: ON)
1	X_DI12	DI12 status	(0: OFF 1: ON)
2	X_DI13	DI13 status	(0: OFF 1: ON)
3	X_DI14	DI14 status	(0: OFF 1: ON)
4	X_DI15	DI15 status	(0: OFF 1: ON)
5 to 15			

● Bit Configuration of D7015: X400_E4 (DI41-DI45 status: E4-terminal area)

Bit	Symbol	Event	
0	X_DI41	DI41 status	(0: OFF 1: ON)
1	X_DI42	DI42 status	(0: OFF 1: ON)
2	X_DI43	DI43 status	(0: OFF 1: ON)
3	X_DI44	DI44 status	(0: OFF 1: ON)
4	X_DI45	DI45 status	(0: OFF 1: ON)
5 to 15			

● D7051 to D7100

Register No.	Description		Range and meaning of value
D7051	PVIN_CTL	Control PV input	-5.0 to 105.0% of PV input range (EU)
D7052 to D7056			
D7057	TRK_CTL	Control tracking input	-5.0 to 105.0% of TRK input range (EU)
D7058 to D7100			

8.4 UT35A/UT32A/UP35A D Registers

For Output Ladder Calculation (D7101 to D7200)

● D7101 to D7110

Register No.	Description		Range and meaning of value
D7101	OUT_CTL	Control OUT output	-5.0 to 105.0% of control OUT output range
D7102			
D7103	RET_CTL	Control RET output	-5.0 to 105.0% of control ERT output range
D7104	OUT2R_CTL	Control OUT2R output (Relay)	-5.0 to 105.0% of control OUT2R output range
D7105	OUTR_CTL	Control OUTR output (Relay)	-5.0 to 105.0% of control OUTR output range
D7106 to D7110			

● Bit Configuration of D7111: DOAL (Control AL1-AL3 status: equipped as standard)

Bit	Symbol	Event	
0	AL1_CTL	Control AL1 status	(0: OFF 1: ON)
1	AL2_CTL	Control AL2 status	(0: OFF 1: ON)
2	AL3_CTL	Control AL3 status	(0: OFF 1: ON)
3 to 15			

● Bit Configuration of D7112: DO10_E1 (Control DO11-DO15 status: E1-terminal area)

Bit	Symbol	Event	
0	DO11_CTL	Control DO11 status	(0: OFF 1: ON)
1	DO12_CTL	Control DO12 status	(0: OFF 1: ON)
2	DO13_CTL	Control DO13 status	(0: OFF 1: ON)
3	DO14_CTL	Control DO14 status	(0: OFF 1: ON)
4	DO15_CTL	Control DO15 status	(0: OFF 1: ON)
5 to 15			

● Bit Configuration of D7115: DO40_E4 (Control DO41-DO45 status: E4-terminal area)

Bit	Symbol	Event	
0	DO41_CTL	Control DO41 status	(0: OFF 1: ON)
1	DO42_CTL	Control DO42 status	(0: OFF 1: ON)
2	DO43_CTL	Control DO43 status	(0: OFF 1: ON)
3	DO44_CTL	Control DO44 status	(0: OFF 1: ON)
4	DO45_CTL	Control DO45 status	(0: OFF 1: ON)
5 to 15			

● D7116 to D7160

Register No.	Description		Range and meaning of value
D7116 to D7150			
D7151	Y_OUT	OUT control output	-5.0 to 105.0%
D7152			
D7153	Y_RET	RET control output	-5.0 to 105.0%
D7154	Y_OUT2R	OUT2R control output	-5.0 to 105.0%
D7155	Y_OUTR	OUTR control output	-5.0 to 105.0%
D7156 to D7160			

● Bit Configuration of D7161: **Y000** (AL1-AL3 status: equipped as standard)

Bit	Symbol	Event	
0	Y_AL1	AL1 status	(0: OFF 1: ON)
1	Y_AL2	AL2 status	(0: OFF 1: ON)
2	Y_AL3	AL3 status	(0: OFF 1: ON)
3 to 15			

● Bit Configuration of D7162: **Y100_E1** (DO11-DO15 status: E1-terminal area)

Bit	Symbol	Event	
0	Y_DO11	DO11 status	(0: OFF 1: ON)
1	Y_DO12	DO12 status	(0: OFF 1: ON)
2	Y_DO13	DO13 status	(0: OFF 1: ON)
3	Y_DO14	DO14 status	(0: OFF 1: ON)
4	Y_DO15	DO15 status	(0: OFF 1: ON)
5 to 15			

● Bit Configuration of D7165: **Y400_E4** (DO41-DO45 status: E4-terminal area)

Bit	Symbol	Event	
0	Y_DO41	DO41 status	(0: OFF 1: ON)
1	Y_DO42	DO42 status	(0: OFF 1: ON)
2	Y_DO43	DO43 status	(0: OFF 1: ON)
3	Y_DO44	DO44 status	(0: OFF 1: ON)
4	Y_DO45	DO45 status	(0: OFF 1: ON)
5 to 15			

8.4 UT35A/UT32A/UP35A D Registers

Status Registers (D7201 to D7300)

- Bit Configuration of D7201 to D7208: M1_16 to M113_128 (Status register (M1-M16 to M113-M128, Non-holding type))

Bit	Symbol								Event
0	M01	M17	M33	M49	M65	M81	M97	M113	Internal relay (Non-holding type) (0: OFF 1: ON)
1	M02	M18	M34	M50	M66	M82	M98	M114	Internal relay (Non-holding type) (0: OFF 1: ON)
2	M03	M19	M35	M51	M67	M83	M99	M115	Internal relay (Non-holding type) (0: OFF 1: ON)
3	M04	M20	M36	M52	M68	M84	M100	M116	Internal relay (Non-holding type) (0: OFF 1: ON)
4	M05	M21	M37	M53	M69	M85	M101	M117	Internal relay (Non-holding type) (0: OFF 1: ON)
5	M06	M22	M38	M54	M70	M86	M102	M118	Internal relay (Non-holding type) (0: OFF 1: ON)
6	M07	M23	M39	M55	M71	M87	M103	M119	Internal relay (Non-holding type) (0: OFF 1: ON)
7	M08	M24	M40	M56	M72	M88	M104	M120	Internal relay (Non-holding type) (0: OFF 1: ON)
8	M09	M25	M41	M57	M73	M89	M105	M121	Internal relay (Non-holding type) (0: OFF 1: ON)
9	M10	M26	M42	M58	M74	M90	M106	M122	Internal relay (Non-holding type) (0: OFF 1: ON)
10	M11	M27	M43	M59	M75	M91	M107	M123	Internal relay (Non-holding type) (0: OFF 1: ON)
11	M12	M28	M44	M60	M76	M92	M108	M124	Internal relay (Non-holding type) (0: OFF 1: ON)
12	M13	M29	M45	M61	M77	M93	M109	M125	Internal relay (Non-holding type) (0: OFF 1: ON)
13	M14	M30	M46	M62	M78	M94	M110	M126	Internal relay (Non-holding type) (0: OFF 1: ON)
14	M15	M31	M47	M63	M79	M95	M111	M127	Internal relay (Non-holding type) (0: OFF 1: ON)
15	M16	M32	M48	M64	M80	M96	M112	M128	Internal relay (Non-holding type) (0: OFF 1: ON)

- Bit Configuration of D7211 to D7212: M1_16_B to M17_32_B (Status register (M1_B-M16_B to M17_B-M32_B, Holding type))

Bit	Symbol		Event
0	M01_B	M17_B	Internal relay (Holding type) (0: OFF 1: ON)
1	M02_B	M18_B	Internal relay (Holding type) (0: OFF 1: ON)
2	M03_B	M19_B	Internal relay (Holding type) (0: OFF 1: ON)
3	M04_B	M20_B	Internal relay (Holding type) (0: OFF 1: ON)
4	M05_B	M21_B	Internal relay (Holding type) (0: OFF 1: ON)
5	M06_B	M22_B	Internal relay (Holding type) (0: OFF 1: ON)
6	M07_B	M23_B	Internal relay (Holding type) (0: OFF 1: ON)
7	M08_B	M24_B	Internal relay (Holding type) (0: OFF 1: ON)
8	M09_B	M25_B	Internal relay (Holding type) (0: OFF 1: ON)
9	M10_B	M26_B	Internal relay (Holding type) (0: OFF 1: ON)
10	M11_B	M27_B	Internal relay (Holding type) (0: OFF 1: ON)
11	M12_B	M28_B	Internal relay (Holding type) (0: OFF 1: ON)
12	M13_B	M29_B	Internal relay (Holding type) (0: OFF 1: ON)
13	M14_B	M30_B	Internal relay (Holding type) (0: OFF 1: ON)
14	M15_B	M31_B	Internal relay (Holding type) (0: OFF 1: ON)
15	M16_B	M32_B	Internal relay (Holding type) (0: OFF 1: ON)

● **Bit Configuration of D7213 to D7218: M33_48_B to M113_128_B (Status register (M33_B-M48_B to M113_B-M128_B, Holding type))**

Bit	Symbol						Event
0	M33_B	M49_B	M65_B	M81_B	M97_B	M113_B	Internal relay (Holding type) * (0: OFF 1: ON)
1	M34_B	M50_B	M66_B	M82_B	M98_B	M114_B	Internal relay (Holding type) * (0: OFF 1: ON)
2	M35_B	M51_B	M67_B	M83_B	M99_B	M115_B	Internal relay (Holding type) * (0: OFF 1: ON)
3	M36_B	M52_B	M68_B	M84_B	M100_B	M116_B	Internal relay (Holding type) * (0: OFF 1: ON)
4	M37_B	M53_B	M69_B	M85_B	M101_B	M117_B	Internal relay (Holding type) * (0: OFF 1: ON)
5	M38_B	M54_B	M70_B	M86_B	M102_B	M118_B	Internal relay (Holding type) * (0: OFF 1: ON)
6	M39_B	M55_B	M71_B	M87_B	M103_B	M119_B	Internal relay (Holding type) * (0: OFF 1: ON)
7	M40_B	M56_B	M72_B	M88_B	M104_B	M120_B	Internal relay (Holding type) * (0: OFF 1: ON)
8	M41_B	M57_B	M73_B	M89_B	M105_B	M121_B	Internal relay (Holding type) * (0: OFF 1: ON)
9	M42_B	M58_B	M74_B	M90_B	M106_B	M122_B	Internal relay (Holding type) * (0: OFF 1: ON)
10	M43_B	M59_B	M75_B	M91_B	M107_B	M123_B	Internal relay (Holding type) * (0: OFF 1: ON)
11	M44_B	M60_B	M76_B	M92_B	M108_B	M124_B	Internal relay (Holding type) * (0: OFF 1: ON)
12	M45_B	M61_B	M77_B	M93_B	M109_B	M125_B	Internal relay (Holding type) * (0: OFF 1: ON)
13	M46_B	M62_B	M78_B	M94_B	M110_B	M126_B	Internal relay (Holding type) * (0: OFF 1: ON)
14	M47_B	M63_B	M79_B	M95_B	M111_B	M127_B	Internal relay (Holding type) * (0: OFF 1: ON)
15	M48_B	M64_B	M80_B	M96_B	M112_B	M128_B	Internal relay (Holding type) * (0: OFF 1: ON)

*: It is Non-holding type when the input sampling period (control period) (SMP) is 50 ms.

● **Bit Configuration of D7221: TIM_RELAY (Time out flag)**

Bit	Symbol	Event
0	TIM1	Timer-1 time out flag (0: OFF 1: ON)
1	TIM2	Timer-2 time out flag (0: OFF 1: ON)
2	TIM3	Timer-3 time out flag (0: OFF 1: ON)
3	TIM4	Timer-4 time out flag (0: OFF 1: ON)
4 to 15		

● **Bit Configuration of D7222: CNT_RELAY (Count out relay flag)**

Bit	Symbol	Event
0	CNT1	Counter-1 count out flag (0: OFF 1: ON)
1	CNT2	Counter-2 count out flag (0: OFF 1: ON)
2	CNT3	Counter-3 count out flag (0: OFF 1: ON)
3	CNT4	Counter-4 count out flag (0: OFF 1: ON)
4 to 15		

8.4 UT35A/UT32A/UP35A D Registers

Constant Register (D7301 to D7500)

Register No.	Description		Range and meaning of value
D7301 to D7330	K01 to K30	K01 data register to K30 data register	K01 to K20: -32768 to 32767 K21 to K30: 0 to 65535
D7331 to D7409			
D7410	C_1	Constant -1	-1
D7411	C0	Constant 0	0
D7412	C1	Constant 1	1
D7413	C2	Constant 2	2
D7414	C3	Constant 3	3
D7415	C4	Constant 4	4
D7416	C5	Constant 5	5
D7417	C10	Constant 10	10
D7418	C50	Constant 50	50
D7419	C60	Constant 60	60
D7420	C100	Constant 100	100
D7421	C1000	Constant 1000	1000
D7422	C10000	Constant 10000	10000
D7423 to D7500			

Input Range / Scale (D7501 to D7600) (Read only)

Register No.	Description		Range and meaning of value
D7501	DP_R	PV input decimal point position	Same as D5103 (DP)
D7502	RH_R	Maximum value of PV input range	Same as D5104 (RH)
D7503	RL_R	Minimum value of PV input range	Same as D5105 (RL)
D7504			
D7505	SDP_R	PV input scale decimal point position	Same as D5106 (SDP)
D7506	SH_R	Maximum value of PV input scale	Same as D5107 (SH)
D7507	SL_R	Minimum value of PV input scale	Same as D5108 (SL)
D7508 to D7532			
D7533	P.DP_L1_R	Control PV input decimal point position	Same as D5202 (P.DP_L1)
D7534	P.RH_L1_R	Maximum value of control PV input range	Same as D5203 (P.RH_L1)
D7535	P.RL_L1_R	Minimum value of control PV input range	Same as D5204 (P.RL_L1)
D7536 to D7600			

8.4.7 Input / Output Terminal Status Register (D7601 to D7700)

Terminal status registers													
Input / output terminal status register													
D-Reg No.	Ref. No.	H No.	Register symbol	R/W			D-Reg No.	Ref. No.	H No.	Register symbol	R/W		
				UT 35A	UT 32A	UP 35A					UT 35A	UT 32A	UP 35A
D7601	47601	1DB0	DI	R	R	R	D7651	47651	1DE2				
D7602	47602	1DB1	DI_E1	R	R	R	D7652	47652	1DE3				
D7603	47603	1DB2					D7653	47653	1DE4				
D7604	47604	1DB3					D7654	47654	1DE5				
D7605	47605	1DB4	DI_E4	R	/	R	D7655	47655	1DE6				
D7606	47606	1DB5					D7656	47656	1DE7				
D7607	47607	1DB6					D7657	47657	1DE8				
D7608	47608	1DB7					D7658	47658	1DE9				
D7609	47609	1DB8					D7659	47659	1DEA				
D7610	47610	1DB9					D7660	47660	1DEB				
D7611	47611	1DBA	OUT_AL	R	R	R	D7661	47661	1DEC				
D7612	47612	1DBB	OUT_DO_E1	R	R	R	D7662	47662	1DED				
D7613	47613	1DBC					D7663	47663	1DEE				
D7614	47614	1DBD					D7664	47664	1DEF				
D7615	47615	1DBE	OUT_DO_E4	R	/	R	D7665	47665	1DF0				
D7616	47616	1DBF					D7666	47666	1DF1				
D7617	47617	1DC0					D7667	47667	1DF2				
D7618	47618	1DC1					D7668	47668	1DF3				
D7619	47619	1DC2					D7669	47669	1DF4				
D7620	47620	1DC3					D7670	47670	1DF5				
D7621	47621	1DC4	OUT_OUT	R	R	R	D7671	47671	1DF6				
D7622	47622	1DC5	OUT_OUT2H	R	R	R	D7672	47672	1DF7				
D7623	47623	1DC6	OUT_OUT2L	R	R	R	D7673	47673	1DF8				
D7624	47624	1DC7	OUT_RET	R	R	R	D7674	47674	1DF9				
D7625	47625	1DC8	OUT_OUTR	R	R	R	D7675	47675	1DFA				
D7626	47626	1DC9	OUT_OUT2R	R	R	R	D7676	47676	1DFB				
D7627	47627	1DCA					D7677	47677	1DFC				
D7628	47628	1DCB					D7678	47678	1DFD				
D7629	47629	1DCC					D7679	47679	1DFE				
D7630	47630	1DCD					D7680	47680	1DFF				
D7631	47631	1DCE					D7681	47681	1E00				
D7632	47632	1DCF					D7682	47682	1E01				
D7633	47633	1DD0					D7683	47683	1E02				
D7634	47634	1DD1					D7684	47684	1E03				
D7635	47635	1DD2					D7685	47685	1E04				
D7636	47636	1DD3					D7686	47686	1E05				
D7637	47637	1DD4					D7687	47687	1E06				
D7638	47638	1DD5					D7688	47688	1E07				
D7639	47639	1DD6					D7689	47689	1E08				
D7640	47640	1DD7					D7690	47690	1E09				
D7641	47641	1DD8					D7691	47691	1E0A				
D7642	47642	1DD9					D7692	47692	1E0B				
D7643	47643	1DDA					D7693	47693	1E0C				
D7644	47644	1DDB					D7694	47694	1E0D				
D7645	47645	1DDC					D7695	47695	1E0E				
D7646	47646	1DDD					D7696	47696	1E0F				
D7647	47647	1DDE					D7697	47697	1E10				
D7648	47648	1DDF					D7698	47698	1E11				
D7649	47649	1DE0					D7699	47699	1E12				
D7650	47650	1DE1					D7700	47700	1E13				

8.4 UT35A/UT32A/UP35A D Registers

● Bit Configuration of D7601: DI (DI1-DI2 terminal status: equipped as standard)

Bit	Symbol	Event
0	DI1	DI1 terminal status (0: OFF 1: ON)
1	DI2	DI2 terminal status (0: OFF 1: ON)
2	DI3 *	DI3 terminal status (0: OFF 1: ON)
3 to 15		

*: Only for UP35A.

● Bit Configuration of D7602: DI_E1 (DI11-DI15 terminal status: E1-terminal area)

Bit	Symbol	Event
0	DI11	DI11 terminal status (0: OFF 1: ON)
1	DI12	DI12 terminal status (0: OFF 1: ON)
2	DI13	DI13 terminal status (0: OFF 1: ON)
3	DI14	DI14 terminal status (0: OFF 1: ON)
4	DI15	DI15 terminal status (0: OFF 1: ON)
5 to 15		

● Bit Configuration of D7605: DI_E4 (DI41-DI45 terminal status: E4-terminal area)

Bit	Symbol	Event
0	DI41	DI41 terminal status (0: OFF 1: ON)
1	DI42	DI42 terminal status (0: OFF 1: ON)
2	DI43	DI43 terminal status (0: OFF 1: ON)
3	DI44	DI44 terminal status (0: OFF 1: ON)
4	DI45	DI45 terminal status (0: OFF 1: ON)
5 to 15		

● Bit Configuration of D7611: OUT_AL (AL1-AL3 terminal status: equipped as standard)

Bit	Symbol	Event
0	OUT_AL1	AL1 terminal status (0: OFF 1: ON)
1	OUT_AL2	AL2 terminal status (0: OFF 1: ON)
2	OUT_AL3	AL3 terminal status (0: OFF 1: ON)
3 to 15		

● Bit Configuration of D7612: OUT_DO_E1 (DO11-DO15 terminal status: E1-terminal area)

Bit	Symbol	Event
0	OUT_DO11	DO11 terminal status (0: OFF 1: ON)
1	OUT_DO12	DO12 terminal status (0: OFF 1: ON)
2	OUT_DO13	DO13 terminal status (0: OFF 1: ON)
3	OUT_DO14	DO14 terminal status (0: OFF 1: ON)
4	OUT_DO15	DO15 terminal status (0: OFF 1: ON)
5 to 15		

● Bit Configuration of D7615: OUT_DO_E4 (DO41-DO45 terminal status: E4-terminal area)

Bit	Symbol	Event
0	OUT_DO41	DO41 terminal status (0: OFF 1: ON)
1	OUT_DO42	DO42 terminal status (0: OFF 1: ON)
2	OUT_DO43	DO43 terminal status (0: OFF 1: ON)
3	OUT_DO44	DO44 terminal status (0: OFF 1: ON)
4	OUT_DO45	DO45 terminal status (0: OFF 1: ON)
5 to 15		

● D7616 to D7700

Register No.	Description		Range and meaning of value
D7616 to D7620			
D7621	OUT_OUT	OUT terminal	-1500 to 31500
D7622	OUT_OUT2H	UT35A Heater break alarm: HAL1 terminal Position proportional control output: VALV (HIGH) terminal UT32A Heater break alarm: HAL1 terminal UP35A Heater break alarm: HAL1 terminal Position proportional control output: VALV (HIGH) terminal	
D7623	OUT_OUT2L	UT35A Cooling-side control output: OUT2 terminal Heater break alarm: HAL2 terminal Position proportional control output: VALV (LOW) terminal UT32A Cooling-side control output: OUT2 terminal Heater break alarm: HAL2 terminal UP35A Cooling-side control output: OUT2 terminal Heater break alarm: HAL2 terminal Position proportional control output: VALV (LOW) terminal	0: OFF 30000: ON
D7624	OUT_RET	RET terminal	-1500 to 31500
D7625	OUT_OUTR	UT35A OUT terminal (Relay) UT32A OUT terminal (Relay) Position proportional control output: VALV (LOW) terminal UP35A OUT terminal (Relay)	0: OFF 30000: ON
D7626	OUT_OUT2R	UT35A OUT2 terminal (Relay) UT32A OUT2 terminal (Relay) Position proportional control output: VALV (HIGH) terminal UP35A OUT2 terminal (Relay)	
D7627 to D7700			

8.4.8 Program Pattern for UP35A (D8001 to D9000)

Pattern Data Setting (D8001 to D8100)

Register No.	Ref. No.	H No.	Register symbol	R/W	Description	Range and meaning of value
D8001	48001	1F40	PTNO_C	R/W	Program pattern number selection	0: Not select program pattern 1 to 2 (4 when the option "/AP" is specified.)
D8002	48002	1F41	SEGNO_C	R/W	Segment number designation	0 (1 to 20. (40 when the option "/AP" is specified.)) * When reading from or writing to D8003 to D8043 registers, write "0" to the register.
D8003	48003	1F42	SSP_L1	R/W	Starting target setpoint	0.0 to 100.0% of PV input range (EU) (Setting range: P.RL to P.RH)
D8004	48004	1F43				
D8005	48005	1F44	STC	R/W	Start code	0: SSP (Program operation begins with the starting target setpoint.) 1: RAMP (Ramp-prioritized PV start) 2: TIME (Time-prioritized PV start) 3: LSP (Local-mode start) * STC=TIME cannot be selected when the parameter SEG.T is TM.RT.
D8006	48006	1F45	WT.SW1	R/W	Wait function ON/OFF	0: OFF (Disable) 1: ON (Enable)
D8007	48007	1F46	WZ.UP1	R/W	Upper-side wait zone	0.0 to 10.0% of PV input range (EU)
D8008	48008	1F47	WZ.LO1	R/W	Lower-side wait zone	OFF: No function 0.00 to 999.59 ("hour.minute" or "minute.
D8009	48009	1F48	WT.TM1	R/W	Wait time	0: OFF (No function) 1 to 59999 (minute or second) * Available only for the wait time at the segment switching. * Use the parameter TMU to set the time unit. (Common in the instrument.)
D8010 to D8025						
D8026	48026	1F59	R.CYCL	R/W	Number of repeat cycles	0 to 999, 1000: CONT (The controller indefinitely repeats the segment specified by the RST and REN parameters.)
D8027	48027	1F5A	R.STRT	R/W	Repeat cycle start segment number	1 to 20 (40 when the option "/AP" is specified.)
D8028	48028	1F5B	R.END	R/W	Repeat cycle end segment number	1 ≤ R.STRT ≤ R.END ≤ 20 (40)
D8029 to D8030						
D8031	48031	1F5E	P.NAME	R/W	Program pattern name	20-digit value of alphanumeric characters can be set. Arrangement: D8031, D8032, D8033, D6004, D8035, D8036, D8037, D8038, D8039, D8040, D8041 Write "0x00" to the register after the character string.
D8032	48032	1F5F	P.NAME	R/W	Program pattern name	
D8033	48033	1F60	P.NAME	R/W	Program pattern name	
D8034	48034	1F61	P.NAME	R/W	Program pattern name	
D8035	48035	1F62	P.NAME	R/W	Program pattern name	
D8036	48036	1F63	P.NAME	R/W	Program pattern name	
D8037	48037	1F64	P.NAME	R/W	Program pattern name	
D8038	48038	1F65	P.NAME	R/W	Program pattern name	
D8039	48039	1F66	P.NAME	R/W	Program pattern name	
D8040	48040	1F67	P.NAME	R/W	Program pattern name	
D8041	48041	1F68	P.NAME	R/W	Program pattern name	
D8042	48042	1F69	PTN.ERR	R	Read/write error information	
D8043 to D8100						

Reading Pattern Data (D8001 to D8100)

■ Modbus communication

The example for the communication command is Modbus/RTU. For easy understanding, space is added but it is not present in the actual command. The device address is "1."

● Reading start segment data

Example: Reading start target setpoint (SSP_L1) for pattern 2

- (1) Write pattern number "2" to D8001 (PTNO._C), and segment number "0" to D8002 (SEGNO._C).
- (2) Read from D8003 (SSP_L1).
- (3) Read from D8042 (PTN.ERR).

If reading PTN.ERR results in other than zero, an error occurred. If zero, the read was successful.

- (1) 01 10 1F40 0002 04 0002 0000 [CRC]
- (2) 01 03 1F42 0001 [CRC]
- (3) 01 03 1F69 0001 [CRC]

Example: Batch reading start segment data for pattern 2

- (1) Write pattern number "2" to D8001 (PTNO._C), and segment number "0" to D8002 (SEGNO._C).
- (2) Read from 40 registers continuously: D8003 (SSP_L1) to D8041 (P.NAME) and D8042 (PTN.ERR).

If reading PTN.ERR results in other than zero, an error occurred. If zero, the read was successful.

- (1) 01 10 1F40 0002 04 0002 0000 [CRC]
- (2) 01 03 1F42 0028 [CRC]

■ PC link communication

The example for the communication command is a PC link without a checksum. The device address is "1."

● Reading start segment data

Example: Reading start target setpoint (SSP_L1) for pattern 2

- (1) Write pattern number "2" to D8001 (PTNO._C), and segment number "0" to D8002 (SEGNO._C).
- (2) Read from D8003 (SSP_L1).
- (3) Read from D8042 (PTN.ERR).

If reading PTN.ERR results in other than zero, an error occurred. If zero, the read was successful.

- (1) 01010WWRD8001,02,00020000
- (2) 01010WRDD8003,01
- (3) 01010WRDD8042,01

Example: Batch reading start segment data for pattern 2

- (1) Write pattern number "2" to D8001 (PTNO._C), and segment number "0" to D8002 (SEGNO._C).
- (2) Read from 40 registers continuously: D8003 (SSP_L1) to D8041 (P.NAME) and D8042 (PTN.ERR).

If reading PTN.ERR results in other than zero, an error occurred. If zero, the read was successful.

- (1) 01010WWRD8001,02,00020000
- (2) 01010WRDD8003,40

Writing Pattern Data (D8001 to D8100)

■ Modbus communication

The example for the communication command is Modbus/RTU. For easy understanding, space is added but it is not present in the actual command. The device address is "1."

● Writing start segment data

Example: Writing "2" to start code (STC) for pattern 2

- (1) Write pattern number "2" to D8001 (PTNO._C), and segment number "0" to D8002 (SEGNO._C).
- (2) Write "2" to D8005 (STC).
- (3) Read from D8042 (PTN.ERR).

If the result is other than zero, an error occurred. If zero, the write was successful.

- (1) 01 10 1F40 0002 04 0002 0000 [CRC]
- (2) 01 10 1F44 0001 02 0002 [CRC]
- (3) 01 03 1F69 0001 [CRC]

Example: Batch writing start segment data for pattern 2

- (1) Write to 41 registers continuously: pattern number "2" to D8001 (PTNO._C), segment number "0" to D8002 (SEGNO._C), and data to D8003 (SSP_L1) to D8041 (P.NAME).
If "PTN.ERR" in the response is other than zero, an error occurred. If zero, the write was successful.

- (1) 01 46 1F40 0029 52 0002 0000 **03 **04 ... **40 **41 [CRC]

■ PC link communication

The example for the communication command is a PC link without a checksum. The device address is "1."

● Writing start segment data

Example: Writing "2" to start code (STC) for pattern 2

- (1) Write pattern number "2" to D8001 (PTNO._C), and segment number "0" to D8002 (SEGNO._C).
- (2) Write "2" to D8005 (STC).
- (3) Read from D8042 (PTN.ERR).

If the result is other than zero, an error occurred. If zero, the write was successful.

- (1) 01010WWRD8001,02,00020000
- (2) 01010WWRD8005,01,0002
- (3) 01010WRDD8042,01

Example: Batch writing start segment data for pattern 2

- (1) Write to 41 registers continuously: pattern number "2" to D8001 (PTNO._C), segment number "0" to D8002 (SEGNO._C), and data to D8003 (SSP_L1) to D8041 (P.NAME).
- (2) Read from D8042 (PTN.ERR).

If the result is other than zero, an error occurred. If zero, the write was successful.

- (1) 01010WWRD8001,41,0002 0000 **03 **04 ... **40 **41
- (2) 01010WRDD8042,01

Segment Data Setting (D8101 to D8200)

Register No.	Ref. No.	H No.	Register symbol	R/W	Description	Range and meaning of value
D8101	48101	1FA4	PTNO._C	R/W	Program pattern number selection	0: Not select program pattern 1 to 2 (4 when the option "/AP" is specified.)
D8102	48102	1FA5	SEGNO._C	R/W	Segment number designation	0 (1 to 20. (40 when the option "/AP" is specified.)) * When reading from or writing to D8003 to D8043 registers, write "0" to the register.
D8103	48103	1FA6	TSP_L1	R/W	Final target setpoint	0.0 to 100.0% of PV input range (EU) (Setting range: P.RL to P.RH)
D8104	48104	1FA7				
D8105	48105	1FA8	TIME	R/W	Segment time setting	Unregistered (65535) 0 to 59999 (minute or second) * Setting available for the parameter SEG. T=TIME.* Use the parameter TMU to set the time unit. (Common in the instrument.) * If the setting is 0.00, TSP changes in stepwise after one control period.
D8106	48106	1FA9	TM.RT	R/W	Segment ramp-rate setting	Unregistered (65535) Ramp: 0.0 to 100.0% of PV input range span (EUS) / 1 hour or 1 minute Soak:0 to 59999 (minute or second) * Setting available for the parameter SEG. T=RAMP. * Use the parameter TMU to set the time unit. (Common in the instrument.) Per 1 hour: TMU=HH.MM, Per 1 minute: TMU=MM.SS * If it is set to 0.0% of the input range span, or the segment time 0.00, the program moves to the next segment after one control period.
D8107	48107	1FAA	S.PID	R/W	Segment PID number selection	1 to 4 * PID number can be set when the parameter "ZON = 0."
D8108	48108	1FAB	JC	R/W	Junction code	0: CONT (Switching for continuation) 1: HOLD (Hold-on switching (the controller holds the end-of-segment setpoint when the segment is completed, to perform control)). 2: LOC (Local-mode switching (the controller switches to a local setpoint when the segment is completed)). 11: W.SW (Wait during switching between segments). 16: W.IV (Wait within a segment interval). 21: W.SL (Segment switching (the controller switches to a local setpoint when the segment is completed after release.)) 31 to 32: PLK.1 to PLK.2 (Linked to patterns 1 to 2.) 33 to 34: PLK.3 to PLK.4 (Linked to patterns 3 to 4.) (when the option "/AP" is specified.)

8.4 UT35A/UT32A/UP35A D Registers

Register No.	Ref. No.	H No.	Register symbol	R/W	Description	Range and meaning of value
D8109	48109	1FAC	PV.TY1	R/W	PV event-1 type	<p>OFF: Disable (Energized)</p> <p>1: PV high limit, 02: PV low limit, 3: SP high limit, 04: SP low limit, 5: Deviation high limit, 6: Deviation low limit, 7: Deviation high and low limits, 8: Deviation within high and low limits, 9: Target SP high limit, 10: Target SP low limit, 11: Target SP deviation high limit, 12: Target SP deviation low limit, 13: Target SP deviation high and low limits, 14: Target SP deviation within high and low limits, 15: OUT high limit, 16: OUT low limit, 17: Cooling-side OUT high limit, 18: Cooling-side OUT low limit</p> <p>* Add 100 for "de-energized". For example, when the PV high limit is de-energized, the setting is 101.</p>
D8110	48110	1FAD	PV.EV1	R/W	PV event-1 setpoint	<p>Set a display value of setpoint of PV alarm, SP alarm, deviation alarm, or output alarm. -19999 to 30000 (Set a value within the input range.)</p> <p>Decimal point position depends on the input type.</p>
D8111	48111	1FAE	PV.TY2	R/W	PV event-2 type	Same as D8109
D8112	48112	1FAF	PV.EV2	R/W	PV event-2 setpoint	Same as D8110
D8113 to D8124						
D8125	48125	1FBC	TME1	R/W	Start condition of time event 1	<p>0: OFF (Start OFF state)</p> <p>1: ON (Start ON state)</p>
D8126	48126	1FBD	T.ON1	R/W	On time of time event 1	<p>0: Unregistered</p> <p>1 to 59999 (minute or second)</p> <p>* Available only within the segment time.</p> <p>* OFF when the operation mode is changed to the mode except the program operation.</p> <p>* Use the parameter TMU to set the time unit. (Common in the instrument.)</p>
D8127	48127	1FBE	T.OF1	R/W	Off time of time event 1	<p>0: Unregistered</p> <p>1 to 59999 (minute or second)</p> <p>* Available only within the segment time.</p> <p>* OFF when the operation mode is changed to the mode except the program operation.</p> <p>* Use the parameter TMU to set the time unit. (Common in the instrument.)</p>
D8128	48128	1FBF	TME2	R/W	Start condition of time event 2	Same as D8125
D8129	48129	1FC0	T.ON2	R/W	On time of time event 2	Same as D8126
D8130	48130	1FC1	T.OF2	R/W	Off time of time event 2	Same as D8127
D8131	48131	1FC2	TME3	R/W	Start condition of time event 3	Same as D8125
D8132	48132	1FC3	T.ON3	R/W	On time of time event 3	Same as D8126
D8133	48133	1FC4	T.OF3	R/W	Off time of time event 3	Same as D8127
D8134	48134	1FC5	TME4	R/W	Start condition of time event 4	Same as D8125
D8135	48135	1FC6	T.ON4	R/W	On time of time event 4	Same as D8126
D8136	48136	1FC7	T.OF4	R/W	Off time of time event 4	Same as D8127
D8137 to D8172						
D8173	48173	1FEC	PTN.ERR	R	Read/write error information	<p>0: normal end</p> <p>Except 0: error (See "Error information" described later in this chapter.)</p>
D8174 to D8200						

Reading Segment Data (D8101 to D8200)

■ Modbus communication

The example for the communication command is Modbus/RTU. For easy understanding, space is added but it is not present in the actual command. The device address is "1."

Example: Reading final target setpoint (TSP_L1) of segment 5 for pattern 1

- (1) Write pattern number "1" to D8101 (PTNO._C), and segment number "5" to D8102 (SEGNO._C).
- (2) Read from D8103 (TSP_L1).
- (3) Read from D8173 (PTN.ERR).

If the result is other than zero, an error occurred. If zero, the read was successful.

- (1) 01 10 1FA4 0002 04 0001 0005 [CRC]
- (2) 01 03 1FA6 0001 [CRC]
- (3) 01 03 1FEC 0001 [CRC]

Example: Batch reading segment data of segment 5 for pattern 1

- (1) Write pattern number "1" to D8101 (PTNO._C), and segment number "5" to D8102 (SEGNO._C).
- (2) Read from 71 registers continuously: D8103 (TSP_L1) to D8136 (T.OF4) and D8173 (PTN.ERR).

If reading PTN.ERR results in other than zero, an error occurred. If zero, the read was successful.

- (1) 01 10 1FA4 0002 04 0001 0005 [CRC]
- (2) 01 03 1FA6 0047 [CRC]

■ PC link communication

The example for the communication command is a PC link without a checksum. The device address is "1."

Example: Reading final target setpoint (TSP_L1) of segment 5 for pattern 1

- (1) Write pattern number "1" to D8101 (PTNO._C), and segment number "5" to D8102 (SEGNO._C).
- (2) Read from D8103 (TSP_L1).
- (3) Read from D8173 (PTN.ERR).

If the result is other than zero, an error occurred. If zero, the read was successful.

- (1) 01010WWRD8101,02,00010005
- (2) 01010WRDD8103,01
- (3) 01010WRDD8173,01

Example: Batch reading segment data of segment 5 for pattern 1

- (1) Write pattern number "1" to D8101 (PTNO._C) and segment number "5" to D8102 (SEGNO._C).
- (2) Read from 34 registers continuously: D8103 (TSP_L1) to D8136 (T.OF4).
- (3) Read from D8173 (PTN.ERR).

If the result is other than zero, an error occurred. If zero, the read was successful.

- (1) 01010WWRD8101,02,00010005
- (2) 01010WRDD8103,34
- (3) 01010WRDD8173,01

Writing Segment Data (D8101 to D8200)

■ Modbus communication

The example for the communication command is Modbus/RTU. For easy understanding, space is added but it is not present in the actual command. The device address is "1."

Example: Writing final target setpoint (TSP_L1) of segment 5 for pattern 1

- (1) Write pattern number "1" to D8101 (PTNO._C), and segment number "5" to D8102 (SEGNO._C).
- (2) Write "50" to D8103 (TSP_L1).
- (3) Read from D8173 (PTN.ERR).

If the result is other than zero, an error occurred. If zero, the write was successful.

- (1) 01 10 1FA4 0002 04 0001 0005 [CRC]
- (2) 01 10 1FA6 0001 02 0032 [CRC]
- (3) 01 03 1FEC 0001 [CRC]

Example: Batch writing segment data of segment 5 for pattern 1

- (1) Write to 36 registers continuously: pattern number "1" to D8101 (PTNO._C), segment number "5" to D8102 (SEGNO._C), and data to D8103 (TSP_L1) to D8136 (T.OF4).
If reading PTN.ERR results in other than zero, an error occurred. If zero, the write was successful.

- (1) 01 46 1FA4 0024 48 0001 0005 **03 **04 ... **35 **36 [CRC]

■ PC link communication

The example for the communication command is a PC link without a checksum. The device address is "1."

Example: Writing final target setpoint (TSP_L1) of segment 5 for pattern 1

- (1) Write pattern number "1" to D8101 (PTNO._C), and segment number "5" to D8102 (SEGNO._C).
- (2) Read from D8103 (TSP_L1).
- (3) Read from D8173 (PTN.ERR).

If the result is other than zero, an error occurred. If zero, the write was successful.

- (1) 01010WWRD8101,02,00010005
- (2) 01010WWRD8103,01,0032
- (3) 01010WRDD8173,01

Example: Batch writing segment data of segment 5 for pattern 1

- (1) Write to 36 registers continuously: pattern number "1" to D8101 (PTNO._C), segment number "5" to D8102 (SEGNO._C), and data to D8103 (TSP_L1) to D8136 (T.OF4).
- (2) Read from D8173 (PTN.ERR).

If the result is other than zero, an error occurred. If zero, the write was successful.

- (1) 01010WWRD8101,36,0001 0005 **03 **04 ... **35 **36
- (2) 01010WRDD8173,01

Final Target Setpoint Setting for Batch Writing (D8201 to D8300)

Register No.	Ref. No.	H No.	Register symbol	R/W	Description	Range and meaning of value
D8201	48201	2008	PTNO._C	R/W	Program pattern number selection	0: Not select program pattern 1 to 2 (4 when the option "/AP" is specified.)
D8202	48202	2009				
D8203	48203	200A	SSP_L1	R/W	Starting target setpoint	0.0 to 100.0% of PV input range (EU) (Setting range: P.RL to P.RH)
D8204	48204	200B	TSP_L1_S1	R/W	Segment-1 final target setpoint	0.0 to 100.0% of PV input range (EU) (Setting range: P.RL to P.RH)
D8205	48205	200C	TSP_L1_S2	R/W	Segment-2 final target setpoint	
D8206	48206	200D	TSP_L1_S3	R/W	Segment-3 final target setpoint	
D8207	48207	200E	TSP_L1_S4	R/W	Segment-4 final target setpoint	
D8208	48208	200F	TSP_L1_S5	R/W	Segment-5 final target setpoint	
D8209	48209	2010	TSP_L1_S6	R/W	Segment-6 final target setpoint	
D8210	48210	2011	TSP_L1_S7	R/W	Segment-7 final target setpoint	
D8211	48211	2012	TSP_L1_S8	R/W	Segment-8 final target setpoint	
D8212	48212	2013	TSP_L1_S9	R/W	Segment-9 final target setpoint	
D8213	48213	2014	TSP_L1_S10	R/W	Segment-10 final target setpoint	
D8214	48214	2015	TSP_L1_S11	R/W	Segment-11 final target setpoint	
D8215	48215	2016	TSP_L1_S12	R/W	Segment-12 final target setpoint	
D8216	48216	2017	TSP_L1_S13	R/W	Segment-13 final target setpoint	
D8217	48217	2018	TSP_L1_S14	R/W	Segment-14 final target setpoint	
D8218	48218	2019	TSP_L1_S15	R/W	Segment-15 final target setpoint	
D8219	48219	201A	TSP_L1_S16	R/W	Segment-16 final target setpoint	
D8220	48220	201B	TSP_L1_S17	R/W	Segment-17 final target setpoint	
D8221	48221	201C	TSP_L1_S18	R/W	Segment-18 final target setpoint	
D8222	48222	201D	TSP_L1_S19	R/W	Segment-19 final target setpoint	
D8223	48223	201E	TSP_L1_S20	R/W	Segment-20 final target setpoint	
D8224	48224	201F	TSP_L1_S21	R/W	Segment-21 final target setpoint	
D8225	48225	2020	TSP_L1_S22	R/W	Segment-22 final target setpoint	
D8226	48226	2021	TSP_L1_S23	R/W	Segment-23 final target setpoint	
D8227	48227	2022	TSP_L1_S24	R/W	Segment-24 final target setpoint	
D8228	48228	2023	TSP_L1_S25	R/W	Segment-25 final target setpoint	
D8229	48229	2024	TSP_L1_S26	R/W	Segment-26 final target setpoint	
D8230	48230	2025	TSP_L1_S27	R/W	Segment-27 final target setpoint	
D8231	48231	2026	TSP_L1_S28	R/W	Segment-28 final target setpoint	
D8232	48232	2027	TSP_L1_S29	R/W	Segment-29 final target setpoint	
D8233	48233	2028	TSP_L1_S30	R/W	Segment-30 final target setpoint	
D8234	48234	2029	TSP_L1_S31	R/W	Segment-31 final target setpoint	
D8235	48235	202A	TSP_L1_S32	R/W	Segment-32 final target setpoint	
D8236	48236	202B	TSP_L1_S33	R/W	Segment-33 final target setpoint	
D8237	48237	202C	TSP_L1_S34	R/W	Segment-34 final target setpoint	
D8238	48238	202D	TSP_L1_S35	R/W	Segment-35 final target setpoint	
D8239	48239	202E	TSP_L1_S36	R/W	Segment-36 final target setpoint	
D8240	48240	202F	TSP_L1_S37	R/W	Segment-37 final target setpoint	
D8241	48241	2030	TSP_L1_S38	R/W	Segment-38 final target setpoint	
D8242	48242	2031	TSP_L1_S39	R/W	Segment-39 final target setpoint	
D8243	48243	2032	TSP_L1_S40	R/W	Segment-40 final target setpoint	
D8244 to D8252						
D8253	48253	203C	PTN.ERR	R	Read/write error information	0: normal end Except 0: error (See "Error information" described later in this chapter.)
D8254 to D8300						

D8301 to D8600: Free area

8.4 UT35A/UT32A/UP35A D Registers

Segment Time Setting for Batch Writing (D8601 to D8700)

Register No.	Ref. No.	H No.	Register symbol	R/W	Description	Range and meaning of value
D8601	48601	2198	PTNO_C	R/W	Program pattern number selection	0: Not select program pattern 1 to 2 (4 when the option "/AP" is specified.)
D8602	48602	2199				
D8603	48603	219A				
D8604	48604	219B	TIME_S1	R/W	Segment-1 segment time setting	Unregistered (65535) 0 to 59999 (minute or second) * Setting available for the parameter SEG. T=TIME. * Use the parameter TMU to set the time unit. (Common in the instrument.) * If the setting is 0.00, TSP changes in stepwise after one control period.
D8605	48605	219C	TIME_S2	R/W	Segment-2 segment time setting	
D8606	48606	219D	TIME_S3	R/W	Segment-3 segment time setting	
D8607	48607	219E	TIME_S4	R/W	Segment-4 segment time setting	
D8608	48608	219F	TIME_S5	R/W	Segment-5 segment time setting	
D8609	48609	21A0	TIME_S6	R/W	Segment-6 segment time setting	
D8610	48610	21A1	TIME_S7	R/W	Segment-7 segment time setting	
D8611	48611	21A2	TIME_S8	R/W	Segment-8 segment time setting	
D8612	48612	21A3	TIME_S9	R/W	Segment-9 segment time setting	
D8613	48613	21A4	TIME_S10	R/W	Segment-10 segment time setting	
D8614	48614	21A5	TIME_S11	R/W	Segment-11 segment time setting	
D8615	48615	21A6	TIME_S12	R/W	Segment-12 segment time setting	
D8616	48616	21A7	TIME_S13	R/W	Segment-13 segment time setting	
D8617	48617	21A8	TIME_S14	R/W	Segment-14 segment time setting	
D8618	48618	21A9	TIME_S15	R/W	Segment-15 segment time setting	
D8619	48619	21AA	TIME_S16	R/W	Segment-16 segment time setting	
D8620	48620	21AB	TIME_S17	R/W	Segment-17 segment time setting	
D8621	48621	21AC	TIME_S18	R/W	Segment-18 segment time setting	
D8622	48622	21AD	TIME_S19	R/W	Segment-19 segment time setting	
D8623	48623	21AE	TIME_S20	R/W	Segment-20 segment time setting	
D8624	48624	21AF	TIME_S21	R/W	Segment-21 segment time setting	
D8625	48625	21B0	TIME_S22	R/W	Segment-22 segment time setting	
D8626	48626	21B1	TIME_S23	R/W	Segment-23 segment time setting	
D8627	48627	21B2	TIME_S24	R/W	Segment-24 segment time setting	
D8628	48628	21B3	TIME_S25	R/W	Segment-25 segment time setting	
D8629	48629	21B4	TIME_S26	R/W	Segment-26 segment time setting	
D8630	48630	21B5	TIME_S27	R/W	Segment-27 segment time setting	
D8631	48631	21B6	TIME_S28	R/W	Segment-28 segment time setting	
D8632	48632	21B7	TIME_S29	R/W	Segment-29 segment time setting	
D8633	48633	21B8	TIME_S30	R/W	Segment-30 segment time setting	
D8634	48634	21B9	TIME_S31	R/W	Segment-31 segment time setting	
D8635	48635	21BA	TIME_S32	R/W	Segment-32 segment time setting	
D8636	48636	21BB	TIME_S33	R/W	Segment-33 segment time setting	
D8637	48637	21BC	TIME_S34	R/W	Segment-34 segment time setting	
D8638	48638	21BD	TIME_S35	R/W	Segment-35 segment time setting	
D8639	48639	21BE	TIME_S36	R/W	Segment-36 segment time setting	
D8640	48640	21BF	TIME_S37	R/W	Segment-37 segment time setting	
D8641	48641	21C0	TIME_S38	R/W	Segment-38 segment time setting	
D8642	48642	21C1	TIME_S39	R/W	Segment-39 segment time setting	
D8643	48643	21C2	TIME_S40	R/W	Segment-40 segment time setting	
D8644 to D8652						
D8653	48653	21CC	PTN.ERR	R	Read/write error information	0: normal end Except 0: error (See "Error information" described later in this chapter.)
D8654 to D8700						

D8701to D8800: Free area

Segment Ramp-Rate Setting for Batch Writing (D8801 to D9000)

Register No.	Ref. No.	H No.	Register symbol	R/W	Description	Range and meaning of value
D8801	48801	2260	PTNO._C	R/W	Program pattern number selection	0: Not select program pattern 1 to 2 (4 when the option "/AP" is specified.)
D8802	48802	2261				
D8803	48803	2262				
D8804	48804	2263	TM.RT_S1	R/W	Segment-1 segment ramp-rate setting	Unregistered (65535) Ramp: 0.0 to 100.0% of PV input range span (EUS) / 1 hour or 1 minute Soak: 0 to 59999 (minute or second) * Setting available for the parameter SEG. T=RAMP. * Use the parameter TMU to set the time unit. (Common in the instrument.) Per 1 hour: TMU=HH.MM, Per 1 minute: TMU=MM.SS * If it is set to 0.0% of the input range span, or the segment time 0.00, the program moves to the next segment after one control period.
D8805	48805	2264	TM.RT_S2	R/W	Segment-2 segment ramp-rate setting	
D8806	48806	2265	TM.RT_S3	R/W	Segment-3 segment ramp-rate setting	
D8807	48807	2266	TM.RT_S4	R/W	Segment-4 segment ramp-rate setting	
D8808	48808	2267	TM.RT_S5	R/W	Segment-5 segment ramp-rate setting	
D8809	48809	2268	TM.RT_S6	R/W	Segment-6 segment ramp-rate setting	
D8810	48810	2269	TM.RT_S7	R/W	Segment-7 segment ramp-rate setting	
D8811	48811	226A	TM.RT_S8	R/W	Segment-8 segment ramp-rate setting	
D8812	48812	226B	TM.RT_S9	R/W	Segment-9 segment ramp-rate setting	
D8813	48813	226C	TM.RT_S10	R/W	Segment-10 segment ramp-rate setting	
D8814	48814	226D	TM.RT_S11	R/W	Segment-11 segment ramp-rate setting	
D8815	48815	226E	TM.RT_S12	R/W	Segment-12 segment ramp-rate setting	
D8816	48816	226F	TM.RT_S13	R/W	Segment-13 segment ramp-rate setting	
D8817	48817	2270	TM.RT_S14	R/W	Segment-14 segment ramp-rate setting	
D8818	48818	2271	TM.RT_S15	R/W	Segment-15 segment ramp-rate setting	
D8819	48819	2272	TM.RT_S16	R/W	Segment-16 segment ramp-rate setting	
D8820	48820	2273	TM.RT_S17	R/W	Segment-17 segment ramp-rate setting	
D8821	48821	2274	TM.RT_S18	R/W	Segment-18 segment ramp-rate setting	
D8822	48822	2275	TM.RT_S19	R/W	Segment-19 segment ramp-rate setting	
D8823	48823	2276	TM.RT_S20	R/W	Segment-20 segment ramp-rate setting	
D8824	48824	2277	TM.RT_S21	R/W	Segment-21 segment ramp-rate setting	
D8825	48825	2278	TM.RT_S22	R/W	Segment-22 segment ramp-rate setting	
D8826	48826	2279	TM.RT_S23	R/W	Segment-23 segment ramp-rate setting	
D8827	48827	227A	TM.RT_S24	R/W	Segment-24 segment ramp-rate setting	
D8828	48828	227B	TM.RT_S25	R/W	Segment-25 segment ramp-rate setting	
D8829	48829	227C	TM.RT_S26	R/W	Segment-26 segment ramp-rate setting	
D8830	48830	227D	TM.RT_S27	R/W	Segment-27 segment ramp-rate setting	
D8831	48831	227E	TM.RT_S28	R/W	Segment-28 segment ramp-rate setting	
D8832	48832	227F	TM.RT_S29	R/W	Segment-29 segment ramp-rate setting	
D8833	48833	2280	TM.RT_S30	R/W	Segment-30 segment ramp-rate setting	
D8834	48834	2281	TM.RT_S31	R/W	Segment-31 segment ramp-rate setting	
D8835	48835	2282	TM.RT_S32	R/W	Segment-32 segment ramp-rate setting	
D8836	48836	2283	TM.RT_S33	R/W	Segment-33 segment ramp-rate setting	
D8837	48837	2284	TM.RT_S34	R/W	Segment-34 segment ramp-rate setting	
D8838	48838	2285	TM.RT_S35	R/W	Segment-35 segment ramp-rate setting	
D8839	48839	2286	TM.RT_S36	R/W	Segment-36 segment ramp-rate setting	
D8840	48840	2287	TM.RT_S37	R/W	Segment-37 segment ramp-rate setting	
D8841	48841	2288	TM.RT_S38	R/W	Segment-38 segment ramp-rate setting	
D8842	48842	2289	TM.RT_S39	R/W	Segment-39 segment ramp-rate setting	
D8843	48843	228A	TM.RT_S40	R/W	Segment-40 segment ramp-rate setting	
D8844 to D8852						
D8853	48853	2294	PTN.ERR	R	Read/write error information	0: normal end Except 0: error (See "Error information" described later in this chapter.)
D8854 to D8960						

Reading Data (Multiple Segment Data) (D8201 to D8953)

■ Modbus communication

The example for the communication command is Modbus/RTU. For easy understanding, space is added but it is not present in the actual command. The device address is "1."

Example: Batch reading SSP_L1 and target setpoints in segments 1 to 5 (TSP_L1_S1 to TSP_L1_S5) for pattern 1

- (1) Write pattern number "1" to D8201 (PTNO._C).
- (2) Read from 6 registers continuously: D8203 (SSP_L1) and D8204 (TSP_L1_S1) to D8208 (TSP_L1_S5).
- (3) Read from D8253 (PTN.ERR).

If the result is other than zero, an error occurred. If zero, the read was successful.

- (1) 01 10 2008 0001 02 0001 [CRC]
- (2) 01 03 200A 0006 [CRC]
- (3) 01 03 203C 0001 [CRC]

Example: Batch reading SSP_L1 and target setpoints in segments 1 to 20 (TSP_L1_S1 to TSP_L1_S20) for pattern 1

- (1) Write pattern number "1" to D8201 (PTNO._C).
- (2) Read from 51 registers continuously: D8204 (TSP_L1_S1) to D8223 (TSP_L1_S20) and D8253 (PTN.ERR).

If reading PTN.ERR results in other than zero, an error occurred. If zero, the read was successful.

- (1) 01 10 2008 0001 02 0001 [CRC]
- (2) 01 03 200A 0033 [CRC]

■ PC link communication

The example for the communication command is a PC link without a checksum. The device address is "1."

Example: Batch reading SSP_L1 and target setpoints in segments 1 to 5 (TSP_L1_S1 to TSP_L1_S5) for pattern 1

- (1) Write pattern number "1" to D8201 (PTNO._C).
- (2) Read from 6 registers continuously: D8203 (SSP_L1) and D8204 (TSP_L1_S1) to D8208 (TSP_L1_S5).
- (3) Read from D8253 (PTN.ERR).

If the result is other than zero, an error occurred. If zero, the read was successful.

- (1) 01010WWRD8201,01,0001
- (2) 01010WRDD8203,06
- (3) 01010WRDD8253,01

Example: Batch reading SSP_L1 and target setpoints in segments 1 to 20 (TSP_L1_S1 to TSP_L1_S20) for pattern 1

- (1) Write pattern number "1" to D8201 (PTNO._C).
- (2) Read from 51 registers continuously: D8203 (SSP_L1), D8204 (TSP_L1_S1) to D8223 (TSP_L1_S20) and D8253 (PTN.ERR).

If reading PTN.ERR results in other than zero, an error occurred. If zero, the read was successful.

- (1) 01010WWRD8201,01,0001
- (2) 01010WRDD8203,51

Writing Data (Multiple Segment Data) (D8201 to D8953)**■ Modbus communication**

The example for the communication command is Modbus/RTU. For easy understanding, space is added but it is not present in the actual command. The device address is "1."

Example: Batch writing SSP_L1 and target setpoints in segments 1 to 20 (TSP_L1_S1 to TSP_L1_S20) for pattern 1

- (1) Write to 23 registers continuously: pattern number "1" to D8201 (PTNO._C), "0" to D8202 (unused), D8203 (SSP_L1), and D8204 (TSP_L1_S1) to D8223 (TSP_L1_S20).

If "PTN.ERR" in the response is other than zero, an error occurred. If zero, the write was successful.

(1) 01 01 46 2008 0017 2E 0001 0000 **03 ... **22 **23 [CRC]

■ PC link communication

The example for the communication command is a PC link without a checksum. The device address is "1."

Example: Batch writing SSP_L1 and target setpoints in segments 1 to 20 (TSP_L1_S1 to TSP_L1_S20) for pattern 1

- (1) Write to 23 registers continuously: pattern number "1" to D8201 (PTNO._C), "0" to D8202 (unused), D8203 (SSP_L1), and D8204 (TSP_L1_S1) to D8223 (TSP_L1_S20).

- (2) Read from D8253 (PTN.ERR).

If the result is other than zero, an error occurred. If zero, the read was successful.

(1) 01010WWRD8201,23,0001 0000 **03 **04 ... **22 **23

(2) 01010WRDD8253,01

8.4 UT35A/UT32A/UP35A D Registers

Used Pattern Numbers and the Number of Remaining Unused Segments (D8961 to D8963)

Register No.	Ref. No.	H No.	Register symbol	R/W	Description	Range and meaning of value
D8961	48961	2300	PTN_USE1	R/W	Used program pattern numbers (Patterns 1 to 4)	See below
D8962						
D8963	48963	2302	ALL.S	R/W	Number of remaining unused segments	0 to 20 (40 when the option "/AP" is specified.)
D8964 to 8970						

● Bit Configuration of D8961: PTN_USE1 (Used program pattern numbers (Patterns 1 to 4))

Bit	Symbol	Event
0	PT1_USE	Used pattern 1
1	PT2_USE	Used pattern 2
2	PT3_USE *	Used pattern 3
3	PT4_USE *	Used pattern 4
4 to 15		

*: Only for UP35A with option "/AP."

Check the Number of Segments, Copy and Clear of Program Pattern (D8971 to D8993)

Register No.	Ref. No.	H No.	Register symbol	R/W	Description	Range and meaning of value
D8971	48971	230A	PTN.S	R/W	Pattern number designation for confirming number of segments	0: not select program pattern 1 to 2 (4 when the option "/AP" is specified.)
D8972	48972	230B	USE.S	R	Number of segments within a pattern	The number of the segment is displayed when the program pattern number is specified in the parameter PTN.S. 0: Not registered 1 to 20 (40 when the option "/AP" is specified.)
D8974 to D8980						
D8981	2315	2314	CPY.S	R/W	Source-of-copying pattern number designation	Set the source-of-copying pattern number designation. 1 to 2 (4 when the option "/AP" is specified.)
D8982	2316	2315	CPY.D	R/W	Target-of-copying pattern number designation	Set the target-of-copying pattern number designation. 1 to 2 (4 when the option "/AP" is specified.)
D8983	2317	2316	PTC.TRG	R/W	Copy trigger	1: copy
D8984	2318	2317	PTN.ERR	R	Read/write error information	0: normal end Except 0: error (See "Error information" described later in this chapter.)
D8985 to D8990						
D8991	48991	231E	CLR.P	R/W	Program pattern clearance	Set the number of program pattern erase. 1 to 2 (4 when the option "/AP" is specified.)
D8992	48992	231F	CLR.TRG	R/W	Clearance trigger	1: clear
D8993	48993	2320	PTN.ERR	R	Read/write error information	0: normal end Except 0: error (See "Error information" described later in this chapter.)
D8994 to D9000						

■ Modbus communication

The example for the communication command is Modbus/RTU. For easy understanding, space is added but it is not present in the actual command. The device address is "1."

● How to check the number of segments used in one pattern

Example: Checking segment numbers used in pattern 1

- (1) Write pattern number "1" to D8971 (PTN.S).
- (2) Read from D8972 (USE.S).

```
(1) 01 10 230A 0001 02 0001 [CRC]
(2) 01 03 230B 0001 [CRC]
```

● How to copy pattern

Example: Copying patterns 1 to 2

- (1) Write "1" to D8981 (CPY.S: Source-of-copying pattern number designation), "2" to D8982 (CPY.D: Target-of-copying pattern number designation), and "1" to D8983 (PTC.TRG: Copy trigger).

If "PTN.ERR" in the response is other than zero, an error occurred. If zero, the write was successful.

```
(1) 01 46 2314 0003 06 0001 0002 0001 [CRC]
```

● How to clear pattern

Example: Clearing pattern 2

- (1) Write "2" to D8911 (CLR.P: Program pattern clearance) and "1" to D8992 (CLR.TRG: Clearance trigger).

If "PTN.ERR" in the response is other than zero, an error occurred. If zero, the write was successful.

```
(1) 01 46 231E 0002 04 0002 0001 [CRC]
```

■ PC link communication

The example for the communication command is a PC link without a checksum. The device address is "1."

● How to check the number of segments used in one pattern

Example: Checking segment numbers used in pattern 1

- (1) Write pattern number "1" to D8971 (PTN.S).
- (2) Read from D8972 (USE.S).

(1) 01010WWRD8971,01,0001
(2) 01010WRDD8972,01

● How to copy pattern

Example: Copying patterns 1 to 2

- (1) Write "1" to D8981 (COY.S: Source-of-copying pattern number designation), "2" to D8982 (COY.D: Target-of-copying pattern number designation), and "1" to D8983 (PTC.TRG: Copy trigger).
- (2) Read from D8984 (PTN.ERR).

If the result is other than zero, an error occurred. If zero, the read was successful.

(1) 01010WWRD8981,03,0001 0002 0001
(2) 01010WRDD8984,01

● How to clear pattern

Example: Clearing pattern 2

- (1) Write "2" to D8911 (CLR.P: Program pattern clearance) and "1" to D8992 (CLR.TRG: Clearance trigger).

If "PTN.ERR" in the response is other than zero, an error occurred. If zero, the write was successful.

- (2) Read from D8993 (PTN.ERR).

If the result is other than zero, an error occurred. If zero, the read was successful.

(1) 01010WWRD8991,02,0002 0001
(2) 01010WRDD8993,01

Error Information

The following table shows the Error Information for the register symbol "PTN.ERR".

Error code	Error information	Cause of error
0	No error	Normal end
1	Pattern creation or editing is disable during program operation.	Deleting or copying of the program pattern, or inserting or deleting of the segment was excuted during program operation.
2	Segment number error	The specified pattern number does not exist. 1 to 2 (4 when the option "/AP" is specified.)
3	Segment number error	The specified segment number does not exist. 1 to 20 (40 when the option "/AP" is specified.)
22	Segment write error	The total number of segments exceeded 20 (40 when the option "/AP" is specified.)
31	Pattern copy error	No pattern exists in the source, or patterns already exist in the destination.
41	Pattern delete error	The pattern to be deleted does not exist.

8.5 Writing via Communication

■ Setting Target Setpoint

In LCL (local) mode

- (1) Set the target setpoints of groups 1 to 4 parameters (SP_L1_1 to SP_L1_4).
- (2) Write the setpoint (1 to 4) in the SPNO. (SP number selection) (depends on the setup parameter SPGR. setting)
- (3) Set the operation mode (R.L_L1) to LCL (local) (0).

Register No.	Register symbol	Description
D2312	SPNO.	SP number selection

In REM (remote) mode (for UT35A/UT32A with communication)

- (1) Write the setpoint in the C.RSP_L1.
Example: When setting 150.0°C for the C.RSP_L1, write "1500" to this register.
- (2) Set the operation mode (R.L_L1) to the REM (remote) mode.

Register No.	Register symbol	Description
D2331	C.RSP_L1	Communication remote setpoint

■ Setting Control Output Value in MAN Mode

The control output value can be written via communication only when the operation mode is set to MAN mode.

- (1) Set the operation mode (A.M) to MAN (1).
- (2) Write the control output value in the MOUT_L1, MOUTc_L1.

Register No.	Register symbol	Description
D2333	MOUT_L1	Heating-side control output in MAN mode
D2334	MOUTc_L1	Cooling-side control output in MAN mode

■ Setting Manual Preset Output Number

The manual preset output number can be written via communication only when the operation mode is set to MAN mode.

- (1) Set the manual preset output 1 to 5 parameters (MPO1_L1 to MPO5_L1).
- (2) Write the setpoint (1 to 5) in the MPON_L1.
- (3) Set the operation mode (A.M) to MAN (1).

Register No.	Register symbol	Description
D3531	MPON_L1	Manual preset output number selection

■ Operating a Valve (for Position proportional type only)

Write a valve position in MOUT_L1 in MAN mode for position proportional PID computation.

■ Setting PID Number (D2503: PIDN_L1_1 to D2563: PIDN_L1_4)

PID number can be selected via communication only when the zone PID selection parameter (ZON) is set to 1, 2, or 4.

D2503 to D2563 = 1 to 4 (depends on the setup parameter SPGR. setting).

When the PID number is selected using the external contact input, the setting via communication is impossible.

8.6 GREEN Series Compatible D Registers

8.6.1 Compatibility with GREEN Series Controllers

The D register map configuration of the UTAdvanced is the same as that of the GREEN Series (UT300 Series) controllers that perform access in the 2-byte integer data format. When GREEN Series devices are replaced with the UTAdvanced, communication programs created in the GREEN Series controllers can be used by just carrying out wiring. If existing programs created in the GREEN Series controllers are used, communication is performed using the area from D0001 to D2000.

However, although the function allocation from D0001 to D1300 is the same as that of the GREEN Series (UT300 Series) controllers, the setting ranges and the function operation specifications of registers are subject to the specifications of the UTAdvanced.

Furthermore, the functions have been enhanced from the GREEN Series controllers, so the generic settings and functions for some registers have been changed. For the changed registers, see “8.6.11 D Registers Differing in Content from GREEN Series.”

The register map after D2001 is a D register map allocated for the UTAdvanced.

When you want to newly perform communication, be sure to use the registers after D2001.

8.6.2 Interpretation of D Register Tables

Register map (Categories)					
Register contents					
D-Reg No.	Ref. No.	H No.	Register symbol for GREEN	Register symbol for UTAdvanced	R/W
D0001	40001	0000	ADERROR	AD1.E_G *1	R
D0002	40002	0001	ERROR.1	PV1.E_L1_G *1	R
D0003	40003	0002	PV.1	PV_L1 (D2003)	
⋮	⋮	⋮	⋮	⋮	⋮
D0250	40250	00F9	ORB.1	 *3	R
⋮	⋮	⋮	⋮	⋮	⋮
D0310	40310	0135	1.OL	Depends on the conditions *4	R/W
⋮	⋮	⋮	⋮	⋮	⋮
D0915	40915	0392	AL1.1	AL1.T_L1 (D2801)*2	R/W

(1) D register numbers (2) Reference numbers (for Modbus communication) (3) Hexadecimal numbers (for Modbus communication) Numbers in parentheses indicate the same register after D2001. Read/write by communication
R: Read enabled
W: Write enabled

■ Interpretation of Cell

*1: AD1.E_G (with _G) indicates a D register converted for the GREEN Series.

Furthermore, PV1.E_L1_G (shaded cell) indicates that it differs in content from that of the GREEN Series.

See “8.6.10 D Registers Converted for GREEN Series” described later.

*2: DI00 (D7601) (shaded cell) indicates that it differs in content from that of the GREEN Series. See “8.6.11 D Registers Differing in Content from GREEN Series” described later.

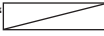
*3: A cell marked with a diagonal line (“”) indicates that it is not supported by the UTAdvanced.

*4: Depends on the conditions indicates that the D register varies depending on the setting condition of other parameters.

See “8.6.12 D Registers Differing Depending on Condition” described later.

8.6.3 Process Data and User Area (D0001 to D0100)

Configuration map for GREEN Series											
Process data						User area					
D-Reg No.	Ref. No.	H No.	Register symbol for GREEN	Register symbol for UTAdvanced	R/W	D-Reg No.	Ref. No.	H No.	Register symbol for GREEN	Register symbol for UTAdvanced	R/W
D0001	40001	0000	ADERROR	AD1.E_G	R	D0051	40051	0032	USER	USER1	R/W
D0002	40002	0001	ERROR	PV1.E_L1_G	R	D0052	40052	0033	USER	USER2	R/W
D0003	40003	0002	PV	PV_L1 (D2003)	R	D0053	40053	0034	USER	USER3	R/W
D0004	40004	0003	CSP	CSP_L1 (D2004)	R	D0054	40054	0035	USER	USER4	R/W
D0005	40005	0004	OUT	OUT_L1 (D2005)	R	D0055	40055	0036	USER	USER5	R/W
D0006	40006	0005	HOUT (Note 1)	H.OUT_L1 (D2006)	R	D0056	40056	0037	USER	USER6	R/W
D0007	40007	0006	COOUT (Note 1)	C.OUT_L1 (D2007)	R	D0057	40057	0038	USER	USER7	R/W
D0008	40008	0007	MOD	MOD_L1_G	R	D0058	40058	0039	USER	USER8	R/W
D0009	40009	0008	PIDNO	PID_L1 (D2009)	R	D0059	40059	003A	USER	USER9	R/W
D0010	40010	0009	CSPNO	CSPNO. (D2010)	R	D0060	40060	003B	USER	USER10	R/W
D0011	40011	000A	ALM	ALM_G	R	D0061	40061	003C	USER	USER11	R/W
D0012	40012	000B	PVEV (Note 2)	PV_EV (D2039)	R	D0062	40062	003D	USER	USER12	R/W
D0013	40013	000C	TMEV1 (Note 2)	TIME_EV_1 (D2040)	R	D0063	40063	003E	USER	USER13	R/W
D0014	40014	000D				D0064	40064	003F	USER	USER14	R/W
D0015	40015	000E				D0065	40065	0040	USER	USER15	R/W
D0016	40016	000F	SEGNO (Note 2)	SEG.N (D2016)	R	D0066	40066	0041	USER	USER16	R/W
D0017	40017	0010	TIME (Note 2)	SEG_RUNTIME (D2017)	R	D0067	40067	0042	USER	USER17	R/W
D0018	40018	0011				D0068	40068	0043	USER	USER18	R/W
D0019	40019	0012				D0069	40069	0044	USER	USER19	R/W
D0020	40020	0013				D0070	40070	0045	USER	USER20	R/W
D0021	40021	0014				D0071	40071	0046	USER	USER21	R/W
D0022	40022	0015				D0072	40072	0047	USER	USER22	R/W
D0023	40023	0016				D0073	40073	0048	USER	USER23	R/W
D0024	40024	0017				D0074	40074	0049	USER	USER24	R/W
D0025	40025	0018				D0075	40075	004A	USER	USER25	R/W
D0026	40026	0019				D0076	40076	004B	USER	USER26	R/W
D0027	40027	001A	OR		R	D0077	40077	004C	USER	USER27	R/W
D0028	40028	001B	HC1 (Note 1)	HC1 (D2061)	R	D0078	40078	004D	USER	USER28	R/W
D0029	40029	001C	HC2 (Note 1)	HC2 (D2062)	R	D0079	40079	004E	USER	USER29	R/W
D0030	40030	001D				D0080	40080	004F	USER	USER30	R/W
D0031	40031	001E				D0081	40081	0050	USER	USER31	R/W
D0032	40032	001F				D0082	40082	0051	USER	USER32	R/W
D0033	40033	0020				D0083	40083	0052	USER	USER33	R/W
D0034	40034	0021				D0084	40084	0053	USER	USER34	R/W
D0035	40035	0022	PARAERR	PA.ER_G	R	D0085	40085	0054	USER	USER35	R/W
D0036	40036	0023				D0086	40086	0055	USER	USER36	R/W
D0037	40037	0024				D0087	40087	0056	USER	USER37	R/W
D0038	40038	0025				D0088	40088	0057	USER	USER38	R/W
D0039	40039	0026				D0089	40089	0058	USER	USER39	R/W
D0040	40040	0027				D0090	40090	0059	USER	USER40	R/W
D0041	40041	0028				D0091	40091	005A	USER	USER41	R/W
D0042	40042	0029				D0092	40092	005B	USER	USER42	R/W
D0043	40043	002A				D0093	40093	005C	USER	USER43	R/W
D0044	40044	002B				D0094	40094	005D	USER	USER44	R/W
D0045	40045	002C				D0095	40095	005E	USER	USER45	R/W
D0046	40046	002D				D0096	40096	005F	USER	USER46	R/W
D0047	40047	002E				D0097	40097	0060	USER	USER47	R/W
D0048	40048	002F				D0098	40098	0061	USER	USER48	R/W
D0049	40049	0030				D0099	40099	0062	USER	USER49	R/W
D0050	40050	0031	USER	USER0	R/W	D0100	40100	0063	USER	USER50	R/W

(Note 1): Not for UP330 series.

(Note 2): For UP300 series

8.6 GREEN Series Compatible D Registers

Configuration map for GREEN Series											
Can not be used											
D-Reg No.	Ref. No.	H No.	Register symbol for GREEN	Register symbol for UTAdvanced	R/W	D-Reg No.	Ref. No.	H No.	Register symbol for GREEN	Register symbol for UTAdvanced	R/W
D0101	40101	0064				D0151	40151	0096	1.SP7		R/W
D0102	40102	0065				D0152	40152	0097	1.TM7		R/W
D0103	40103	0066				D0153	40153	0098	1.SP8		R/W
D0104	40104	0067				D0154	40154	0099	1.TM8		R/W
D0105	40105	0068				D0155	40155	009A	1.SP9		R/W
D0106	40106	0069				D0156	40156	009B	1.TM9		R/W
D0107	40107	006A				D0157	40157	009C	1.SPA		R/W
D0108	40108	006B				D0158	40158	009D	1.TMA		R/W
D0109	40109	006C				D0159	40159	009E	1.JC		R/W
D0110	40110	006D				D0160	40160	009F			
D0111	40111	006E				D0161	40161	00A0	2.AL1		R/W
D0112	40112	006F				D0162	40162	00A1	2.A1		R/W
D0113	40113	0070				D0163	40163	00A2	2.AL2		R/W
D0114	40114	0071				D0164	40164	00A3	2.A2		R/W
D0115	40115	0072				D0165	40165	00A4	2.EON		R/W
D0116	40116	0073				D0166	40166	00A5	2.EOF		R/W
D0117	40117	0074				D0167	40167	00A6	2.SSP		R/W
D0118	40118	0075				D0168	40168	00A7	2.STC		R/W
D0119	40119	0076				D0169	40169	00A8	2.SP1		R/W
D0120	40120	0077				D0170	40170	00A9	2.TM1		R/W
D0121	40121	0078				D0171	40171	00AA	2.SP2		R/W
D0122	40122	0079				D0172	40172	00AB	2.TM2		R/W
D0123	40123	007A				D0173	40173	00AC	2.SP3		R/W
D0124	40124	007B				D0174	40174	00AD	2.TM3		R/W
D0125	40125	007C				D0175	40175	00AE	2.SP4		R/W
D0126	40126	007D				D0176	40176	00AF	2.TM4		R/W
D0127	40127	007E				D0177	40177	00B0	2.SP5		R/W
D0128	40128	007F				D0178	40178	00B1	2.TM5		R/W
D0129	40129	0080				D0179	40179	00B2	2.SP6		R/W
D0130	40130	0081				D0180	40180	00B3	2.TM6		R/W
D0131	40131	0082	1.AL1		R/W	D0181	40181	00B4	2.SP7		R/W
D0132	40132	0083	1.A1		R/W	D0182	40182	00B5	2.TM7		R/W
D0133	40133	0084	1.AL2		R/W	D0183	40183	00B6	2.SP8		R/W
D0134	40134	0085	1.A2		R/W	D0184	40184	00B7	2.TM8		R/W
D0135	40135	0086	1.EON		R/W	D0185	40185	00B8	2.SP9		R/W
D0136	40136	0087	1.EOF		R/W	D0186	40186	00B9	2.TM9		R/W
D0137	40137	0088	1.SSP		R/W	D0187	40187	00BA	2.SPA		R/W
D0138	40138	0089	1.STC		R/W	D0188	40188	00BB	2.TMA		R/W
D0139	40139	008A	1.SP1		R/W	D0189	40189	00BC	2.JC		R/W
D0140	40140	008B	1.TM1		R/W	D0190	40190	00BD			
D0141	40141	008C	1.SP2		R/W	D0191	40191	00BE			
D0142	40142	008D	1.TM2		R/W	D0192	40192	00BF			
D0143	40143	008E	1.SP3		R/W	D0193	40193	00C0			
D0144	40144	008F	1.TM3		R/W	D0194	40194	00C1			
D0145	40145	0090	1.SP4		R/W	D0195	40195	00C2			
D0146	40146	0091	1.TM4		R/W	D0196	40196	00C3			
D0147	40147	0092	1.SP5		R/W	D0197	40197	00C4			
D0148	40148	0093	1.TM5		R/W	D0198	40198	00C5			
D0149	40149	0094	1.SP6		R/W	D0199	40199	00C6			
D0150	40150	0095	1.TM6		R/W	D0200	40200	00C7			

Note: D0101 to D0200; for UP300 series

8.6.4 Operation Mode and Operation-related Parameters (D0201 to D0300)

Configuration map for GREEN Series											
Operation mode / Operation-related parameters											
D-Reg No.	Ref. No.	H No.	Register symbol for GREEN	Register symbol for UTAdvanced	R/W	D-Reg No.	Ref. No.	H No.	Register symbol for GREEN	Register symbol for UTAdvanced	R/W
D0201	40201	00C8	A/M (Note 2)	A.M (D2301)	R/W	D0251	40251	00FA	ORH		R
D0202	40202	00C9				D0252	40252	00FB	ORL		R
D0203	40203	00CA				D0253	40253	00FC			
D0204	40204	00CB				D0254	40254	00FD	OH	OH_G	R/W
D0205	40205	00CC	S/R (Note 2)	S.R (D2304)	R/W	D0255	40255	00FE	OL	OL_G	R/W
D0206	40206	00CD				D0256	40256	00FF	HYS	HYS_G	R/W
D0207	40207	00CE	SPNO (Note 2)	SPNO. (D2312)	R/W	D0257	40257	0100	DR	DR_G	R/W
D0208	40208	00CF	R/P1/P2 (Note 3)	MODE (2316)	R/W	D0258	40258	0101	HB1 (Note 2)	HB1 (D5403)	R/W
D0209	40209	00D0	HOLD (Note 3)	HOLD (D2317)	R/W	D0259	40259	0102	HB2 (Note 2)	HB2 (D5404)	R/W
D0210	40210	00D1	ADV (Note 3)	ADV (D2318)	R/W	D0260	40260	0103	WIT.Z		R
D0211	40211	00D2				D0261	40261	0104	WIT.T		R
D0212	40212	00D3				D0262	40262	0105			
D0213	40213	00D4				D0263	40263	0106			
D0214	40214	00D5				D0264	40264	0107			
D0215	40215	00D6	C.RSP (Note 2)	C.RSP_L1 (D2331)	R/W	D0265	40265	0108			
D0216	40216	00D7				D0266	40266	0109			
D0217	40217	00D8	MOUT (Note 2)	MOUT_L1 (D2333)	R/W	D0267	40267	010A			
D0218	40218	00D9	MOUTc (Note 2)	MOUc_L1 (D2334)	R/W	D0268	40268	010B			
D0219	40219	00DA				D0269	40269	010C			
D0220	40220	00DB				D0270	40270	010D			
D0221	40221	00DC	HOLDSP (Note 3)	H.SP_L1 (D2337)	R/W	D0271	40271	010E			
D0222	40222	00DD				D0272	40272	010F			
D0223	40223	00DE	HOLDTM (Note 3)	H.TM (D2341)	R/W	D0273	40273	0110			
D0224	40224	00DF				D0274	40274	0111			
D0225	40225	00E0				D0275	40275	0112			
D0226	40226	00E1				D0276	40276	0113			
D0227	40227	00E2				D0277	40277	0114			
D0228	40228	00E3				D0278	40278	0115			
D0229	40229	00E4				D0279	40279	0116			
D0230	40230	00E5				D0280	40280	0117			
D0231	40231	00E6	A1 (Note 2)	A1_G	R/W	D0281	40281	0118			
D0232	40232	00E7	A2 (Note 2)	A2_G	R/W	D0282	40282	0119			
D0233	40233	00E8	A3 (Note 2)	A3_G	R/W	D0283	40283	011A			
D0234	40234	00E9				D0284	40284	011B			
D0235	40235	00EA				D0285	40285	011C			
D0236	40236	00EB				D0286	40286	011D			
D0237	40237	00EC	PCCH (Note 1)	PCH_L1 (D5714)	R/W	D0287	40287	011E			
D0238	40238	00ED	PCCL (Note 1)	PCL_L1 (D5715)	R/W	D0288	40288	011F			
D0239	40239	00EE				D0289	40289	0120			
D0240	40240	00EF				D0290	40290	0121			
D0241	40241	00F0	AT	AT_L1 (D2308)	R/W	D0291	40291	0122			
D0242	40242	00F1	SC	SC_L1 (D3501)	R/W	D0292	40292	0123			
D0243	40243	00F2	BS	BS_L1 (D2901)	R/W	D0293	40293	0124			
D0244	40244	00F3	FL	FL_L1 (D2902)	R/W	D0294	40294	0125			
D0245	40245	00F4	UPR (Note 2)	UPR_L1 (D2705)	R/W	D0295	40295	0126			
D0246	40246	00F5	DNR (Note 2)	DNR_L1 (D2706)	R/W	D0296	40296	0127			
D0247	40247	00F6				D0297	40297	0128			
D0248	40248	00F7				D0298	40298	0129			
D0249	40249	00F8				D0299	40299	012A			
D0250	40250	00F9	ORB		R	D0300	40300	012B			

Note 1: Parameters PCCH and PCCL are used for UT351/UT321/UP351 only.

(Note 2): Not for UP330 series.

(Note 3): For UP300 series

(Note 4): When UP300 series, see the 8.6.12 D Registers Differing Depending on Conditions

8.6 GREEN Series Compatible D Registers

8.6.5 PID Parameters (D0301 to D0500)

Configuration map for GREEN Series											
SP / AL / PID parameters											
D-Reg No.	Ref. No.	H No.	Register symbol for GREEN	Register symbol for UTAdvanced	R/W	D-Reg No.	Ref. No.	H No.	Register symbol for GREEN	Register symbol for UTAdvanced	R/W
D0301	40301	012C	1.SP (Note 1)	SP_L1_1 (D2501)	R/W	D0351	40351	015E	3.SP (Note 1)	SP_L1_3 (D2541)	R/W
D0302	40302	012D				D0352	40352	015F			
D0303	40303	012E				D0353	40353	0160			
D0304	40304	012F				D0354	40354	0161			
D0305	40305	0130				D0355	40355	0162			
D0306	40306	0131	1.P	P_L1_1 (D3001)	R/W	D0356	40356	0163	3.P	P_L1_3 (D3101)	R/W
D0307	40307	0132	1.I	I_L1_1 (D3002)	R/W	D0357	40357	0164	3.I	I_L1_3 (D3102)	R/W
D0308	40308	0133	1.D	D_L1_1 (D3003)	R/W	D0358	40358	0165	3.D	D_L1_3 (D3103)	R/W
D0309	40309	0134				D0359	40359	0166			
D0310	40310	0135				D0360	40360	0167			
D0311	40311	0136	1.MR	MR_L1_1 (D3006)	R/W	D0361	40361	0168	3.MR	MR_L1_3 (D3106)	R/W
D0312	40312	0137				D0362	40362	0169			
D0313	40313	0138				D0363	40363	016A			
D0314	40314	0139	1.Pc (Note 1)	Pc_L1_1 (D3013)	R/W	D0364	40364	016B	3.Pc (Note 1)	Pc_L1_3 (D3113)	R/W
D0315	40315	013A	1.lc (Note 1)	lc_L1_1 (D3014)	R/W	D0365	40365	016C	3.lc (Note 1)	lc_L1_3 (D3114)	R/W
D0316	40316	013B	1.Dc (Note 1)	Dc_L1_1 (D3015)	R/W	D0366	40366	016D	3.Dc (Note 1)	Dc_L1_3 (D3115)	R/W
D0317	40317	013C				D0367	40367	016E			
D0318	40318	013D	1.DB (Note 1)	DB_L1_1 (D3019)	R/W	D0368	40368	016F	3.DB (Note 1)	DB_L1_3 (D3119)	R/W
D0319	40319	013E	1.RP	RP1_L1 (D3551)	R/W	D0369	40369	0170			
D0320	40320	013F				D0370	40370	0171			
D0321	40321	0140				D0371	40371	0172			
D0322	40322	0141				D0372	40372	0173			
D0323	40323	0142				D0373	40373	0174			
D0324	40324	0143				D0374	40374	0175			
D0325	40325	0144				D0375	40375	0176			
D0326	40326	0145	2.SP (Note 1)	SP_L1_2 (D2521)	R/W	D0376	40376	0177	4.SP (Note 1)	SP_L1_4 (D2561)	R/W
D0327	40327	0146				D0377	40377	0178			
D0328	40328	0147				D0378	40378	0179			
D0329	40329	0148				D0379	40379	017A			
D0330	40330	0149				D0380	40380	017B			
D0331	40331	014A	2.P	P_L1_2 (D3051)	R/W	D0381	40381	017C	4.P	P_L1_4 (D3151)	R/W
D0332	40332	014B	2.I	I_L1_2 (D3052)	R/W	D0382	40382	017D	4.I	I_L1_4 (D3152)	R/W
D0333	40333	014C	2.D	D_L1_2 (D3053)	R/W	D0383	40383	017E	4.D	D_L1_4 (D3153)	R/W
D0334	40334	014D				D0384	40384	017F			
D0335	40335	014E				D0385	40385	0180			
D0336	40336	014F	2.MR	MR_L1_2 (D3056)	R/W	D0386	40386	0181	4.MR	MR_L1_4 (D3156)	R/W
D0337	40337	0150				D0387	40387	0182			
D0338	40338	0151				D0388	40388	0183			
D0339	40339	0152	2.Pc (Note 1)	Pc_L1_2 (D3063)	R/W	D0389	40389	0184	4.Pc (Note 1)	Pc_L1_4 (D3163)	R/W
D0340	40340	0153	2.lc (Note 1)	lc_L1_2 (D3064)	R/W	D0390	40390	0185	4.lc (Note 1)	lc_L1_4 (D3164)	R/W
D0341	40341	0154	2.Dc (Note 1)	Dc_L1_2 (3065)	R/W	D0391	40391	0186	4.Dc (Note 1)	Dc_L1_4 (D3165)	R/W
D0342	40342	0155				D0392	40392	0187			
D0343	40343	0156	2.DB (Note 1)	DB_L1_2 (D3069)	R/W	D0393	40393	0188	4.DB (Note 1)	DB_L1_4 (D3169)	R/W
D0344	40344	0157	2.RP	RP2_L1 (D3552)	R/W	D0394	40394	0189			
D0345	40345	0158				D0395	40395	018A			
D0346	40346	0159				D0396	40396	018B			
D0347	40347	015A				D0397	40397	018C			
D0348	40348	015B				D0398	40398	018D			
D0349	40349	015C				D0399	40399	018E			
D0350	40350	015D				D0400	40400	018F			

(Note 1): Not for UP330 series.

8.6 GREEN Series Compatible D Registers

Configuration map for GREEN Series											
SP / AL / PID parameters											
D-Reg No.	Ref. No.	H No.	Register symbol for GREEN	Register symbol for UTAdvanced	R/W	D-Reg No.	Ref. No.	H No.	Register symbol for GREEN	Register symbol for UTAdvanced	R/W
D0401	40401	0190				D0451	40451	01C2			
D0402	40402	0191				D0452	40452	01C3			
D0403	40403	0192				D0453	40453	01C4			
D0404	40404	0193				D0454	40454	01C5			
D0405	40405	0194				D0455	40455	01C6			
D0406	40406	0195				D0456	40456	01C7			
D0407	40407	0196				D0457	40457	01C8			
D0408	40408	0197				D0458	40458	01C9			
D0409	40409	0198				D0459	40459	01CA			
D0410	40410	0199				D0460	40460	01CB			
D0411	40411	019A				D0461	40461	01CC			
D0412	40412	019B				D0462	40462	01CD			
D0413	40413	019C				D0463	40463	01CE			
D0414	40414	019D				D0464	40464	01CF			
D0415	40415	019E				D0465	40465	01D0			
D0416	40416	019F				D0466	40466	01D1			
D0417	40417	01A0				D0467	40467	01D2			
D0418	40418	01A1				D0468	40468	01D3			
D0419	40419	01A2				D0469	40469	01D4			
D0420	40420	01A3				D0470	40470	01D5			
D0421	40421	01A4				D0471	40471	01D6			
D0422	40422	01A5				D0472	40472	01D7			
D0423	40423	01A6				D0473	40473	01D8			
D0424	40424	01A7				D0474	40474	01D9			
D0425	40425	01A8				D0475	40475	01DA			
D0426	40426	01A9				D0476	40476	01DB			
D0427	40427	01AA				D0477	40477	01DC			
D0428	40428	01AB				D0478	40478	01DD			
D0429	40429	01AC				D0479	40479	01DE			
D0430	40430	01AD				D0480	40480	01DF			
D0431	40431	01AE				D0481	40481	01E0			
D0432	40432	01AF				D0482	40482	01E1			
D0433	40433	01B0				D0483	40483	01E2			
D0434	40434	01B1				D0484	40484	01E3			
D0435	40435	01B2				D0485	40485	01E4			
D0436	40436	01B3				D0486	40486	01E5			
D0437	40437	01B4				D0487	40487	01E6			
D0438	40438	01B5				D0488	40488	01E7			
D0439	40439	01B6				D0489	40489	01E8			
D0440	40440	01B7				D0490	40490	01E9			
D0441	40441	01B8				D0491	40491	01EA			
D0442	40442	01B9				D0492	40492	01EB			
D0443	40443	01BA				D0493	40493	01EC			
D0444	40444	01BB				D0494	40494	01ED	RDV	RDV_L1 (D3559)	R/W
D0445	40445	01BC				D0495	40495	01EE			
D0446	40446	01BD				D0496	40496	01EF			
D0447	40447	01BE				D0497	40497	01F0			
D0448	40448	01BF				D0498	40498	01F1			
D0449	40449	01C0				D0499	40499	01F2			
D0450	40450	01C1				D0500	40500	01F3			

D0501 to D0900: Free area

8.6 GREEN Series Compatible D Registers

8.6.6 Control Action Parameters (D0901 to D1000)

Configuration map for GREEN Series											
Control action parameters											
D-Reg No.	Ref. No.	H No.	Register symbol for GREEN	Register symbol for UTAdvanced	R/W	D-Reg No.	Ref. No.	H No.	Register symbol for GREEN	Register symbol for UTAdvanced	R/W
D0901	40901	0384				D0951	40951	03B6			
D0902	40902	0385				D0952	40952	03B7			
D0903	40903	0386				D0953	40953	03B8			
D0904	40904	0387	TMU	TMU_L1 (D2707) (Note 3)	R/W	D0954	40954	03B9			
D0905	40905	0388	SEG.T (Note 2)	SEG.T (D5016)	R/W	D0955	40955	03BA			
D0906	40906	0389				D0956	40956	03BB			
D0907	40907	038A				D0957	40957	03BC			
D0908	40908	038B				D0958	40958	03BD			
D0909	40909	038C				D0959	40959	03BE			
D0910	40910	038D				D0960	40960	03BF			
D0911	40911	038E				D0961	40961	03C0			
D0912	40912	038F				D0962	40962	03C1			
D0913	40913	0390				D0963	40963	03C2			
D0914	40914	0391				D0964	40964	03C3			
D0915	40915	0392	AL1 (Note 1)	AL1.T_L1 (D2801)	R/W	D0965	40965	03C4			
D0916	40916	0393	AL2 (Note 1)	AL2.T_L1 (D2805)	R/W	D0966	40966	03C5			
D0917	40917	0394	AL3 (Note 1)	AL3.T_L1 (D2809)	R/W	D0967	40967	03C6			
D0918	40918	0395				D0968	40968	03C7			
D0919	40919	0396	HY1	HY1_L1 (D2841)	R/W	D0969	40969	03C8			
D0920	40920	0397	HY2	HY2_L1 (D2842)	R/W	D0970	40970	03C9			
D0921	40921	0398	HY3 (Note 1)	HY3_L1 (D2843)	R/W	D0971	40971	03CA			
D0922	40922	0399				D0972	40972	03CB			
D0923	40923	039A				D0973	40973	03CC			
D0924	40924	039B	PO	PO_G	R/W	D0974	40974	03CD			
D0925	40925	039C	POc	POc_G	R/W	D0975	40975	03CE			
D0926	40926	039D				D0976	40976	03CF			
D0927	40927	039E	C.MD	ALG_L1 (D5005)	R/W	D0977	40977	03D0			
D0928	40928	039F	AR	AR_L1 (D3526)	R/W	D0978	40978	03D1			
D0929	40929	03A0	ZON (Note 1)	ZON (D5012)	R/W	D0979	40979	03D2			
D0930	40930	03A1				D0980	40980	03D3			
D0931	40931	03A2				D0981	40981	03D4			
D0932	40932	03A3	DIS		R/W	D0982	40982	03D5			
D0933	40933	03A4	SPH (Note 1)	SPH_L1 (D5210)	R/W	D0983	40983	03D6			
D0934	40934	03A5	SPL (Note 1)	SPL_L1 (D5211)	R/W	D0984	40984	03D7			
D0935	40935	03A6	DY1 (Note 1)	DYN1_L1 (D2849)	R/W	D0985	40985	03D8			
D0936	40936	03A7	DY2 (Note 1)	DYN2_L1 (D2850)	R/W	D0986	40986	03D9			
D0937	40937	03A8	DY3 (Note 1)	DYN3_L1 (D2851)	R/W	D0987	40987	03DA			
D0938	40938	03A9				D0988	40988	03DB			
D0939	40939	03AA				D0989	40989	03DC			
D0940	40940	03AB				D0990	40990	03DD			
D0941	40941	03AC				D0991	40991	03DE			
D0942	40942	03AD				D0992	40992	03DF			
D0943	40943	03AE				D0993	40993	03E0			
D0944	40944	03AF				D0994	40994	03E1			
D0945	40945	03B0				D0995	40995	03E2			
D0946	40946	03B1				D0996	40996	03E3			
D0947	40947	03B2				D0997	40997	03E4			
D0948	40948	03B3				D0998	40998	03E5			
D0949	40949	03B4				D0999	40999	03E6			
D0950	40950	03B5				D1000	41000	03E7			

(Note1): Not for UP300 series.

(Note2): For UP300 series.

(Note 3): Note that for the UP300 series, the resister symbols for UTAdvanced are "TMU (D5017)."

8.6.7 Common Function Parameters (D1001 to D1100)

Configuration map for GREEN Series											
Common function parameters											
D-Reg No.	Ref. No.	H No.	Register symbol for GREEN	Register symbol for UTAdvanced	R/W	D-Reg No.	Ref. No.	H No.	Register symbol for GREEN	Register symbol for UTAdvanced	R/W
D1001	41001	03E8				D1051	41051	041A			
D1002	41002	03E9				D1052	41052	041B			
D1003	41003	03EA				D1053	41053	041C			
D1004	41004	03EB				D1054	41054	041D			
D1005	41005	03EC				D1055	41055	041E			
D1006	41006	03ED				D1056	41056	041F			
D1007	41007	03EE				D1057	41057	0420			
D1008	41008	03EF				D1058	41058	0421			
D1009	41009	03F0				D1059	41059	0422			
D1010	41010	03F1				D1060	41060	0423			
D1011	41011	03F2				D1061	41061	0424			
D1012	41012	03F3				D1062	41062	0425			
D1013	41013	03F4	RET	RTS (D5321)	R/W	D1063	41063	0426			
D1014	41014	03F5	RTH	RTH (D5322)	R/W	D1064	41064	0427			
D1015	41015	03F6	RTL	RTL (D5323)	R/W	D1065	41065	0428			
D1016	41016	03F7				D1066	41066	0429			
D1017	41017	03F8				D1067	41067	042A			
D1018	41018	03F9				D1068	41068	042B			
D1019	41019	03FA				D1069	41069	042C			
D1020	41020	03FB				D1070	41070	042D			
D1021	41021	03FC				D1071	41071	042E			
D1022	41022	03FD				D1072	41072	042F			
D1023	41023	03FE				D1073	41073	0430			
D1024	41024	03FF				D1074	41074	0431			
D1025	41025	0400				D1075	41075	0432			
D1026	41026	0401				D1076	41076	0433			
D1027	41027	0402				D1077	41077	0434			
D1028	41028	0403				D1078	41078	0435			
D1029	41029	0404				D1079	41079	0436			
D1030	41030	0405				D1080	41080	0437			
D1031	41031	0406				D1081	41081	0438			
D1032	41032	0407				D1082	41082	0439			
D1033	41033	0408				D1083	41083	043A			
D1034	41034	0409				D1084	41084	043B			
D1035	41035	040A				D1085	41085	043C			
D1036	41036	040B	LOCK		R	D1086	41086	043D			
D1037	41037	040C	PCMD	PCMD_L1 (D5713)	R/W	D1087	41087	043E			
D1038	41038	040D	ERJC	ERJC (D5111)	R/W	D1088	41088	043F			
D1039	41039	040E				D1089	41089	0440			
D1040	41040	040F				D1090	41090	0441			
D1041	41041	0410				D1091	41091	0442			
D1042	41042	0411				D1092	41092	0443			
D1043	41043	0412				D1093	41093	0444			
D1044	41044	0413				D1094	41094	0445			
D1045	41045	0414				D1095	41095	0446			
D1046	41046	0415				D1096	41096	0447			
D1047	41047	0416				D1097	41097	0448			
D1048	41048	0417				D1098	41098	0449			
D1049	41049	0418				D1099	41099	044A			
D1050	41050	0419				D1100	41100	044B			

8.6 GREEN Series Compatible D Registers

8.6.8 Display and Input / Output Parameters (D1101 to D1200)

Configuration map for GREEN Series											
Display and input / Output parameters											
D-Reg No.	Ref. No.	H No.	Register symbol for GREEN	Register symbol for UTAdvanced	R/W	D-Reg No.	Ref. No.	H No.	Register symbol for GREEN	Register symbol for UTAdvanced	R/W
D1101	41101	044C	C.S1		R/W	D1151	41151	047E			
D1102	41102	044D	C.S2		R/W	D1152	41152	047F			
D1103	41103	044E	C.S3		R/W	D1153	41153	0480			
D1104	41104	044F	C.S4		R/W	D1154	41154	0481			
D1105	41105	0450				D1155	41155	0482			
D1106	41106	0451				D1156	41156	0483			
D1107	41107	0452				D1157	41157	0484			
D1108	41108	0453				D1158	41158	0485			
D1109	41109	0454				D1159	41159	0486			
D1110	41110	0455				D1160	41160	0487			
D1111	41111	0456				D1161	41161	0488			
D1112	41112	0457				D1162	41162	0489			
D1113	41113	0458				D1163	41163	048A			
D1114	41114	0459				D1164	41164	048B			
D1115	41115	045A				D1165	41165	048C			
D1116	41116	045B				D1166	41166	048D			
D1117	41117	045C				D1167	41167	048E			
D1118	41118	045D				D1168	41168	048F			
D1119	41119	045E				D1169	41169	0490			
D1120	41120	045F				D1170	41170	0491			
D1121	41121	0460				D1171	41171	0492			
D1122	41122	0461				D1172	41172	0493			
D1123	41123	0462				D1173	41173	0494			
D1124	41124	0463				D1174	41174	0495			
D1125	41125	0464				D1175	41175	0496			
D1126	41126	0465				D1176	41176	0497			
D1127	41127	0466				D1177	41177	0498			
D1128	41128	0467				D1178	41178	0499			
D1129	41129	0468				D1179	41179	049A			
D1130	41130	0469				D1180	41180	049B			
D1131	41131	046A				D1181	41181	049C			
D1132	41132	046B				D1182	41182	049D			
D1133	41133	046C				D1183	41183	049E			
D1134	41134	046D				D1184	41184	049F			
D1135	41135	046E				D1185	41185	04A0			
D1136	41136	046F				D1186	41186	04A1			
D1137	41137	0470				D1187	41187	04A2			
D1138	41138	0471				D1188	41188	04A3			
D1139	41139	0472				D1189	41189	04A4			
D1140	41140	0473				D1190	41190	04A5			
D1141	41141	0474				D1191	41191	04A6			
D1142	41142	0475				D1192	41192	04A7			
D1143	41143	0476				D1193	41193	04A8			
D1144	41144	0477				D1194	41194	04A9			
D1145	41145	0478				D1195	41195	04AA			
D1146	41146	0479				D1196	41196	04AB			
D1147	41147	047A				D1197	41197	04AC			
D1148	41148	047B				D1198	41198	04AD			
D1149	41149	047C				D1199	41199	04AE			
D1150	41150	047D				D1200	41200	04AF			

8.6.9 Control Mode, PV Input, and Control Output Parameters (D1201 to D1300)

Configuration map for GREEN Series											
Control mmode, PV input, and Control output parameters											
D-Reg No.	Ref. No.	H No.	Register symbol for GREEN	Register symbol for UTAdvanced	R/W	D-Reg No.	Ref. No.	H No.	Register symbol for GREEN	Register symbol for UTAdvanced	R/W
D1201	41201	04B0	IN	IN (D5101)	R/W	D1251	41251	04E2	DLN	Depends on the conditions	R/W
D1202	41202	04B1	UNI	UNI (D5102)	R/W	D1252	41252	04E3	ADR	Depends on the conditions	R/W
D1203	41203	04B2				D1253	41253	04E4	RP.T	Depends on the conditions	R/W
D1204	41204	04B3	RH	RH (D5104)	R/W	D1254	41254	04E5			
D1205	41205	04B4	RL	RL (D5105)	R/W	D1255	41255	04E6			
D1206	41206	04B5	SDP	SDP (D5106)	R/W	D1256	41256	04E7			
D1207	41207	04B6	SH	SH (D5107)	R/W	D1257	41257	04E8			
D1208	41208	04B7	SL	SL (D5108)	R/W	D1258	41258	04E9			
D1209	41209	04B8	BSL	BSL (D5109)	R/W	D1259	41259	04EA			
D1210	41210	04B9	RJC	RJC (D5110)	R/W	D1260	41260	04EB			
D1211	41211	04BA				D1261	41261	04EC			
D1212	41212	04BB				D1262	41262	04ED			
D1213	41213	04BC				D1263	41263	04EE			
D1214	41214	04BD				D1264	41264	04EF			
D1215	41215	04BE				D1265	41265	04F0			
D1216	41216	04BF				D1266	41266	04F1			
D1217	41217	04C0				D1267	41267	04F2			
D1218	41218	04C1				D1268	41268	04F3			
D1219	41219	04C2				D1269	41269	04F4			
D1220	41220	04C3				D1270	41270	04F5			
D1221	41221	04C4				D1271	41271	04F6			
D1222	41222	04C5				D1272	41272	04F7			
D1223	41223	04C6				D1273	41273	04F8			
D1224	41224	04C7				D1274	41274	04F9			
D1225	41225	04C8				D1275	41275	04FA			
D1226	41226	04C9				D1276	41276	04FB			
D1227	41227	04CA				D1277	41277	04FC			
D1228	41228	04CB				D1278	41278	04FD			
D1229	41229	04CC				D1279	41279	04FE			
D1230	41230	04CD				D1280	41280	04FF			
D1231	41231	04CE				D1281	41281	0500			
D1232	41232	04CF				D1282	41282	0501			
D1233	41233	04D0				D1283	41283	0502			
D1234	41234	04D1				D1284	41284	0503			
D1235	41235	04D2				D1285	41285	0504			
D1236	41236	04D3				D1286	41286	0505			
D1237	41237	04D4				D1287	41287	0506			
D1238	41238	04D5	OT		R	D1288	41288	0507			
D1239	41239	04D6				D1289	41289	0508			
D1240	41240	04D7	CT	CT (D5303)	R/W	D1290	41290	0509			
D1241	41241	04D8				D1291	41291	050A			
D1242	41242	04D9	CTc (Note 1)	CTc (D5304)	R/W	D1292	41292	050B			
D1243	41243	04DA				D1293	41293	050C			
D1244	41244	04DB				D1294	41294	050D			
D1245	41245	04DC				D1295	41295	050E			
D1246	41246	04DD				D1296	41296	050F			
D1247	41247	04DE	PSL	Depends on the conditions	R/W	D1297	41297	0510			
D1248	41248	04DF	BPS	Depends on the conditions	R/W	D1298	41298	0511			
D1249	41249	04E0	PRI	Depends on the conditions	R/W	D1299	41299	0512			
D1250	41250	04E1	STP	Depends on the conditions	R/W	D1300	41300	0513			

(Note1): Not for UP330 series.

D1301 to D2000: Free area

8.6 GREEN Series Compatible D Registers

8.6.10 D Registers Converted for GREEN Series

● **Bit Configuration of D0001: AD1.E_G (A/D converter error status for GREEN Series)**

Bit	Symbol		Event
	GREEN Series	UTAdvanced	
0	ADERR.st	ADERR (I4065)	PV input A/D converter error
1 to 15			

● **Bit Configuration of D0002: PV1.E_L1_G (PV input error status for GREEN Series)**

Bit	Symbol		Event
	GREEN Series	UTAdvanced	
0			
1	PVBO.st	PVBO_L1 (I4097)	PV input burnout error
2	RJCERR.st	RJCERR (I4070)	PV input RJC error
3			
4	PV+over.st	PVPOV_L1 (I4101)	PV input over-scale
5	PV-over.st	PVMOV_L1 (I4102)	PV input under-scale
6 to 13			
14	ATERR.st	ATERR_L1 (I4111)	Auto-tuning timeout error
15			

● **Bit Configuration of D0008: MOD_L1_G (Operation mode status for GREEN Series)**

UT35A/UT32A

Bit	Symbol		Event
	GREEN Series	UTAdvanced	
0	A/M.st	A.M (I4193)	0: AUTO, 1: MAN
1			
2	S/R.st	S.R (I4195)	0: Run, 1: Stop
3 to 13			
14	AT.st	AT_L1_ON (I4207)	0: Auto-tuning is OFF, 1: Auto-tuning is ON
15			

UP35A

Bit	Symbol		Event
	GREEN Series	UTAdvanced	
0 to 7			
8	RESET.st	RST_ON (I4181)	1: Program reset
9	PROG1.st	PT1 (I4849)	1: Program pattern 1 running
10	PROG2.st	PT2 (I4850)	1: Program pattern 2 running
11			
12	HOLD.st	HOLD_ON (I4189)	1: Pause
13	WAIT.st	WAITF (I4190)	1: Wait
14	AT1.st	AT_L1 (I4191)	0: Auto-tuning is OFF, 1: Auto-tuning is ON
15			

● **Bit Configuration of D0011: ALM_G (Alarm status for GREEN Series) (Only for UT35A/UT32A)**

Bit	Symbol		Event
	GREEN Series	UTAdvanced	
0	ALM1.st	ALM1_L1 (I4321)	'1' when alarm 1 is ON; '0' when OFF
1	ALM2.st	ALM2_L1 (I4322)	'1' when alarm 2 is ON; '0' when OFF
2	ALM3.st	ALM3_L1 (I4323)	'1' when alarm 3 is ON; '0' when OFF
3 to 15			

● Bit Configuration of D0035: PA.ER_G (Parameter error status for GREEN Series)

Bit	Symbol		Event
	GREEN Series	UTAdvanced	
0	CALB.E.st	CALB_ERR (I4002)	Calibration value error
1 to 5			
6	SETUP.st	SETPA_ERR (I4005)	Setup parameter error
7			
8	PARA.E.st	OPEPA_ERR (I4006)	Operation parameter error
9	MODE.E.st	CTLPA_ERR (I4011)	Control parameter error
10 to 11			
12	EEP.E.st	FRAM_ERR (I4009)	Faulty FRAM
13			
14	SYSTEM.E.st	SYSTEM_ERR (I4001)	System data error
15			

● D0231: A1_G (Alarm-1 setpoint for GREEN Series)

Register No.	Symbol		Event
	GREEN Series	UTAdvanced	
D0231	A1	A1_G	<p>-19999 to 30000 (Set a value within the input range.)</p> <p>Write: The value written in A1_G will be written in the register of A1_L1_1 to A1_L1_4. A1_L1_1 (D2504) A1_L1_2 (D2524) A1_L1_3 (D2544) A1_L1_4 (D2564)</p> <p>Note: When the same value as the current value is written to A1_G, the action to write A1_L1_1 through A1_L1_4 is performed again. At this time, if different values are set in A1_L1_1 through A1_L1_4, they are overwritten by the same value.</p> <p>Read: The alarm-1 setpoint of the group number being selected in CSPNO.(D0210).</p>

● D0232: A2_G (Alarm-2 setpoint for GREEN Series)

Register No.	Symbol		Event
	GREEN Series	UTAdvanced	
D0232	A2	A2_G	<p>-19999 to 30000 (Set a value within the input range.)</p> <p>Write: The value written in A2_G will be written in the register of A2_L1_1 to A2_L1_4. A2_L1_1 (D2505) A2_L1_2 (D2525) A2_L1_3 (D2545) A2_L1_4 (D2565)</p> <p>Note: When the same value as the current value is written to A2_G, the action to write A2_L1_1 through A2_L1_4 is performed again. At this time, if different values are set in A2_L1_1 through A2_L1_4, they are overwritten by the same value.</p> <p>Read: The alarm-2 setpoint of the group number being selected in CSPNO.(D0210).</p>

● D0233: A3_G (Alarm-3 setpoint for GREEN Series)

Register No.	Symbol		Event
	GREEN Series	UTAdvanced	
D0233	A3	A3_G	<p>-19999 to 30000 (Set a value within the input range.)</p> <p>Write: The value written in A3_G will be written in the register of A3_L1_1 to A3_L1_4. A3_L1_1 (D2506) A3_L1_2 (D2526) A3_L1_3 (D2546) A3_L1_4 (D2566)</p> <p>Note: When the same value as the current value is written to A3_G, the action to write A3_L1_1 through A3_L1_4 is performed again. At this time, if different values are set in A3_L1_1 through A3_L1_4, they are overwritten by the same value.</p> <p>Read: The alarm-3 setpoint of the group number being selected in CSPNO.(D0210).</p>

8.6 GREEN Series Compatible D Registers

● D0254: OH_G (Control output high limit for GREEN Series)

Register No.	Symbol		Event
	GREEN Series	UTAdvanced	
D0254	OH	OH_G	<p>-4.9 to 105.0%, (OL<OH) In Heating/cooling control: 0.1 to 105.0% (OL<OH)</p> <p>Write: The value written in OH_G will be written in the register of OH_L1_1 to OH_L1_4 and OH_L1_R. OH_L1_1 (D3004) OH_L1_2 (D3054) OH_L1_3 (D3104) OH_L1_4 (D3154) OH_L1_R (D3404)</p> <p>Note: When the same value as the current value is written to OH_G, the action to write OH_L1_1 through OH_L1_4 and OH_L1_R is performed again. At this time, if different values are set in OH_L1_1 through OH_L1_4 and OH_L1_R, they are overwritten by the same value.</p> <p>Read: The control output high limit of the group number being selected in PID_L1 (D0009).</p>

● D0255: OL_G (Control output low limit for GREEN Series)

Register No.	Symbol		Event
	GREEN Series	UTAdvanced	
D0255	OL	OL_G	<p>-5.0 to 104.9%, (OL<OH), SD: Tight shut In Heating/cooling control: 0.0 to 104.9% (OL<OH)</p> <p>Write: The value written in OH_G will be written in the register of OL_L1_1 to OL_L1_4 and OL_L1_R. OL_L1_1 (D3005) OL_L1_2 (D3055) OL_L1_3 (D3105) OL_L1_4 (D3155) OL_L1_R (D3405)</p> <p>Note: When the same value as the current value is written to OL_G, the action to write OL_L1_1 through OL_L1_4 and OL_L1_R is performed again. At this time, if different values are set in OL_L1_1 through OL_L1_4 and OL_L1_R, they are overwritten by the same value.</p> <p>Read: The control output low limit of the group number being selected in PID_L1 (D0009).</p>

● D0256: HYS_G (Hysteresis for GREEN Series)

Register No.	Symbol		Event
	GREEN Series	UTAdvanced	
D0256	HYS	HYS_G	<p>In ON/OFF control or Two-position two-level control: 0.0 to 100.0% of PV input range span (EUS) In Heating/cooling control or Position proportional control: 0.0 to 100.0%</p> <p>Write: The value written in HYS_G will be written in the register of HYS_L1_1 to HYS_L1_4 and HYS_L1_R. HYS_L1_1 (D3007) HYS_L1_2 (D3057) HYS_L1_3 (D3107) HYS_L1_4 (D3157) HYS_L1_R (D3407)</p> <p>Note: When the same value as the current value is written to HYS_G, the action to write HYS_L1_1 through HYS_L1_4 and HYS_L1_R is performed again. At this time, if different values are set in HYS_L1_1 through HYS_L1_4 and HYS_L1_R, they are overwritten by the same value.</p> <p>Read: The hysteresis of the group number being selected in PID_L1 (D0009).</p>

● D0257: DR_G (Direct/reverse action switch for GREEN Series)

Register No.	Symbol		Event
	GREEN Series	UTAdvanced	
D0257	DR	DR_G	<p>0: RVS: Reverse action 1: DIR: Direct action</p> <p>Write: The value written in DR_G will be written in the register of DR_L1_1 to DR_L1_4 and DR_L1_R.</p> <p>DR_L1_1 (D3011) DR_L1_2 (D3061) DR_L1_3 (D3111) DR_L1_4 (D3161) DR_L1_R (D3411)</p> <p>Note: When the same value as the current value is written to DR_G, the action to write DR_L1_1 through DR_L1_4 and DR_L1_R is performed again. At this time, if different values are set in DR_L1_1 through DR_L1_4 and DR_L1_R, they are overwritten by the same value.</p> <p>Read: The direct/reverse action switch of the group number being selected in PID_L1 (D0009).</p>

● D0924: PO_G (Preset output for GREEN Series)

Register No.	Symbol		Event
	GREEN Series	UTAdvanced	
D0924	PO	PO_G	<p>-5.0 to 105.0%</p> <p>Write: The value written in PO_G will be written in the register of PO_L1_1 to PO_L1_4 and PO_L1_R.</p> <p>PO_L1_1 (D3020) PO_L1_2 (D3070) PO_L1_3 (D3120) PO_L1_4 (D3170) PO_L1_R (D3420)</p> <p>Note: When the same value as the current value is written to PO_G, the action to write PO_L1_1 through PO_L1_4 and PO_L1_R is performed again. At this time, if different values are set in PO_L1_1 through PO_L1_4 and PO_L1_R, they are overwritten by the same value.</p> <p>Read: The preset output of the group number being selected in PID_L1 (D0009).</p>

● D0925: POc_G (Cooling-side preset output for GREEN Series)

Register No.	Symbol		Event
	GREEN Series	UTAdvanced	
D0925	POc	POc_G	<p>-5.0 to 105.0%</p> <p>Write: The value written in POc_G will be written in the register of POc_L1_1 to POc_L1_4 and POc_L1_R.</p> <p>POc_L1_1 (D3022) POc_L1_2 (D3072) POc_L1_3 (D3122) POc_L1_4 (D3172) POc_L1_R (D3422)</p> <p>Note: When the same value as the current value is written to POc_G, the action to write POc_L1_1 through POc_L1_4 and POc_L1_R is performed again. At this time, if different values are set in POc_L1_1 through POc_L1_4 and POc_L1_R, they are overwritten by the same value.</p> <p>Read: The cooling-side preset output of the group number being selected in PID_L1 (D0009).</p>

8.6 GREEN Series Compatible D Registers

8.6.11 D Registers Differing in Content from GREEN Series

- **D0028, D0029:** Heter break alarm-1 current value display, Heter break alarm-2 current value display
 - D0258, D0259:** Heater break alarm-1 current setpoint, Heater break alarm-2 current setpoint
- UTAdvanced

Register No.	Description		Range and meaning of value
D0028	HC1	Heter break alarm-1 current value display	0.0 to 360.0 Arms
D0029	HC2	Heter break alarm-2 current value display	
D0258	HB1	Heater break alarm-1 current setpoint	0: OFF
D0259	HB2	Heater break alarm-2 current setpoint	0.1 to 300.0 Arms

GREEN Series

Register No.	Description		Range and meaning of value
D0028	HC1	Heter break alarm-1 current value display	The current value of the heater burnout detector is shown on the display of the HC1 or HC2 parameter.
D0029	HC2	Heter break alarm-2 current value display	
D0258	HB1	Heater burnout current measurement 1	0: OFF
D0259	HB2	Heater burnout current measurement 2	1 to 50 A

Note: Each displayed value for HC1, HC2, HB, and HB2 of UTAdvanced has a decimal point. The decimal point should be noted beforehand.

Example: When the displayed value for HC1 of UTAdvanced is 30.0 A, "300" is read out. ("300" is stored in the HC1 register.)
When the value of 30 A is written to HB1 register, "3.0" A is displayed on the UTAdvanced.

- **D0208 : MODE (Operation mode) (for UP300 series)**

UTAdvanced

Register No.	Description		Range and meaning of value
D0208	MODE	Operation mode	0: RESET (Start of program operation) 1: PROG (Stop of program operation) 2: LOCAL (Start of local-mode operation)

GREEN Series

Register No.	Description		Range and meaning of value
D0208	R/P1/P2	Operation mode	0: RET (Program operation is reset.) 1: PRG1 (Program 1 operation) 3: PRG2 (program 2 operation)

● D0915 to D0917: Alarm-1 type to alarm-4 type
UTAdvanced

Register No.	Description		Range and meaning of value
D0915	AL1.T_L1	Alarm-1 type	0: Disable 01: PV high limit 02: PV low limit 03: SP high limit 04: SP low limit 05: Deviation high limit 06: Deviation low limit 07: Deviation high and low limits 08: Deviation within high and low limits 09: Target SP high limit 10: Target SP low limit 11: Target SP deviation high limit 12: Target SP deviation low limit 13: Target SP deviation high and low limits 14: Target SP deviation within high and low limits 15: OUT high limit 16: OUT low limit 17: Cooling-side OUT high limit 18: Cooling-side OUT low limit 19: Analog input PV high limit 20: Analog input PV low limit 27: Feedback input high limit 28: Feedback input low limit 29: PV velocity 30: Fault diagnosis 31: FAIL
D0916	AL2.T_L1	Alarm-2 type	
D0917	AL3.T_L1	Alarm-3 type	

GREEN Series

Register No.	Description		Range and meaning of value
D0915	AL1	Alarm-1 type	OFF (0), 1 to 25, 28 to 31, 33 to 38, 43 to 48 1: PV high limit (energized, no stand-by action) 2: PV low limit (energized, no stand-by action) 3: Deviation high limit (energized, no stand-by action) 4: Deviation low limit (energized, no stand-by action) 5: Deviation high limit (de-energized, no stand-by action) 6: Deviation low limit (de-energized, no stand-by action) For other alarm types, see "Changing Alarm Type" of GREEN series (UT351, UT350, UT321, UT320) User's manual.
D0916	AL2	Alarm-2 type	
D0917	AL3	Alarm-3 type	

8.6 GREEN Series Compatible D Registers

- **D1240: Control output cycle time**
Heating-side control output cycle time (in Heating/cooling control)
- D1241: Cooling-side control output cycle time**
UTAdvanced

Register No.	Description		Range and meaning of value
D1240	CT	Control output cycle time Heating-side control output cycle time (in Heating/cooling control)	0.5 to 1000.0 s
D1241	CTc	Cooling-side control output cycle time	

GREEN Series

Register No.	Description		Range and meaning of value
D1240	CT	Control output cycle time Heating-side control output cycle time (in Heating/cooling control)	1 to 1000 s
D1241	CTc	Cooling-side control output cycle time	

8.6.12 D Registers Differing Depending on Conditions

- **D registers differing depending on the model**

Example: For UT35A, D1247 is PSL_E3.

For UT32A, D1247 is PSL_E1.

Register No.	Name of GREEN	UT35A	UT32A	UP35A
D1247	PSL	D5521 (PSL_E3)	D5501 (PSL_E1)	D5521 (PSL_E4)
D1248	BPS	D5522 (BPS_E3)	D5502 (BPS_E1)	D5522 (BPS_E4)
D1249	PRI	D5523 (PRI_E3)	D5503 (PRI_E1)	D5523 (PRI_E4)
D1250	STP	D5524 (STP_E3)	D5504 (STP_E1)	D5524 (STP_E4)
D1251	DLN	D5525 (DLN_E3)	D5505 (DLN_E1)	D5525 (DLN_E4)
D1252	ADR	D5526 (ADR_E3)	D5506 (ADR_E1)	D5526 (ADR_E4)
D1253	RP.T	D5527 (RP.T_E3)	D5507 (RP.T_E1)	D5527 (RP.T_E4)

- **D registers differing depending on the PID number (PID_L1)**

Example: D0254 is OH_L1_1 when PDI_L1 = 1.

Register No.	Name of GREEN	PID_L1_1	PID_L1_2	PID_L1_3	PID_L1_4	PID_L1_R
D0254	OH	D3004 (OH_L1_1)	D3054 (OH_L1_2)	D3104 (OH_L1_3)	D3154 (OH_L1_4)	D3404 (OH_L1_R)
D0255 (When CNT_L1 = 0, 1 or 2)	OL	D3005 (OL_L1_1)	D3055 (OL_L1_2)	D3105 (OL_L1_3)	D3155 (OL_L1_4)	D3405 (OL_L1_R)
D0255 (When CNT_L1 = 3* or 4) *: Only for UT35A/UT32A.	OL	D3016 (OHC_L1_1)	D3066 (OHC_L1_2)	D3116 (OHC_L1_3)	D3166 (OHC_L1_4)	D3416 (OHC_L1_R)
D0256	HYS	D3007 (HYS_L1_1)	D3057 (HYS_L1_2)	D3107 (HYS_L1_3)	D3157 (HYS_L1_4)	D3407 (HYS_L1_R)
D0257	DR	D3011 (DR_L1_1)	D3061 (DR_L1_2)	D3111 (DR_L1_3)	D3161 (DR_L1_4)	D3411 (DR_L1_R)

9.1 Overview

This chapter describes the functions and applications of the I relays.

I relays are used in ladder program, Modbus communication, PC link communication, and contact input / output functions.

I relays contain status information of errors, operation, and alarms. Contents of I relays can be read only by means of communication using a host computer. (Note that the I relays have the same information as the D registers but with I relays, some of the information is read-only.)

- ▶ [Contact input and output functions: Chapter 12 Contact Input and Output Functions of the UTAdvanced User's Manual](#)

Use of the I relays enables the following:

- Centralized control by the host computer

D registers and I relays on the UTAdvanced are used for parameter settings or ladder program creations of LL50A Parameter Setting Software.

9.2 Classification of I Relays

I relays are classified as shown below.

Classification of I Relay Map

I relay No.	Area and data categories	Description	
1 to 192	GREEN series (See 9.5 I Relays Corresponding to GREEN Series)	Status	Each bit information is the same as that of D register.
193 to 576		Free area	
577 to 640		SP number, PID number, Pattern number, Segment number (Note 1)	Each bit information is the same as that of D register.
641 to 720		Status	Each bit information is the same as that of D register.
721 to 784		User area	
785 to 4000		Free area	
4001 to 4064	Function status	System error	Each bit information is the same as that of D register.
4065 to 4128		Input error	Each bit information is the same as that of D register.
4129 to 4192		Free area	
4193 to 4256		Operation Mode	Each bit information of 4193 to 4240 is the same as that of D register. For 4241 to 4256, see the section 9.3.1.
4257 to 4320		Free area	
4321 to 4384		Alarm	Each bit information is the same as that of D register.
4385 to 4528		Alarm latch	Each bit information of 4385 to 4512 is the same as that of D register. For 4385 to 4512, see the section 9.3.1.
4529 to 4576		Heater break alarm	Each bit information is the same as that of D register.
4577 to 4640		P number, PID number, Pattern number, Segment number (Note 1)	Each bit information is the same as that of D register.
4641 to 4704		Free area	
4705 to 4768		Key	Each bit information is the same as that of D register. Note: For UP35A, see the section 9.3.1.
4769 to 4784		Display	Each bit information is the same as that of D register.
4785 to 4848		PV event status, Time event status (Note 2)	Each bit information is the same as that of D register.
4849 to 5024		Pattern number status, Segment number status (Note 2)	See the section 9.3.1.
5025 to 5152		Status for ladder program	Input (status) relay
5153 to 5280	Output (status) relay		Each bit information is the same as that of D register.
5281 to 5536	Control (status) relay		Each bit information is the same as that of D register.
5537 to 5600	Special relay		Each bit information of 5409 to 5540 is the same as that of D register. For 5441 to 5472, see the section 9.3.2.
5473 to 5536	Free area		
5537 to 5792	Internal relay		Each bit information is the same as that of D register.
5793 to 6048	Free area		
6049 to 6240	Peer-to-peer communication register		See the section 9.3.2.
6241 to 6304	Free area		

For Ladder

I relay No.	Area and data categories	Description	
6305 to 6432	Input / Output terminal status	DI terminal	Each bit information is the same as that of D register.
6433 to 6560		DO terminal	Each bit information is the same as that of D register.
6561 to 7072		Free area	

Note 1: SP numbers are for UT35A/UT32A, and Pattern numbers and Segment numbers are for UP55A.

Note 2: These are for UP35A.

CAUTION

- Check the model and suffix codes and parameter settings before writing to or read from the registers to be used.
- In the area for I relay numbers 4001 to 6560, it is prohibited to write data to I relays with blank cells in I relay map tables. If you attempt to do so, the UTAdvanced may not operate properly.

Note

- I relay numbers 4001 to 6560 store ON/OFF status information and are normally read for ON/OFF status information.

■ How to Specify I Relay Numbers

When specifying an I relay number for communication, begin the number with the character "I."

Example: Set "I4065" to specify the ADERR (I relay No.: 4065).

■ I relay symbol

- With regards to some register symbols, the loop number and terminal area are indicated by adding the underline () to the end of the parameter symbols.

Note

Since the UT35A/UT32A is a single-loop controller, it has no distinction between Loop-1 and Loop-2.

However, the register symbol has "L1" which indicates Loop-1.

□□□□_L1 L1: Loop numbers
□□□□_En En: Terminal area (E1 to E4)

Example : **PVBO_L1** Indicates PVBO.
ADERR_E1 Indicates ADERR in E1-terminal area.

9.3 UT35A/UT32A/UP35A I Relays

9.3.1 Function Status (4001 to 5024)

Note

When specifying an I relay number for communication, begin the number with the character "I."
Example: Set "I4065" to specify the ADERR (I relay No.: 4065).

System error				Input error			
NO.	I relay symbol	R/W		NO.	I relay symbol	R/W	
		UT35A/UT32A	UP35A			UT35A/UT32A	UP35A
4001	SYSTEM_ERR	R	R	4065	ADERR	R	R
4002	CALB_ERR	R	R	4066			
4003	UPARA_ERR	R	R	4067			
4004				4068			
4005	SETPA_ERR	R	R	4069			
4006	OPEPA_ERR	R	R	4070	RJCERR	R	R
4007	PROG_ERR		R	4071			
4008				4072			
4009	FRAM_ERR	R	R	4073	ADBO	R	R
4010				4074			
4011	CTLPA_ERR	R	R	4075			
4012				4076			
4013				4077			
4014				4078			
4015				4079			
4016				4080			
4017	LAD_ERR	R	R	4081	VALVBO	R	R
4018	LAD_OVER	R	R	4082	VALV_ATERR	R	R
4019	LAD_P_ERR	R	R	4083			
4020				4084			
4021	LD100_OVER	R	R	4085			
4022	LD200_OVER	R	R	4086			
4023				4087			
4024				4088			
4025				4089			
4026				4090			
4027				4091			
4028				4092			
4029				4093			
4030				4094			
4031				4095			
4032				4096			
4033	E1_ERR	R	R	4097	PVBO_L1	R	R
4034				4098			
4035	E3_ERR	R	R	4099			
4036				4100			
4037	E4_ERR	R	R	4101	PVPOVER_L1	R	R
4038				4102	PVMOVER_L1	R	R
4039				4103			
4040				4104			
4041	COM_E1_ERR	R		4105			
4042				4106			
4043	COM_E3_ERR	R	R	4107			
4044				4108			
4045				4109			
4046				4110			
4047				4111	ATERR_L1	R	R
4048				4112			
4049				4113			
4050				4114			
4051				4115			
4052				4116			
4053				4117			
4054				4118			
4055				4119			
4056				4120			
4057				4121			
4058				4122			
4059				4123			
4060				4124			
4061				4125			
4062				4126			
4063				4127			
4064				4128			

9.3 UT35A/UT32A/UP35A I Relays

Operation mode				Operation mode				Operation mode			
NO.	I relay symbol	R/W		NO.	I relay symbol	R/W		NO.	I relay symbol	R/W	
		UT35A/UT32A	UP35A			UT35A/UT32A	UP35A			UT35A/UT32A	UP35A
4129				4193	A.M	R/W		4257	WTEND1		R
4130				4194	R.L_L1	R/W		4258	WTEND3		R
4131				4195	S.R	R/W		4259	WTEND5		R
4132				4196				4260			
4133				4197				4261	SEG_SYNC		R
4134				4198				4262			
4135				4199				4263			
4136				4200				4264			
4137				4201	TRK_ON_L1	R/W		4265	PTEND1		R
4138				4202				4266	PTEND3		R
4139				4203				4267	PTEND5		R
4140				4204				4268			
4141				4205				4269			
4142				4206				4270			
4143				4207	AT_L1_ON	R/W		4271			
4144				4208				4272			
4145				4209	VALV_AT	R	R	4273			
4146				4210	VALV_GUSS	R	R	4274			
4147				4211				4275			
4148				4212				4276			
4149				4213	VALV_OPEN	R	R	4277			
4150				4214	VALV_CLOSE	R	R	4278			
4151				4215				4279			
4152				4216				4280			
4153				4217				4281			
4154				4218				4282			
4155				4219				4283			
4156				4220				4284			
4157				4221				4285			
4158				4222				4286			
4159				4223				4287			
4160				4224				4288			
4161				4225				4289			
4162				4226				4290			
4163				4227				4291			
4164				4228				4292			
4165				4229				4293			
4166				4230				4294			
4167				4231				4295			
4168				4232				4296			
4169				4233				4297			
4170				4234				4298			
4171				4235				4299			
4172				4236				4300			
4173				4237				4301			
4174				4238				4302			
4175				4239				4303			
4176				4240				4304			
4177	A.M_L1		R/W	4241				4305			
4178				4242				4306			
4179				4243				4307			
4180				4244				4308			
4181	RST_ON		R/W	4245				4309			
4182	PRG_ON		R/W	4246				4310			
4183	LOC_ON		R/W	4247				4311			
4184				4248				4312			
4185				4249				4313			
4186	TRK_ON_L1		R/W	4250				4314			
4187	ADV_ON		R/W	4251				4315			
4188				4252				4316			
4189	HOLD_ON		R/W	4253				4317			
4190	WAITF		R	4254				4318			
4191	AT_L1_ON		R/W	4255				4319			
4192				4256	FAIL_ALARM	R	R	4320			

9.3 UT35A/UT32A/UP35A I Relays

Alarm				Alarm latch				Alarm latch			
NO.	I relay symbol	R/W		NO.	I relay symbol	R/W		NO.	I relay symbol	R/W	
		UT35A/UT32A	UP35A			UT35A/UT32A	UP35A			UT35A/UT32A	UP35A
4321	ALM1_L1	R	R	4385	ALO1LA1_L1	R	R	4449	ALO1LA3_L1	R	R
4322	ALM2_L1	R	R	4386	ALO2LA1_L1	R	R	4450	ALO2LA3_L1	R	R
4323	ALM3_L1	R		4387	ALO3LA1_L1	R		4451	ALO3LA3_L1	R	
4324				4388				4452			
4325	ALM4_L1	R		4389	ALO4LA1_L1	R		4453	ALO4LA3_L1	R	
4326				4390				4454			
4327				4391				4455			
4328				4392				4456			
4329				4393				4457			
4330				4394				4458			
4331				4395				4459			
4332				4396				4460			
4333				4397				4461			
4334				4398				4462			
4335				4399				4463			
4336				4400				4464			
4337				4401				4465			
4338				4402				4466			
4339				4403				4467			
4340				4404				4468			
4341				4405				4469			
4342				4406				4470			
4343				4407				4471			
4344				4408				4472			
4345				4409				4473			
4346				4410				4474			
4347				4411				4475			
4348				4412				4476			
4349				4413				4477			
4350				4414				4478			
4351				4415				4479			
4352				4416				4480			
4353	ALO1_L1	R	R	4417	ALO1LA2_L1	R	R	4481	ALO1LA4_L1	R	R
4354	ALO2_L1	R	R	4418	ALO2LA2_L1	R	R	4482	ALO2LA4_L1	R	R
4355	ALO3_L1	R		4419	ALO3LA2_L1	R		4483	ALO3LA4_L1	R	
4356				4420				4484			
4357	ALO4_L1	R		4421	ALO4LA2_L1	R		4485	ALO4LA4_L1	R	
4358				4422				4486			
4359				4423				4487			
4360				4424				4488			
4361				4425				4489			
4362				4426				4490			
4363				4427				4491			
4364				4428				4492			
4365				4429				4493			
4366				4430				4494			
4367				4431				4495			
4368				4432				4496			
4369				4433				4497			
4370				4434				4498			
4371				4435				4499			
4372				4436				4500			
4373				4437				4501			
4374				4438				4502			
4375				4439				4503			
4376				4440				4504			
4377				4441				4505			
4378				4442				4506			
4379				4443				4507			
4380				4444				4508			
4381				4445				4509			
4382				4446				4510			
4383				4447				4511			
4384				4448				4512			

9.3 UT35A/UT32A/UP35A I Relays

Alarm latch and Heater break alarm				SP number and PID number				Pattern number and Segment number			
NO.	I relay symbol	R/W		NO.	I relay symbol	R/W		NO.	I relay symbol	R/W	
		UT35A/UT32A	UP35A			UT35A/UT32A	UP35A			UT35A/UT32A	UP35A
4513	ALOLA_RLS	R/W	R/W	4577	CSPN.B0	R		4641	PTNO.B0		R
4514	ALM_WAIT	R/W	R/W	4578	CSPN.B1	R		4642	PTNO.B1		R
4515				4579	CSPN.B2	R		4643	PTNO.B2		R
4516				4580				4644			
4517				4581				4645			
4518				4582				4646			
4519				4583				4647			
4520				4584				4648			
4521				4585				4649			
4522				4586				4650			
4523				4587				4651			
4524				4588				4652			
4525				4589				4653			
4526				4590				4654			
4527				4591				4655			
4528				4592				4656			
4529	CT_AL1	R	R	4593				4657	SEGNO.B0		R
4530	CT_AL2	R	R	4594				4658	SEGNO.B1		R
4531				4595				4659	SEGNO.B2		R
4532				4596				4660	SEGNO.B3		R
4533				4597				4661	SEGNO.B4		R
4534				4598				4662	SEGNO.B5		R
4535				4599				4663			
4536				4600				4664			
4537				4601				4665			
4538				4602				4666			
4539				4603				4667			
4540				4604				4668			
4541				4605				4669			
4542				4606				4670			
4543				4607				4671			
4544				4608				4672			
4545				4609	PIDN.B0_L1	R	R	4673	RAMP_UP_L		R
4546				4610	PIDN.B1_L1	R	R	4674	SOAK_L		R
4547				4611	PIDN.B2_L1	R	R	4675	RAMP_DN_L		R
4548				4612				4676			
4549				4613				4677			
4550				4614				4678			
4551				4615				4679			
4552				4616				4680			
4553				4617				4681			
4554				4618				4682			
4555				4619				4683			
4556				4620				4684			
4557				4621				4685			
4558				4622				4686			
4559				4623				4687			
4560				4624				4688			
4561				4625				4689			
4562				4626				4690			
4563				4627				4691			
4564				4628				4692			
4565				4629				4693			
4566				4630				4694			
4567				4631				4695			
4568				4632				4696			
4569				4633				4697			
4570				4634				4698			
4571				4635				4699			
4572				4636				4700			
4573				4637				4701			
4574				4638				4702			
4575				4639				4703			
4576				4640				4704			

Key				Display, PV event status and Time event status			
NO.	I relay symbol	R/W		NO.	I relay symbol	R/W	
		UT35A/UT32A	UP35A			UT35A/UT32A	UP35A
4705	PARA_KEY	R	R	4769	MG1.B	R	R
4706	DISP_KEY	R	R	4770	MG2.B	R	R
4707	RIGHT_KEY	R	R	4771	MG3.B	R	R
4708	DOWN_KEY	R	R	4772			
4709	SET_KEY	R	R	4773	MG4.B	R	R
4710	UP_KEY	R	R	4774			
4711	LEFT_KEY	R	R	4775			
4712	F2_KEY	R		4776			
4713	F1_KEY	R		4777			
4714	A/M_KEY	R		4778			
4715	FN_KEY	R		4779	PVRW_L1	R	R
4716	PTN_KEY		R	4780			
4717	RST_KEY		R	4781			
4718	MODE_KEY		R	4782			
4719	RUN_KEY		R	4783			
4720				4784			
4721				4785	PV_EV1		R
4722				4786	PV_EV2		R
4723				4787			
4724				4788			
4725				4789			
4726				4790			
4727				4791			
4728				4792			
4729				4793			
4730				4794			
4731				4795			
4732				4796			
4733				4797			
4734				4798			
4735				4799			
4736				4800			
4737				4801	PV_EV1_OUT		R
4738				4802	PV_EV2_OUT		R
4739				4803			
4740				4804			
4741				4805			
4742				4806			
4743				4807			
4744				4808			
4745				4809			
4746				4810			
4747				4811			
4748				4812			
4749				4813			
4750				4814			
4751				4815			
4752				4816			
4753				4817	TIME_EV1		R
4754				4818	TIME_EV2		R
4755				4819	TIME_EV3		R
4756				4820			
4757				4821	TIME_EV4		R
4758				4822			
4759				4823			
4760				4824			
4761				4825			
4762				4826			
4763				4827			
4764				4828			
4765				4829			
4766				4830			
4767				4831			
4768				4832			

9.3 UT35A/UT32A/UP35A I Relays

Pattern number status and Segment number status				Pattern number status and Segment number status				Pattern number status and Segment number status			
NO.	I relay symbol	R/W		NO.	I relay symbol	R/W		NO.	I relay symbol	R/W	
		UT35A/UT32A	UP35A			UT35A/UT32A	UP35A			UT35A/UT32A	UP35A
4833				4897	SEG1		R	4961			
4834				4898	SEG2		R	4962			
4835				4899	SEG3		R	4963			
4836				4900	SEG4		R	4964			
4837				4901	SEG5		R	4965			
4838				4902	SEG6		R	4966			
4839				4903	SEG7		R	4967			
4840				4904	SEG8		R	4968			
4841				4905	SEG9		R	4969			
4842				4906	SEG10		R	4970			
4843				4907	SEG11		R	4971			
4844				4908	SEG12		R	4972			
4845				4909	SEG13		R	4973			
4846				4910	SEG14		R	4974			
4847				4911	SEG15		R	4975			
4848				4912	SEG16		R	4976			
4849	PT1		R	4913	SEG17		R	4977			
4850	PT2		R	4914	SEG18		R	4978			
4851	PT3		R	4915	SEG19		R	4979			
4852	PT4		R	4916	SEG20		R	4980			
4853				4917	SEG21		R	4981			
4854				4918	SEG22		R	4982			
4855				4919	SEG23		R	4983			
4856				4920	SEG24		R	4984			
4857				4921	SEG25		R	4985			
4858				4922	SEG26		R	4986			
4859				4923	SEG27		R	4987			
4860				4924	SEG28		R	4988			
4861				4925	SEG29		R	4989			
4862				4926	SEG30		R	4990			
4863				4927	SEG31		R	4991			
4864				4928	SEG32		R	4992			
4865				4929	SEG33		R	4993			
4866				4930	SEG34		R	4994			
4867				4931	SEG35		R	4995			
4868				4932	SEG36		R	4996			
4869				4933	SEG37		R	4997			
4870				4934	SEG38		R	4998			
4871				4935	SEG39		R	4999			
4872				4936	SEG40		R	5000			
4873				4937				5001			
4874				4938				5002			
4875				4939				5003			
4876				4940				5004			
4877				4941				5005			
4878				4942				5006			
4879				4943				5007			
4880				4944				5008			
4881				4945				5009			
4882				4946				5010			
4883				4947				5011			
4884				4948				5012			
4885				4949				5013			
4886				4950				5014			
4887				4951				5015			
4888				4952				5016			
4889				4953				5017			
4890				4954				5018			
4891				4955				5019			
4892				4956				5020			
4893				4957				5021			
4894				4958				5022			
4895				4959				5023			
4896				4960				5024			

System Error, Input Error, and Operation Mode (4001 to 4320)

UT35A/UT32A

I relay No.	Symbol	Event	
4001 to 4016	SYSTEM_ERR to CTLPA_ERR	Parameter error status (Same as D2068)	
4017 to 4032	LAD_ERR to LD200_OVER	Ladder error status (Same as D2012)	
4033 to 4048	E1_ERR to COM_E3_ERR	Option error status (Same as D2070)	
4049 to 4064			
4065 to 4128	ADERR to ADBO	A/D converter error status 1 (Same as D2001)	
	VALVBO to VALV_ATERR	A/D converter error status 2 (Same as D2065)	
	PVBO_L1 to ATERR_L1	PV input error status (Same as D2002)	
4129 to 4192	Free Area		
4193 to 4208	A.M_L1 to AT_L1_ON	Operation mode status (Same as D2008)	
4209 to 4224	VALV_AT to VALV_CLOSE	Valve status (Same as D2064)	
4225 to 4255			
4256	FAIL_ALARM	FAIL alarm status (For contact output. Not available for the communication or the ladder program.)	0: FAIL alarm 1: OFF (Normal)
4257 to 4320	Free area		

UP35A

I relay No.	Symbol	Event	
4001 to 4016	SYSTEM_ERR to CTLPA_ERR	Parameter error status (Same as D2068)	
4017 to 4032	LAD_ERR to LD200_OVER	Ladder error status (Same as D2012)	
4033 to 4048	E1_ERR to COM_E4_ERR	Option error status (Same as D2070)	
4049 to 4064			
4065 to 4128	ADERR to ADBO_E4	A/D converter error status 1 (Same as D2001)	
	VALVBO to VALV_ATERR	A/D converter error status 2 (Same as D2065)	
	PVBO_L1 to ATERR_L1	PV input error status (Same as D2002)	
4129 to 476			
4177 to 4192	A.M_L1 to AT_L1_ON	Operation mode status (Same as D2008)	
4193 to 4208			
4209 to 4224	VALV_AT to VALV_CLOSE	Valve status (Same as D2064)	
4225 to 4255			
4256	FAIL_ALARM	FAIL alarm status (For contact output. Not available for the communication or the ladder program.)	0: FAIL alarm 1: OFF (Normal)
4257 to 4320	WTEND1	Wait end signal (1 second)	0: OFF 1: ON
	WTEND3	Wait end signal (3 seconds)	
	WTEND5	Wait end signal (5 seconds)	
	SEG_SYNC	Control flag for segment transition	
	PTEND1	Pattern end signal (1 second)	
	PTEND3	Pattern end signal (3 seconds)	
PTEND5	Pattern end signal (5 seconds)		
4273 to 4320			

9.3 UT35A/UT32A/UP35A I Relays

Alarm, Alarm Latch and Heater Break Alarm (4321 to 4576)

UT35A/UT32A

I relay No.	Symbol	Event	
4321 to 4336	ALM1_L1~ALM4_L1	Alarm-1 to alarm-4 status (Same as D2011)	
4337 to 4352			
4353 to 4368	ALO1_L1 to ALO4_L1	Alarm-1 to alarm-4 output status (Same as D2037)	
4369 to 4384			
4385 to 4400	ALO1LA1_L1 to ALO4LA1_L1	Alarm-1 to alarm-4 latch output status (Same as D2071)	
4401 to 4416			
4417 to 4432	ALO1LA2_L1 to ALO4LA2_L1	Alarm-1 to alarm-4 latch-2 output status (Same as D2073)	
4433 to 4448			
4449 to 4464	ALO1LA3_L1 to ALO4LA3_L1	Alarm-1 to alarm-4 latch-3 output status (Same as D2075)	
4465 to 4480			
4481 to 4496	ALO1LA4_L1 to ALO4LA4_L1	Alarm-1 to alarm-4 latch-4 output status (Same as D2077)	
4497 to 4512			
4513	ALOLA_RLS	Alarm latch release flag	0: OFF 1: Latch release Automatically returned to "0".
4514	ALM_WAIT	Forced stand-by alarm flag	0: OFF 1: Forced stand-by Automatically returned to "0".
4529 to 4544	CT_AL1 to CT_AL2	Heater break alarm status (Same as D2063)	
4545 to 4576			

UP35A

I relay No.	Symbol	Event	
4321 to 4336	ALM1_L1~ALM2_L1	Alarm-1 to alarm-2 status (Same as D2011)	
4337 to 4352			
4353 to 4368	ALO1_L1 to ALO2_L1	Alarm-1 to alarm-2 output status (Same as D2037)	
4369 to 4384			
4385 to 4400	ALO1LA1_L1 to ALO2LA1_L1	Alarm-1 to alarm-2 latch output status (Same as D2071)	
4401 to 4416			
4417 to 4432	ALO1LA2_L1 to ALO2LA2_L1	Alarm-1 to alarm-2 latch-2 output status (Same as D2073)	
4433 to 4448			
4449 to 4464	ALO1LA3_L1 to ALO2LA3_L1	Alarm-1 to alarm-2 latch-3 output status (Same as D2075)	
4465 to 4480			
4481 to 4496	ALO1LA4_L1 to ALO2LA4_L1	Alarm-1 to alarm-2 latch-4 output status (Same as D2077)	
4497 to 4512			
4513	ALOLA_RLS	Alarm latch release flag	0: OFF 1: Latch release Automatically returned to "0".
4514	ALM_WAIT	Forced stand-by alarm flag	0: OFF 1: Forced stand-by Automatically returned to "0".
4529 to 4544	CT_AL1 to CT_AL2	Heater break alarm status (Same as D2063)	
4545 to 4576			

SP Number and PID Number (4577 to 4704)

UT35A/UT32A

I relay No.	Symbol	Event	
4577 to 4592 *1	CSPN.B0 to CSPN.B2	SP number (Same as D2010)	
4593 to 4608			
4609 to 4624 *1	PIDN.B0_L1 to PIDN.B2_L1	PID number (Same as D2009)	
4625 to 4640			
4641 to 4704	Free area		

*1: The information of I relays 4577 to 4592 and 4609 to 4624 is represented by 3-digit binary codes, from 000 (0 in decimal) to 100 (4 in decimal), which are formed by the bit combination of three I relays. The lowest-numbered I relay in each set signifies the LSB.

UP35A

I relay No.	Symbol	Event
4577 to 4608		
4609 to 4624 *1	PIDN.B0_L1 to PIDN.B3_L1	PID number (Same as D2009)
4625 to 4640		
4641 to 4656	PTNO.B0 to PTNO.B2	Pattern number (Same as D2015)
4657 to 4672	SEGNO.B0 to SEGNO. B5	Segment number (Same as D2016)
4673	RAMP_UP_L	Ramp-up status lamp
4674	SOAK_L	Soak status lamp
4675	PAMP_DN_L	Ramp-down status lamp
4689 to 4704		

*1: The information of I relays 4577 to 4592 and 4609 to 4640 is represented by 4-digit binary codes, from 0000 (0 in decimal) to 1000 (8 in decimal), which are formed by the bit combination of four I relays. The lowest-numbered I relay in each set signifies the LSB.

Key (4705 to 4768)

UT35A/UT32A

I relay No.	Symbol	Event
4705 to 4720	PARA_KEY to FN_KEY	Key status (Same as D6301)
4721 to 4768		

UP35A

I relay No.	Symbol	Event
4705 to 4720	PARA_KEY to RUN_KEY	Key status (Same as D6301)
4721 to 4768		

Display, PV Event Status and Time Event Status (4769 to 5024)

UT35A/UT32A

I relay No.	Symbol	Event
4769 to 4773	MG1.B to MG4.B	Message display interruption status (Same as D2066)
4779	PVRW_L1	PV red/white switch 0: White color 1: Red color
4785 to 4832		
4833 to 5024	Free area	

UP35A

I relay No.	Symbol	Event
4769 to 4773	MG1.B to MG4.B	Message display interruption status (Same as D2066)
4779	PVRW_L1	PV red/white switch 0: White color 1: Red color
4785 to 4800	PV_EV1 to PV_EV2	PV event status (D2039)
4801 to 4816	PV_EV1_OUT to PV_EV2_OUT	PV event output status (D2050)
4817 to 4832	TIME_EV1 to TIME_EV4	Time event status_1 (D2040)
4833 to 4848		

Pattern Number Status and Segment Number Status (4849 to 5024)

UP35A

I relay No.	Symbol	Event
4849 to 4864	PT1 to PT4	Pattern 1-4 running status
4865 to 4896		
4897 to 4912	SEG1 to SEG16	Segment 1-16 running status
4913 to 4928	SEG17 to SEG32	Segment 17-32 running status
4929 to 4944	SEG33 to SEG40	Segment 33-40 running status
4945 to 5024		

9.3.2 Status for Ladder Program (5025 to 5664)

Note

When specifying an I relay number for communication, begin the number with the character "I."
Example: Set "I5025" to specify the X_DI1 (I relay No.: 5025).

Input (status) relay				Input (status) relay			
NO.	I relay symbol	R/W		NO.	I relay symbol	R/W	
		UT35A/UT32A	UP35A			UT35A/UT32A	UP35A
5025	X_DI1	R	R	5089	X_DI41	R	R
5026	X_DI2	R	R	5090	X_DI42	R	R
5027	X_DI3		R	5091	X_DI43	R	R
5028				5092	X_DI44	R	R
5029				5093	X_DI45	R	R
5030				5094			
5031				5095			
5032				5096			
5033				5097			
5034				5098			
5035				5099			
5036				5100			
5037				5101			
5038				5102			
5039				5103			
5040				5104			
5041	X_DI11	R	R	5105			
5042	X_DI12	R	R	5106			
5043	X_DI13	R	R	5107			
5044	X_DI14	R	R	5108			
5045	X_DI15	R	R	5109			
5046				5110			
5047				5111			
5048				5112			
5049				5113			
5050				5114			
5051				5115			
5052				5116			
5053				5117			
5054				5118			
5055				5119			
5056				5120			
5057				5121			
5058				5122			
5059				5123			
5060				5124			
5061				5125			
5062				5126			
5063				5127			
5064				5128			
5065				5129			
5066				5130			
5067				5131			
5068				5132			
5069				5133			
5070				5134			
5071				5135			
5072				5136			
5073				5137			
5074				5138			
5075				5139			
5076				5140			
5077				5141			
5078				5142			
5079				5143			
5080				5144			
5081				5145			
5082				5146			
5083				5147			
5084				5148			
5085				5149			
5086				5150			
5087				5151			
5088				5152			

9.3 UT35A/UT32A/UP35A I Relays

Output (status) relay				Output (status) relay			
NO.	I relay symbol	R/W		NO.	I relay symbol	R/W	
		UT35A/UT32A	UP35A			UT35A/UT32A	UP35A
5153	Y_AL1	R/W	R/W	5217	Y_DO41	R/W	R/W
5154	Y_AL2	R/W	R/W	5218	Y_DO42	R/W	R/W
5155	Y_AL3	R/W	R/W	5219	Y_DO43	R/W	R/W
5156				5220	Y_DO44	R/W	R/W
5157				5221	Y_DO45	R/W	R/W
5158				5222			
5159				5223			
5160				5224			
5161				5225			
5162				5226			
5163				5227			
5164				5228			
5165				5229			
5166				5230			
5167				5231			
5168				5232			
5169	Y_DO11	R/W	R/W	5233			
5170	Y_DO12	R/W	R/W	5234			
5171	Y_DO13	R/W	R/W	5235			
5172	Y_DO14	R/W	R/W	5236			
5173	Y_DO15	R/W	R/W	5237			
5174				5238			
5175				5239			
5176				5240			
5177				5241			
5178				5242			
5179				5243			
5180				5244			
5181				5245			
5182				5246			
5183				5247			
5184				5248			
5185				5249			
5186				5250			
5187				5251			
5188				5252			
5189				5253			
5190				5254			
5191				5255			
5192				5256			
5193				5257			
5194				5258			
5195				5259			
5196				5260			
5197				5261			
5198				5262			
5199				5263			
5200				5264			
5201				5265			
5202				5266			
5203				5267			
5204				5268			
5205				5269			
5206				5270			
5207				5271			
5208				5272			
5209				5273			
5210				5274			
5211				5275			
5212				5276			
5213				5277			
5214				5278			
5215				5279			
5216				5280			

Control (status) relay				Control (status) relay			
NO.	I relay symbol	R/W		NO.	I relay symbol	R/W	
		UT35A/UT32A	UP35A			UT35A/UT32A	UP35A
5281	AL1_CTL	R	R	5345	DO41_CTL	R	R
5282	AL2_CTL	R	R	5346	DO42_CTL	R	R
5283	AL3_CTL	R	R	5347	DO43_CTL	R	R
5284				5348	DO44_CTL	R	R
5285				5349	DO45_CTL	R	R
5286				5350			
5287				5351			
5288				5352			
5289				5353			
5290				5354			
5291				5355			
5292				5356			
5293				5357			
5294				5358			
5295				5359			
5296				5360			
5297	DO11_CTL	R	R	5361			
5298	DO12_CTL	R	R	5362			
5299	DO13_CTL	R	R	5363			
5300	DO14_CTL	R	R	5364			
5301	DO15_CTL	R	R	5365			
5302				5366			
5303				5367			
5304				5368			
5305				5369			
5306				5370			
5307				5371			
5308				5372			
5309				5373			
5310				5374			
5311				5375			
5312				5376			
5313				5377			
5314				5378			
5315				5379			
5316				5380			
5317				5381			
5318				5382			
5319				5383			
5320				5384			
5321				5385			
5322				5386			
5323				5387			
5324				5388			
5325				5389			
5326				5390			
5327				5391			
5328				5392			
5329				5393			
5330				5394			
5331				5395			
5332				5396			
5333				5397			
5334				5398			
5335				5399			
5336				5400			
5337				5401			
5338				5402			
5339				5403			
5340				5404			
5341				5405			
5342				5406			
5343				5407			
5344				5408			

9.3 UT35A/UT32A/UP35A I Relays

Special relay				Free area			
NO.	I relay symbol	R/W		NO.	I relay symbol	R/W	
		UT35A/UT32A	UP35A			UT35A/UT32A	UP35A
5409	TIM1	R	R	5473			
5410	TIM2	R	R	5474			
5411	TIM3	R	R	5475			
5412	TIM4	R	R	5476			
5413				5477			
5414				5478			
5415				5479			
5416				5480			
5417				5481			
5418				5482			
5419				5483			
5420				5484			
5421				5485			
5422				5486			
5423				5487			
5424				5488			
5425	CNT1	R	R	5489			
5426	CNT2	R	R	5490			
5427	CNT3	R	R	5491			
5428	CNT4	R	R	5492			
5429				5493			
5430				5494			
5431				5495			
5432				5496			
5433				5497			
5434				5498			
5435				5499			
5436				5500			
5437				5501			
5438				5502			
5439				5503			
5440				5504			
5441	SMPCLK	R	R	5505			
5442	CLK1	R	R	5506			
5443	CLK2	R	R	5507			
5444	CLK10	R	R	5508			
5445	CLK60	R	R	5509			
5446				5510			
5447	CLK1P	R	R	5511			
5448	CLK2P	R	R	5512			
5449	CLK10P	R	R	5513			
5450	CLK60P	R	R	5514			
5451				5515			
5452				5516			
5453				5517			
5454				5518			
5455				5519			
5456				5520			
5457	PON	R	R	5521			
5458	PLS1	R	R	5522			
5459	ZERO	R	R	5523			
5460				5524			
5461	PDLVL	R	R	5525			
5462				5526			
5463				5527			
5464				5528			
5465				5529			
5466				5530			
5467				5531			
5468				5532			
5469				5533			
5470				5534			
5471				5535			
5472				5536			

Internal relay				Internal relay			
NO.	I relay symbol	R/W		NO.	I relay symbol	R/W	
		UT35A/UT32A	UP35A			UT35A/UT32A	UP35A
5537	M01	R/W	R/W	5601	M65	R/W	R/W
5538	M02	R/W	R/W	5602	M66	R/W	R/W
5539	M03	R/W	R/W	5603	M67	R/W	R/W
5540	M04	R/W	R/W	5604	M68	R/W	R/W
5541	M05	R/W	R/W	5605	M69	R/W	R/W
5542	M06	R/W	R/W	5606	M70	R/W	R/W
5543	M07	R/W	R/W	5607	M71	R/W	R/W
5544	M08	R/W	R/W	5608	M72	R/W	R/W
5545	M09	R/W	R/W	5609	M73	R/W	R/W
5546	M10	R/W	R/W	5610	M74	R/W	R/W
5547	M11	R/W	R/W	5611	M75	R/W	R/W
5548	M12	R/W	R/W	5612	M76	R/W	R/W
5549	M13	R/W	R/W	5613	M77	R/W	R/W
5550	M14	R/W	R/W	5614	M78	R/W	R/W
5551	M15	R/W	R/W	5615	M79	R/W	R/W
5552	M16	R/W	R/W	5616	M80	R/W	R/W
5553	M17	R/W	R/W	5617	M81	R/W	R/W
5554	M18	R/W	R/W	5618	M82	R/W	R/W
5555	M19	R/W	R/W	5619	M83	R/W	R/W
5556	M20	R/W	R/W	5620	M84	R/W	R/W
5557	M21	R/W	R/W	5621	M85	R/W	R/W
5558	M22	R/W	R/W	5622	M86	R/W	R/W
5559	M23	R/W	R/W	5623	M87	R/W	R/W
5560	M24	R/W	R/W	5624	M88	R/W	R/W
5561	M25	R/W	R/W	5625	M89	R/W	R/W
5562	M26	R/W	R/W	5626	M90	R/W	R/W
5563	M27	R/W	R/W	5627	M91	R/W	R/W
5564	M28	R/W	R/W	5628	M92	R/W	R/W
5565	M29	R/W	R/W	5629	M93	R/W	R/W
5566	M30	R/W	R/W	5630	M94	R/W	R/W
5567	M31	R/W	R/W	5631	M95	R/W	R/W
5568	M32	R/W	R/W	5632	M96	R/W	R/W
5569	M33	R/W	R/W	5633	M97	R/W	R/W
5570	M34	R/W	R/W	5634	M98	R/W	R/W
5571	M35	R/W	R/W	5635	M99	R/W	R/W
5572	M36	R/W	R/W	5636	M100	R/W	R/W
5573	M37	R/W	R/W	5637	M101	R/W	R/W
5574	M38	R/W	R/W	5638	M102	R/W	R/W
5575	M39	R/W	R/W	5639	M103	R/W	R/W
5576	M40	R/W	R/W	5640	M104	R/W	R/W
5577	M41	R/W	R/W	5641	M105	R/W	R/W
5578	M42	R/W	R/W	5642	M106	R/W	R/W
5579	M43	R/W	R/W	5643	M107	R/W	R/W
5580	M44	R/W	R/W	5644	M108	R/W	R/W
5581	M45	R/W	R/W	5645	M109	R/W	R/W
5582	M46	R/W	R/W	5646	M110	R/W	R/W
5583	M47	R/W	R/W	5647	M111	R/W	R/W
5584	M48	R/W	R/W	5648	M112	R/W	R/W
5585	M49	R/W	R/W	5649	M113	R/W	R/W
5586	M50	R/W	R/W	5650	M114	R/W	R/W
5587	M51	R/W	R/W	5651	M115	R/W	R/W
5588	M52	R/W	R/W	5652	M116	R/W	R/W
5589	M53	R/W	R/W	5653	M117	R/W	R/W
5590	M54	R/W	R/W	5654	M118	R/W	R/W
5591	M55	R/W	R/W	5655	M119	R/W	R/W
5592	M56	R/W	R/W	5656	M120	R/W	R/W
5593	M57	R/W	R/W	5657	M121	R/W	R/W
5594	M58	R/W	R/W	5658	M122	R/W	R/W
5595	M59	R/W	R/W	5659	M123	R/W	R/W
5596	M60	R/W	R/W	5660	M124	R/W	R/W
5597	M61	R/W	R/W	5661	M125	R/W	R/W
5598	M62	R/W	R/W	5662	M126	R/W	R/W
5599	M63	R/W	R/W	5663	M127	R/W	R/W
5600	M64	R/W	R/W	5664	M128	R/W	R/W

9.3 UT35A/UT32A/UP35A I Relays

Internal relay				Internal relay			
NO.	I relay symbol	R/W		NO.	I relay symbol	R/W	
		UT35A/UT32A	UP35A			UT35A/UT32A	UP35A
5665	M01_B	R/W	R/W	5729	M65_B	R/W	R/W
5666	M02_B	R/W	R/W	5730	M66_B	R/W	R/W
5667	M03_B	R/W	R/W	5731	M67_B	R/W	R/W
5668	M04_B	R/W	R/W	5732	M68_B	R/W	R/W
5669	M05_B	R/W	R/W	5733	M69_B	R/W	R/W
5670	M06_B	R/W	R/W	5734	M70_B	R/W	R/W
5671	M07_B	R/W	R/W	5735	M71_B	R/W	R/W
5672	M08_B	R/W	R/W	5736	M72_B	R/W	R/W
5673	M09_B	R/W	R/W	5737	M73_B	R/W	R/W
5674	M10_B	R/W	R/W	5738	M74_B	R/W	R/W
5675	M11_B	R/W	R/W	5739	M75_B	R/W	R/W
5676	M12_B	R/W	R/W	5740	M76_B	R/W	R/W
5677	M13_B	R/W	R/W	5741	M77_B	R/W	R/W
5678	M14_B	R/W	R/W	5742	M78_B	R/W	R/W
5679	M15_B	R/W	R/W	5743	M79_B	R/W	R/W
5680	M16_B	R/W	R/W	5744	M80_B	R/W	R/W
5681	M17_B	R/W	R/W	5745	M81_B	R/W	R/W
5682	M18_B	R/W	R/W	5746	M82_B	R/W	R/W
5683	M19_B	R/W	R/W	5747	M83_B	R/W	R/W
5684	M20_B	R/W	R/W	5748	M84_B	R/W	R/W
5685	M21_B	R/W	R/W	5749	M85_B	R/W	R/W
5686	M22_B	R/W	R/W	5750	M86_B	R/W	R/W
5687	M23_B	R/W	R/W	5751	M87_B	R/W	R/W
5688	M24_B	R/W	R/W	5752	M88_B	R/W	R/W
5689	M25_B	R/W	R/W	5753	M89_B	R/W	R/W
5690	M26_B	R/W	R/W	5754	M90_B	R/W	R/W
5691	M27_B	R/W	R/W	5755	M91_B	R/W	R/W
5692	M28_B	R/W	R/W	5756	M92_B	R/W	R/W
5693	M29_B	R/W	R/W	5757	M93_B	R/W	R/W
5694	M30_B	R/W	R/W	5758	M94_B	R/W	R/W
5695	M31_B	R/W	R/W	5759	M95_B	R/W	R/W
5696	M32_B	R/W	R/W	5760	M96_B	R/W	R/W
5697	M33_B	R/W	R/W	5761	M97_B	R/W	R/W
5698	M34_B	R/W	R/W	5762	M98_B	R/W	R/W
5699	M35_B	R/W	R/W	5763	M99_B	R/W	R/W
5700	M36_B	R/W	R/W	5764	M100_B	R/W	R/W
5701	M37_B	R/W	R/W	5765	M101_B	R/W	R/W
5702	M38_B	R/W	R/W	5766	M102_B	R/W	R/W
5703	M39_B	R/W	R/W	5767	M103_B	R/W	R/W
5704	M40_B	R/W	R/W	5768	M104_B	R/W	R/W
5705	M41_B	R/W	R/W	5769	M105_B	R/W	R/W
5706	M42_B	R/W	R/W	5770	M106_B	R/W	R/W
5707	M43_B	R/W	R/W	5771	M107_B	R/W	R/W
5708	M44_B	R/W	R/W	5772	M108_B	R/W	R/W
5709	M45_B	R/W	R/W	5773	M109_B	R/W	R/W
5710	M46_B	R/W	R/W	5774	M110_B	R/W	R/W
5711	M47_B	R/W	R/W	5775	M111_B	R/W	R/W
5712	M48_B	R/W	R/W	5776	M112_B	R/W	R/W
5713	M49_B	R/W	R/W	5777	M113_B	R/W	R/W
5714	M50_B	R/W	R/W	5778	M114_B	R/W	R/W
5715	M51_B	R/W	R/W	5779	M115_B	R/W	R/W
5716	M52_B	R/W	R/W	5780	M116_B	R/W	R/W
5717	M53_B	R/W	R/W	5781	M117_B	R/W	R/W
5718	M54_B	R/W	R/W	5782	M118_B	R/W	R/W
5719	M55_B	R/W	R/W	5783	M119_B	R/W	R/W
5720	M56_B	R/W	R/W	5784	M120_B	R/W	R/W
5721	M57_B	R/W	R/W	5785	M121_B	R/W	R/W
5722	M58_B	R/W	R/W	5786	M122_B	R/W	R/W
5723	M59_B	R/W	R/W	5787	M123_B	R/W	R/W
5724	M60_B	R/W	R/W	5788	M124_B	R/W	R/W
5725	M61_B	R/W	R/W	5789	M125_B	R/W	R/W
5726	M62_B	R/W	R/W	5790	M126_B	R/W	R/W
5727	M63_B	R/W	R/W	5791	M127_B	R/W	R/W
5728	M64_B	R/W	R/W	5792	M128_B	R/W	R/W

5793 to 6048: Free area

Peer-to-peer communication register				Peer-to-peer communication register			
NO.	I relay symbol	R/W		NO.	I relay symbol	R/W	
		UT35A/UT32A	UP35A			UT35A/UT32A	UP35A
6049	CF01	R	R	6113	CI01	R	R
6050	CF02	R	R	6114	CI02	R	R
6051	CF03	R	R	6115	CI03	R	R
6052	CF04	R	R	6116	CI04	R	R
6053				6117	CI05	R	R
6054				6118	CI06	R	R
6055				6119	CI07	R	R
6056				6120	CI08	R	R
6057				6121	CI09	R	R
6058				6122	CI10	R	R
6059				6123	CI11	R	R
6060				6124	CI12	R	R
6061				6125	CI13	R	R
6062				6126	CI14	R	R
6063				6127	CI15	R	R
6064				6128	CI16	R	R
6065	CE01	R	R	6129	CI17	R	R
6066	CE02	R	R	6130	CI18	R	R
6067	CE03	R	R	6131	CI19	R	R
6068	CE04	R	R	6132	CI20	R	R
6069				6133	CI21	R	R
6070				6134	CI22	R	R
6071				6135	CI23	R	R
6072				6136	CI24	R	R
6073				6137	CI25	R	R
6074				6138	CI26	R	R
6075				6139	CI27	R	R
6076				6140	CI28	R	R
6077				6141	CI29	R	R
6078				6142	CI30	R	R
6079				6143	CI31	R	R
6080				6144	CI32	R	R
6081	CTL_STOP	R *	R *	6145	CI33	R	R
6082				6146	CI34	R	R
6083				6147	CI35	R	R
6084				6148	CI36	R	R
6085				6149	CI37	R	R
6086				6150	CI38	R	R
6087				6151	CI39	R	R
6088				6152	CI40	R	R
6089				6153	CI41	R	R
6090				6154	CI42	R	R
6091				6155	CI43	R	R
6092				6156	CI44	R	R
6093				6157	CI45	R	R
6094				6158	CI46	R	R
6095				6159	CI47	R	R
6096				6160	CI48	R	R
6097				6161	CI49	R	R
6098				6162	CI50	R	R
6099				6163	CI51	R	R
6100				6164	CI52	R	R
6101				6165	CI53	R	R
6102				6166	CI54	R	R
6103				6167	CI55	R	R
6104				6168	CI56	R	R
6105				6169	CI57	R	R
6106				6170	CI58	R	R
6107				6171	CI59	R	R
6108				6172	CI60	R	R
6109				6173	CI61	R	R
6110				6174	CI62	R	R
6111				6175	CI63	R	R
6112				6176	CI64	R	R

*: R/W when the LL50A Parameter Setting Software is used.

9.3 UT35A/UT32A/UP35A I Relays

Peer-to-peer communication register				Free area			
NO.	I relay symbol	R/W		NO.	I relay symbol	R/W	
		UT35A/UT32A	UP35A			UT35A/UT32A	UP35A
6177	CO01	R *	R *	6241			
6178	CO02	R *	R *	6242			
6179	CO03	R *	R *	6243			
6180	CO04	R *	R *	6244			
6181	CO05	R *	R *	6245			
6182	CO06	R *	R *	6246			
6183	CO07	R *	R *	6247			
6184	CO08	R *	R *	6248			
6185	CO09	R *	R *	6249			
6186	CO10	R *	R *	6250			
6187	CO11	R *	R *	6251			
6188	CO12	R *	R *	6252			
6189	CO13	R *	R *	6253			
6190	CO14	R *	R *	6254			
6191	CO15	R *	R *	6255			
6192	CO16	R *	R *	6256			
6193				6257			
6194				6258			
6195				6259			
6196				6260			
6197				6261			
6198				6262			
6199				6263			
6200				6264			
6201				6265			
6202				6266			
6203				6267			
6204				6268			
6205				6269			
6206				6270			
6207				6271			
6208				6272			
6209				6273			
6210				6274			
6211				6275			
6212				6276			
6213				6277			
6214				6278			
6215				6279			
6216				6280			
6217				6281			
6218				6282			
6219				6283			
6220				6284			
6221				6285			
6222				6286			
6223				6287			
6224				6288			
6225				6289			
6226				6290			
6227				6291			
6228				6292			
6229				6293			
6230				6294			
6231				6295			
6232				6296			
6233				6297			
6234				6298			
6235				6299			
6236				6300			
6237				6301			
6238				6302			
6239				6303			
6240				6304			

*: R/W when the LL50A Parameter Setting Software is used.

Input (Status) Relay and Output (Status) Relay (5025 to 5280)

I relay No.	Symbol	Description
5025 to 5040	X_DI1 to X_DI2 *	DI1-DI2 status (Same as D7011) *
5041 to 5056	X_DI11 to X_DI15	DI11-DI15 status (Same as D7012)
5057 to 5072		
5073 to 5088		
5089 to 5104	X_DI41 to X_DI45	DI41-DI45 status (Same as D7015)
5105 to 5152		
5153 to 5168	Y_AL1 to Y_AL3	AL1-AL3 status (Same as D7161)
5169 to 5184	Y_DO11 to Y_DO15	DO11-DO15 status (Same sa D7162)
5185 to 5200		
5201 to 5216		
5217 to 5232	Y_DO41 to Y_DO45	DO41-DO45 status (Same as D7165)
5233 to 5280		

*: UP35A; X_DI1 to X_DI3 (DI1-DI3 status (Same as D7011))

Control (Status) Relay (5281 to 5408)

I relay No.	Symbol	Description
5281 to 5296	AL1_CTL to AL3_CTL	Control AL1-AL3 status (Same as D7111)
5297 to 5312	DO11_CTL to DO15_CTL	Control DO11-DO15 status (Same as D7112)
5313 to 5328		
5329 to 5344		
5345 to 5360	DO41_CTL to DO45_CTL	Control DOI41-DO45 status (Same as D7115)
5361 to 5408		

Special Relay (5409 to 5536)

I relay No.	Symbol	Description	
5409 to 5424	TIM1 to TIM4	Time out flag (Same as D7221)	
5425 to 5440	CNT1 to CNT4	Time out flag (Same as D7222)	
5441	SMPCLK	Input sampling period (control period) clock	
5442	CLK1	1-second clock	
5443	CLK2	2-second clock	
5444	CLK10	10-second clock	
5445	CLK60	60-second clock	
5447	CLK1P	1-second clock pulse	
5448	CLK2P	2-second clock pulse	
5449	CLK10P	10-second clock pulse	
5450	CLK60P	60-second clock pulse	
5457	PON	Power on flag	0: Power-on and initializing 1: During operation
5458	PLS1	Always ON	1: ON
5459	ZERO	Always OFF	0: OFF
5461	PDLVL	Power failure detection level *1	0: Power failure of about 5 seconds or more 1: Power failure of about less than 5 seconds
5473 to 5536	Free area		

*1: No power failure is detected in the following cases, and the unit maintains normal operations.

- A momentary power failure of 20 ms or less in the case of 100 – 240 V AC
- A momentary power failure of 1 ms in the case of 24 V AC/DC

9.3 UT35A/UT32A/UP35A I Relays

Internal Relay (5537 to 5792)

I relay No.	Symbol	Description
5537 to 5664	M01 to M128	You can read/write data from/to the area via communication. (Same as D7201 to D7208) That is, you can use the area freely without affecting the control function of the UTAdvanced
5665 to 5696	M01_B to M32_B	You can read/write data from/to the area via communication. (Same as D7211 to D7212) That is, you can use the area freely without affecting the control function of the UTAdvanced
5697 to 5792	M33_B to M128_B	You can read/write data from/to the area via communication. (Same as D7213 to D7218) That is, you can use the area freely without affecting the control function of the UTAdvanced
5793 to 6048		

Peer-to-peer Communication Register (6049 to 6304)

I relay No.	Symbol	Description
6049 to 6064	CF01 to CF04	Reception timeout flag-1 for peer-to-peer communication to Reception timeout flag-4 for peer-to-peer communication 0: OFF 1: ON
6065 to 6080	CE01 to CE04	End of data reception flag-1 for peer-to-peer communication to End of data reception flag-4 for peer-to-peer communication 0: OFF 1: ON
6081	CTL_STOP	Control computation start/stop flag for peer-to-peer communication 0: Normal operation 1: Stop control computation
6097 to 6112		
6113 to 6176	CI01 to CI64	Status input relay-1 for peer-to-peer communication to Status input relay-64 for peer-to-peer communication 0: OFF 1: ON
6177 to 6192	CO01 to CO16	Status output relay-1 for peer-to-peer communication to Status output relay-16 for peer-to-peer communication 0: OFF 1: ON
6193 to 6240		
6241 to 6304	Free area	

9.3.3 Input / Output Terminal Status (6305 to 6560)

Note

When specifying an I relay number for communication, begin the number with the character "I."
Example: Set "I6305" to specify the DI1 (I relay No.: 6305).

9.3 UT35A/UT32A/UP35A I Relays

DI terminals				DI terminals			
NO.	I relay symbol	R/W		NO.	I relay symbol	R/W	
		UT35A/UT32A	UP35A			UT35A/UT32A	UP35A
6305	DI1	R	R	6369	DI41	R	R
6306	DI2	R	R	6370	DI42	R	R
6307	DI3		R	6371	DI43	R	R
6308				6372	DI44	R	R
6309				6373	DI45	R	R
6310				6374			
6311				6375			
6312				6376			
6313				6377			
6314				6378			
6315				6379			
6316				6380			
6317				6381			
6318				6382			
6319				6383			
6320				6384			
6321	DI11	R	R	6385			
6322	DI12	R	R	6386			
6323	DI13	R	R	6387			
6324	DI14	R	R	6388			
6325	DI15	R	R	6389			
6326				6390			
6327				6391			
6328				6392			
6329				6393			
6330				6394			
6331				6395			
6332				6396			
6333				6397			
6334				6398			
6335				6399			
6336				6400			
6337				6401			
6338				6402			
6339				6403			
6340				6404			
6341				6405			
6342				6406			
6343				6407			
6344				6408			
6345				6409			
6346				6410			
6347				6411			
6348				6412			
6349				6413			
6350				6414			
6351				6415			
6352				6416			
6353				6417			
6354				6418			
6355				6419			
6356				6420			
6357				6421			
6358				6422			
6359				6423			
6360				6424			
6361				6425			
6362				6426			
6363				6427			
6364				6428			
6365				6429			
6366				6430			
6367				6431			
6368				6432			

DO terminals				DO terminals			
NO.	I relay symbol	R/W		NO.	I relay symbol	R/W	
		UT35A/UT32A	UP35A			UT35A/UT32A	UP35A
6433	OUT_AL1	R	R	6497	OUT_DO41	R	R
6434	OUT_AL2	R	R	6498	OUT_DO42	R	R
6435	OUT_AL3	R	R	6499	OUT_DO43	R	R
6436				6500	OUT_DO44	R	R
6437				6501	OUT_DO45	R	R
6438				6502			
6439				6503			
6440				6504			
6441				6505			
6442				6506			
6443				6507			
6444				6508			
6445				6509			
6446				6510			
6447				6511			
6448				6512			
6449	OUT_DO11	R	R	6513			
6450	OUT_DO12	R	R	6514			
6451	OUT_DO13	R	R	6515			
6452	OUT_DO14	R	R	6516			
6453	OUT_DO15	R	R	6517			
6454				6518			
6455				6519			
6456				6520			
6457				6521			
6458				6522			
6459				6523			
6460				6524			
6461				6525			
6462				6526			
6463				6527			
6464				6528			
6465				6529			
6466				6530			
6467				6531			
6468				6532			
6469				6533			
6470				6534			
6471				6535			
6472				6536			
6473				6537			
6474				6538			
6475				6539			
6476				6540			
6477				6541			
6478				6542			
6479				6543			
6480				6544			
6481				6545			
6482				6546			
6483				6547			
6484				6548			
6485				6549			
6486				6550			
6487				6551			
6488				6552			
6489				6553			
6490				6554			
6491				6555			
6492				6556			
6493				6557			
6494				6558			
6495				6559			
6496				6560			

6561 to 7072: Free area

9.3 UT35A/UT32A/UP35A I Relays

DI Terminals and DO Terminals (6305 to 6560)

I relay No.	Symbol	Description
6305 to 6320	DI1 to DI2 *	DI1-DI2 status (Same as D7601) *
6321 to 6336	DI11 to DI15	DI11-DI15 status (Same as D7602)
6337 to 6352		
6353 to 6368		
6369 to 6384	DI41 to DI45	DI41-DI45 status (Same as D7605)
6385 to 6432		
6433 to 6448	OUT_AL1 to OUT_AL3	AL1-AL3 status (Same as D7611)
6449 to 6464	OUT_DO11 to OUT_DO15	DO11-DO15 status (Same as D7612)
6465 to 6480		
6481 to 6496		
6497 to 6512	OUT_DO41 to OUT_DO45	DO41-DO45 status (Same as D7615)
6513 to 6560		

*: UP35A; DI1 to DI3 (DI1-DI3 status (Same as D7601))

9.4 Reading via Communication

■ When reading the alarm status

Read I relay numbers 4321 to 4336 for alarm-1 to alarm-4 status.

I relay No.	Symbol	Event
4321 to 4336	ALM1_L1~ALM4_L1	Alarm-1 to alarm-4 status (Same as D2011) *
⋮	⋮	⋮
4545 to 4576		

*: The contents of alarm-1 to alarm-4 status (I relay numbers 4321 to 4336: ALM1_L1 to ALM4_L1) are the same as the bit configuration of D register number D2011 (alarm-1 to alarm-4 status). Refer to the bit configuration of D2011 described in “Chapter 9 Functions and Applications of D Registers (for UT35A/UT32A/UP35A).”

The following shows the bit configuration of D2011 described in “Chapter 8 Functions and Applications of D Registers (for UT35A/UT32A/UP35A).”

● Bit Configuration of D2011: ALM_L1 (Alarm-1 to alarm-4 status)

Bit	Symbol	Event
0	ALM1_L1	'1' when alarm 1 is ON; '0' when OFF
1	ALM2_L1	'1' when alarm 2 is ON; '0' when OFF
2	ALM3_L1	'1' when alarm 3 is ON; '0' when OFF
3		
4	ALM4_L1	'1' when alarm 4 is ON; '0' when OFF
5 to 15		

Note

When specifying an I relay number for communication, begin the number with the character “I.”
Example: Set “I4321” to specify the ALM1_L1 (I relay No.: 4321).

9.5 GREEN Series Compatible I Relays

9.5.1 Compatibility with GREEN Series Controllers

The map configuration from 1 to 2048 of the I relay map is the same as that of the GREEN Series (UT300 Series) controllers.

If existing programs created in the GREEN Series controllers are used, communication is performed using the area from 0001 to 0784.

The I relay map after 4001 is allocated for the UTAdvanced.

If you want to newly perform communication, be sure to use the registers after 4001.

9.5.2 Conventions Used in I Relay Tables

■ How to Specify I Relay Numbers

When specifying an I relay number for communication, begin the number with the character "I."

Example: Set "I0001" to specify the ADERR (I relay No.: 0001).

■ Interpretation of Cell

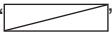
A cell marked with a diagonal line (") indicates that it is not supported by the UTAdvanced.

■ I relay symbol

- With regards to some register symbols, the loop number is indicated by adding the underline () to the end of the parameter symbols.

Note

Since the UT35A/UT32A is a single-loop controller, it has no distinction between Loop-1 and Loop-2.

However, the register symbol has "L1" which indicates Loop-1.

□□□□ L1 L1: Loop numbers

Example : **PVBO L1** Indicates PVBO.

- Numbers in parentheses after the register symbols of the UTAdvanced indicate the same I relay after I4001.

Note

-
- I relay numbers 1 to 192 store ON/OFF status information and are normally read for ON/OFF status information. I relay numbers 1 to 192 also exists in D registers. They have the same function data as D registers.
 - In the area for I relay numbers 1 to 720, it is prohibited to write data to I relays with blank cells in I relay map tables. If you attempt to do so, the UTAdvanced may not operate properly.
-

9.5.3 Status (0001 to 0192)

UT35A/UT32A

NO.	I relay symbol		NO.	I relay symbol		NO.	I relay symbol	
	GREEN	UTAdvanced		GREEN	UTAdvanced		GREEN	UTAdvanced
1	ADERROR	ADERR (4065)	65	AUT/MAN	A.M (4193) *1	129		
2			66			130		
3			67	S/R	S.R (4193)	131		
4			68			132		
5			69			133		
6			70			134		
7			71			135		
8			72			136		
9			73			137		
10			74			138		
11			75			139		
12			76			140		
13			77			141		
14			78			142		
15			79	AT	AT_L1_ON (4207)	143		
16			80			144		
17			81			145		
18	PVBO	PVBO_L1 (4097)	82			146		
19	RJCERR	RJCERR (4070)	83			147		
20			84			148		
21	PV+over	PVPOVER_L1 (4101)	85			149		
22	PV-over	PVMOVER_L1 (4102)	86			150		
23			87			151		
24			88			152		
25			89			153		
26			90			154		
27			91			155		
28			92			156		
29			93			157		
30			94			158		
31	AT.E	ATERR_L1 (4111)	95			159		
32			96			160		
33			97	ALM1	ALM1_L1 (4321)	161		
34			98	ALM2	ALM2_L1 (4322)	162		
35			99	ALM3	ALM3_L1 (4323)	163		
36			100			164		
37			101			165		
38			102	OR		166		
39			103			167		
40			104			168		
41			105			169		
42			106			170		
43			107			171		
44			108			172		
45			109			173		
46			110			174		
47			111			175		
48			112			176		
49	CALB.E	CALB_ERR (4002)	113			177		
50			114			178		
51			115			179		
52			116			180		
53			117			181		
54			118			182		
55	SETUP	SETPA_ERR (4005)	119			183		
56			120			184		
57	PARA.E	OPEPA_ERR (4006)	121			185		
58			122			186		
59			123			187		
60			124			188		
61	EEP.E	FRAM_ERR (4009)	125			189		
62			126			190		
63	SYSTEM.E	SYSTEM_ERR (4001)	127			191		
64			128			192		

193 to 640: Free area

9.5 I Relays Corresponding to GREEN Series

I relay No.	Symbol	Description
1 to 16	ADERR	A/D converter error status for GREEN Series (Same as 0001)
17 to 32	PVBO_L1 to ATERR_L1	PV input error status for GREEN Series (Same as 0002)
33 to 48		
49 to 64	CALB_ERR to SYSTEM_ERR	Parameter error status for GREEN Series (Same as 0035)
65 to 80	A.M to AT_L1_ON	Operation mode status for GREEN Series (Same as 0008)
81 to 96		
97 to 112	ALM1_L1 to ALM3_L1	Alarm status for GREEN Series (Same as 0011)
113 to 192		

193 to 640: Free area

UP35A

NO.	I relay symbol		NO.	I relay symbol		NO.	I relay symbol	
	GREEN	UTAdvanced		GREEN	UTAdvanced		GREEN	UTAdvanced
	Status							
1	ADERROR	ADERR (4065)	65			129	TIME1	TIME_EV1 (4817)
2			66			130		
3			67			131		
4			68			132		
5			69			133		
6			70			134		
7			71			135		
8			72			136		
9			73	RESET	RST_ON (4181)	137		
10			74	PROG1	PT1 (4849)	138		
11			75	PROG2	PT2 (4850)	139		
12			76			140		
13			77	HOLD	HOLD_ON (4189)	141		
14			78	WAIT	WAITF (4190)	142		
15			79	AT1	AT_L1_ON (4191)	143		
16			80			144		
17			81			145		
18	PVBO	PVBO_L1 (4097)	82			146		
19	RJCERR	RJCERR (4070)	83			147		
20			84			148		
21	PV+over	PVPOVER_L1 (4101)	85			149		
22	PV-over	PVMOVER_L1 (4102)	86			150		
23			87			151		
24			88			152		
25			89			153		
26			90			154		
27			91			155		
28			92			156		
29			93			157		
30			94			158		
31	AT.E	ATERR_L1 (4111)	95			159		
32			96			160		
33			97			161		
34			98			162		
35			99			163		
36			100			164		
37			101			165		
38			102	OR		166		
39			103			167		
40			104			168		
41			105			169		
42			106			170		
43			107			171		
44			108			172		
45			109			173		
46			110			174		
47			111			175		
48			112			176		
49	CALB.E	CALB_ERR (4002)	113	PVE1	PV_EV1 (4785)	177		
50			114	PVE2	PV_EV2 (4786)	178		
51			115			179		
52			116			180		
53			117			181		
54			118			182		
55	SETUP	SETPA_ERR (4005)	119			183		
56			120			184		
57	PARA.E	OPEPA_ERR (4006)	121			185		
58			122			186		
59			123			187		
60			124			188		
61	EEP.E	FRAM_ERR (4009)	125			189		
62			126			190		
63	SYSTEM.E	SYSTEM_ERR (4001)	127			191		
64			128			192		

193 to 640: Free area

9.5 I Relays Corresponding to GREEN Series

I relay No.	Symbol	Description
1 to 16	ADERR to VALVBO	A/D converter error status for GREEN Series (Same as D0001)
17 to 32	PVBO_L1 to ATERR_L1	PV input error status for GREEN Series (Same as D0002)
33 to 48		
49 to 64	CALB_ERR to SYSTEM_ERR	Parameter error status for GREEN Series (Same as D0035)
65 to 80	RST_ON to AT_L1_ON	Operation mode status for GREEN Series (Same as D0008)
81 to 112		
113 to 128	PV_EV1 to PV_EV2	PV event 1-2 status for GREEN Series (Same as D0012)
129 to 144	TIME_EV1	Time event status for GREEN Series (Same as D0013)
145 to 192		

193 to 576: Free area

9.5.4 User Area (0721 to 784)

I relay No.	I relay symbol	Description	
721 to 784	USER	User area	You can read/write data from/to the area for I relays 721 to 784 via communication. That is, you can use the area freely without affecting the control function of the UTAdvanced. However, the data cannot be saved.

10.1 Overview

This chapter describes the functions and applications of the D registers. D registers are used in Modbus, PC link, ladder, Ethernet communications, or Open Network communication (network profile creating function of LL50A) and are used for storing UTAdvanced parameter data, flag data, process data, and other data and values. The host computer can utilize these data by reading from and writing to the D registers. When you newly perform communication with the UTAdvanced, the D registers after D2001 are used.

Use of the D registers enables the following:

- Centralized control by the host computer
- Reading and writing of data between the UTAdvanced and the host computer

Note

The D registers available vary depending on the model and suffix codes of the UTAdvanced or parameter settings. For details, refer to the respective UTAdvanced User's Manual.

D registers and I relays on the UTAdvanced are used for parameter settings or ladder program creations of LL50A Parameter Setting Software.

10.3 Classification of D Registers

■ Classification of D Register Map Tables

The table on next page outlines how the D registers are classified by their numbers in the D register map tables.

When you newly perform communication with the UTAdvanced, the D registers after D2001 are used.

CAUTION

- Check the model and suffix codes and parameter settings before writing to or read from the registers to be used.
- No data can be written to or read from blank parts of the data storage area by communication.
The UTAdvanced sometimes does not operate properly if an attempt is made to write to or read from blank parts of the data storage area.

■ Setting a Value with a Decimal Point

When setting a value with a decimal point from the host computer, set a value excluding the decimal point (hexadecimal)*.

Note

The UTAdvanced determine the decimal point position by the parameter setting.

Example: When setting a target setpoint "50.0" from the host computer

Set "1F4" which is a hexadecimal value of "500" (50.0 excluding the decimal point) (this is also true for setting 5.00 or 500).

Target setpoint "50.0": P.DP = 1

Target setpoint "5.00": P.DP = 2

Target setpoint "500": P.DP = 0

*: For ladder operation, set the BCD value excluding the decimal point.

10.3 Classification of D Registers

Classification of D Registers

Register No.	Area and data categories	Description	Reference		
D0001 to D0049	Configuration map for GREEN Series (See 10.6 GREEN Series Compatible D Registers)	Process data	Sections 10.6.3		
D0050 to D0100		User area	Sections 10.6.3		
D0101 to D0200		Cannot be used			
D0201 to D0300		Operation-related parameter	Sections 10.6.4		
D0301 to D0900		Free area			
D0901 to D1000		Alarm function parameter	Sections 10.6.5		
D1001 to D1100		Common function parameter	Sections 10.6.6		
D1101 to D1200		SELECT Display Setting parameter	Sections 10.6.7		
D1201 to D1300		PV input / Communication parameter	Sections 10.6.8		
D1301 to D2000		Free area			
D2001 to D2100	Process monitoring	Process data	Sections 10.4.1		
D2101 to D2300	Free area	Free area			
D2301 to D2400	Operation parameter	Alarm Setpoint Setting	Sections 10.4.2		
D2401 to D2800		Free area			
D2801 to D2900		Alarm function setting			
D2901 to D3000		PV-related setting			
D3001 to D4800	Free area	Free area			
D4801 to D5000	10-segment linearizer setting parameter	10-segment linearizer setting	Sections 10.4.3		
D5001 to D5100	Setup parameter	Function setting	Sections 10.4.4		
D5101 to D5300		Input setting			
D5301 to D5400		Output setting			
D5401 to D5500		Free area			
D5501 to D5700		Communication setting			
D5701 to D5800		Key action setting / Display function setting / SELECT display setting			
D5801 to D5900		Lock setting (Key lock / menu lock)			
D5901 to D6200		DI function setting			
D6201 to D6300		DO function setting			
D6301 to D6400		I/O display			
D6401 to D6500		System setting			
D6501 to D7600		Free area		Free area	
D7601 to D7700		Terminal status register		Input / Output terminal status register	Sections 10.4.5

Note 1: Data in the process values, operation parameters, and setup parameters is stored in the format (data excluding the decimal point of PV input range, PV input range span, %, or ABS) described in "Lists of Operation Parameters" and "Lists of Setup Parameters" in the UTAdvanced Operation Guide or User's Manual.
The OFF status of data is indicated by "0" and the ON status is indicated by "1."
D registers D2001 to D2100 are read-only.

10.4 UM33A D Registers

10.4.1 Process Monitoring (D2001 to D2300)

Process monitoring area									
Process data									
D-Reg No.	Ref. No.	H No.	Register symbol	R/W	D-Reg No.	Ref. No.	H No.	Register symbol	R/W
				UM33A					UM33A
D2001	42001	07D0	AD1.E	R	D2051	42051	0802		
D2002	42002	07D1	PV1.E_L1	R	D2052	42052	0803		
D2003	42003	07D2	PV_L1	R	D2053	42053	0804		
D2004	42004	07D3			D2054	42054	0805		
D2005	42005	07D4			D2055	42055	0806		
D2006	42006	07D5			D2056	42056	0807		
D2007	42007	07D6			D2057	42057	0808		
D2008	42008	07D7			D2058	42058	0809		
D2009	42009	07D8			D2059	42059	080A		
D2010	42010	07D9			D2060	42060	080B		
D2011	42011	07DA	ALM_L1	R	D2061	42061	080C		
D2012	42012	07DB			D2062	42062	080D		
D2013	42013	07DC			D2063	42063	080E		
D2014	42014	07DD			D2064	42064	080F		
D2015	42015	07DE			D2065	42065	0810		
D2016	42016	07DF			D2066	42066	0811	DIMG	R
D2017	42017	07E0			D2067	42067	0812		
D2018	42018	07E1			D2068	42068	0813	PA.ER	R
D2019	42019	07E2			D2069	42069	0814		
D2020	42020	07E3			D2070	42070	0815	OPER	R
D2021	42021	07E4			D2071	42071	0816	ALOLA1_L1	R
D2022	42022	07E5			D2072	42072	0817		
D2023	42023	07E6			D2073	42073	0818	ALOLA2_L1	R
D2024	42024	07E7			D2074	42074	0819		
D2025	42025	07E8			D2075	42075	081A	ALOLA3_L1	R
D2026	42026	07E9			D2076	42076	081B		
D2027	42027	07EA			D2077	42077	081C	ALOLA4_L1	R
D2028	42028	07EB			D2078	42078	081D		
D2029	42029	07EC			D2079	42079	081E		
D2030	42030	07ED			D2080	42080	081F		
D2031	42031	07EE			D2081	42081	0820		
D2032	42032	07EF			D2082	42082	0821		
D2033	42033	07F0			D2083	42083	0822		
D2034	42034	07F1			D2084	42084	0823		
D2035	42035	07F2			D2085	42085	0824		
D2036	42036	07F3			D2086	42086	0825		
D2037	42037	07F4	ALO_L1	R	D2087	42087	0826		
D2038	42038	07F5			D2088	42088	0827		
D2039	42039	07F6			D2089	42089	0828		
D2040	42040	07F7			D2090	42090	0829		
D2041	42041	07F8			D2091	42091	082A		
D2042	42042	07F9			D2092	42092	082B		
D2043	42043	07FA			D2093	42093	082C		
D2044	42044	07FB			D2094	42094	082D		
D2045	42045	07FC			D2095	42095	082E		
D2046	42046	07FD			D2096	42096	082F		
D2047	42047	07FE			D2097	42097	0830		
D2048	42048	07FF			D2098	42098	0831		
D2049	42049	0800			D2099	42099	0832		
D2050	42050	0801			D2100	42100	0833		

D2201 to D2300: Free area

10.4 UM33A D Registers

Process Data Area

Some of the D registers represent multiple events such as errors and status depending on combinations of bits in the register.

In the following tables, if an event indicated by a specific bit occurs, the state of that bit changes to "1."

If no event occurs, the state of that bit is "0." Blank lines in each table indicate unused bits.

Process Data (D2001 to D2100)

● Bit Configuration of D2001: AD1.E (A/D converter error status 1)

Bit	Symbol	Event
0	ADERR	PV input A/D converter error
1 to 4		
5	RJCERR	PV input RJC error
6 to 7		
8	ADBO	PV input burnout error
9 to 15		

● Bit Configuration of D2002: PV1.E_L1 (PV input error status)

Bit	Symbol	Event
0	PVBO_L1	PV input burnout error
1 to 3		
4	PVPOVER_L1	PV input over-scale
5	PVMOVER_L1	PV input under-scale
6 to 15		

● D2003 to D2007

Register No.	Description	Range and meaning of value
D2003	PV_L1	Measurement value -5.0 to 105.0% of PV input range (EU)

● Bit Configuration of D2011: ALM_L1 (Alarm-1 to alarm-8 status)

Bit	Symbol	Event
0	ALM1_L1	'1' when Alarm 1 is ON; '0' when OFF
1	ALM2_L1	'1' when Alarm 2 is ON; '0' when OFF
2	ALM3_L1	'1' when Alarm 3 is ON; '0' when OFF
3		
4	ALM4_L1	'1' when Alarm 4 is ON; '0' when OFF
5	ALM5_L1	'1' when Alarm 5 is ON; '0' when OFF
6	ALM6_L1	'1' when Alarm 6 is ON; '0' when OFF
7		
8	ALM7_L1	'1' when Alarm 7 is ON; '0' when OFF
9	ALM8_L1	'1' when Alarm 8 is ON; '0' when OFF
10 to 15		

● **Bit Configuration of D2037: ALO_L1 (Alarm-1 to alarm-8 output status)**

Bit	Symbol	Event
0	ALO1_L1	Output status where Alarm output 1 is assigned. 0: When the alarm is turned off (alarm type: energized), or the alarm is turned on (alarm type: de-energized). (The relay contact is open.) 1: When the alarm is turned on (alarm type: energized), or the alarm is turned off (alarm type: de-energized). (The relay contact is closed.)
1	ALO2_L1	Output status where Alarm output 2 is assigned. For bit information, same as bit 0.
2	ALO3_L1	Output status where Alarm output 3 is assigned. For bit information, same as bit 0.
3		
4	ALO4_L1	Output status where Alarm output 4 is assigned. For bit information, same as bit 0.
5	ALO5_L1	Output status where Alarm output 5 is assigned. For bit information, same as bit 0.
6	ALO6_L1	Output status where Alarm output 6 is assigned. For bit information, same as bit 0.
7		
8	ALO7_L1	Output status where Alarm output 7 is assigned. For bit information, same as bit 0.
9	ALO8_L1	Output status where Alarm output 8 is assigned. For bit information, same as bit 0.
10 to 15		

● **Bit Configuration of D2066: DIMG (Message display interruption status)**

Bit	Symbol	Event
0	MG1.B	Message display interruption 1 (1: displayed, 0: not displayed)
1	MG2.B	Message display interruption 2 (1: displayed, 0: not displayed)
2	MG3.B	Message display interruption 3 (1: displayed, 0: not displayed)
3		
4	MG4.B	Message display interruption 4 (1: displayed, 0: not displayed)
5 to 15		

● **Bit Configuration of D2068: PA.ER (Parameter error status)**

Bit	Symbol	Event
0	SYSTEM_ERR	System data error
1	CALB_ERR	Calibration value error
2	UPARA_ERR	User (parameter) default value error
3		
4	SETPA_ERR	Setup parameter error
5	OPEPA_ERR	Operation parameter error
6 to 7		
8	FRAM_ERR	Faulty FRAM
9		
10	CTLPA_ERR	Control parameter error
11 to 15		

● **Bit Configuration of D2070: OP.ER (Option error status)**

Bit	Symbol	Event
0	E1_ERR	Nonresponding hardware of E1 terminal area
1 to 7		
8	COM_E1_ERR	Communication error E1 terminal area
9 to 15		

10.4 UM33A D Registers

● Bit Configuration of D2071: ALOLA1_L1 (Alarm-1 to alarm-8 latch output status)

Bit	Symbol	Event
0	ALO1LA1_L1	Alarm-1 latch-1 output status
1	ALO2LA1_L1	Alarm-2 latch-1 output status
2	ALO3LA1_L1	Alarm-3 latch-1 output status
3		
4	ALO4LA1_L1	Alarm-4 latch-1 output status
5	ALO5LA1_L1	Alarm-5 latch-1 output status
6	ALO6LA1_L1	Alarm-6 latch-1 output status
7		
8	ALO7LA1_L1	Alarm-7 latch-1 output status
9	ALO8LA1_L1	Alarm-8 latch-1 output status
10 to 15		

● Bit Configuration of D2073: ALOLA2_L1 (Alarm-1 to alarm-8 latch-2 output status)

Bit	Symbol	Event
0	ALO1LA2_L1	Alarm-1 latch-2 output status
1	ALO2LA2_L1	Alarm-2 latch-2 output status
2	ALO3LA2_L1	Alarm-3 latch-2 output status
3		
4	ALO4LA2_L1	Alarm-4 latch-2 output status
5	ALO5LA2_L1	Alarm-5 latch-2 output status
6	ALO6LA2_L1	Alarm-6 latch-2 output status
7		
8	ALO7LA2_L1	Alarm-7 latch-2 output status
9	ALO8LA2_L1	Alarm-8 latch-2 output status
10 to 15		

● Bit Configuration of D2075: ALOLA3_L1 (Alarm-1 to alarm-8 latch-3 output status)

Bit	Symbol	Event
0	ALO1LA3_L1	Alarm-1 latch-3 output status
1	ALO2LA3_L1	Alarm-2 latch-3 output status
2	ALO3LA3_L1	Alarm-3 latch-3 output status
3		
4	ALO4LA3_L1	Alarm-4 latch-3 output status
5	ALO5LA3_L1	Alarm-5 latch-3 output status
6	ALO6LA3_L1	Alarm-6 latch-3 output status
7		
8	ALO7LA3_L1	Alarm-7 latch-3 output status
9	ALO8LA3_L1	Alarm-8 latch-3 output status
10 to 15		

● Bit Configuration of D2077: ALOLA4_L1 (Alarm-1 to alarm-8 latch-4 output status)

Bit	Symbol	Event
0	ALO1LA4_L1	Alarm-1 latch-4 output status
1	ALO2LA4_L1	Alarm-2 latch-4 output status
2	ALO3LA4_L1	Alarm-3 latch-4 output status
3		
4	ALO4LA4_L1	Alarm-4 latch-4 output status
5	ALO5LA4_L1	Alarm-5 latch-4 output status
6	ALO6LA4_L1	Alarm-6 latch-4 output status
7		
8	ALO7LA4_L1	Alarm-7 latch-4 output status
9	ALO8LA4_L1	Alarm-8 latch-4 output status
10 to 15		

Free Area (D2101 to D2300)

Register No.	Description	Range and meaning of value
D2101 to D2300	Free area	

10.4 UM33A D Registers

10.4.2 Operation Parameter (D2301 to D3000)

Operation parameters									
Alarm setpoint setting (Menu: AL)									
D-Reg No.	Ref. No.	H No.	Register Symbol	R/W UM33A	D-Reg No.	Ref. No.	H No.	Register Symbol	R/W UM33A
D2301	42301	08FC			D2351	42351	092E	A1_L1	R/W
D2302	42302	08FD			D2352	42352	092F	A2_L1	R/W
D2303	42303	08FE			D2353	42353	0930	A3_L1	R/W
D2304	42304	08FF			D2354	42354	0931	A4_L1	R/W
D2305	42305	0900			D2355	42355	0932	A5_L1	R/W
D2306	42306	0901			D2356	42356	0933	A6_L1	R/W
D2307	42307	0902			D2357	42357	0934	A7_L1	R/W
D2308	42308	0903			D2358	42358	0935	A8_L1	R/W
D2309	42309	0904			D2359	42359	0936	PEAK	R
D2310	42310	0905			D2360	42360	0937	BOTM	R
D2311	42311	0906			D2361	42361	0938		
D2312	42312	0907			D2362	42362	0939		
D2313	42313	0908			D2363	42363	093A		
D2314	42314	0909			D2364	42364	093B		
D2315	42315	090A			D2365	42365	093C		
D2316	42316	090B			D2366	42366	093D		
D2317	42317	090C			D2367	42367	093E		
D2318	42318	090D			D2368	42368	093F		
D2319	42319	090E			D2369	42369	0940		
D2320	42320	090F			D2370	42370	0941		
D2321	42321	0910			D2371	42371	0942		
D2322	42322	0911			D2372	42372	0943		
D2323	42323	0912			D2373	42373	0944		
D2324	42324	0913			D2374	42374	0945		
D2325	42325	0914			D2375	42375	0946		
D2326	42326	0915			D2376	42376	0947		
D2327	42327	0916			D2377	42377	0948		
D2328	42328	0917			D2378	42378	0949		
D2329	42329	0918			D2379	42379	094A		
D2330	42330	0919			D2380	42380	094B		
D2331	42331	091A			D2381	42381	094C		
D2332	42332	091B			D2382	42382	094D		
D2333	42333	091C			D2383	42383	094E		
D2334	42334	091D			D2384	42384	094F		
D2335	42335	091E			D2385	42385	0950		
D2336	42336	091F			D2386	42386	0951		
D2337	42337	0920			D2387	42387	0952		
D2338	42338	0921			D2388	42388	0953		
D2339	42339	0922			D2389	42389	0954		
D2340	42340	0923			D2390	42390	0955		
D2341	42341	0924			D2391	42391	0956		
D2342	42342	0925			D2392	42392	0957		
D2343	42343	0926			D2393	42393	0958		
D2344	42344	0927			D2394	42394	0959		
D2345	42345	0928			D2395	42395	095A		
D2346	42346	0929			D2396	42396	095B		
D2347	42347	092A			D2397	42397	095C		
D2348	42348	092B			D2398	42398	095D		
D2349	42349	092C			D2399	42399	095E		
D2350	42350	092D			D2400	42400	095F		

D2401 to D2800: Free area

Operation parameter									
Alarm function setting (Menu: ALRM)									
D-Reg No.	Ref. No.	H No.	Register symbol	R/W	D-Reg No.	Ref. No.	H No.	Register symbol	R/W
				UM33A					UM33A
D2801	42801	0AF0	AL1.T_L1	R/W	D2851	42851	0B22	DYN3_L1	R/W
D2802	42802	0AF1	AL1.W_L1	R/W	D2852	42852	0B23	DYN4_L1	R/W
D2803	42803	0AF2	AL1.D_L1	R/W	D2853	42853	0B24	DYN5_L1	R/W
D2804	42804	0AF3	AL1.L_L1	R/W	D2854	42854	0B25	DYN6_L1	R/W
D2805	42805	0AF4	AL2.T_L1	R/W	D2855	42855	0B26	DYN7_L1	R/W
D2806	42806	0AF5	AL2.W_L1	R/W	D2856	42856	0B27	DYN8_L1	R/W
D2807	42807	0AF6	AL2.D_L1	R/W	D2857	42857	0B28	DYF1_L1	R/W
D2808	42808	0AF7	AL2.L_L1	R/W	D2858	42858	0B29	DYF2_L1	R/W
D2809	42809	0AF8	AL3.T_L1	R/W	D2859	42859	0B2A	DYF3_L1	R/W
D2810	42810	0AF9	AL3.W_L1	R/W	D2860	42860	0B2B	DYF4_L1	R/W
D2811	42811	0AFA	AL3.D_L1	R/W	D2861	42861	0B2C	DYF5_L1	R/W
D2812	42812	0AFB	AL3.L_L1	R/W	D2862	42862	0B2D	DYF6_L1	R/W
D2813	42813	0AFC	AL4.T_L1	R/W	D2863	42863	0B2E	DYF7_L1	R/W
D2814	42814	0AFD	AL4.W_L1	R/W	D2864	42864	0B2F	DYF8_L1	R/W
D2815	42815	0AFE	AL4.D_L1	R/W	D2865	42865	0B30		
D2816	42816	0AFF	AL4.L_L1	R/W	D2866	42866	0B31		
D2817	42817	0B00	AL5.T_L1	R/W	D2867	42867	0B32		
D2818	42818	0B01	AL5.W_L1	R/W	D2868	42868	0B33		
D2819	42819	0B02	AL5.D_L1	R/W	D2869	42869	0B34		
D2820	42820	0B03	AL5.L_L1	R/W	D2870	42870	0B35		
D2821	42821	0B04	AL6.T_L1	R/W	D2871	42871	0B36		
D2822	42822	0B05	AL6.W_L1	R/W	D2872	42872	0B37		
D2823	42823	0B06	AL6.D_L1	R/W	D2873	42873	0B38		
D2824	42824	0B07	AL6.L_L1	R/W	D2874	42874	0B39		
D2825	42825	0B08	AL7.T_L1	R/W	D2875	42875	0B3A		
D2826	42826	0B09	AL7.W_L1	R/W	D2876	42876	0B3B		
D2827	42827	0B0A	AL7.D_L1	R/W	D2877	42877	0B3C		
D2828	42828	0B0B	AL7.L_L1	R/W	D2878	42878	0B3D		
D2829	42829	0B0C	AL8.T_L1	R/W	D2879	42879	0B3E		
D2830	42830	0B0D	AL8.W_L1	R/W	D2880	42880	0B3F		
D2831	42831	0B0E	AL8.D_L1	R/W	D2881	42881	0B40		
D2832	42832	0B0F	AL8.L_L1	R/W	D2882	42882	0B41		
D2833	42833	0B10	VT1_L1	R/W	D2883	42883	0B42		
D2834	42834	0B11	VT2_L1	R/W	D2884	42884	0B43		
D2835	42835	0B12	VT3_L1	R/W	D2885	42885	0B44		
D2836	42836	0B13	VT4_L1	R/W	D2886	42886	0B45		
D2837	42837	0B14	VT5_L1	R/W	D2887	42887	0B46		
D2838	42838	0B15	VT6_L1	R/W	D2888	42888	0B47		
D2839	42839	0B16	VT7_L1	R/W	D2889	42889	0B48		
D2840	42840	0B17	VT8_L1	R/W	D2890	42890	0B49		
D2841	42841	0B18	HY1_L1	R/W	D2891	42891	0B4A		
D2842	42842	0B19	HY2_L1	R/W	D2892	42892	0B4B		
D2843	42843	0B1A	HY3_L1	R/W	D2893	42893	0B4C		
D2844	42844	0B1B	HY4_L1	R/W	D2894	42894	0B4D		
D2845	42845	0B1C	HY5_L1	R/W	D2895	42895	0B4E		
D2846	42846	0B1D	HY6_L1	R/W	D2896	42896	0B4F		
D2847	42847	0B1E	HY7_L1	R/W	D2897	42897	0B50		
D2848	42848	0B1F	HY8_L1	R/W	D2898	42898	0B51		
D2849	42849	0B20	DYN1_L1	R/W	D2899	42899	0B52		
D2850	42850	0B21	DYN2_L1	R/W	D2900	42900	0B53		

10.4 UM33A D Registers

Operation parameter									
PV-related setting (Menu: PVS)									
D-Reg No.	Ref. No.	H No.	Register symbol	R/W	D-Reg No.	Ref. No.	H No.	Register symbol	R/W
				UM33A					UM33A
D2901	42901	0B54	BS_L1	R/W	D2951	42951	0B86		
D2902	42902	0B55	FL_L1	R/W	D2952	42952	0B87		
D2903	42903	0B56			D2953	42953	0B88		
D2904	42904	0B57			D2954	42954	0B89		
D2905	42905	0B58			D2955	42955	0B8A		
D2906	42906	0B59			D2956	42956	0B8B		
D2907	42907	0B5A			D2957	42957	0B8C		
D2908	42908	0B5B			D2958	42958	0B8D		
D2909	42909	0B5C			D2959	42959	0B8E		
D2910	42910	0B5D			D2960	42960	0B8F		
D2911	42911	0B5E			D2961	42961	0B90		
D2912	42912	0B5F			D2962	42962	0B91		
D2913	42913	0B60			D2963	42963	0B92		
D2914	42914	0B61			D2964	42964	0B93		
D2915	42915	0B62			D2965	42965	0B94		
D2916	42916	0B63			D2966	42966	0B95		
D2917	42917	0B64			D2967	42967	0B96		
D2918	42918	0B65			D2968	42968	0B97		
D2919	42919	0B66			D2969	42969	0B98		
D2920	42920	0B67			D2970	42970	0B99		
D2921	42921	0B68			D2971	42971	0B9A		
D2922	42922	0B69			D2972	42972	0B9B		
D2923	42923	0B6A			D2973	42973	0B9C		
D2924	42924	0B6B			D2974	42974	0B9D		
D2925	42925	0B6C			D2975	42975	0B9E		
D2926	42926	0B6D			D2976	42976	0B9F		
D2927	42927	0B6E			D2977	42977	0BA0		
D2928	42928	0B6F			D2978	42978	0BA1		
D2929	42929	0B70			D2979	42979	0BA2		
D2930	42930	0B71			D2980	42980	0BA3		
D2931	42931	0B72			D2981	42981	0BA4		
D2932	42932	0B73			D2982	42982	0BA5		
D2933	42933	0B74			D2983	42983	0BA6		
D2934	42934	0B75			D2984	42984	0BA7		
D2935	42935	0B76			D2985	42985	0BA8		
D2936	42936	0B77			D2986	42986	0BA9		
D2937	42937	0B78			D2987	42987	0BAA		
D2938	42938	0B79			D2988	42988	0BAB		
D2939	42939	0B7A			D2989	42989	0BAC		
D2940	42940	0B7B			D2990	42990	0BAD		
D2941	42941	0B7C			D2991	42991	0BAE		
D2942	42942	0B7D			D2992	42992	0BAF		
D2943	42943	0B7E			D2993	42993	0BB0		
D2944	42944	0B7F			D2994	42994	0BB1		
D2945	42945	0B80			D2995	42995	0BB2		
D2946	42946	0B81			D2996	42996	0BB3		
D2947	42947	0B82			D2997	42997	0BB4		
D2948	42948	0B83			D2998	42998	0BB5		
D2949	42949	0B84			D2999	42999	0BB6		
D2950	42950	0B85			D3000	43000	0BB7		

Alarm Setpoint Setting (D2301 to D2400)

Register No.	Description	Range and meaning of value
D2301 to D2350		
D2351	A1_L1	Alarm-1 setpoint
D2352	A2_L1	Alarm-2 setpoint
D2353	A3_L1	Alarm-3 setpoint
D2354	A4_L1	Alarm-4 setpoint
D2355	A5_L1	Alarm-5 setpoint
D2356	A6_L1	Alarm-6 setpoint
D2357	A7_L1	Alarm-7 setpoint
D2358	A8_L1	Alarm-8 setpoint
D2359	PEAK	PV peak value
D2360	BOTM	PV bottom value
D2361 to D2400		

Set a display value of setpoint of PV alarm or velocity alarm.
-19999 to 30000 (Set a value within the input range.)
Decimal point position depends on the input type.

Read only
-5.0 to 105.0% of PV input range span (EUS)

Free Area (D2401 to D2800)

Register No.	Description	Range and meaning of value
D2401 to D2800	Free area	

10.4 UM33A D Registers

Alarm Function Setting (D2801 to D2900)

Register No.	Description	Range and meaning of value
D2801	AL1.T_L1	AL1.T_L1 to AL8.T_L1 0: Disable 1: PV high limit 2: PV low limit 29: PV velocity 30: Fault diagnosis 31: FAIL AL1.W_L1 to AL8.W_L1 0: Without Stand-by action 1: With Stand-by action AL1.D_L1 to AL8.D_L1 0: Alarm output: Energized 1: Alarm output: De-energized AL1.L_L1 to AL8.L_L1 0: OFF 1: Latch 1 2: Latch 2 3: Latch 3 4: Latch 4 When the UTAdvanced parameter is set by key stroke, the alarm type, stand-by action, energized/de-energized, and latch comprise one parameter.
D2802	AL1.W_L1	
D2803	AL1.D_L1	
D2804	AL1.L_L1	
D2805	AL2.T_L1	
D2806	AL2.W_L1	
D2807	AL2.D_L1	
D2808	AL2.L_L1	
D2809	AL3.T_L1	
D2810	AL3.W_L1	
D2811	AL3.D_L1	
D2812	AL3.L_L1	
D2813	AL4.T_L1	
D2814	AL4.W_L1	
D2815	AL4.D_L1	
D2816	AL4.L_L1	
D2817	AL5.T_L1	
D2818	AL5.W_L1	
D2819	AL5.D_L1	
D2820	AL5.L_L1	
D2821	AL6.T_L1	
D2822	AL6.W_L1	
D2823	AL6.D_L1	
D2824	AL6.L_L1	
D2825	AL7.T_L1	
D2826	AL7.W_L1	
D2827	AL7.D_L1	
D2828	AL7.L_L1	
D2829	AL8.T_L1	
D2830	AL8.W_L1	
D2831	AL8.D_L1	
D2832	AL8.L_L1	
D2833	VT1_L1	1 to 5999 (second)
D2834	VT2_L1	
D2835	VT3_L1	
D2836	VT4_L1	
D2837	VT5_L1	
D2838	VT6_L1	
D2839	VT7_L1	
D2840	VT8_L1	

Register No.	Description		Range and meaning of value
D2841	HY1_L1	Alarm-1 hysteresis	Set a display value of setpoint of hysteresis. -19999 to 30000 (Set a value within the input range.) Decimal point position depends on the input type.
D2842	HY2_L1	Alarm-2 hysteresis	
D2843	HY3_L1	Alarm-3 hysteresis	
D2844	HY4_L1	Alarm-4 hysteresis	
D2845	HY5_L1	Alarm-5 hysteresis	
D2846	HY6_L1	Alarm-6 hysteresis	
D2847	HY7_L1	Alarm-7 hysteresis	
D2848	HY8_L1	Alarm-8 hysteresis	
D2849	DYN1_L1	Alarm-1 On-delay timer	An alarm output is ON when the delay timer expires after the alarm setpoint is reached. 0 to 5999 (second)
D2850	DYN2_L1	Alarm-2 On-delay timer	
D2851	DYN3_L1	Alarm-3 On-delay timer	
D2852	DYN4_L1	Alarm-4 On-delay timer	
D2853	DYN5_L1	Alarm-5 On-delay timer	
D2854	DYN6_L1	Alarm-6 On-delay timer	
D2855	DYN7_L1	Alarm-7 On-delay timer	
D2856	DYN8_L1	Alarm-8 On-delay timer	
D2857	DYF1_L1	Alarm-1 Off-delay timer	An alarm output is OFF when the delay timer expires after the alarm setpoint is reached. 0 to 5999 (second)
D2858	DYF2_L1	Alarm-2 Off-delay timer	
D2859	DYF3_L1	Alarm-3 Off-delay timer	
D2860	DYF4_L1	Alarm-4 Off-delay timer	
D2861	DYF5_L1	Alarm-5 Off-delay timer	
D2862	DYF6_L1	Alarm-6 Off-delay timer	
D2863	DYF7_L1	Alarm-7 Off-delay timer	
D2864	DYF8_L1	Alarm-8 Off-delay timer	
D2865			
D2866	AMD_L1	Alarm mode	0: Always active 1: Not active in STOP mode 2: Not active in STOP or MAN mode
D2867 to D2900			

PV-related Setting (D2901 to D3000)

Register No.	Description		Range and meaning of value
D2901	BS_L1	PV input bias	-100.0 to 100.0% of PV input range span (EUS)
D2902	FL_L1	PV input filter	0: OFF (Disable) 1 to 120 s
D2903 to D2900			

Free Area (D3001 to D4800)

Register No.	Description		Range and meaning of value
D3001 to D4800			Free area

10.4 UM33A D Registers

10.4.3 10-segment Linearizer Setting Parameter (D4801 to D4900)

10-segment linearizer setting parameter									
10-segment inearizer setting (Menu: PYS1, PYS2)									
D-Reg No.	Ref. No.	H No.	Register symbol	R/W UM33A	D-Reg No.	Ref. No.	H No.	Register symbol	R/W UM33A
D4801	44801	12C0			D4851	44851	12F2	B10_2	R/W
D4802	44802	12C1	A1_1	R/W	D4852	44852	12F3	A11_2	R/W
D4803	44803	12C2	B1_1	R/W	D4853	44853	12F4	B11_2	R/W
D4804	44804	12C3	A2_1	R/W	D4854	44854	12F5	PMD_2	R/W
D4805	44805	12C4	B2_1	R/W	D4855	44855	12F6		
D4806	44806	12C5	A3_1	R/W	D4856	44856	12F7		
D4807	44807	12C6	B3_1	R/W	D4857	44857	12F8		
D4808	44808	12C7	A4_1	R/W	D4858	44858	12F9		
D4809	44809	12C8	B4_1	R/W	D4859	44859	12FA		
D4810	44810	12C9	A5_1	R/W	D4860	44860	12FB		
D4811	44811	12CA	B5_1	R/W	D4861	44861	12FC		
D4812	44812	12CB	A6_1	R/W	D4862	44862	12FD		
D4813	44813	12CC	B6_1	R/W	D4863	44863	12FE		
D4814	44814	12CD	A7_1	R/W	D4864	44864	12FF		
D4815	44815	12CE	B7_1	R/W	D4865	44865	1300		
D4816	44816	12CF	A8_1	R/W	D4866	44866	1301		
D4817	44817	12D0	B8_1	R/W	D4867	44867	1302		
D4818	44818	12D1	A9_1	R/W	D4868	44868	1303		
D4819	44819	12D2	B9_1	R/W	D4869	44869	1304		
D4820	44820	12D3	A10_1	R/W	D4870	44870	1305		
D4821	44821	12D4	B10_1	R/W	D4871	44871	1306		
D4822	44822	12D5	A11_1	R/W	D4872	44872	1307		
D4823	44823	12D6	B11_1	R/W	D4873	44873	1308		
D4824	44824	12D7	PMD_1	R/W	D4874	44874	1309		
D4825	44825	12D8			D4875	44875	130A		
D4826	44826	12D9			D4876	44876	130B		
D4827	44827	12DA			D4877	44877	130C		
D4828	44828	12DB			D4878	44878	130D		
D4829	44829	12DC			D4879	44879	130E		
D4830	44830	12DD			D4880	44880	130F		
D4831	44831	12DE			D4881	44881	1310		
D4832	44832	12DF	A1_2	R/W	D4882	44882	1311		
D4833	44833	12E0	B1_2	R/W	D4883	44883	1312		
D4834	44834	12E1	A2_2	R/W	D4884	44884	1313		
D4835	44835	12E2	B2_2	R/W	D4885	44885	1314		
D4836	44836	12E3	A3_2	R/W	D4886	44886	1315		
D4837	44837	12E4	B3_2	R/W	D4887	44887	1316		
D4838	44838	12E5	A4_2	R/W	D4888	44888	1317		
D4839	44839	12E6	B4_2	R/W	D4889	44889	1318		
D4840	44840	12E7	A5_2	R/W	D4890	44890	1319		
D4841	44841	12E8	B5_2	R/W	D4891	44891	131A		
D4842	44842	12E9	A6_2	R/W	D4892	44892	131B		
D4843	44843	12EA	B6_2	R/W	D4893	44893	131C		
D4844	44844	12EB	A7_2	R/W	D4894	44894	131D		
D4845	44845	12EC	B7_2	R/W	D4895	44895	131E		
D4846	44846	12ED	A8_2	R/W	D4896	44896	131F		
D4847	44847	12EE	B8_2	R/W	D4897	44897	1320		
D4848	44848	12EF	A9_2	R/W	D4898	44898	1321		
D4849	44849	12F0	B9_2	R/W	D4899	44899	1322		
D4850	44850	12F1	A10_2	R/W	D4900	44900	1323		

D4901 to D5000: Free area

10-segment Linearizer Setting (D4801 to D4900)

Register No.	Description	Range and meaning of value
D4801		
D4802	A1_1	10-segment linearizer input 1 of group 1
D4803	B1_1	10-segment linearizer output 1 of group 1
D4804	A2_1	10-segment linearizer input 2 of group 1
D4805	B2_1	10-segment linearizer output 2 of group 1
D4806	A3_1	10-segment linearizer input 3 of group 1
D4807	B3_1	10-segment linearizer output 3 of group 1
D4808	A4_1	10-segment linearizer input 4 of group 1
D4809	B4_1	10-segment linearizer output 4 of group 1
D4810	A5_1	10-segment linearizer input 5 of group 1
D4811	B5_1	10-segment linearizer output 5 of group 1
D4812	A6_1	10-segment linearizer input 6 of group 1
D4813	B6_1	10-segment linearizer output 6 of group 1
D4814	A7_1	10-segment linearizer input 7 of group 1
D4815	B7_1	10-segment linearizer output 7 of group 1
D4816	A8_1	10-segment linearizer input 8 of group 1
D4817	B8_1	10-segment linearizer output 8 of group 1
D4818	A9_1	10-segment linearizer input 9 of group 1
D4819	B9_1	10-segment linearizer output 9 of group 1
D4820	A10_1	10-segment linearizer input 10 of group 1
D4821	B10_1	10-segment linearizer output 10 of group 1
D4822	A11_1	10-segment linearizer input 11 of group 1
D4823	B11_1	10-segment linearizer output 11 of group 1
D4824	PMD_1	10-segment linearizer mode of group 1
D4825 to D4831		0: 10-segment linearizer bias 1: 10-segment linearizer approximation
D4832 to D4853	A1_2 to B11_2	For RTE analog output A1_2 to A11_2 Output linearizer: -5.0 to 105.0% B1_2 to B11_2 Output linearizer: -5.0 to 105.0%
D4854	PMD_2	10-segment linearizer mode of group 2
D4855 to D4900		Same as D4824

Free Area (D4901 to D5000)

Register No.	Description	Range and meaning of value
D4901 to 5000	Free area	

10.4 UM33A D Registers

10.4.4 Setup Parameters (D5001 to D6500)

Setup parameter									
Control function setting (Menu: CTL)									
D-Reg No.	Ref. No.	H No.	Register symbol	R/W UM33A	D-Reg No.	Ref. No.	H No.	Register symbol	R/W UM33A
D5001	45001	1388			D5051	45051	13BA		
D5002	45002	1389			D5052	45052	13BB		
D5003	45003	138A			D5053	45053	13BC		
D5004	45004	138B			D5054	45054	13BD		
D5005	45005	138C			D5055	45055	13BE		
D5006	45006	138D			D5056	45056	13BF		
D5007	45007	138E			D5057	45057	13C0		
D5008	45008	138F			D5058	45058	13C1		
D5009	45009	1390	ALNO_L1	R/W	D5059	45059	13C2		
D5010	45010	1391			D5060	45060	13C3		
D5011	45011	1392			D5061	45061	13C4		
D5012	45012	1393			D5062	45062	13C5		
D5013	45013	1394			D5063	45063	13C6		
D5014	45014	1395			D5064	45064	13C7		
D5015	45015	1396			D5065	45065	13C8		
D5016	45016	1397			D5066	45066	13C9		
D5017	45017	1398			D5067	45067	13CA		
D5018	45018	1399			D5068	45068	13CB		
D5019	45019	139A	SMP	R/W	D5069	45069	13CC		
D5020	45020	139B			D5070	45070	13CD		
D5021	45021	139C			D5071	45071	13CE		
D5022	45022	139D			D5072	45072	13CF		
D5023	45023	139E			D5073	45073	13D0		
D5024	45024	139F			D5074	45074	13D1		
D5025	45025	13A0			D5075	45075	13D2		
D5026	45026	13A1			D5076	45076	13D3		
D5027	45027	13A2			D5077	45077	13D4		
D5028	45028	13A3			D5078	45078	13D5		
D5029	45029	13A4			D5079	45079	13D6		
D5030	45030	13A5			D5080	45080	13D7		
D5031	45031	13A6			D5081	45081	13D8		
D5032	45032	13A7			D5082	45082	13D9		
D5033	45033	13A8			D5083	45083	13DA		
D5034	45034	13A9			D5084	45084	13DB		
D5035	45035	13AA			D5085	45085	13DC		
D5036	45036	13AB			D5086	45086	13DD		
D5037	45037	13AC			D5087	45087	13DE		
D5038	45038	13AD			D5088	45088	13DF		
D5039	45039	13AE			D5089	45089	13E0		
D5040	45040	13AF			D5090	45090	13E1		
D5041	45041	13B0			D5091	45091	13E2		
D5042	45042	13B1			D5092	45092	13E3		
D5043	45043	13B2			D5093	45093	13E4		
D5044	45044	13B3			D5094	45094	13E5		
D5045	45045	13B4			D5095	45095	13E6		
D5046	45046	13B5			D5096	45096	13E7		
D5047	45047	13B6			D5097	45097	13E8		
D5048	45048	13B7			D5098	45098	13E9		
D5049	45049	13B8			D5099	45099	13EA		
D5050	45050	13B9			D5100	45100	13EB		

Setup parameter									
Input setting (PV input setting menu: PV)									
D-Reg No.	Ref. No.	H No.	Register symbol	R/W	D-Reg No.	Ref. No.	H No.	Register symbol	R/W
				UM33A					UM33A
D5101	45101	13EC	IN	R/W	D5151	45151	141E		
D5102	45102	13ED	UNIT	R/W	D5152	45152	141F		
D5103	45103	13EE	DP	R	D5153	45153	1420		
D5104	45104	13EF	RH	R/W	D5154	45154	1421		
D5105	45105	13F0	RL	R/W	D5155	45155	1422		
D5106	45106	13F1	SDP	R/W	D5156	45156	1423		
D5107	45107	13F2	SH	R/W	D5157	45157	1424		
D5108	45108	13F3	SL	R/W	D5158	45158	1425		
D5109	45109	13F4	BSL	R/W	D5159	45159	1426		
D5110	45110	13F5	RJC	R/W	D5160	45160	1427		
D5111	45111	13F6	ERJC	R/W	D5161	45161	1428		
D5112	45112	13F7	A.BS	R/W	D5162	45162	1429		
D5113	45113	13F8	A.FL	R/W	D5163	45163	142A		
D5114	45114	13F9	A.SR	R/W	D5164	45164	142B		
D5115	45115	13FA	A.LC	R/W	D5165	45165	142C		
D5116	45116	13FB			D5166	45166	142D		
D5117	45117	13FC			D5167	45167	142E		
D5118	45118	13FD			D5168	45168	142F		
D5119	45119	13FE			D5169	45169	1430		
D5120	45120	13FF			D5170	45170	1431		
D5121	45121	1400			D5171	45171	1432		
D5122	45122	1401			D5172	45172	1433		
D5123	45123	1402			D5173	45173	1434		
D5124	45124	1403			D5174	45174	1435		
D5125	45125	1404			D5175	45175	1436		
D5126	45126	1405			D5176	45176	1437		
D5127	45127	1406			D5177	45177	1438		
D5128	45128	1407			D5178	45178	1439		
D5129	45129	1408			D5179	45179	143A		
D5130	45130	1409			D5180	45180	143B		
D5131	45131	140A			D5181	45181	143C		
D5132	45132	140B			D5182	45182	143D		
D5133	45133	140C			D5183	45183	143E		
D5134	45134	140D			D5184	45184	143F		
D5135	45135	140E			D5185	45185	1440		
D5136	45136	140F			D5186	45186	1441		
D5137	45137	1410			D5187	45187	1442		
D5138	45138	1411			D5188	45188	1443		
D5139	45139	1412			D5189	45189	1444		
D5140	45140	1413			D5190	45190	1445		
D5141	45141	1414			D5191	45191	1446		
D5142	45142	1415			D5192	45192	1447		
D5143	45143	1416			D5193	45193	1448		
D5144	45144	1417			D5194	45194	1449		
D5145	45145	1418			D5195	45195	144A		
D5146	45146	1419			D5196	45196	144B		
D5147	45147	141A			D5197	45197	144C		
D5148	45148	141B			D5198	45198	144D		
D5149	45149	141C			D5199	45199	144E		
D5150	45150	141D			D5200	45200	144F		

10.4 UM33A D Registers

Setup parameter									
Input setting (Input range-SP limiter setting parameters menu: MPV)									
D-Reg No.	Ref. No.	H No.	Register symbol	R/W	D-Reg No.	Ref. No.	H No.	Register symbol	R/W
				UM33A					UM33A
D5201	45201	1450	P.UNI_L1	R/W	D5251	45251	1482		
D5202	45202	1451	P.DP_L1	R/W	D5252	45252	1483		
D5203	45203	1452	P.RH_L1	R/W	D5253	45253	1484		
D5204	45204	1453	P.RL_L1	R/W	D5254	45254	1485		
D5205	45205	1454			D5255	45255	1486		
D5206	45206	1455			D5256	45256	1487		
D5207	45207	1456			D5257	45257	1488		
D5208	45208	1457			D5258	45258	1489		
D5209	45209	1458			D5259	45259	148A		
D5210	45210	1459			D5260	45260	148B		
D5211	45211	145A			D5261	45261	148C		
D5212	45212	145B			D5262	45262	148D		
D5213	45213	145C			D5263	45263	148E		
D5214	45214	145D			D5264	45264	148F		
D5215	45215	145E			D5265	45265	1490		
D5216	45216	145F			D5266	45266	1491		
D5217	45217	1460			D5267	45267	1492		
D5218	45218	1461			D5268	45268	1493		
D5219	45219	1462			D5269	45269	1494		
D5220	45220	1463			D5270	45270	1495		
D5221	45221	1464			D5271	45271	1496		
D5222	45222	1465			D5272	45272	1497		
D5223	45223	1466			D5273	45273	1498		
D5224	45224	1467			D5274	45274	1499		
D5225	45225	1468			D5275	45275	149A		
D5226	45226	1469			D5276	45276	149B		
D5227	45227	146A			D5277	45277	149C		
D5228	45228	146B			D5278	45278	149D		
D5229	45229	146C			D5279	45279	149E		
D5230	45230	146D			D5280	45280	149F		
D5231	45231	146E			D5281	45281	14A0		
D5232	45232	146F			D5282	45282	14A1		
D5233	45233	1470			D5283	45283	14A2		
D5234	45234	1471			D5284	45284	14A3		
D5235	45235	1472			D5285	45285	14A4		
D5236	45236	1473			D5286	45286	14A5		
D5237	45237	1474			D5287	45287	14A6		
D5238	45238	1475			D5288	45288	14A7		
D5239	45239	1476			D5289	45289	14A8		
D5240	45240	1477			D5290	45290	14A9		
D5241	45241	1478			D5291	45291	14AA		
D5242	45242	1479			D5292	45292	14AB		
D5243	45243	147A			D5293	45293	14AC		
D5244	45244	147B			D5294	45294	14AD		
D5245	45245	147C			D5295	45295	14AE		
D5246	45246	147D			D5296	45296	14AF		
D5247	45247	147E			D5297	45297	14B0		
D5248	45248	147F			D5298	45298	14B1		
D5249	45249	1480			D5299	45299	14B2		
D5250	45250	1481			D5300	45300	14B3		

Setup parameter									
Output setting (Menu: OUT)									
D-Reg No.	Ref. No.	H No.	Register symbol	R/W	D-Reg No.	Ref. No.	H No.	Register symbol	R/W
				UM33A					UM33A
D5301	45301	14B4			D5351	45351	14E6		
D5302	45302	14B5			D5352	45352	14E7		
D5303	45303	14B6			D5353	45353	14E8		
D5304	45304	14B7			D5354	45354	14E9		
D5305	45305	14B8			D5355	45355	14EA		
D5306	45306	14B9			D5356	45356	14EB		
D5307	45307	14BA			D5357	45357	14EC		
D5308	45308	14BB			D5358	45358	14ED		
D5309	45309	14BC			D5359	45359	14EE		
D5310	45310	14BD			D5360	45360	14EF		
D5311	45311	14BE			D5361	45361	14F0		
D5312	45312	14BF			D5362	45362	14F1		
D5313	45313	14C0			D5363	45363	14F2		
D5314	45314	14C1			D5364	45364	14F3		
D5315	45315	14C2			D5365	45365	14F4		
D5316	45316	14C3			D5366	45366	14F5		
D5317	45317	14C4			D5367	45367	14F6		
D5318	45318	14C5			D5368	45368	14F7		
D5319	45319	14C6			D5369	45369	14F8		
D5320	45320	14C7			D5370	45370	14F9		
D5321	45321	14C8	RTS	R/W	D5371	45371	14FA		
D5322	45322	14C9	RTH	R/W	D5372	45372	14FB		
D5323	45323	14CA	RTL	R/W	D5373	45373	14FC		
D5324	45324	14CB			D5374	45374	14FD		
D5325	45325	14CC			D5375	45375	14FE		
D5326	45326	14CD			D5376	45376	14FF		
D5327	45327	14CE			D5377	45377	1500		
D5328	45328	14CF			D5378	45378	1501		
D5329	45329	14D0			D5379	45379	1502		
D5330	45330	14D1			D5380	45380	1503		
D5331	45331	14D2			D5381	45381	1504		
D5332	45332	14D3			D5382	45382	1505		
D5333	45333	14D4			D5383	45383	1506		
D5334	45334	14D5			D5384	45384	1507		
D5335	45335	14D6	RET.H	R/W	D5385	45385	1508		
D5336	45336	14D7	RET.L	R/W	D5386	45386	1509		
D5337	45337	14D8			D5387	45387	150A		
D5338	45338	14D9			D5388	45388	150B		
D5339	45339	14DA			D5389	45389	150C		
D5340	45340	14DB			D5390	45390	150D		
D5341	45341	14DC			D5391	45391	150E		
D5342	45342	14DD			D5392	45392	150F		
D5343	45343	14DE	RET.A	R/W	D5393	45393	1510		
D5344	45344	14DF			D5394	45394	1511		
D5345	45345	14E0			D5395	45395	1512		
D5346	45346	14E1			D5396	45396	1513		
D5347	45347	14E2			D5397	45397	1514		
D5348	45348	14E3			D5398	45398	1515		
D5349	45349	14E4			D5399	45399	1516		
D5350	45350	14E5			D5400	45400	1517		

D5401 to D5500: Free area

10.4 UM33A D Registers

Setup parameter									
Communication setting (RS-485 communication setting menu: R485)									
D-Reg No.	Ref. No.	H No.	Register symbol	R/W	D-Reg No.	Ref. No.	H No.	Register symbol	R/W
				UM33A					UM33A
D5501	45501	157C	PSL_E1		D5551	45551	15AE		
D5502	45502	157D	BPS_E1		D5552	45552	15AF		
D5503	45503	157E	PRI_E1		D5553	45553	15B0		
D5504	45504	157F	STP_E1		D5554	45554	15B1		
D5505	45505	1580	DLN_E1		D5555	45555	15B2		
D5506	45506	1581	ADR_E1		D5556	45556	15B3		
D5507	45507	1582	RP.T_E1		D5557	45557	15B4		
D5508	45508	1583			D5558	45558	15B5		
D5509	45509	1584			D5559	45559	15B6		
D5510	45510	1585			D5560	45560	15B7		
D5511	45511	1586			D5561	45561	15B8		
D5512	45512	1587			D5562	45562	15B9		
D5513	45513	1588			D5563	45563	15BA		
D5514	45514	1589			D5564	45564	15BB		
D5515	45515	158A			D5565	45565	15BC		
D5516	45516	158B			D5566	45566	15BD		
D5517	45517	158C			D5567	45567	15BE		
D5518	45518	158D			D5568	45568	15BF		
D5519	45519	158E			D5569	45569	15C0		
D5520	45520	158F			D5570	45570	15C1		
D5521	45521	1590			D5571	45571	15C2		
D5522	45522	1591			D5572	45572	15C3		
D5523	45523	1592			D5573	45573	15C4		
D5524	45524	1593			D5574	45574	15C5		
D5525	45525	1594			D5575	45575	15C6		
D5526	45526	1595			D5576	45576	15C7		
D5527	45527	1596			D5577	45577	15C8		
D5528	45528	1597			D5578	45578	15C9		
D5529	45529	1598			D5579	45579	15CA		
D5530	45530	1599			D5580	45580	15CB		
D5531	45531	159A			D5581	45581	15CC		
D5532	45532	159B			D5582	45582	15CD		
D5533	45533	159C			D5583	45583	15CE		
D5534	45534	159D			D5584	45584	15CF		
D5535	45535	159E			D5585	45585	15D0		
D5536	45536	159F			D5586	45586	15D1		
D5537	45537	15A0			D5587	45587	15D2		
D5538	45538	15A1			D5588	45588	15D3		
D5539	45539	15A2			D5589	45589	15D4		
D5540	45540	15A3			D5590	45590	15D5		
D5541	45541	15A4			D5591	45591	15D6		
D5542	45542	15A5			D5592	45592	15D7		
D5543	45543	15A6			D5593	45593	15D8		
D5544	45544	15A7			D5594	45594	15D9		
D5545	45545	15A8			D5595	45595	15DA		
D5546	45546	15A9			D5596	45596	15DB		
D5547	45547	15AA			D5597	45597	15DC		
D5548	45548	15AB			D5598	45598	15DD		
D5549	45549	15AC			D5599	45599	15DE		
D5550	45550	15AD			D5600	45600	15DF		

D5601 to D5700: Free area

Setup parameter									
Key operation setting (Menu: KEY), Display function setting (Menu: DISP), SELECT Display setting (Menu: CSEL)									
D-Reg No.	Ref. No.	H No.	Register symbol	R/W	D-Reg No.	Ref. No.	H No.	Register symbol	R/W
				UM33A					UM33A
D5701	45701	1644			D5751	45751	1676	B.STS	R/W
D5702	45702	1645			D5752	45752	1677		
D5703	45703	1646	Fn-K *1	R/W	D5753	45753	1678	D.CYC	R/W
D5704	45704	1647			D5754	45754	1679	OP.JP	R/W
D5705	45705	1648			D5755	45755	167A	MLSD	R/W
D5706	45706	1649			D5756	45756	167B		
D5707	45707	164A			D5757	45757	167C		
D5708	45708	164B			D5758	45758	167D		
D5709	45709	164C			D5759	45759	167E		
D5710	45710	164D			D5760	45760	167F		
D5711	45711	164E			D5761	45761	1680	CS1	R/W
D5712	45712	164F			D5762	45762	1681	CS2	R/W
D5713	45713	1650	PCMD_L1	R/W	D5763	45763	1682	CS3	R/W
D5714	45714	1651	PCH_L1	R/W	D5764	45764	1683	CS4	R/W
D5715	45715	1652	PCL_L1	R/W	D5765	45765	1684	CS5	R/W
D5716	45716	1653			D5766	45766	1685		
D5717	45717	1654			D5767	45767	1686		
D5718	45718	1655			D5768	45768	1687		
D5719	45719	1656			D5769	45769	1688		
D5720	45720	1657			D5770	45770	1689		
D5721	45721	1658			D5771	45771	168A		
D5722	45722	1659			D5772	45772	168B		
D5723	45723	165A	EV1_L1	R/W	D5773	45773	168C		
D5724	45724	165B	EV2_L1	R/W	D5774	45774	168D		
D5725	45725	165C	EV3_L1	R/W	D5775	45775	168E		
D5726	45726	165D	EV4_L1	R/W	D5776	45776	168F		
D5727	45727	165E	EV5_L1	R/W	D5777	45777	1690		
D5728	45728	165F	EV6_L1	R/W	D5778	45778	1691		
D5729	45729	1660	EV7_L1	R/W	D5779	45779	1692		
D5730	45730	1661	EV8_L1	R/W	D5780	45780	1693		
D5731	45731	1662			D5781	45781	1694		
D5732	45732	1663			D5782	45782	1695		
D5733	45733	1664			D5783	45783	1696		
D5734	45734	1665			D5784	45784	1697		
D5735	45735	1666			D5785	45785	1698		
D5736	45736	1667			D5786	45786	1699		
D5737	45737	1668			D5787	45787	169A		
D5738	45738	1669			D5788	45788	169B		
D5739	45739	166A	PV.D	R/W	D5789	45789	169C		
D5740	45740	166B	SP.D	R/W	D5790	45790	169D		
D5741	45741	166C	STS.D	R/W	D5791	45791	169E		
D5742	45742	166D	SPD	R/W	D5792	45792	169F		
D5743	45743	166E	GUID	R/W	D5793	45793	16A0		
D5744	45744	166F	HOME	R/W	D5794	45794	16A1		
D5745	45745	1670	ECO	R/W	D5795	45795	16A2		
D5746	45746	1671	BRI	R/W	D5796	45796	16A3		
D5747	45747	1672	B.PVW	R/W	D5797	45797	16A4		
D5748	45748	1673	B.PVR	R/W	D5798	45798	16A5		
D5749	45749	1674	B.SP	R/W	D5799	45799	16A6		
D5750	45750	1675			D5800	45800	16A7		

*1: Same parameter exists in other menu. "-K" is added to the end of the parameter in KEY menu.

10.4 UM33A D Registers

Setup parameter									
Lock setting (Key lock setting menu: KLOC) (Menu lock setting menu: MLOC)									
D-Reg No.	Ref. No.	H No.	Register symbol	R/W	D-Reg No.	Ref. No.	H No.	Register symbol	R/W
				UM33A					UM33A
D5801	45801	16A8			D5851	45851	16DA	DI.SL-L *1	R/W
D5802	45802	16A9			D5852	45852	16DB		
D5803	45803	16AA			D5853	45853	16DC	DI.D-L *1	R/W
D5804	45804	16AB			D5854	45854	16DD		
D5805	45805	16AC			D5855	45855	16DE		
D5806	45806	16AD			D5856	45856	16DF		
D5807	45807	16AE			D5857	45857	16E0		
D5808	45808	16AF			D5858	45858	16E1	ALM-L *1	R/W
D5809	45809	16B0			D5859	45859	16E2	DO_E1-L *1	R/W
D5810	45810	16B1			D5860	45860	16E3		
D5811	45811	16B2			D5861	45861	16E4		
D5812	45812	16B3			D5862	45862	16E5	DO_E4-L *1	R/W
D5813	45813	16B4			D5863	45863	16E6	I/O-L *1	R/W
D5814	45814	16B5			D5864	45864	16E7	SYS-L *1	R/W
D5815	45815	16B6			D5865	45865	16E8	INIT-L *1	R/W
D5816	45816	16B7			D5866	45866	16E9	VER-L *1	R/W
D5817	45817	16B8			D5867	45867	16EA	LVL-L *1	R/W
D5818	45818	16B9	COM.W	R/W	D5868	45868	16EB		
D5819	45819	16BA	DATA-L *1	R/W	D5869	45869	16EC		
D5820	45820	16BB			D5870	45870	16ED		
D5821	45821	16BC	U.PV	R/W	D5871	45871	16EE		
D5822	45822	16BD			D5872	45872	16EF	ALRM_L1-L *1	R/W
D5823	45823	16BE			D5873	45873	16F0		
D5824	45824	16BF			D5874	45874	16F1	PVS_L1-L *1	R/W
D5825	45825	16C0			D5875	45875	16F2		
D5826	45826	16C1			D5876	45876	16F3		
D5827	45827	16C2			D5877	45877	16F4		
D5828	45828	16C3			D5878	45878	16F5		
D5829	45829	16C4			D5879	45879	16F6		
D5830	45830	16C5			D5880	45880	16F7		
D5831	45831	16C6	CTL-L *1	R/W	D5881	45881	16F8		
D5832	45832	16C7	PV-L *1	R/W	D5882	45882	16F9		
D5833	45833	16C8			D5883	45883	16FA		
D5834	45834	16C9			D5884	45884	16FB		
D5835	45835	16CA			D5885	45885	16FC		
D5836	45836	16CB	MPV_L1-L *1	R/W	D5886	45886	16FD	PYS1-L *1	R/W
D5837	45837	16CC			D5887	45887	16FE	PYS2-L *1	R/W
D5838	45838	16CD	OUT-L *1	R/W	D5888	45888	16FF		
D5839	45839	16CE			D5889	45889	1700		
D5840	45840	16CF	R485_E1-L *1	R/W	D5890	45890	1701	AL-L *1	R/W
D5841	45841	16D0			D5891	45891	1702		
D5842	45842	16D1			D5892	45892	1703		
D5843	45843	16D2			D5893	45893	1704		
D5844	45844	16D3			D5894	45894	1705		
D5845	45845	16D4			D5895	45895	1706		
D5846	45846	16D5			D5896	45896	1707		
D5847	45847	16D6	KEY-L *1	R/W	D5897	45897	1708		
D5848	45848	16D7	DISP-L *1	R/W	D5898	45898	1709		
D5849	45849	16D8	CSEL-L *1	R/W	D5899	45899	170A		
D5850	45850	16D9	KLOC-L *1	R/W	D5900	45900	170B		

*1: Same parameter exists in other menu. "-L" is added to the end of the parameter in KLOC menu or MLOC menu.

Setup parameter									
DI function setting (DI function registration menu: DI.SL)									
D-Reg No.	Ref. No.	H No.	Register symbol	R/W	D-Reg No.	Ref. No.	H No.	Register symbol	R/W
				UM33A					UM33A
D5901	45901	170C			D5951	45951	173E		
D5902	45902	170D			D5952	45952	173F		
D5903	45903	170E			D5953	45953	1740		
D5904	45904	170F			D5954	45954	1741		
D5905	45905	1710			D5955	45955	1742		
D5906	45906	1711			D5956	45956	1743		
D5907	45907	1712			D5957	45957	1744		
D5908	45908	1713			D5958	45958	1745		
D5909	45909	1714			D5959	45959	1746		
D5910	45910	1715			D5960	45960	1747		
D5911	45911	1716			D5961	45961	1748		
D5912	45912	1717			D5962	45962	1749		
D5913	45913	1718			D5963	45963	174A		
D5914	45914	1719			D5964	45964	174B		
D5915	45915	171A			D5965	45965	174C		
D5916	45916	171B			D5966	45966	174D		
D5917	45917	171C			D5967	45967	174E		
D5918	45918	171D			D5968	45968	174F		
D5919	45919	171E	RST-D *1	R/W	D5969	45969	1750		
D5920	45920	171F	LAT-D *1	R/W	D5970	45970	1751		
D5921	45921	1720	LCD-D *1	R/W	D5971	45971	1752		
D5922	45922	1721	MG1-D *1	R/W	D5972	45972	1753		
D5923	45923	1722	MG2-D *1	R/W	D5973	45973	1754		
D5924	45924	1723	MG3-D *1	R/W	D5974	45974	1755		
D5925	45925	1724	MG4-D *1	R/W	D5975	45975	1756		
D5926	45926	1725			D5976	45976	1757		
D5927	45927	1726			D5977	45977	1758		
D5928	45928	1727			D5978	45978	1759		
D5929	45929	1728			D5979	45979	175A		
D5930	45930	1729			D5980	45980	175B		
D5931	45931	172A			D5981	45981	175C		
D5932	45932	172B			D5982	45982	175D		
D5933	45933	172C			D5983	45983	175E		
D5934	45934	172D			D5984	45984	175F		
D5935	45935	172E			D5985	45985	1760		
D5936	45936	172F			D5986	45986	1761		
D5937	45937	1730	PVRW_L1-D *1	R/W	D5987	45987	1762		
D5938	45938	1731			D5988	45988	1763		
D5939	45939	1732			D5989	45989	1764		
D5940	45940	1733			D5990	45990	1765		
D5941	45941	1734			D5991	45991	1766		
D5942	45942	1735			D5992	45992	1767		
D5943	45943	1736			D5993	45993	1768		
D5944	45944	1737			D5994	45994	1769		
D5945	45945	1738			D5995	45995	176A		
D5946	45946	1739			D5996	45996	176B		
D5947	45947	173A			D5997	45997	176C		
D5948	45948	173B			D5998	45998	176D		
D5949	45949	173C			D5999	45999	176E		
D5950	45950	173D			D6000	46000	176F		

*1: Same parameter exists in other menu. "-D" is added to the end of the parameter in DI.SL menu.

10.4 UM33A D Registers

Setup parameter									
DI function setting (Message)									
D-Reg No.	Ref. No.	H No.	Register symbol	R/W	D-Reg No.	Ref. No.	H No.	Register symbol	R/W
				UM33A					UM33A
D6001	46001	1770	MSG1	R/W	D6051	46051	17A2	MSG3	R/W
D6002	46002	1771	MSG1	R/W	D6052	46052	17A3		
D6003	46003	1772	MSG1	R/W	D6053	46053	17A4		
D6004	46004	1773	MSG1	R/W	D6054	46054	17A5		
D6005	46005	1774	MSG1	R/W	D6055	46055	17A6		
D6006	46006	1775	MSG1	R/W	D6056	46056	17A7		
D6007	46007	1776	MSG1	R/W	D6057	46057	17A8		
D6008	46008	1777	MSG1	R/W	D6058	46058	17A9		
D6009	46009	1778	MSG1	R/W	D6059	46059	17AA		
D6010	46010	1779	MSG1	R/W	D6060	46060	17AB		
D6011	46011	177A	MSG1	R/W	D6061	46061	17AC	MSG4	R/W
D6012	46012	177B			D6062	46062	17AD	MSG4	R/W
D6013	46013	177C			D6063	46063	17AE	MSG4	R/W
D6014	46014	177D			D6064	46064	17AF	MSG4	R/W
D6015	46015	177E			D6065	46065	17B0	MSG4	R/W
D6016	46016	177F			D6066	46066	17B1	MSG4	R/W
D6017	46017	1780			D6067	46067	17B2	MSG4	R/W
D6018	46018	1781			D6068	46068	17B3	MSG4	R/W
D6019	46019	1782			D6069	46069	17B4	MSG4	R/W
D6020	46020	1783			D6070	46070	17B5	MSG4	R/W
D6021	46021	1784	MSG2	R/W	D6071	46071	17B6	MSG4	R/W
D6022	46022	1785	MSG2	R/W	D6072	46072	17B7		
D6023	46023	1786	MSG2	R/W	D6073	46073	17B8		
D6024	46024	1787	MSG2	R/W	D6074	46074	17B9		
D6025	46025	1788	MSG2	R/W	D6075	46075	17BA		
D6026	46026	1789	MSG2	R/W	D6076	46076	17BB		
D6027	46027	178A	MSG2	R/W	D6077	46077	17BC		
D6028	46028	178B	MSG2	R/W	D6078	46078	17BD		
D6029	46029	178C	MSG2	R/W	D6079	46079	17BE		
D6030	46030	178D	MSG2	R/W	D6080	46080	17BF		
D6031	46031	178E	MSG2	R/W	D6081	46081	17C0		
D6032	46032	178F			D6082	46082	17C1		
D6033	46033	1790			D6083	46083	17C2		
D6034	46034	1791			D6084	46084	17C3		
D6035	46035	1792			D6085	46085	17C4		
D6036	46036	1793			D6086	46086	17C5		
D6037	46037	1794			D6087	46087	17C6		
D6038	46038	1795			D6088	46088	17C7		
D6039	46039	1796			D6089	46089	17C8		
D6040	46040	1797			D6090	46090	17C9		
D6041	46041	1798	MSG3	R/W	D6091	46091	17CA		
D6042	46042	1799	MSG3	R/W	D6092	46092	17CB		
D6043	46043	179A	MSG3	R/W	D6093	46093	17CC		
D6044	46044	179B	MSG3	R/W	D6094	46094	17CD		
D6045	46045	179C	MSG3	R/W	D6095	46095	17CE		
D6046	46046	179D	MSG3	R/W	D6096	46096	17CF		
D6047	46047	179E	MSG3	R/W	D6097	46097	17D0		
D6048	46048	179F	MSG3	R/W	D6098	46098	17D1		
D6049	46049	17A0	MSG3	R/W	D6099	46099	17D2		
D6050	46050	17A1	MSG3	R/W	D6100	46100	17D3		

Setup parameter									
DI function setting (DI1-DI2 contact type setting menu: DI.D)									
D-Reg No.	Ref. No.	H No.	Register symbol	R/W	D-Reg No.	Ref. No.	H No.	Register symbol	R/W
				UM33A					UM33A
D6101	46101	17D4	DI1.D	R/W	D6151	46151	1806		
D6102	46102	17D5	DI2.D	R/W	D6152	46152	1807		
D6103	46103	17D6			D6153	46153	1808		
D6104	46104	17D7			D6154	46154	1809		
D6105	46105	17D8			D6155	46155	180A		
D6106	46106	17D9			D6156	46156	180B		
D6107	46107	17DA			D6157	46157	180C		
D6108	46108	17DB			D6158	46158	180D		
D6109	46109	17DC			D6159	46159	180E		
D6110	46110	17DD			D6160	46160	180F		
D6111	46111	17DE			D6161	46161	1810		
D6112	46112	17DF			D6162	46162	1811		
D6113	46113	17E0			D6163	46163	1812		
D6114	46114	17E1			D6164	46164	1813		
D6115	46115	17E2			D6165	46165	1814		
D6116	46116	17E3			D6166	46166	1815		
D6117	46117	17E4			D6167	46167	1816		
D6118	46118	17E5			D6168	46168	1817		
D6119	46119	17E6			D6169	46169	1818		
D6120	46120	17E7			D6170	46170	1819		
D6121	46121	17E8			D6171	46171	181A		
D6122	46122	17E9			D6172	46172	181B		
D6123	46123	17EA			D6173	46173	181C		
D6124	46124	17EB			D6174	46174	181D		
D6125	46125	17EC			D6175	46175	181E		
D6126	46126	17ED			D6176	46176	181F		
D6127	46127	17EE			D6177	46177	1820		
D6128	46128	17EF			D6178	46178	1821		
D6129	46129	17F0			D6179	46179	1822		
D6130	46130	17F1			D6180	46180	1823		
D6131	46131	17F2			D6181	46181	1824		
D6132	46132	17F3			D6182	46182	1825		
D6133	46133	17F4			D6183	46183	1826		
D6134	46134	17F5			D6184	46184	1827		
D6135	46135	17F6			D6185	46185	1828		
D6136	46136	17F7			D6186	46186	1829		
D6137	46137	17F8			D6187	46187	182A		
D6138	46138	17F9			D6188	46188	182B		
D6139	46139	17FA			D6189	46189	182C		
D6140	46140	17FB			D6190	46190	182D		
D6141	46141	17FC			D6191	46191	182E		
D6142	46142	17FD			D6192	46192	182F		
D6143	46143	17FE			D6193	46193	1830		
D6144	46144	17FF			D6194	46194	1831		
D6145	46145	1800			D6195	46195	1832		
D6146	46146	1801			D6196	46196	1833		
D6147	46147	1802			D6197	46197	1834		
D6148	46148	1803			D6198	46198	1835		
D6149	46149	1804			D6199	46199	1836		
D6150	46150	1805			D6200	46200	1837		

10.4 UM33A D Registers

Setup parameter									
DO function setting (AL1-AL4 function registration menu: ALM) (DO setting menu (E1): DO)									
D-Reg No.	Ref. No.	H No.	Register symbol	R/W	D-Reg No.	Ref. No.	H No.	Register symbol	R/W
				UM33A					UM33A
D6201	46201	1838			D6251	46251	186A		
D6202	46202	1839			D6252	46252	186B		
D6203	46203	183A			D6253	46253	186C		
D6204	46204	183B			D6254	46254	186D		
D6205	46205	183C			D6255	46255	186E		
D6206	46206	183D			D6256	46256	186F		
D6207	46207	183E			D6257	46257	1870		
D6208	46208	183F			D6258	46258	1871		
D6209	46209	1840			D6259	46259	1872		
D6210	46210	1841			D6260	46260	1873		
D6211	46211	1842	AL1.S	R/W	D6261	46261	1874		
D6212	46212	1843	AL2.S	R/W	D6262	46262	1875		
D6213	46213	1844	AL3.S	R/W	D6263	46263	1876		
D6214	46214	1845	AL4.S	R/W	D6264	46264	1877		
D6215	46215	1846	AL1.D	R/W	D6265	46265	1878		
D6216	46216	1847	AL2.D	R/W	D6266	46266	1879		
D6217	46217	1848	AL3.D	R/W	D6267	46267	187A		
D6218	46218	1849	AL4.D	R/W	D6268	46268	187B		
D6219	46219	184A			D6269	46269	187C		
D6220	46220	184B			D6270	46270	187D		
D6221	46221	184C	DO1.S_E1	R/W	D6271	46271	187E		
D6222	46222	184D	DO2.S_E1	R/W	D6272	46272	187F		
D6223	46223	184E	DO3.S_E1	R/W	D6273	46273	1880		
D6224	46224	184F	DO4.S_E1	R/W	D6274	46274	1881		
D6225	46225	1850	DO5.S_E1	R/W	D6275	46275	1882		
D6226	46226	1851	DO1.D_E1	R/W	D6276	46276	1883		
D6227	46227	1852	DO2.D_E1	R/W	D6277	46277	1884		
D6228	46228	1853	DO3.D_E1	R/W	D6278	46278	1885		
D6229	46229	1854	DO4.D_E1	R/W	D6279	46279	1886		
D6230	46230	1855	DO5.D_E1	R/W	D6280	46280	1887		
D6231	46231	1856			D6281	46281	1888		
D6232	46232	1857			D6282	46282	1889		
D6233	46233	1858			D6283	46283	188A		
D6234	46234	1859			D6284	46284	188B		
D6235	46235	185A			D6285	46285	188C		
D6236	46236	185B			D6286	46286	188D		
D6237	46237	185C			D6287	46287	188E		
D6238	46238	185D			D6288	46288	188F		
D6239	46239	185E			D6289	46289	1890		
D6240	46240	185F			D6290	46290	1891		
D6241	46241	1860			D6291	46291	1892		
D6242	46242	1861			D6292	46292	1893		
D6243	46243	1862			D6293	46293	1894		
D6244	46244	1863			D6294	46294	1895		
D6245	46245	1864			D6295	46295	1896		
D6246	46246	1865			D6296	46296	1897		
D6247	46247	1866			D6297	46297	1898		
D6248	46248	1867			D6298	46298	1899		
D6249	46249	1868			D6299	46299	189A		
D6250	46250	1869			D6300	46300	189B		

Setup parameter									
I/O display (Menu: I/O)									
D-Reg No.	Ref. No.	H No.	Register symbol	R/W	D-Reg No.	Ref. No.	H No.	Register symbol	R/W
				UM33A					UM33A
D6301	46301	189C	KEY-IO *1	R	D6351	46351	18CE		
D6302	46302	189D			D6352	46352	18CF		
D6303	46303	189E			D6353	46353	18D0		
D6304	46304	189F			D6354	46354	18D1		
D6305	46305	18A0			D6355	46355	18D2		
D6306	46306	18A1			D6356	46356	18D3		
D6307	46307	18A2			D6357	46357	18D4		
D6308	46308	18A3			D6358	46358	18D5		
D6309	46309	18A4			D6359	46359	18D6		
D6310	46310	18A5			D6360	46360	18D7		
D6311	46311	18A6			D6361	46361	18D8		
D6312	46312	18A7			D6362	46362	18D9		
D6313	46313	18A8			D6363	46363	18DA		
D6314	46314	18A9			D6364	46364	18DB		
D6315	46315	18AA			D6365	46365	18DC		
D6316	46316	18AB			D6366	46366	18DD		
D6317	46317	18AC			D6367	46367	18DE		
D6318	46318	18AD			D6368	46368	18DF		
D6319	46319	18AE			D6369	46369	18E0		
D6320	46320	18AF			D6370	46370	18E1		
D6321	46321	18B0			D6371	46371	18E2		
D6322	46322	18B1			D6372	46372	18E3		
D6323	46323	18B2			D6373	46373	18E4		
D6324	46324	18B3			D6374	46374	18E5		
D6325	46325	18B4			D6375	46375	18E6		
D6326	46326	18B5			D6376	46376	18E7		
D6327	46327	18B6			D6377	46377	18E8		
D6328	46328	18B7			D6378	46378	18E9		
D6329	46329	18B8			D6379	46379	18EA		
D6330	46330	18B9			D6380	46380	18EB		
D6331	46331	18BA			D6381	46381	18EC		
D6332	46332	18BB			D6382	46382	18ED		
D6333	46333	18BC			D6383	46383	18EE		
D6334	46334	18BD			D6384	46384	18EF		
D6335	46335	18BE			D6385	46385	18F0		
D6336	46336	18BF			D6386	46386	18F1		
D6337	46337	18C0			D6387	46387	18F2		
D6338	46338	18C1			D6388	46388	18F3		
D6339	46339	18C2			D6389	46389	18F4		
D6340	46340	18C3			D6390	46390	18F5		
D6341	46341	18C4			D6391	46391	18F6		
D6342	46342	18C5			D6392	46392	18F7		
D6343	46343	18C6			D6393	46393	18F8		
D6344	46344	18C7			D6394	46394	18F9		
D6345	46345	18C8			D6395	46395	18FA		
D6346	46346	18C9			D6396	46396	18FB		
D6347	46347	18CA			D6397	46397	18FC		
D6348	46348	18CB			D6398	46398	18FD		
D6349	46349	18CC			D6399	46399	18FE		
D6350	46350	18CD			D6400	46400	18FF		

*1: Same parameter exists in other menu. "-IO" is added to the end of the parameter in I/O menu.

10.4 UM33A D Registers

Setup parameter									
System setting (Menu: SYS)									
D-Reg No.	Ref. No.	H No.	Register symbol	R/W UM33A	D-Reg No.	Ref. No.	H No.	Register symbol	R/W UM33A
D6401	46401	1900			D6451	46451	1932		
D6402	46402	1901	R.TM	R/W	D6452	46452	1933		
D6403	46403	1902			D6453	46453	1934		
D6404	46404	1903			D6454	46454	1935		
D6405	46405	1904			D6455	46455	1936		
D6406	46406	1905			D6456	46456	1937		
D6407	46407	1906			D6457	46457	1938		
D6408	46408	1907			D6458	46458	1939		
D6409	46409	1908	C.GRN	R/W	D6459	46459	193A		
D6410	46410	1909	FREQ	R/W	D6460	46460	193B		
D6411	46411	190A			D6461	46461	193C		
D6412	46412	190B			D6462	46462	193D		
D6413	46413	190C			D6463	46463	193E		
D6414	46414	190D			D6464	46464	193F		
D6415	46415	190E			D6465	46465	1940		
D6416	46416	190F			D6466	46466	1941		
D6417	46417	1910	QSM	R/W	D6467	46467	1942		
D6418	46418	1911	LANG	R/W	D6468	46468	1943		
D6419	46419	1912			D6469	46469	1944		
D6420	46420	1913			D6470	46470	1945		
D6421	46421	1914	U.DEF	R/W	D6471	46471	1946		
D6422	46422	1915			D6472	46472	1947		
D6423	46423	1916	F.DEF	R/W	D6473	46473	1948		
D6424	46424	1917			D6474	46474	1949		
D6425	46425	1918			D6475	46475	194A		
D6426	46426	1919			D6476	46476	194B		
D6427	46427	191A			D6477	46477	194C		
D6428	46428	191B			D6478	46478	194D		
D6429	46429	191C			D6479	46479	194E		
D6430	46430	191D			D6480	46480	194F		
D6431	46431	191E	LEVL	R/W	D6481	46481	1950		
D6432	46432	191F			D6482	46482	1951		
D6433	46433	1920			D6483	46483	1952		
D6434	46434	1921			D6484	46484	1953		
D6435	46435	1922			D6485	46485	1954		
D6436	46436	1923			D6486	46486	1955		
D6437	46437	1924			D6487	46487	1956		
D6438	46438	1925			D6488	46488	1957		
D6439	46439	1926			D6489	46489	1958		
D6440	46440	1927			D6490	46490	1959		
D6441	46441	1928			D6491	46491	195A		
D6442	46442	1929			D6492	46492	195B		
D6443	46443	192A			D6493	46493	195C		
D6444	46444	192B			D6494	46494	195D		
D6445	46445	192C			D6495	46495	195E		
D6446	46446	192D			D6496	46496	195F		
D6447	46447	192E			D6497	46497	1960		
D6448	46448	192F			D6498	46498	1961		
D6449	46449	1930			D6499	46499	1962		
D6450	46450	1931			D6500	46500	1963		

D6501 to D7600: Free area

Function Setting (D5001 to D5100)

Register No.	Description	Range and meaning of value
D5001 to D5008		
D5009	ALNO_L1	Number of alarms 1 to 8
D5010 to D5018		
D5019	SMP	Input sampling period (control period) 0: 50 (50 ms) 1: 100 (100 ms) 2: 200 (200 ms)
D5019 to D5100		

10.4 UM33A D Registers

Input Setting (D5101 to D5300)

Register No.		Description	Range and meaning of value
D5101	IN	PV input type	0: OFF (Disable) 1: K1 (-270.0 to 1370.0°C / -450.0 to 2500.0 F) 2: K2 (-270.0 to 1000.0°C / -450.0 to 2300.0 F) 3: K3 (-200.0 to 500.0°C / -200.0 to 1000.0 F) 4: J (-200.0 to 1200.0°C / -300.0 to 2300.0 F) 5: T1 (-270.0 to 400.0°C / -450.0 to 750.0 F) 6: T2 (0.0 to 400.0°C / -200.0 to 750.0 F) 7: B (0.0 to 1800.0°C / 32 to 3300 F) 8: S (0.0 to 1700.0°C / 32 to 3100 F) 9: R (0.0 to 1700.0°C / 32 to 3100 F) 10: N (-200.0 to 1300.0°C / -300.0 to 2400.0 F) 11: E (-270.0 to 1000.0°C / -450.0 to 1800.0 F) 12: L (-200.0 to 900.0°C / -300.0 to 1600.0 F) 13: U1 (-200.0 to 400.0°C / -300.0 to 750.0 F) 14: U2 (0.0 to 400.0°C / -200.0 to 1000.0 F) 15: W (0.0 to 2300.0°C / 32 to 4200 F) 16: PL2 (0.0 to 1390.0°C / 32.0 to 2500.0 F) 17: P2040 (0.0 to 1900.0°C / 32 to 3400 F) 18: WRE (0.0 to 2000.0°C / 32 to 3600 F) 30: JPT1 (-200.0 to 500.0°C / -300.0 to 1000.0 F) 31: JPT2 (-150.00 to 150.00°C / -200.0 to 300.0 F) 35: PT1 (-200.0 to 850.0°C / -300.0 to 1560.0 F) 36: PT2 (-200.0 to 500.0°C / -300.0 to 1000.0 F) 37: PT3 (-150.00 to 150.00°C / -200.0 to 300.0 F) 40: 0.4-2V (0.400 to 2.000 V) 41: 1-5V (1.000 to 5.000 V) 42: 4-20 (4.00 to 20.00 mA) 50: 0-2V (0.000 to 2.000 V) 51: 0-10V (0.00 to 10.00 V) 52: 0-20 (0.00 to 20.00 mA) 55: -1020 (-10.00 to 20.00 mV) 56: 0-100 (0.0 to 100.0 mV) *W: W-5% Re/W-26% Re(Hoskins Mfg. Co.), ASTM E988 WRE: W97Re3-W75Re25
D5102	UNIT	PV input unit	0, 2, 3, 4: - (No unit) 1: C (Degree Celsius) 5: F (Degree Fahrenheit)
D5103	DP	PV input decimal point position	0: No decimal place 1: One decimal place 2: Two decimal places 3: Three decimal places 4: Four decimal places
D5104	RH	Maximum value of PV input range	Depends on the input type. - For temperature input - Set the temperature range that is actually displayed. (RL<RH) - For voltage / current input - Set the range of a voltage / current signal that is applied. The scale across which the voltage / current signal is actually displayed should be set using the maximum value of input scale (SH) and minimum value of input scale (SL). (Input is always 0% when RL = RH.)
D5105	RL	Minimum value of PV input range	Same as D5103
D5106	SDP	PV input scale decimal point position	Same as D5103
D5107	SH	Maximum value of PV input scale	-19999 to 30000, (SL<SH), SH - SL ≤ 30000
D5108	SL	Minimum value of PV input scale	
D5109	BSL	PV input burnout action	0: OFF (Disable) 1: UP (Upscale) 2: DOWN (Downscale)
D5110	RJC	PV input reference junction compensation	0: OFF (RJC OFF) 1: ON (RJC ON)
D5111	ERJC	PV input external RJC setpoint	-10.0 to 60.0°C
D5112 to D5200			

Register No.	Description		Range and meaning of value
D5201	P.UNI_L1	Control PV input unit	0, 2, 3, 4: - (No unit) 1: C (Degree Celsius) 5: F (Degree Fahrenheit)
D5202	P.DP_L1	Control PV input decimal point position	0: No decimal place 1: One decimal place 2: Two decimal places 3: Three decimal places 4: Four decimal places
D5203	P.RH_L1	Maximum value of control PV input range	-19999 to 30000, (P.RL<P.RH), P.RH - P.RL ≤ 30000
D5204	P.RL_L1	Minimum value of control PV input range	
D5205 to D5300			

Output Setting (D5301 to D5400)

Register No.	Description		Range and meaning of value
D5301 to D5320			
D5321	RTS	Retransmission output type of RET	0: OFF (Disable) 1: PV1 (PV) 4: LPS (15 V DC loop power supply)
D5322	RTH	Maximum value of retransmission output scale of RET	When RTS=1 (PV1), RTL+1digit to 30000 Decimal point position: RTS=1 (PV1): decimal point position is same as that of PV input.
D5323	RTL	Minimum value of retransmission output scale of RET	When RTS=1 (PV1), -19999 to RTH-1digit Decimal point position: RTS=1 (PV1): decimal point position is same as that of PV input.
D5324 to D5334			
D5335	RET.H	100% segmental point of RET current output	-100.0 to 200.0%
D5336	RET.L	0% segmental point of RET current output	
D5337 to D5342			
D5343	RET.A	RET current output range	0: 4-20 (4 to 20 mA) 1: 0-20 (0 to 20 mA) 2: 20-4 (20 to 4 mA) 3: 20-0 (20 to 0 mA)
D5344 to D5400			

Free Area (D5401 to D5500)

Register No.	Description		Range and meaning of value
D5401 to 5500			Free area

10.4 UM33A D Registers

Communication Setting (D5501 to D5700)

Register No.		Description	Range and meaning of value
D5501	PSL_E1	Protocol selection	0: PCL (PC link communication) 1: PCLSM (PC link communication (with checksum)) 2: LADR (Ladder communication) 3: CO-M (Coordinated master station) 4: CO-S (Coordinated slave station) 7: MBASC (Modbus (ASCII)) 8: MBRTU (Modbus (RTU)) 10: CO-S1 (Coordinated slave station (Loop-1 mode)) 11: CO-S2 (Coordinated slave station (Loop-2 mode)) 12: P-P (Peer-to-peer communication)
D5502	BPS_E1	Baud rate	0: 600 (600 bps) 1: 1200 (1200 bps) 2: 2400 (2400 bps) 3: 4800 (4800 bps) 4: 9600 (9600 bps) 5: 19200 (19.2k bps) 6: 38400 (38.4k bps)
D5503	PRI_E1	Parity	0: NONE (None) 1: EVEN (Even) 2: ODD (Odd)
D5504	STP_E1	Stop bit	1: 1 bit, 2: 2 bit
D5505	DLN_E1	Data length	7: 7 bit, 8: 8bit
D5506	ADR_E1	Address	1 to 99
D5507	RP.T_E1	Minimum response time	0 to 10 (x10ms)
D5508 ro D5700			

Key Operation Setting, Display Function Setting, and SELECT Display Setting (D5701 to D5800)

Register No.		Description	Range and meaning of value
D5701 to D5702			
D5703	Fn *1	User function key-n action setting	0: OFF (Disable) 18: LTUP (LCD brightness UP) 19: LTDN (LCD brightness DOWN) 20: BRI (Adjust LCD brightness) 21: LCD (LCD backlight ON/OFF switch) 22: LAT (Latch release) 23: PID (PID tuning switch) 24: AL (Alarm Setpoint Setting) 25: RST (PV peak and bottom values reset)
D5704 to D5712			
D5713	PCMD_L1	Active color PV display switch	0: Fixed in white 1: Fixed in red 2: Link to alarm 1 (Alarm OFF: white, Alarm ON: red) 3: Link to alarm 1 (Alarm OFF: red, Alarm ON: white) 4: Link to alarm 1 or 2 (Alarm OFF: white, Alarm ON: red) 5: Link to alarm 1 or 2 (Alarm OFF: red, Alarm ON: white) 6: PV limit (Within range: white, Out of range: red) 7: PV limit (Within range: red, Out of range: white) 10: Link to DI (ON: red, OFF: white)
D5714	PCH_L1	PV color change high limit	Set a display value when in PV limit or SP deviation.
D5715	PCL_L1	PV color change low limit	-19999 to 30000 (Set a value within the input range.) Decimal point position depends on the input type.
D5716 to D5722			
D5723	EV1_L1	EV1 display condition registration	Setting range: 4001 to 6304
D5724	EV2_L1	EV2 display condition registration	OFF: Disable
D5725	EV3_L1	EV3 display condition registration	4321: Link to alarm 1 (Lit when the alarm occurs) 4322: Link to alarm 2 (Lit when the alarm occurs) 4323: Link to alarm 3 (Lit when the alarm occurs) 4325: Link to alarm 4 (Lit when the alarm occurs) 4326: Link to alarm 5 (Lit when the alarm occurs) 4327: Link to alarm 6 (Lit when the alarm occurs) 4329: Link to alarm 7 (Lit when the alarm occurs) 4330: Link to alarm 8 (Lit when the alarm occurs)
D5726	EV4_L1	EV4 display condition registration	5025 to 5026: Link to DI1-DI2 (Lit when the contact is closed) 5153 to 5155: Link to AL1-AL3 (Lit when the contact is closed) 5156: Link to AL4 (Lit when the contact is closed) 5169 to 5173: Link to DO11-DO15 (E1- terminal area) (Lit when the contact is closed) For other functions, see the Chapter 11 Functions and Applications of I Relays (for UM33A). *: Initial value. The contact action changes by the setting of each "contact type" parameter.
D5727 to D5738			
D5739	PV.D	PV display area ON/OFF	0: OFF (Nondisplay) 1: ON (Display)
D5740	SP.D	Setpoint display area ON/OFF	
D5741	STS.D	Status display area ON/OFF	
D5742	SPD	Scroll speed	(Slow) 1 to 8 (Quick)
D5743	GUID	Guide display ON/OFF	0: OFF (Nondisplay) 1: ON (Display)

*1: Same parameter exists in other menu. "-K" is added to the end of the parameter in KEY menu.

10.4 UM33A D Registers

Register No.	Description		Range and meaning of value
D5744	HOME	Home Operation Display setting	0: Valve Position Display 18: CS1 (SELECT Display 1) 19: CS2 (SELECT Display 2) 20: CS3 (SELECT Display 3) 21: CS4 (SELECT Display 4) 22: CS5 (SELECT Display 5)
D5745	ECO	Economy mode	0: OFF (Disable) 1: Economy mode ON (All indications except PV display OFF) 2: Economy mode ON (All indications OFF) 3: Brightness 10 % (whole indication)
D5746	BRI	Brightness	(Dark) 1 to 5 (Bright)
D5747	B.PVW	White brightness adjustment of PV display	Adjusts the white brightness of PV display. (Dark) -4 to 4 (Bright)
D5748	B.PVR	Red brightness adjustment of PV display	Adjusts the red brightness of PV display. (Dark) -4 to 4 (Bright)
D5749	B.SP	Brightness adjustment of Setpoint display	Adjusts the brightness of SP display. (Dark) -4 to 4 (Bright)
D5750			
D5751	B.STS	Brightness adjustment of Status indicator	Adjusts the brightness of Status display. (Dark) -4 to 4 (Bright)
D5752			
D5753	D.CYC	Display update cycle	1: 100 ms 2: 200 ms 3: 500 ms 4: 1 s 5: 2 s
D5754	OP.JP	AUTORETURN TO OPERATION DISPLAY	Automatically returned to the Operation Display when there has been no keystroke operation for 5 minutes. 0: OFF (Not automatically returned) 1: ON (Automatically returned)
D5755	MLSD	Least significant digital mask of PV display	0: OFF (With least significant digit) 1: ON (Without least significant digit)
D5756 to D5760			
D5761	CS1	SELECT Display-1 registration	Register the operation parameter (except the Operation Mode) that is frequently modified to display it in the Operation Display. 0: OFF (No registration) 2301 to 5000 (Register the register number of the parameter)
D5762	CS2	SELECT Display-2 registration	
D5763	CS3	SELECT Display-3 registration	
D5764	CS4	SELECT Display-4 registration	
D5765	CS5	SELECT Display-5 registration	
D5766 to D5800			

Lock Setting (Key Lock/Menu Lock) (D5801 to D5900)

Register No.	Description	Range and meaning of value
D5801 to D5817		
D5818	COM.W	Communication write enable/disable 0: OFF (Enable) 1: ON (Disable)
D5819	DATA-L *1	Front panel parameter data key lock 0: OFF (Unlock) 1: ON (Lock)
D5820		
D5821	U.PV	PV Display lock 0: OFF (Display) 1: ON (Nondisplay)
D5822 to D5830		
D5831	CTL-L *1	[CTL] menu lock
D5832	PV-L *1	[PV] menu lock
D5833 to D5835		
D5836	MPV_L1-L *1	[MPV] menu lock
D5837		0: OFF (Display) 1: ON (Nondisplay)
D5838	OUT-L *1	[OUT] menu lock
D5839		
D5840	R485_E1-L *1	[R485] menu lock (E1-terminal area)
D5841 to D5846		
D5847	KEY-L *1	[KEY] menu lock
D5848	DISP-L *1	[DISP] menu lock
D5849	CSEL-L *1	[CSEL] menu lock
D5850	KLOC-L *1	[KLOC] menu lock
D5851	DI.SL-L *1	[DI.SL] menu lock
D5852		0: OFF (Display) 1: ON (Nondisplay)
D5853	DI.D-L *1	[DI.D] menu lock
D5854 to D5857		
D5858	ALM-L *1	[ALM] menu lock
D5859	DO_E1-L *1	[DO] menu lock (E1-terminal area)
D5860 to D5862		
D5863	I/O-L *1	[I/O] menu lock
D5864	SYS-L *1	[SYS] menu lock
D5865	INIT-L *1	[INIT] menu lock
D5866	VER-L *1	[VER] menu lock
D5867	LVL-L *1	[LVL] menu lock
D5868 to D5871		
D5872	ALRM_L1-L *1	[ALRM] menu lock
D5873		0: OFF (Display) 1: ON (Nondisplay)
D5874	PVS_L1-L *1	[PVS] menu lock
D5875 to D5885		
D5886	PYS1-L *1	[PYS1] menu lock
D5887	PYS2-L *1	[PYS2] menu lock
D5888 to D5889		
D5890	AL-L *1	[AL] menu lock
D5891 to D5900		

*1: Same parameter exists in other menu. "-L" is added to the end of the parameter in KLOC menu or MLOC menu.

10.4 UM33A D Registers

DI Function Setting (D5901 to D6200)

Register No.	Description	Range and meaning of value
D5901 to D5918		
D5919	RST-D *1	
D5920	LAT-D *1	Latch release
D5921	LCD-D *1	LCD backlight ON/OFF switch
D5922	MG1-D *1	Message display interruption 1
D5923	MG2-D *1	Message display interruption 2
D5924	MG3-D *1	Message display interruption 3
D5925	MG4-D *1	Message display interruption 4
D5926 to D5936		
D5937	PVRW_L1-D *1	PV red/white switch
D5938 to D6000		
D6001	MSG1	20-digit value of alphanumeric characters can be set. Arrangement: D6001, D6002, D6003, D6004, D6005, D6006, D6007, DD6008, D6009, D6010, D6011 Write "0x00" to the register after the character string.
D6002	MSG1	
D6003	MSG1	
D6004	MSG1	
D6005	MSG1	
D6006	MSG1	
D6007	MSG1	
D6008	MSG1	
D6009	MSG1	
D6010	MSG1	
D6011	MSG1	
D6012 to D6020		
D6021	MSG2	20-digit value of alphanumeric characters can be set. Arrangement: D6021, D6022, D6023, D6024, D6025, D6026, D6027, D6028, D6029, D6030, D6031 Write "0x00" to the register after the character string.
D6022	MSG2	
D6023	MSG2	
D6024	MSG2	
D6025	MSG2	
D6026	MSG2	
D6027	MSG2	
D6028	MSG2	
D6029	MSG2	
D6030	MSG2	
D6031	MSG2	
D6032 to D6040		
D6041	MSG3	20-digit value of alphanumeric characters can be set. Arrangement: D6041, D6042, D6043, D6044, D6045, D6046, D6047, D6048, D6049, D6050, D6051 Write "0x00" to the register after the character string.
D6042	MSG3	
D6043	MSG3	
D6044	MSG3	
D6045	MSG3	
D6046	MSG3	
D6047	MSG3	
D6048	MSG3	
D6049	MSG3	
D6050	MSG3	
D6051	MSG3	
D6052 to D6060		

*2: With regards to the information on D6001 to D6011, D6021 to D6031, D6041 to D6051, and D6061 to D6071, 11 D registers comprise one message.

Register No.	Description		Range and meaning of value
D6061	MSG4	Message-4 *2	20-digit value of alphanumeric characters can be set. Arrangement: D6061, D6062, D6063, D6064, D6065, D6066, D6067, D6068, D6069, D6070, D6071 Write "0x00" to the register after the character string.
D6062	MSG4		
D6063	MSG4		
D6064	MSG4		
D6065	MSG4		
D6066	MSG4		
D6067	MSG4		
D6068	MSG4		
D6069	MSG4		
D6070	MSG4		
D6071	MSG4		
D6072 to D6100			
D6101	DI1.D	DI1 contact type	0: The assigned function is enabled when the contact is closed. 1: The assigned function is enabled when the contact is opened.
D6102	DI2.D	DI2 contact type	
D6102 to D6200			

*1: Same parameter exists in other menu. "-D" is added to the end of the parameter in DI.SL menu.

*2: With regards to the information on D6001 to D6011, D6021 to D6031, D6041 to D6051, and D6061 to D6071, 11 D registers comprise one message.

DO Function Setting (D6201 to D6300)

Register No.	Description		Range and meaning of value
D6201 to D6210			
D6211	AL1.S	AL1 function selection	Set an I relay number (Setting range: 4001 to 6304). Ex.) Set the number 4353 for AL1.S to use the alarm 1. 0: OFF (No function) Alarm 1: 4353 Alarm 2: 4354 Alarm 3: 4355 Alarm 4: 4357 Alarm 5: 4358 Alarm 6: 4359 Alarm 7: 4361 Alarm 8: 4362
D6212	AL2.S	AL2 function selection	Alarm 5: 4358 Alarm 6: 4359 Alarm 7: 4361 Alarm 8: 4362
D6213	AL3.S	AL3 function selection	FAIL (Normally ON) output: 4256
D6214	AL4.S	AL4 function selection	For the items other than below, see the Chapter 11 Functions and Applications of I Relays (for UM33A).
D6215	AL1.D	AL1 contact type	0: When the event of assigned function occurs, the contact is closed. 1: When the event of assigned function occurs, the contact is opened.
D6216	AL2.D	AL2 contact type	
D6217	AL3.D	AL3 contact type	
D6218	AL4.D	AL4 contact type	
D6219 to D6220			
D6221	DO1.S_E1	DO11 function selection	Same as D6211
D6222	DO2.S_E1	DO12 function selection	
D6223	DO3.S_E1	DO13 function selection	
D6224	DO4.S_E1	DO14 function selection	
D6225	DO5.S_E1	DO15 function selection	
D6226	DO1.D_E1	DO11 contact type	Same as D62615
D6227	DO2.D_E1	DO12 contact type	
D6228	DO3.D_E1	DO13 contact type	
D6229	DO4.D_E1	DO14 contact type	
D6230	DO5.D_E1	DO15 contact type	
D6231 to D6300			

10.4 UM33A D Registers

I/O Display (D6301 to D6400)

● Bit Configuration of D6301: KEY-IO*1 (Key status)

Bit	Symbol	Event
0	PARA_KEY	PARAMETER (PARA) key (0: OFF 1: ON)
1	DISP_KEY	DISPLAY (DISP) key (0: OFF 1: ON)
2	RIGHT_KEY	RIGHT key (0: OFF 1: ON)
3	DOWN_KEY	DOWN key (0: OFF 1: ON)
4	SET_KEY	SET/ENTER key (0: OFF 1: ON)
5	UP_KEY	UP key (0: OFF 1: ON)
6	LEFT_KEY	LEFT key (0: OFF 1: ON)
7 to 9		
10	FN_KEY	Fn key (0: OFF 1: ON)
11 to 15		

*1: Same parameter exists in other menu. "-IO" is added to the end of the parameter in I/O menu.

● D6302 to D6400

Register No.	Description	Range and meaning of value
D6302 to D6400	Free area	

System Setting (D6401 to D6500)

Register No.	Description	Range and meaning of value
D6401		
D6402	R.TM	Restart timer Set time between power on and the instant where controller starts computation. 0 to 10 s
D6403 to D6408		
D6409	C.GRN	Response as GREEN Series 0: OFF (Works as UM33A in communication of device information response or broadcasting.) 1: ON (Works as GREEN Series in communication of device information response or broadcasting.)
D6410	FREQ	Power frequency 0: AUTO 1: 60 Hz 2: 50 Hz
D6411 to D6416		
D6417	QSM	Quick setting mode 0: OFF (Disable) 1: ON (Enable)
D6418	LANG	Guide display language 0: ENG (English) 1: FRA (French) 2: GER (German) 3: SPA (Spanish)
D6419 to D6420		
D6421	U.DEF	Initialization to user default value 12345: Initialization, automatically returned to "0" after initialization.
D6422		
D6423	F.DEF	Initialization to factory default value -12345: Initialization, automatically returned to "0" after initialization.
D6424 to D6430		
D6431	LEVL	Parameter display level 1: EASY (Easy setting mode) 2: STANDAR (Standard setting mode) 3: PRO (Professional setting mode)
D6432 to D6500		

Free Area (D6501 to D7600)

Register No.	Description	Range and meaning of value
D6501 to D7600	Free area	

10.4.5 Input / Output Terminal Status Register (D7601 to D7700)

Terminal status registers									
Input / output terminal status register									
D-Reg No.	Ref. No.	H No.	Register symbol	R/W UM33A	D-Reg No.	Ref. No.	H No.	Register symbol	R/W UM33A
D7601	47601	1DB0	DI	R	D7651	47651	1DE2		
D7602	47602	1DB1			D7652	47652	1DE3		
D7603	47603	1DB2			D7653	47653	1DE4		
D7604	47604	1DB3			D7654	47654	1DE5		
D7605	47605	1DB4			D7655	47655	1DE6		
D7606	47606	1DB5			D7656	47656	1DE7		
D7607	47607	1DB6			D7657	47657	1DE8		
D7608	47608	1DB7			D7658	47658	1DE9		
D7609	47609	1DB8			D7659	47659	1DEA		
D7610	47610	1DB9			D7660	47660	1DEB		
D7611	47611	1DBA	OUT_AL	R	D7661	47661	1DEC		
D7612	47612	1DBB	OUT_DO_E1	R	D7662	47662	1DED		
D7613	47613	1DBC			D7663	47663	1DEE		
D7614	47614	1DBD			D7664	47664	1DEF		
D7615	47615	1DBE			D7665	47665	1DF0		
D7616	47616	1DBF			D7666	47666	1DF1		
D7617	47617	1DC0			D7667	47667	1DF2		
D7618	47618	1DC1			D7668	47668	1DF3		
D7619	47619	1DC2			D7669	47669	1DF4		
D7620	47620	1DC3			D7670	47670	1DF5		
D7621	47621	1DC4			D7671	47671	1DF6		
D7622	47622	1DC5			D7672	47672	1DF7		
D7623	47623	1DC6			D7673	47673	1DF8		
D7624	47624	1DC7	OUT_RET	R	D7674	47674	1DF9		
D7625	47625	1DC8	OUT_OUTR	R	D7675	47675	1DFA		
D7626	47626	1DC9			D7676	47676	1DFB		
D7627	47627	1DCA			D7677	47677	1DFC		
D7628	47628	1DCB			D7678	47678	1DFD		
D7629	47629	1DCC			D7679	47679	1DFE		
D7630	47630	1DCD			D7680	47680	1DFF		
D7631	47631	1DCE			D7681	47681	1E00		
D7632	47632	1DCF			D7682	47682	1E01		
D7633	47633	1DD0			D7683	47683	1E02		
D7634	47634	1DD1			D7684	47684	1E03		
D7635	47635	1DD2			D7685	47685	1E04		
D7636	47636	1DD3			D7686	47686	1E05		
D7637	47637	1DD4			D7687	47687	1E06		
D7638	47638	1DD5			D7688	47688	1E07		
D7639	47639	1DD6			D7689	47689	1E08		
D7640	47640	1DD7			D7690	47690	1E09		
D7641	47641	1DD8			D7691	47691	1E0A		
D7642	47642	1DD9			D7692	47692	1E0B		
D7643	47643	1DDA			D7693	47693	1E0C		
D7644	47644	1ddb			D7694	47694	1E0D		
D7645	47645	1DDC			D7695	47695	1E0E		
D7646	47646	1DDD			D7696	47696	1E0F		
D7647	47647	1DDE			D7697	47697	1E10		
D7648	47648	1DDF			D7698	47698	1E11		
D7649	47649	1DE0			D7699	47699	1E12		
D7650	47650	1DE1			D7700	47700	1E13		

10.4 UM33A D Registers

● Bit Configuration of D7601: DI (DI1-DI2 terminal status: equipped as standard)

Bit	Symbol	Event
0	DI1	DI1 terminal status (0: OFF 1: ON)
1	DI2	DI2 terminal status (0: OFF 1: ON)
2 to 15		

● Bit Configuration of D7611: OUT_AL (AL1-AL3 terminal status: equipped as standard)

Bit	Symbol	Event
0	OUT_AL1	AL1 terminal status (0: OFF 1: ON)
1	OUT_AL2	AL2 terminal status (0: OFF 1: ON)
2	OUT_AL3	AL3 terminal status (0: OFF 1: ON)
3 to 15		

● Bit Configuration of D7612: OUT_DO_E1 (DO11-DO15 terminal status: E1-terminal area)

Bit	Symbol	Event
0	OUT_DO11	DO11 terminal status (0: OFF 1: ON)
1	OUT_DO12	DO12 terminal status (0: OFF 1: ON)
2	OUT_DO13	DO13 terminal status (0: OFF 1: ON)
3	OUT_DO14	DO14 terminal status (0: OFF 1: ON)
4	OUT_DO15	DO15 terminal status (0: OFF 1: ON)
5 to 15		

● D7613 to D7700

Register No.	Description	Range and meaning of value
D7613 to D7623		
D7624	OUT_RET	RET terminal -1500 (-5%) to 31500 (105%)
D7625	OUT_OUTR	AL4 terminal status 0: OFF 30000: ON
D7626 to D7700		

10.5 Writing via Communication

■ Setting Target Setpoint

In LCL (local) mode

(1) Write the setpoint in the Alarm-1 setpoint to Alarm-8 setpoint.

Register No.	Register symbol	Description
D2351	A1_L1	Alarm-1 setpoint
D2352	A2_L1	Alarm-2 setpoint
D2353	A3_L1	Alarm-3 setpoint
D2354	A4_L1	Alarm-4 setpoint
D2355	A5_L1	Alarm-5 setpoint
D2356	A6_L1	Alarm-6 setpoint
D2357	A7_L1	Alarm-7 setpoint
D2358	A8_L1	Alarm-8 setpoint
D5009	ALNO.	Number of alarms

10.6 GREEN Series Compatible D Registers

10.6.1 Compatibility with GREEN Series Controllers

The D register map configuration of the UTAdvanced is the same as that of the GREEN Series (UM300 Series) controllers that perform access in the 2-byte integer data format. When GREEN Series devices are replaced with the UTAdvanced, communication programs created in the GREEN Series controllers can be used by just carrying out wiring. If existing programs created in the GREEN Series controllers are used, communication is performed using the area from D0001 to D2000.

However, although the function allocation from D0001 to D1300 is the same as that of the GREEN Series (UM300 Series) controllers, the setting ranges and the function operation specifications of registers are subject to the specifications of the UTAdvanced.

Furthermore, the functions have been enhanced from the GREEN Series controllers, so the generic settings and functions for some registers have been changed. For the changed registers, see "10.6.10 D Registers Differing in Content from GREEN Series."

The register map after D2001 is a D register map allocated for the UTAdvanced.

When you want to newly perform communication, be sure to use the registers after D2001.

10.6.2 Interpretation of D Register Tables

Register map (Categories)					
Register contents					
D-Reg No.	Ref. No.	H No.	Register symbol for GREEN	Register symbol for UTAdvanced	R/W
D0001	40001	0000	ADERROR	AD1.E_G *1	R
D0002	40002	0001	ERROR.1	PV1.E_L1_G *1	R
D0003	40003	0002	PV.1	PV_L1 (D2003)	
:	:	:	:	:	:
D0250	40250	00F9	ORB.1	/ *3	R
:	:	:	:	:	:
D0915	40915	0392	AL1.1	AL1.T_L1 (D2801)*2	R/W

(1) D register numbers (2) Reference numbers (for Modbus communication) (3) Hexadecimal numbers (for Modbus communication)

Numbers in parentheses indicate the same register after D2001.

Read/write by communication
R: Read enabled
W: Write enabled

■ Interpretation of Cell

*1: AD1.E_G (with _G) indicates a D register converted for the GREEN Series.

Furthermore, PV1.E_L1_G (shaded cell) indicates that it differs in content from that of the GREEN Series.

See "10.6.9 D Registers Converted for GREEN Series" described later.

*2: D100 (D7601) (shaded cell) indicates that it differs in content from that of the GREEN Series.

See "10.6.10 D Registers Differing in Content from GREEN Series" described later.

*3: A cell marked with a diagonal line ("/") indicates that it is not supported by the UTAdvanced.

10.6 GREEN Series Compatible D Registers

10.6.3 Process Data and User Area (D0001 to D0100)

Configuration map for GREEN Series											
Process data						User area					
D-Reg No.	Ref. No.	H No.	Register symbol for GREEN	Register symbol for UTAdvanced	R/W	D-Reg No.	Ref. No.	H No.	Register symbol for GREEN	Register symbol for UTAdvanced	R/W
D0001	40001	0000	ADERROR	AD1.E_G	R	D0051	40051	0032	USER	USER1	R/W
D0002	40002	0001	ERROR	PV1.E_L1_G	R	D0052	40052	0033	USER	USER2	R/W
D0003	40003	0002	PV	PV_L1 (D2003)	R	D0053	40053	0034	USER	USER3	R/W
D0004	40004	0003				D0054	40054	0035	USER	USER4	R/W
D0005	40005	0004				D0055	40055	0036	USER	USER5	R/W
D0006	40006	0005				D0056	40056	0037	USER	USER6	R/W
D0007	40007	0006				D0057	40057	0038	USER	USER7	R/W
D0008	40008	0007				D0058	40058	0039	USER	USER8	R/W
D0009	40009	0008				D0059	40059	003A	USER	USER9	R/W
D0010	40010	0009				D0060	40060	003B	USER	USER10	R/W
D0011	40011	000A	ALM	ALM_G	R	D0061	40061	003C	USER	USER11	R/W
D0012	40012	000B				D0062	40062	003D	USER	USER12	R/W
D0013	40013	000C				D0063	40063	003E	USER	USER13	R/W
D0014	40014	000D				D0064	40064	003F	USER	USER14	R/W
D0015	40015	000E				D0065	40065	0040	USER	USER15	R/W
D0016	40016	000F				D0066	40066	0041	USER	USER16	R/W
D0017	40017	0010				D0067	40067	0042	USER	USER17	R/W
D0018	40018	0011				D0068	40068	0043	USER	USER18	R/W
D0019	40019	0012				D0069	40069	0044	USER	USER19	R/W
D0020	40020	0013				D0070	40070	0045	USER	USER20	R/W
D0021	40021	0014				D0071	40071	0046	USER	USER21	R/W
D0022	40022	0015				D0072	40072	0047	USER	USER22	R/W
D0023	40023	0016				D0073	40073	0048	USER	USER23	R/W
D0024	40024	0017				D0074	40074	0049	USER	USER24	R/W
D0025	40025	0018				D0075	40075	004A	USER	USER25	R/W
D0026	40026	0019				D0076	40076	004B	USER	USER26	R/W
D0027	40027	001A				D0077	40077	004C	USER	USER27	R/W
D0028	40028	001B				D0078	40078	004D	USER	USER28	R/W
D0029	40029	001C				D0079	40079	004E	USER	USER29	R/W
D0030	40030	001D				D0080	40080	004F	USER	USER30	R/W
D0031	40031	001E				D0081	40081	0050	USER	USER31	R/W
D0032	40032	001F				D0082	40082	0051	USER	USER32	R/W
D0033	40033	0020				D0083	40083	0052	USER	USER33	R/W
D0034	40034	0021				D0084	40084	0053	USER	USER34	R/W
D0035	40035	0022	PARAERR	PA.ER_G	R	D0085	40085	0054	USER	USER35	R/W
D0036	40036	0023				D0086	40086	0055	USER	USER36	R/W
D0037	40037	0024				D0087	40087	0056	USER	USER37	R/W
D0038	40038	0025				D0088	40088	0057	USER	USER38	R/W
D0039	40039	0026				D0089	40089	0058	USER	USER39	R/W
D0040	40040	0027				D0090	40090	0059	USER	USER40	R/W
D0041	40041	0028				D0091	40091	005A	USER	USER41	R/W
D0042	40042	0029				D0092	40092	005B	USER	USER42	R/W
D0043	40043	002A				D0093	40093	005C	USER	USER43	R/W
D0044	40044	002B				D0094	40094	005D	USER	USER44	R/W
D0045	40045	002C				D0095	40095	005E	USER	USER45	R/W
D0046	40046	002D				D0096	40096	005F	USER	USER46	R/W
D0047	40047	002E				D0097	40097	0060	USER	USER47	R/W
D0048	40048	002F				D0098	40098	0061	USER	USER48	R/W
D0049	40049	0030				D0099	40099	0062	USER	USER49	R/W
D0050	40050	0031	USER	USER0	R/W	D0100	40100	0063	USER	USER50	R/W

10.6 GREEN Series Compatible D Registers

Configuration map for GREEN Series											
Can not be used											
D-Reg No.	Ref. No.	H No.	Register symbol for GREEN	Register symbol for UTAdvanced	R/W	D-Reg No.	Ref. No.	H No.	Register symbol for GREEN	Register symbol for UTAdvanced	R/W
D0101	40101	0064				D0151	40151	0096			
D0102	40102	0065				D0152	40152	0097			
D0103	40103	0066				D0153	40153	0098			
D0104	40104	0067				D0154	40154	0099			
D0105	40105	0068				D0155	40155	009A			
D0106	40106	0069				D0156	40156	009B			
D0107	40107	006A				D0157	40157	009C			
D0108	40108	006B				D0158	40158	009D			
D0109	40109	006C				D0159	40159	009E			
D0110	40110	006D				D0160	40160	009F			
D0111	40111	006E				D0161	40161	00A0			
D0112	40112	006F				D0162	40162	00A1			
D0113	40113	0070				D0163	40163	00A2			
D0114	40114	0071				D0164	40164	00A3			
D0115	40115	0072				D0165	40165	00A4			
D0116	40116	0073				D0166	40166	00A5			
D0117	40117	0074				D0167	40167	00A6			
D0118	40118	0075				D0168	40168	00A7			
D0119	40119	0076				D0169	40169	00A8			
D0120	40120	0077				D0170	40170	00A9			
D0121	40121	0078				D0171	40171	00AA			
D0122	40122	0079				D0172	40172	00AB			
D0123	40123	007A				D0173	40173	00AC			
D0124	40124	007B				D0174	40174	00AD			
D0125	40125	007C				D0175	40175	00AE			
D0126	40126	007D				D0176	40176	00AF			
D0127	40127	007E				D0177	40177	00B0			
D0128	40128	007F				D0178	40178	00B1			
D0129	40129	0080				D0179	40179	00B2			
D0130	40130	0081				D0180	40180	00B3			
D0131	40131	0082				D0181	40181	00B4			
D0132	40132	0083				D0182	40182	00B5			
D0133	40133	0084				D0183	40183	00B6			
D0134	40134	0085				D0184	40184	00B7			
D0135	40135	0086				D0185	40185	00B8			
D0136	40136	0087				D0186	40186	00B9			
D0137	40137	0088				D0187	40187	00BA			
D0138	40138	0089				D0188	40188	00BB			
D0139	40139	008A				D0189	40189	00BC			
D0140	40140	008B				D0190	40190	00BD			
D0141	40141	008C				D0191	40191	00BE			
D0142	40142	008D				D0192	40192	00BF			
D0143	40143	008E				D0193	40193	00C0			
D0144	40144	008F				D0194	40194	00C1			
D0145	40145	0090				D0195	40195	00C2			
D0146	40146	0091				D0196	40196	00C3			
D0147	40147	0092				D0197	40197	00C4			
D0148	40148	0093				D0198	40198	00C5			
D0149	40149	0094				D0199	40199	00C6			
D0150	40150	0095				D0200	40200	00C7			

10.6 GREEN Series Compatible D Registers

10.6.4 Operation-related Parameters (D0201 to D0300)

Configuration map for GREEN Series											
Operation-related parameters											
D-Reg No.	Ref. No.	H No.	Register symbol for GREEN	Register symbol for UTAdvanced	R/W	D-Reg No.	Ref. No.	H No.	Register symbol for GREEN	Register symbol for UTAdvanced	R/W
D0201	40201	00C8				D0251	40251	00FA	ORH		R
D0202	40202	00C9				D0252	40252	00FB	ORL		R
D0203	40203	00CA				D0253	40253	00FC			
D0204	40204	00CB				D0254	40254	00FD			
D0205	40205	00CC				D0255	40255	00FE			
D0206	40206	00CD				D0256	40256	00FF			
D0207	40207	00CE				D0257	40257	0100			
D0208	40208	00CF				D0258	40258	0101			
D0209	40209	00D0				D0259	40259	0102			
D0210	40210	00D1				D0260	40260	0103			
D0211	40211	00D2				D0261	40261	0104			
D0212	40212	00D3				D0262	40262	0105			
D0213	40213	00D4				D0263	40263	0106			
D0214	40214	00D5				D0264	40264	0107			
D0215	40215	00D6				D0265	40265	0108			
D0216	40216	00D7				D0266	40266	0109			
D0217	40217	00D8				D0267	40267	010A			
D0218	40218	00D9				D0268	40268	010B			
D0219	40219	00DA				D0269	40269	010C			
D0220	40220	00DB				D0270	40270	010D			
D0221	40221	00DC				D0271	40271	010E			
D0222	40222	00DD				D0272	40272	010F			
D0223	40223	00DE				D0273	40273	0110			
D0224	40224	00DF				D0274	40274	0111			
D0225	40225	00E0				D0275	40275	0112			
D0226	40226	00E1				D0276	40276	0113			
D0227	40227	00E2				D0277	40277	0114			
D0228	40228	00E3				D0278	40278	0115			
D0229	40229	00E4				D0279	40279	0116			
D0230	40230	00E5				D0280	40280	0117			
D0231	40231	00E6	A1	A1_L1 (D2351)	R/W	D0281	40281	0118			
D0232	40232	00E7	A2	A2_L1 (D2352)	R/W	D0282	40282	0119			
D0233	40233	00E8	A3	A3_L1 (D2353)	R/W	D0283	40283	011A			
D0234	40234	00E9	A4	A4_L1 (D2354)	R/W	D0284	40284	011B			
D0235	40235	00EA	PEAK	PEAK (D2359)	R	D0285	40285	011C			
D0236	40236	00EB	BOTM	BOTM (D2360)	R	D0286	40286	011D			
D0237	40237	00EC	PCCH (Note 1)	PCH_L1 (D5714)	R/W	D0287	40287	011E			
D0238	40238	00ED	PCCL (Note 1)	PCL_L1 (D5715)	R/W	D0288	40288	011F			
D0239	40239	00EE				D0289	40289	0120			
D0240	40240	00EF				D0290	40290	0121			
D0241	40241	00F0				D0291	40291	0122			
D0242	40242	00F1				D0292	40292	0123			
D0243	40243	00F2	BS	BS_L1 (D2901)	R/W	D0293	40293	0124			
D0244	40244	00F3	FL	FL_L1 (D2902)	R/W	D0294	40294	0125			
D0245	40245	00F4				D0295	40295	0126			
D0246	40246	00F5				D0296	40296	0127			
D0247	40247	00F6				D0297	40297	0128			
D0248	40248	00F7				D0298	40298	0129			
D0249	40249	00F8				D0299	40299	012A			
D0250	40250	00F9	ORB		R	D0300	40300	012B			

Note 1: Parameters PCCH and PCCL are used for UM351/UM331 only.

D0301 to D0900: Free area

10.6.5 Alarm Function Parameters (D0901 to D1000)

Configuration map for GREEN Series											
Alarm function parameters											
D-Reg No.	Ref. No.	H No.	Register symbol for GREEN	Register symbol for UTAdvanced	R/W	D-Reg No.	Ref. No.	H No.	Register symbol for GREEN	Register symbol for UTAdvanced	R/W
D0901	40901	0384				D0951	40951	03B6			
D0902	40902	0385				D0952	40952	03B7			
D0903	40903	0386				D0953	40953	03B8			
D0904	40904	0387				D0954	40954	03B9			
D0905	40905	0388				D0955	40955	03BA			
D0906	40906	0389				D0956	40956	03BB			
D0907	40907	038A				D0957	40957	03BC			
D0908	40908	038B				D0958	40958	03BD			
D0909	40909	038C				D0959	40959	03BE			
D0910	40910	038D				D0960	40960	03BF			
D0911	40911	038E				D0961	40961	03C0			
D0912	40912	038F				D0962	40962	03C1			
D0913	40913	0390				D0963	40963	03C2			
D0914	40914	0391				D0964	40964	03C3			
D0915	40915	0392	AL1	AL1.T_L1 (D2801)	R/W	D0965	40965	03C4			
D0916	40916	0393	AL2	AL2.T_L1 (D2805)	R/W	D0966	40966	03C5			
D0917	40917	0394	AL3	AL3.T_L1 (D2809)	R/W	D0967	40967	03C6			
D0918	40918	0395	AL4	AL4.T_L1 (D2813)	R/W	D0968	40968	03C7			
D0919	40919	0396	HY1	HY1_L1 (D2841)	R/W	D0969	40969	03C8			
D0920	40920	0397	HY2	HY2_L1 (D2842)	R/W	D0970	40970	03C9			
D0921	40921	0398	HY3	HY3_L1 (D2843)	R/W	D0971	40971	03CA			
D0922	40922	0399	HY4	HY4_L1 (D2844)	R/W	D0972	40972	03CB			
D0923	40923	039A				D0973	40973	03CC			
D0924	40924	039B				D0974	40974	03CD			
D0925	40925	039C				D0975	40975	03CE			
D0926	40926	039D				D0976	40976	03CF			
D0927	40927	039E				D0977	40977	03D0			
D0928	40928	039F				D0978	40978	03D1			
D0929	40929	03A0				D0979	40979	03D2			
D0930	40930	03A1				D0980	40980	03D3			
D0931	40931	03A2				D0981	40981	03D4			
D0932	40932	03A3	DIS		R/W	D0982	40982	03D5			
D0933	40933	03A4				D0983	40983	03D6			
D0934	40934	03A5				D0984	40984	03D7			
D0935	40935	03A6	DY1	DYN1_L1 (D2849)	R/W	D0985	40985	03D8			
D0936	40936	03A7	DY2	DYN2_L1 (D2850)	R/W	D0986	40986	03D9			
D0937	40937	03A8	DY3	DYN3_L1 (D2851)	R/W	D0987	40987	03DA			
D0938	40938	03A9	DY4	DYN4_L1 (D2852)	R/W	D0988	40988	03DB			
D0939	40939	03AA				D0989	40989	03DC			
D0940	40940	03AB				D0990	40990	03DD			
D0941	40941	03AC				D0991	40991	03DE			
D0942	40942	03AD				D0992	40992	03DF			
D0943	40943	03AE				D0993	40993	03E0			
D0944	40944	03AF				D0994	40994	03E1			
D0945	40945	03B0				D0995	40995	03E2			
D0946	40946	03B1				D0996	40996	03E3			
D0947	40947	03B2				D0997	40997	03E4			
D0948	40948	03B3				D0998	40998	03E5			
D0949	40949	03B4				D0999	40999	03E6			
D0950	40950	03B5				D1000	41000	03E7			

10.6 GREEN Series Compatible D Registers

10.6.6 Common Function Parameters (D1001 to D1100)

Configuration map for GREEN Series											
Common function parameters											
D-Reg No.	Ref. No.	H No.	Register symbol for GREEN	Register symbol for UTAdvanced	R/W	D-Reg No.	Ref. No.	H No.	Register symbol for GREEN	Register symbol for UTAdvanced	R/W
D1001	41001	03E8				D1051	41051	041A			
D1002	41002	03E9				D1052	41052	041B			
D1003	41003	03EA				D1053	41053	041C			
D1004	41004	03EB				D1054	41054	041D			
D1005	41005	03EC				D1055	41055	041E			
D1006	41006	03ED				D1056	41056	041F			
D1007	41007	03EE				D1057	41057	0420			
D1008	41008	03EF				D1058	41058	0421			
D1009	41009	03F0				D1059	41059	0422			
D1010	41010	03F1				D1060	41060	0423			
D1011	41011	03F2				D1061	41061	0424			
D1012	41012	03F3				D1062	41062	0425			
D1013	41013	03F4	RET	RTS (D5321)	R/W	D1063	41063	0426			
D1014	41014	03F5	RTH	RTH (D5322)	R/W	D1064	41064	0427			
D1015	41015	03F6	RTL	RTL (D5323)	R/W	D1065	41065	0428			
D1016	41016	03F7				D1066	41066	0429			
D1017	41017	03F8				D1067	41067	042A			
D1018	41018	03F9				D1068	41068	042B			
D1019	41019	03FA				D1069	41069	042C			
D1020	41020	03FB				D1070	41070	042D			
D1021	41021	03FC				D1071	41071	042E			
D1022	41022	03FD				D1072	41072	042F			
D1023	41023	03FE				D1073	41073	0430			
D1024	41024	03FF				D1074	41074	0431			
D1025	41025	0400				D1075	41075	0432			
D1026	41026	0401				D1076	41076	0433			
D1027	41027	0402				D1077	41077	0434			
D1028	41028	0403				D1078	41078	0435			
D1029	41029	0404				D1079	41079	0436			
D1030	41030	0405				D1080	41080	0437			
D1031	41031	0406				D1081	41081	0438			
D1032	41032	0407				D1082	41082	0439			
D1033	41033	0408				D1083	41083	043A			
D1034	41034	0409				D1084	41084	043B			
D1035	41035	040A				D1085	41085	043C			
D1036	41036	040B	LOCK		R	D1086	41086	043D			
D1037	41037	040C	PCMD (Note)	PCMD_L1 (D5713)	R/W	D1087	41087	043E			
D1038	41038	040D	ERJC (Note)	ERJC (D5111)	R/W	D1088	41088	043F			
D1039	41039	040E				D1089	41089	0440			
D1040	41040	040F				D1090	41090	0441			
D1041	41041	0410				D1091	41091	0442			
D1042	41042	0411				D1092	41092	0443			
D1043	41043	0412				D1093	41093	0444			
D1044	41044	0413				D1094	41094	0445			
D1045	41045	0414				D1095	41095	0446			
D1046	41046	0415				D1096	41096	0447			
D1047	41047	0416				D1097	41097	0448			
D1048	41048	0417				D1098	41098	0449			
D1049	41049	0418				D1099	41099	044A			
D1050	41050	0419				D1100	41100	044B			

Note: Only for UM351/UM331.

10.6.7 SELECT Display Setting Parameters (D1101 to D1200)

Configuration map for GREEN Series											
SELECT display setting parameters											
D-Reg No.	Ref. No.	H No.	Register symbol for GREEN	Register symbol for UTAdvanced	R/W	D-Reg No.	Ref. No.	H No.	Register symbol for GREEN	Register symbol for UTAdvanced	R/W
D1101	41101	044C	C.S1		R	D1151	41151	047E			
D1102	41102	044D	C.S2		R	D1152	41152	047F			
D1103	41103	044E	C.S3		R	D1153	41153	0480			
D1104	41104	044F	C.S4		R	D1154	41154	0481			
D1105	41105	0450				D1155	41155	0482			
D1106	41106	0451				D1156	41156	0483			
D1107	41107	0452				D1157	41157	0484			
D1108	41108	0453				D1158	41158	0485			
D1109	41109	0454				D1159	41159	0486			
D1110	41110	0455				D1160	41160	0487			
D1111	41111	0456				D1161	41161	0488			
D1112	41112	0457				D1162	41162	0489			
D1113	41113	0458				D1163	41163	048A			
D1114	41114	0459				D1164	41164	048B			
D1115	41115	045A				D1165	41165	048C			
D1116	41116	045B				D1166	41166	048D			
D1117	41117	045C				D1167	41167	048E			
D1118	41118	045D				D1168	41168	048F			
D1119	41119	045E				D1169	41169	0490			
D1120	41120	045F				D1170	41170	0491			
D1121	41121	0460				D1171	41171	0492			
D1122	41122	0461				D1172	41172	0493			
D1123	41123	0462				D1173	41173	0494			
D1124	41124	0463				D1174	41174	0495			
D1125	41125	0464				D1175	41175	0496			
D1126	41126	0465				D1176	41176	0497			
D1127	41127	0466				D1177	41177	0498			
D1128	41128	0467				D1178	41178	0499			
D1129	41129	0468				D1179	41179	049A			
D1130	41130	0469				D1180	41180	049B			
D1131	41131	046A				D1181	41181	049C			
D1132	41132	046B				D1182	41182	049D			
D1133	41133	046C				D1183	41183	049E			
D1134	41134	046D				D1184	41184	049F			
D1135	41135	046E				D1185	41185	04A0			
D1136	41136	046F				D1186	41186	04A1			
D1137	41137	0470				D1187	41187	04A2			
D1138	41138	0471				D1188	41188	04A3			
D1139	41139	0472				D1189	41189	04A4			
D1140	41140	0473				D1190	41190	04A5			
D1141	41141	0474				D1191	41191	04A6			
D1142	41142	0475				D1192	41192	04A7			
D1143	41143	0476				D1193	41193	04A8			
D1144	41144	0477				D1194	41194	04A9			
D1145	41145	0478				D1195	41195	04AA			
D1146	41146	0479				D1196	41196	04AB			
D1147	41147	047A				D1197	41197	04AC			
D1148	41148	047B				D1198	41198	04AD			
D1149	41149	047C				D1199	41199	04AE			
D1150	41150	047D				D1200	41200	04AF			

10.6 GREEN Series Compatible D Registers

10.6.8 PV Input, and Communication Parameters (D1201 to D1300)

Configuration map for GREEN Series											
PV input, and Communication parameters											
D-Reg No.	Ref. No.	H No.	Register symbol for GREEN	Register symbol for UTAdvanced	R/W	D-Reg No.	Ref. No.	H No.	Register symbol for GREEN	Register symbol for UTAdvanced	R/W
D1201	41201	04B0	IN	IN (D5101)	R/W	D1251	41251	04E2	DLN	DLN_E1 (D5505)	R/W
D1202	41202	04B1	UNI	UNI (D5102)	R/W	D1252	41252	04E3	ADR	ADR_E1 (D5506)	R/W
D1203	41203	04B2				D1253	41253	04E4	RP.T	RP.T_E1 (D5507)	R/W
D1204	41204	04B3	RH	RH (D5104)	R/W	D1254	41254	04E5			
D1205	41205	04B4	RL	RL (D5105)	R/W	D1255	41255	04E6			
D1206	41206	04B5	SDP	SDP (D5106)	R/W	D1256	41256	04E7			
D1207	41207	04B6	SH	SH (D5107)	R/W	D1257	41257	04E8			
D1208	41208	04B7	SL	SL (D5108)	R/W	D1258	41258	04E9			
D1209	41209	04B8	BSL	BSL (D5109)	R/W	D1259	41259	04EA			
D1210	41210	04B9	RJC	RJC (D5110)	R/W	D1260	41260	04EB			
D1211	41211	04BA				D1261	41261	04EC			
D1212	41212	04BB				D1262	41262	04ED			
D1213	41213	04BC				D1263	41263	04EE			
D1214	41214	04BD				D1264	41264	04EF			
D1215	41215	04BE				D1265	41265	04F0			
D1216	41216	04BF				D1266	41266	04F1			
D1217	41217	04C0				D1267	41267	04F2			
D1218	41218	04C1				D1268	41268	04F3			
D1219	41219	04C2				D1269	41269	04F4			
D1220	41220	04C3				D1270	41270	04F5			
D1221	41221	04C4				D1271	41271	04F6			
D1222	41222	04C5				D1272	41272	04F7			
D1223	41223	04C6				D1273	41273	04F8			
D1224	41224	04C7				D1274	41274	04F9			
D1225	41225	04C8				D1275	41275	04FA			
D1226	41226	04C9				D1276	41276	04FB			
D1227	41227	04CA				D1277	41277	04FC			
D1228	41228	04CB				D1278	41278	04FD			
D1229	41229	04CC				D1279	41279	04FE			
D1230	41230	04CD				D1280	41280	04FF			
D1231	41231	04CE				D1281	41281	0500			
D1232	41232	04CF				D1282	41282	0501			
D1233	41233	04D0				D1283	41283	0502			
D1234	41234	04D1				D1284	41284	0503			
D1235	41235	04D2				D1285	41285	0504			
D1236	41236	04D3				D1286	41286	0505			
D1237	41237	04D4				D1287	41287	0506			
D1238	41238	04D5				D1288	41288	0507			
D1239	41239	04D6				D1289	41289	0508			
D1240	41240	04D7				D1290	41290	0509			
D1241	41241	04D8				D1291	41291	050A			
D1242	41242	04D9				D1292	41292	050B			
D1243	41243	04DA				D1293	41293	050C			
D1244	41244	04DB				D1294	41294	050D			
D1245	41245	04DC				D1295	41295	050E			
D1246	41246	04DD				D1296	41296	050F			
D1247	41247	04DE	PSL	PSL_E1 (D5501)	R/W	D1297	41297	0510			
D1248	41248	04DF	BPS	BPS_E1 (D5502)	R/W	D1298	41298	0511			
D1249	41249	04E0	PRI	PRI_E1 (D5503)	R/W	D1299	41299	0512			
D1250	41250	04E1	STP	STP_E1 (D5504)	R/W	D1300	41300	0513			

D1301 to D2000: Free area

10.6.9 D Registers Converted for GREEN Series

● Bit Configuration of D0001: AD1.E_G (A/D converter error status for GREEN Series)

Bit	Symbol		Event
	GREEN Series	UTAdvanced	
0	ADERR.st	ADERR (I4065)	PV input A/D converter error
1 to 15			

● Bit Configuration of D0002: PV1.E_L1_G (PV input error status for GREEN Series)

Bit	Symbol		Event
	GREEN Series	UTAdvanced	
0			
1	PVBO.st	PVBO_L1 (I4097)	PV input burnout error
2	RJCERR.st	RJCERR (I4070)	PV input RJC error
3			
4	PV+over.st	PVPOV_L1 (I4101)	PV input over-scale
5	PV-over.st	PVMOV_L1 (I4102)	PV input under-scale
6 to 15			

● Bit Configuration of D0011: ALM_G (Alarm status for GREEN Series)

Bit	Symbol		Event
	GREEN Series	UTAdvanced	
0	ALM1.st	ALM1_L1 (I4321)	'1' when alarm 1 is ON; '0' when OFF
1	ALM2.st	ALM2_L1 (I4322)	'1' when alarm 2 is ON; '0' when OFF
2	ALM3.st	ALM3_L1 (I4323)	'1' when alarm 3 is ON; '0' when OFF
3			
4	ALM4.st	ALM4_L1 (I4325)	'1' when alarm 4 is ON; '0' when OFF
5 to 15			

● Bit Configuration of D0035: PA.ER_G (Parameter error status for GREEN Series)

Bit	Symbol		Event
	GREEN Series	UTAdvanced	
0	CALB.E.st	CALB_ERR (I4002)	Calibration value error
1 to 5			
6	SETUP.st	SETPA_ERR (I4005)	Setup parameter error
7			
8	PARA.E.st	OPEPA_ERR (I4006)	Operation parameter error
9	MODE.E.st	CTLPA_ERR (I4011)	Control parameter error
10 to 11			
12	EEPE.st	FRAM_ERR (I4009)	Faulty FRAM
13			
14	SYSTEM.E.st	SYSTEM_ERR (I4001)	System data error
15			

10.6 GREEN Series Compatible D Registers

10.6.10 D Registers Differing in Content from GREEN Series

● D0915 to D0917: Alarm-1 type to alarm-4 type

UTAdvanced

Register No.	Description		Range and meaning of value
D0915	AL1.T_L1	Alarm-1 type	0: Disable 01: PV high limit 02: PV low limit 29: PV velocity 30: Fault diagnosis 31: FAIL
D0916	AL2.T_L1	Alarm-2 type	
D0917	AL3.T_L1	Alarm-3 type	
D0918	AL4.T_L1	Alarm-4 type	

GREEN Series

Register No.	Description		Range and meaning of value
D0915	AL1	Alarm-1 type	OFF (0) 1: PV high limit (energized, no stand-by action) 2: PV low limit (energized, no stand-by action) 9: PV high limit (de-energized, no stand-by action) 10: PV low limit (de-energized, no stand-by action) 11: PV high limit (energized, stand-by action) 12: PV low limit (energized, stand-by action) 19: PV high limit (de-energized, stand-by action) 20: PV low limit (de-energized, stand-by action) 21: Fault diagnosis output Turns on in case of input burnout, A/D converter failure, or reference junction compensation (RJC) failure. 22: FAIL output Turns off in case of program failure, ROM failure, RAM failure, or power failure. This output is on during normal operation. If it turns off, the retransmission output is set to 0%, the alarm output is set to OFF, and the indicator stops.
D0916	AL2	Alarm-2 type	
D0917	AL3	Alarm-3 type	
D0918	AL4	Alarm-4 type	

11.1 Overview

This chapter describes the functions and applications of the I relays.

I relays are used in Modbus communication, PC link communication, and contact input / output functions.

I relays contain status information of errors, operation, and alarms. Contents of I relays can be read only by means of communication using a host computer. (Note that the I relays have the same information as the D registers but with I relays, some of the information is read-only.)

- ▶ [Contact input and output functions: Chapter 11 Contact Input and Output Functions of the UTAdvanced User's Manual](#)

Use of the I relays enables the following:

- Centralized control by the host computer

D registers and I relays on the UTAdvanced are used for parameter settings or ladder program creations of LL50A Parameter Setting Software.

11.2 Classification of I Relays

I relays are classified as shown below.

Classification of I Relay Map

I relay No.	Area and data categories	Description	
1 to 192	GREEN series	Status	Each bit information is the same as that of D register.
193 to 640	(See 11.5 I Relays Corresponding to GREEN Series)	Free area	
641 to 720		Status	Each bit information is the same as that of D register.
721 to 784		User area	
785 to 4000		Free area	
4001 to 4064	Function status	System error	Each bit information is the same as that of D register.
4065 to 4128		Input error	Each bit information is the same as that of D register.
4129 to 4192		Free area	
4193 to 4256		FAIL alarm	See the section 11.3.1.
4257 to 4320		Free area	
4321 to 4384		Alarm	Each bit information is the same as that of D register.
4385 to 4528		Alarm latch	Each bit information of 4385 to 4512 is the same as that of D register. For 4513 to 4528, see the section 11.3.1.
4529 to 4704		Free area	
4705 to 4768		Key	Each bit information is the same as that of D register.
4769 to 4832		Display	Each bit information is the same as that of D register.
4833 to 5024		Free area	
5025 to 5152		Input / Output status	Input (status) relay
5153 to 5280	Output (status) relay		Each bit information is the same as that of D register.
5281 to 5536	Free area		
5537 to 5472	Special status	Special relay	See the section 11.3.3.
5473 to 6304	Free area		
6305 to 6432	Input / Output terminal status	DI terminal	Each bit information is the same as that of D register.
6433 to 6560		DO terminal	Each bit information is the same as that of D register.
6561 to 7072		Free area	

CAUTION

- Check the model and suffix codes and parameter settings before writing to or read from the registers to be used.
 - In the area for I relay numbers 4001 to 6560, it is prohibited to write data to I relays with blank cells in I relay map tables. If you attempt to do so, the UTAdvanced may not operate properly.
-

Note

- I relay numbers 4001 to 6560 store ON/OFF status information and are normally read for ON/OFF status information.
-

■ How to Specify I Relay Numbers

When specifying an I relay number for communication, begin the number with the character "I."

Example: Set "I4065" to specify the ADERR (I relay No.: 4065).

■ I relay symbol

- With regards to some register symbols, the loop number and terminal area are indicated by adding the underline () to the end of the parameter symbols.

Note

Since the UM33A is a single-loop controller, it has no distinction between Loop-1 and Loop-2. However, the register symbol has "L1" which indicates Loop-1.

□□□□_L1	L1: Loop numbers
□□□□_E1	E1: Terminal area (E1)

Example : **PVBO_L1** Indicates PVBO.
ADERR_E1 Indicates ADERR in E1-terminal area.

11.3 UM33A I Relays

11.3.1 Function Status (4001 to 5024)

Note

When specifying an I relay number for communication, begin the number with the character "I."
Example: Set "I4065" to specify the ADERR (I relay No.: 4065).

System error			Input error			Free area		
NO.	I relay symbol	R/W	NO.	I relay symbol	R/W	NO.	I relay symbol	R/W
4001	SYSTEM_ERR	R	4065	ADERR	R	4129		
4002	CALB_ERR	R	4066			4130		
4003	UPARA_ERR	R	4067			4131		
4004			4068			4132		
4005	SETPA_ERR	R	4069			4133		
4006	OPEPA_ERR	R	4070	RJCERR	R	4134		
4007			4071			4135		
4008			4072			4136		
4009	FRAM_ERR	R	4073	ADBO	R	4137		
4010			4074			4138		
4011	CTLPA_ERR	R	4075			4139		
4012			4076			4140		
4013			4077			4141		
4014			4078			4142		
4015			4079			4143		
4016			4080			4144		
4017			4081			4145		
4018			4082			4146		
4019			4083			4147		
4020			4084			4148		
4021			4085			4149		
4022			4086			4150		
4023			4087			4151		
4024			4088			4152		
4025			4089			4153		
4026			4090			4154		
4027			4091			4155		
4028			4092			4156		
4029			4093			4157		
4030			4094			4158		
4031			4095			4159		
4032			4096			4160		
4033	E1_ERR	R	4097	PVBO_L1	R	4161		
4034			4098			4162		
4035			4099			4163		
4036			4100			4164		
4037			4101	PVPOVER_L1	R	4165		
4038			4102	PVMOVER_L1	R	4166		
4039			4103			4167		
4040			4104			4168		
4041	COM_E1_ERR	R	4105			4169		
4042			4106			4170		
4043			4107			4171		
4044			4108			4172		
4045			4109			4173		
4046			4110			4174		
4047			4111			4175		
4048			4112			4176		
4049			4113			4177		
4050			4114			4178		
4051			4115			4179		
4052			4116			4180		
4053			4117			4181		
4054			4118			4182		
4055			4119			4183		
4056			4120			4184		
4057			4121			4185		
4058			4122			4186		
4059			4123			4187		
4060			4124			4188		
4061			4125			4189		
4062			4126			4190		
4063			4127			4191		
4064			4128			4192		

11.3 UM33A I Relays

FAIL alarm			Free area		
NO.	I relay symbol	R/W	NO.	I relay symbol	R/W
4193			4257		
4194			4258		
4195			4259		
4196			4260		
4197			4261		
4198			4262		
4199			4263		
4200			4264		
4201			4265		
4202			4266		
4203			4267		
4204			4268		
4205			4269		
4206			4270		
4207			4271		
4208			4272		
4209			4273		
4210			4274		
4211			4275		
4212			4276		
4213			4277		
4214			4278		
4215			4279		
4216			4280		
4217			4281		
4218			4282		
4219			4283		
4220			4284		
4221			4285		
4222			4286		
4223			4287		
4224			4288		
4225			4289		
4226			4290		
4227			4291		
4228			4292		
4229			4293		
4230			4294		
4231			4295		
4232			4296		
4233			4297		
4234			4298		
4235			4299		
4236			4300		
4237			4301		
4238			4302		
4239			4303		
4240			4304		
4241			4305		
4242			4306		
4243			4307		
4244			4308		
4245			4309		
4246			4310		
4247			4311		
4248			4312		
4249			4313		
4250			4314		
4251			4315		
4252			4316		
4253			4317		
4254			4318		
4255			4319		
4256	FAIL_ALARM	R	4320		

Alarm			Alarm latch			Alarm latch		
NO.	I relay symbol	R/W	NO.	I relay symbol	R/W	NO.	I relay symbol	R/W
4321	ALM1_L1	R	4385	ALO1LA1_L1	R	4449	ALO1LA3_L1	R
4322	ALM2_L1	R	4386	ALO2LA1_L1	R	4450	ALO2LA3_L1	R
4323	ALM3_L1	R	4387	ALO3LA1_L1	R	4451	ALO3LA3_L1	R
4324			4388			4452		
4325	ALM4_L1	R	4389	ALO4LA1_L1	R	4453	ALO4LA3_L1	R
4326	ALM5_L1	R	4390	ALO5LA1_L1	R	4454	ALO5LA3_L1	R
4327	ALM6_L1	R	4391	ALO6LA1_L1	R	4455	ALO6LA3_L1	R
4328			4392			4456		
4329	ALM7_L1	R	4393	ALO7LA1_L1	R	4457	ALO7LA3_L1	R
4330	ALM8_L1	R	4394	ALO8LA1_L1	R	4458	ALO8LA3_L1	R
4331			4395			4459		
4332			4396			4460		
4333			4397			4461		
4334			4398			4462		
4335			4399			4463		
4336			4400			4464		
4337			4401			4465		
4338			4402			4466		
4339			4403			4467		
4340			4404			4468		
4341			4405			4469		
4342			4406			4470		
4343			4407			4471		
4344			4408			4472		
4345			4409			4473		
4346			4410			4474		
4347			4411			4475		
4348			4412			4476		
4349			4413			4477		
4350			4414			4478		
4351			4415			4479		
4352			4416			4480		
4353	ALO1_L1	R	4417	ALO1LA2_L1	R	4481	ALO1LA4_L1	R
4354	ALO2_L1	R	4418	ALO2LA2_L1	R	4482	ALO2LA4_L1	R
4355	ALO3_L1	R	4419	ALO3LA2_L1	R	4483	ALO3LA4_L1	R
4356			4420			4484		
4357	ALO4_L1	R	4421	ALO4LA2_L1	R	4485	ALO4LA4_L1	R
4358	ALO5_L1	R	4422	ALO5LA2_L1	R	4486	ALO5LA4_L1	R
4359	ALO6_L1	R	4423	ALO6LA2_L1	R	4487	ALO6LA4_L1	R
4360			4424			4488		
4361	ALO7_L1	R	4425	ALO7LA2_L1	R	4489	ALO7LA4_L1	R
4362	ALO8_L1	R	4426	ALO8LA2_L1	R	4490	ALO8LA4_L1	R
4363			4427			4491		
4364			4428			4492		
4365			4429			4493		
4366			4430			4494		
4367			4431			4495		
4368			4432			4496		
4369			4433			4497		
4370			4434			4498		
4371			4435			4499		
4372			4436			4500		
4373			4437			4501		
4374			4438			4502		
4375			4439			4503		
4376			4440			4504		
4377			4441			4505		
4378			4442			4506		
4379			4443			4507		
4380			4444			4508		
4381			4445			4509		
4382			4446			4510		
4383			4447			4511		
4384			4448			4512		

11.3 UM33A I Relays

Alarm latch			Free area			Free area		
NO.	I relay symbol	R/W	NO.	I relay symbol	R/W	NO.	I relay symbol	R/W
4513	ALOLA_RLS	R/W	4577			4641		
4514	ALM_WAIT	R/W	4578			4642		
4515			4579			4643		
4516			4580			4644		
4517			4581			4645		
4518			4582			4646		
4519			4583			4647		
4520			4584			4648		
4521			4585			4649		
4522			4586			4650		
4523			4587			4651		
4524			4588			4652		
4525			4589			4653		
4526			4590			4654		
4527			4591			4655		
4528			4592			4656		
4529			4593			4657		
4530			4594			4658		
4531			4595			4659		
4532			4596			4660		
4533			4597			4661		
4534			4598			4662		
4535			4599			4663		
4536			4600			4664		
4537			4601			4665		
4538			4602			4666		
4539			4603			4667		
4540			4604			4668		
4541			4605			4669		
4542			4606			4670		
4543			4607			4671		
4544			4608			4672		
4545			4609			4673		
4546			4610			4674		
4547			4611			4675		
4548			4612			4676		
4549			4613			4677		
4550			4614			4678		
4551			4615			4679		
4552			4616			4680		
4553			4617			4681		
4554			4618			4682		
4555			4619			4683		
4556			4620			4684		
4557			4621			4685		
4558			4622			4686		
4559			4623			4687		
4560			4624			4688		
4561			4625			4689		
4562			4626			4690		
4563			4627			4691		
4564			4628			4692		
4565			4629			4693		
4566			4630			4694		
4567			4631			4695		
4568			4632			4696		
4569			4633			4697		
4570			4634			4698		
4571			4635			4699		
4572			4636			4700		
4573			4637			4701		
4574			4638			4702		
4575			4639			4703		
4576			4640			4704		

Key			Display		
NO.	I relay symbol	R/W	NO.	I relay symbol	R/W
4705	PARA_KEY	R	4769	MG1.B	R
4706	DISP_KEY	R	4770	MG2.B	R
4707	RIGHT_KEY	R	4771	MG3.B	R
4708	DOWN_KEY	R	4772		
4709	SET_KEY	R	4773	MG4.B	R
4710	UP_KEY	R	4774		
4711	LEFT_KEY	R	4775		
4712			4776		
4713			4777		
4714			4778		
4715	FN_KEY	R	4779	PVRW_L1	R
4716			4780		
4717			4781		
4718			4782		
4719			4783		
4720			4784		
4721			4785		
4722			4786		
4723			4787		
4724			4788		
4725			4789		
4726			4790		
4727			4791		
4728			4792		
4729			4793		
4730			4794		
4731			4795		
4732			4796		
4733			4797		
4734			4798		
4735			4799		
4736			4800		
4737			4801		
4738			4802		
4739			4803		
4740			4804		
4741			4805		
4742			4806		
4743			4807		
4744			4808		
4745			4809		
4746			4810		
4747			4811		
4748			4812		
4749			4813		
4750			4814		
4751			4815		
4752			4816		
4753			4817		
4754			4818		
4755			4819		
4756			4820		
4757			4821		
4758			4822		
4759			4823		
4760			4824		
4761			4825		
4762			4826		
4763			4827		
4764			4828		
4765			4829		
4766			4830		
4767			4831		
4768			4832		

4833 to 5024: Free area

11.3 UM33A I Relays

System Error, Input Error, and Operation Mode (4001 to 4320)

I relay No.	Symbol	Event	
4001 to 4016	SYSTEM_ERR to CTLPA_ERR	Parameter error status (Same as D2068)	
4017 to 4032			
4033 to 4048	E1_ERR to COM_E1_ERR	Option error status (Same as D2070)	
4049 to 4064			
4065 to 4080	ADERR to ADBO	A/D converter error status 1 (Same as D2001)	
4081 to 4096			
4097 to 4112	PVBO_L1 to ATERR_L1	PV input error status (Same as D2002)	
4113 to 4128			
4129 to 4192	Free Area		
4193 to 4255			
4256	FAIL_ALARM	FAIL alarm status	0: FAIL alarm 1: OFF (Normal)
4257 to 4320	Free area		

Alarm, Alarm Latch (4321 to 4576)

I relay No.	Symbol	Event	
4321 to 4336	ALM1_L1~ALM8_L1	Alarm-1 to alarm-8 status (Same as D2011)	
4337 to 4352			
4353 to 4368	ALO1_L1 to ALO8_L1	Alarm-1 to alarm-8 output status (Same as D2037)	
4369 to 4384			
4385 to 4400	ALO1LA1_L1 to ALO8LA1_L1	Alarm-1 to alarm-8 latch output status (Same as D2071)	
4401 to 4416			
4417 to 4432	ALO1LA2_L1 to ALO8LA2_L1	Alarm-1 to alarm-8 latch-2 output status (Same as D2073)	
4433 to 4448			
4449 to 4464	ALO1LA3_L1 to ALO8LA3_L1	Alarm-1 to alarm-8 latch-3 output status (Same as D2075)	
4465 to 4480			
4481 to 4496	ALO1LA4_L1 to ALO8LA4_L1	Alarm-1 to alarm-8 latch-4 output status (Same as D2077)	
4497 to 4512			
4513	ALOLA_RLS	Alarm latch release flag	0: OFF 1: Latch release Automatically returned to "0".
4514	ALM_WAIT	Forced stand-by alarm flag	0: OFF 1: Forced stand-by Automatically returned to "0".
4529 to 4576			

Key (4705 to 4768)

I relay No.	Symbol	Event	
4705 to 4720	PARA_KEY to FN_KEY	Key status (Same as D6301)	
4721 to 4768			

Display (4769 to 4832)

I relay No.	Symbol	Event	
4769 to 4773	MG1.B to MG4.B	Message display interruption status (Same as D2066)	
4779	PVRW_L1	PV red/white switch	0: White color 1: Red color
4785 to 4832			

11.3.2 Input / Output Status (5025 to 5472)

Note

When specifying an I relay number for communication, begin the number with the character "I."
Example: Set "I5025" to specify the X_D11 (I relay No.: 5025).

11.3 UM33A I Relays

Input (status) relay			Input (status) relay		
NO.	I relay symbol	R/W	NO.	I relay symbol	R/W
5025	X_DI1	R	5089		
5026	X_DI2	R	5090		
5027			5091		
5028			5092		
5029			5093		
5030			5094		
5031			5095		
5032			5096		
5033			5097		
5034			5098		
5035			5099		
5036			5100		
5037			5101		
5038			5102		
5039			5103		
5040			5104		
5041			5105		
5042			5106		
5043			5107		
5044			5108		
5045			5109		
5046			5110		
5047			5111		
5048			5112		
5049			5113		
5050			5114		
5051			5115		
5052			5116		
5053			5117		
5054			5118		
5055			5119		
5056			5120		
5057			5121		
5058			5122		
5059			5123		
5060			5124		
5061			5125		
5062			5126		
5063			5127		
5064			5128		
5065			5129		
5066			5130		
5067			5131		
5068			5132		
5069			5133		
5070			5134		
5071			5135		
5072			5136		
5073			5137		
5074			5138		
5075			5139		
5076			5140		
5077			5141		
5078			5142		
5079			5143		
5080			5144		
5081			5145		
5082			5146		
5083			5147		
5084			5148		
5085			5149		
5086			5150		
5087			5151		
5088			5152		

Output (status) relay			Output (status) relay		
NO.	I relay symbol	R/W	NO.	I relay symbol	R/W
5153	Y_AL1	R/W	5217		
5154	Y_AL2	R/W	5218		
5155	Y_AL3	R/W	5219		
5156			5220		
5157			5221		
5158			5222		
5159			5223		
5160			5224		
5161			5225		
5162			5226		
5163			5227		
5164			5228		
5165			5229		
5166			5230		
5167			5231		
5168			5232		
5169	Y_DO11	R/W	5233		
5170	Y_DO12	R/W	5234		
5171	Y_DO13	R/W	5235		
5172	Y_DO14	R/W	5236		
5173	Y_DO15	R/W	5237		
5174			5238		
5175			5239		
5176			5240		
5177			5241		
5178			5242		
5179			5243		
5180			5244		
5181			5245		
5182			5246		
5183			5247		
5184			5248		
5185			5249		
5186			5250		
5187			5251		
5188			5252		
5189			5253		
5190			5254		
5191			5255		
5192			5256		
5193			5257		
5194			5258		
5195			5259		
5196			5260		
5197			5261		
5198			5262		
5199			5263		
5200			5264		
5201			5265		
5202			5266		
5203			5267		
5204			5268		
5205			5269		
5206			5270		
5207			5271		
5208			5272		
5209			5273		
5210			5274		
5211			5275		
5212			5276		
5213			5277		
5214			5278		
5215			5279		
5216			5280		

5281 to 5536: Free area

11.3 UM33A I Relays

Input (Status) Relay and Output (Status) Relay (5025 to 5280)

I relay No.	Symbol	Description
5025 to 5040	X_DI1 to X_DI2	DI1-DI2 status (Same as D7011)
5041 to 5152		
5153 to 5168	Y_AL1 to Y_AL3	AL1-AL3 status (Same as D7161)
5169 to 5184	Y_DO11 to Y_DO15	DO11-DO15 status (Same sa D7162)
5185 to 5280		

11.3.3 Special Relay (5537 to 5792)

Note

When specifying an I relay number for communication, begin the number with the character "I."
Example: Set "I5537" to specify the DI1 (I relay No.: 5537).

11.3 UM33A I Relays

Special relay			Special relay		
NO.	I relay symbol	R/W	NO.	I relay symbol	R/W
5537	M01	R/W	5601		
5538	M02	R/W	5602		
5539	M03	R/W	5603		
5540	M04	R/W	5604		
5541	M05	R/W	5605		
5542	M06	R/W	5606		
5543	M07	R/W	5607		
5544	M08	R/W	5608		
5545	M09	R/W	5609		
5546	M10	R/W	5610		
5547	M11	R/W	5611		
5548	M12	R/W	5612		
5549	M13	R/W	5613		
5550	M14	R/W	5614		
5551	M15	R/W	5615		
5552	M16	R/W	5616		
5553			5617		
5554			5618		
5555			5619		
5556			5620		
5557			5621		
5558			5622		
5559			5623		
5560			5624		
5561			5625		
5562			5626		
5563			5627		
5564			5628		
5565			5629		
5566			5630		
5567			5631		
5568			5632		
5569			5633		
5570			5634		
5571			5635		
5572			5636		
5573			5637		
5574			5638		
5575			5639		
5576			5640		
5577			5641		
5578			5642		
5579			5643		
5580			5644		
5581			5645		
5582			5646		
5583			5647		
5584			5648		
5585			5649		
5586			5650		
5587			5651		
5588			5652		
5589			5653		
5590			5654		
5591			5655		
5592			5656		
5593			5657		
5594			5658		
5595			5659		
5596			5660		
5597			5661		
5598			5662		
5599			5663		
5600			5664		

Special relay			Special relay		
NO.	I relay symbol	R/W	NO.	I relay symbol	R/W
5665	M01_B	R/W	5729		
5666	M02_B	R/W	5730		
5667	M03_B	R/W	5731		
5668	M04_B	R/W	5732		
5669	M05_B	R/W	5733		
5670	M06_B	R/W	5734		
5671	M07_B	R/W	5735		
5672	M08_B	R/W	5736		
5673	M09_B	R/W	5737		
5674	M10_B	R/W	5738		
5675	M11_B	R/W	5739		
5676	M12_B	R/W	5740		
5677	M13_B	R/W	5741		
5678	M14_B	R/W	5742		
5679	M15_B	R/W	5743		
5680	M16_B	R/W	5744		
5681			5745		
5682			5746		
5683			5747		
5684			5748		
5685			5749		
5686			5750		
5687			5751		
5688			5752		
5689			5753		
5690			5754		
5691			5755		
5692			5756		
5693			5757		
5694			5758		
5695			5759		
5696			5760		
5697			5761		
5698			5762		
5699			5763		
5700			5764		
5701			5765		
5702			5766		
5703			5767		
5704			5768		
5705			5769		
5706			5770		
5707			5771		
5708			5772		
5709			5773		
5710			5774		
5711			5775		
5712			5776		
5713			5777		
5714			5778		
5715			5779		
5716			5780		
5717			5781		
5718			5782		
5719			5783		
5720			5784		
5721			5785		
5722			5786		
5723			5787		
5724			5788		
5725			5789		
5726			5790		
5727			5791		
5728			5792		

5793 to 6304: Free area

11.3 UM33A I Relays

Special relay (5537 to 5792)

I relay No.	Symbol	Description
5537 to 5552	M01 to M16	You can read/write data from/to the area via communication. (Same as D7201 to D7208) That is, you can use the area freely without affecting the control function of the UTAdvanced
5553 to 5664		
5665 to 5680	M01_B to M16_B	You can read/write data from/to the area via communication. (Same as D7211 to D7212) That is, you can use the area freely without affecting the control function of the UTAdvanced
5681 to 5792		

11.3.4 Input / Output Terminal Status (6305 to 6560)

Note

When specifying an I relay number for communication, begin the number with the character "I."
Example: Set "I6305" to specify the DI1 (I relay No.: 6305).

11.3 UM33A I Relays

DI terminals			DI terminals		
NO.	I relay symbol	R/W	NO.	I relay symbol	R/W
6305	DI1	R	6369		
6306	DI2	R	6370		
6307			6371		
6308			6372		
6309			6373		
6310			6374		
6311			6375		
6312			6376		
6313			6377		
6314			6378		
6315			6379		
6316			6380		
6317			6381		
6318			6382		
6319			6383		
6320			6384		
6321			6385		
6322			6386		
6323			6387		
6324			6388		
6325			6389		
6326			6390		
6327			6391		
6328			6392		
6329			6393		
6330			6394		
6331			6395		
6332			6396		
6333			6397		
6334			6398		
6335			6399		
6336			6400		
6337			6401		
6338			6402		
6339			6403		
6340			6404		
6341			6405		
6342			6406		
6343			6407		
6344			6408		
6345			6409		
6346			6410		
6347			6411		
6348			6412		
6349			6413		
6350			6414		
6351			6415		
6352			6416		
6353			6417		
6354			6418		
6355			6419		
6356			6420		
6357			6421		
6358			6422		
6359			6423		
6360			6424		
6361			6425		
6362			6426		
6363			6427		
6364			6428		
6365			6429		
6366			6430		
6367			6431		
6368			6432		

DO terminals			DO terminals		
NO.	I relay symbol	R/W	NO.	I relay symbol	R/W
6433	OUT_AL1	R	6497		
6434	OUT_AL2	R	6498		
6435	OUT_AL3	R	6499		
6436			6500		
6437			6501		
6438			6502		
6439			6503		
6440			6504		
6441			6505		
6442			6506		
6443			6507		
6444			6508		
6445			6509		
6446			6510		
6447			6511		
6448			6512		
6449	OUT_DO11	R	6513		
6450	OUT_DO12	R	6514		
6451	OUT_DO13	R	6515		
6452	OUT_DO14	R	6516		
6453	OUT_DO15	R	6517		
6454			6518		
6455			6519		
6456			6520		
6457			6521		
6458			6522		
6459			6523		
6460			6524		
6461			6525		
6462			6526		
6463			6527		
6464			6528		
6465			6529		
6466			6530		
6467			6531		
6468			6532		
6469			6533		
6470			6534		
6471			6535		
6472			6536		
6473			6537		
6474			6538		
6475			6539		
6476			6540		
6477			6541		
6478			6542		
6479			6543		
6480			6544		
6481			6545		
6482			6546		
6483			6547		
6484			6548		
6485			6549		
6486			6550		
6487			6551		
6488			6552		
6489			6553		
6490			6554		
6491			6555		
6492			6556		
6493			6557		
6494			6558		
6495			6559		
6496			6560		

6561 to 7072: Free area

11.3 UM33A I Relays

DI Terminals and DO Terminals (6305 to 6560)

I relay No.	Symbol	Description
6305 to 6320	DI1 to DI2	DI1-DI2 status (Same as D7601)
6321 to 6336	DI11 to DI15	DI11-DI15 status (Same as D7602)
6337 to 6432		
6433 to 6448	OUT_AL1 to OUT_AL3	AL1-AL3 status (Same as D7611)
6449 to 6464	OUT_DO11 to OUT_DO15	DO11-DO15 status (Same as D7612)
6465 to 6560		

11.4 Reading via Communication

■ When reading the alarm status

Read I relay numbers 4321 to 4336 for alarm-1 to alarm-8 status.

I relay No.	Symbol	Event
4321 to 4336	ALM1_L1~ALM8_L1	Alarm-1 to alarm-8 status (Same as D2011) *
⋮	⋮	⋮
4545 to 4576		

*: The contents of alarm-1 to alarm-8 status (I relay numbers 4321 to 4336: ALM1_L1 to ALM8_L1) are the same as the bit configuration of D register number D2011 (alarm-1 to alarm-8 status). Refer to the bit configuration of D2011 described in “Chapter 10 Functions and Applications of D Registers (for UM33A).”

The following shows the bit configuration of D2011 described in “Chapter 10 Functions and Applications of D Registers (for UM33A).”

● Bit Configuration of D2011: ALM_L1 (Alarm-1 to alarm-8 status)

Bit	Symbol	Event
0	ALM1_L1	'1' when alarm 1 is ON; '0' when OFF
1	ALM2_L1	'1' when alarm 2 is ON; '0' when OFF
2	ALM3_L1	'1' when alarm 3 is ON; '0' when OFF
3		
4	ALM4_L1	'1' when alarm 4 is ON; '0' when OFF
5	ALM5_L1	'1' when alarm 5 is ON; '0' when OFF
6	ALM6_L1	'1' when alarm 6 is ON; '0' when OFF
7		
8	ALM7_L1	'1' when alarm 7 is ON; '0' when OFF
9	ALM8_L1	'1' when alarm 8 is ON; '0' when OFF
10 to 15		

Note

When specifying an I relay number for communication, begin the number with the character “I.”
Example: Set “I4321” to specify the ALM1_L1 (I relay No.: 4321).

11.5 GREEN Series Compatible I Relays

11.5.1 Compatibility with GREEN Series Controllers

The map configuration from 1 to 2048 of the I relay map is the same as that of the GREEN Series (UT300 Series) controllers.

If existing programs created in the GREEN Series controllers are used, communication is performed using the area from 0001 to 0784.

The I relay map after 4001 is allocated for the UTAdvanced.

If you want to newly perform communication, be sure to use the registers after 4001.

11.5.2 Conventions Used in I Relay Tables

■ How to Specify I Relay Numbers

When specifying an I relay number for communication, begin the number with the character "I."

Example: Set "I0001" to specify the ADERR (I relay No.: 0001).

■ Interpretation of Cell

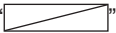
A cell marked with a diagonal line (") indicates that it is not supported by the UTAdvanced.

■ I relay symbol

- With regards to some register symbols, the loop number is indicated by adding the underline () to the end of the parameter symbols.

Note

Since the UM33A is a single-loop controller, it has no distinction between Loop-1 and Loop-2. However, the register symbol has "L1" which indicates Loop-1.

□□□□_L1 L1: Loop numbers

Example : PVBO_L1 Indicates PVBO.

- Numbers in parentheses after the register symbols of the UTAdvanced indicate the same I relay after I4001.

Note

-
- I relay numbers 1 to 192 store ON/OFF status information and are normally read for ON/OFF status information. I relay numbers 1 to 192 also exists in D registers. They have the same function data as D registers.
 - In the area for I relay numbers 1 to 720, it is prohibited to write data to I relays with blank cells in I relay map tables. If you attempt to do so, the UTAdvanced may not operate properly.
-

11.5.3 Status (0001 to 0192)

NO.	I relay symbol		NO.	Status		NO.	I relay symbol	
	GREEN	UTAdvanced		GREEN	UTAdvanced		GREEN	UTAdvanced
1	ADERROR.st	ADERR (4065)	65			129		
2			66			130		
3			67			131		
4			68			132		
5			69			133		
6			70			134		
7			71			135		
8			72			136		
9			73			137		
10			74			138		
11			75			139		
12			76			140		
13			77			141		
14			78			142		
15			79			143		
16			80			144		
17			81			145		
18	PVBO.st	PVBO_L1 (4097)	82			146		
19	RJCERR.st	RJCERR (4070)	83			147		
20			84			148		
21	PV+over.st	PVPOVER_L1 (4101)	85			149		
22	PV-over.st	PVMOVER_L1 (4102)	86			150		
23			87			151		
24			88			152		
25			89			153		
26			90			154		
27			91			155		
28			92			156		
29			93			157		
30			94			158		
31			95			159		
32			96			160		
33			97	ALM1.st	ALM1_L1 (4321)	161		
34			98	ALM2.st	ALM2_L1 (4322)	162		
35			99	ALM3.st	ALM3_L1 (4323)	163		
36			100			164		
37			101	ALM4.st	ALM4_L1 (4325)	165		
38			102			166		
39			103			167		
40			104			168		
41			105			169		
42			106			170		
43			107			171		
44			108			172		
45			109			173		
46			110			174		
47			111			175		
48			112			176		
49	CALB.E.st	CALB_ERR (4002)	113			177		
50			114			178		
51			115			179		
52			116			180		
53			117			181		
54			118			182		
55	SETUP.st	SETPA_ERR (4005)	119			183		
56			120			184		
57	PARA.E.st	OPEPA_ERR (4006)	121			185		
58			122			186		
59			123			187		
60			124			188		
61	EEP.E.st	FRAM_ERR (4009)	125			189		
62			126			190		
63	SYSTEM.E.st	SYSTEM_ERR (4001)	127			191		
64			128			192		

193 to 720: Free area

11.5 I Relays Corresponding to GREEN Series

I relay No.	Symbol	Description
1 to 16	ADERR	A/D converter error status for GREEN Series (Same as 0001)
17 to 32	PVBO_L1 to ATERR_L1	PV input error status for GREEN Series (Same as 0002)
33 to 48		
49 to 64	CALB_ERR to SYSTEM_ERR	Parameter error status for GREEN Series (Same as 0035)
65 to 80		
81 to 96		
97 to 112	ALM1_L1 to ALM4_L1	Alarm status for GREEN Series (Same as 0011)
113 to 192		

193 to 720: Free area

11.5.4 User Area (0721 to 784)

I relay No.	I relay symbol	Description	
721 to 784	USER	User area	You can read/write data from/to the area for I relays 721 to 784 via communication. That is, you can use the area freely without affecting the control function of the UTAdvanced. However, the data cannot be saved.

12.1 Overview

This chapter describes the functions and applications of the D registers.

D registers are used in Modbus, PC link, ladder, or Ethernet communications and are used for storing UTAdvanced parameter data, flag data, process data, and other data and values.

The host computer can utilize these data by reading from and writing to the D registers. When you newly perform communication with the UTAdvanced, the D registers after D2001 are used.

Use of the D registers enables the following:

- Centralized control by the host computer
- Reading and writing of data between the UTAdvanced and the host computer

Note

The D registers available vary depending on the model and suffix codes of the UTAdvanced or parameter settings. For details, refer to the respective UTAdvanced User's Manual.

D registers and I relays on the UTAdvanced are used for parameter settings of LL50A Parameter Setting Software.

12.2 Conventions Used in D Register Tables

This section describes the conventions used in the D register map tables.

The numerical values arranged vertically in the leftmost column of the table represent (1) D register numbers. 5-digit numbers in the column next to it show (2) reference numbers for Modbus communication. The third column from the left provides (3) register numbers (hexadecimal) for Modbus communication.

Alphabet characters in the register map represent process data, operation parameters, setup parameters, and other flag register names. For details on operation parameters and setup parameters, refer to the respective UT35A-L Operation Guide and User's Manual.

Register map (Categories)				
Register contents				
D-Reg No.	Ref. No.	H No.	Register symbol	R/W
D2001	42001	07D0	AD1.E *1	R
D2002	42002	07D1	PV1.E_L1 *1	R
D2003	40003	07D2	PV_L1 *1	R
D2004	40004	07D3	CSP_L1	R
•	•	•	•	•
•	•	•	•	•
•	•	•	•	•

↑

(1) D register numbers

↑

(2) Reference numbers (for Modbus communication)

↑

(3) Hexadecimal numbers (for Modbus communication)

↑

Read/write by communication
R: Read enabled
W: Write enabled
: No register

*1: Register symbols listed in blue-color boldface (e.g., **AD1.E**) indicates the parameters of the UTAdvanced.

■ D Register Symbols

- With regards to some D register symbols, the loop number, terminal area, and group number are indicated by adding the underline () to the end of the parameter symbols.

Note

Since the UT35A-L is a limit controller, it has no distinction between Loop-1 and Loop-2. However, the register symbol has "L1" which indicates Loop-1.

□□□□_L1 L1: Loop numbers
□□□□_En En: Terminal area (E3)

Example : **SP_L1** Indicates SP.
 A2_2 Indicates A2 of group 2.

12.3 Classification of D Registers

■ Classification of D Register Map Tables

The table on next page outlines how the D registers are classified by their numbers in the D register map tables.

When you newly perform communication with the UTAdvanced, the D registers after D2001 are used.

CAUTION

- Check the model and suffix codes and parameter settings before writing to or read from the registers to be used.
- No data can be written to or read from blank parts of the data storage area by communication.
The UTAdvanced sometimes does not operate properly if an attempt is made to write to or read from blank parts of the data storage area.

■ Setting a Value with a Decimal Point

When setting a value with a decimal point from the host computer, set a value excluding the decimal point (hexadecimal)*.

Note

The UTAdvanced determine the decimal point position by the parameter setting.

Example: When setting a target setpoint "50.0" from the host computer

Set "1F4" which is a hexadecimal value of "500" (50.0 excluding the decimal point) (this is also true for setting 5.00 or 500).

Target setpoint "50.0": P.DP = 1

Target setpoint "5.00": P.DP = 2

Target setpoint "500": P.DP = 0

*: For ladder operation, set the BCD value excluding the decimal point.

12.3 Classification of D Registers

Classification of D Registers

Register No.	Area and data categories	Description	Reference	
D0001 to D0049	Configuration map for GREEN Series (See 12.6 GREEN Series Compatible D Registers)	Process data	Sections 12.6.3	
D0050 to D0100		User area	Sections 12.6.3	
D0101 to D0200		Free area	Sections 12.6.3	
D0201 to D0230		Operation mode parameter	Sections 12.6.4	
D0231 to D0300		Operation-related parameter	Sections 12.6.4	
D0301 to D0500		SP parameter	Sections 12.6.5	
D0501 to D0900		Free area		
D0901 to D1000		Control action parameter	Sections 12.6.6	
D1001 to D1100		Common function parameter	Sections 12.6.7	
D1101 to D1200		Free area		
D1201 to D1300		PV input and control output parameter	Sections 12.6.8	
D1301 to D2000		Free area		
D2001 to D2100		Process monitoring	Process data	Sections 12.4.1
D2101 to D2200			Current SP group	
D2201 to D2500	Free area			
D2501 to D2600	Operation parameter	SP and alarm setpoint setting	Sections 12.4.2	
D2601 to D2700		SP-related setting		
D2701 to D2800		Free area		
D2801 to D2900		Alarm function setting		
D2901 to D3000		PV-related setting		
D3001 to D5000	Free area	Free area		
D5001 to D5100	Setup parameter	Control function setting	Sections 12.4.3	
D5101 to D5300		Input setting		
D5301 to D5400		Output setting		
D5401 to D5500		Free area		
D5501 to D5700		Communication setting		
D5701 to D5800		Key action setting / Display function setting		
D5801 to D5900		Lock setting (Key lock / menu lock)		
D5901 to D6200		DI function setting		
D6201 to D6300		Free area		
D6301 to D6400		I/O display		
D6401 to D6500	System setting			
D6501 to D7600	Free area	Free area		
D7601 to D7700	Terminal status register	Input / Output terminal status register	Sections 12.4.4	
D7701 to D9000	Free area	Free area		

Note 1: Data in the process values, operation parameters, and setup parameters is stored in the format (data excluding the decimal point of PV input range, PV input range span, %, or ABS) described in "Lists of Operation Parameters" and "Lists of Setup Parameters" in the UT35A-L Operation Guide or User's Manual.
The OFF status of data is indicated by "0" and the ON status is indicated by "1."
D registers D2001 to D2100 are read-only.

12.4 UT35A-L D Registers

12.4.1 Process Monitoring (D2001 to D2300)

Process monitoring area									
Process data									
D-Reg No.	Ref. No.	H No.	Register symbol	R/W	D-Reg No.	Ref. No.	H No.	Register symbol	R/W
				UT35A-L					UT35A-L
D2001	42001	07D0	AD1.E	R	D2051	42051	0802		
D2002	42002	07D1	PV1.E_L1	R	D2052	42052	0803		
D2003	42003	07D2	PV_L1	R	D2053	42053	0804		
D2004	42004	07D3	CSP_L1	R	D2054	42054	0805		
D2005	42005	07D4			D2055	42055	0806		
D2006	42006	07D5			D2056	42056	0807		
D2007	42007	07D6			D2057	42057	0808		
D2008	42008	07D7	MOD_L1	R	D2058	42058	0809		
D2009	42009	07D8			D2059	42059	080A		
D2010	42010	07D9			D2060	42060	080B		
D2011	42011	07DA	ALM_L1	R	D2061	42061	080C		
D2012	42012	07DB			D2062	42062	080D		
D2013	42013	07DC			D2063	42063	080E		
D2014	42014	07DD			D2064	42064	080F		
D2015	42015	07DE			D2065	42065	0810		
D2016	42016	07DF			D2066	42066	0811	DIMG	R
D2017	42017	07E0			D2067	42067	0812		
D2018	42018	07E1			D2068	42068	0813	PA.ER	R
D2019	42019	07E2			D2069	42069	0814		
D2020	42020	07E3			D2070	42070	0815	OPER	R
D2021	42021	07E4			D2071	42071	0816	ALOLA1_L1	R
D2022	42022	07E5			D2072	42072	0817		
D2023	42023	07E6			D2073	42073	0818	ALOLA2_L1	R
D2024	42024	07E7			D2074	42074	0819		
D2025	42025	07E8			D2075	42075	081A	ALOLA3_L1	R
D2026	42026	07E9			D2076	42076	081B		
D2027	42027	07EA			D2077	42077	081C	ALOLA4_L1	R
D2028	42028	07EB			D2078	42078	081D		
D2029	42029	07EC			D2079	42079	081E		
D2030	42030	07ED			D2080	42080	081F		
D2031	42031	07EE			D2081	42081	0820	TIME	R
D2032	42032	07EF			D2082	42082	0821	MAX/MIN	R
D2033	42033	07F0			D2083	42083	0822		
D2034	42034	07F1			D2084	42084	0823		
D2035	42035	07F2			D2085	42085	0824		
D2036	42036	07F3			D2086	42086	0825		
D2037	42037	07F4	ALO_L1	R	D2087	42087	0826		
D2038	42038	07F5			D2088	42088	0827		
D2039	42039	07F6			D2089	42089	0828		
D2040	42040	07F7			D2090	42090	0829		
D2041	42041	07F8			D2091	42091	082A		
D2042	42042	07F9			D2092	42092	082B		
D2043	42043	07FA			D2093	42093	082C		
D2044	42044	07FB			D2094	42094	082D		
D2045	42045	07FC			D2095	42095	082E		
D2046	42046	07FD			D2096	42096	082F		
D2047	42047	07FE			D2097	42097	0830		
D2048	42048	07FF			D2098	42098	0831		
D2049	42049	0800			D2099	42099	0832		
D2050	42050	0801			D2100	42100	0833		

12.4 UT35A-L D Registers

Process monitoring area									
Current SP group									
D-Reg No.	Ref. No.	H No.	Register symbol	R/W	D-Reg No.	Ref. No.	H No.	Register symbol	R/W
				UT35A-L					UT35A-L
D2101	42101	0834	SP_L1	R/W	D2151	42151	0866		
D2102	42102	0835			D2152	42152	0867		
D2103	42103	0836			D2153	42153	0868		
D2104	42104	0837	A1_L1	R/W	D2154	42154	0869		
D2105	42105	0838	A2_L1	R/W	D2155	42155	086A		
D2106	42106	0839	A3_L1	R/W	D2156	42156	086B		
D2107	42107	083A			D2157	42157	086C		
D2108	42108	083B			D2158	42158	086D		
D2109	42109	083C			D2159	42159	086E		
D2110	42110	083D			D2160	42160	086F		
D2111	42111	083E			D2161	42161	0870		
D2112	42112	083F			D2162	42162	0871		
D2113	42113	0840			D2163	42163	0872		
D2114	42114	0841			D2164	42164	0873		
D2115	42115	0842			D2165	42165	0874		
D2116	42116	0843			D2166	42166	0875		
D2117	42117	0844			D2167	42167	0876		
D2118	42118	0845			D2168	42168	0877		
D2119	42119	0846			D2169	42169	0878		
D2120	42120	0847			D2170	42170	0879		
D2121	42121	0848			D2171	42171	087A		
D2122	42122	0849			D2172	42172	087B		
D2123	42123	084A			D2173	42173	087C		
D2124	42124	084B			D2174	42174	087D		
D2125	42125	084C			D2175	42175	087E		
D2126	42126	084D			D2176	42176	087F		
D2127	42127	084E			D2177	42177	0880		
D2128	42128	084F			D2178	42178	0881		
D2129	42129	0850			D2179	42179	0882		
D2130	42130	0851			D2180	42180	0883		
D2131	42131	0852			D2181	42181	0884		
D2132	42132	0853			D2182	42182	0885		
D2133	42133	0854			D2183	42183	0886		
D2134	42134	0855			D2184	42184	0887		
D2135	42135	0856			D2185	42185	0888		
D2136	42136	0857			D2186	42186	0889		
D2137	42137	0858			D2187	42187	088A		
D2138	42138	0859			D2188	42188	088B		
D2139	42139	085A			D2189	42189	088C		
D2140	42140	085B			D2190	42190	088D		
D2141	42141	085C			D2191	42191	088E		
D2142	42142	085D			D2192	42192	088F		
D2143	42143	085E			D2193	42193	0890		
D2144	42144	085F			D2194	42194	0891		
D2145	42145	0860			D2195	42195	0892		
D2146	42146	0861			D2196	42196	0893		
D2147	42147	0862			D2197	42197	0894		
D2148	42148	0863			D2198	42198	0895		
D2149	42149	0864			D2199	42199	0896		
D2150	42150	0865			D2200	42200	0897		

D2201 to D2300: Free area

Process Data Area

Some of the D registers represent multiple events such as errors and status depending on combinations of bits in the register.

In the following tables, if an event indicated by a specific bit occurs, the state of that bit changes to "1."

If no event occurs, the state of that bit is "0." Blank lines in each table indicate unused bits.

Process Data (D2001 to D2100)

● Bit Configuration of D2001: AD1.E (A/D converter error status 1)

Bit	Symbol	Event
0	ADERR	PV input A/D converter error
1 to 4		
5	RJCERR	PV input RJC error
6 to 7		
8	ADBO	PV input burnout error
9 to 15		

● Bit Configuration of D2002: PV1.E_L1 (PV input error status)

Bit	Symbol	Event
0	PVBO_L1	PV input burnout error
1 to 3		
4	PVPOVER_L1	PV input over-scale
5	PVMOVER_L1	PV input under-scale
6 to 15		

● D2003 to D2004

Register No.	Description	Range and meaning of value
D2003	PV_L1	Measurement value -5.0 to 105.0% of PV input range (EU)
D2004	CSP_L1	Control setpoint 0.0 to 100.0% of PV input range (EU) (Setting range: SPL to SPH)

● Bit Configuration of D2008: MOD_L1 (Operation mode status)

Bit	Symbol	Event
0		
1 to 11		
12	EXD	1: Exceeded
13	OUT	0: Output relay OFF, 1: Output relay ON
14 to 15		

12.4 UT35A-L D Registers

● Bit Configuration of D2011: ALM_L1 (Alarm-1 to alarm-3 status)

Bit	Symbol	Event
0	ALM1_L1	'1' when Alarm 1 is ON; '0' when OFF
1	ALM2_L1	'1' when Alarm 2 is ON; '0' when OFF
2	ALM3_L1	'1' when Alarm 3 is ON; '0' when OFF
3 to 15		

● Bit Configuration of D2037: ALO_L1 (Alarm-1 to alarm-3 output status)

Bit	Symbol	Event
0	ALO1_L1	Output status where Alarm output 1 is assigned. 0: When the alarm is turned off (alarm type: energized), or the alarm is turned on (alarm type: de-energized). (The relay contact is open.) 1: When the alarm is turned on (alarm type: energized), or the alarm is turned off (alarm type: de-energized). (The relay contact is closed.)
1	ALO2_L1	Output status where Alarm output 2 is assigned. For bit information, same as bit 0.
2	ALO3_L1	Output status where Alarm output 3 is assigned. For bit information, same as bit 0.
3		
4 to 15		

● Bit Configuration of D2066: DIMG (Message display interruption status)

Bit	Symbol	Event
0	MG1.B	Message display interruption 1 (1: displayed, 0: not displayed)
1	MG2.B	Message display interruption 2 (1: displayed, 0: not displayed)
2	MG3.B	Message display interruption 3 (1: displayed, 0: not displayed)
3		
4	MG4.B	Message display interruption 4 (1: displayed, 0: not displayed)
5 to 15		

● Bit Configuration of D2068: PA.ER (Parameter error status)

Bit	Symbol	Event
0	SYSTEM_ERR	System data error
1	CALB_ERR	Calibration value error
2	UPARA_ERR	User (parameter) default value error
3		
4	SETPA_ERR	Setup parameter error
5	OPEPA_ERR	Operation parameter error
6 to 7		
8	FRAM_ERR	Faulty FRAM
9		
10	CTLPA_ERR	Control parameter error
11 to 15		

● **Bit Configuration of D2070: OP.ER (Option error status)**

Bit	Symbol	Event
0		
1		
2	E3_ERR	Nonresponding hardware of E3 terminal area
3 to 9		
10	COM_E3_ERR	Communication error E3 terminal area
11 to 15		

● **Bit Configuration of D2071: ALOLA1_L1 (Alarm-1 to alarm-3 latch output status)**

Bit	Symbol	Event
0	ALO1LA1_L1	Alarm-1 latch-1 output status
1	ALO2LA1_L1	Alarm-2 latch-1 output status
2	ALO3LA1_L1	Alarm-3 latch-1 output status
3		
4 to 15		

● **Bit Configuration of D2073: ALOLA2_L1 (Alarm-1 to alarm-3 latch-2 output status)**

Bit	Symbol	Event
0	ALO1LA2_L1	Alarm-1 latch-2 output status
1	ALO2LA2_L1	Alarm-2 latch-2 output status
2	ALO3LA2_L1	Alarm-3 latch-2 output status
3		
4 to 15		

● **Bit Configuration of D2075: ALOLA3_L1 (Alarm-1 to alarm-3 latch-3 output status)**

Bit	Symbol	Event
0	ALO1LA3_L1	Alarm-1 latch-3 output status
1	ALO2LA3_L1	Alarm-2 latch-3 output status
2	ALO3LA3_L1	Alarm-3 latch-3 output status
3		
4 to 15		

● **Bit Configuration of D2077: ALOLA4_L1 (Alarm-1 to alarm-3 latch-4 output status)**

Bit	Symbol	Event
0	ALO1LA4_L1	Alarm-1 latch-4 output status
1	ALO2LA4_L1	Alarm-2 latch-4 output status
2	ALO3LA4_L1	Alarm-3 latch-4 output status
3		
4 to 15		

● **D2081: TIME (Duration time)**

Example: The reading for one hours, 38 minutes and 57 seconds is given as 5937 seconds.

Use the parameter TMU to set the time unit.

● **D2082: MAX/MIN (Maximum value/Minimum value)**

The maximum/minimum value of the PV input.

Use the parameter HI.LO to set the limit control type (LOW or High).

12.4 UT35A-L D Registers

Current SP Group (D2101 to D2200)

Register No.	Description	Range and meaning of value
D2101	SP_L1_1	Target setpoint
D2102		
D2103		
D2104	A1_L1_1	Alarm-1 setpoint
D2105	A2_L1_1	Alarm-2 setpoint
D2106	A3_L1_1	Alarm-3 setpoint
D2107 to D2200		

Free Area (D2201 to D2500)

Register No.	Description	Range and meaning of value
D2201 to D2500	Free area	

12.4.2 Operation Parameter (D2501 to D4700)

Operation parameter									
SP and alarm setpoint setting (Menu: SP)									
D-Reg No.	Ref. No.	H No.	Register symbol	R/W	D-Reg No.	Ref. No.	H No.	Register symbol	R/W
				UT35A-L					UT35A-L
D2501	42501	09C4	SP_L1_1	R/W	D2551	42551	09F6		
D2502	42502	09C5			D2552	42552	09F7		
D2503	42503	09C6			D2553	42553	09F8		
D2504	42504	09C7	A1_L1_1	R/W	D2554	42554	09F9		
D2505	42505	09C8	A2_L1_1	R/W	D2555	42555	09FA		
D2506	42506	09C9	A3_L1_1	R/W	D2556	42556	09FB		
D2507	42507	09CA			D2557	42557	09FC		
D2508	42508	09CB			D2558	42558	09FD		
D2509	42509	09CC			D2559	42559	09FE		
D2510	42510	09CD			D2560	42560	09FF		
D2511	42511	09CE			D2561	42561	0A00		
D2512	42512	09CF			D2562	42562	0A01		
D2513	42513	09D0			D2563	42563	0A02		
D2514	42514	09D1			D2564	42564	0A03		
D2515	42515	09D2			D2565	42565	0A04		
D2516	42516	09D3			D2566	42566	0A05		
D2517	42517	09D4			D2567	42567	0A06		
D2518	42518	09D5			D2568	42568	0A07		
D2519	42519	09D6			D2569	42569	0A08		
D2520	42520	09D7			D2570	42570	0A09		
D2521	42521	09D8			D2571	42571	0A0A		
D2522	42522	09D9			D2572	42572	0A0B		
D2523	42523	09DA			D2573	42573	0A0C		
D2524	42524	09DB			D2574	42574	0A0D		
D2525	42525	09DC			D2575	42575	0A0E		
D2526	42526	09DD			D2576	42576	0A0F		
D2527	42527	09DE			D2577	42577	0A10		
D2528	42528	09DF			D2578	42578	0A11		
D2529	42529	09E0			D2579	42579	0A12		
D2530	42530	09E1			D2580	42580	0A13		
D2531	42531	09E2			D2581	42581	0A14		
D2532	42532	09E3			D2582	42582	0A15		
D2533	42533	09E4			D2583	42583	0A16		
D2534	42534	09E5			D2584	42584	0A17		
D2535	42535	09E6			D2585	42585	0A18		
D2536	42536	09E7			D2586	42586	0A19		
D2537	42537	09E8			D2587	42587	0A1A		
D2538	42538	09E9			D2588	42588	0A1B		
D2539	42539	09EA			D2589	42589	0A1C		
D2540	42540	09EB			D2590	42590	0A1D		
D2541	42541	09EC			D2591	42591	0A1E		
D2542	42542	09ED			D2592	42592	0A1F		
D2543	42543	09EE			D2593	42593	0A20		
D2544	42544	09EF			D2594	42594	0A21		
D2545	42545	09F0			D2595	42595	0A22		
D2546	42546	09F1			D2596	42596	0A23		
D2547	42547	09F2			D2597	42597	0A24		
D2548	42548	09F3			D2598	42598	0A25		
D2549	42549	09F4			D2599	42599	0A26		
D2550	42550	09F5			D2600	42600	0A27		

D2601 to D2700: Free area

12.4 UT35A-L D Registers

Operation parameter									
SP-related setting (Menu: SPS)									
D-Reg No.	Ref. No.	H No.	Register symbol	R/W	D-Reg No.	Ref. No.	H No.	Register symbol	R/W
				UT35A-L					UT35A-L
D2701	42701	0A8C			D2751	42751	0ABE		
D2702	42702	0A8D			D2752	42751	0ABF		
D2703	42703	0A8E			D2753	42751	0AC0		
D2704	42704	0A8F			D2754	42751	0AC1		
D2705	42705	0A90			D2755	42751	0AC2		
D2706	42706	0A91			D2756	42751	0AC3		
D2707	42707	0A92			D2757	42751	0AC4		
D2708	42708	0A93			D2758	42751	0AC5		
D2709	42709	0A94			D2759	42751	0AC6		
D2710	42710	0A95			D2760	42751	0AC7		
D2711	42711	0A96			D2761	42751	0AC8		
D2712	42712	0A97			D2762	42751	0AC9		
D2713	42713	0A98			D2763	42751	0ACA		
D2714	42714	0A99	TMU_L1	R/W	D2764	42751	0ACB		
D2715	42715	0A9A			D2765	42751	0ACC		
D2716	42716	0A9B			D2766	42751	0ACD		
D2717	42717	0A9C			D2767	42751	0ACE		
D2718	42718	0A9D			D2768	42751	0ACF		
D2719	42719	0A9E			D2769	42751	0AD0		
D2720	42720	0A9F			D2770	42751	0AD1		
D2721	42721	0AA0			D2771	42751	0AD2		
D2722	42722	0AA1			D2772	42751	0AD3		
D2723	42723	0AA2			D2773	42751	0AD4		
D2724	42724	0AA3			D2774	42751	0AD5		
D2725	42725	0AA4			D2775	42751	0AD6		
D2726	42726	0AA5			D2776	42751	0AD7		
D2727	42727	0AA6			D2777	42751	0AD8		
D2728	42728	0AA7			D2778	42751	0AD9		
D2729	42729	0AA8			D2779	42751	0ADA		
D2730	42730	0AA9			D2780	42751	0ADB		
D2731	42731	0AAA			D2781	42751	0ADC		
D2732	42732	0AAB			D2782	42751	0ADD		
D2733	42733	0AAC			D2783	42751	0ADE		
D2734	42734	0AAD			D2784	42751	0ADF		
D2735	42735	0AAE			D2785	42751	0AE0		
D2736	42736	0AAF			D2786	42751	0AE1		
D2737	42737	0AB0			D2787	42751	0AE2		
D2738	42738	0AB1			D2788	42751	0AE3		
D2739	42739	0AB2			D2789	42751	0AE4		
D2740	42740	0AB3			D2790	42751	0AE5		
D2741	42741	0AB4			D2791	42751	0AE6		
D2742	42742	0AB5			D2792	42751	0AE7		
D2743	42743	0AB6			D2793	42751	0AE8		
D2744	42744	0AB7			D2794	42751	0AE9		
D2745	42745	0AB8			D2795	42751	0AEA		
D2746	42746	0AB9			D2796	42751	0AEB		
D2747	42747	0ABA			D2797	42751	0AEC		
D2748	42748	0ABB			D2798	42751	0AED		
D2749	42749	0ABC			D2799	42751	0AEE		
D2750	42750	0ABD			D2800	42751	0AEF		

Operation parameter									
Alarm function setting (Menu: ALRM)									
D-Reg No.	Ref. No.	H No.	Register symbol	R/W	D-Reg No.	Ref. No.	H No.	Register symbol	R/W
				UT35A-L					UT35A-L
D2801	42801	0AF0	AL1.T_L1	R/W	D2851	42851	0B22	DYN3_L1	R/W
D2802	42802	0AF1	AL1.W_L1	R/W	D2852	42852	0B23		
D2803	42803	0AF2	AL1.D_L1	R/W	D2853	42853	0B24		
D2804	42804	0AF3	AL1.L_L1	R/W	D2854	42854	0B25		
D2805	42805	0AF4	AL2.T_L1	R/W	D2855	42855	0B26		
D2806	42806	0AF5	AL2.W_L1	R/W	D2856	42856	0B27		
D2807	42807	0AF6	AL2.D_L1	R/W	D2857	42857	0B28	DYF1_L1	R/W
D2808	42808	0AF7	AL2.L_L1	R/W	D2858	42858	0B29	DYF2_L1	R/W
D2809	42809	0AF8	AL3.T_L1	R/W	D2859	42859	0B2A	DYF3_L1	R/W
D2810	42810	0AF9	AL3.W_L1	R/W	D2860	42860	0B2B		
D2811	42811	0AFA	AL3.D_L1	R/W	D2861	42861	0B2C		
D2812	42812	0AFB	AL3.L_L1	R/W	D2862	42862	0B2D		
D2813	42813	0AFC			D2863	42863	0B2E		
D2814	42814	0AFD			D2864	42864	0B2F		
D2815	42815	0AFE			D2865	42865	0B30		
D2816	42816	0AFF			D2866	42866	0B31		
D2817	42817	0B00			D2867	42867	0B32		
D2818	42818	0B01			D2868	42868	0B33		
D2819	42819	0B02			D2869	42869	0B34		
D2820	42820	0B03			D2870	42870	0B35		
D2821	42821	0B04			D2871	42871	0B36		
D2822	42822	0B05			D2872	42872	0B37		
D2823	42823	0B06			D2873	42873	0B38		
D2824	42824	0B07			D2874	42874	0B39		
D2825	42825	0B08			D2875	42875	0B3A		
D2826	42826	0B09			D2876	42876	0B3B		
D2827	42827	0B0A			D2877	42877	0B3C		
D2828	42828	0B0B			D2878	42878	0B3D		
D2829	42829	0B0C			D2879	42879	0B3E		
D2830	42830	0B0D			D2880	42880	0B3F		
D2831	42831	0B0E			D2881	42881	0B40		
D2832	42832	0B0F			D2882	42882	0B41		
D2833	42833	0B10	VT1_L1	R/W	D2883	42883	0B42		
D2834	42834	0B11	VT2_L1	R/W	D2884	42884	0B43		
D2835	42835	0B12	VT3_L1	R/W	D2885	42885	0B44		
D2836	42836	0B13			D2886	42886	0B45		
D2837	42837	0B14			D2887	42887	0B46		
D2838	42838	0B15			D2888	42888	0B47		
D2839	42839	0B16			D2889	42889	0B48		
D2840	42840	0B17			D2890	42890	0B49		
D2841	42841	0B18	HY1_L1	R/W	D2891	42891	0B4A		
D2842	42842	0B19	HY2_L1	R/W	D2892	42892	0B4B		
D2843	42843	0B1A	HY3_L1	R/W	D2893	42893	0B4C		
D2844	42844	0B1B			D2894	42894	0B4D		
D2845	42845	0B1C			D2895	42895	0B4E		
D2846	42846	0B1D			D2896	42896	0B4F		
D2847	42847	0B1E			D2897	42897	0B50		
D2848	42848	0B1F			D2898	42898	0B51		
D2849	42849	0B20	DYN1_L1	R/W	D2899	42899	0B52		
D2850	42850	0B21	DYN2_L1	R/W	D2900	42900	0B53		

12.4 UT35A-L D Registers

Operation parameter									
PV-related setting (Menu: PVS)									
D-Reg No.	Ref. No.	H No.	Register symbol	R/W	D-Reg No.	Ref. No.	H No.	Register symbol	R/W
				UT35A-L					UT35A-L
D2901	42901	0B54	BS_L1	R/W	D2951	42951	0B86		
D2902	42902	0B55	FL_L1	R/W	D2952	42952	0B87		
D2903	42903	0B56			D2953	42953	0B88		
D2904	42904	0B57			D2954	42954	0B89		
D2905	42905	0B58			D2955	42955	0B8A		
D2906	42906	0B59			D2956	42956	0B8B		
D2907	42907	0B5A			D2957	42957	0B8C		
D2908	42908	0B5B			D2958	42958	0B8D		
D2909	42909	0B5C			D2959	42959	0B8E		
D2910	42910	0B5D			D2960	42960	0B8F		
D2911	42911	0B5E	HYS_L1	R/W	D2961	42961	0B90		
D2912	42912	0B5F			D2962	42962	0B91		
D2913	42913	0B60			D2963	42963	0B92		
D2914	42914	0B61			D2964	42964	0B93		
D2915	42915	0B62			D2965	42965	0B94		
D2916	42916	0B63			D2966	42966	0B95		
D2917	42917	0B64			D2967	42967	0B96		
D2918	42918	0B65			D2968	42968	0B97		
D2919	42919	0B66			D2969	42969	0B98		
D2920	42920	0B67			D2970	42970	0B99		
D2921	42921	0B68			D2971	42971	0B9A		
D2922	42922	0B69			D2972	42972	0B9B		
D2923	42923	0B6A			D2973	42973	0B9C		
D2924	42924	0B6B			D2974	42974	0B9D		
D2925	42925	0B6C			D2975	42975	0B9E		
D2926	42926	0B6D			D2976	42976	0B9F		
D2927	42927	0B6E			D2977	42977	0BA0		
D2928	42928	0B6F			D2978	42978	0BA1		
D2929	42929	0B70			D2979	42979	0BA2		
D2930	42930	0B71			D2980	42980	0BA3		
D2931	42931	0B72			D2981	42981	0BA4		
D2932	42932	0B73			D2982	42982	0BA5		
D2933	42933	0B74			D2983	42983	0BA6		
D2934	42934	0B75			D2984	42984	0BA7		
D2935	42935	0B76			D2985	42985	0BA8		
D2936	42936	0B77			D2986	42986	0BA9		
D2937	42937	0B78			D2987	42987	0BAA		
D2938	42938	0B79			D2988	42988	0BAB		
D2939	42939	0B7A			D2989	42989	0BAC		
D2940	42940	0B7B			D2990	42990	0BAD		
D2941	42941	0B7C			D2991	42991	0BAE		
D2942	42942	0B7D			D2992	42992	0BAF		
D2943	42943	0B7E			D2993	42993	0BB0		
D2944	42944	0B7F			D2994	42994	0BB1		
D2945	42945	0B80			D2995	42995	0BB2		
D2946	42946	0B81			D2996	42996	0BB3		
D2947	42947	0B82			D2997	42997	0BB4		
D2948	42948	0B83			D2998	42998	0BB5		
D2949	42949	0B84			D2999	42999	0BB6		
D2950	42950	0B85			D3000	43000	0BB7		

D3001 to D4700: Free area

SP and Alarm Setpoint Setting (D2501 to D2700)

Register No.	Description	Range and meaning of value
D2501	SP_L1_1	Target setpoint of group 1
D2502		0.0 to 100.0% of PV input range (EU) (Setting range: SPL to SPH)
D2503		
D2504	A1_L1_1	Alarm-1 setpoint of group 1
D2505	A2_L1_1	Alarm-2 setpoint of group 1
D2506	A3_L1_1	Alarm-3 setpoint of group 1
D2507 to D2800		Set a display value of setpoint of PV alarm, SP alarm, deviation alarm, or velocity alarm. -19999 to 30000 (Set a value within the input range.) Decimal point position depends on the input type.

SP-related Setting (D2701 to D2800)

Register No.	Description	Range and meaning of value
D2701 to D2713		
D2714	TMU_L1	Time unit for duration time
D2715 to D2800		0: HH:MM (Hour and minute) 1: MM:SS (Minute and second)

12.4 UT35A-L D Registers

Alarm Function Setting (D2801 to D2900)

Register No.	Description		Range and meaning of value
D2801	AL1.T_L1	Alarm-1 type	AL1.T_L1 to AL3.T_L1 0: Disable 1: PV high limit 2: PV low limit 3: SP high limit 4: SP low limit 5: Deviation high limit 6: Deviation low limit 7: Deviation high and low limits 8: Deviation within high and low limits 29: PV velocity 30: Fault diagnosis 31: FAIL
D2802	AL1.W_L1	Alarm-1 stand-by action	
D2803	AL1.D_L1	Alarm-1 energized/de-energized	
D2804	AL1.L_L1	Alarm-1 latch	
D2805	AL2.T_L1	Alarm-2 type	
D2806	AL2.W_L1	Alarm-2 stand-by action	
D2807	AL2.D_L1	Alarm-2 energized/de-energized	
D2808	AL2.L_L1	Alarm-2 latch	
D2809	AL3.T_L1	Alarm-3 type	
D2810	AL3.W_L1	Alarm-3 stand-by action	
D2811	AL3.D_L1	Alarm-3 energized/de-energized	
D2812	AL3.L_L1	Alarm-3 latch	
D2813 to D2832			AL1.L_L1 to AL3.L_L1 0: OFF 1: Latch 1 2: Latch 2 3: Latch 3 4: Latch 4 When the UTAdvanced parameter is set by key stroke, the alarm type, stand-by action, energized/de-energized, and latch comprise one parameter.
D2833	VT1_L1	PV velocity alarm time setpoint 1	
D2834	VT2_L1	PV velocity alarm time setpoint 2	
D2835	VT3_L1	PV velocity alarm time setpoint 3	
D2836 to D2840			1 to 5999 (second)

Register No.	Description		Range and meaning of value
D2841	HY1_L1	Alarm-1 hysteresis	Set a display value of setpoint of hysteresis. -19999 to 30000 (Set a value within the input range.) Decimal point position depends on the input type.
D2842	HY2_L1	Alarm-2 hysteresis	
D2843	HY3_L1	Alarm-3 hysteresis	
D2844 to D2848			
D2849	DYN1_L1	Alarm-1 On-delay timer	An alarm output is ON when the delay timer expires after the alarm setpoint is reached. 0 to 5999 (second)
D2850	DYN2_L1	Alarm-2 On-delay timer	
D2851	DYN3_L1	Alarm-3 On-delay timer	
D2852 to D2856			
D2857	DYF1_L1	Alarm-1 Off-delay timer	An alarm output is OFF when the delay timer expires after the alarm setpoint is reached. 0 to 5999 (second)
D2858	DYF2_L1	Alarm-2 Off-delay timer	
D2859	DYF3_L1	Alarm-3 Off-delay timer	
D2860 to D2900			

PV-related Setting (D2901 to D3000)

Register No.	Description		Range and meaning of value
D2901	BS_L1	PV input bias	-100.0 to 100.0% of PV input range span (EUS)
D2902	FL_L1	PV input filter	0: OFF (Disable) 1 to 120 s
D2903 to D2910			
D2911	HYS_L1	Limit control output hysteresis	0.0 to 100.0% of PV input span (EUS)
D2912 to D3000			

Free Area (D3001 to D5000)

Register No.	Description		Range and meaning of value
D3001 to D5000	Free area		

12.4 UT35A-L D Registers

12.4.3 Setup Parameters (D5001 to D7000)

Setup parameter									
Control function setting (Menu: CTL)									
D-Reg No.	Ref. No.	H No.	Register symbol	R/W	D-Reg No.	Ref. No.	H No.	Register symbol	R/W
				UT35A-L					UT35A-L
D5001	45001	1388			D5051	45051	13BA		
D5002	45002	1389			D5052	45052	13BB		
D5003	45003	138A			D5053	45053	13BC		
D5004	45004	138B			D5054	45054	13BD		
D5005	45005	138C			D5055	45055	13BE		
D5006	45006	138D			D5056	45056	13BF		
D5007	45007	138E			D5057	45057	13C0		
D5008	45008	138F			D5058	45058	13C1		
D5009	45009	1390			D5059	45059	13C2		
D5010	45010	1391			D5060	45060	13C3		
D5011	45011	1392			D5061	45061	13C4		
D5012	45012	1393			D5062	45062	13C5		
D5013	45013	1394			D5063	45063	13C6		
D5014	45014	1395			D5064	45064	13C7		
D5015	45015	1396			D5065	45065	13C8		
D5016	45016	1397			D5066	45066	13C9		
D5017	45017	1398			D5067	45067	13CA		
D5018	45018	1399			D5068	45068	13CB		
D5019	45019	139A			D5069	45069	13CC		
D5020	45020	139B			D5070	45070	13CD		
D5021	45021	139C	HI,LO	R/W	D5071	45071	13CE		
D5022	45022	139D	CNF	R/W	D5072	45072	13CF		
D5023	45023	139E			D5073	45073	13D0		
D5024	45024	139F			D5074	45074	13D1		
D5025	45025	13A0			D5075	45075	13D2		
D5026	45026	13A1			D5076	45076	13D3		
D5027	45027	13A2			D5077	45077	13D4		
D5028	45028	13A3			D5078	45078	13D5		
D5029	45029	13A4			D5079	45079	13D6		
D5030	45030	13A5			D5080	45080	13D7		
D5031	45031	13A6			D5081	45081	13D8		
D5032	45032	13A7			D5082	45082	13D9		
D5033	45033	13A8			D5083	45083	13DA		
D5034	45034	13A9			D5084	45084	13DB		
D5035	45035	13AA			D5085	45085	13DC		
D5036	45036	13AB			D5086	45086	13DD		
D5037	45037	13AC			D5087	45087	13DE		
D5038	45038	13AD			D5088	45088	13DF		
D5039	45039	13AE			D5089	45089	13E0		
D5040	45040	13AF			D5090	45090	13E1		
D5041	45041	13B0			D5091	45091	13E2		
D5042	45042	13B1			D5092	45092	13E3		
D5043	45043	13B2			D5093	45093	13E4		
D5044	45044	13B3			D5094	45094	13E5		
D5045	45045	13B4			D5095	45095	13E6		
D5046	45046	13B5			D5096	45096	13E7		
D5047	45047	13B6			D5097	45097	13E8		
D5048	45048	13B7			D5098	45098	13E9		
D5049	45049	13B8			D5099	45099	13EA		
D5050	45050	13B9			D5100	45100	13EB		

Setup parameter									
Input setting (PV input setting menu: PV)									
D-Reg No.	Ref. No.	H No.	Register symbol	R/W	D-Reg No.	Ref. No.	H No.	Register symbol	R/W
				UT35A-L					UT35A-L
D5101	45101	13EC	IN	R/W	D5151	45151	141E		
D5102	45102	13ED	UNIT	R/W	D5152	45152	141F		
D5103	45103	13EE	DP	R	D5153	45153	1420		
D5104	45104	13EF	RH	R/W	D5154	45154	1421		
D5105	45105	13F0	RL	R/W	D5155	45155	1422		
D5106	45106	13F1	SDP	R/W	D5156	45156	1423		
D5107	45107	13F2	SH	R/W	D5157	45157	1424		
D5108	45108	13F3	SL	R/W	D5158	45158	1425		
D5109	45109	13F4	BSL	R/W	D5159	45159	1426		
D5110	45110	13F5	RJC	R/W	D5160	45160	1427		
D5111	45111	13F6	ERJC	R/W	D5161	45161	1428		
D5112	45112	13F7	A.BS	R/W	D5162	45162	1429		
D5113	45113	13F8	A.FL	R/W	D5163	45163	142A		
D5114	45114	13F9			D5164	45164	142B		
D5115	45115	13FA			D5165	45165	142C		
D5116	45116	13FB			D5166	45166	142D		
D5117	45117	13FC			D5167	45167	142E		
D5118	45118	13FD			D5168	45168	142F		
D5119	45119	13FE			D5169	45169	1430		
D5120	45120	13FF			D5170	45170	1431		
D5121	45121	1400			D5171	45171	1432		
D5122	45122	1401			D5172	45172	1433		
D5123	45123	1402			D5173	45173	1434		
D5124	45124	1403			D5174	45174	1435		
D5125	45125	1404			D5175	45175	1436		
D5126	45126	1405			D5176	45176	1437		
D5127	45127	1406			D5177	45177	1438		
D5128	45128	1407			D5178	45178	1439		
D5129	45129	1408			D5179	45179	143A		
D5130	45130	1409			D5180	45180	143B		
D5131	45131	140A			D5181	45181	143C		
D5132	45132	140B			D5182	45182	143D		
D5133	45133	140C			D5183	45183	143E		
D5134	45134	140D			D5184	45184	143F		
D5135	45135	140E			D5185	45185	1440		
D5136	45136	140F			D5186	45186	1441		
D5137	45137	1410			D5187	45187	1442		
D5138	45138	1411			D5188	45188	1443		
D5139	45139	1412			D5189	45189	1444		
D5140	45140	1413			D5190	45190	1445		
D5141	45141	1414			D5191	45191	1446		
D5142	45142	1415			D5192	45192	1447		
D5143	45143	1416			D5193	45193	1448		
D5144	45144	1417			D5194	45194	1449		
D5145	45145	1418			D5195	45195	144A		
D5146	45146	1419			D5196	45196	144B		
D5147	45147	141A			D5197	45197	144C		
D5148	45148	141B			D5198	45198	144D		
D5149	45149	141C			D5199	45199	144E		
D5150	45150	141D			D5200	45200	144F		

12.4 UT35A-L D Registers

Setup parameter									
Input setting (Input range-SP limiter setting parameters menu: MPV)									
D-Reg No.	Ref. No.	H No.	Register symbol	R/W	D-Reg No.	Ref. No.	H No.	Register symbol	R/W
				UT35A-L					UT35A-L
D5201	45201	1450	P.UNI_L1	R/W	D5251	45251	1482		
D5202	45202	1451	P.DP_L1	R/W	D5252	45252	1483		
D5203	45203	1452	P.RH_L1	R/W	D5253	45253	1484		
D5204	45204	1453	P.RL_L1	R/W	D5254	45254	1485		
D5205	45205	1454			D5255	45255	1486		
D5206	45206	1455			D5256	45256	1487		
D5207	45207	1456			D5257	45257	1488		
D5208	45208	1457			D5258	45258	1489		
D5209	45209	1458			D5259	45259	148A		
D5210	45210	1459	SPH_L1	R/W	D5260	45260	148B		
D5211	45211	145A	SPL_L1	R/W	D5261	45261	148C		
D5212	45212	145B			D5262	45262	148D		
D5213	45213	145C			D5263	45263	148E		
D5214	45214	145D			D5264	45264	148F		
D5215	45215	145E			D5265	45265	1490		
D5216	45216	145F			D5266	45266	1491		
D5217	45217	1460			D5267	45267	1492		
D5218	45218	1461			D5268	45268	1493		
D5219	45219	1462			D5269	45269	1494		
D5220	45220	1463			D5270	45270	1495		
D5221	45221	1464			D5271	45271	1496		
D5222	45222	1465			D5272	45272	1497		
D5223	45223	1466			D5273	45273	1498		
D5224	45224	1467			D5274	45274	1499		
D5225	45225	1468			D5275	45275	149A		
D5226	45226	1469			D5276	45276	149B		
D5227	45227	146A			D5277	45277	149C		
D5228	45228	146B			D5278	45278	149D		
D5229	45229	146C			D5279	45279	149E		
D5230	45230	146D			D5280	45280	149F		
D5231	45231	146E			D5281	45281	14A0		
D5232	45232	146F			D5282	45282	14A1		
D5233	45233	1470			D5283	45283	14A2		
D5234	45234	1471			D5284	45284	14A3		
D5235	45235	1472			D5285	45285	14A4		
D5236	45236	1473			D5286	45286	14A5		
D5237	45237	1474			D5287	45287	14A6		
D5238	45238	1475			D5288	45288	14A7		
D5239	45239	1476			D5289	45289	14A8		
D5240	45240	1477			D5290	45290	14A9		
D5241	45241	1478			D5291	45291	14AA		
D5242	45242	1479			D5292	45292	14AB		
D5243	45243	147A			D5293	45293	14AC		
D5244	45244	147B			D5294	45294	14AD		
D5245	45245	147C			D5295	45295	14AE		
D5246	45246	147D			D5296	45296	14AF		
D5247	45247	147E			D5297	45297	14B0		
D5248	45248	147F			D5298	45298	14B1		
D5249	45249	1480			D5299	45299	14B2		
D5250	45250	1481			D5300	45300	14B3		

Setup parameter									
Output setting (Menu: OUT)									
D-Reg No.	Ref. No.	H No.	Register symbol	R/W	D-Reg No.	Ref. No.	H No.	Register symbol	R/W
				UT35A-L					UT35A-L
D5301	45301	14B4			D5351	45351	14E6		
D5302	45302	14B5			D5352	45352	14E7		
D5303	45303	14B6			D5353	45353	14E8		
D5304	45304	14B7			D5354	45354	14E9		
D5305	45305	14B8			D5355	45355	14EA		
D5306	45306	14B9			D5356	45356	14EB		
D5307	45307	14BA			D5357	45357	14EC		
D5308	45308	14BB			D5358	45358	14ED		
D5309	45309	14BC			D5359	45359	14EE		
D5310	45310	14BD			D5360	45360	14EF		
D5311	45311	14BE			D5361	45361	14F0		
D5312	45312	14BF			D5362	45362	14F1		
D5313	45313	14C0			D5363	45363	14F2		
D5314	45314	14C1			D5364	45364	14F3		
D5315	45315	14C2			D5365	45365	14F4		
D5316	45316	14C3			D5366	45366	14F5		
D5317	45317	14C4			D5367	45367	14F6		
D5318	45318	14C5			D5368	45368	14F7		
D5319	45319	14C6			D5369	45369	14F8		
D5320	45320	14C7			D5370	45370	14F9		
D5321	45321	14C8	RTS	R/W	D5371	45371	14FA		
D5322	45322	14C9	RTH	R/W	D5372	45372	14FB		
D5323	45323	14CA	RTL	R/W	D5373	45373	14FC		
D5324	45324	14CB			D5374	45374	14FD		
D5325	45325	14CC			D5375	45375	14FE		
D5326	45326	14CD			D5376	45376	14FF		
D5327	45327	14CE			D5377	45377	1500		
D5328	45328	14CF			D5378	45378	1501		
D5329	45329	14D0			D5379	45379	1502		
D5330	45330	14D1			D5380	45380	1503		
D5331	45331	14D2			D5381	45381	1504		
D5332	45332	14D3			D5382	45382	1505		
D5333	45333	14D4			D5383	45383	1506		
D5334	45334	14D5			D5384	45384	1507		
D5335	45335	14D6			D5385	45385	1508		
D5336	45336	14D7			D5386	45386	1509		
D5337	45337	14D8			D5387	45387	150A		
D5338	45338	14D9			D5388	45388	150B		
D5339	45339	14DA			D5389	45389	150C		
D5340	45340	14DB			D5390	45390	150D		
D5341	45341	14DC			D5391	45391	150E		
D5342	45342	14DD			D5392	45392	150F		
D5343	45343	14DE	RET.A	R/W	D5393	45393	1510		
D5344	45344	14DF			D5394	45394	1511		
D5345	45345	14E0			D5395	45395	1512		
D5346	45346	14E1			D5396	45396	1513		
D5347	45347	14E2			D5397	45397	1514		
D5348	45348	14E3			D5398	45398	1515		
D5349	45349	14E4			D5399	45399	1516		
D5350	45350	14E5			D5400	45400	1517		

D5401 to D5500: Free area

12.4 UT35A-L D Registers

Setup parameter									
Communication setting (RS-485 communication setting menu: R485) (Ethernet communication setting menu: ETHR)									
D-Reg No.	Ref. No.	H No.	Register symbol	R/W	D-Reg No.	Ref. No.	H No.	Register symbol	R/W
				UT35A-L					UT35A-L
D5501	45501	157C			D5551	45551	15AE	SM4_E3	R/W
D5502	45502	157D			D5552	45552	15AF	DG1_E3	R/W
D5503	45503	157E			D5553	45553	15B0	DG2_E3	R/W
D5504	45504	157F			D5554	45554	15B1	DG3_E3	R/W
D5505	45505	1580			D5555	45555	15B2	DG4_E3	R/W
D5506	45506	1581			D5556	45556	15B3	PRT_E3	R/W
D5507	45507	1582			D5557	45557	15B4	IPAR_E3	R/W
D5508	45508	1583			D5558	45558	15B5	1.IP1_E3	R/W
D5509	45509	1584			D5559	45559	15B6	1.IP2_E3	R/W
D5510	45510	1585			D5560	45560	15B7	1.IP3_E3	R/W
D5511	45511	1586			D5561	45561	15B8	1.IP4_E3	R/W
D5512	45512	1587			D5562	45562	15B9	2.IP1_E3	R/W
D5513	45513	1588			D5563	45563	15BA	2.IP2_E3	R/W
D5514	45514	1589			D5564	45564	15BB	2.IP3_E3	R/W
D5515	45515	158A			D5565	45565	15BC	2.IP4_E3	R/W
D5516	45516	158B			D5566	45566	15BD	ESW_E3	R/W
D5517	45517	158C			D5567	45567	15BE		
D5518	45518	158D			D5568	45568	15BF		
D5519	45519	158E			D5569	45569	15C0		
D5520	45520	158F			D5570	45570	15C1		
D5521	45521	1590	PSL_E3	R/W	D5571	45571	15C2	MAC1_E3	R
D5522	45522	1591	BPS_E3	R/W	D5572	45572	15C3	MAC2_E3	R
D5523	45523	1592	PRI_E3	R/W	D5573	45573	15C4	MAC3_E3	R
D5524	45524	1593	STP_E3	R/W	D5574	45574	15C5		
D5525	45525	1594	DLN_E3	R/W	D5575	45575	15C6		
D5526	45526	1595	ADR_E3	R/W	D5576	45576	15C7		
D5527	45527	1596	RP.T_E3	R/W	D5577	45577	15C8		
D5528	45528	1597			D5578	45578	15C9		
D5529	45529	1598			D5579	45579	15CA		
D5530	45530	1599			D5580	45580	15CB		
D5531	45531	159A			D5581	45581	15CC		
D5532	45532	159B			D5582	45582	15CD		
D5533	45533	159C			D5583	45583	15CE		
D5534	45534	159D			D5584	45584	15CF		
D5535	45535	159E			D5585	45585	15D0		
D5536	45536	159F			D5586	45586	15D1		
D5537	45537	15A0			D5587	45587	15D2		
D5538	45538	15A1			D5588	45588	15D3		
D5539	45539	15A2			D5589	45589	15D4		
D5540	45540	15A3			D5590	45590	15D5		
D5541	45541	15A4	HSR_E3	R/W	D5591	45591	15D6		
D5542	45542	15A5	BPS_E3	R/W	D5592	45592	15D7		
D5543	45543	15A6	PRI_E3	R/W	D5593	45593	15D8		
D5544	45544	15A7	IP1_E3	R/W	D5594	45594	15D9		
D5545	45545	15A8	IP2_E3	R/W	D5595	45595	15DA		
D5546	45546	15A9	IP3_E3	R/W	D5596	45596	15DB		
D5547	45547	15AA	IP4_E3	R/W	D5597	45597	15DC		
D5548	45548	15AB	SM1_E3	R/W	D5598	45598	15DD		
D5549	45549	15AC	SM2_E3	R/W	D5599	45599	15DE		
D5550	45550	15AD	SM3_E3	R/W	D5600	45600	15DF		

D5601 to D5700: Free area

Setup parameter									
Key operation setting (Menu: KEY), Display function setting (Menu: DISP)									
D-Reg No.	Ref. No.	H No.	Register symbol	R/W	D-Reg No.	Ref. No.	H No.	Register symbol	R/W
				UT35A-L					UT35A-L
D5701	45701	1644	F1-K *1	R/W	D5751	45751	1676	B.STS	R/W
D5702	45702	1645	F2-K *1	R/W	D5752	45752	1677		
D5703	45703	1646	Fn-K *1	R/W	D5753	45753	1678	D.CYC	R/W
D5704	45704	1647			D5754	45754	1679	OP.JP	R/W
D5705	45705	1648			D5755	45755	167A	MLSD	R/W
D5706	45706	1649			D5756	45756	167B		
D5707	45707	164A			D5757	45757	167C		
D5708	45708	164B			D5758	45758	167D		
D5709	45709	164C			D5759	45759	167E		
D5710	45710	164D			D5760	45760	167F		
D5711	45711	164E			D5761	45761	1680		
D5712	45712	164F			D5762	45762	1681		
D5713	45713	1650	PCMD_L1	R/W	D5763	45763	1682		
D5714	45714	1651	PCH_L1	R/W	D5764	45764	1683		
D5715	45715	1652	PCL_L1	R/W	D5765	45765	1684		
D5716	45716	1653			D5766	45766	1685		
D5717	45717	1654			D5767	45767	1686		
D5718	45718	1655			D5768	45768	1687		
D5719	45719	1656			D5769	45769	1688		
D5720	45720	1657			D5770	45770	1689		
D5721	45721	1658			D5771	45771	168A		
D5722	45722	1659			D5772	45772	168B		
D5723	45723	165A			D5773	45773	168C		
D5724	45724	165B			D5774	45774	168D		
D5725	45725	165C			D5775	45775	168E		
D5726	45726	165D			D5776	45776	168F		
D5727	45727	165E			D5777	45777	1690		
D5728	45728	165F			D5778	45778	1691		
D5729	45729	1660			D5779	45779	1692		
D5730	45730	1661			D5780	45780	1693		
D5731	45731	1662			D5781	45781	1694		
D5732	45732	1663			D5782	45782	1695		
D5733	45733	1664			D5783	45783	1696		
D5734	45734	1665			D5784	45784	1697		
D5735	45735	1666			D5785	45785	1698		
D5736	45736	1667			D5786	45786	1699		
D5737	45737	1668			D5787	45787	169A		
D5738	45738	1669			D5788	45788	169B		
D5739	45739	166A			D5789	45789	169C		
D5740	45740	166B			D5790	45790	169D		
D5741	45741	166C			D5791	45791	169E		
D5742	45742	166D	SPD	R/W	D5792	45792	169F		
D5743	45743	166E	GUID	R/W	D5793	45793	16A0		
D5744	45744	166F	HOME	R/W	D5794	45794	16A1		
D5745	45745	1670	ECO	R/W	D5795	45795	16A2		
D5746	45746	1671	BRI	R/W	D5796	45796	16A3		
D5747	45747	1672	B.PVW	R/W	D5797	45797	16A4		
D5748	45748	1673	B.PVR	R/W	D5798	45798	16A5		
D5749	45749	1674	B.SP	R/W	D5799	45799	16A6		
D5750	45750	1675	B.BAR	R/W	D5800	45800	16A7		

*1: Same parameter exists in other menu. "-K" is added to the end of the parameter in KEY menu.

12.4 UT35A-L D Registers

Setup parameter									
Lock setting (Key lock setting menu: KLOC) (Menu lock setting menu: MLOC)									
D-Reg No.	Ref. No.	H No.	Register symbol	R/W	D-Reg No.	Ref. No.	H No.	Register symbol	R/W
				UT35A-L					UT35A-L
D5801	45801	16A8			D5851	45851	16DA	DI.SL-L *1	R/W
D5802	45802	16A9			D5852	45852	16DB		
D5803	45803	16AA			D5853	45853	16DC		
D5804	45804	16AB			D5854	45854	16DD		
D5805	45805	16AC			D5855	45855	16DE		
D5806	45806	16AD			D5856	45856	16DF		
D5807	45807	16AE			D5857	45857	16E0		
D5808	45808	16AF			D5858	45858	16E1		
D5809	45809	16B0			D5859	45859	16E2		
D5810	45810	16B1			D5860	45860	16E3		
D5811	45811	16B2			D5861	45861	16E4		
D5812	45812	16B3			D5862	45862	16E5		
D5813	45813	16B4			D5863	45863	16E6	I/O-L *1	R/W
D5814	45814	16B5			D5864	45864	16E7	SYS-L *1	R/W
D5815	45815	16B6			D5865	45865	16E8	INIT-L *1	R/W
D5816	45816	16B7			D5866	45866	16E9	VER-L *1	R/W
D5817	45817	16B8			D5867	45867	16EA	LVL-L *1	R/W
D5818	45818	16B9	COM.W	R/W	D5868	45868	16EB		
D5819	45819	16BA	DATA-L *1	R/W	D5869	45869	16EC		
D5820	45820	16BB			D5870	45870	16ED	SP_L1-L *1	R/W
D5821	45821	16BC			D5871	45871	16EE	SPS_L1-L *1	R/W
D5822	45822	16BD			D5872	45872	16EF	ALRM_L1-L *1	R/W
D5823	45823	16BE			D5873	45873	16F0		
D5824	45824	16BF			D5874	45874	16F1	PVS_L1-L *1	R/W
D5825	45825	16C0			D5875	45875	16F2		
D5826	45826	16C1			D5876	45876	16F3		
D5827	45827	16C2			D5877	45877	16F4		
D5828	45828	16C3			D5878	45878	16F5		
D5829	45829	16C4			D5879	45879	16F6		
D5830	45830	16C5			D5880	45880	16F7		
D5831	45831	16C6	CTL-L *1	R/W	D5881	45881	16F8		
D5832	45832	16C7	PV-L *1	R/W	D5882	45882	16F9		
D5833	45833	16C8			D5883	45883	16FA		
D5834	45834	16C9			D5884	45884	16FB		
D5835	45835	16CA			D5885	45885	16FC		
D5836	45836	16CB	MPV_L1-L *1	R/W	D5886	45886	16FD		
D5837	45837	16CC			D5887	45887	16FE		
D5838	45838	16CD	OUT-L *1	R/W	D5888	45888	16FF		
D5839	45839	16CE			D5889	45889	1700		
D5840	45840	16CF			D5890	45890	1701		
D5841	45841	16D0	R485_E3-L *1	R/W	D5891	45891	1702		
D5842	45842	16D1			D5892	45892	1703		
D5843	45843	16D2	ETHR_E3-L *1	R/W	D5893	45893	1704		
D5844	45844	16D3			D5894	45894	1705		
D5845	45845	16D4			D5895	45895	1706		
D5846	45846	16D5			D5896	45896	1707		
D5847	45847	16D6	KEY-L *1	R/W	D5897	45897	1708		
D5848	45848	16D7	DISP-L *1	R/W	D5898	45898	1709		
D5849	45849	16D8			D5899	45899	170A		
D5850	45850	16D9	KLOC-L *1	R/W	D5900	45900	170B		

*1: Same parameter exists in other menu. "-L" is added to the end of the parameter in KLOC menu or MLOC menu.

Setup parameter									
DI function setting (DI function registration menu: DI.SL)									
D-Reg No.	Ref. No.	H No.	Register symbol	R/W	D-Reg No.	Ref. No.	H No.	Register symbol	R/W
				UT35A-L					UT35A-L
D5901	45901	170C			D5951	45951	173E		
D5902	45902	170D			D5952	45952	173F		
D5903	45903	170E			D5953	45953	1740		
D5904	45904	170F			D5954	45954	1741		
D5905	45905	1710			D5955	45955	1742		
D5906	45906	1711			D5956	45956	1743		
D5907	45907	1712			D5957	45957	1744		
D5908	45908	1713			D5958	45958	1745		
D5909	45909	1714			D5959	45959	1746		
D5910	45910	1715			D5960	45960	1747		
D5911	45911	1716			D5961	45961	1748		
D5912	45912	1717			D5962	45962	1749		
D5913	45913	1718			D5963	45963	174A		
D5914	45914	1719			D5964	45964	174B		
D5915	45915	171A			D5965	45965	174C		
D5916	45916	171B			D5966	45966	174D		
D5917	45917	171C			D5967	45967	174E		
D5918	45918	171D			D5968	45968	174F		
D5919	45919	171E			D5969	45969	1750		
D5920	45920	171F			D5970	45970	1751		
D5921	45921	1720			D5971	45971	1752		
D5922	45922	1721			D5972	45972	1753		
D5923	45923	1722			D5973	45973	1754		
D5924	45924	1723			D5974	45974	1755		
D5925	45925	1724			D5975	45975	1756		
D5926	45926	1725			D5976	45976	1757		
D5927	45927	1726			D5977	45977	1758		
D5928	45928	1727			D5978	45978	1759		
D5929	45929	1728			D5979	45979	175A		
D5930	45930	1729			D5980	45980	175B		
D5931	45931	172A			D5981	45981	175C		
D5932	45932	172B			D5982	45982	175D		
D5933	45933	172C			D5983	45983	175E		
D5934	45934	172D			D5984	45984	175F		
D5935	45935	172E			D5985	45985	1760		
D5936	45936	172F			D5986	45986	1761		
D5937	45937	1730			D5987	45987	1762		
D5938	45938	1731			D5988	45988	1763		
D5939	45939	1732			D5989	45989	1764		
D5940	45940	1733	DI2.S	R/W	D5990	45990	1765		
D5941	45941	1734			D5991	45991	1766		
D5942	45942	1735			D5992	45992	1767		
D5943	45943	1736			D5993	45993	1768		
D5944	45944	1737			D5994	45994	1769		
D5945	45945	1738			D5995	45995	176A		
D5946	45946	1739			D5996	45996	176B		
D5947	45947	173A			D5997	45997	176C		
D5948	45948	173B			D5998	45998	176D		
D5949	45949	173C			D5999	45999	176E		
D5950	45950	173D			D6000	46000	176F		

12.4 UT35A-L D Registers

Setup parameter									
DI function setting (Message)									
D-Reg No.	Ref. No.	H No.	Register symbol	R/W	D-Reg No.	Ref. No.	H No.	Register symbol	R/W
				UT35A-L					UT35A-L
D6001	46001	1770	MSG1	R/W	D6051	46051	17A2	MSG3	R/W
D6002	46002	1771	MSG1	R/W	D6052	46052	17A3		
D6003	46003	1772	MSG1	R/W	D6053	46053	17A4		
D6004	46004	1773	MSG1	R/W	D6054	46054	17A5		
D6005	46005	1774	MSG1	R/W	D6055	46055	17A6		
D6006	46006	1775	MSG1	R/W	D6056	46056	17A7		
D6007	46007	1776	MSG1	R/W	D6057	46057	17A8		
D6008	46008	1777	MSG1	R/W	D6058	46058	17A9		
D6009	46009	1778	MSG1	R/W	D6059	46059	17AA		
D6010	46010	1779	MSG1	R/W	D6060	46060	17AB		
D6011	46011	177A	MSG1	R/W	D6061	46061	17AC	MSG4	R/W
D6012	46012	177B			D6062	46062	17AD	MSG4	R/W
D6013	46013	177C			D6063	46063	17AE	MSG4	R/W
D6014	46014	177D			D6064	46064	17AF	MSG4	R/W
D6015	46015	177E			D6065	46065	17B0	MSG4	R/W
D6016	46016	177F			D6066	46066	17B1	MSG4	R/W
D6017	46017	1780			D6067	46067	17B2	MSG4	R/W
D6018	46018	1781			D6068	46068	17B3	MSG4	R/W
D6019	46019	1782			D6069	46069	17B4	MSG4	R/W
D6020	46020	1783			D6070	46070	17B5	MSG4	R/W
D6021	46021	1784	MSG2	R/W	D6071	46071	17B6	MSG4	R/W
D6022	46022	1785	MSG2	R/W	D6072	46072	17B7		
D6023	46023	1786	MSG2	R/W	D6073	46073	17B8		
D6024	46024	1787	MSG2	R/W	D6074	46074	17B9		
D6025	46025	1788	MSG2	R/W	D6075	46075	17BA		
D6026	46026	1789	MSG2	R/W	D6076	46076	17BB		
D6027	46027	178A	MSG2	R/W	D6077	46077	17BC		
D6028	46028	178B	MSG2	R/W	D6078	46078	17BD		
D6029	46029	178C	MSG2	R/W	D6079	46079	17BE		
D6030	46030	178D	MSG2	R/W	D6080	46080	17BF		
D6031	46031	178E	MSG2	R/W	D6081	46081	17C0		
D6032	46032	178F			D6082	46082	17C1		
D6033	46033	1790			D6083	46083	17C2		
D6034	46034	1791			D6084	46084	17C3		
D6035	46035	1792			D6085	46085	17C4		
D6036	46036	1793			D6086	46086	17C5		
D6037	46037	1794			D6087	46087	17C6		
D6038	46038	1795			D6088	46088	17C7		
D6039	46039	1796			D6089	46089	17C8		
D6040	46040	1797			D6090	46090	17C9		
D6041	46041	1798	MSG3	R/W	D6091	46091	17CA		
D6042	46042	1799	MSG3	R/W	D6092	46092	17CB		
D6043	46043	179A	MSG3	R/W	D6093	46093	17CC		
D6044	46044	179B	MSG3	R/W	D6094	46094	17CD		
D6045	46045	179C	MSG3	R/W	D6095	46095	17CE		
D6046	46046	179D	MSG3	R/W	D6096	46096	17CF		
D6047	46047	179E	MSG3	R/W	D6097	46097	17D0		
D6048	46048	179F	MSG3	R/W	D6098	46098	17D1		
D6049	46049	17A0	MSG3	R/W	D6099	46099	17D2		
D6050	46050	17A1	MSG3	R/W	D6100	46100	17D3		

D6101 to D6300: Free area

Setup parameter									
I/O display (Menu: I/O)									
D-Reg No.	Ref. No.	H No.	Register symbol	R/W	D-Reg No.	Ref. No.	H No.	Register symbol	R/W
				UT35A-L					UT35A-L
D6301	46301	189C	KEY-IO *1	R	D6351	46351	18CE		
D6302	46302	189D			D6352	46352	18CF		
D6303	46303	189E			D6353	46353	18D0		
D6304	46304	189F			D6354	46354	18D1		
D6305	46305	18A0			D6355	46355	18D2		
D6306	46306	18A1			D6356	46356	18D3		
D6307	46307	18A2			D6357	46357	18D4		
D6308	46308	18A3			D6358	46358	18D5		
D6309	46309	18A4			D6359	46359	18D6		
D6310	46310	18A5			D6360	46360	18D7		
D6311	46311	18A6			D6361	46361	18D8		
D6312	46312	18A7			D6362	46362	18D9		
D6313	46313	18A8			D6363	46363	18DA		
D6314	46314	18A9			D6364	46364	18DB		
D6315	46315	18AA			D6365	46365	18DC		
D6316	46316	18AB			D6366	46366	18DD		
D6317	46317	18AC			D6367	46367	18DE		
D6318	46318	18AD			D6368	46368	18DF		
D6319	46319	18AE			D6369	46369	18E0		
D6320	46320	18AF			D6370	46370	18E1		
D6321	46321	18B0			D6371	46371	18E2		
D6322	46322	18B1			D6372	46372	18E3		
D6323	46323	18B2			D6373	46373	18E4		
D6324	46324	18B3			D6374	46374	18E5		
D6325	46325	18B4			D6375	46375	18E6		
D6326	46326	18B5			D6376	46376	18E7		
D6327	46327	18B6			D6377	46377	18E8		
D6328	46328	18B7			D6378	46378	18E9		
D6329	46329	18B8			D6379	46379	18EA		
D6330	46330	18B9			D6380	46380	18EB		
D6331	46331	18BA			D6381	46381	18EC		
D6332	46332	18BB			D6382	46382	18ED		
D6333	46333	18BC			D6383	46383	18EE		
D6334	46334	18BD			D6384	46384	18EF		
D6335	46335	18BE			D6385	46385	18F0		
D6336	46336	18BF			D6386	46386	18F1		
D6337	46337	18C0			D6387	46387	18F2		
D6338	46338	18C1			D6388	46388	18F3		
D6339	46339	18C2			D6389	46389	18F4		
D6340	46340	18C3			D6390	46390	18F5		
D6341	46341	18C4			D6391	46391	18F6		
D6342	46342	18C5			D6392	46392	18F7		
D6343	46343	18C6			D6393	46393	18F8		
D6344	46344	18C7			D6394	46394	18F9		
D6345	46345	18C8			D6395	46395	18FA		
D6346	46346	18C9			D6396	46396	18FB		
D6347	46347	18CA			D6397	46397	18FC		
D6348	46348	18CB			D6398	46398	18FD		
D6349	46349	18CC			D6399	46399	18FE		
D6350	46350	18CD			D6400	46400	18FF		

*1: Same parameter exists in other menu. "-IO" is added to the end of the parameter in I/O menu.

12.4 UT35A-L D Registers

Setup parameter									
System setting (Menu: SYS)									
D-Reg No.	Ref. No.	H No.	Register symbol	R/W	D-Reg No.	Ref. No.	H No.	Register symbol	R/W
				UT35A-L					UT35A-L
D6401	46401	1900			D6451	46451	1932		
D6402	46402	1901			D6452	46452	1933		
D6403	46403	1902	R.MD	R/W	D6453	46453	1934		
D6404	46404	1903			D6454	46454	1935		
D6405	46405	1904			D6455	46455	1936		
D6406	46406	1905			D6456	46456	1937		
D6407	46407	1906			D6457	46457	1938		
D6408	46408	1907			D6458	46458	1939		
D6409	46409	1908	C.GRN	R/W	D6459	46459	193A		
D6410	46410	1909	FREQ	R/W	D6460	46460	193B		
D6411	46411	190A			D6461	46461	193C		
D6412	46412	190B			D6462	46462	193D		
D6413	46413	190C			D6463	46463	193E		
D6414	46414	190D			D6464	46464	193F		
D6415	46415	190E			D6465	46465	1940		
D6416	46416	190F			D6466	46466	1941		
D6417	46417	1910	QSM	R/W	D6467	46467	1942		
D6418	46418	1911			D6468	46468	1943		
D6419	46419	1912			D6469	46469	1944		
D6420	46420	1913			D6470	46470	1945		
D6421	46421	1914	U.DEF	R/W	D6471	46471	1946		
D6422	46422	1915			D6472	46472	1947		
D6423	46423	1916	F.DEF	R/W	D6473	46473	1948		
D6424	46424	1917			D6474	46474	1949		
D6425	46425	1918			D6475	46475	194A		
D6426	46426	1919			D6476	46476	194B		
D6427	46427	191A			D6477	46477	194C		
D6428	46428	191B			D6478	46478	194D		
D6429	46429	191C			D6479	46479	194E		
D6430	46430	191D			D6480	46480	194F		
D6431	46431	191E	LEVL	R/W	D6481	46481	1950		
D6432	46432	191F			D6482	46482	1951		
D6433	46433	1920			D6483	46483	1952		
D6434	46434	1921			D6484	46484	1953		
D6435	46435	1922			D6485	46485	1954		
D6436	46436	1923			D6486	46486	1955		
D6437	46437	1924			D6487	46487	1956		
D6438	46438	1925			D6488	46488	1957		
D6439	46439	1926			D6489	46489	1958		
D6440	46440	1927			D6490	46490	1959		
D6441	46441	1928			D6491	46491	195A		
D6442	46442	1929			D6492	46492	195B		
D6443	46443	192A			D6493	46493	195C		
D6444	46444	192B			D6494	46494	195D		
D6445	46445	192C			D6495	46495	195E		
D6446	46446	192D			D6496	46496	195F		
D6447	46447	192E			D6497	46497	1960		
D6448	46448	192F			D6498	46498	1961		
D6449	46449	1930			D6499	46499	1962		
D6450	46450	1931			D6500	46500	1963		

D6501 to D7600: Free area

Control Function Setting (D5001 to D5100)

Register No.	Description	Range and meaning of value
D5001 to D5020		
D5021	HI.LO	Limit control type 0: LOW (Low limit control) 1: HIGH (High limit control)
D5022	CNF	The way of confirming operation 0: KEY (By key operation) 1: DI (By DI)
D5023 to D5100		

12.4 UT35A-L D Registers

Input Setting (D5101 to D5300)

Register No.		Description	Range and meaning of value
D5101	IN	PV input type	0: OFF (Disable) 1: K1 (-270.0 to 1370.0°C / -450.0 to 2500.0 F) 2: K2 (-270.0 to 1000.0°C / -450.0 to 2300.0 F) 3: K3 (-200.0 to 500.0°C / -200.0 to 1000.0 F) 4: J (-200.0 to 1200.0°C / -300.0 to 2300.0 F) 5: T1 (-270.0 to 400.0°C / -450.0 to 750.0 F) 6: T2 (0.0 to 400.0°C / -200.0 to 750.0 F) 7: B (0.0 to 1800.0°C / 32 to 3300 F) 8: S (0.0 to 1700.0°C / 32 to 3100 F) 9: R (0.0 to 1700.0°C / 32 to 3100 F) 10: N (-200.0 to 1300.0°C / -300.0 to 2400.0 F) 11: E (-270.0 to 1000.0°C / -450.0 to 1800.0 F) 12: L (-200.0 to 900.0°C / -300.0 to 1600.0 F) 13: U1 (-200.0 to 400.0°C / -300.0 to 750.0 F) 14: U2 (0.0 to 400.0°C / -200.0 to 1000.0 F) 15: W (0.0 to 2300.0°C / 32 to 4200 F) 16: PL2 (0.0 to 1390.0°C / 32.0 to 2500.0 F) 17: P2040 (0.0 to 1900.0°C / 32 to 3400 F) 18: WRE (0.0 to 2000.0°C / 32 to 3600 F) 30: JPT1 (-200.0 to 500.0°C / -300.0 to 1000.0 F) 31: JPT2 (-150.00 to 150.00°C / -200.0 to 300.0 F) 35: PT1 (-200.0 to 850.0°C / -300.0 to 1560.0 F) 36: PT2 (-200.0 to 500.0°C / -300.0 to 1000.0 F) 37: PT3 (-150.00 to 150.00°C / -200.0 to 300.0 F) 40: 0.4-2V (0.400 to 2.000 V) 41: 1-5V (1.000 to 5.000 V) 42: 4-20 (4.00 to 20.00 mA) 50: 0-2V (0.000 to 2.000 V) 51: 0-10V (0.00 to 10.00 V) 52: 0-20 (0.00 to 20.00 mA) 55: -1020 (-10.00 to 20.00 mV) 56: 0-100 (0.0 to 100.0 mV) *W: W-5% Re/W-26% Re(Hoskins Mfg. Co.), ASTM E988 WRE: W97Re3-W75Re25
D5102	UNIT	PV input unit	0, 2, 3, 4: - (No unit) 1: C (Degree Celsius) 5: F (Degree Fahrenheit)
D5103	DP	PV input decimal point position	0: No decimal place 1: One decimal place 2: Two decimal places 3: Three decimal places 4: Four decimal places
D5104	RH	Maximum value of PV input range	Depends on the input type. - For temperature input - Set the temperature range that is actually controlled. (RL<RH) - For voltage / current input - Set the range of a voltage / current signal that is applied. The scale across which the voltage / current signal is actually controlled should be set using the maximum value of input scale (SH) and minimum value of input scale (SL). (Input is always 0% when RL = RH.)
D5105	RL	Minimum value of PV input range	Same as D5103
D5106	SDP	PV input scale decimal point position	Same as D5103
D5107	SH	Maximum value of PV input scale	-19999 to 30000, (SL<SH), SH - SL ≤ 30000
D5108	SL	Minimum value of PV input scale	
D5109	BSL	PV input burnout action	0: OFF (Disable) 1: UP (Upscale) 2: DOWN (Downscale)
D5110	RJC	PV input reference junction compensation	0: OFF (RJC OFF) 1: ON (RJC ON)
D5111	ERJC	PV input external RJC setpoint	-10.0 to 60.0°C
D5112	A.BS	PV analog input bias	-100.0 to 100.0% of PV input range span (EUS)
D5113	A.FL	PV analog input filter	0: OFF 1 to 120 s
D5114 to D5200			

Register No.	Description		Range and meaning of value
D5201	P.UNI_L1	Control PV input unit	0, 2, 3, 4: - (No unit) 1: C (Degree Celsius) 5: F (Degree Fahrenheit)
D5202	P.DP_L1	Control PV input decimal point position	0: No decimal place 1: One decimal place 2: Two decimal places 3: Three decimal places 4: Four decimal places
D5203	P.RH_L1	Maximum value of control PV input range	-19999 to 30000, (P.RL<P.RH), P.RH - P.RL ≤ 30000
D5204	P.RL_L1	Minimum value of control PV input range	
D5205 to D5209			
D5210	SPH_L1	SP high limit	0.0 to 100.0% of PV input range (EU), (SPL<SPH)
D5211	SPL_L1	SP low limit	
D5210 to D5300			

Output Setting (D5301 to D5400)

Register No.	Description		Range and meaning of value
D5301 to D5320			
D5321	RTS	Retransmission output type of RET	0: OFF (Disable) 1: PV1 (PV) 2: SP1 (SP)

Register No.	Description		Range and meaning of value
D5322	RTH	Maximum value of retransmission output scale of RET	When RTS=1 (PV1) or 2 (SP1), RTL+1digit to 30000 Decimal point position: RTS=1 (PV1) or 2 (SP1): decimal point position is same as that of PV input.
D5323	RTL	Minimum value of retransmission output scale of RET	When RTS=1 (PV1) or 2 (SP1), -19999 to RTH-1digit Decimal point position: RTS=1 (PV1) or 2 (SP1): decimal point position is same as that of PV input.
D5324 to D5342			
D5343	RET.A	RET current output range	0: 4-20 (4 to 20 mA) 1: 0-20 (0 to 20 mA) 2: 20-4 (20 to 4 mA) 3: 20-0 (20 to 0 mA)
D5344 to D5400			

12.4 UT35A-L D Registers

Communication Setting (D5501 to D5700)

Register No.		Description	Range and meaning of value
D5501 ro D5520			
D5521	PSL_E3	Protocol selection	0: PCL (PC link communication) 1: PCLSM (PC link communication (with checksum)) 2: LADR (Ladder communication) 7: MBASC (Modbus (ASCII)) 8: MBRTU (Modbus (RTU))
D5522	BPS_E3	Baud rate	0: 600 (600 bps) 1: 1200 (1200 bps) 2: 2400 (2400 bps) 3: 4800 (4800 bps) 4: 9600 (9600 bps) 5: 19200 (19.2k bps) 6: 38400 (38.4k bps)
D5523	PRI_E3	Parity	0: NONE (None) 1: EVEN (Even) 2: ODD (Odd)
D5524	STP_E3	Stop bit	1: 1 bit, 2: 2 bit
D5525	DLN_E3	Data length	7: 7 bit, 8: 8 bit
D5526	ADR_E3	Address	1 to 99
D5527	RP.T_E3	Minimum response time	0 to 10 (x10ms)
D5528 to D5540			
D5541	HSR_E3	High-speed response mode	0: OFF, 1 to 8
D5542	BPS_E3	Baud rate	4: 9600 (9600 bps) 5: 19200 (19.2k bps) 6: 38400 (38.4k bps)
D5543	PRI_E3	Parity	0: NONE (None) 1: EVEN (Even) 2: ODD (Odd)
D5544	IP1_E3	IP address 1	0 to 255 Address : D5542.D5543.D5544.D5545
D5545	IP2_E3	IP address 2	
D5546	IP3_E3	IP address 3	
D5547	IP4_E3	IP address 4	
D5548	SM1_E3	Subnet mask 1	0 to 255 Address : D5546.D5547.D5548.D5549
D5549	SM2_E3	Subnet mask 2	
D5550	SM3_E3	Subnet mask 3	
D5551	SM4_E3	Subnet mask 4	

Register No.	Description		Range and meaning of value
D5552	DG1_E3	Default gateway 1	0 to 255 Address : D5550.D5551.D5552.D5553
D5553	DG2_E3	Default gateway 2	
D5554	DG3_E3	Default gateway 3	
D5555	DG4_E3	Default gateway 4	
D5556	PRT_E3	Port number	502, 1024 to 65535
D5557	IPAR_E3	IP access restriction	0: OFF (Disable) 1: ON (Enable)
D5558	1.IP1_E3	Permitted IP address 1-1	0 to 255 Address : D5556.D5557.D5558.D5559
D5559	1.IP2_E3	Permitted IP address 1-2	
D5560	1.IP3_E3	Permitted IP address 1-3	
D5561	1.IP4_E3	Permitted IP address 1-4	
D5562	2.IP1_E3	Permitted IP address 2-1	0 to 255 Address : D5560.D5561.D5562.D5563
D5563	2.IP2_E3	Permitted IP address 2-2	
D5564	2.IP3_E3	Permitted IP address 2-3	
D5565	2.IP4_E3	Permitted IP address 2-4	
D5566	ESW_E3	Ethernet setting switch	0: OFF 1: ON (Enable) Setting this parameter to "1: ON" enables the Ethernet communication parameter settings. * The parameter ESW automatically returns to "0: OFF" after "1: ON" is set.
D5567 to D5570			
D5571	MAC1_E3	MAC address 1 *1	0000 to FFFF (Hex) Arrangement: D5771, D5772, D5773
D5572	MAC2_E3	MAC address 2 *1	
D5573	MAC3_E3	MAC address 3 *1	
D5574 to D5700			

*1: With regards to the information on D5571 to D5573, three D registers comprise one parameter data.

12.4 UT35A-L D Registers

Key Operation Setting, Display Function Setting, and SELECT Display Setting (D5701 to D5800)

Register No.		Description	Range and meaning of value
D5701	F1-K	User function key-1 action setting	0: OFF (Disable) 18: LTUP (LCD brightness UP)
D5702	F2-K	User function key-2 action setting	19: LTDN (LCD brightness DOWN) 20: BRI (Adjust LCD brightness)
D5703	Fn-K	User function key-n action setting	21: LCD (LCD backlight ON/OFF switch) 22: LAT (Latch release)
D5704 to D5712			
D5713	PCMD_L1	Active color PV display switch	0: Fixed in white 1: Fixed in red 2: Link to alarm 1 (Alarm OFF: white, Alarm ON: red) 3: Link to alarm 1 (Alarm OFF: red, Alarm ON: white) 4: Link to alarm 1 or 2 (Alarm OFF: white, Alarm ON: red) 5: Link to alarm 1 or 2 (Alarm OFF: red, Alarm ON: white) 6: PV limit (Within range: white, Out of range: red) 7: PV limit (Within range: red, Out of range: white) 8: SP deviation (Within deviation: white, Out of deviation: red) 9: SP deviation (Within deviation: red, Out of deviation: white) 10: Link to DI2 (ON: red, OFF: white) (*) 11: Link to EXCEEDED lamp (Unlit: white, lit: red) 12: Link to OUT lamp (Unlit: white, lit: red) *: Set the parameter DI2.S=PVRW
D5714	PCH_L1	PV color change high limit	Set a display value when in PV limit or SP deviation.
D5715	PCL_L1	PV color change low limit	-19999 to 30000 (Set a value within the input range.) Decimal point position depends on the input type.
D5716 to D5741			
D5742	SPD	Scroll speed	(Slow) 1 to 8 (Quick)
D5743	GUID	Guide display ON/OFF	0: OFF (Nondisplay) 1: ON (Display)
D5744	HOME	Home Operation Display setting	23: PV (PV Display) 24: SP (SP Display)
D5745	ECO	Economy mode	0: OFF (Disable) 1: Economy mode ON (All indications except PV display OFF) 2: Economy mode ON (All indications OFF) 3: Brightness 10 % (whole indication)
D5746	BRI	Brightness	(Dark) 1 to 5 (Bright)
D5747	B.PVW	White brightness adjustment of PV display	Adjusts the white brightness of PV display. (Dark) -4 to 4 (Bright)
D5748	B.PVR	Red brightness adjustment of PV display	Adjusts the red brightness of PV display. (Dark) -4 to 4 (Bright)
D5749	B.SP	Brightness adjustment of Setpoint display	Adjusts the brightness of SP display. (Dark) -4 to 4 (Bright)
D5750	B.BAR	Brightness adjustment of Bar-graph display	Adjusts the brightness of EXCEEDED indicator and OUT indicator display. (Dark) -4 to 4 (Bright)
D5751	B.STS	Brightness adjustment of Status indicator	Adjusts the brightness of Status display. (Dark) -4 to 4 (Bright)
D5753	D.CYC	Display update cycle	1: 100 ms 2: 200 ms 3: 500 ms 4: 1 s 5: 2 s
D5754	OP.JP	AUTORETURN TO OPERATION DISPLAY	Automatically returned to the Operation Display when there has been no keystroke operation for 5 minutes. 0: OFF (Not automatically returned) 1: ON (Automatically returned)
D5755	MLSD	Least significant digital mask of PV display	0: OFF (With least significant digit) 1: ON (Without least significant digit)
D5756 to D5800			

*1: Same parameter exists in other menu. "-K" is added to the end of the parameter in KEY menu.

Lock Setting (Key Lock/Menu Lock) (D5801 to D5900)

Register No.	Description	Range and meaning of value
D5801 to D5817		
D5818	COM.W	Communication write enable/disable 0: OFF (Enable) 1: ON (Disable)
D5819	DATA-L *1	Front panel parameter data key lock 0: OFF (Unlock) 1: ON (Lock)
D5820 to D5830		
D5831	CTL-L *1	[CTL] menu lock
D5832	PV-L *1	[PV] menu lock
D5833 to D5835		
D5836	MPV_L1-L *1	[MPV] menu lock
D5837		
D5838	OUT-L *1	[OUT] menu lock
D5839 to D5840		
D5841	R485_E3-L *1	[R485] menu lock (E3-terminal area)
D5842		
D5843	ETHR_E3-L *1	[ETHR] menu lock (E3-terminal area)
D5844 to D5846		
D5847	KEY-L *1	[KEY] menu lock
D5848	DISP-L *1	[DISP] menu lock
D5849		
D5850	KLOC-L *1	[KLOC] menu lock
D5851	DI.SL-L *1	[DI.SL] menu lock
D5852 to D5862		
D5863	I/O-L *1	[I/O] menu lock
D5864	SYS-L *1	[SYS] menu lock
D5865	INIT-L *1	[INIT] menu lock
D5866	VER-L *1	[VER] menu lock
D5867	LVL-L *1	[LVL] menu lock
D5868 to D5869		
D5870	SP_L1-L *1	[SP] menu lock
D5871	SPS_L1-L *1	[SPS] menu lock
D5872	ALRM_L1-L *1	[ALRM] menu lock
D5873		
D5874	PVS_L1-L *1	[PVS] menu lock
D5875 to D5900		

0: OFF (Display)
1: ON (Nondisplay)

*1: Same parameter exists in other menu. "-L" is added to the end of the parameter in KLOC menu or MLOC menu.

12.4 UT35A-L D Registers

DI Function Setting (D5901 to D6200)

Register No.	Description		Range and meaning of value
D5901 to D5939			
D5940	DI2.S	DI2 function selection	0: OFF (No function) 1: LAT (Latch release) 2: LCD (LCD backlight ON/OFF switch) 3: PVPW (PV red/white switch) 4: MG1 (Message display interruption 1) 5: MG2 (Message display interruption 2) 6: MG3 (Message display interruption 3) 7: MG4 (Message display interruption 4)
D5941 to D6000			
D6001	MSG1	Message-1 *2	20-digit value of alphanumeric characters can be set. Arrangement: D6001, D6002, D6003, D6004, D6005, D6006, D6007, DD6008, D6009, D6010, D6011 Write "0x00" to the register after the character string.
D6002	MSG1		
D6003	MSG1		
D6004	MSG1		
D6005	MSG1		
D6006	MSG1		
D6007	MSG1		
D6008	MSG1		
D6009	MSG1		
D6010	MSG1		
D6011	MSG1		
D6012 to D6020			
D6021	MSG2	Message-2 *2	20-digit value of alphanumeric characters can be set. Arrangement: D6021, D6022, D6023, D6024, D6025, D6026, D6027, D6028, D6029, D6030, D6031 Write "0x00" to the register after the character string.
D6022	MSG2		
D6023	MSG2		
D6024	MSG2		
D6025	MSG2		
D6026	MSG2		
D6027	MSG2		
D6028	MSG2		
D6029	MSG2		
D6030	MSG2		
D6031	MSG2		
D6032 to D6040			
D6041	MSG3	Message-3 *2	20-digit value of alphanumeric characters can be set. Arrangement: D6041, D6042, D6043, D6044, D6045, D6046, D6047, D6048, D6049, D6050, D6051 Write "0x00" to the register after the character string.
D6042	MSG3		
D6043	MSG3		
D6044	MSG3		
D6045	MSG3		
D6046	MSG3		
D6047	MSG3		
D6048	MSG3		
D6049	MSG3		
D6050	MSG3		
D6051	MSG3		
D6052 to D6060			

*1: Same parameter exists in other menu. "-D" is added to the end of the parameter in DI.SL menu.

Register No.	Description		Range and meaning of value
D6061	MSG4	Message-4 *2	20-digit value of alphanumeric characters can be set. Arrangement: D6061, D6062, D6063, D6064, D6065, D6066, D6067, D6068, D6069, D6070, D6071 Write "0x00" to the register after the character string.
D6062	MSG4		
D6063	MSG4		
D6064	MSG4		
D6065	MSG4		
D6066	MSG4		
D6067	MSG4		
D6068	MSG4		
D6069	MSG4		
D6070	MSG4		
D6071	MSG4		
D6072 to D6200			

*2: With regards to the information on D6001 to D6011, D6021 to D6031, D6041 to D6051, and D6061 to D6071, 11 D registers comprise one message.

● D6201 to D6300

Register No.	Description		Range and meaning of value
D6201 to D6300		Free area	

12.4 UT35A-L D Registers

I/O Display (D6301 to D6400)

● Bit Configuration of D6301: KEY-IO*1 (Key status)

Bit	Symbol	Event
0	PARA_KEY	PARAMETER (PARA) key (0: OFF 1: ON)
1	DISP_KEY	DISPLAY (DISP) key (0: OFF 1: ON)
2	RIGHT_KEY	RIGHT key (0: OFF 1: ON)
3	DOWN_KEY	DOWN key (0: OFF 1: ON)
4	SET_KEY	SET/ENTER key (0: OFF 1: ON)
5	UP_KEY	UP key (0: OFF 1: ON)
6	LEFT_KEY	LEFT key (0: OFF 1: ON)
7	F2_KEY	F2 key (0: OFF 1: ON)
8	F1_KEY	F1 key (0: OFF 1: ON)
9	RST_KEY	RST key (0: OFF 1: ON)
10	FN_KEY	Fn key (0: OFF 1: ON)
11		
12		
13		
14		
15		

*1: Same parameter exists in other menu. "-IO" is added to the end of the parameter in I/O menu.

● D6302 to D6400

Register No.	Description	Range and meaning of value
D6302 to D6400	Free area	

System Setting (D6401 to D6500)

Register No.	Description	Range and meaning of value
D6401 to D6408		
D6403	R.MD	Restart mode 0: Limit output is ON at power on in any cases 1: Limit output is OFF at power on when PV doesn't exceed SP
D6409	C.GRN	Response as GREEN Series 0: OFF (Works as UT35A-L in communication of device information response or broadcasting.) 1: ON (Works as GREEN Series in communication of device information response or broadcasting.)
D6410	FREQ	Power frequency 0: AUTO 1: 60 Hz 2: 50 Hz
D6411 to D6416		
D6417	QSM	Quick setting mode 0: OFF (Disable) 1: ON (Enable)
D6418 to D6420		
D6421	U.DEF	Initialization to user default value 12345: Initialization, automatically returned to "0" after initialization.
D6422		
D6423	F.DEF	Initialization to factory default value -12345: Initialization, automatically returned to "0" after initialization. *
D6424 to D6430		
D6431	LEVL	Parameter display level 1: EASY (Easy setting mode) 2: STD (Standard setting mode) 3: PRO (Professional setting mode)
D6432 to D6500		

Free Area (D6501 to D7000)

Register No.	Description	Range and meaning of value
D6501 to D7600	Free area	

12.4 UT35A-L D Registers

12.4.4 Input / Output Terminal Status Register (D7601 to D7700)

Terminal status registers									
Input / output terminal status register									
D-Reg No.	Ref. No.	H No.	Register symbol	R/W	D-Reg No.	Ref. No.	H No.	Register symbol	R/W
				UT35A-L					UT35A-L
D7601	47601	1DB0	DI	R	D7651	47651	1DE2		
D7602	47602	1DB1			D7652	47652	1DE3		
D7603	47603	1DB2			D7653	47653	1DE4		
D7604	47604	1DB3			D7654	47654	1DE5		
D7605	47605	1DB4			D7655	47655	1DE6		
D7606	47606	1DB5			D7656	47656	1DE7		
D7607	47607	1DB6			D7657	47657	1DE8		
D7608	47608	1DB7			D7658	47658	1DE9		
D7609	47609	1DB8			D7659	47659	1DEA		
D7610	47610	1DB9			D7660	47660	1DEB		
D7611	47611	1DBA	OUT_AL	R	D7661	47661	1DEC		
D7612	47612	1DBB			D7662	47662	1DED		
D7613	47613	1DBC			D7663	47663	1DEE		
D7614	47614	1DBD			D7664	47664	1DEF		
D7615	47615	1DBE			D7665	47665	1DF0		
D7616	47616	1DBF			D7666	47666	1DF1		
D7617	47617	1DC0			D7667	47667	1DF2		
D7618	47618	1DC1			D7668	47668	1DF3		
D7619	47619	1DC2			D7669	47669	1DF4		
D7620	47620	1DC3			D7670	47670	1DF5		
D7621	47621	1DC4			D7671	47671	1DF6		
D7622	47622	1DC5			D7672	47672	1DF7		
D7623	47623	1DC6			D7673	47673	1DF8		
D7624	47624	1DC7	OUT_RET	R	D7674	47674	1DF9		
D7625	47625	1DC8	OUT_OUTR	R	D7675	47675	1DFA		
D7626	47626	1DC9			D7676	47676	1DFB		
D7627	47627	1DCA			D7677	47677	1DFC		
D7628	47628	1DCB			D7678	47678	1DFD		
D7629	47629	1DCC			D7679	47679	1DFE		
D7630	47630	1DCD			D7680	47680	1DFF		
D7631	47631	1DCE			D7681	47681	1E00		
D7632	47632	1DCF			D7682	47682	1E01		
D7633	47633	1DD0			D7683	47683	1E02		
D7634	47634	1DD1			D7684	47684	1E03		
D7635	47635	1DD2			D7685	47685	1E04		
D7636	47636	1DD3			D7686	47686	1E05		
D7637	47637	1DD4			D7687	47687	1E06		
D7638	47638	1DD5			D7688	47688	1E07		
D7639	47639	1DD6			D7689	47689	1E08		
D7640	47640	1DD7			D7690	47690	1E09		
D7641	47641	1DD8			D7691	47691	1E0A		
D7642	47642	1DD9			D7692	47692	1E0B		
D7643	47643	1DDA			D7693	47693	1E0C		
D7644	47644	1ddb			D7694	47694	1E0D		
D7645	47645	1DDC			D7695	47695	1E0E		
D7646	47646	1DDD			D7696	47696	1E0F		
D7647	47647	1DDE			D7697	47697	1E10		
D7648	47648	1DDF			D7698	47698	1E11		
D7649	47649	1DE0			D7699	47699	1E12		
D7650	47650	1DE1			D7700	47700	1E13		

D7701 to D9000: Free area

● Bit Configuration of D7601: DI (DI1-DI2 terminal status: equipped as standard)

Bit	Symbol	Event	
0	DI1	DI1 terminal status	(0: OFF 1: ON)
1	DI2	DI2 terminal status	(0: OFF 1: ON)
2 to 15			

● Bit Configuration of D7611: OUT_AL (AL1-AL3 terminal status: equipped as standard)

Bit	Symbol	Event	
0	OUT_AL1	AL1 terminal status	(0: OFF 1: ON)
1	OUT_AL2	AL2 terminal status	(0: OFF 1: ON)
2	OUT_AL3	AL3 terminal status	(0: OFF 1: ON)
3 to 15			

● D7616 to D7700

Register No.	Description		Range and meaning of value
D7616 to D7623			
D7624	OUT_RET	RET terminal	-1500 to 31500
D7625	OUT_OUTR	OUT terminal (Relay)	0: OFF 30000: ON
D7626 to D7700			

Free Area (D7701 to D9000)

Register No.	Description	Range and meaning of value
D7701 to D9000	Free area	

12.5 GREEN Series Compatible D Registers

12.5.1 Compatibility with GREEN Series Controllers

The D register map configuration of the UTAdvanced is the same as that of the GREEN Series (UT300 Series) controllers that perform access in the 2-byte integer data format. When GREEN Series devices are replaced with the UTAdvanced, communication programs created in the GREEN Series controllers can be used by just carrying out wiring. If existing programs created in the GREEN Series controllers are used, communication is performed using the area from D0001 to D2000.

However, although the function allocation from D0001 to D1300 is the same as that of the GREEN Series (UT300 Series) controllers, the setting ranges and the function operation specifications of registers are subject to the specifications of the UTAdvanced.

Furthermore, the functions have been enhanced from the GREEN Series controllers, so the generic settings and functions for some registers have been changed. For the changed registers, see “12.6.11 D Registers Differing in Content from GREEN Series.”

The register map after D2001 is a D register map allocated for the UTAdvanced.

When you want to newly perform communication, be sure to use the registers after D2001.

12.5.2 Interpretation of D Register Tables

Register map (Categories)					
Register contents					
D-Reg No.	Ref. No.	H No.	Register symbol for GREEN	Register symbol for UTAdvanced	R/W
D0001	40001	0000	ADERROR	AD1.E_G *1	R
D0002	40002	0001	ERROR.1	PV1.E_L1_G *1	R
D0003	40003	0002	PV.1	PV_L1 (D2003)	
⋮	⋮	⋮	⋮	⋮	⋮
D0250	40250	00F9	ORB.1	 *3	R
⋮	⋮	⋮	⋮	⋮	⋮
D0310	40310	0135	1.OL	Depends on the conditions *4	R/W
⋮	⋮	⋮	⋮	⋮	⋮
D0915	40915	0392	AL1.1	AL1.T_L1 (D2801)*2	R/W

(1) D register numbers (2) Reference numbers (for Modbus communication) (3) Hexadecimal numbers (for Modbus communication) Numbers in parentheses indicate the same register after D2001. Read/write by communication
 R: Read enabled
 W: Write enabled

■ Interpretation of Cell

*1: AD1.E_G (with _G) indicates a D register converted for the GREEN Series.

Furthermore, PV1.E_L1_G (shaded cell) indicates that it differs in content from that of the GREEN Series.

See “12.6.10 D Registers Converted for GREEN Series” described later.

*2: D100 (D7601) (shaded cell) indicates that it differs in content from that of the GREEN Series. See “12.6.11 D Registers Differing in Content from GREEN Series” described later.

*3: A cell marked with a diagonal line () indicates that it is not supported by the UTAdvanced.

*4: Depends on the conditions indicates that the D register varies depending on the setting condition of other parameters.

See “12.6.12 D Registers Differing Depending on Condition” described later.

■ D register symbols

- With regards to some D register symbols, the loop number, terminal area, and group number are indicated by adding the underline () to the end of the parameter symbols.

If both the loop number and group number are added to the parameter symbols, they are added in the order of loop number and group number.

Note

Since the UT35A-L is a limit controller, it has no distinction between Loop-1 and Loop-2. However, the register symbol has "L1" which indicates Loop-1.

□□□□ **L1** **L1**: Loop numbers
 □□□□ **E3** **E3**: Terminal area (E3)

Example : **SP** **L1** Indicates SP.
 A2 Indicates A2

- With regards to D register symbols from D0001 to D2000, the capital letter G with underline (G) is added to the end of the parameter symbols to indicate that the D register was converted for the GREEN Series.
 D registers with G do not appear in the area for the UTAdvanced after D2001. See "12.6.10 D Registers Converted for GREEN Series."

□□□□ **G** Example: AD1.E_G, PV1.E_L1_G, ALM_G

- Numbers in parentheses after the register symbols of the UTAdvanced indicate the same D register after D2001.

12.5 UT35A-L D Registers

12.5.3 Process Data and User Area (D0001 to D0100)

Configuration map for GREEN Series											
Process data						User area					
D-Reg No.	Ref. No.	H No.	Register symbol for GREEN	Register symbol for UT35A-L	R/W	D-Reg No.	Ref. No.	H No.	Register symbol for GREEN	Register symbol for UT35A-L	R/W
D0001	40001	0000	ADERROR	AD1.E_G	R	D0051	40051	0032	USER	USER1	R/W
D0002	40002	0001	ERROR	PV1.E_L1_G	R	D0052	40052	0033	USER	USER2	R/W
D0003	40003	0002	PV	PV_L1 (D2003)	R	D0053	40053	0034	USER	USER3	R/W
D0004	40004	0003	CSP	CSP_L1 (D2004)	R	D0054	40054	0035	USER	USER4	R/W
D0005	40005	0004				D0055	40055	0036	USER	USER5	R/W
D0006	40006	0005				D0056	40056	0037	USER	USER6	R/W
D0007	40007	0006				D0057	40057	0038	USER	USER7	R/W
D0008	40008	0007	MOD	MOD_L1_G	R	D0058	40058	0039	USER	USER8	R/W
D0009	40009	0008	TIME	TIME (D2081)	R	D0059	40059	003A	USER	USER9	R/W
D0010	40010	0009	MAX/MIN	MAX/MIN (D2082)	R	D0060	40060	003B	USER	USER10	R/W
D0011	40011	000A	ALM	ALM_G	R	D0061	40061	003C	USER	USER11	R/W
D0012	40012	000B				D0062	40062	003D	USER	USER12	R/W
D0013	40013	000C				D0063	40063	003E	USER	USER13	R/W
D0014	40014	000D				D0064	40064	003F	USER	USER14	R/W
D0015	40015	000E				D0065	40065	0040	USER	USER15	R/W
D0016	40016	000F				D0066	40066	0041	USER	USER16	R/W
D0017	40017	0010				D0067	40067	0042	USER	USER17	R/W
D0018	40018	0011				D0068	40068	0043	USER	USER18	R/W
D0019	40019	0012				D0069	40069	0044	USER	USER19	R/W
D0020	40020	0013				D0070	40070	0045	USER	USER20	R/W
D0021	40021	0014				D0071	40071	0046	USER	USER21	R/W
D0022	40022	0015				D0072	40072	0047	USER	USER22	R/W
D0023	40023	0016				D0073	40073	0048	USER	USER23	R/W
D0024	40024	0017				D0074	40074	0049	USER	USER24	R/W
D0025	40025	0018				D0075	40075	004A	USER	USER25	R/W
D0026	40026	0019				D0076	40076	004B	USER	USER26	R/W
D0027	40027	001A				D0077	40077	004C	USER	USER27	R/W
D0028	40028	001B				D0078	40078	004D	USER	USER28	R/W
D0029	40029	001C				D0079	40079	004E	USER	USER29	R/W
D0030	40030	001D				D0080	40080	004F	USER	USER30	R/W
D0031	40031	001E				D0081	40081	0050	USER	USER31	R/W
D0032	40032	001F				D0082	40082	0051	USER	USER32	R/W
D0033	40033	0020				D0083	40083	0052	USER	USER33	R/W
D0034	40034	0021				D0084	40084	0053	USER	USER34	R/W
D0035	40035	0022	PARAERR	PA.ER_G	R	D0085	40085	0054	USER	USER35	R/W
D0036	40036	0023				D0086	40086	0055	USER	USER36	R/W
D0037	40037	0024				D0087	40087	0056	USER	USER37	R/W
D0038	40038	0025				D0088	40088	0057	USER	USER38	R/W
D0039	40039	0026				D0089	40089	0058	USER	USER39	R/W
D0040	40040	0027				D0090	40090	0059	USER	USER40	R/W
D0041	40041	0028				D0091	40091	005A	USER	USER41	R/W
D0042	40042	0029				D0092	40092	005B	USER	USER42	R/W
D0043	40043	002A				D0093	40093	005C	USER	USER43	R/W
D0044	40044	002B				D0094	40094	005D	USER	USER44	R/W
D0045	40045	002C				D0095	40095	005E	USER	USER45	R/W
D0046	40046	002D				D0096	40096	005F	USER	USER46	R/W
D0047	40047	002E				D0097	40097	0060	USER	USER47	R/W
D0048	40048	002F				D0098	40098	0061	USER	USER48	R/W
D0049	40049	0030				D0099	40099	0062	USER	USER49	R/W
D0050	40050	0031	USER	USER0	R/W	D0100	40100	0063	USER	USER50	R/W

D0101 to D0200: Free area

12.5.4 Operation Mode and Operation-related Parameters (D0201 to D0300)

Configuration map for GREEN Series											
Operation mode / Operation-related parameters											
D-Reg No.	Ref. No.	H No.	Register symbol for GREEN	Register symbol for UTAdvanced	R/W	D-Reg No.	Ref. No.	H No.	Register symbol for GREEN	Register symbol for UTAdvanced	R/W
D0201	40201	00C8				D0251	40251	00FA			
D0202	40202	00C9				D0252	40252	00FB			
D0203	40203	00CA				D0253	40253	00FC			
D0204	40204	00CB				D0254	40254	00FD			
D0205	40205	00CC				D0255	40255	00FE			
D0206	40206	00CD				D0256	40256	00FF	H	HYS_G	R/W
D0207	40207	00CE				D0257	40257	0100			
D0208	40208	00CF				D0258	40258	0101			
D0209	40209	00D0				D0259	40259	0102			
D0210	40210	00D1				D0260	40260	0103			
D0211	40211	00D2				D0261	40261	0104			
D0212	40212	00D3				D0262	40262	0105			
D0213	40213	00D4				D0263	40263	0106			
D0214	40214	00D5				D0264	40264	0107			
D0215	40215	00D6				D0265	40265	0108			
D0216	40216	00D7				D0266	40266	0109			
D0217	40217	00D8				D0267	40267	010A			
D0218	40218	00D9				D0268	40268	010B			
D0219	40219	00DA				D0269	40269	010C			
D0220	40220	00DB				D0270	40270	010D			
D0221	40221	00DC				D0271	40271	010E			
D0222	40222	00DD				D0272	40272	010F			
D0223	40223	00DE				D0273	40273	0110			
D0224	40224	00DF				D0274	40274	0111			
D0225	40225	00E0				D0275	40275	0112			
D0226	40226	00E1				D0276	40276	0113			
D0227	40227	00E2				D0277	40277	0114			
D0228	40228	00E3				D0278	40278	0115			
D0229	40229	00E4				D0279	40279	0116			
D0230	40230	00E5				D0280	40280	0117			
D0231	40231	00E6	A1	A1_G	R/W	D0281	40281	0118			
D0232	40232	00E7	A2	A2_G	R/W	D0282	40282	0119			
D0233	40233	00E8				D0283	40283	011A			
D0234	40234	00E9				D0284	40284	011B			
D0235	40235	00EA				D0285	40285	011C			
D0236	40236	00EB				D0286	40286	011D			
D0237	40237	00EC				D0287	40287	011E			
D0238	40238	00ED				D0288	40288	011F			
D0239	40239	00EE				D0289	40289	0120			
D0240	40240	00EF				D0290	40290	0121			
D0241	40241	00F0				D0291	40291	0122			
D0242	40242	00F1				D0292	40292	0123			
D0243	40243	00F2	BS	BS_L1 (D2901)	R/W	D0293	40293	0124			
D0244	40244	00F3	FL	FL_L1 (D2902)	R/W	D0294	40294	0125			
D0245	40245	00F4				D0295	40295	0126			
D0246	40246	00F5				D0296	40296	0127			
D0247	40247	00F6				D0297	40297	0128			
D0248	40248	00F7				D0298	40298	0129			
D0249	40249	00F8				D0299	40299	012A			
D0250	40250	00F9				D0300	40300	012B			

12.5 UT35A-L D Registers

12.5.5 SP Parameters (D0301 to D0500)

Configuration map for GREEN Series											
SP parameters											
D-Reg No.	Ref. No.	H No.	Register symbol for GREEN	Register symbol for UTAdvanced	R/W	D-Reg No.	Ref. No.	H No.	Register symbol for GREEN	Register symbol for UTAdvanced	R/W
D0301	40301	012C	SP	SP_L1 (D2501)	R/W	D0351	40351	015E			
D0302	40302	012D				D0352	40352	015F			
D0303	40303	012E				D0353	40353	0160			
D0304	40304	012F				D0354	40354	0161			
D0305	40305	0130				D0355	40355	0162			
D0306	40306	0131				D0356	40356	0163			
D0307	40307	0132				D0357	40357	0164			
D0308	40308	0133				D0358	40358	0165			
D0309	40309	0134				D0359	40359	0166			
D0310	40310	0135				D0360	40360	0167			
D0311	40311	0136				D0361	40361	0168			
D0312	40312	0137				D0362	40362	0169			
D0313	40313	0138				D0363	40363	016A			
D0314	40314	0139				D0364	40364	016B			
D0315	40315	013A				D0365	40365	016C			
D0316	40316	013B				D0366	40366	016D			
D0317	40317	013C				D0367	40367	016E			
D0318	40318	013D				D0368	40368	016F			
D0319	40319	013E				D0369	40369	0170			
D0320	40320	013F				D0370	40370	0171			
D0321	40321	0140				D0371	40371	0172			
D0322	40322	0141				D0372	40372	0173			
D0323	40323	0142				D0373	40373	0174			
D0324	40324	0143				D0374	40374	0175			
D0325	40325	0144				D0375	40375	0176			
D0326	40326	0145				D0376	40376	0177			
D0327	40327	0146				D0377	40377	0178			
D0328	40328	0147				D0378	40378	0179			
D0329	40329	0148				D0379	40379	017A			
D0330	40330	0149				D0380	40380	017B			
D0331	40331	014A				D0381	40381	017C			
D0332	40332	014B				D0382	40382	017D			
D0333	40333	014C				D0383	40383	017E			
D0334	40334	014D				D0384	40384	017F			
D0335	40335	014E				D0385	40385	0180			
D0336	40336	014F				D0386	40386	0181			
D0337	40337	0150				D0387	40387	0182			
D0338	40338	0151				D0388	40388	0183			
D0339	40339	0152				D0389	40389	0184			
D0340	40340	0153				D0390	40390	0185			
D0341	40341	0154				D0391	40391	0186			
D0342	40342	0155				D0392	40392	0187			
D0343	40343	0156				D0393	40393	0188			
D0344	40344	0157				D0394	40394	0189			
D0345	40345	0158				D0395	40395	018A			
D0346	40346	0159				D0396	40396	018B			
D0347	40347	015A				D0397	40397	018C			
D0348	40348	015B				D0398	40398	018D			
D0349	40349	015C				D0399	40399	018E			
D0350	40350	015D				D0400	40400	018F			

D0501 to D0900: Free area

12.5.6 Control Action Parameters (D0901 to D1000)

Configuration map for GREEN Series											
Control action parameters											
D-Reg No.	Ref. No.	H No.	Register symbol for GREEN	Register symbol for UTAdvanced	R/W	D-Reg No.	Ref. No.	H No.	Register symbol for GREEN	Register symbol for UTAdvanced	R/W
D0901	40901	0384				D0951	40951	03B6			
D0902	40902	0385				D0952	40952	03B7			
D0903	40903	0386				D0953	40953	03B8			
D0904	40904	0387	TMU	TMU_L1 (D2714)	R/W	D0954	40954	03B9			
D0905	40905	0388				D0955	40955	03BA			
D0906	40906	0389				D0956	40956	03BB			
D0907	40907	038A				D0957	40957	03BC			
D0908	40908	038B				D0958	40958	03BD			
D0909	40909	038C				D0959	40959	03BE			
D0910	40910	038D				D0960	40960	03BF			
D0911	40911	038E				D0961	40961	03C0			
D0912	40912	038F				D0962	40962	03C1			
D0913	40913	0390				D0963	40963	03C2			
D0914	40914	0391				D0964	40964	03C3			
D0915	40915	0392	AL1 (Note 1)	AL1.T_L1 (D2801)	R/W	D0965	40965	03C4			
D0916	40916	0393	AL2 (Note 1)	AL2.T_L1 (D2805)	R/W	D0966	40966	03C5			
D0917	40917	0394				D0967	40967	03C6			
D0918	40918	0395				D0968	40968	03C7			
D0919	40919	0396	HY1	HY1_L1 (D2841)	R/W	D0969	40969	03C8			
D0920	40920	0397	HY2	HY2_L1 (D2842)	R/W	D0970	40970	03C9			
D0921	40921	0398				D0971	40971	03CA			
D0922	40922	0399				D0972	40972	03CB			
D0923	40923	039A				D0973	40973	03CC			
D0924	40924	039B				D0974	40974	03CD			
D0925	40925	039C				D0975	40975	03CE			
D0926	40926	039D				D0976	40976	03CF			
D0927	40927	039E				D0977	40977	03D0			
D0928	40928	039F				D0978	40978	03D1			
D0929	40929	03A0				D0979	40979	03D2			
D0930	40930	03A1	R.MD	R.MD (D6403)	R/W	D0980	40980	03D3			
D0931	40931	03A2				D0981	40981	03D4			
D0932	40932	03A3	DIS	CNF (D5022)	R/W	D0982	40982	03D5			
D0933	40933	03A4	HI.LO	HI.LO (D5021)	R/W	D0983	40983	03D6			
D0934	40934	03A5	OP.SL	HOME (D5744)	R/W	D0984	40984	03D7			
D0935	40935	03A6				D0985	40985	03D8			
D0936	40936	03A7				D0986	40986	03D9			
D0937	40937	03A8				D0987	40987	03DA			
D0938	40938	03A9				D0988	40988	03DB			
D0939	40939	03AA				D0989	40989	03DC			
D0940	40940	03AB				D0990	40990	03DD			
D0941	40941	03AC				D0991	40991	03DE			
D0942	40942	03AD				D0992	40992	03DF			
D0943	40943	03AE				D0993	40993	03E0			
D0944	40944	03AF				D0994	40994	03E1			
D0945	40945	03B0				D0995	40995	03E2			
D0946	40946	03B1				D0996	40996	03E3			
D0947	40947	03B2				D0997	40997	03E4			
D0948	40948	03B3				D0998	40998	03E5			
D0949	40949	03B4				D0999	40999	03E6			
D0950	40950	03B5				D1000	41000	03E7			

12.5 UT35A-L D Registers

12.5.7 Common Function Parameters (D1001 to D1100)

Configuration map for GREEN Series											
Common function parameters											
D-Reg No.	Ref. No.	H No.	Register symbol for GREEN	Register symbol for UTAdvanced	R/W	D-Reg No.	Ref. No.	H No.	Register symbol for GREEN	Register symbol for UTAdvanced	R/W
D1001	41001	03E8				D1051	41051	041A			
D1002	41002	03E9				D1052	41052	041B			
D1003	41003	03EA				D1053	41053	041C			
D1004	41004	03EB				D1054	41054	041D			
D1005	41005	03EC				D1055	41055	041E			
D1006	41006	03ED				D1056	41056	041F			
D1007	41007	03EE				D1057	41057	0420			
D1008	41008	03EF				D1058	41058	0421			
D1009	41009	03F0				D1059	41059	0422			
D1010	41010	03F1				D1060	41060	0423			
D1011	41011	03F2				D1061	41061	0424			
D1012	41012	03F3				D1062	41062	0425			
D1013	41013	03F4	RET	RTS (D5321)	R/W	D1063	41063	0426			
D1014	41014	03F5	RTH	RTH (D5322)	R/W	D1064	41064	0427			
D1015	41015	03F6	RTL	RTL (D5323)	R/W	D1065	41065	0428			
D1016	41016	03F7				D1066	41066	0429			
D1017	41017	03F8				D1067	41067	042A			
D1018	41018	03F9				D1068	41068	042B			
D1019	41019	03FA				D1069	41069	042C			
D1020	41020	03FB				D1070	41070	042D			
D1021	41021	03FC				D1071	41071	042E			
D1022	41022	03FD				D1072	41072	042F			
D1023	41023	03FE				D1073	41073	0430			
D1024	41024	03FF				D1074	41074	0431			
D1025	41025	0400				D1075	41075	0432			
D1026	41026	0401				D1076	41076	0433			
D1027	41027	0402				D1077	41077	0434			
D1028	41028	0403				D1078	41078	0435			
D1029	41029	0404				D1079	41079	0436			
D1030	41030	0405				D1080	41080	0437			
D1031	41031	0406				D1081	41081	0438			
D1032	41032	0407				D1082	41082	0439			
D1033	41033	0408				D1083	41083	043A			
D1034	41034	0409				D1084	41084	043B			
D1035	41035	040A				D1085	41085	043C			
D1036	41036	040B	LOCK		R	D1086	41086	043D			
D1037	41037	040C				D1087	41087	043E			
D1038	41038	040D				D1088	41088	043F			
D1039	41039	040E				D1089	41089	0440			
D1040	41040	040F				D1090	41090	0441			
D1041	41041	0410				D1091	41091	0442			
D1042	41042	0411				D1092	41092	0443			
D1043	41043	0412				D1093	41093	0444			
D1044	41044	0413				D1094	41094	0445			
D1045	41045	0414				D1095	41095	0446			
D1046	41046	0415				D1096	41096	0447			
D1047	41047	0416				D1097	41097	0448			
D1048	41048	0417				D1098	41098	0449			
D1049	41049	0418				D1099	41099	044A			
D1050	41050	0419				D1100	41100	044B			

12.5.8 PV Input, and Limit Control Output Parameters (D1201 to D1300)

Configuration map for GREEN Series											
PV input, and Control output parameters											
D-Reg No.	Ref. No.	H No.	Register symbol for GREEN	Register symbol for UTAdvanced	R/W	D-Reg No.	Ref. No.	H No.	Register symbol for GREEN	Register symbol for UTAdvanced	R/W
D1201	41201	04B0	IN	IN (D5101)	R/W	D1251	41251	04E2	DLN	DLN_E3 (D5525)	R/W
D1202	41202	04B1	UNI	UNI (D5102)	R/W	D1252	41252	04E3	ADR	ADR_E3 (D5526)	R/W
D1203	41203	04B2				D1253	41253	04E4	RP.T	RP.T_E3 (D5527)	R/W
D1204	41204	04B3	RH	RH (D5104)	R/W	D1254	41254	04E5			
D1205	41205	04B4	RL	RL (D5105)	R/W	D1255	41255	04E6			
D1206	41206	04B5	SDP	SDP (D5106)	R/W	D1256	41256	04E7			
D1207	41207	04B6	SH	SH (D5107)	R/W	D1257	41257	04E8			
D1208	41208	04B7	SL	SL (D5108)	R/W	D1258	41258	04E9			
D1209	41209	04B8	BSL	BSL (D5109)	R/W	D1259	41259	04EA			
D1210	41210	04B9	RJC	RJC (D5110)	R/W	D1260	41260	04EB			
D1211	41211	04BA				D1261	41261	04EC			
D1212	41212	04BB				D1262	41262	04ED			
D1213	41213	04BC				D1263	41263	04EE			
D1214	41214	04BD				D1264	41264	04EF			
D1215	41215	04BE				D1265	41265	04F0			
D1216	41216	04BF				D1266	41266	04F1			
D1217	41217	04C0				D1267	41267	04F2			
D1218	41218	04C1				D1268	41268	04F3			
D1219	41219	04C2				D1269	41269	04F4			
D1220	41220	04C3				D1270	41270	04F5			
D1221	41221	04C4				D1271	41271	04F6			
D1222	41222	04C5				D1272	41272	04F7			
D1223	41223	04C6				D1273	41273	04F8			
D1224	41224	04C7				D1274	41274	04F9			
D1225	41225	04C8				D1275	41275	04FA			
D1226	41226	04C9				D1276	41276	04FB			
D1227	41227	04CA				D1277	41277	04FC			
D1228	41228	04CB				D1278	41278	04FD			
D1229	41229	04CC				D1279	41279	04FE			
D1230	41230	04CD				D1280	41280	04FF			
D1231	41231	04CE				D1281	41281	0500			
D1232	41232	04CF				D1282	41282	0501			
D1233	41233	04D0				D1283	41283	0502			
D1234	41234	04D1				D1284	41284	0503			
D1235	41235	04D2				D1285	41285	0504			
D1236	41236	04D3				D1286	41286	0505			
D1237	41237	04D4				D1287	41287	0506			
D1238	41238	04D5				D1288	41288	0507			
D1239	41239	04D6				D1289	41289	0508			
D1240	41240	04D7				D1290	41290	0509			
D1241	41241	04D8				D1291	41291	050A			
D1242	41242	04D9				D1292	41292	050B			
D1243	41243	04DA				D1293	41293	050C			
D1244	41244	04DB				D1294	41294	050D			
D1245	41245	04DC				D1295	41295	050E			
D1246	41246	04DD				D1296	41296	050F			
D1247	41247	04DE	PSL	PSL-E3 (D5521)	R/W	D1297	41297	0510			
D1248	41248	04DF	BPS	BPS-E3 (D5522)	R/W	D1298	41298	0511			
D1249	41249	04E0	PRI	PRI-E3 (D5523)	R/W	D1299	41299	0512			
D1250	41250	04E1	STP	STP-E3 (D5524)	R/W	D1300	41300	0513			

D1301 to D2000: Free area

12.5.9 D Registers Converted for GREEN Series

● Bit Configuration of D0001: AD1.E_G (A/D converter error status for GREEN Series)

Bit	Symbol		Event
	GREEN Series	UTAdvanced	
0	ADERR.st	ADERR (I4065)	PV input A/D converter error
1 to 15			

● Bit Configuration of D0002: PV1.E_L1_G (PV input error status for GREEN Series)

Bit	Symbol		Event
	GREEN Series	UTAdvanced	
0			
1	PVBO.st	PVBO_L1 (I4097)	PV input burnout error
2	RJCERR.st	RJCERR (I4070)	PV input RJC error
3			
4	PV+over.st	PVPOV_L1 (I4101)	PV input over-scale
5	PV-over.st	PVMOV_L1 (I4102)	PV input under-scale
6 to 15			

● Bit Configuration of D0008: MOD_L1_G (Operation mode status for GREEN Series)

Bit	Symbol		Event
	GREEN Series	UTAdvanced	
0			
1	EXD	EXD	1: Exceeded
2	OUT	OUT	0: Output relay is Off, 1: Output relay is On
3 to 15			

● Bit Configuration of D0011: ALM_G (Alarm status for GREEN Series)

Bit	Symbol		Event
	GREEN Series	UTAdvanced	
0	ALM1.st	ALM1_L1 (I4321)	'1' when alarm 1 is ON; '0' when OFF
1	ALM2.st	ALM2_L1 (I4322)	'1' when alarm 2 is ON; '0' when OFF
2 to 15			

● **Bit Configuration of D0035: PA.ER_G (Parameter error status for GREEN Series)**

Bit	Symbol		Event
	GREEN Series	UTAdvanced	
0	CALB.E.st	CALB_ERR (I4002)	Calibration value error
1 to 5			
6	SETUP.st	SETPA_ERR (I4005)	Setup parameter error
7			
8	PARA.E.st	OPEPA_ERR (I4006)	Operation parameter error
9 to 11			
12	EEP.E.st	FRAM_ERR (I4009)	Faulty FRAM
13			
14	SYSTEM.E.st	SYSTEM_ERR (I4001)	System data error
15			

● **D0231: A1_G (Alarm-1 setpoint for GREEN Series)**

Register No.	Symbol		Event
	GREEN Series	UTAdvanced	
D0231	A1	A1_G	-19999 to 30000 (Set a value within the input range.) Write: The value written in A1_G will be written in the register of A1_L1. A1_L1 (D2504) Note: When the same value as the current value is written to A1_G, the action to write A1_L1 is performed again. At this time, if different values are set in A1_L1, they are overwritten by the same value.

● **D0232: A2_G (Alarm-2 setpoint for GREEN Series)**

Register No.	Symbol		Event
	GREEN Series	UTAdvanced	
D0232	A2	A2_G	-19999 to 30000 (Set a value within the input range.) Write: The value written in A2_G will be written in the register of A2_L1_1. A2_L1 (D2505) Note: When the same value as the current value is written to A2_G, the action to write A2_L1 is performed again. At this time, if different values are set in A2_L1, they are overwritten by the same value.

● **D0256: HYS_G (Limit Control Output Hysteresis for GREEN Series)**

Register No.	Symbol		Event
	GREEN Series	UTAdvanced	
D0256	H	HYS_G	0.0 to 100.0% of PV input range span (EUS) Write: The value written in HYS_G will be written in the register of HYS_L1. HYS_L1 (D2911)

12.5.10 D Registers Differing in Content from GREEN Series

● D0915 to D0917: Alarm-1 type to alarm-3 type
UTAdvanced

Register No.	Description		Range and meaning of value
D0915	AL1.T_L1	Alarm-1 type	0: Disable 01: PV high limit 02: PV low limit 05: Deviation high limit 06: Deviation low limit 07: Deviation high and low limits 08: Deviation within high and low limits 29: PV velocity 30: Fault diagnosis 31: FAIL
D0916	AL2.T_L1	Alarm-2 type	
D0917	AL3.T_L1	Alarm-3 type	

GREEN Series

Register No.	Description		Range and meaning of value
D0915	AL1	Alarm-1 type	OFF (0) 1: PV high limit (energized, no stand-by action) 2: PV low limit (energized, no stand-by action) 3: Deviation high limit (energized, no stand-by action) 4: Deviation low limit (energized, no stand-by action) 5: Deviation high limit (de-energized, no stand-by action) 6: Deviation low limit (de-energized, no stand-by action) For other alarm types, see "Changing Alarm Type" of GREEN series (UT350L) User's manual.
D0916	AL2	Alarm-2 type	

13.1 Overview

This chapter describes the functions and applications of the I relays.

I relays are used in Modbus communication, PC link communication, and contact input / output functions.

I relays contain status information of errors, operation, and alarms. Contents of I relays can be read only by means of communication using a host computer. (Note that the I relays have the same information as the D registers but with I relays, some of the information is read-only.)

- ▶ [Contact input and output functions: Chapter 12 Contact Input and Output Functions of the UT35A-L User's Manual](#)

Use of the I relays enables the following:

- Centralized control by the host computer

D registers and I relays on the UTAdvanced are used for parameter settings of LL50A Parameter Setting Software.

13.2 Classification of I Relays

I relays are classified as shown below.

Classification of I Relay Map

I relay No.	Area and data categories	Description	
1 to 192	GREEN series	Status	Each bit information is the same as that of D register.
193 to 640	(See 13.5 I Relays Corresponding to GREEN Series)	Free area	
641 to 720		Status	Each bit information is the same as that of D register.
721 to 784		User area	
785 to 4000		Free area	
4001 to 4064	Function status	System error	Each bit information is the same as that of D register.
4065 to 4128		Input error	Each bit information is the same as that of D register.
4129 to 4192		Free area	
4193 to 4256		Operation Mode	Each bit information of 4193 to 4240 is the same as that of D register. For 4241 to 4256, see the section 13.3.1.
4257 to 4320		Free area	
4321 to 4384		Alarm	Each bit information is the same as that of D register.
4385 to 4528		Alarm latch	Each bit information of 4385 to 4512 is the same as that of D register. For 4385 to 4512, see the section 13.3.1.
4529 to 4704		Free area	
4705 to 4768		Key	Each bit information is the same as that of D register.
4769 to 4784		Display	Each bit information is the same as that of D register.
4785 to 6304		Free area	
6305 to 6432		Input / Output terminal status	DI terminal
6433 to 6560	DO terminal		Each bit information is the same as that of D register.
6561 to 7072	Free area		

CAUTION

- Check the model and suffix codes and parameter settings before writing to or read from the registers to be used.
- In the area for I relay numbers 4001 to 6560, it is prohibited to write data to I relays with blank cells in I relay map tables. If you attempt to do so, the UTAdvanced may not operate properly.

Note

- I relay numbers 4001 to 6560 store ON/OFF status information and are normally read for ON/OFF status information.

■ How to Specify I Relay Numbers

When specifying an I relay number for communication, begin the number with the character "I."

Example: Set "I4065" to specify the ADERR (I relay No.: 4065).

■ I relay symbol

- With regards to some register symbols, the loop number and terminal area are indicated by adding the underline () to the end of the parameter symbols.

Note

Since the UT35A/UT32A is a limit controller, it has no distinction between Loop-1 and Loop-2. However, the register symbol has "L1" which indicates Loop-1.

□□□□_L1	L1: Loop numbers
□□□□_En	En: Terminal area (E1 to E4)

Example : **PVBO_L1** Indicates PVBO.
ADERR_E3 Indicates ADERR in E3-terminal area.

13.3 UT35A-L I Relays

13.3.1 Function Status (4001 to 5024)

Note

When specifying an I relay number for communication, begin the number with the character "I."
Example: Set "I4065" to specify the ADERR (I relay No.: 4065).

System error			Input error		
NO.	I relay symbol	R/W UT35A-L	NO.	I relay symbol	R/W UT35A-L
4001	SYSTEM_ERR	R	4065	ADERR	R
4002	CALB_ERR	R	4066		
4003	UPARA_ERR	R	4067		
4004			4068		
4005	SETPA_ERR	R	4069		
4006	OPEPA_ERR	R	4070	RJCERR	R
4007			4071		
4008			4072		
4009	FRAM_ERR	R	4073	ADBO	R
4010			4074		
4011	CTLPA_ERR	R	4075		
4012			4076		
4013			4077		
4014			4078		
4015			4079		
4016			4080		
4017			4081		
4018			4082		
4019			4083		
4020			4084		
4021			4085		
4022			4086		
4023			4087		
4024			4088		
4025			4089		
4026			4090		
4027			4091		
4028			4092		
4029			4093		
4030			4094		
4031			4095		
4032			4096		
4033			4097	PVBO_L1	R
4034			4098		
4035	E3_ERR	R	4099		
4036			4100		
4037			4101	PVPOVER_L1	R
4038			4102	PVMOVER_L1	R
4039			4103		
4040			4104		
4041			4105		
4042			4106		
4043	COM_E3_ERR	R	4107		
4044			4108		
4045			4109		
4046			4110		
4047			4111		
4048			4112		
4049			4113		
4050			4114		
4051			4115		
4052			4116		
4053			4117		
4054			4118		
4055			4119		
4056			4120		
4057			4121		
4058			4122		
4059			4123		
4060			4124		
4061			4125		
4062			4126		
4063			4127		
4064			4128		

13.3 UT35A-L I Relays

Operation mode			Operation mode			Operation mode		
NO.	I relay symbol	R/W UT35A-L	NO.	I relay symbol	R/W UT35A-L	NO.	I relay symbol	R/W UT35A-L
4129			4193			4257		
4130			4194			4258		
4131			4195			4259		
4132			4196			4260		
4133			4197			4261		
4134			4198			4262		
4135			4199			4263		
4136			4200			4264		
4137			4201			4265		
4138			4202			4266		
4139			4203			4267		
4140			4204			4268		
4141			4205	EXD	R	4269		
4142			4206	OUT	R	4270		
4143			4207			4271		
4144			4208			4272		
4145			4209			4273		
4146			4210			4274		
4147			4211			4275		
4148			4212			4276		
4149			4213			4277		
4150			4214			4278		
4151			4215			4279		
4152			4216			4280		
4153			4217			4281		
4154			4218			4282		
4155			4219			4283		
4156			4220			4284		
4157			4221			4285		
4158			4222			4286		
4159			4223			4287		
4160			4224			4288		
4161			4225			4289		
4162			4226			4290		
4163			4227			4291		
4164			4228			4292		
4165			4229			4293		
4166			4230			4294		
4167			4231			4295		
4168			4232			4296		
4169			4233			4297		
4170			4234			4298		
4171			4235			4299		
4172			4236			4300		
4173			4237			4301		
4174			4238			4302		
4175			4239			4303		
4176			4240			4304		
4177			4241			4305		
4178			4242			4306		
4179			4243			4307		
4180			4244			4308		
4181			4245			4309		
4182			4246			4310		
4183			4247			4311		
4184			4248			4312		
4185			4249			4313		
4186			4250			4314		
4187			4251			4315		
4188			4252			4316		
4189			4253			4317		
4190			4254			4318		
4191			4255			4319		
4192			4256			4320		

Alarm			Alarm latch			Alarm latch		
NO.	I relay symbol	R/W UT35A-L	NO.	I relay symbol	R/W UT35A-L	NO.	I relay symbol	R/W UT35A-L
4321	ALM1_L1	R	4385	ALO1LA1_L1	R	4449	ALO1LA3_L1	R
4322	ALM2_L1	R	4386	ALO2LA1_L1	R	4450	ALO2LA3_L1	R
4323	ALM3_L1	R	4387	ALO3LA1_L1	R	4451	ALO3LA3_L1	R
4324			4388			4452		
4325			4389			4453		
4326			4390			4454		
4327			4391			4455		
4328			4392			4456		
4329			4393			4457		
4330			4394			4458		
4331			4395			4459		
4332			4396			4460		
4333			4397			4461		
4334			4398			4462		
4335			4399			4463		
4336			4400			4464		
4337			4401			4465		
4338			4402			4466		
4339			4403			4467		
4340			4404			4468		
4341			4405			4469		
4342			4406			4470		
4343			4407			4471		
4344			4408			4472		
4345			4409			4473		
4346			4410			4474		
4347			4411			4475		
4348			4412			4476		
4349			4413			4477		
4350			4414			4478		
4351			4415			4479		
4352			4416			4480		
4353	ALO1_L1	R	4417	ALO1LA2_L1	R	4481	ALO1LA4_L1	R
4354	ALO2_L1	R	4418	ALO2LA2_L1	R	4482	ALO2LA4_L1	R
4355	ALO3_L1	R	4419	ALO3LA2_L1	R	4483	ALO3LA4_L1	R
4356			4420			4484		
4357			4421			4485		
4358			4422			4486		
4359			4423			4487		
4360			4424			4488		
4361			4425			4489		
4362			4426			4490		
4363			4427			4491		
4364			4428			4492		
4365			4429			4493		
4366			4430			4494		
4367			4431			4495		
4368			4432			4496		
4369			4433			4497		
4370			4434			4498		
4371			4435			4499		
4372			4436			4500		
4373			4437			4501		
4374			4438			4502		
4375			4439			4503		
4376			4440			4504		
4377			4441			4505		
4378			4442			4506		
4379			4443			4507		
4380			4444			4508		
4381			4445			4509		
4382			4446			4510		
4383			4447			4511		
4384			4448			4512		

13.3 UT35A-L I Relays

Alarm latch and Heater break alarm			SP number and PID number			Pattern number and Segment number		
NO.	I relay symbol	R/W UT35A-L	NO.	I relay symbol	R/W UT35A-L	NO.	I relay symbol	R/W UT35A-L
4513	ALOLA_RLS	R/W	4577			4641		
4514	ALM_WAIT	R/W	4578			4642		
4515			4579			4643		
4516			4580			4644		
4517			4581			4645		
4518			4582			4646		
4519			4583			4647		
4520			4584			4648		
4521			4585			4649		
4522			4586			4650		
4523			4587			4651		
4524			4588			4652		
4525			4589			4653		
4526			4590			4654		
4527			4591			4655		
4528			4592			4656		
4529			4593			4657		
4530			4594			4658		
4531			4595			4659		
4532			4596			4660		
4533			4597			4661		
4534			4598			4662		
4535			4599			4663		
4536			4600			4664		
4537			4601			4665		
4538			4602			4666		
4539			4603			4667		
4540			4604			4668		
4541			4605			4669		
4542			4606			4670		
4543			4607			4671		
4544			4608			4672		
4545			4609			4673		
4546			4610			4674		
4547			4611			4675		
4548			4612			4676		
4549			4613			4677		
4550			4614			4678		
4551			4615			4679		
4552			4616			4680		
4553			4617			4681		
4554			4618			4682		
4555			4619			4683		
4556			4620			4684		
4557			4621			4685		
4558			4622			4686		
4559			4623			4687		
4560			4624			4688		
4561			4625			4689		
4562			4626			4690		
4563			4627			4691		
4564			4628			4692		
4565			4629			4693		
4566			4630			4694		
4567			4631			4695		
4568			4632			4696		
4569			4633			4697		
4570			4634			4698		
4571			4635			4699		
4572			4636			4700		
4573			4637			4701		
4574			4638			4702		
4575			4639			4703		
4576			4640			4704		

Key			Display, PV event status		
NO.	I relay symbol	R/W	NO.	I relay symbol	R/W
		UT35A-L			UT35A-L
4705	PARA_KEY	R	4769	MG1.B	R
4706	DISP_KEY	R	4770	MG2.B	R
4707	RIGHT_KEY	R	4771	MG3.B	R
4708	DOWN_KEY	R	4772		
4709	SET_KEY	R	4773	MG4.B	R
4710	UP_KEY	R	4774		
4711	LEFT_KEY	R	4775		
4712	F2_KEY	R	4776		
4713	F1_KEY	R	4777		
4714	RST_KEY	R	4778		
4715	FN_KEY	R	4779	PV_RED_WHITE	R
4716			4780		
4717			4781		
4718			4782		
4719			4783		
4720			4784		
4721			4785		
4722			4786		
4723			4787		
4724			4788		
4725			4789		
4726			4790		
4727			4791		
4728			4792		
4729			4793		
4730			4794		
4731			4795		
4732			4796		
4733			4797		
4734			4798		
4735			4799		
4736			4800		
4737			4801		
4738			4802		
4739			4803		
4740			4804		
4741			4805		
4742			4806		
4743			4807		
4744			4808		
4745			4809		
4746			4810		
4747			4811		
4748			4812		
4749			4813		
4750			4814		
4751			4815		
4752			4816		
4753			4817		
4754			4818		
4755			4819		
4756			4820		
4757			4821		
4758			4822		
4759			4823		
4760			4824		
4761			4825		
4762			4826		
4763			4827		
4764			4828		
4765			4829		
4766			4830		
4767			4831		
4768			4832		

13.3 UT35A-L I Relays

System Error, Input Error, and Operation Mode (4001 to 4320)

I relay No.	Symbol	Event	
4001 to 4016	SYSTEM_ERR to CTLPA_ERR	Parameter error status (Same as D2068)	
4017 to 4032			
4033 to 4048	E3_ERR to COM_E3_ERR	Option error status (Same as D2070)	
4049 to 4064			
4065 to 4128	ADERR to ADBO PVBO_L1 to ATERR_L1	A/D converter error status 1 (Same as D2001) PV input error status (Same as D2002)	
4129 to 4204	Free Area		
4205 to 4206	EXD to OUT	Operation mode status (Same as D2008)	
4207 to 4255			
4256	FAIL_ALARM	FAIL alarm status	0: FAIL alarm 1: OFF (Normal)
4257 to 4320	Free area		

Alarm and Alarm Latch (4321 to 4576)

I relay No.	Symbol	Event	
4321 to 4336	ALM1_L1~ALM3_L1	Alarm-1 to alarm-3 status (Same as D2011)	
4337 to 4352			
4353 to 4368	ALO1_L1 to ALO3_L1	Alarm-1 to alarm-3 output status (Same as D2037)	
4369 to 4384			
4385 to 4400	ALO1LA1_L1 to ALO4LA1_L1	Alarm-1 to alarm-3 latch output status (Same as D2071)	
4401 to 4416			
4417 to 4432	ALO1LA2_L1 to ALO4LA2_L1	Alarm-1 to alarm-3 latch-2 output status (Same as D2073)	
4433 to 4448			
4449 to 4464	ALO1LA3_L1 to ALO4LA3_L1	Alarm-1 to alarm-3 latch-3 output status (Same as D2075)	
4465 to 4480			
4481 to 4496	ALO1LA4_L1 to ALO4LA4_L1	Alarm-1 to alarm-3 latch-4 output status (Same as D2077)	
4497 to 4512			
4513	ALOLA_RLS	Alarm latch release flag	0: OFF 1: Latch release Automatically returned to "0".
4514	ALM_WAIT	Forced stand-by alarm flag	0: OFF 1: Forced stand-by Automatically returned to "0".
4529 to 4576			

Key (4705 to 4768)

I relay No.	Symbol	Event	
4705 to 4720	PARA_KEY to FN_KEY	Key status (Same as D6301)	
4721 to 4768			

Display, PV Event Status and Time Event Status (4769 to 5024)

I relay No.	Symbol	Event	
4769 to 4773	MG1.B to MG4.B	Message display interruption status (Same as D2066)	
4779	PV_RED_WHITE	PV red/white switch	0: WHITE 1: RED
4785 to 4832			

13.3.2 Status for Input/Output Relay

Note

When specifying an I relay number for communication, begin the number with the character "I."
Example: Set "I5025" to specify the X_DI1 (I relay No.: 5025).

13.3 UT35A-L I Relays

Input (status) relay			Input (status) relay		
NO.	I relay symbol	R/W UT35A-L	NO.	I relay symbol	R/W UT35A-L
5025	X_DI1	R	5089		
5026	X_DI2	R	5090		
5027			5091		
5028			5092		
5029			5093		
5030			5094		
5031			5095		
5032			5096		
5033			5097		
5034			5098		
5035			5099		
5036			5100		
5037			5101		
5038			5102		
5039			5103		
5040			5104		
5041			5105		
5042			5106		
5043			5107		
5044			5108		
5045			5109		
5046			5110		
5047			5111		
5048			5112		
5049			5113		
5050			5114		
5051			5115		
5052			5116		
5053			5117		
5054			5118		
5055			5119		
5056			5120		
5057			5121		
5058			5122		
5059			5123		
5060			5124		
5061			5125		
5062			5126		
5063			5127		
5064			5128		
5065			5129		
5066			5130		
5067			5131		
5068			5132		
5069			5133		
5070			5134		
5071			5135		
5072			5136		
5073			5137		
5074			5138		
5075			5139		
5076			5140		
5077			5141		
5078			5142		
5079			5143		
5080			5144		
5081			5145		
5082			5146		
5083			5147		
5084			5148		
5085			5149		
5086			5150		
5087			5151		
5088			5152		

Output (status) relay			Output (status) relay		
NO.	I relay symbol	R/W	NO.	I relay symbol	R/W
		UT35A/UT32A			UT35A/UT32A
5153	Y_AL1	R/W	5217		
5154	Y_AL2	R/W	5218		
5155	Y_AL3	R/W	5219		
5156			5220		
5157			5221		
5158			5222		
5159			5223		
5160			5224		
5161			5225		
5162			5226		
5163			5227		
5164			5228		
5165			5229		
5166			5230		
5167			5231		
5168			5232		
5169			5233		
5170			5234		
5171			5235		
5172			5236		
5173			5237		
5174			5238		
5175			5239		
5176			5240		
5177			5241		
5178			5242		
5179			5243		
5180			5244		
5181			5245		
5182			5246		
5183			5247		
5184			5248		
5185			5249		
5186			5250		
5187			5251		
5188			5252		
5189			5253		
5190			5254		
5191			5255		
5192			5256		
5193			5257		
5194			5258		
5195			5259		
5196			5260		
5197			5261		
5198			5262		
5199			5263		
5200			5264		
5201			5265		
5202			5266		
5203			5267		
5204			5268		
5205			5269		
5206			5270		
5207			5271		
5208			5272		
5209			5273		
5210			5274		
5211			5275		
5212			5276		
5213			5277		
5214			5278		
5215			5279		
5216			5280		

13.3 UT35A-L I Relays

Input (Status) Relay and Output (Status) Relay (5025 to 5280)

I relay No.	Symbol	Description
5025 to 5040	X_DI1 to X_DI2	DI1-DI2 status (Same as D7011)
5041 to 5056		
5057 to 5072		
5073 to 5088		
5089 to 5104		
5105 to 5152		
5153 to 5168	Y_AL1 to Y_AL3	AL1-AL3 status (Same as D7161)
5169 to 5184		
5185 to 5200		
5201 to 5216		
5217 to 5232		
5233 to 5280		

13.3.3 Input / Output Terminal Status (6305 to 6560)

Note

When specifying an I relay number for communication, begin the number with the character "I."
Example: Set "I6305" to specify the DI1 (I relay No.: 6305).

13.3 UT35A-L I Relays

DI terminals			DI terminals		
NO.	I relay symbol	R/W	NO.	I relay symbol	R/W
		UT35A-L			UT35A-L
6305	DI1	R	6369		
6306	DI2	R	6370		
6307			6371		
6308			6372		
6309			6373		
6310			6374		
6311			6375		
6312			6376		
6313			6377		
6314			6378		
6315			6379		
6316			6380		
6317			6381		
6318			6382		
6319			6383		
6320			6384		
6321			6385		
6322			6386		
6323			6387		
6324			6388		
6325			6389		
6326			6390		
6327			6391		
6328			6392		
6329			6393		
6330			6394		
6331			6395		
6332			6396		
6333			6397		
6334			6398		
6335			6399		
6336			6400		
6337			6401		
6338			6402		
6339			6403		
6340			6404		
6341			6405		
6342			6406		
6343			6407		
6344			6408		
6345			6409		
6346			6410		
6347			6411		
6348			6412		
6349			6413		
6350			6414		
6351			6415		
6352			6416		
6353			6417		
6354			6418		
6355			6419		
6356			6420		
6357			6421		
6358			6422		
6359			6423		
6360			6424		
6361			6425		
6362			6426		
6363			6427		
6364			6428		
6365			6429		
6366			6430		
6367			6431		
6368			6432		

DO terminals			DO terminals		
NO.	I relay symbol	R/W	NO.	I relay symbol	R/W
		UT35A-L			UT35A-L
6433	OUT_AL1	R	6497		
6434	OUT_AL2	R	6498		
6435	OUT_AL3	R	6499		
6436			6500		
6437			6501		
6438			6502		
6439			6503		
6440			6504		
6441			6505		
6442			6506		
6443			6507		
6444			6508		
6445			6509		
6446			6510		
6447			6511		
6448			6512		
6449			6513		
6450			6514		
6451			6515		
6452			6516		
6453			6517		
6454			6518		
6455			6519		
6456			6520		
6457			6521		
6458			6522		
6459			6523		
6460			6524		
6461			6525		
6462			6526		
6463			6527		
6464			6528		
6465			6529		
6466			6530		
6467			6531		
6468			6532		
6469			6533		
6470			6534		
6471			6535		
6472			6536		
6473			6537		
6474			6538		
6475			6539		
6476			6540		
6477			6541		
6478			6542		
6479			6543		
6480			6544		
6481			6545		
6482			6546		
6483			6547		
6484			6548		
6485			6549		
6486			6550		
6487			6551		
6488			6552		
6489			6553		
6490			6554		
6491			6555		
6492			6556		
6493			6557		
6494			6558		
6495			6559		
6496			6560		

6561 to 7072: Free area

13.3 UT35A-L I Relays

DI Terminals and DO Terminals (6305 to 6560)

I relay No.	Symbol	Description
6305 to 6320	DI1 to DI2	DI1-DI2 status (Same as D7601)
6321 to 6336		
6337 to 6352		
6353 to 6368		
6369 to 6384		
6385 to 6432		
6433 to 6448	OUT_AL1 to OUT_AL3	AL1-AL3 status (Same as D7611)
6449 to 6464		
6465 to 6480		
6481 to 6496		
6497 to 6512		
6513 to 6560		

13.4 Reading via Communication

■ When reading the alarm status

Read I relay numbers 4321 to 4336 for alarm-1 to alarm-3 status.

I relay No.	Symbol	Event
4321 to 4336	ALM1_L1~ALM3_L1	Alarm-1 to alarm-3 status (Same as D2011) *
⋮	⋮	⋮
4545 to 4576		

*: The contents of alarm-1 to alarm-4 status (I relay numbers 4321 to 4336: ALM1_L1 to ALM4_L1) are the same as the bit configuration of D register number D2011 (alarm-1 to alarm-4 status). Refer to the bit configuration of D2011 described in “Chapter 12 Functions and Applications of D Registers (for UT35A).”

The following shows the bit configuration of D2011 described in “Chapter 12 Functions and Applications of D Registers (for UT35A-L).”

● Bit Configuration of D2011: ALM_L1 (Alarm-1 to alarm-4 status)

Bit	Symbol	Event
0	ALM1_L1	'1' when alarm 1 is ON; '0' when OFF
1	ALM2_L1	'1' when alarm 2 is ON; '0' when OFF
2	ALM3_L1	'1' when alarm 3 is ON; '0' when OFF
3		
4		
5 to 15		

Note

When specifying an I relay number for communication, begin the number with the character “I.”
Example: Set “I4321” to specify the ALM1_L1 (I relay No.: 4321).

13.5 GREEN Series Compatible I Relays

13.5.1 Compatibility with GREEN Series Controllers

The map configuration from 1 to 2048 of the I relay map is the same as that of the GREEN Series (UT300 Series) controllers.

If existing programs created in the GREEN Series controllers are used, communication is performed using the area from 0001 to 0784.

The I relay map after 4001 is allocated for the UTAdvanced.

If you want to newly perform communication, be sure to use the registers after 4001.

13.5.2 Conventions Used in I Relay Tables

■ How to Specify I Relay Numbers

When specifying an I relay number for communication, begin the number with the character "I."

Example: Set "I0001" to specify the ADERR (I relay No.: 0001).

■ Interpretation of Cell

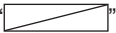
A cell marked with a diagonal line (") indicates that it is not supported by the UTAdvanced.

■ I relay symbol

- With regards to some register symbols, the loop number is indicated by adding the underline () to the end of the parameter symbols.

Note

Since the UT35A/UT32A is a limit controller, it has no distinction between Loop-1 and Loop-2. However, the register symbol has "L1" which indicates Loop-1.

□□□□ L1 L1: Loop numbers

Example : PVBO L1 Indicates PVBO.

- Numbers in parentheses after the register symbols of the UTAdvanced indicate the same I relay after I4001.

Note

-
- I relay numbers 1 to 192 store ON/OFF status information and are normally read for ON/OFF status information. I relay numbers 1 to 192 also exists in D registers. They have the same function data as D registers.
 - In the area for I relay numbers 1 to 720, it is prohibited to write data to I relays with blank cells in I relay map tables. If you attempt to do so, the UTAdvanced may not operate properly.
-

13.5.3 Status (0001 to 0192)

NO.	I relay symbol		NO.	Status		NO.	I relay symbol	
	GREEN	UTAdvanced		GREEN	UTAdvanced		GREEN	UTAdvanced
	1	ADERROR		ADERR (4065)	65			
2			66	EXD	EXD (4205)	130		
3			67	OUT	OUT (4206)	131		
4			68			132		
5			69			133		
6			70			134		
7			71			135		
8			72			136		
9			73			137		
10			74			138		
11			75			139		
12			76			140		
13			77			141		
14			78			142		
15			79			143		
16			80			144		
17			81			145		
18	PVBO	PVBO_L1 (4097)	82			146		
19	RJCERR	RJCERR (4070)	83			147		
20			84			148		
21	PV+over	PVPOVER_L1 (4101)	85			149		
22	PV-over	PVMOVER_L1 (4102)	86			150		
23			87			151		
24			88			152		
25			89			153		
26			90			154		
27			91			155		
28			92			156		
29			93			157		
30			94			158		
31			95			159		
32			96			160		
33			97	ALM1	ALM1_L1 (4321)	161		
34			98	ALM2	ALM2_L1 (4322)	162		
35			99			163		
36			100			164		
37			101			165		
38			102			166		
39			103			167		
40			104			168		
41			105			169		
42			106			170		
43			107			171		
44			108			172		
45			109			173		
46			110			174		
47			111			175		
48			112			176		
49	CALB.E	CALB_ERR (4002)	113			177		
50			114			178		
51			115			179		
52			116			180		
53			117			181		
54			118			182		
55	SETUP	SETPA_ERR (4005)	119			183		
56			120			184		
57	PARA.E	OPEPA_ERR (4006)	121			185		
58			122			186		
59			123			187		
60			124			188		
61	EEP.E	FRAM_ERR (4009)	125			189		
62			126			190		
63	SYSTEM.E	SYSTEM_ERR (4001)	127			191		
64			128			192		

193 to 640: Free area

13.5 GREEN Series Compatible I Relays

I relay No.	Symbol	Description
1 to 16	ADERR	A/D converter error status for GREEN Series (Same as 0001)
17 to 32	PVBO_L1 to ATERR_L1	PV input error status for GREEN Series (Same as 0002)
33 to 48		
49 to 64	CALB_ERR to SYSTEM_ERR	Parameter error status for GREEN Series (Same as 0035)
65 to 80	EXD to OUT	EXCEED flag and OUT relay flag
	AT_L1_ON	Operation mode status for GREEN Series (Same as 0008)
81 to 96		
97 to 112		
113 to 192		

193 to 720: Free area

13.5.4 User Area (0721 to 784)

I relay No.	I relay symbol	Description	
721 to 784	USER	User area	You can read/write data from/to the area for I relays 721 to 784 via communication. That is, you can use the area freely without affecting the control function of the UT35A-L. However, the data cannot be saved.

14.1 Overview

This chapter describes the functions and applications of the D registers. D registers are used in Modbus, PC link, ladder, Ethernet communications, or Open Network communication (network profile creating function of LL50A) and are used for storing UTAdvanced parameter data, flag data, process data, and other data and values. The host computer can utilize these data by reading from and writing to the D registers. When you newly perform communication with the UTAdvanced, the D registers after D2001 are used.

Use of the D registers enables the following:

- Centralized control by the host computer
- Reading and writing of data between the UTAdvanced and the host computer

Note

The D registers available vary depending on the model and suffix codes of the UTAdvanced or parameter settings. For details, refer to the respective UTAdvanced User's Manual.

D registers and I relays on the UTAdvanced are used for parameter settings or ladder program creations of LL50A Parameter Setting Software.

14.3 Classification of D Registers

■ Classification of D Register Map Tables

The table on next page outlines how the D registers are classified by their numbers in the D register map tables.

When you newly perform communication with the UTAdvanced, the D registers after D2001 are used.

CAUTION

- Check the model and suffix codes and parameter settings before writing to or read from the registers to be used.
- No data can be written to or read from blank parts of the data storage area by communication.
The UTAdvanced sometimes does not operate properly if an attempt is made to write to or read from blank parts of the data storage area.

■ Setting a Value with a Decimal Point

When setting a value with a decimal point from the host computer, set a value excluding the decimal point (hexadecimal)*.

Note

The UTAdvanced determine the decimal point position by the parameter setting.

Example: When setting a target setpoint "50.0" from the host computer

Set "1F4" which is a hexadecimal value of "500" (50.0 excluding the decimal point) (this is also true for setting 5.00 or 500).

Target setpoint "50.0": P.DP = 1

Target setpoint "5.00": P.DP = 2

Target setpoint "500": P.DP = 0

*: For ladder operation, set the BCD value excluding the decimal point.

14.3 Classification of D Registers

Classification of D Registers

Register No.	Area and data categories	Description	Reference
D0001 to D0049	Configuration map for GREEN Series (See 14.6 GREEN Series Compatible D Registers)	Process data	Sections 14.6.3
D0050 to D0100		User area	Sections 14.6.3
D0101 to D0200		Free area	
D0201 to D0230		Operation mode parameter	Sections 14.6.4
D0231 to D0300		Operation-related parameter	Sections 14.5.4
D0301 to D0700		PID parameter	Sections 14.6.5, 14.5.6
D0701 to D0800		10-segment linearizer parameters and USER parameter	Sections 14.6.7
D0801 to D0900		Message text	Sections 14.6.8
D0901 to D1000		Control action parameter	Sections 14.6.9
D1001 to D1100		Loop-common function parameter	Sections 14.6.10
D1101 to D1200		Display and I/O configuration parameter	Sections 14.6.11
D1201 to D1300		Controller mode, PV input, and control output parameter	Sections 14.6.12
D1301 to D2000		Free area	
D2001 to D2100	Process monitoring	Process data	Sections 14.4.1
D2101 to D2200		Current SP group and PID group	
D2201 to D2300	Free area	Free area	
D2301 to D2400	Operation mode parameter	Loop-1 / Loop-2 operation mode	Sections 14.4.2
D2401 to D2500	Free area	Free area	
D2501 to D2700	Loop-1 operation parameter (group 1 to 8)	SP and alarm setpoint setting	Sections 14.4.3
D2701 to D2800		SP-related setting	
D2801 to D2900		Alarm function setting	
D2901 to D3000		PV-related setting	
D3001 to D3500		PID setting	
D3501 to D3600	Control action-related setting		
D3601 to D3800	Loop-2 operation parameter (group 1 to 8)	SP and alarm setpoint setting	Sections 14.4.4
D3801 to D3900		SP-related setting	
D3901 to D4000		Alarm function setting	
D4001 to D4100		PV-related setting	
D4101 to D4600		PID setting	
D4601 to D4690	Control action-related setting		
D4691 to D4700	Custom display register	Custom display register	
D4701 to D4800	P parameter	P parameter	Sections 14.4.5
D4801 to D5000	10-segment linearizer setting parameter	10-segment linearizer setting	Sections 14.4.6
D5001 to D5100	Setup parameter	Control function setting	Sections 14.4.7
D5101 to D5300		Input setting	
D5301 to D5400		Output setting	
D5401 to D5500		Free area	
D5501 to D5700		Communication setting	
D5701 to D5800		Key action setting / Display function setting / SELECT display setting	
D5801 to D5900		Lock setting (Key lock / menu lock)	
D5901 to D6200		DI function setting	
D6201 to D6300		DO function setting	
D6301 to D6400		I/O display	
D6401 to D6500		System setting	
D6501 to D7000	Free area	Free area	
D7001 to D7100	Registers for ladder program	For input ladder calculation	Sections 14.4.8
D7101 to D7200		For output ladder calculation	
D7201 to D7300		Status register	
D7301 to D7500		Constant register	
D7501 to D7600		Input range / scale	
D7601 to D7700	Terminal status register	Input / Output terminal status register	Sections 14.4.9
D7701 to D7900	Program pattern parameter	Pattern data setting	Sections 14.4.10
D7901 to D9000	Free area	Free area	
D9001 to D9200	Loop-1 operation parameter (group 9 to 20)	SP and alarm setpoint setting	Sections 14.4.11
D9201 to D9400		PID setting	
D9401 to D9700	Loop-2 operation parameter (group 9 to 20)	SP and alarm setpoint setting	
D9701 to D10000		PID setting	

Note 1: Data in the process values, operation parameters, and setup parameters is stored in the format (data excluding the decimal point of PV input range, PV input range span, %, or ABS) described in "Lists of Operation Parameters" and "Lists of Setup Parameters" in the UTAdvanced Operation Guide or User's Manual. The OFF status of data is indicated by "0" and the ON status is indicated by "1."
D registers D2001 to D2100 are read-only.

14.4 UT75A D Registers

14.4.1 Process Monitoring (D2001 to D2200)

Process monitoring area									
Process data									
D-Reg No.	Ref. No.	H No.	Register symbol	R/W	D-Reg No.	Ref. No.	H No.	Register symbol	R/W
				UT75A					UT75A
D2001	42001	07D0	AD1.E	R	D2051	42051	0802		
D2002	42002	07D1	PV1.E_L1	R	D2052	42052	0803		
D2003	42003	07D2	PV_L1	R	D2053	42053	0804		
D2004	42004	07D3	CSP_L1	R	D2054	42054	0805		
D2005	42005	07D4	OUT_L1	R	D2055	42055	0806		
D2006	42006	07D5	H.OUT_L1	R	D2056	42056	0807		
D2007	42007	07D6	C.OUT_L1	R	D2057	42057	0808		
D2008	42008	07D7	MOD_L1	R	D2058	42058	0809		
D2009	42009	07D8	PID_L1	R	D2059	42059	080A		
D2010	42010	07D9	CSPNO.	R	D2060	42060	080B		
D2011	42011	07DA	ALM_L1	R	D2061	42061	080C		
D2012	42012	07DB	LA.ER	R	D2062	42062	080D		
D2013	42013	07DC	ALM_L2	R	D2063	42063	080E		
D2014	42014	07DD			D2064	42064	080F	VALV	R
D2015	42015	07DE			D2065	42065	0810	AD2.E	R
D2016	42016	07DF			D2066	42066	0811	DIMG	R
D2017	42017	07E0			D2067	42067	0812		
D2018	42018	07E1	PV2.E_L2	R	D2068	42068	0813	PA.ER	R
D2019	42019	07E2	PV_L2	R	D2069	42069	0814		
D2020	42020	07E3	CSP_L2	R	D2070	42070	0815	OP.ER	R
D2021	42021	07E4	OUT_L2	R	D2071	42071	0816	ALOLA1_L1	R
D2022	42022	07E5	H.OUT_L2	R	D2072	42072	0817	ALOLA1_L2	R
D2023	42023	07E6	C.OUT_L2	R	D2073	42073	0818	ALOLA2_L1	R
D2024	42024	07E7	MOD_L2	R	D2074	42074	0819	ALOLA2_L2	R
D2025	42025	07E8	PID_L2	R	D2075	42075	081A	ALOLA3_L1	R
D2026	42026	07E9			D2076	42076	081B	ALOLA3_L2	R
D2027	42027	07EA			D2077	42077	081C	ALOLA4_L1	R
D2028	42028	07EB			D2078	42078	081D	ALOLA4_L2	R
D2029	42029	07EC	SEG.N	R	D2079	42079	081E		
D2030	42030	07ED	SEG_RUNTIME	R	D2080	42080	081F		
D2031	42031	07EE	REM_RCY	R	D2081	42081	0820		
D2032	42032	07EF			D2082	42082	0821		
D2033	42033	07F0			D2083	42083	0822		
D2034	42034	07F1			D2084	42084	0823		
D2035	42035	07F2	DEV_L1	R	D2085	42085	0824		
D2036	42036	07F3	DEV_L2	R	D2086	42086	0825		
D2037	42037	07F4	ALO_L1	R	D2087	42087	0826		
D2038	42038	07F5	ALO_L2	R	D2088	42088	0827		
D2039	42039	07F6			D2089	42089	0828		
D2040	42040	07F7			D2090	42090	0829		
D2041	42041	07F8			D2091	42091	082A		
D2042	42042	07F9			D2092	42092	082B		
D2043	42043	07FA			D2093	42093	082C		
D2044	42044	07FB			D2094	42094	082D		
D2045	42045	07FC			D2095	42095	082E		
D2046	42046	07FD			D2096	42096	082F		
D2047	42047	07FE			D2097	42097	0830		
D2048	42048	07FF			D2098	42098	0831		
D2049	42049	0800			D2099	42099	0832		
D2050	42050	0801			D2100	42100	0833		

14.4 UT75A D Registers

Process monitoring area									
Current SP group and PID group									
D-Reg No.	Ref. No.	H No.	Register symbol	R/W	D-Reg No.	Ref. No.	H No.	Register symbol	R/W
				UT75A					UT75A
D2101	42101	0834	SP_L1_*	R/W	D2151	42151	0866	SP_L2_*	R/W
D2102	42102	0835	SUB_*	R/W	D2152	42152	0867		
D2103	42103	0836	PIDN_L1_*	R/W	D2153	42153	0868	PIDN_L2_*	R/W
D2104	42104	0837	A1_L1_*	R/W	D2154	42154	0869	A1_L2_*	R/W
D2105	42105	0838	A2_L1_*	R/W	D2155	42155	086A	A2_L2_*	R/W
D2106	42106	0839	A3_L1_*	R/W	D2156	42156	086B	A3_L2_*	R/W
D2107	42107	083A	A4_L1_*	R/W	D2157	42157	086C	A4_L2_*	R/W
D2108	42108	083B	A5_L1_*	R/W	D2158	42158	086D	A5_L2_*	R/W
D2109	42109	083C	A6_L1_*	R/W	D2159	42159	086E	A6_L2_*	R/W
D2110	42110	083D	A7_L1_*	R/W	D2160	42160	086F	A7_L2_*	R/W
D2111	42111	083E	A8_L1_*	R/W	D2161	42161	0870	A8_L2_*	R/W
D2112	42112	083F	UPR_L1_*	R/W	D2162	42162	0871	UPR_L2_*	R/W
D2113	42113	0840	DNR_L1_*	R/W	D2163	42163	0872	DNR_L2_*	R/W
D2114	42114	0841	P_L1_*	R/W	D2164	42164	0873	P_L2_*	R/W
D2115	42115	0842	I_L1_*	R/W	D2165	42165	0874	I_L2_*	R/W
D2116	42116	0843	D_L1_*	R/W	D2166	42166	0875	D_L2_*	R/W
D2117	42117	0844	OH_L1_*	R/W	D2167	42167	0876	OH_L2_*	R/W
D2118	42118	0845	OL_L1_*	R/W	D2168	42168	0877	OL_L2_*	R/W
D2119	42119	0846	MR_L1_*	R/W	D2169	42169	0878	MR_L2_*	R/W
D2120	42120	0847	HYS_L1_*	R/W	D2170	42170	0879	HYS_L2_*	R/W
D2121	42121	0848	SU.HY_L1_*	R/W	D2171	42171	087A		
D2122	42122	0849	HY.UP_L1_*	R/W	D2172	42172	087B	HY.UP_L2_*	R/W
D2123	42123	084A	HY.LO_L1_*	R/W	D2173	42173	087C	HY.LO_L2_*	R/W
D2124	42124	084B	DR_L1_*	R/W	D2174	42174	087D	DR_L2_*	R/W
D2125	42125	084C	SU.DR_*	R/W	D2175	42175	087E		
D2126	42126	084D	Pc_L1_*	R/W	D2176	42176	087F	Pc_L2_*	R/W
D2127	42127	084E	Ic_L1_*	R/W	D2177	42177	0880	Ic_L2_*	R/W
D2128	42128	084F	Dc_L1_*	R/W	D2178	42178	0881	Dc_L2_*	R/W
D2129	42129	0850	OHc_L1_*	R/W	D2179	42179	0882	OHc_L2_*	R/W
D2130	42130	0851	OLc_L1_*	R/W	D2180	42180	0883	OLc_L2_*	R/W
D2131	42131	0852	HYSc_L1_*	R/W	D2181	42181	0884	HYSc_L2_*	R/W
D2132	42132	0853	DB_L1_*	R/W	D2182	42182	0885	DB_L2_*	R/W
D2133	42133	0854	PO_L1_*	R/W	D2183	42183	0886	PO_L2_*	R/W
D2134	42134	0855	SU.PO_*	R/W	D2184	42184	0887		
D2135	42135	0856	POc_L1_*	R/W	D2185	42185	0888	POc_L2_*	R/W
D2136	42136	0857			D2186	42186	0889		
D2137	42137	0858			D2187	42187	088A		
D2138	42138	0859			D2188	42188	088B		
D2139	42139	085A			D2189	42189	088C		
D2140	42140	085B			D2190	42190	088D		
D2141	42141	085C			D2191	42191	088E		
D2142	42142	085D			D2192	42192	088F		
D2143	42143	085E			D2193	42193	0890		
D2144	42144	085F			D2194	42194	0891		
D2145	42145	0860			D2195	42195	0892		
D2146	42146	0861			D2196	42196	0893		
D2147	42147	0862			D2197	42197	0894		
D2148	42148	0863			D2198	42198	0895		
D2149	42149	0864			D2199	42199	0896		
D2150	42150	0865			D2200	42200	0897		

See the next page regarding “*.”

- *: The group number to be displayed varies depending on the currently used SP number selection (D2312) and PID number (D2009, D2025).
1 to 20 is written in D2101 to D2112 and D2151 to D2163.
1 to 16, or R (currently used group number) is written in D2114 to D2135 and D2164 to D2185.

14.4 UT75A D Registers

Process Data Area

Some of the D registers represent multiple events such as errors and status depending on combinations of bits in the register.

In the following tables, if an event indicated by a specific bit occurs, the state of that bit changes to "1."

If no event occurs, the state of that bit is "0." Blank lines in each table indicate unused bits.

Process Data (D2001 to D2100)

● Bit Configuration of D2001: AD1.E (A/D converter error status 1)

Bit	Symbol	Event
0	ADERR	PV input A/D converter error
1	ADERR_E1	PV2 input (E1-terminal area) A/D converter error
2	ADERR_E2	AIN2 input (E2-terminal area) A/D converter error
3		
4	ADERR_E4	AIN4 input (E4-terminal area) A/D converter error
5	RJCERR	PV input RJC error
6	RJCERR_E1	PV2 input RJC error
7		
8	ADBO	PV input burnout error
9	ADBO_E1	PV2 input (E1-terminal area) burnout error
10	ADBO_E2	AIN2 input (E2-terminal area) burnout error
11		
12	ADBO_E4	AIN4 input (E4-terminal area) burnout error
13 to 15		

● Bit Configuration of D2002: PV1.E_L1 (Loop-1 PV input error status)

Bit	Symbol	Event
0	PVBO_L1	Loop-1 PV input burnout error
1	PV2BO_L1	Loop-1 PV2 input burnout error
2	CPV2BO_L1	Burnout error when the Loop-1 PV2 input is used for control.
3		
4	PVPOVER_L1	Loop-1 PV input over-scale
5	PVMOVER_L1	Loop-1 PV input under-scale
6 to 13		
14	ATERR_L1	Loop-1 auto-tuning timeout error
15		

● D2003 to D2007

Register No.	Description		Range and meaning of value
D2003	PV_L1	Loop-1 measurement value	-5.0 to 105.0% of PV input range (EU)
D2004	CSP_L1	Loop-1 control setpoint	0.0 to 100.0% of PV input range (EU) (Setting range: SPL to SPH)
D2005	OUT_L1	Loop-1 control output	-5.0 to 105.0%
D2006	H.OUT_L1	Heating-side control output	-5.0 to 105.0% (In Heating/cooling control: 0.0 to 105.0%)
D2007	C.OUT_L1	Cooling-side control output	0.0 to 105.0%

● **Bit Configuration of D2008: MOD_L1 (Loop-1 operation mode status)**

Bit	Symbol	Event
0	A.M_L1	0: AUTO, 1: MAN *1
1	R.L_L1	0: Local, 1: Remote
2	S.R_L1	0: Run, 1: Stop
3		
4	CAS_ON	1: CAS *2
5	AUTO_ON	1: AUTO *2
6	MAN_ON	1: MAN *2
7		
8	TRK_ON_L1	1: Output tracking
9		
10 to 13		
14	AT_L1_ON	0: Auto-tuning is OFF, 1: Auto-tuning is ON
15		

*1: Effective for the control modes except for cascade control and cascade secondary-loop control.

*2: Effective for cascade control mode and cascade secondary-loop control mode.

● **Bit Configuration of D2009: PID_L1 (Current PID number for Loop-1)**

Bit	Symbol	Event
0	PIDN.B0_L1	Loop-1 bit-0 of the PID number
1	PIDN.B1_L1	Loop-1 bit-1 of the PID number
2	PIDN.B2_L1	Loop-1 bit-2 of the PID number
3	PIDN.B3_L1	Loop-1 bit-3 of the PID number
4	PIDN.B4_L1	Loop-1 bit-4 of the PID number
5 to 15		

● **Bit Configuration of D2010: CSPNO. (Current control setpoint number)**

Bit	Symbol	Event
0	CCSPN.B0	Bit-0 of control setpoint number
1	CCSPN.B1	Bit-1 of control setpoint number
2	CCSPN.B2	Bit-2 of control setpoint number
3	CCSPN.B3	Bit-3 of control setpoint number
4	CCSPN.B4	Bit-4 of control setpoint number
5 to 15		

● **Bit Configuration of D2011: ALM_L1 (Loop-1 alarm-1 to alarm-8 status)**

Bit	Symbol	Event
0	ALM1_L1	'1' when Loop-1 alarm 1 is ON; '0' when OFF
1	ALM2_L1	'1' when Loop-1 alarm 2 is ON; '0' when OFF
2	ALM3_L1	'1' when Loop-1 alarm 3 is ON; '0' when OFF
3		
4	ALM4_L1	'1' when Loop-1 alarm 4 is ON; '0' when OFF
5	ALM5_L1	'1' when Loop-1 alarm 5 is ON; '0' when OFF
6	ALM6_L1	'1' when Loop-1 alarm 6 is ON; '0' when OFF
7		
8	ALM7_L1	'1' when Loop-1 alarm 7 is ON; '0' when OFF
9	ALM8_L1	'1' when Loop-1 alarm 8 is ON; '0' when OFF
10 to 15		

14.4 UT75A D Registers

● Bit Configuration of D2012: LA.ER (Ladder error status)

Bit	Symbol	Event
0	LAD_ERR	Corrupted ladder program
1	LAD_OVER	Ladder calculation overflow
2	LAD_P_ERR	Ladder program error
3		
4	LD100_OVER	Load factor over 100%
5	LD200_OVER	Load factor over 200% (Forced end)
6 to 15		

● Bit Configuration of D2013: ALM_L2 (Loop-2 alarm-1 to alarm-8 status)

Bit	Symbol	Event
0	ALM1_L2	'1' when Loop-2 alarm 1 is ON; '0' when OFF
1	ALM2_L2	'1' when Loop-2 alarm 2 is ON; '0' when OFF
2	ALM3_L2	'1' when Loop-2 alarm 3 is ON; '0' when OFF
3		
4	ALM4_L2	'1' when Loop-2 alarm 4 is ON; '0' when OFF
5	ALM5_L2	'1' when Loop-2 alarm 5 is ON; '0' when OFF
6	ALM6_L2	'1' when Loop-2 alarm 6 is ON; '0' when OFF
7		
8	ALM7_L2	'1' when Loop-2 alarm 7 is ON; '0' when OFF
9	ALM8_L2	'1' when Loop-2 alarm 7 is ON; '0' when OFF
10 to 15		

● Bit Configuration of D2018: PV2.E_L2 (Loop-2 PV input error status)

Bit	Symbol	Event
0	PVBO_L2	Loop-2 PV input burnout error
1	PV2BO_L2	Loop-2 PV2 input burnout error
2	CPV2BO_L2	Burnout error when the Loop-2 PV2 input is used for control.
3		
4	PVPOVER_L2	Loop-2 PV input over-scale
5	PVMOVER_L2	Loop-2 PV input under-scale
6 to 13		
14	ATERR_L2	Loop-2 auto-tuning timeout error
15		

● D2019 to D2023

Register No.	Symbol	Description	Range and meaning of value
D2019	PV_L2	Loop-2 measurement value	-5.0 to 105.0% of PV input range (EU)
D2020	CSP_L2	Loop-2 control setpoint	0.0 to 100.0% of PV input range (EU) (Setting range: SPL to SPH)
D2021	OUT_L2	Loop-2 control output	-5.0 to 105.0%
D2022	H.OUT_L2	Heating-side control output	-5.0 to 105.0% (In Heating/cooling control: 0.0 to 105.0%)
D2023	C.OUT_L2	Cooling-side control output	0.0 to 105.0%

● Bit Configuration of D2024: MOD_L2 (Loop-2 operation mode status)

Bit	Symbol	Event
0	A.M_L2	0: AUTO, 1: MAN
1	R.L_L2	0: Local, 1: Remote
2	S.R_L2	0: Run, 1: Stop
3 to 13		
14	AT_L2_ON	0: Auto-tuning is OFF, 1: Auto-tuning is ON
15		

● Bit Configuration of D2025: PID_L2 (Current PID number for Loop 2)

Bit	Symbol	Event
0	PIDN.B0_L2	Loop-2 bit-0 of the PID number
1	PIDN.B1_L2	Loop-2 bit-1 of the PID number
2	PIDN.B2_L2	Loop-2 bit-2 of the PID number
3	PIDN.B3_L2	Loop-2 bit-3 of the PID number
4	PIDN.B4_L2	Loop-2 bit-4 of the PID number
5 to 15		

● D2029 to D2031

Register No.	Description		Range and meaning of value
D2029	SEG.N	Current segment number currently in operation	0: Not executing. 1 to 20
D2030	SEG_RUNTIME	Remaining segment-time during operation/Elapsed time during wait.	0 to 59999 (minute or second) * Use the parameter TMU to set the time unit.
D2031	REM_RCY	Number of repeat cycles	0 to 999, 1000 (R.CYCL=CONT (limitless number of times))

● D2035 to D2036

Register No.	Description		Range and meaning of value
D2035	DEV_L1	Loop-1 deviation	-105.0 to 105.0% of PV input range (EU)
D2036	DEV_L2	Loop-2 deviation	-105.0 to 105.0% of PV input range (EU)

● Bit Configuration of D2037: ALO_L1 (Loop-1 alarm-1 to alarm-8 output status)

Bit	Symbol	Event
0	ALO1_L1	Output status where Loop-1 alarm output 1 is assigned. 0: When the alarm is turned off (alarm type: energized), or the alarm is turned on (alarm type: de-energized). (The relay contact is open.) 1: When the alarm is turned on (alarm type: energized), or the alarm is turned off (alarm type: de-energized). (The relay contact is closed.)
1	ALO2_L1	Output status where Loop-1 alarm output 2 is assigned. For bit information, same as bit 0.
2	ALO3_L1	Output status where Loop-1 alarm output 3 is assigned. For bit information, same as bit 0.
3		
4	ALO4_L1	Output status where Loop-1 alarm output 4 is assigned. For bit information, same as bit 0.
5	ALO5_L1	Output status where Loop-1 alarm output 5 is assigned. For bit information, same as bit 0.
6	ALO6_L1	Output status where Loop-1 alarm output 6 is assigned. For bit information, same as bit 0.
7		
8	ALO7_L1	Output status where Loop-1 alarm output 7 is assigned. For bit information, same as bit 0.
9	ALO8_L1	Output status where Loop-1 alarm output 8 is assigned. For bit information, same as bit 0.
10 to 15		

● Bit Configuration of D2038: ALO_L2 (Loop-2 alarm-1 to alarm-8 output status)

Bit	Symbol	Event
0	ALO1_L2	Output status where Loop-2 alarm output 1 is assigned. 0: When the alarm is turned off (alarm type: energized), or the alarm is turned on (alarm type: de-energized). (The relay contact is open.) 1: When the alarm is turned on (alarm type: energized), or the alarm is turned off (alarm type: de-energized). (The relay contact is closed.)
1	ALO2_L2	Output status where Loop-2 alarm output 2 is assigned. For bit information, same as bit 0.
2	ALO3_L2	Output status where Loop-2 alarm output 3 is assigned. For bit information, same as bit 0.
3		
4	ALO4_L2	Output status where Loop-2 alarm output 4 is assigned. For bit information, same as bit 0.
5	ALO5_L2	Output status where Loop-2 alarm output 5 is assigned. For bit information, same as bit 0.
6	ALO6_L2	Output status where Loop-2 alarm output 6 is assigned. For bit information, same as bit 0.
7		
8	ALO7_L2	Output status where Loop-2 alarm output 7 is assigned. For bit information, same as bit 0.
9	ALO8_L2	Output status where Loop-2 alarm output 8 is assigned. For bit information, same as bit 0.
10 to 15		

● Bit Configuration of D2064: VALV (Valve status)

Bit	Symbol	Event
0	VALV_GUSS	0: Operation by feedback input 1: Operation by estimating type
1	VALV_OPEN	0: Output off, 1: Output on
2	VALV_CLOSE	0: Output off, 1: Output on
3	VALV_AT	0: Stop automatic valve position adjustment 1: Automatic valve position adjustment
4 to 15		

● Bit Configuration of D2065: AD2.E (A/D converter error status 2)

Bit	Symbol	Event
0	VALVBO	Feedback input resistor/current burnout
1	VALV_ATERR	Valve position automatic adjustment error
2 to 15		

● Bit Configuration of D2066: DIMG (Message display interruption status)

Bit	Symbol	Event
0	MG1.B	Message display interruption 1 (1: displayed, 0: not displayed)
1	MG2.B	Message display interruption 2 (1: displayed, 0: not displayed)
2	MG3.B	Message display interruption 3 (1: displayed, 0: not displayed)
3		
4	MG4.B	Message display interruption 4 (1: displayed, 0: not displayed)
5 to 15		

● Bit Configuration of D2068: **PA.ER** (Parameter error status)

Bit	Symbol	Event
0	SYSTEM_ERR	System data error
1	CALB_ERR	Calibration value error
2	UPARA_ERR	User (parameter) default value error
3		
4	SETPA_ERR	Setup parameter error
5	OPEPA_ERR	Operation parameter error
6		
7		
8	FRAM_ERR	Faulty FRAM
9		
10	CTLPA_ERR	Control parameter error
11 to 15		

● Bit Configuration of D2070: **OP.ER** (Option error status)

Bit	Symbol	Event
0	E1_ERR	Nonresponding hardware of E1 terminal area
1	E2_ERR	Nonresponding hardware of E2 terminal area
2	E3_ERR	Nonresponding hardware of E3 terminal area
3		
4	E4_ERR	Nonresponding hardware of E4 terminal area
5 to 9		
10	COM_E3_ERR	Communication error E3 terminal area
11		
12	COM_E4_ERR	Communication error E4 terminal area
13 to 15		

● Bit Configuration of D2071: **ALOLA1_L1** (Loop-1 alarm-1 to alarm-8 latch output status)

Bit	Symbol	Event
0	ALO1LA1_L1	Alarm-1 latch-1 output status
1	ALO2LA1_L1	Alarm-2 latch-1 output status
2	ALO3LA1_L1	Alarm-3 latch-1 output status
3		
4	ALO4LA1_L1	Alarm-4 latch-1 output status
5	ALO5LA1_L1	Alarm-5 latch-1 output status
6	ALO6LA1_L1	Alarm-6 latch-1 output status
7		
8	ALO7LA1_L1	Alarm-7 latch-1 output status
9	ALO8LA1_L1	Alarm-8 latch-1 output status
10 to 15		

● Bit Configuration of D2072: **ALOLA1_L2** (Loop-2 alarm-1 to alarm-8 latch output status)

Bit	Symbol	Event
0	ALO1LA1_L2	Alarm-1 latch-1 output status
1	ALO2LA1_L2	Alarm-2 latch-1 output status
2	ALO3LA1_L2	Alarm-3 latch-1 output status
3		
4	ALO4LA1_L2	Alarm-4 latch-1 output status
5	ALO5LA1_L2	Alarm-5 latch-1 output status
6	ALO6LA1_L2	Alarm-6 latch-1 output status
7		
8	ALO7LA1_L2	Alarm-7 latch-1 output status
9	ALO8LA1_L2	Alarm-8 latch-1 output status
10 to 15		

● **Bit Configuration of D2073: ALOLA2_L1 (Loop-1 alarm-1 to alarm-8 latch-2 output status)**

Bit	Symbol	Event
0	ALO1LA2_L1	Alarm-1 latch-2 output status
1	ALO2LA2_L1	Alarm-2 latch-2 output status
2	ALO3LA2_L1	Alarm-3 latch-2 output status
3		
4	ALO4LA2_L1	Alarm-4 latch-2 output status
5	ALO5LA2_L1	Alarm-5 latch-2 output status
6	ALO6LA2_L1	Alarm-6 latch-2 output status
7		
8	ALO7LA2_L1	Alarm-7 latch-2 output status
9	ALO8LA2_L1	Alarm-8 latch-2 output status
10 to 15		

● **Bit Configuration of D2074: ALOLA2_L2 (Loop-2 alarm-1 to alarm-8 latch-2 output status)**

Bit	Symbol	Event
0	ALO1LA2_L2	Alarm-1 latch-2 output status
1	ALO2LA2_L2	Alarm-2 latch-2 output status
2	ALO3LA2_L2	Alarm-3 latch-2 output status
3		
4	ALO4LA2_L2	Alarm-4 latch-2 output status
5	ALO5LA2_L2	Alarm-5 latch-2 output status
6	ALO6LA2_L2	Alarm-6 latch-2 output status
7		
8	ALO7LA2_L2	Alarm-7 latch-2 output status
9	ALO8LA2_L2	Alarm-8 latch-2 output status
10 to 15		

● **Bit Configuration of D2075: ALOLA3_L1 (Loop-1 alarm-1 to alarm-8 latch-3 output status)**

Bit	Symbol	Event
0	ALO1LA3_L1	Alarm-1 latch-3 output status
1	ALO2LA3_L1	Alarm-2 latch-3 output status
2	ALO3LA3_L1	Alarm-3 latch-3 output status
3		
4	ALO4LA3_L1	Alarm-4 latch-3 output status
5	ALO5LA3_L1	Alarm-5 latch-3 output status
6	ALO6LA3_L1	Alarm-6 latch-3 output status
7		
8	ALO7LA3_L1	Alarm-7 latch-3 output status
9	ALO8LA3_L1	Alarm-8 latch-3 output status
10 to 15		

● **Bit Configuration of D2076: ALOLA3_L2 (Loop-2 alarm-1 to alarm-8 latch-3 output status)**

Bit	Symbol	Event
0	ALO1LA3_L2	Alarm-1 latch-3 output status
1	ALO2LA3_L2	Alarm-2 latch-3 output status
2	ALO3LA3_L2	Alarm-3 latch-3 output status
3		
4	ALO4LA3_L2	Alarm-4 latch-3 output status
5	ALO5LA3_L2	Alarm-5 latch-3 output status
6	ALO6LA3_L2	Alarm-6 latch-3 output status
7		
8	ALO7LA3_L2	Alarm-7 latch-3 output status
9	ALO8LA3_L2	Alarm-8 latch-3 output status
10 to 15		

● **Bit Configuration of D2077: ALOLA4_L1 (Loop-1 alarm-1 to alarm-8 latch-4 output status)**

Bit	Symbol	Event
0	ALO1LA4_L1	Alarm-1 latch-4 output status
1	ALO2LA4_L1	Alarm-2 latch-4 output status
2	ALO3LA4_L1	Alarm-3 latch-4 output status
3		
4	ALO4LA4_L1	Alarm-4 latch-4 output status
5	ALO5LA4_L1	Alarm-5 latch-4 output status
6	ALO6LA4_L1	Alarm-6 latch-4 output status
7		
8	ALO7LA4_L1	Alarm-7 latch-4 output status
9	ALO8LA4_L1	Alarm-8 latch-4 output status
10 to 15		

● **Bit Configuration of D2078: ALOLA4_L2 (Loop-2 alarm-1 to alarm -8 latch-4 output status)**

Bit	Symbol	Event
0	ALO1LA4_L2	Alarm-1 latch-4 output status
1	ALO2LA4_L2	Alarm-2 latch-4 output status
2	ALO3LA4_L2	Alarm-3 latch-4 output status
3		
4	ALO4LA4_L2	Alarm-4 latch-4 output status
5	ALO5LA4_L2	Alarm-5 latch-4 output status
6	ALO6LA4_L2	Alarm-6 latch-4 output status
7		
8	ALO7LA4_L2	Alarm-7 latch-4 output status
9	ALO8LA4_L2	Alarm-8 latch-4 output status
10 to 15		

14.4 UT75A D Registers

Current SP Group and PID Group (D2101 to D2200)

Register No.	Description	Range and meaning of value
D2101	SP_L1_*	Loop-1 target setpoint 0.0 to 100.0% of PV input range (EU) (Setting range: SPL to SPH)
D2102	SUB_*	Loop-1 sub-target setpoint (in Two-position two-level control) Set the offset from SP. -100.0 to 100.0% of PV input range span (EUS)
D2103	PIDN_L1_*	Loop-1 PID number selection Set a PID group number to use. 1 to 8 (Depends on the PIDG. setting.)
D2104	A1_L1_*	Loop-1 alarm-1 setpoint
D2105	A2_L1_*	Loop-1 alarm-2 setpoint
D2106	A3_L1_*	Loop-1 alarm-3 setpoint
D2107	A4_L1_*	Loop-1 alarm-4 setpoint
D2108	A5_L1_*	Loop-1 alarm-5 setpoint
D2109	A6_L1_*	Loop-1 alarm-6 setpoint
D2110	A7_L1_*	Loop-1 alarm-7 setpoint
D2111	A8_L1_*	Loop-1 alarm-8 setpoint
D2112 to D2113		
D2114	P_L1_*	Proportional band Heating-side proportional band (in Heating/cooling control) 0.0 to 999.9% When 0.0 is set, it operates as 0.1. Heating-side ON/OFF control applies when 0.0 in Heating/cooling control
D2115	I_L1_*	Integral time Heating-side integral time (in Heating/cooling control) 0: OFF (Disable) 1 to 6000 s
D2116	D_L1_*	Derivative time Heating-side derivative time (in Heating/cooling control) 0: OFF (Disable) 1 to 6000 s
D2117	OH_L1_*	Control output high limit Heating-side control output high limit (in Heating/cooling control) -4.9 to 105.0%, (OL<OH) In Heating/cooling control: 0.1 to 105.0% (OL<OH)
D2118	OL_L1_*	Control output low limit Heating-side control output low limit (in Heating/cooling control) -5.0 to 104.9%, (OL<OH), SD: Tight shut In Heating/cooling control: 0.0 to 104.9% (OL<OH)
D2119	MR_L1_*	Manual reset Enabled when integral time is OFF. The manual reset value equals the output value when PV = SP. -5.0 to 105.0%
D2120	HYS_L1_*	Hysteresis (in ON/OFF control, Position proportional control, or Two-position two-level control) Heating-side ON/OFF control hysteresis (in Heating/cooling control) In ON/OFF control or Two-position two-level control: 0.0 to 100.0% of PV input range span (EUS) In Heating/cooling control or Position proportional control: 0.0 to 100.0%
D2121	SU.HY_L1_*	Sub-hysteresis (in Two-position two-level control) 0.0 to 100.0% of PV input range span (EUS)
D2122	HY.UP_L1_*	Upper-side hysteresis (in ON/OFF control) 0.0 to 100.0% of PV input range span (EUS)
D2123	HY.LO_L1_*	Lower-side hysteresis (in ON/OFF control)
D2124	DR_L1_*	Direct/reverse action switch 0: RVS (Reverse action)
D2125	SU.DR_*	Sub-direct/reverse action switch (in Two-position two-level control) 1: DIR (Direct action)
D2126	Pc_L1_*	Cooling-side proportional band 0.0 to 999.9% (Cooling-side ON/OFF control applies when 0.0 in Heating/cooling control)
D2127	Ic_L1_*	Cooling-side integral time 0: OFF (Disable) 1 to 6000 s
D2128	Dc_L1_*	Cooling-side derivative time 0: OFF (Disable) 1 to 6000 s
D2129	OHc_L1_*	Cooling-side control output high limit 0.1 to 105.0%, (OLc<OHc)

* 1 to 20 is written in D2101 to D2112 and D2151 to D2163.
1 to 16, or R (currently used group number) is written in D2114 to D2135 and D2164 to D2185.

Register No.	Description		Range and meaning of value
D2130	OLc_L1_*	Cooling-side control output low limit	0.0 to 104.9%, (OLc<OHc)
D2131	HYSc_L1_*	Cooling-side ON/OFF control hysteresis	0.0 to 100.0%
D2132	DB_L1_*	Output dead band (in Heating/cooling control or Position proportional control)	In Heating/cooling control: -100.0 to 50.0% In Position proportional control: 1.0 to 10.0%
D2133	PO_L1_*	Preset output Heating-side preset output (in Heating/cooling control)	In STOP mode, fixed control output can be generated. In Position proportional control, Valve opening can be set -5.0 to 105.0%
D2134	SU.PO_*	Sub-preset output (in Two-position two-level control)	In STOP mode, fixed sub-control output can be generated. 0%, 100%
D2135	POc_L1_*	Cooling-side preset output	In STOP mode, cooling-side fixed control output can be generated. -5.0 to 105.0%
D2136 to D2150			
D2151 to D2161	SP_L2_* to A8_L2_*	Loop-2 target setpoint to alarm-8 setpoint	Same as D2101 to D2111
D2162 to D2163			
D2164 to D2185	P_L2_* to POc_L2_*	Loop-2 proportional band Heating-side proportional band (in Heating/cooling control) to Cooling-side preset output	Same as D2114 to D2135
D2186 to D2200			

* 1 to 20 is written in D2101 to D2112 and D2151 to D2163.
1 to 16, or R (currently used group number) is written in D2114 to D2135 and D2164 to D2185.

14.4 UT75A D Registers

14.4.2 Loop-1 / Loop-2 Operation Mode Parameter (D2301 to D2500)

Operation mode parameters									
Loop-1 / Loop-2 operation mode (Menu: MODE)									
D-Reg No.	Ref. No.	H No.	Register symbol	R/W	D-Reg No.	Ref. No.	H No.	Register symbol	R/W
				UT75A					UT75A
D2301	42301	08FC	A.M_L1	R/W	D2351	42351	092E		
D2302	42302	08FD	A.M_L2	R/W	D2352	42352	092F		
D2303	42303	08FE	C.A.M	R/W	D2353	42353	0930		
D2304	42304	08FF	S.R_L1	R/W	D2354	42354	0931		
D2305	42305	0900	S.R_L2	R/W	D2355	42355	0932		
D2306	42306	0901	R.L_L1	R/W	D2356	42356	0933		
D2307	42307	0902	R.L_L2	R/W	D2357	42357	0934		
D2308	42308	0903	AT_L1	R/W	D2358	42358	0935		
D2309	42309	0904	AT_L2	R/W	D2359	42359	0936		
D2310	42310	0905			D2360	42360	0937		
D2311	42311	0906			D2361	42361	0938		
D2312	42312	0907	SPNO.	R/W	D2362	42362	0939		
D2313	42313	0908			D2363	42363	093A		
D2314	42314	0909	TRK_ON_L1	R/W	D2364	42364	093B		
D2315	42315	090A	TRK_ON_L2	R/W	D2365	42365	093C		
D2316	42316	090B			D2366	42366	093D		
D2317	42317	090C			D2367	42367	093E		
D2318	42318	090D			D2368	42368	093F		
D2319	42319	090E			D2369	42369	0940		
D2320	42320	090F			D2370	42370	0941		
D2321	42321	0910			D2371	42371	0942		
D2322	42322	0911			D2372	42372	0943		
D2323	42323	0912			D2373	42373	0944		
D2324	42324	0913			D2374	42374	0945		
D2325	42325	0914			D2375	42375	0946		
D2326	42326	0915			D2376	42376	0947		
D2327	42327	0916	HOLD	R/W	D2377	42377	0948		
D2328	42328	0917	ADV	R/W	D2378	42378	0949		
D2329	42329	0918	PROG	R/W	D2379	42379	094A		
D2330	42330	0919			D2380	42380	094B		
D2331	42331	091A	C.RSP_L1	R/W	D2381	42381	094C		
D2332	42332	091B	C.RSP_L2	R/W	D2382	42382	094D		
D2333	42333	091C	MOUT_L1	R/W	D2383	42383	094E		
D2334	42334	091D	MOUTc_L1	R/W	D2384	42384	094F		
D2335	42335	091E	MOUT_L2	R/W	D2385	42385	0950		
D2336	42336	091F	MOUTc_L2	R/W	D2386	42386	0951		
D2337	42337	0920			D2387	42387	0952		
D2338	42338	0921			D2388	42388	0953		
D2339	42339	0922			D2389	42389	0954		
D2340	42340	0923			D2390	42390	0955		
D2341	42341	0924			D2391	42391	0956		
D2342	42342	0925			D2392	42392	0957		
D2343	42343	0926			D2393	42393	0958		
D2344	42344	0927			D2394	42394	0959		
D2345	42345	0928			D2395	42395	095A		
D2346	42346	0929			D2396	42396	095B		
D2347	42347	092A			D2397	42397	095C		
D2348	42348	092B			D2398	42398	095D		
D2349	42349	092C			D2399	42399	095E		
D2350	42350	092D			D2400	42400	095F		

Free area (D2401 to D2500)

Loop-1 / Loop-2 Operation Mode (D2301 to D2400)

Register No.	Description		Range and meaning of value
D2301	A.M_L1	Loop-1 AUTO/MAN switch	0: AUTO (Automatic mode) 1: MAN (Manual mode) Effective for the control modes except for cascade control and cascade secondary-loop control.
D2302	A.M_L2	Loop-2 AUTO/MAN switch	0: AUTO (Automatic mode) 1: MAN (Manual mode)
D2303	C.A.M	CAS/AUTO/MAN switch	0: AUTO (Automatic mode) 1: MAN (Manual mode) 2: CAS (Cascade mode) Effective for cascade control mode and cascade secondary-loop control mode.
D2304	S.R_L1	STOP/RUN switch	0: RUN (Run mode) 1: STOP (Stop mode) Preset output (PO) is generated in STOP mode.
D2305	S.R_L2	STOP/RUN switch	Default: Not displayed. STOP/RUN switch is assigned to contact input.
D2306	R.L_L1	Loop-1 REMOTE/LOCAL switch	0: LCL (Local mode) 1: REM (Remote mode) Select a remote input method for acquiring the target setpoint from remote input, program operation, or communication using the parameter RMS.
D2307	R.L_L2	Loop-2 REMOTE/LOCAL switch	
D2308	AT_L1	Loop-1 auto-tuning switch	0: OFF (Disable)
D2309	AT_L2	Loop-2 auto-tuning switch	1 to 16: Perform auto-tuning. Tuning result is stored in the specified numbered PID. 17: R (Tuning result is stored in the PID for reference deviation.)
D2310 to D2311			
D2312	SPNO.	SP number selection	1 to 8 (Depends on the setup parameter SPGR. setting.)
D2313			
D2314	TRK_ON_L1	Loop-1 output tracking status	0: OFF 1: ON
D2315	TRK_ON_L2	Loop-2 output tracking status	0: OFF 1: ON
D2316 to D2326			
D2327	HOLD	Pause/cancel release of program operation	Display during program operation. 0: OFF (Cancel release (Program operation restart)) 1: ON (Pause)
D2328	ADV	Advance of segment	Display during program operation. Set as "ADV = 1 (ON)" to advance from the current segment to the next segment.
D2329	PROG	RUN/STOP switch of program operation	P.STOP: Stop of program operation P.RUN: Start of program operation
D2330			
D2331	C.RSP_L1	Loop-1 communication remote setpoint	0.0 to 100.0% of PV input range (EU)
D2332	C.RSP_L2	Loop-2 communication remote setpoint	
D2333	MOUT_L1	Loop-1 heating-side control output in MAN mode	0.0 to 105.0% (Standard type: -5.0 to 105.0%)
D2334	MOUTc_L1	Loop-1 cooling-side control output in MAN mode	0.0 to 105.0%
D2335	MOUT_L2	Loop-2 heating-side control output in MAN mode	0.0 to 105.0% (Standard type: -5.0 to 105.0%)
D2336	MOUTc_L2	Loop-2 cooling-side control output in MAN mode	0.0 to 105.0%
D2337 to D2400			

14.4 UT75A D Registers

14.4.3 Loop-1 Operation Parameter (D2501 to D3600)

Loop-1 operation parameter									
SP and alarm setpoint setting (Menu: SP)									
D-Reg No.	Ref. No.	H No.	Register symbol	R/W	D-Reg No.	Ref. No.	H No.	Register symbol	R/W
				UT75A					UT75A
D2501	42501	09C4	SP_L1_1	R/W	D2551	42551	09F6	A8_L1_3	R/W
D2502	42502	09C5	SUB_1	R/W	D2552	42552	09F7	UPR_L1_3	R/W
D2503	42503	09C6	PIDN_L1_1	R/W	D2553	42553	09F8	UPR_L1_3	R/W
D2504	42504	09C7	A1_L1_1	R/W	D2554	42554	09F9		
D2505	42505	09C8	A2_L1_1	R/W	D2555	42555	09FA		
D2506	42506	09C9	A3_L1_1	R/W	D2556	42556	09FB		
D2507	42507	09CA	A4_L1_1	R/W	D2557	42557	09FC		
D2508	42508	09CB	A5_L1_1	R/W	D2558	42558	09FD		
D2509	42509	09CC	A6_L1_1	R/W	D2559	42559	09FE		
D2510	42510	09CD	A7_L1_1	R/W	D2560	42560	09FF		
D2511	42511	09CE	A8_L1_1	R/W	D2561	42561	0A00	SP_L1_4	R/W
D2512	42512	09CF	UPR_L1_1	R/W	D2562	42562	0A01	SUB_4	R/W
D2513	42513	09D0	DNR_L1_1	R/W	D2563	42563	0A02	PIDN_L1_4	R/W
D2514	42514	09D1			D2564	42564	0A03	A1_L1_4	R/W
D2515	42515	09D2			D2565	42565	0A04	A2_L1_4	R/W
D2516	42516	09D3			D2566	42566	0A05	A3_L1_4	R/W
D2517	42517	09D4			D2567	42567	0A06	A4_L1_4	R/W
D2518	42518	09D5			D2568	42568	0A07	A5_L1_4	R/W
D2519	42519	09D6			D2569	42569	0A08	A6_L1_4	R/W
D2520	42520	09D7			D2570	42570	0A09	A7_L1_4	R/W
D2521	42521	09D8	SP_L1_2	R/W	D2571	42571	0A0A	A8_L1_4	R/W
D2522	42522	09D9	SUB_2	R/W	D2572	42572	0A0B	UPR_L1_4	R/W
D2523	42523	09DA	PIDN_L1_2	R/W	D2573	42573	0A0C	DNR_L1_4	R/W
D2524	42524	09DB	A1_L1_2	R/W	D2574	42574	0A0D		
D2525	42525	09DC	A2_L1_2	R/W	D2575	42575	0A0E		
D2526	42526	09DD	A3_L1_2	R/W	D2576	42576	0A0F		
D2527	42527	09DE	A4_L1_2	R/W	D2577	42577	0A10		
D2528	42528	09DF	A5_L1_2	R/W	D2578	42578	0A11		
D2529	42529	09E0	A6_L1_2	R/W	D2579	42579	0A12		
D2530	42530	09E1	A7_L1_2	R/W	D2580	42580	0A13		
D2531	42531	09E2	A8_L1_2	R/W	D2581	42581	0A14	SP_L1_5	R/W
D2532	42532	09E3	UPR_L1_2	R/W	D2582	42582	0A15	SUB_5	R/W
D2533	42533	09E4	DNR_L1_2	R/W	D2583	42583	0A16	PIDN_L1_5	R/W
D2534	42534	09E5			D2584	42584	0A17	A1_L1_5	R/W
D2535	42535	09E6			D2585	42585	0A18	A2_L1_5	R/W
D2536	42536	09E7			D2586	42586	0A19	A3_L1_5	R/W
D2537	42537	09E8			D2587	42587	0A1A	A4_L1_5	R/W
D2538	42538	09E9			D2588	42588	0A1B	A5_L1_5	R/W
D2539	42539	09EA			D2589	42589	0A1C	A6_L1_5	R/W
D2540	42540	09EB			D2590	42590	0A1D	A7_L1_5	R/W
D2541	42541	09EC	SP_L1_3	R/W	D2591	42591	0A1E	A8_L1_5	R/W
D2542	42542	09ED	SUB_3	R/W	D2592	42592	0A1F	UPR_L1_5	R/W
D2543	42543	09EE	PIDN_L1_3	R/W	D2593	42593	0A20	DNR_L1_5	R/W
D2544	42544	09EF	A1_L1_3	R/W	D2594	42594	0A21		
D2545	42545	09F0	A2_L1_3	R/W	D2595	42595	0A22		
D2546	42546	09F1	A3_L1_3	R/W	D2596	42596	0A23		
D2547	42547	09F2	A4_L1_3	R/W	D2597	42597	0A24		
D2548	42548	09F3	A5_L1_3	R/W	D2598	42598	0A25		
D2549	42549	09F4	A6_L1_3	R/W	D2599	42599	0A26		
D2550	42550	09F5	A7_L1_3	R/W	D2600	42600	0A27		

Loop-1 operation parameter									
SP and alarm setpoint setting (Menu: SP)									
D-Reg No.	Ref. No.	H No.	Register symbol	R/W	D-Reg No.	Ref. No.	H No.	Register symbol	R/W
				UT75A					UT75A
D2601	42601	0A28	SP_L1_6	R/W	D2651	42651	0A5A	A8_L1_8	R/W
D2602	42602	0A29	SUB_6	R/W	D2652	42652	0A5B	UPR_L1_8	R/W
D2603	42603	0A2A	PIDN_L1_6	R/W	D2653	42653	0A5C	DNR_L1_8	R/W
D2604	42604	0A2B	A1_L1_6	R/W	D2654	42654	0A5D		
D2605	42605	0A2C	A2_L1_6	R/W	D2655	42655	0A5E		
D2606	42606	0A2D	A3_L1_6	R/W	D2656	42656	0A5F		
D2607	42607	0A2E	A4_L1_6	R/W	D2657	42657	0A60		
D2608	42608	0A2F	A5_L1_6	R/W	D2658	42658	0A61		
D2609	42609	0A30	A6_L1_6	R/W	D2659	42659	0A62		
D2610	42610	0A31	A7_L1_6	R/W	D2660	42660	0A63		
D2611	42611	0A32	A8_L1_6	R/W	D2661	42661	0A64		
D2612	42612	0A33	UPR_L1_6	R/W	D2662	42662	0A65		
D2613	42613	0A34	DNR_L1_6	R/W	D2663	42663	0A66		
D2614	42614	0A35			D2664	42664	0A67		
D2615	42615	0A36			D2665	42665	0A68		
D2616	42616	0A37			D2666	42666	0A69		
D2617	42617	0A38			D2667	42667	0A6A		
D2618	42618	0A39			D2668	42668	0A6B		
D2619	42619	0A3A			D2669	42669	0A6C		
D2620	42620	0A3B			D2670	42670	0A6D		
D2621	42621	0A3C	SP_L1_7	R/W	D2671	42671	0A6E		
D2622	42622	0A3D	SUB_7	R/W	D2672	42672	0A6F		
D2623	42623	0A3E	PIDN_L1_7	R/W	D2673	42673	0A70		
D2624	42624	0A3F	A1_L1_7	R/W	D2674	42674	0A71		
D2625	42625	0A40	A2_L1_7	R/W	D2675	42675	0A72		
D2626	42626	0A41	A3_L1_7	R/W	D2676	42676	0A73		
D2627	42627	0A42	A4_L1_7	R/W	D2677	42677	0A74		
D2628	42628	0A43	A5_L1_7	R/W	D2678	42678	0A75		
D2629	42629	0A44	A6_L1_7	R/W	D2679	42679	0A76		
D2630	42630	0A45	A7_L1_7	R/W	D2680	42680	0A77		
D2631	42631	0A46	A8_L1_7	R/W	D2681	42681	0A78		
D2632	42632	0A47	UPR_L1_7	R/W	D2682	42682	0A79		
D2633	42633	0A48	DNR_L1_7	R/W	D2683	42683	0A7A		
D2634	42634	0A49			D2684	42684	0A7B		
D2635	42635	0A4A			D2685	42685	0A7C		
D2636	42636	0A4B			D2686	42686	0A7D		
D2637	42637	0A4C			D2687	42687	0A7E		
D2638	42638	0A4D			D2688	42688	0A7F		
D2639	42639	0A4E			D2689	42689	0A80		
D2640	42640	0A4F			D2690	42690	0A81		
D2641	42641	0A50	SP_L1_8	R/W	D2691	42691	0A82		
D2642	42642	0A51	SUB_8	R/W	D2692	42692	0A83		
D2643	42643	0A52	PIDN_L1_8	R/W	D2693	42693	0A84		
D2644	42644	0A53	A1_L1_8	R/W	D2694	42694	0A85		
D2645	42645	0A54	A2_L1_8	R/W	D2695	42695	0A86		
D2646	42646	0A55	A3_L1_8	R/W	D2696	42696	0A87		
D2647	42647	0A56	A4_L1_8	R/W	D2697	42697	0A88		
D2648	42648	0A57	A5_L1_8	R/W	D2698	42698	0A89		
D2649	42649	0A58	A6_L1_8	R/W	D2699	42699	0A8A		
D2650	42650	0A59	A7_L1_8	R/W	D2700	42700	0A8B		

14.4 UT75A D Registers

Loop-1 operation parameter									
SP-related setting (Menu: SPS)									
D-Reg No.	Ref. No.	H No.	Register symbol	R/W	D-Reg No.	Ref. No.	H No.	Register symbol	R/W
				UT75A					UT75A
D2701	42701	0A8C	RMS_L1	R/W	D2751	42751	0ABE		
D2702	42702	0A8D	RFL_L1	R/W	D2752	42752	0ABF		
D2703	42703	0A8E	RT_L1	R/W	D2753	42753	0AC0		
D2704	42704	0A8F	RBS_L1	R/W	D2754	42754	0AC1		
D2705	42705	0A90			D2755	42755	0AC2		
D2706	42706	0A91			D2756	42756	0AC3		
D2707	42707	0A92	TMU_L1	R/W	D2757	42757	0AC4		
D2708	42708	0A93			D2758	42758	0AC5		
D2709	42709	0A94			D2759	42759	0AC6		
D2710	42710	0A95	SPT_L1	R/W	D2760	42760	0AC7		
D2711	42711	0A96	PVT_L1	R/W	D2761	42761	0AC8		
D2712	42712	0A97			D2762	42762	0AC9		
D2713	42713	0A98			D2763	42763	0ACA		
D2714	42714	0A99			D2764	42764	0ACB		
D2715	42715	0A9A			D2765	42765	0ACC		
D2716	42716	0A9B			D2766	42766	0ACD		
D2717	42717	0A9C			D2767	42767	0ACE		
D2718	42718	0A9D			D2768	42768	0ACF		
D2719	42719	0A9E			D2769	42769	0AD0		
D2720	42720	0A9F			D2770	42770	0AD1		
D2721	42721	0AA0			D2771	42771	0AD2		
D2722	42722	0AA1			D2772	42772	0AD3		
D2723	42723	0AA2			D2773	42773	0AD4		
D2724	42724	0AA3			D2774	42774	0AD5		
D2725	42725	0AA4			D2775	42775	0AD6		
D2726	42726	0AA5			D2776	42776	0AD7		
D2727	42727	0AA6			D2777	42777	0AD8		
D2728	42728	0AA7			D2778	42778	0AD9		
D2729	42729	0AA8			D2779	42779	0ADA		
D2730	42730	0AA9			D2780	42780	0ADB		
D2731	42731	0AAA			D2781	42781	0ADC		
D2732	42732	0AAB			D2782	42782	0ADD		
D2733	42733	0AAC			D2783	42783	0ADE		
D2734	42734	0AAD			D2784	42784	0ADF		
D2735	42735	0AAE			D2785	42785	0AE0		
D2736	42736	0AAF			D2786	42786	0AE1		
D2737	42737	0AB0			D2787	42787	0AE2		
D2738	42738	0AB1			D2788	42788	0AE3		
D2739	42739	0AB2			D2789	42789	0AE4		
D2740	42740	0AB3			D2790	42790	0AE5		
D2741	42741	0AB4			D2791	42791	0AE6		
D2742	42742	0AB5			D2792	42792	0AE7		
D2743	42743	0AB6			D2793	42793	0AE8		
D2744	42744	0AB7			D2794	42794	0AE9		
D2745	42745	0AB8			D2795	42795	0AEA		
D2746	42746	0AB9			D2796	42796	0AEB		
D2747	42747	0ABA			D2797	42797	0AEC		
D2748	42748	0ABB			D2798	42798	0AED		
D2749	42749	0ABC			D2799	42799	0AEE		
D2750	42750	0ABD			D2800	42800	0AEF		

Loop-1 operation parameter									
Alarm function setting (Menu: ALRM)									
D-Reg No.	Ref. No.	H No.	Register symbol	R/W	D-Reg No.	Ref. No.	H No.	Register symbol	R/W
				UT75A					UT75A
D2801	42801	0AF0	AL1.T_L1	R/W	D2851	42851	0B22	DYN3_L1	R/W
D2802	42802	0AF1	AL1.W_L1	R/W	D2852	42852	0B23	DYN4_L1	R/W
D2803	42803	0AF2	AL1.D_L1	R/W	D2853	42853	0B24	DYN5_L1	R/W
D2804	42804	0AF3	AL1.L_L1	R/W	D2854	42854	0B25	DYN6_L1	R/W
D2805	42805	0AF4	AL2.T_L1	R/W	D2855	42855	0B26	DYN7_L1	R/W
D2806	42806	0AF5	AL2.W_L1	R/W	D2856	42856	0B27	DYN8_L1	R/W
D2807	42807	0AF6	AL2.D_L1	R/W	D2857	42857	0B28	DYF1_L1	R/W
D2808	42808	0AF7	AL2.L_L1	R/W	D2858	42858	0B29	DYF2_L1	R/W
D2809	42809	0AF8	AL3.T_L1	R/W	D2859	42859	0B2A	DYF3_L1	R/W
D2810	42810	0AF9	AL3.W_L1	R/W	D2860	42860	0B2B	DYF4_L1	R/W
D2811	42811	0AFA	AL3.D_L1	R/W	D2861	42861	0B2C	DYF5_L1	R/W
D2812	42812	0AFB	AL3.L_L1	R/W	D2862	42862	0B2D	DYF6_L1	R/W
D2813	42813	0AFC	AL4.T_L1	R/W	D2863	42863	0B2E	DYF7_L1	R/W
D2814	42814	0AFD	AL4.W_L1	R/W	D2864	42864	0B2F	DYF8_L1	R/W
D2815	42815	0AFE	AL4.D_L1	R/W	D2865	42865	0B30		
D2816	42816	0AFF	AL4.L_L1	R/W	D2866	42866	0B31	AMD_L1	R/W
D2817	42817	0B00	AL5.T_L1	R/W	D2867	42867	0B32		
D2818	42818	0B01	AL5.W_L1	R/W	D2868	42868	0B33		
D2819	42819	0B02	AL5.D_L1	R/W	D2869	42869	0B34		
D2820	42820	0B03	AL5.L_L1	R/W	D2870	42870	0B35		
D2821	42821	0B04	AL6.T_L1	R/W	D2871	42871	0B36		
D2822	42822	0B05	AL6.W_L1	R/W	D2872	42872	0B37		
D2823	42823	0B06	AL6.D_L1	R/W	D2873	42873	0B38		
D2824	42824	0B07	AL6.L_L1	R/W	D2874	42874	0B39		
D2825	42825	0B08	AL7.T_L1	R/W	D2875	42875	0B3A		
D2826	42826	0B09	AL7.W_L1	R/W	D2876	42876	0B3B		
D2827	42827	0B0A	AL7.D_L1	R/W	D2877	42877	0B3C		
D2828	42828	0B0B	AL7.L_L1	R/W	D2878	42878	0B3D		
D2829	42829	0B0C	AL8.T_L1	R/W	D2879	42879	0B3E		
D2830	42830	0B0D	AL8.W_L1	R/W	D2880	42880	0B3F		
D2831	42831	0B0E	AL8.D_L1	R/W	D2881	42881	0B40		
D2832	42832	0B0F	AL8.L_L1	R/W	D2882	42882	0B41		
D2833	42833	0B10	VT1_L1	R/W	D2883	42883	0B42		
D2834	42834	0B11	VT2_L1	R/W	D2884	42884	0B43		
D2835	42835	0B12	VT3_L1	R/W	D2885	42885	0B44		
D2836	42836	0B13	VT4_L1	R/W	D2886	42886	0B45		
D2837	42837	0B14	VT5_L1	R/W	D2887	42887	0B46		
D2838	42838	0B15	VT6_L1	R/W	D2888	42888	0B47		
D2839	42839	0B16	VT7_L1	R/W	D2889	42889	0B48		
D2840	42840	0B17	VT8_L1	R/W	D2890	42890	0B49		
D2841	42841	0B18	HY1_L1	R/W	D2891	42891	0B4A		
D2842	42842	0B19	HY2_L1	R/W	D2892	42892	0B4B		
D2843	42843	0B1A	HY3_L1	R/W	D2893	42893	0B4C		
D2844	42844	0B1B	HY4_L1	R/W	D2894	42894	0B4D		
D2845	42845	0B1C	HY5_L1	R/W	D2895	42895	0B4E		
D2846	42846	0B1D	HY6_L1	R/W	D2896	42896	0B4F		
D2847	42847	0B1E	HY7_L1	R/W	D2897	42897	0B50		
D2848	42848	0B1F	HY8_L1	R/W	D2898	42898	0B51		
D2849	42849	0B20	DYN1_L1	R/W	D2899	42899	0B52		
D2850	42850	0B21	DYN2_L1	R/W	D2900	42900	0B53		

14.4 UT75A D Registers

Loop-1 operation parameter									
PV-related setting (Menu: PVS)									
D-Reg No.	Ref. No.	H No.	Register symbol	R/W	D-Reg No.	Ref. No.	H No.	Register symbol	R/W
				UT75A					UT75A
D2901	42901	0B54	BS_L1	R/W	D2951	42951	0B86		
D2902	42902	0B55	FL_L1	R/W	D2952	42952	0B87		
D2903	42903	0B56			D2953	42953	0B88		
D2904	42904	0B57			D2954	42954	0B89		
D2905	42905	0B58			D2955	42955	0B8A		
D2906	42906	0B59			D2956	42956	0B8B		
D2907	42907	0B5A			D2957	42957	0B8C		
D2908	42908	0B5B			D2958	42958	0B8D		
D2909	42909	0B5C			D2959	42959	0B8E		
D2910	42910	0B5D			D2960	42960	0B8F		
D2911	42911	0B5E			D2961	42961	0B90		
D2912	42912	0B5F			D2962	42962	0B91		
D2913	42913	0B60			D2963	42963	0B92		
D2914	42914	0B61			D2964	42964	0B93		
D2915	42915	0B62			D2965	42965	0B94		
D2916	42916	0B63			D2966	42966	0B95		
D2917	42917	0B64			D2967	42967	0B96		
D2918	42918	0B65			D2968	42968	0B97		
D2919	42919	0B66			D2969	42969	0B98		
D2920	42920	0B67			D2970	42970	0B99		
D2921	42921	0B68			D2971	42971	0B9A		
D2922	42922	0B69			D2972	42972	0B9B		
D2923	42923	0B6A			D2973	42973	0B9C		
D2924	42924	0B6B			D2974	42974	0B9D		
D2925	42925	0B6C			D2975	42975	0B9E		
D2926	42926	0B6D			D2976	42976	0B9F		
D2927	42927	0B6E			D2977	42977	0BA0		
D2928	42928	0B6F			D2978	42978	0BA1		
D2929	42929	0B70			D2979	42979	0BA2		
D2930	42930	0B71			D2980	42980	0BA3		
D2931	42931	0B72			D2981	42981	0BA4		
D2932	42932	0B73			D2982	42982	0BA5		
D2933	42933	0B74			D2983	42983	0BA6		
D2934	42934	0B75			D2984	42984	0BA7		
D2935	42935	0B76			D2985	42985	0BA8		
D2936	42936	0B77			D2986	42986	0BA9		
D2937	42937	0B78			D2987	42987	0BAA		
D2938	42938	0B79			D2988	42988	0BAB		
D2939	42939	0B7A			D2989	42989	0BAC		
D2940	42940	0B7B			D2990	42990	0BAD		
D2941	42941	0B7C			D2991	42991	0BAE		
D2942	42942	0B7D			D2992	42992	0BAF		
D2943	42943	0B7E			D2993	42993	0BB0		
D2944	42944	0B7F			D2994	42994	0BB1		
D2945	42945	0B80			D2995	42995	0BB2		
D2946	42946	0B81			D2996	42996	0BB3		
D2947	42947	0B82			D2997	42997	0BB4		
D2948	42948	0B83			D2998	42998	0BB5		
D2949	42949	0B84			D2999	42999	0BB6		
D2950	42950	0B85			D3000	43000	0BB7		

Loop-1 operation parameter									
PID setting (Menu: PID)									
D-Reg No.	Ref. No.	H No.	Register symbol	R/W	D-Reg No.	Ref. No.	H No.	Register symbol	R/W
				UT75A					UT75A
D3001	43001	0BB8	P_L1_1	R/W	D3051	43051	0BEA	P_L1_2	R/W
D3002	43002	0BB9	I_L1_1	R/W	D3052	43052	0BEB	I_L1_2	R/W
D3003	43003	0BBA	D_L1_1	R/W	D3053	43053	0BEC	D_L1_2	R/W
D3004	43004	0BBB	OH_L1_1	R/W	D3054	43054	0BED	OH_L1_2	R/W
D3005	43005	0BBC	OL_L1_1	R/W	D3055	43055	0BEE	OL_L1_2	R/W
D3006	43006	0BBD	MR_L1_1	R/W	D3056	43056	0BEF	MR_L1_2	R/W
D3007	43007	0BBE	HYS_L1_1	R/W	D3057	43057	0BF0	HYS_L1_2	R/W
D3008	43008	0BBF	SU.HY_1	R/W	D3058	43058	0BF1	SU.HY_2	R/W
D3009	43009	0BC0	HY.UP_L1_1	R/W	D3059	43059	0BF2	HY.UP_L1_2	R/W
D3010	43010	0BC1	HY.LO_L1_1	R/W	D3060	43060	0BF3	HY.LO_L1_2	R/W
D3011	43011	0BC2	DR_L1_1	R/W	D3061	43061	0BF4	DR_L1_2	R/W
D3012	43012	0BC3	SU.DR_1	R/W	D3062	43062	0BF5	SU.DR_2	R/W
D3013	43013	0BC4	Pc_L1_1	R/W	D3063	43063	0BF6	Pc_L1_2	R/W
D3014	43014	0BC5	Ic_L1_1	R/W	D3064	43064	0BF7	Ic_L1_2	R/W
D3015	43015	0BC6	Dc_L1_1	R/W	D3065	43065	0BF8	Dc_L1_2	R/W
D3016	43016	0BC7	OHc_L1_1	R/W	D3066	43066	0BF9	OHc_L1_2	R/W
D3017	43017	0BC8	OLc_L1_1	R/W	D3067	43067	0BFA	OLc_L1_2	R/W
D3018	43018	0BC9	HYSc_L1_1	R/W	D3068	43068	0BFB	HYSc_L1_2	R/W
D3019	43019	0BCA	DB_L1_1	R/W	D3069	43069	0BFC	DB_L1_2	R/W
D3020	43020	0BCB	PO_L1_1	R/W	D3070	43070	0BFD	PO_L1_2	R/W
D3021	43021	0BCC	SU.PO_1	R/W	D3071	43071	0BFE	SU.PO_2	R/W
D3022	43022	0BCD	POc_L1_1	R/W	D3072	43072	0BFF	POc_L1_2	R/W
D3023	43023	0BCE			D3073	43073	0C00		
D3024	43024	0BCF			D3074	43074	0C01		
D3025	43025	0BD0			D3075	43075	0C02		
D3026	43026	0BD1			D3076	43076	0C03		
D3027	43027	0BD2			D3077	43077	0C04		
D3028	43028	0BD3			D3078	43078	0C05		
D3029	43029	0BD4			D3079	43079	0C06		
D3030	43030	0BD5			D3080	43080	0C07		
D3031	43031	0BD6			D3081	43081	0C08		
D3032	43032	0BD7			D3082	43082	0C09		
D3033	43033	0BD8			D3083	43083	0C0A		
D3034	43034	0BD9			D3084	43084	0C0B		
D3035	43035	0BDA			D3085	43085	0C0C		
D3036	43036	0BDB			D3086	43086	0C0D		
D3037	43037	0BDC			D3087	43087	0C0E		
D3038	43038	0BDD			D3088	43088	0C0F		
D3039	43039	0BDE			D3089	43089	0C10		
D3040	43040	0BDF			D3090	43090	0C11		
D3041	43041	0BE0			D3091	43091	0C12		
D3042	43042	0BE1			D3092	43092	0C13		
D3043	43043	0BE2			D3093	43093	0C14		
D3044	43044	0BE3			D3094	43094	0C15		
D3045	43045	0BE4			D3095	43095	0C16		
D3046	43046	0BE5			D3096	43096	0C17		
D3047	43047	0BE6			D3097	43097	0C18		
D3048	43048	0BE7			D3098	43098	0C19		
D3049	43049	0BE8			D3099	43099	0C1A		
D3050	43050	0BE9			D3100	43100	0C1B		

14.4 UT75A D Registers

Loop-1 operation parameter									
PID setting (Menu: PID)									
D-Reg No.	Ref. No.	H No.	Register symbol	R/W	D-Reg No.	Ref. No.	H No.	Register symbol	R/W
				UT75A					UT75A
D3101	43101	0C1C	P_L1_3	R/W	D3151	43151	0C4E	P_L1_4	R/W
D3102	43102	0C1D	I_L1_3	R/W	D3152	43152	0C4F	I_L1_4	R/W
D3103	43103	0C1E	D_L1_3	R/W	D3153	43153	0C50	D_L1_4	R/W
D3104	43104	0C1F	OH_L1_3	R/W	D3154	43154	0C51	OH_L1_4	R/W
D3105	43105	0C20	OL_L1_3	R/W	D3155	43155	0C52	OL_L1_4	R/W
D3106	43106	0C21	MR_L1_3	R/W	D3156	43156	0C53	MR_L1_4	R/W
D3107	43107	0C22	HYS_L1_3	R/W	D3157	43157	0C54	HYS_L1_4	R/W
D3108	43108	0C23	SU.HY_3	R/W	D3158	43158	0C55	SU.HY_4	R/W
D3109	43109	0C24	HY.UP_L1_3	R/W	D3159	43159	0C56	HY.UP_L1_4	R/W
D3110	43110	0C25	HY.LO_L1_3	R/W	D3160	43160	0C57	HY.LO_L1_4	R/W
D3111	43111	0C26	DR_L1_3	R/W	D3161	43161	0C58	DR_L1_4	R/W
D3112	43112	0C27	SU.DR_3	R/W	D3162	43162	0C59	SU.DR_4	R/W
D3113	43113	0C28	Pc_L1_3	R/W	D3163	43163	0C5A	Pc_L1_4	R/W
D3114	43114	0C29	Ic_L1_3	R/W	D3164	43164	0C5B	Ic_L1_4	R/W
D3115	43115	0C2A	Dc_L1_3	R/W	D3165	43165	0C5C	Dc_L1_4	R/W
D3116	43116	0C2B	OHc_L1_3	R/W	D3166	43166	0C5D	OHc_L1_4	R/W
D3117	43117	0C2C	OLc_L1_3	R/W	D3167	43167	0C5E	OLc_L1_4	R/W
D3118	43118	0C2D	HYS_L1_3	R/W	D3168	43168	0C5F	HYS_L1_4	R/W
D3119	43119	0C2E	DB_L1_3	R/W	D3169	43169	0C60	DB_L1_4	R/W
D3120	43120	0C2F	PO_L1_3	R/W	D3170	43170	0C61	PO_L1_4	R/W
D3121	43121	0C30	SU.PO_3	R/W	D3171	43171	0C62	SU.PO_4	R/W
D3122	43122	0C31	POc_L1_3	R/W	D3172	43172	0C63	POc_L1_4	R/W
D3123	43123	0C32			D3173	43173	0C64		
D3124	43124	0C33			D3174	43174	0C65		
D3125	43125	0C34			D3175	43175	0C66		
D3126	43126	0C35			D3176	43176	0C67		
D3127	43127	0C36			D3177	43177	0C68		
D3128	43128	0C37			D3178	43178	0C69		
D3129	43129	0C38			D3179	43179	0C6A		
D3130	43130	0C39			D3180	43180	0C6B		
D3131	43131	0C3A			D3181	43181	0C6C		
D3132	43132	0C3B			D3182	43182	0C6D		
D3133	43133	0C3C			D3183	43183	0C6E		
D3134	43134	0C3D			D3184	43184	0C6F		
D3135	43135	0C3E			D3185	43185	0C70		
D3136	43136	0C3F			D3186	43186	0C71		
D3137	43137	0C40			D3187	43187	0C72		
D3138	43138	0C41			D3188	43188	0C73		
D3139	43139	0C42			D3189	43189	0C74		
D3140	43140	0C43			D3190	43190	0C75		
D3141	43141	0C44			D3191	43191	0C76		
D3142	43142	0C45			D3192	43192	0C77		
D3143	43143	0C46			D3193	43193	0C78		
D3144	43144	0C47			D3194	43194	0C79		
D3145	43145	0C48			D3195	43195	0C7A		
D3146	43146	0C49			D3196	43196	0C7B		
D3147	43147	0C4A			D3197	43197	0C7C		
D3148	43148	0C4B			D3198	43198	0C7D		
D3149	43149	0C4C			D3199	43199	0C7E		
D3150	43150	0C4D			D3200	43200	0C7F		

Loop-1 operation parameter									
PID setting (Menu: PID)									
D-Reg No.	Ref. No.	H No.	Register symbol	R/W	D-Reg No.	Ref. No.	H No.	Register symbol	R/W
				UT75A					UT75A
D3201	43201	0C80	P_L1_5	R/W	D3251	43251	0CB2	P_L1_6	R/W
D3202	43202	0C81	I_L1_5	R/W	D3252	43252	0CB3	I_L1_6	R/W
D3203	43203	0C82	D_L1_5	R/W	D3253	43253	0CB4	D_L1_6	R/W
D3204	43204	0C83	OH_L1_5	R/W	D3254	43254	0CB5	OH_L1_6	R/W
D3205	43205	0C84	OL_L1_5	R/W	D3255	43255	0CB6	OL_L1_6	R/W
D3206	43206	0C85	MR_L1_5	R/W	D3256	43256	0CB7	MR_L1_6	R/W
D3207	43207	0C86	HYS_L1_5	R/W	D3257	43257	0CB8	HYS_L1_6	R/W
D3208	43208	0C87	SU.HY_5	R/W	D3258	43258	0CB9	SU.HY_6	R/W
D3209	43209	0C88	HY.UP_L1_5	R/W	D3259	43259	0CBA	HY.UP_L1_6	R/W
D3210	43210	0C89	HY.LO_L1_5	R/W	D3260	43260	0CBB	HY.LO_L1_6	R/W
D3211	43211	0C8A	DR_L1_5	R/W	D3261	43261	0CBC	DR_L1_6	R/W
D3212	43212	0C8B	SU.DR_5	R/W	D3262	43262	0CBD	SU.DR_6	R/W
D3213	43213	0C8C	Pc_L1_5	R/W	D3263	43263	0CBE	Pc_L1_6	R/W
D3214	43214	0C8D	Ic_L1_5	R/W	D3264	43264	0CBF	Ic_L1_6	R/W
D3215	43215	0C8E	Dc_L1_5	R/W	D3265	43265	0CC0	Dc_L1_6	R/W
D3216	43216	0C8F	OHc_L1_5	R/W	D3266	43266	0CC1	OHc_L1_6	R/W
D3217	43217	0C90	OLc_L1_5	R/W	D3267	43267	0CC2	OLc_L1_6	R/W
D3218	43218	0C91	HYSc_L1_5	R/W	D3268	43268	0CC3	HYSc_L1_6	R/W
D3219	43219	0C92	DB_L1_5	R/W	D3269	43269	0CC4	DB_L1_6	R/W
D3220	43220	0C93	PO_L1_5	R/W	D3270	43270	0CC5	PO_L1_6	R/W
D3221	43221	0C94	SU.PO_5	R/W	D3271	43271	0CC6	SU.PO_6	R/W
D3222	43222	0C95	POc_L1_5	R/W	D3272	43272	0CC7	POc_L1_6	R/W
D3223	43223	0C96			D3273	43273	0CC8		
D3224	43224	0C97			D3274	43274	0CC9		
D3225	43225	0C98			D3275	43275	0CCA		
D3226	43226	0C99			D3276	43276	0CCB		
D3227	43227	0C9A			D3277	43277	0CCC		
D3228	43228	0C9B			D3278	43278	0CCD		
D3229	43229	0C9C			D3279	43279	0CCE		
D3230	43230	0C9D			D3280	43280	0CCF		
D3231	43231	0C9E			D3281	43281	0CD0		
D3232	43232	0C9F			D3282	43282	0CD1		
D3233	43233	0CA0			D3283	43283	0CD2		
D3234	43234	0CA1			D3284	43284	0CD3		
D3235	43235	0CA2			D3285	43285	0CD4		
D3236	43236	0CA3			D3286	43286	0CD5		
D3237	43237	0CA4			D3287	43287	0CD6		
D3238	43238	0CA5			D3288	43288	0CD7		
D3239	43239	0CA6			D3289	43289	0CD8		
D3240	43240	0CA7			D3290	43290	0CD9		
D3241	43241	0CA8			D3291	43291	0CDA		
D3242	43242	0CA9			D3292	43292	0CDB		
D3243	43243	0CAA			D3293	43293	0CDC		
D3244	43244	0CAB			D3294	43294	0CDD		
D3245	43245	0CAC			D3295	43295	0CDE		
D3246	43246	0CAD			D3296	43296	0CDF		
D3247	43247	0CAE			D3297	43297	0CE0		
D3248	43248	0CAF			D3298	43298	0CE1		
D3249	43249	0CB0			D3299	43299	0CE2		
D3250	43250	0CB1			D3300	43300	0CE3		

14.4 UT75A D Registers

Loop-1 operation parameter									
PID setting (Menu: PID)									
D-Reg No.	Ref. No.	H No.	Register symbol	R/W	D-Reg No.	Ref. No.	H No.	Register symbol	R/W
				UT75A					UT75A
D3301	43301	0CE4	P_L1_7	R/W	D3351	43351	0D16	P_L1_8	R/W
D3302	43302	0CE5	I_L1_7	R/W	D3352	43352	0D17	I_L1_8	R/W
D3303	43303	0CE6	D_L1_7	R/W	D3353	43353	0D18	D_L1_8	R/W
D3304	43304	0CE7	OH_L1_7	R/W	D3354	43354	0D19	OH_L1_8	R/W
D3305	43305	0CE8	OL_L1_7	R/W	D3355	43355	0D1A	OL_L1_8	R/W
D3306	43306	0CE9	MR_L1_7	R/W	D3356	43356	0D1B	MR_L1_8	R/W
D3307	43307	0CEA	HYS_L1_7	R/W	D3357	43357	0D1C	HYS_L1_8	R/W
D3308	43308	0CEB	SU.HY_7	R/W	D3358	43358	0D1D	SU.HY_8	R/W
D3309	43309	0CEC	HY.UP_L1_7	R/W	D3359	43359	0D1E	HY.UP_L1_8	R/W
D3310	43310	0CED	HY.LO_L1_7	R/W	D3360	43360	0D1F	HY.LO_L1_8	R/W
D3311	43311	0CEE	DR_L1_7	R/W	D3361	43361	0D20	DR_L1_8	R/W
D3312	43312	0CEF	SU.DR_7	R/W	D3362	43362	0D21	SU.DR_8	R/W
D3313	43313	0CF0	Pc_L1_7	R/W	D3363	43363	0D22	Pc_L1_8	R/W
D3314	43314	0CF1	Ic_L1_7	R/W	D3364	43364	0D23	Ic_L1_8	R/W
D3315	43315	0CF2	Dc_L1_7	R/W	D3365	43365	0D24	Dc_L1_8	R/W
D3316	43316	0CF3	OHc_L1_7	R/W	D3366	43366	0D25	OHc_L1_8	R/W
D3317	43317	0CF4	OLc_L1_7	R/W	D3367	43367	0D26	OLc_L1_8	R/W
D3318	43318	0CF5	HYSc_L1_7	R/W	D3368	43368	0D27	HYSc_L1_8	R/W
D3319	43319	0CF6	DB_L1_7	R/W	D3369	43369	0D28	DB_L1_8	R/W
D3320	43320	0CF7	PO_L1_7	R/W	D3370	43370	0D29	PO_L1_8	R/W
D3321	43321	0CF8	SU.PO_7	R/W	D3371	43371	0D2A	SU.PO_8	R/W
D3322	43322	0CF9	POc_L1_7	R/W	D3372	43372	0D2B	POc_L1_8	R/W
D3323	43323	0CFA			D3373	43373	0D2C		
D3324	43324	0CFB			D3374	43374	0D2D		
D3325	43325	0CFC			D3375	43375	0D2E		
D3326	43326	0CFD			D3376	43376	0D2F		
D3327	43327	0CFE			D3377	43377	0D30		
D3328	43328	0CFF			D3378	43378	0D31		
D3329	43329	0D00			D3379	43379	0D32		
D3330	43330	0D01			D3380	43380	0D33		
D3331	43331	0D02			D3381	43381	0D34		
D3332	43332	0D03			D3382	43382	0D35		
D3333	43333	0D04			D3383	43383	0D36		
D3334	43334	0D05			D3384	43384	0D37		
D3335	43335	0D06			D3385	43385	0D38		
D3336	43336	0D07			D3386	43386	0D39		
D3337	43337	0D08			D3387	43387	0D3A		
D3338	43338	0D09			D3388	43388	0D3B		
D3339	43339	0D0A			D3389	43389	0D3C		
D3340	43340	0D0B			D3390	43390	0D3D		
D3341	43341	0D0C			D3391	43391	0D3E		
D3342	43342	0D0D			D3392	43392	0D3F		
D3343	43343	0D0E			D3393	43393	0D40		
D3344	43344	0D0F			D3394	43394	0D41		
D3345	43345	0D10			D3395	43395	0D42		
D3346	43346	0D11			D3396	43396	0D43		
D3347	43347	0D12			D3397	43397	0D44		
D3348	43348	0D13			D3398	43398	0D45		
D3349	43349	0D14			D3399	43399	0D46		
D3350	43350	0D15			D3400	43400	0D47		

Loop-1 operation parameter									
PID setting (Menu: PID)									
D-Reg No.	Ref. No.	H No.	Register symbol	R/W	D-Reg No.	Ref. No.	H No.	Register symbol	R/W
				UT75A					UT75A
D3401	43401	0D48	P_L1_R	R/W	D3451	43451	0D7A		
D3402	43402	0D49	I_L1_R	R/W	D3452	43452	0D7B		
D3403	43403	0D4A	D_L1_R	R/W	D3453	43453	0D7C		
D3404	43404	0D4B	OH_L1_R	R/W	D3454	43454	0D7D		
D3405	43405	0D4C	OL_L1_R	R/W	D3455	43455	0D7E		
D3406	43406	0D4D	MR_L1_R	R/W	D3456	43456	0D7F		
D3407	43407	0D4E	HYS_L1_R	R/W	D3457	43457	0D80		
D3408	43408	0D4F	SU.HY_R	R/W	D3458	43458	0D81		
D3409	43409	0D50	HY.UP_L1_R	R/W	D3459	43459	0D82		
D3410	43410	0D51	HY.LO_L1_R	R/W	D3460	43460	0D83		
D3411	43411	0D52	DR_L1_R	R/W	D3461	43461	0D84		
D3412	43412	0D53	SU.DR_R	R/W	D3462	43462	0D85		
D3413	43413	0D54	Pc_L1_R	R/W	D3463	43463	0D86		
D3414	43414	0D55	Ic_L1_R	R/W	D3464	43464	0D87		
D3415	43415	0D56	Dc_L1_R	R/W	D3465	43465	0D88		
D3416	43416	0D57	OHc_L1_R	R/W	D3466	43466	0D89		
D3417	43417	0D58	OLc_L1_R	R/W	D3467	43467	0D8A		
D3418	43418	0D59	HYSc_L1_R	R/W	D3468	43468	0D8B		
D3419	43419	0D5A	DB_L1_R	R/W	D3469	43469	0D8C		
D3420	43420	0D5B	PO_L1_R	R/W	D3470	43470	0D8D		
D3421	43421	0D5C	SU.PO_R	R/W	D3471	43471	0D8E		
D3422	43422	0D5D	POc_L1_R	R/W	D3472	43472	0D8F		
D3423	43423	0D5E			D3473	43473	0D90		
D3424	43424	0D5F			D3474	43474	0D91		
D3425	43425	0D60			D3475	43475	0D92		
D3426	43426	0D61			D3476	43476	0D93		
D3427	43427	0D62			D3477	43477	0D94		
D3428	43428	0D63			D3478	43478	0D95		
D3429	43429	0D64			D3479	43479	0D96		
D3430	43430	0D65			D3480	43480	0D97		
D3431	43431	0D66			D3481	43481	0D98		
D3432	43432	0D67			D3482	43482	0D99		
D3433	43433	0D68			D3483	43483	0D9A		
D3434	43434	0D69			D3484	43484	0D9B		
D3435	43435	0D6A			D3485	43485	0D9C		
D3436	43436	0D6B			D3486	43486	0D9D		
D3437	43437	0D6C			D3487	43487	0D9E		
D3438	43438	0D6D			D3488	43488	0D9F		
D3439	43439	0D6E			D3489	43489	0DA0		
D3440	43440	0D6F			D3490	43490	0DA1		
D3441	43441	0D70			D3491	43491	0DA2		
D3442	43442	0D71			D3492	43492	0DA3		
D3443	43443	0D72			D3493	43493	0DA4		
D3444	43444	0D73			D3494	43494	0DA5		
D3445	43445	0D74			D3495	43495	0DA6		
D3446	43446	0D75			D3496	43496	0DA7		
D3447	43447	0D76			D3497	43497	0DA8		
D3448	43448	0D77			D3498	43498	0DA9		
D3449	43449	0D78			D3499	43499	0DAA		
D3450	43450	0D79			D3500	43500	0DAB		

14.4 UT75A D Registers

Loop-1 operation parameter										
Control action-related setting (Tuning menu: TUNE) (Zone control menu: ZONE)										
D-Reg No.	Ref. No.	H No.	Register symbol	R/W	D-Reg No.	Ref. No.	H No.	Register symbol	R/W	
				UT75A					UT75A	
D3501	43501	0DAC	SC_L1	R/W	D3551	43551	0DDE	RP1_L1	R/W	
D3502	43502	0DAD			D3552	43552	0DDF	RP2_L1	R/W	
D3503	43503	0DAE	AT.TY_L1	R/W	D3553	43553	0DE0	RP3_L1	R/W	
D3504	43504	0DAF	AT.OH_L1	R/W	D3554	43554	0DE1	RP4_L1	R/W	
D3505	43505	0DB0	AT.OL_L1	R/W	D3555	43555	0DE2	RP5_L1	R/W	
D3506	43506	0DB1	AT.BS_L1	R/W	D3556	43556	0DE3	RP6_L1	R/W	
D3507	43507	0DB2			D3557	43557	0DE4	RP7_L1	R/W	
D3508	43508	0DB3			D3558	43558	0DE5	RHY_L1	R/W	
D3509	43509	0DB4			D3559	43559	0DE6	RDV_L1	R/W	
D3510	43510	0DB5			D3560	43560	0DE7			
D3511	43511	0DB6	STM	R/W	D3561	43561	0DE8			
D3512	43512	0DB7	SWD	R/W	D3562	43562	0DE9			
D3513	43513	0DB8	GW_L1	R/W	D3563	43563	0DEA			
D3514	43514	0DB9	GG_L1	R/W	D3564	43564	0DEB			
D3515	43515	0DBA			D3565	43565	0DEC			
D3516	43516	0DBB			D3566	43566	0DED			
D3517	43517	0DBC	BD	R/W	D3567	43567	0DEE			
D3518	43518	0DBD	BB	R/W	D3568	43568	0DEF			
D3519	43519	0DBE	BL	R/W	D3569	43569	0DF0			
D3520	43520	0DBF			D3570	43570	0DF1			
D3521	43521	0DC0	FLG	R/W	D3571	43571	0DF2			
D3522	43522	0DC1	FGN	R/W	D3572	43572	0DF3			
D3523	43523	0DC2	FBI	R/W	D3573	43573	0DF4			
D3524	43524	0DC3	FBO	R/W	D3574	43574	0DF5			
D3525	43525	0DC4			D3575	43575	0DF6			
D3526	43526	0DC5	AR_L1	R/W	D3576	43576	0DF7			
D3527	43527	0DC6			D3577	43577	0DF8			
D3528	43528	0DC7	OLMT_L1	R/W	D3578	43578	0DF9			
D3529	43529	0DC8	OPR.U_L1	R/W	D3579	43579	0DFA			
D3530	43530	0DC9	OPR.L_L1	R/W	D3580	43580	0DFB			
D3531	43531	0DCA	MPON_L1	R/W	D3581	43581	0DFC			
D3532	43532	0DCB	MPO1_L1	R/W	D3582	43582	0DFD			
D3533	43533	0DCC	MPO2_L1	R/W	D3583	43583	0DFE			
D3534	43534	0DCD	MPO3_L1	R/W	D3584	43584	0DFE			
D3535	43535	0DCE	MPO4_L1	R/W	D3585	43585	0E00			
D3536	43536	0DCF	MPO5_L1	R/W	D3586	43586	0E01			
D3537	43537	0DD0			D3587	43587	0E02			
D3538	43538	0DD1			D3588	43588	0E03			
D3539	43539	0DD2			D3589	43589	0E04			
D3540	43540	0DD3			D3590	43590	0E05			
D3541	43541	0DD4			D3591	43591	0E06			
D3542	43542	0DD5			D3592	43592	0E07			
D3543	43543	0DD6			D3593	43593	0E08			
D3544	43544	0DD7			D3594	43594	0E09			
D3545	43545	0DD8			D3595	43595	0E0A			
D3546	43546	0DD9			D3596	43596	0E0B			
D3547	43547	0DDA			D3597	43597	0E0C			
D3548	43548	0DDB			D3598	43598	0E0D			
D3549	43549	0DDC			D3599	43599	0E0E			
D3550	43550	0DDD			D3600	43600	0E0F			

Loop-1 SP and Alarm Setpoint Setting of Groups 1 to 8 (D2501 to D2700)

Register No.	Description	Range and meaning of value
D2501	SP_L1_1	Target setpoint of group 1 0.0 to 100.0% of PV input range (EU) (Setting range: SPL to SPH)
D2502	SUB_1	Sub-target setpoint (in Two-position two-level control) of group 1 Set the offset from SP. -100.0 to 100.0% of PV input range span (EUS)
D2503	PIDN_L1_1	PID number selection of group 1 Set a PID group number to use. 1 to 8 (Depends on the PIDG. setting.)
D2504	A1_L1_1	Alarm-1 setpoint of group 1
D2505	A2_L1_1	Alarm-2 setpoint of group 1
D2506	A3_L1_1	Alarm-3 setpoint of group 1
D2507	A4_L1_1	Alarm-4 setpoint of group 1
D2508	A5_L1_1	Alarm-5 setpoint of group 1
D2509	A6_L1_1	Alarm-6 setpoint of group 1
D2510	A7_L1_1	Alarm-7 setpoint of group 1
D2511	A8_L1_1	Alarm-8 setpoint of group 1
D2512	UPR_L1_1	SP ramp-up rate of group 1 Used to prevent SP from changing suddenly. Set a ramp-up rate or ramp-down rate per hour or minute. Set a time unit using the parameter TMU. 0: OFF (Disable)
D2513	DNR_L1_1	SP ramp-down rate of group 1 0.0 + 1 digit to 100.0% of PV input range span (EUS)
D2514 to D2520		
D2521 to D2531	SP_L1_2 to A8_L1_2	Target setpoint of group 2 to Alarm-8 setpoint of group 2 Same as 2501 to D2511
D2532	UPR_L1_2	SP ramp-up rate of group 2 Same as 2512 to D2513
D2533	DNR_L1_2	SP ramp-down rate of group 2
D2534 to D2540		
D2541 to D2551	SP_L1_3 to A8_L1_3	Target setpoint of group 3 to Alarm-8 setpoint of group 3 Same as D2501 to D2511
D2552	UPR_L1_3	SP ramp-up rate of group 3 Same as 2512 to D2513
D2553	DNR_L1_3	SP ramp-down rate of group 3
D2552 to D2560		
D2561 to D2571	SP_L1_4 to A8_L1_4	Target setpoint of group 4 to Alarm-8 setpoint of group 4 Same as D2501 to D2511
D2572	UPR_L1_4	SP ramp-up rate of group 4 Same as 2512 to D2513
D2573	DNR_L1_4	SP ramp-down rate of group 4
D2574 to D2580		
D2581 to D2591	SP_L1_5 to A8_L1_5	Target setpoint of group 5 to Alarm-8 setpoint of group 5 Same as D2501 to D2511
D2592	UPR_L1_5	SP ramp-up rate of group 5 Same as 2512 to D2513
D2593	DNR_L1_5	SP ramp-down rate of group 5
D2594 to D2600		
D2601 to D2611	SP_L1_6 to A8_L1_6	Target setpoint of group 6 to Alarm-8 setpoint of group 6 Same as D2501 to D2511
D2612	UPR_L1_6	SP ramp-up rate of group 6 Same as 2512 to D2513
D2613	DNR_L1_6	SP ramp-down rate of group 6
D2612 to D2620		
D2621 to D2631	SP_L1_7 to A8_L1_7	Target setpoint of group 7 to Alarm-8 setpoint of group 7 Same as D2501 to D2511
D2632	UPR_L1_7	SP ramp-up rate of group 7 Same as 2512 to D2513
D2633	DNR_L1_7	SP ramp-down rate of group 7
D2632 to D2640		
D2641 to D2651	SP_L1_8 to A8_L1_8	Target setpoint of group 8 to Alarm-8 setpoint of group 8 Same as D2501 to D2511
D2652	UPR_L1_8	SP ramp-up rate of group 8 Same as 2512 to D2513
D2653	DNR_L1_8	SP ramp-down rate of group 8
D2654 to D2700		

14.4 UT75A D Registers

Loop-1 SP-related Setting (D2701 to D2800)

Register No.		Description	Range and meaning of value
D2701	RMS_L1	Remote input method	0: RSP (Via remote (aux. analog) input) 1: COM (Via communication) RSP is not displayed if the remote (auxiliary analog) input is not specified. COM is not displayed if the communication function is not specified. When neither the remote (auxiliary analog) input nor communication function is specified, this parameter is not displayed.
D2702	RFL_L1	Remote input filter	0: OFF (Disable) 1 to 120 s
D2703	RT_L1	Remote input ratio	SP = Remote input x RT + Remote input bias 0.001 to 9.999
D2704	RBS_L1	Remote input bias	-100.0 to 100.0% of PV input range span (EUS)
D2705 to D2706			
D2707	TMU_L1	SP ramp-rate time unit	0: HOUR (Ramp-up rate or ramp-down rate per hour) 1: MIN (Ramp-up rate or ramp-down rate per minute)
D2708 to D2709			
D2710	SPT_L1	SP tracking selection	Tracking is performed when the mode changes from Remote to Local. (The local setpoint keeps track of the remote setpoint.) 0: OFF (Disable) 1: ON (Enable)
D2711	PVT_L1	PV tracking selection	Causes the setpoint to keep track of the PV so the setpoint automatically reverts to its original value at a preset rate of change. The UPR, DNR, and TMU are used in combination. Operating conditions: 1) MAN → AUTO, 2) STOP → AUTO, 3) Power-on, 4) SP number change, 5) SP change 0: OFF (Disable) 1: ON (Enable)
D2712 to D2800			

Loop-1 Alarm Function Setting (D2801 to D2900)

Register No.	Description	Range and meaning of value
D2801	AL1.T_L1	Alarm-1 type
D2802	AL1.W_L1	Alarm-1 stand-by action
D2803	AL1.D_L1	Alarm-1 energized/de-energized
D2804	AL1.L_L1	Alarm-1 latch
D2805	AL2.T_L1	Alarm-2 type
D2806	AL2.W_L1	Alarm-2 stand-by action
D2807	AL2.D_L1	Alarm-2 energized/de-energized
D2808	AL2.L_L1	Alarm-2 latch
D2809	AL3.T_L1	Alarm-3 type
D2810	AL3.W_L1	Alarm-3 stand-by action
D2811	AL3.D_L1	Alarm-3 energized/de-energized
D2812	AL3.L_L1	Alarm-3 latch
D2813	AL4.T_L1	Alarm-4 type
D2814	AL4.W_L1	Alarm-4 stand-by action
D2815	AL4.D_L1	Alarm-4 energized/de-energized
D2816	AL4.L_L1	Alarm-4 latch
D2817	AL5.T_L1	Alarm-5 type
D2818	AL5.W_L1	Alarm-5 stand-by action
D2819	AL5.D_L1	Alarm-5 energized/de-energized
D2820	AL5.L_L1	Alarm-5 latch
D2821	AL6.T_L1	Alarm-6 type
D2822	AL6.W_L1	Alarm-6 stand-by action
D2823	AL6.D_L1	Alarm-6 energized/de-energized
D2824	AL6.L_L1	Alarm-6 latch
D2825	AL7.T_L1	Alarm-7 type
D2826	AL7.W_L1	Alarm-7 stand-by action
D2827	AL7.D_L1	Alarm-7 energized/de-energized
D2828	AL7.L_L1	Alarm-7 latch
D2829	AL8.T_L1	Alarm-8 type
D2830	AL8.W_L1	Alarm-8 stand-by action
D2831	AL8.D_L1	Alarm-8 energized/de-energized
D2832	AL8.L_L1	Alarm-8 latch
D2833	VT1_L1	PV velocity alarm time setpoint 1
D2834	VT2_L1	PV velocity alarm time setpoint 2
D2835	VT3_L1	PV velocity alarm time setpoint 3
D2836	VT4_L1	PV velocity alarm time setpoint 4
D2837	VT5_L1	PV velocity alarm time setpoint 5
D2838	VT6_L1	PV velocity alarm time setpoint 6
D2839	VT7_L1	PV velocity alarm time setpoint 7
D2840	VT8_L1	PV velocity alarm time setpoint 8

AL1.T_L1 to AL8.T_L1
0: Disable
1: PV high limit
2: PV low limit
3: SP high limit
4: SP low limit
5: Deviation high limit
6: Deviation low limit
7: Deviation high and low limits
8: Deviation within high and low limits
9: Target SP high limit
10: Target SP low limit
11: Target SP deviation high limit
12: Target SP deviation low limit
13: Target SP deviation high and low limits
14: Target SP deviation within high and low limits
15: OUT high limit
16: OUT low limit
17: Cooling-side OUT high limit
18: Cooling-side OUT low limit
19: Analog input PV high limit
20: Analog input PV low limit
21: Analog input PV2 high limit
22: Analog input PV2 low limit
23: Analog input AIN2 high limit
24: Analog input AIN2 low limit
25: Analog input AIN4 high limit
26: Analog input AIN4 low limit
27: Feedback input high limit
28: Feedback input low limit
29: PV velocity
30: Fault diagnosis
31: FAIL
32: Deviation(%) high limit
33: Deviation(%) low limit
34: Deviation(%) high and low limits
35: Deviation(%) within high and low limits
36: Target SP deviation(%) high limit
37: Target SP deviation(%) low limit
38: Target SP deviation(%) high and low limits
39: Target SP deviation(%) within high and low limits

AL1.W_L1 to AL8.W_L1
0: Without Stand-by action
1: With Stand-by action

AL1.D_L1 to AL8.D_L1
0: Alarm output: Energized
1: Alarm output: De-energized

AL1.L_L1 to AL8.L_L1
0: OFF
1: Latch 1
2: Latch 2
3: Latch 3
4: Latch 4

When the UTAdvanced parameter is set by key stroke, the alarm type, stand-by action, energized/de-energized, and latch comprise one parameter.

1 to 5999 (second)

14.4 UT75A D Registers

Register No.	Description	Range and meaning of value
D2841	HY1_L1	Alarm-1 hysteresis
D2842	HY2_L1	Alarm-2 hysteresis
D2843	HY3_L1	Alarm-3 hysteresis
D2844	HY4_L1	Alarm-4 hysteresis
D2845	HY5_L1	Alarm-5 hysteresis
D2846	HY6_L1	Alarm-6 hysteresis
D2847	HY7_L1	Alarm-7 hysteresis
D2848	HY8_L1	Alarm-8 hysteresis
D2849	DYN1_L1	Alarm-1 On-delay timer
D2850	DYN2_L1	Alarm-2 On-delay timer
D2851	DYN3_L1	Alarm-3 On-delay timer
D2852	DYN4_L1	Alarm-4 On-delay timer
D2853	DYN5_L1	Alarm-5 On-delay timer
D2854	DYN6_L1	Alarm-6 On-delay timer
D2855	DYN7_L1	Alarm-7 On-delay timer
D2856	DYN8_L1	Alarm-8 On-delay timer
D2857	DYF1_L1	Alarm-1 Off-delay timer
D2858	DYF2_L1	Alarm-2 Off-delay timer
D2859	DYF3_L1	Alarm-3 Off-delay timer
D2860	DYF4_L1	Alarm-4 Off-delay timer
D2861	DYF5_L1	Alarm-5 Off-delay timer
D2862	DYF6_L1	Alarm-6 Off-delay timer
D2863	DYF7_L1	Alarm-7 Off-delay timer
D2864	DYF8_L1	Alarm-8 Off-delay timer
D2865		
D2866	AMD_L1	Alarm mode
D2867 to D2900		

Set a display value of setpoint of hysteresis.
-19999 to 30000 (Set a value within the input range.)
Decimal point position depends on the input type.

An alarm output is ON when the delay timer expires after the alarm setpoint is reached.
0 to 5999 (second)

An alarm output is OFF when the delay timer expires after the alarm setpoint is reached.
0 to 5999 (second)

0: Always active
1: Not active in STOP mode
2: Not active in STOP or MAN mode

Loop-1 PV-related Setting (D2901 to D3000)

Register No.	Description	Range and meaning of value
D2901	BS_L1	PV input bias
D2902	FL_L1	PV input filter
D2903 to D2900		

-100.0 to 100.0% of PV input range span (EUS)

0: OFF (Disable)
1 to 120 s

Loop-1 PID Setting of Groups 1 to 8 and R (D3001 to D3500)

Register No.		Description	Range and meaning of value
D3001	P_L1_1	Proportional band of group 1 Heating-side proportional band (in Heating/cooling control) of group 1	0.0 to 999.9% When 0.0% is set, it operates as 0.1%. Heating-side ON/OFF control applies when 0.0% in Heating/cooling control
D3002	I_L1_1	Integral time of group 1 Heating-side integral time (in Heating/cooling control) of group 1	0: OFF (Disable) 1 to 6000 s
D3003	D_L1_1	Derivative time of group 1 Heating-side derivative time (in Heating/cooling control) of group 1	0: OFF (Disable) 1 to 6000 s
D3004	OH_L1_1	Control output high limit of group 1 Heating-side control output high limit (in Heating/cooling control) of group 1	-4.9 to 105.0%, (OL<OH) In Heating/cooling control: 0.1 to 105.0% (OL<OH)
D3005	OL_L1_1	Control output low limit of group 1 Heating-side control output low limit (in Heating/cooling control) of group 1	-5.0 to 104.9%, (OL<OH), SD: Tight shut In Heating/cooling control: 0.0 to 104.9% (OL<OH)
D3006	MR_L1_1	Manual reset of group 1	Enabled when integral time is OFF. The manual reset value equals the output value when PV = SP. -5.0 to 105.0%
D3007	HYS_L1_1	Hysteresis (in ON/OFF control, Position proportional control, or Two-position two-level control) Heating-side ON/OFF control hysteresis (in Heating/cooling control)	In ON/OFF control or Two-position two-level control: 0.0 to 100.0% of PV input range span (EUS) In Heating/cooling control or Position proportional control: 0.0 to 100.0%
D3008	SU.HY_1	Sub-hysteresis (in Two-position two-level control) of group 1	0.0 to 100.0% of PV input range span (EUS)
D3009	HY.UP_L1_1	Upper-side hysteresis (in ON/OFF control) of group 1	0.0 to 100.0% of PV input range span (EUS)
D3010	HY.LO_L1_1	Lower-side hysteresis (in ON/OFF control) of group 1	
D3011	DR_L1_1	Direct/reverse action switch of group 1	0: RVS: Reverse action 1: DIR: Direct action
D3012	SU.DR_1	Sub-direct/reverse action switch (in Two-position two-level control) of group 1	
D3013	Pc_L1_1	Cooling-side proportional band of group 1	0.0 to 999.9% (Cooling-side ON/OFF control applies when 0.0% in Heating/cooling control)
D3014	Ic_L1_1	Cooling-side integral time of group 1	0: OFF (Disable) 1 to 6000 s
D3015	Dc_L1_1	Cooling-side derivative time of group 1	0: OFF (Disable) 1 to 6000 s
D3016	OHc_L1_1	Cooling-side control output high limit of group 1	0.1 to 105.0%, (OLc<OHc)
D3017	OLc_L1_1	Cooling-side control output low limit of group 1	0.0 to 104.9%, (OLc<OHc)
D3018	HYSc_L1_1	Cooling-side ON/OFF control hysteresis of group 1	0.0 to 100.0%
D3019	DB_L1_1	Output dead band (in Heating/cooling control or Position proportional control)	In Heating/cooling control: -100.0 to 50.0% In Position proportional control: 1.0 to 10.0%
D3020	PO_L1_1	Preset output of group 1 Heating-side preset output (in Heating/cooling control) of group 1	In STOP mode, fixed control output can be generated. In Position proportional control, Valve opening can be set -5.0 to 105.0%
D3021	SU.PO_1	Sub-preset output (in Two-position two-level control) of group 1	In STOP mode, fixed sub-control output can be generated. 0%, 100%
D3022	POc_L1_1	Cooling-side preset output of group 1	In STOP mode, cooling-side fixed control output can be generated. -5.0 to 105.0%
D3023 to D3050			

14.4 UT75A D Registers

Register No.	Description	Range and meaning of value
D3051 to D3072	P_L1_2 to POc_L1_2 Proportional band of group 2 Heating-side proportional band (in Heating/cooling control) of group 2 to Cooling-side preset output of group 2	Same as D3001 to D3022
D3073 to D3100		
D3101 to D3122	P_L1_3 to POc_L1_3 Proportional band of group 3 Heating-side proportional band (in Heating/cooling control) of group 3 to Cooling-side preset output of group 3	Same as D3001 to D3022
D3123 to D3150		
D3151 to D3172	P_L1_4 to POc_L1_4 Proportional band of group 4 Heating-side proportional band (in Heating/cooling control) of group 4 to Cooling-side preset output of group 4	Same as D3001 to D3022
D3173 to D3200		
D3201 to D3222	P_L1_5 to POc_L1_5 Proportional band of group 5 Heating-side proportional band (in Heating/cooling control) of group 5 to Cooling-side preset output of group 5	Same as D3001 to D3022
D3223 to D3250		
D3251 to D3272	P_L1_6 to POc_L1_6 Proportional band of group 6 Heating-side proportional band (in Heating/cooling control) of group 6 to Cooling-side preset output of group 6	Same as D3001 to D3022
D3273 to D3300		
D3301 to D3322	P_L1_7 to POc_L1_7 Proportional band of group 7 Heating-side proportional band (in Heating/cooling control) of group 7 to Cooling-side preset output of group 7	Same as D3001 to D3022
D3323 to D3350		
D3351 to D3372	P_L1_8 to POc_L1_8 Proportional band of group 8 Heating-side proportional band (in Heating/cooling control) of group 8 to Cooling-side preset output of group 8	Same as D3001 to D3022
D3373 to D3400		
D3401 to D3422	P_L1_R to POc_L1_R Proportional band of group R Heating-side proportional band (in Heating/cooling control) of group R to Cooling-side preset output of group R	Same as D3001 to D3022
D3423 to D3500		

Loop-1 Control Action-related Setting (D3501 to D3600)

Register No.	Description		Range and meaning of value
D3501	SC_L1	Super function	0: OFF (Disable) 1: Overshoot suppressing function (normal mode) 2: Hunting suppressing function (stable mode) Enables to answer the wider characteristic changes compared with response mode. 3: Hunting suppressing function (response mode) Enables quick follow-up and short converging time of PV for the changed SP. 4: Overshoot suppressing function (strong suppressing mode) Note: Setpoints 2 and 3 must be used in PID control or PI control. Disabled in the following controls: 1) ON/OFF control, 2) PD control, 3) P control, 4) Heating/cooling control Do not use the function for the control processes with response such as flow or pressure control.
D3502			
D3503	AT.TY_L1	Auto-tuning type	0: Normal 1: Stability
D3504	AT.OH_L1	Output high limit in auto-tuning	-5.0 to 105.0% (Disabled in Heating/cooling control)
D3505	AT.OL_L1	Output low limit in auto-tuning	
D3506	AT.BS_L1	SP bias in auto-tuning	-100.0 to 100.0% of PV input range span (EUS)
D3507 to D3510			
D3511	STM	Sample PI sampled time	0 to 9999 s
D3512	SWD	Sample PI control time span	0 to 9999 s
D3513	GW_L1	Non-linear control gap width	0: OFF 0.0+1digit to 50.0% of PV input range span (EUS)
D3514	GG_L1	Non-linear control gain	0.001 to 1.000
D3515 to D3516			
D3517	BD	Batch PID deviation setpoint	0.0 to 100.0% of PV input range span (EUS)
D3518	BB	Batch PID bias	0.0 to 100.0%
D3519	BL	Batch PID lock-up width	0.0 to 100.0% of PV input range span (EUS)
D3520			
D3521	FLG	Feedforward first-order lag time constant	0: OFF, 1 to 120 s
D3522	FGN	Feedforward gain	-9.999 to 9.999
D3523	FBI	Feedforward input bias	-100.0 to 100.0%
D3524	FBO	Feedforward output bias	-999.9 to 999.9%
D3525			
D3526	AR_L1	Anti-reset windup (excess integration prevention)	0: AUTO, 50.0 to 200.0%
D3527			
D3528	OLMT_L1	Output limiter switch	0: OFF (Disable output limiter in MAN mode) 1: ON (Enable output limiter in MAN mode)
D3529	OPR.U_L1	Upper-side output velocity limiter	0: OFF (Disable), 0.1 to 100.0%/s
D3530	OPR.L_L1	Lower-side output velocity limiter	
D3531	MPON_L1	Manual preset output number selection	Select the output used in MAN mode when switched from AUTO to MAN mode. 0: OFF (Hold the control output in AUTO mode (bumpless)) 1: Use manual preset output 1 (output bump) 2: Use manual preset output 2 (output bump) 3: Use manual preset output 3 (output bump) 4: Use manual preset output 4 (output bump) 5: Use manual preset output 5 (output bump)
D3532	MPO1_L1	Manual preset output 1	-5.0 to 105.0% However, output is limited to the output high limit and low limit.
D3533	MPO2_L1	Manual preset output 2	
D3534	MPO3_L1	Manual preset output 3	
D3535	MPO4_L1	Manual preset output 4	
D3536	MPO5_L1	Manual preset output 5	
D3537 to D3550			

14.4 UT75A D Registers

Register No.	Description		Range and meaning of value
D3551	RP1_L1	Reference point 1	Set reference points at which switching is carried out between groups of PID constants according to the given temperature zone. 0.0 to 100.0% of PV input range (EU) (RP1 ≤ RP2 ≤ RP3 ≤ RP4 ≤ RP5 ≤ RP6 ≤ RP7)
D3552	RP2_L1	Reference point 2	
D3553	RP3_L1	Reference point 3	
D3554	RP4_L1	Reference point 4	
D3555	RP5_L1	Reference point 5	
D3556	RP6_L1	Reference point 6	
D3557	RP7_L1	Reference point 7	
D3558	RHY_L1	Zone PID switching hysteresis	Hysteresis can be set for switching at a reference point. 0.0 to 10.0% of PV input range span (EUS)
D3559	RDV_L1	Reference deviation	Set a deviation from SP. The PID for reference deviation is used if there is a larger deviation than the preset reference deviation. 0: OFF (Disable) 0.0 + 1 digit to 100.0% of PV input range span (EUS)
D3560 to D3600			

14.4.4 Loop-2 Operation Parameter/Custom Display Register (D3601 to D4700)

Loop-2 operation parameter									
SP and alarm setpoint setting (Menu: SP)									
D-Reg No.	Ref. No.	H No.	Register symbol	R/W	D-Reg No.	Ref. No.	H No.	Register symbol	R/W
				UT75A					UT75A
D3601	43601	0E10	SP_L2_1	R/W	D3651	43651	0E42	A8_L2_3	R/W
D3602	43602	0E11			D3652	43652	0E43	UPR_L2_3	R/W
D3603	43603	0E12	PIDN_L2_1	R/W	D3653	43653	0E44	DNR_L2_3	R/W
D3604	43604	0E13	A1_L2_1	R/W	D3654	43654	0E45		
D3605	43605	0E14	A2_L2_1	R/W	D3655	43655	0E46		
D3606	43606	0E15	A3_L2_1	R/W	D3656	43656	0E47		
D3607	43607	0E16	A4_L2_1	R/W	D3657	43657	0E48		
D3608	43608	0E17	A5_L2_1	R/W	D3658	43658	0E49		
D3609	43609	0E18	A6_L2_1	R/W	D3659	43659	0E4A		
D3610	43610	0E19	A7_L2_1	R/W	D3660	43660	0E4B		
D3611	43611	0E1A	A8_L2_1	R/W	D3661	43661	0E4C	SP_L2_4	R/W
D3612	43612	0E1B	UPR_L2_1	R/W	D3662	43662	0E4D		
D3613	43613	0E1C	DNR_L2_1	R/W	D3663	43663	0E4E	PIDN_L2_4	R/W
D3614	43614	0E1D			D3664	43664	0E4F	A1_L2_4	R/W
D3615	43615	0E1E			D3665	43665	0E50	A2_L2_4	R/W
D3616	43616	0E1F			D3666	43666	0E51	A3_L2_4	R/W
D3617	43617	0E20			D3667	43667	0E52	A4_L2_4	R/W
D3618	43618	0E21			D3668	43668	0E53	A5_L2_4	R/W
D3619	43619	0E22			D3669	43669	0E54	A6_L2_4	R/W
D3620	43620	0E23			D3670	43670	0E55	A7_L2_4	R/W
D3621	43621	0E24	SP_L2_2	R/W	D3671	43671	0E56	A8_L2_4	R/W
D3622	43622	0E25			D3672	43672	0E57	UPR_L2_4	R/W
D3623	43623	0E26	PIDN_L2_2	R/W	D3673	43673	0E58	DNR_L2_4	R/W
D3624	43624	0E27	A1_L2_2	R/W	D3674	43674	0E59		
D3625	43625	0E28	A2_L2_2	R/W	D3675	43675	0E5A		
D3626	43626	0E29	A3_L2_2	R/W	D3676	43676	0E5B		
D3627	43627	0E2A	A4_L2_2	R/W	D3677	43677	0E5C		
D3628	43628	0E2B	A5_L2_2	R/W	D3678	43678	0E5D		
D3629	43629	0E2C	A6_L2_2	R/W	D3679	43679	0E5E		
D3630	43630	0E2D	A7_L2_2	R/W	D3680	43680	0E5F		
D3631	43631	0E2E	A8_L2_2	R/W	D3681	43681	0E60	SP_L2_5	R/W
D3632	43632	0E2F	UPR_L2_2	R/W	D3682	43682	0E61		
D3633	43633	0E30	DNR_L2_2	R/W	D3683	43683	0E62	PIDN_L2_5	R/W
D3634	43634	0E31			D3684	43684	0E63	A1_L2_5	R/W
D3635	43635	0E32			D3685	43685	0E64	A2_L2_5	R/W
D3636	43636	0E33			D3686	43686	0E65	A3_L2_5	R/W
D3637	43637	0E34			D3687	43687	0E66	A4_L2_5	R/W
D3638	43638	0E35			D3688	43688	0E67	A5_L2_5	R/W
D3639	43639	0E36			D3689	43689	0E68	A6_L2_5	R/W
D3640	43640	0E37			D3690	43690	0E69	A7_L2_5	R/W
D3641	43641	0E38	SP_L2_3	R/W	D3691	43691	0E6A	A8_L2_5	R/W
D3642	43642	0E39			D3692	43692	0E6B	UPR_L2_5	R/W
D3643	43643	0E3A	PIDN_L2_3	R/W	D3693	43693	0E6C	DNR_L2_5	R/W
D3644	43644	0E3B	A1_L2_3	R/W	D3694	43694	0E6D		
D3645	43645	0E3C	A2_L2_3	R/W	D3695	43695	0E6E		
D3646	43646	0E3D	A3_L2_3	R/W	D3696	43696	0E6F		
D3647	43647	0E3E	A4_L2_3	R/W	D3697	43697	0E70		
D3648	43648	0E3F	A5_L2_3	R/W	D3698	43698	0E71		
D3649	43649	0E40	A6_L2_3	R/W	D3699	43699	0E72		
D3650	43650	0E41	A7_L2_3	R/W	D3700	43700	0E73		

14.4 UT75A D Registers

Loop-2 operation parameter									
SP and alarm setpoint setting (Menu: SP)									
D-Reg No.	Ref. No.	H No.	Register symbol	R/W	D-Reg No.	Ref. No.	H No.	Register symbol	R/W
				UT75A					UT75A
D3701	43701	0E74	SP_L2_6	R/W	D3751	43751	0EA6	A8_L2_8	R/W
D3702	43702	0E75			D3752	43752	0EA7	UPR_L2_8	R/W
D3703	43703	0E76	PIDN_L2_6	R/W	D3753	43753	0EA8	DNR_L2_8	R/W
D3704	43704	0E77	A1_L2_6	R/W	D3754	43754	0EA9		
D3705	43705	0E78	A2_L2_6	R/W	D3755	43755	0EAA		
D3706	43706	0E79	A3_L2_6	R/W	D3756	43756	0EAB		
D3707	43707	0E7A	A4_L2_6	R/W	D3757	43757	0EAC		
D3708	43708	0E7B	A5_L2_6	R/W	D3758	43758	0EAD		
D3709	43709	0E7C	A6_L2_6	R/W	D3759	43759	0EAE		
D3710	43710	0E7D	A7_L2_6	R/W	D3760	43760	0EAF		
D3711	43711	0E7E	A8_L2_6	R/W	D3761	43761	0EB0		
D3712	43712	0E7F	UPR_L2_6	R/W	D3762	43762	0EB1		
D3713	43713	0E80	DNR_L2_6	R/W	D3763	43763	0EB2		
D3714	43714	0E81			D3764	43764	0EB3		
D3715	43715	0E82			D3765	43765	0EB4		
D3716	43716	0E83			D3766	43766	0EB5		
D3717	43717	0E84			D3767	43767	0EB6		
D3718	43718	0E85			D3768	43768	0EB7		
D3719	43719	0E86			D3769	43769	0EB8		
D3720	43720	0E87			D3770	43770	0EB9		
D3721	43721	0E88	SP_L2_7	R/W	D3771	43771	0EBA		
D3722	43722	0E89			D3772	43772	0EBB		
D3723	43723	0E8A	PIDN_L2_7	R/W	D3773	43773	0EBC		
D3724	43724	0E8B	A1_L2_7	R/W	D3774	43774	0EBD		
D3725	43725	0E8C	A2_L2_7	R/W	D3775	43775	0EBE		
D3726	43726	0E8D	A3_L2_7	R/W	D3776	43776	0EBF		
D3727	43727	0E8E	A4_L2_7	R/W	D3777	43777	0EC0		
D3728	43728	0E8F	A5_L2_7	R/W	D3778	43778	0EC1		
D3729	43729	0E90	A6_L2_7	R/W	D3779	43779	0EC2		
D3730	43730	0E91	A7_L2_7	R/W	D3780	43780	0EC3		
D3731	43731	0E92	A8_L2_7	R/W	D3781	43781	0EC4		
D3732	43732	0E93	UPR_L2_7	R/W	D3782	43782	0EC5		
D3733	43733	0E94	DNR_L2_7	R/W	D3783	43783	0EC6		
D3734	43734	0E95			D3784	43784	0EC7		
D3735	43735	0E96			D3785	43785	0EC8		
D3736	43736	0E97			D3786	43786	0EC9		
D3737	43737	0E98			D3787	43787	0ECA		
D3738	43738	0E99			D3788	43788	0ECB		
D3739	43739	0E9A			D3789	43789	0ECC		
D3740	43740	0E9B			D3790	43790	0ECD		
D3741	43741	0E9C	SP_L2_8	R/W	D3791	43791	0ECE		
D3742	43742	0E9D			D3792	43792	0ECF		
D3743	43743	0E9E	PIDN_L2_8	R/W	D3793	43793	0ED0		
D3744	43744	0E9F	A1_L2_8	R/W	D3794	43794	0ED1		
D3745	43745	0EA0	A2_L2_8	R/W	D3795	43795	0ED2		
D3746	43746	0EA1	A3_L2_8	R/W	D3796	43796	0ED3		
D3747	43747	0EA2	A4_L2_8	R/W	D3797	43797	0ED4		
D3748	43748	0EA3	A5_L2_8	R/W	D3798	43798	0ED5		
D3749	43749	0EA4	A6_L2_8	R/W	D3799	43799	0ED6		
D3750	43750	0EA5	A7_L2_8	R/W	D3800	43800	0ED7		

Loop-2 operation parameter									
SP-related setting (Menu: SPS)									
D-Reg No.	Ref. No.	H No.	Register symbol	R/W	D-Reg No.	Ref. No.	H No.	Register symbol	R/W
				UT75A					UT75A
D3801	43801	0ED8	RMS_L2	R/W	D3851	43851	F0A		
D3802	43802	0ED9	RFL_L2	R/W	D3852	43852	F0B		
D3803	43803	0EDA	RT_L2	R/W	D3853	43853	F0C		
D3804	43804	0EDB	RBS_L2	R/W	D3854	43854	F0D		
D3805	43805	0EDC			D3855	43855	F0E		
D3806	43806	0EDD			D3856	43856	F0F		
D3807	43807	0EDE	TMU_L2	R/W	D3857	43857	F10		
D3808	43808	0EDF			D3858	43858	F11		
D3809	43809	0EE0			D3859	43859	F12		
D3810	43810	0EE1	SPT_L2	R/W	D3860	43860	F13		
D3811	43811	0EE2	PVT_L2	R/W	D3861	43861	F14		
D3812	43812	0EE3			D3862	43862	F15		
D3813	43813	0EE4			D3863	43863	F16		
D3814	43814	0EE5			D3864	43864	F17		
D3815	43815	0EE6			D3865	43865	F18		
D3816	43816	0EE7			D3866	43866	F19		
D3817	43817	0EE8			D3867	43867	F1A		
D3818	43818	0EE9			D3868	43868	F1B		
D3819	43819	0EEA			D3869	43869	F1C		
D3820	43820	0EEB			D3870	43870	F1D		
D3821	43821	0EEC			D3871	43871	F1E		
D3822	43822	0EED			D3872	43872	F1F		
D3823	43823	0EEE			D3873	43873	F20		
D3824	43824	0EEF			D3874	43874	F21		
D3825	43825	0EF0			D3875	43875	F22		
D3826	43826	0EF1			D3876	43876	F23		
D3827	43827	0EF2			D3877	43877	F24		
D3828	43828	0EF3			D3878	43878	F25		
D3829	43829	0EF4			D3879	43879	F26		
D3830	43830	0EF5			D3880	43880	F27		
D3831	43831	0EF6			D3881	43881	F28		
D3832	43832	0EF7			D3882	43882	F29		
D3833	43833	0EF8			D3883	43883	F2A		
D3834	43834	0EF9			D3884	43884	F2B		
D3835	43835	0EFA			D3885	43885	F2C		
D3836	43836	0EFB			D3886	43886	F2D		
D3837	43837	0EFC			D3887	43887	F2E		
D3838	43838	0EFD			D3888	43888	F2F		
D3839	43839	0EFE			D3889	43889	F30		
D3840	43840	0EFF			D3890	43890	F31		
D3841	43841	0F00			D3891	43891	F32		
D3842	43842	0F01			D3892	43892	F33		
D3843	43843	0F02			D3893	43893	F34		
D3844	43844	0F03			D3894	43894	F35		
D3845	43845	0F04			D3895	43895	F36		
D3846	43846	0F05			D3896	43896	F37		
D3847	43847	0F06			D3897	43897	F38		
D3848	43848	0F07			D3898	43898	F39		
D3849	43849	0F08			D3899	43899	F3A		
D3850	43850	0F09			D3900	43900	F3B		

14.4 UT75A D Registers

Loop-2 operation parameter									
Alarm function setting (Menu: ALRM)									
D-Reg No.	Ref. No.	H No.	Register symbol	R/W	D-Reg No.	Ref. No.	H No.	Register symbol	R/W
				UT75A					UT75A
D3901	43901	0F3C	AL1.T_L2	R/W	D3951	43951	0F6E	DYN3_L2	R/W
D3902	43902	0F3D	AL1.W_L2	R/W	D3952	43952	0F6F	DYN4_L2	R/W
D3903	43903	0F3E	AL1.D_L2	R/W	D3953	43953	0F70	DYN5_L2	R/W
D3904	43904	0F3F	AL1.L_L2	R/W	D3954	43954	0F71	DYN6_L2	R/W
D3905	43905	0F40	AL2.T_L2	R/W	D3955	43955	0F72	DYN7_L2	R/W
D3906	43906	0F41	AL2.W_L2	R/W	D3956	43956	0F73	DYN8_L2	R/W
D3907	43907	0F42	AL2.D_L2	R/W	D3957	43957	0F74	DYF1_L2	R/W
D3908	43908	0F43	AL2.L_L2	R/W	D3958	43958	0F75	DYF2_L2	R/W
D3909	43909	0F44	AL3.T_L2	R/W	D3959	43959	0F76	DYF3_L2	R/W
D3910	43910	0F45	AL3.W_L2	R/W	D3960	43960	0F77	DYF4_L2	R/W
D3911	43911	0F46	AL3.D_L2	R/W	D3961	43961	0F78	DYF5_L2	R/W
D3912	43912	0F47	AL3.L_L2	R/W	D3962	43962	0F79	DYF6_L2	R/W
D3913	43913	0F48	AL4.T_L2	R/W	D3963	43963	0F7A	DYF7_L2	R/W
D3914	43914	0F49	AL4.W_L2	R/W	D3964	43964	0F7B	DYF8_L2	R/W
D3915	43915	0F4A	AL4.D_L2	R/W	D3965	43965	0F7C		
D3916	43916	0F4B	AL4.L_L2	R/W	D3966	43966	0F7D	AMD_L2	R/W
D3917	43917	0F4C	AL5.T_L2	R/W	D3967	43967	0F7E		
D3918	43918	0F4D	AL5.W_L2	R/W	D3968	43968	0F7F		
D3919	43919	0F4E	AL5.D_L2	R/W	D3969	43969	0F80		
D3920	43920	0F4F	AL5.L_L2	R/W	D3970	43970	0F81		
D3921	43921	0F50	AL6.T_L2	R/W	D3971	43971	0F82		
D3922	43922	0F51	AL6.W_L2	R/W	D3972	43972	0F83		
D3923	43923	0F52	AL6.D_L2	R/W	D3973	43973	0F84		
D3924	43924	0F53	AL6.L_L2	R/W	D3974	43974	0F85		
D3925	43925	0F54	AL7.T_L2	R/W	D3975	43975	0F86		
D3926	43926	0F55	AL7.W_L2	R/W	D3976	43976	0F87		
D3927	43927	0F56	AL7.D_L2	R/W	D3977	43977	0F88		
D3928	43928	0F57	AL7.L_L2	R/W	D3978	43978	0F89		
D3929	43929	0F58	AL8.T_L2	R/W	D3979	43979	0F8A		
D3930	43930	0F59	AL8.W_L2	R/W	D3980	43980	0F8B		
D3931	43931	0F5A	AL8.D_L2	R/W	D3981	43981	0F8C		
D3932	43932	0F5B	AL8.L_L2	R/W	D3982	43982	0F8D		
D3933	43933	0F5C	VT1_L2	R/W	D3983	43983	0F8E		
D3934	43934	0F5D	VT2_L2	R/W	D3984	43984	0F8F		
D3935	43935	0F5E	VT3_L2	R/W	D3985	43985	0F90		
D3936	43936	0F5F	VT4_L2	R/W	D3986	43986	0F91		
D3937	43937	0F60	VT5_L2	R/W	D3987	43987	0F92		
D3938	43938	0F61	VT6_L2	R/W	D3988	43988	0F93		
D3939	43939	0F62	VT7_L2	R/W	D3989	43989	0F94		
D3940	43940	0F63	VT8_L2	R/W	D3990	43990	0F95		
D3941	43941	0F64	HY1_L2	R/W	D3991	43991	0F96		
D3942	43942	0F65	HY2_L2	R/W	D3992	43992	0F97		
D3943	43943	0F66	HY3_L2	R/W	D3993	43993	0F98		
D3944	43944	0F67	HY4_L2	R/W	D3994	43994	0F99		
D3945	43945	0F68	HY5_L2	R/W	D3995	43995	0F9A		
D3946	43946	0F69	HY6_L2	R/W	D3996	43996	0F9B		
D3947	43947	0F6A	HY7_L2	R/W	D3997	43997	0F9C		
D3948	43948	0F6B	HY8_L2	R/W	D3998	43998	0F9D		
D3949	43949	0F6C	DYN1_L2	R/W	D3999	43999	0F9E		
D3950	43950	0F6D	DYN2_L2	R/W	D4000	44000	0F9F		

Loop-2 operation parameter									
PV-related setting (Menu: PVS)									
D-Reg No.	Ref. No.	H No.	Register symbol	R/W	D-Reg No.	Ref. No.	H No.	Register symbol	R/W
				UT75A					UT75A
D4001	44001	0FA0	BS_L2	R/W	D4051	44051	0FD2		
D4002	44002	0FA1	FL_L2	R/W	D4052	44052	0FD3		
D4003	44003	0FA2			D4053	44053	0FD4		
D4004	44004	0FA3			D4054	44054	0FD5		
D4005	44005	0FA4			D4055	44055	0FD6		
D4006	44006	0FA5			D4056	44056	0FD7		
D4007	44007	0FA6			D4057	44057	0FD8		
D4008	44008	0FA7			D4058	44058	0FD9		
D4009	44009	0FA8			D4059	44059	0FDA		
D4010	44010	0FA9			D4060	44060	vFDB		
D4011	44011	0FAA			D4061	44061	0FDC		
D4012	44012	0FAB			D4062	44062	0FDD		
D4013	44013	0FAC			D4063	44063	0FDE		
D4014	44014	0FAD			D4064	44064	0FDF		
D4015	44015	0FAE			D4065	44065	0FE0		
D4016	44016	0FAF			D4066	44066	0FE1		
D4017	44017	0FB0			D4067	44067	0FE2		
D4018	44018	0FB1			D4068	44068	0FE3		
D4019	44019	0FB2			D4069	44069	0FE4		
D4020	44020	0FB3			D4070	44070	0FE5		
D4021	44021	0FB4			D4071	44071	0FE6		
D4022	44022	0FB5			D4072	44072	0FE7		
D4023	44023	0FB6			D4073	44073	0FE8		
D4024	44024	0FB7			D4074	44074	0FE9		
D4025	44025	0FB8			D4075	44075	0FEA		
D4026	44026	0FB9			D4076	44076	0FEB		
D4027	44027	0FBA			D4077	44077	0FEC		
D4028	44028	0FBB			D4078	44078	0FED		
D4029	44029	0FBC			D4079	44079	0FEE		
D4030	44030	0FBD			D4080	44080	0FEF		
D4031	44031	0FBE			D4081	44081	0FF0		
D4032	44032	0FBF			D4082	44082	0FF1		
D4033	44033	0FC0			D4083	44083	0FF2		
D4034	44034	0FC1			D4084	44084	0FF3		
D4035	44035	0FC2			D4085	44085	0FF4		
D4036	44036	0FC3			D4086	44086	0FF5		
D4037	44037	0FC4			D4087	44087	0FF6		
D4038	44038	0FC5			D4088	44088	0FF7		
D4039	44039	0FC6			D4089	44089	0FF8		
D4040	44040	0FC7			D4090	44090	0FF9		
D4041	44041	0FC8			D4091	44091	0FFA		
D4042	44042	0FC9			D4092	44092	0FFB		
D4043	44043	0FCA			D4093	44093	0FFC		
D4044	44044	0FCB			D4094	44094	0FFD		
D4045	44045	0FCC			D4095	44095	0FFE		
D4046	44046	0FCD			D4096	44096	0FFF		
D4047	44047	0FCE			D4097	44097	1000		
D4048	44048	0FCF			D4098	44098	1001		
D4049	44049	0FD0			D4099	44099	1002		
D4050	44050	0FD1			D4100	44100	1003		

14.4 UT75A D Registers

Loop-2 operation parameter									
PID setting (Menu: PID)									
D-Reg No.	Ref. No.	H No.	Register symbol	R/W	D-Reg No.	Ref. No.	H No.	Register symbol	R/W
				UT75A					UT75A
D4101	44101	1004	P_L2_1	R/W	D4151	44151	1036	P_L2_2	R/W
D4102	44102	1005	I_L2_1	R/W	D4152	44152	1037	I_L2_2	R/W
D4103	44103	1006	D_L2_1	R/W	D4153	44153	1038	D_L2_2	R/W
D4104	44104	1007	OH_L2_1	R/W	D4154	44154	1039	OH_L2_2	R/W
D4105	44105	1008	OL_L2_1	R/W	D4155	44155	103A	OL_L2_2	R/W
D4106	44106	1009	MR_L2_1	R/W	D4156	44156	103B	MR_L2_2	R/W
D4107	44107	100A	HYS_L2_1	R/W	D4157	44157	103C	HYS_L2_2	R/W
D4108	44108	100B			D4158	44158	103D		
D4109	44109	100C	HY.UP_L2_1	R/W	D4159	44159	103E	HY.UP_L2_2	R/W
D4110	44110	100D	HY.LO_L2_1	R/W	D4160	44160	103F	HY.LO_L2_2	R/W
D4111	44111	100E	DR_L2_1	R/W	D4161	44161	1040	DR_L2_2	R/W
D4112	44112	100F			D4162	44162	1041		
D4113	44113	1010	Pc_L2_1	R/W	D4163	44163	1042	Pc_L2_2	R/W
D4114	44114	1011	Ic_L2_1	R/W	D4164	44164	1043	Ic_L2_2	R/W
D4115	44115	1012	Dc_L2_1	R/W	D4165	44165	1044	Dc_L2_2	R/W
D4116	44116	1013	OHc_L2_1	R/W	D4166	44166	1045	OHc_L2_2	R/W
D4117	44117	1014	OLc_L2_1	R/W	D4167	44167	1046	OLc_L2_2	R/W
D4118	44118	1015	HYSc_L2_1	R/W	D4168	44168	1047	HYSc_L2_2	R/W
D4119	44119	1016	DB_L2_1	R/W	D4169	44169	1048	DB_L2_2	R/W
D4120	44120	1017	PO_L2_1	R/W	D4170	44170	1049	PO_L2_2	R/W
D4121	44121	1018			D4171	44171	104A		
D4122	44122	1019	POc_L2_1	R/W	D4172	44172	104B	POc_L2_2	R/W
D4123	44123	101A			D4173	44173	104C		
D4124	44124	101B			D4174	44174	104D		
D4125	44125	101C			D4175	44175	104E		
D4126	44126	101D			D4176	44176	104F		
D4127	44127	101E			D4177	44177	1050		
D4128	44128	101F			D4178	44178	1051		
D4129	44129	1020			D4179	44179	1052		
D4130	44130	1021			D4180	44180	1053		
D4131	44131	1022			D4181	44181	1054		
D4132	44132	1023			D4182	44182	1055		
D4133	44133	1024			D4183	44183	1056		
D4134	44134	1025			D4184	44184	1057		
D4135	44135	1026			D4185	44185	1058		
D4136	44136	1027			D4186	44186	1059		
D4137	44137	1028			D4187	44187	105A		
D4138	44138	1029			D4188	44188	105B		
D4139	44139	102A			D4189	44189	105C		
D4140	44140	102B			D4190	44190	105D		
D4141	44141	102C			D4191	44191	105E		
D4142	44142	102D			D4192	44192	105F		
D4143	44143	102E			D4193	44193	1060		
D4144	44144	102F			D4194	44194	1061		
D4145	44145	1030			D4195	44195	1062		
D4146	44146	1031			D4196	44196	1063		
D4147	44147	1032			D4197	44197	1064		
D4148	44148	1033			D4198	44198	1065		
D4149	44149	1034			D4199	44199	1066		
D4150	44150	1035			D4200	44200	1067		

Loop-2 operation parameter									
PID setting (Menu: PID)									
D-Reg No.	Ref. No.	H No.	Register symbol	R/W	D-Reg No.	Ref. No.	H No.	Register symbol	R/W
				UT75A					UT75A
D4201	44201	1068	P_L2_3	R/W	D4251	44251	109A	P_L2_4	R/W
D4202	44202	1069	I_L2_3	R/W	D4252	44252	109B	I_L2_4	R/W
D4203	44203	106A	D_L2_3	R/W	D4253	44253	109C	D_L2_4	R/W
D4204	44204	106B	OH_L2_3	R/W	D4254	44254	109D	OH_L2_4	R/W
D4205	44205	106C	OL_L2_3	R/W	D4255	44255	109E	OL_L2_4	R/W
D4206	44206	106D	MR_L2_3	R/W	D4256	44256	109F	MR_L2_4	R/W
D4207	44207	106E	HYS_L2_3	R/W	D4257	44257	10A0	HYS_L2_4	R/W
D4208	44208	106F			D4258	44258	10A1		
D4209	44209	1070	HY.UP_L2_3	R/W	D4259	44259	10A2	HY.UP_L2_4	R/W
D4210	44210	1071	HY.LO_L2_3	R/W	D4260	44260	10A3	HY.LO_L2_4	R/W
D4211	44211	1072	DR_L2_3	R/W	D4261	44261	10A4	DR_L2_4	R/W
D4212	44212	1073			D4262	44262	10A5		
D4213	44213	1074	Pc_L2_3	R/W	D4263	44263	10A6	Pc_L2_4	R/W
D4214	44214	1075	Ic_L2_3	R/W	D4264	44264	10A7	Ic_L2_4	R/W
D4215	44215	1076	Dc_L2_3	R/W	D4265	44265	10A8	Dc_L2_4	R/W
D4216	44216	1077	OHc_L2_3	R/W	D4266	44266	10A9	OHc_L2_4	R/W
D4217	44217	1078	OLc_L2_3	R/W	D4267	44267	10AA	OLc_L2_4	R/W
D4218	44218	1079	HYS_L2_3	R/W	D4268	44268	10AB	HYS_L2_4	R/W
D4219	44219	107A	DB_L2_3	R/W	D4269	44269	10AC	DB_L2_4	R/W
D4220	44220	107B	PO_L2_3	R/W	D4270	44270	10AD	PO_L2_4	R/W
D4221	44221	107C			D4271	44271	10AE		
D4222	44222	107D	POc_L2_3	R/W	D4272	44272	10AF	POc_L2_4	R/W
D4223	44223	107E			D4273	44273	10B0		
D4224	44224	107F			D4274	44274	10B1		
D4225	44225	1080			D4275	44275	10B2		
D4226	44226	1081			D4276	44276	10B3		
D4227	44227	1082			D4277	44277	10B4		
D4228	44228	1083			D4278	44278	10B5		
D4229	44229	1084			D4279	44279	10B6		
D4230	44230	1085			D4280	44280	10B7		
D4231	44231	1086			D4281	44281	10B8		
D4232	44232	1087			D4282	44282	10B9		
D4233	44233	1088			D4283	44283	10BA		
D4234	44234	1089			D4284	44284	10BB		
D4235	44235	108A			D4285	44285	10BC		
D4236	44236	108B			D4286	44286	10BD		
D4237	44237	108C			D4287	44287	10BE		
D4238	44238	108D			D4288	44288	10BF		
D4239	44239	108E			D4289	44289	10C0		
D4240	44240	108F			D4290	44290	10C1		
D4241	44241	1090			D4291	44291	10C2		
D4242	44242	1091			D4292	44292	10C3		
D4243	44243	1092			D4293	44293	10C4		
D4244	44244	1093			D4294	44294	10C5		
D4245	44245	1094			D4295	44295	10C6		
D4246	44246	1095			D4296	44296	10C7		
D4247	44247	1096			D4297	44297	10C8		
D4248	44248	1097			D4298	44298	10C9		
D4249	44249	1098			D4299	44299	10CA		
D4250	44250	1099			D4300	44300	10CB		

14.4 UT75A D Registers

Loop-2 operation parameter									
PID setting (Menu: PID)									
D-Reg No.	Ref. No.	H No.	Register symbol	R/W	D-Reg No.	Ref. No.	H No.	Register symbol	R/W
				UT75A					UT75A
D4301	44301	10CC	P_L2_5	R/W	D4351	44351	10FE	P_L2_6	R/W
D4302	44302	10CD	I_L2_5	R/W	D4352	44352	10FF	I_L2_6	R/W
D4303	44303	10CE	D_L2_5	R/W	D4353	44353	1100	D_L2_6	R/W
D4304	44304	10CF	OH_L2_5	R/W	D4354	44354	1101	OH_L2_6	R/W
D4305	44305	10D0	OL_L2_5	R/W	D4355	44355	1102	OL_L2_6	R/W
D4306	44306	10D1	MR_L2_5	R/W	D4356	44356	1103	MR_L2_6	R/W
D4307	44307	10D2	HYS_L2_5	R/W	D4357	44357	1104	HYS_L2_6	R/W
D4308	44308	10D3			D4358	44358	1105		
D4309	44309	10D4	HY.UP_L2_5	R/W	D4359	44359	1106	HY.UP_L2_6	R/W
D4310	44310	10D5	HY.LO_L2_5	R/W	D4360	44360	1107	HY.LO_L2_6	R/W
D4311	44311	10D6	DR_L2_5	R/W	D4361	44361	1108	DR_L2_6	R/W
D4312	44312	10D7			D4362	44362	1109		
D4313	44313	10D8	Pc_L2_5	R/W	D4363	44363	110A	Pc_L2_6	R/W
D4314	44314	10D9	Ic_L2_5	R/W	D4364	44364	110B	Ic_L2_6	R/W
D4315	44315	10DA	Dc_L2_5	R/W	D4365	44365	110C	Dc_L2_6	R/W
D4316	44316	10DB	OHc_L2_5	R/W	D4366	44366	110D	OHc_L2_6	R/W
D4317	44317	10DC	OLc_L2_5	R/W	D4367	44367	110E	OLc_L2_6	R/W
D4318	44318	10DD	HYSc_L2_5	R/W	D4368	44368	110F	HYSc_L2_6	R/W
D4319	44319	10DE	DB_L2_5	R/W	D4369	44369	1110	DB_L2_6	R/W
D4320	44320	10DF	PO_L2_5	R/W	D4370	44370	1111	PO_L2_6	R/W
D4321	44321	10E0			D4371	44371	1112		
D4322	44322	10E1	POc_L2_5	R/W	D4372	44372	1113	POc_L2_6	R/W
D4323	44323	10E2			D4373	44373	1114		
D4324	44324	10E3			D4374	44374	1115		
D4325	44325	10E4			D4375	44375	1116		
D4326	44326	10E5			D4376	44376	1117		
D4327	44327	10E6			D4377	44377	1118		
D4328	44328	10E7			D4378	44378	1119		
D4329	44329	10E8			D4379	44379	111A		
D4330	44330	10E9			D4380	44380	111B		
D4331	44331	10EA			D4381	44381	111C		
D4332	44332	10EB			D4382	44382	111D		
D4333	44333	10EC			D4383	44383	111E		
D4334	44334	10ED			D4384	44384	111F		
D4335	44335	10EE			D4385	44385	1120		
D4336	44336	10EF			D4386	44386	1121		
D4337	44337	10F0			D4387	44387	1122		
D4338	44338	10F1			D4388	44388	1123		
D4339	44339	10F2			D4389	44389	1124		
D4340	44340	10F3			D4390	44390	1125		
D4341	44341	10F4			D4391	44391	1126		
D4342	44342	10F5			D4392	44392	1127		
D4343	44343	10F6			D4393	44393	1128		
D4344	44344	10F7			D4394	44394	1129		
D4345	44345	10F8			D4395	44395	112A		
D4346	44346	10F9			D4396	44396	112B		
D4347	44347	10FA			D4397	44397	112C		
D4348	44348	10FB			D4398	44398	112D		
D4349	44349	10FC			D4399	44399	112E		
D4350	44350	10FD			D4400	44400	112F		

Loop-2 operation parameter									
PID setting (Menu: PID)									
D-Reg No.	Ref. No.	H No.	Register symbol	R/W	D-Reg No.	Ref. No.	H No.	Register symbol	R/W
				UT75A					UT75A
D4401	44401	1130	P_L2_7	R/W	D4451	44451	1162	P_L2_8	R/W
D4402	44402	1131	I_L2_7	R/W	D4452	44452	1163	I_L2_8	R/W
D4403	44403	1132	D_L2_7	R/W	D4453	44453	1164	D_L2_8	R/W
D4404	44404	1133	OH_L2_7	R/W	D4454	44454	1165	OH_L2_8	R/W
D4405	44405	1134	OL_L2_7	R/W	D4455	44455	1166	OL_L2_8	R/W
D4406	44406	1135	MR_L2_7	R/W	D4456	44456	1167	MR_L2_8	R/W
D4407	44407	1136	HYS_L2_7	R/W	D4457	44457	1168	HYS_L2_8	R/W
D4408	44408	1137			D4458	44458	1169		
D4409	44409	1138	HY.UP_L2_7	R/W	D4459	44459	116A	HY.UP_L2_8	R/W
D4410	44410	1139	HY.LO_L2_7	R/W	D4460	44460	116B	HY.LO_L2_8	R/W
D4411	44411	113A	DR_L2_7	R/W	D4461	44461	116C	DR_L2_8	R/W
D4412	44412	113B			D4462	44462	116D		
D4413	44413	113C	Pc_L2_7	R/W	D4463	44463	116E	Pc_L2_8	R/W
D4414	44414	113D	Ic_L2_7	R/W	D4464	44464	116F	Ic_L2_8	R/W
D4415	44415	113E	Dc_L2_7	R/W	D4465	44465	1170	Dc_L2_8	R/W
D4416	44416	113F	OHc_L2_7	R/W	D4466	44466	1171	OHc_L2_8	R/W
D4417	44417	1140	OLc_L2_7	R/W	D4467	44467	1172	OLc_L2_8	R/W
D4418	44418	1141	HYSc_L2_7	R/W	D4468	44468	1173	HYSc_L2_8	R/W
D4419	44419	1142	DB_L2_7	R/W	D4469	44469	1174	DB_L2_8	R/W
D4420	44420	1143	PO_L2_7	R/W	D4470	44470	1175	PO_L2_8	R/W
D4421	44421	1144			D4471	44471	1176		
D4422	44422	1145	POc_L2_7	R/W	D4472	44472	1177	POc_L2_8	R/W
D4423	44423	1146			D4473	44473	1178		
D4424	44424	1147			D4474	44474	1179		
D4425	44425	1148			D4475	44475	117A		
D4426	44426	1149			D4476	44476	117B		
D4427	44427	114A			D4477	44477	117C		
D4428	44428	114B			D4478	44478	117D		
D4429	44429	114C			D4479	44479	117E		
D4430	44430	114D			D4480	44480	117F		
D4431	44431	114E			D4481	44481	1180		
D4432	44432	114F			D4482	44482	1181		
D4433	44433	1150			D4483	44483	1182		
D4434	44434	1151			D4484	44484	1183		
D4435	44435	1152			D4485	44485	1184		
D4436	44436	1153			D4486	44486	1185		
D4437	44437	1154			D4487	44487	1186		
D4438	44438	1155			D4488	44488	1187		
D4439	44439	1156			D4489	44489	1188		
D4440	44440	1157			D4490	44490	1189		
D4441	44441	1158			D4491	44491	118A		
D4442	44442	1159			D4492	44492	118B		
D4443	44443	115A			D4493	44493	118C		
D4444	44444	115B			D4494	44494	118D		
D4445	44445	115C			D4495	44495	118E		
D4446	44446	115D			D4496	44496	118F		
D4447	44447	115E			D4497	44497	1190		
D4448	44448	115F			D4498	44498	1191		
D4449	44449	1160			D4499	44499	1192		
D4450	44450	1161			D4500	44500	1193		

14.4 UT75A D Registers

Loop-2 operation parameter									
PID setting (Menu: PID)									
D-Reg No.	Ref. No.	H No.	Register symbol	R/W	D-Reg No.	Ref. No.	H No.	Register symbol	R/W
				UT75A					UT75A
D4501	44501	1194	P_L2_R	R/W	D4551	44551	11C6		
D4502	44502	1195	I_L2_R	R/W	D4552	44552	11C7		
D4503	44503	1196	D_L2_R	R/W	D4553	44553	11C8		
D4504	44504	1197	OH_L2_R	R/W	D4554	44554	11C9		
D4505	44505	1198	OL_L2_R	R/W	D4555	44555	11CA		
D4506	44506	1199	MR_L2_R	R/W	D4556	44556	11CB		
D4507	44507	119A	HYS_L2_R	R/W	D4557	44557	11CC		
D4508	44508	119B			D4558	44558	11CD		
D4509	44509	119C	HY.UP_L2_R	R/W	D4559	44559	11CE		
D4510	44510	119D	HY.LO_L2_R	R/W	D4560	44560	11CF		
D4511	44511	119E	DR_L2_R	R/W	D4561	44561	11D0		
D4512	44512	119F			D4562	44562	11D1		
D4513	44513	11A0	Pc_L2_R	R/W	D4563	44563	11D2		
D4514	44514	11A1	Ic_L2_R	R/W	D4564	44564	11D3		
D4515	44515	11A2	Dc_L2_R	R/W	D4565	44565	11D4		
D4516	44516	11A3	OHc_L2_R	R/W	D4566	44566	11D5		
D4517	44517	11A4	OLc_L2_R	R/W	D4567	44567	11D6		
D4518	44518	11A5	HYSc_L2_R	R/W	D4568	44568	11D7		
D4519	44519	11A6	DB_L2_R	R/W	D4569	44569	11D8		
D4520	44520	11A7	PO_L2_R	R/W	D4570	44570	11D9		
D4521	44521	11A8			D4571	44571	11DA		
D4522	44522	11A9	POc_L2_R	R/W	D4572	44572	11DB		
D4523	44523	11AA			D4573	44573	11DC		
D4524	44524	11AB			D4574	44574	11DD		
D4525	44525	11AC			D4575	44575	11DE		
D4526	44526	11AD			D4576	44576	11DF		
D4527	44527	11AE			D4577	44577	11E0		
D4528	44528	11AF			D4578	44578	11E1		
D4529	44529	11B0			D4579	44579	11E2		
D4530	44530	11B1			D4580	44580	11E3		
D4531	44531	11B2			D4581	44581	11E4		
D4532	44532	11B3			D4582	44582	11E5		
D4533	44533	11B4			D4583	44583	11E6		
D4534	44534	11B5			D4584	44584	11E7		
D4535	44535	11B6			D4585	44585	11E8		
D4536	44536	11B7			D4586	44586	11E9		
D4537	44537	11B8			D4587	44587	11EA		
D4538	44538	11B9			D4588	44588	11EB		
D4539	44539	11BA			D4589	44589	11EC		
D4540	44540	11BB			D4590	44590	11ED		
D4541	44541	11BC			D4591	44591	11EE		
D4542	44542	11BD			D4592	44592	11EF		
D4543	44543	11BE			D4593	44593	11F0		
D4544	44544	11BF			D4594	44594	11F1		
D4545	44545	11C0			D4595	44595	11F2		
D4546	44546	11C1			D4596	44596	11F3		
D4547	44547	11C2			D4597	44597	11F4		
D4548	44548	11C3			D4598	44598	11F5		
D4549	44549	11C4			D4599	44599	11F6		
D4550	44550	11C5			D4600	44600	11F7		

Loop-2 operation parameter									
Control action-related setting (Tuning menu: TUNE) (Zone control menu: ZONE)									
D-Reg No.	Ref. No.	H No.	Register symbol	R/W	D-Reg No.	Ref. No.	H No.	Register symbol	R/W
				UT75A					UT75A
D4601	44601	11F8	SC_L2	R/W	D4651	44651	122A		
D4602	44602	11F9			D4652	44652	122B		
D4603	44603	11FA	AT.TY_L2	R/W	D4653	44653	122C	RP1_L2	R/W
D4604	44604	11FB	AT.OH_L2	R/W	D4654	44654	122D	RP2_L2	R/W
D4605	44605	11FC	AT.OL_L2	R/W	D4655	44655	122E	RP3_L2	R/W
D4606	44606	11FD	AT.BS_L2	R/W	D4656	44656	122F	RP4_L2	R/W
D4607	44607	11FE			D4657	44657	1230	RP5_L2	R/W
D4608	44608	11FF			D4658	44658	1231	RP6_L2	R/W
D4609	44609	1200			D4659	44659	1232	RP7_L2	R/W
D4610	44610	1201			D4660	44660	1233	RHY_L2	R/W
D4611	44611	1202			D4661	44661	1234	RDV_L2	R/W
D4612	44612	1203			D4662	44662	1235		
D4613	44613	1204	GW_L2	R/W	D4663	44663	1236		
D4614	44614	1205	GG_L2	R/W	D4664	44664	1237		
D4615	44615	1206			D4665	44665	1238		
D4616	44616	1207			D4666	44666	1239		
D4617	44617	1208			D4667	44667	123A		
D4618	44618	1209			D4668	44668	123B		
D4619	44619	120A			D4669	44669	123C		
D4620	44620	120B			D4670	44670	123D		
D4621	44621	120C			D4671	44671	123E		
D4622	44622	120D			D4672	44672	123F		
D4623	44623	120E			D4673	44673	1240		
D4624	44624	120F			D4674	44674	1241		
D4625	44625	1210			D4675	44675	1242		
D4626	44626	1211	AR_L2	R/W	D4676	44676	1243		
D4627	44627	1212			D4677	44677	1244		
D4628	44628	1213	OLMT_L2	R/W	D4678	44678	1245		
D4629	44629	1214	OPR.U_L2	R/W	D4679	44679	1246		
D4630	44630	1215	OPR.L_L2	R/W	D4680	44680	1247		
D4631	44631	1216	MPON_L2	R/W	D4681	44681	1248		
D4632	44632	1217	MPO1_L2	R/W	D4682	44682	1249		
D4633	44633	1218	MPO2_L2	R/W	D4683	44683	124A		
D4634	44634	1219	MPO3_L2	R/W	D4684	44684	124B		
D4635	44635	121A	MPO4_L2	R/W	D4685	44685	124C		
D4636	44636	121B	MPO5_L2	R/W	D4686	44686	124D		
D4637	44637	121C			D4687	44687	124E		
D4638	44638	121D			D4688	44688	124F		
D4639	44639	121E			D4689	44689	1250		
D4640	44640	121F			D4690	44690	1251		
D4641	44641	1220			D4691	44691	1252		
D4642	44642	1221			D4692	44692	1253		
D4643	44643	1222			D4693	44693	1254		
D4644	44644	1223			D4694	44694	1255		
D4645	44645	1224			D4695	44695	1256		
D4646	44646	1225			D4696	44696	1257		
D4647	44647	1226			D4697	44697	1258		
D4648	44648	1227			D4698	44698	1259		
D4649	44649	1228			D4699	44699	125A		
D4650	44650	1229			D4700	44700	125B		

14.4 UT75A D Registers

Loop-2 SP and Alarm Setpoint Setting of Groups 1 to 8 (D3601 to D3800)

Register No.	Description	Range and meaning of value
D3601	SP_L2_1	Target setpoint of group 1
D3602		
D3603	PIDN_L2_1	PID number selection of group 1
D3604	A1_L2_1	Alarm-1 setpoint of group 1
D3605	A2_L2_1	Alarm-2 setpoint of group 1
D3606	A3_L2_1	Alarm-3 setpoint of group 1
D3607	A4_L2_1	Alarm-4 setpoint of group 1
D3608	A5_L2_1	Alarm-5 setpoint of group 1
D3609	A6_L2_1	Alarm-6 setpoint of group 1
D3610	A7_L2_1	Alarm-7 setpoint of group 1
D3611	A8_L2_1	Alarm-8 setpoint of group 1
D3612	UPR_L2_1	SP ramp-up rate of group 1
D3613	DNR_L2_1	SP ramp-down rate of group 1
D3614 to D3620		
D3621 to D3631	SP_L2_2 to A8_L2_2	Target setpoint of group 2 to Alarm-8 setpoint of group 2
D3632	UPR_L2_2	SP ramp-up rate of group 2
D3633	DNR_L2_2	SP ramp-down rate of group 2
D3634 to D3640		
D3641 to D3651	SP_L2_3 to A8_L2_3	Target setpoint of group 3 to Alarm-8 setpoint of group 3
D3652	UPR_L2_3	SP ramp-up rate of group 3
D3653	DNR_L2_3	SP ramp-down rate of group 3
D3654 to D3660		
D3661 to D3671	SP_L2_4 to A8C_L2_4	Target setpoint of group 4 to Alarm-8 setpoint of group 4
D3672	UPR_L2_4	SP ramp-up rate of group 4
D3673	DNR_L2_4	SP ramp-down rate of group 4
D3674 to D3680		
D3681 to D3691	SP_L2_5 to A8_L2_5	Target setpoint of group 5 to Alarm-8 setpoint of group 5
D3692	UPR_L2_5	SP ramp-up rate of group 5
D3693	DNR_L2_5	SP ramp-down rate of group 5
D3694 to D3700		
D3701 to D3711	SP_L2_6 to A8_L2_6	Target setpoint of group 6 to Alarm-8 setpoint of group 6
D3712	UPR_L2_6	SP ramp-up rate of group 6
D3713	DNR_L2_6	SP ramp-down rate of group 6
D3714 to D3720		
D3721 to D3731	SP_L2_7 to A8_L2_7	Target setpoint of group 7 to Alarm-8 setpoint of group 7
D3732	UPR_L2_7	SP ramp-up rate of group 7
D3733	DNR_L2_7	SP ramp-down rate of group 7
D3734 to D3740		
D3741 to D3751	SP_L2_8 to A8_L2_8	Target setpoint of group 8 to Alarm-8 setpoint of group 8
D3752	UPR_L2_8	SP ramp-up rate of group 8
D3753	DNR_L2_8	SP ramp-down rate of group 8
D3754 to D3800		

Loop-2 SP-related Setting (D3801 to D3900)

Register No.		Description	Range and meaning of value
D3801	RMS_L2	Remote input method	0: RSP (Via remote (aux. analog) input) 1: COM (Via communication) RSP is not displayed if the remote (auxiliary analog) input is not specified. COM is not displayed if the communication function is not specified. When neither the remote (auxiliary analog) input nor communication function is specified, this parameter is not displayed.
D3802	RFL_L2	Remote input filter	0: OFF (Disable) 1 to 120 s
D3803	RT_L2	Remote input ratio	SP = Remote input x RT + Remote input bias 0.001 to 9.999
D3804	RBS_L2	Remote input bias	-100.0 to 100.0% of PV input range span (EUS)
D3805 to D3806			
D3807	TMU_L2	SP ramp-rate time unit	0: HOUR (Ramp-up rate or ramp-down rate per hour) 1: MIN (Ramp-up rate or ramp-down rate per minute)
D3808 to D3809			
D3810	SPT_L2	SP tracking selection	Tracking is performed when the mode changes from Remote to Local. (The local setpoint keeps track of the remote setpoint.) 0: OFF (Disable) 1: ON (Enable)
D3811	PVT_L2	PV tracking selection	Causes the setpoint to keep track of the PV so the setpoint automatically reverts to its original value at a preset rate of change. The UPR, DNR, and TMU are used in combination. Operating conditions: 1) MAN → AUTO, 2) STOP → AUTO, 3) Power-on, 4) SP number change, 5) SP change 0: OFF (Disable) 1: ON (Enable)
D3812 to D3900			

14.4 UT75A D Registers

Loop-2 Alarm Function Setting (D3901 to D4000)

Register No.	Description	Range and meaning of value
D3901	AL1.T_L2	AL1.T_L1 to AL8.T_L1 00: Disable 01: PV high limit 02: PV low limit 03: SP high limit 04: SP low limit 05: Deviation high limit 06: Deviation low limit 07: Deviation high and low limits 08: Deviation within high and low limits 09: Target SP high limit 10: Target SP low limit 11: Target SP deviation high limit 12: Target SP deviation low limit 13: Target SP deviation high and low limits 14: Target SP deviation within high and low limits 15: OUT high limit 16: OUT low limit 17: Cooling-side OUT high limit 18: Cooling-side OUT low limit 19: Analog input PV high limit 20: Analog input PV low limit 21: Analog input PV2 high limit 22: Analog input PV2 low limit 23: Analog input AIN2 high limit 24: Analog input AIN2 low limit 25: Analog input AIN4 high limit 26: Analog input AIN4 low limit 27: Feedback input high limit 28: Feedback input low limit 29: PV velocity 30: Fault diagnosis 31: FAIL 32: Deviation(%) high limit 33: Deviation(%) low limit 34: Deviation(%) high and low limits 35: Deviation(%) within high and low limits 36: Target SP deviation(%) high limit 37: Target SP deviation(%) low limit 38: Target SP deviation(%) high and low limits 39: Target SP deviation(%) within high and low limits AL1.W_L1 to AL8.W_L1 0: Without Stand-by action 1: With Stand-by action AL1.D_L1 to AL8.D_L1 0: Alarm output: Energized 1: Alarm output: De-energized AL1.L_L1 to AL8.L_L1 0: OFF 1: Latch 1 2: Latch 2 3: Latch 3 4: Latch 4 When the UTAdvanced parameter is set by key stroke, the alarm type, stand-by action, energized/de-energized, and latch comprise one parameter.
D3902	AL1.W_L2	
D3903	AL1.D_L2	
D3904	AL1.L_L2	
D3905	AL2.T_L2	
D3906	AL2.W_L2	
D3907	AL2.D_L2	
D3908	AL2.L_L2	
D3909	AL3.T_L2	
D3910	AL3.W_L2	
D3911	AL3.D_L2	
D3912	AL3.L_L2	
D3913	AL4.T_L2	
D3914	AL4.W_L2	
D3915	AL4.D_L2	
D3916	AL4.L_L2	
D3917	AL5.T_L2	
D3918	AL5.W_L2	
D3919	AL5.D_L2	
D3920	AL5.L_L2	
D3921	AL6.T_L2	
D3922	AL6.W_L2	
D3923	AL6.D_L2	
D3924	AL6.L_L2	
D3925	AL7.T_L2	
D3926	AL7.W_L2	
D3927	AL7.D_L2	
D3928	AL7.L_L2	
D3929	AL8.T_L2	
D3930	AL8.W_L2	
D3931	AL8.D_L2	
D3932	AL8.L_L2	Alarm-8 latch
D3933	VT1_L2	PV velocity alarm time setpoint 1
D3934	VT2_L2	PV velocity alarm time setpoint 2
D3935	VT3_L2	PV velocity alarm time setpoint 3
D3936	VT4_L2	PV velocity alarm time setpoint 4
D3937	VT5_L2	PV velocity alarm time setpoint 5
D3938	VT6_L2	PV velocity alarm time setpoint 6
D3939	VT7_L2	PV velocity alarm time setpoint 7
D3940	VT8_L2	PV velocity alarm time setpoint 8

Register No.	Description		Range and meaning of value
D3941	HY1_L2	Alarm-1 hysteresis	Set a display value of setpoint of hysteresis. -19999 to 30000 (Set a value within the input range.) Decimal point position depends on the input type.
D3942	HY2_L2	Alarm-2 hysteresis	
D3943	HY3_L2	Alarm-3 hysteresis	
D3944	HY4_L2	Alarm-4 hysteresis	
D3945	HY5_L2	Alarm-5 hysteresis	
D3946	HY6_L2	Alarm-6 hysteresis	
D3947	HY7_L2	Alarm-7 hysteresis	
D3948	HY8_L2	Alarm-8 hysteresis	
D3949	DYN1_L2	Alarm-1 On-delay timer	An alarm output is ON when the delay timer expires after the alarm setpoint is reached. 0.00 to 99.59 (m.s)
D3950	DYN2_L2	Alarm-2 On-delay timer	
D3951	DYN3_L2	Alarm-3 On-delay timer	
D3952	DYN4_L2	Alarm-4 On-delay timer	
D3953	DYN5_L2	Alarm-5 On-delay timer	
D3954	DYN6_L2	Alarm-6 On-delay timer	
D3955	DYN7_L2	Alarm-7 On-delay timer	
D3956	DYN8_L2	Alarm-8 On-delay timer	
D3957	DYF1_L2	Alarm-1 Off-delay timer	An alarm output is OFF when the delay timer expires after the alarm setpoint is reached. 0.00 to 99.59 (m.s)
D3958	DYF2_L2	Alarm-2 Off-delay timer	
D3959	DYF3_L2	Alarm-3 Off-delay timer	
D3960	DYF4_L2	Alarm-4 Off-delay timer	
D3961	DYF5_L2	Alarm-5 Off-delay timer	
D3962	DYF6_L2	Alarm-6 Off-delay timer	
D3963	DYF7_L2	Alarm-7 Off-delay timer	
D3964	DYF8_L2	Alarm-8 Off-delay timer	
D3965			
D3966	AMD_L2	Alarm mode	0: Always active 1: Not active in STOP mode 2: Not active in STOP or MAN mode
D3967 to D4000			

Loop-2 PV-related Setting (D4001 to D4100)

Register No.	Description		Range and meaning of value
D4001	BS_L2	PV input bias	-100.0 to 100.0% of PV input range span (EUS)
D4002	FL_L2	PV input filter	0: OFF (Disable) 1 to 120 s
D4003 to D4100			

14.4 UT75A D Registers

Loop-2 PID Setting of Groups 1 to 8 and R (D4101 to D4600)

Register No.	Description		Range and meaning of value
D4101	P_L2_1	Proportional band of group 1 Heating-side proportional band (in Heating/cooling control) of group 1	0.0 to 999.9% When 0.0% is set, it operates as 0.1%. Heating-side ON/OFF control applies when 0.0% in Heating/cooling control
D4102	I_L2_1	Integral time of group 1 Heating-side integral time (in Heating/cooling control) of group 1	0: OFF (Disable) 1 to 6000 s
D4103	D_L2_1	Derivative time of group 1 Heating-side derivative time (in Heating/cooling control) of group 1	0: OFF (Disable) 1 to 6000 s
D4104	OH_L2_1	Control output high limit of group 1 Heating-side control output high limit (in Heating/cooling control) of group 1	-4.9 to 105.0%, (OL<OH) In Heating/cooling control: 0.1 to 105.0% (OL<OH)
D4105	OL_L2_1	Control output low limit of group 1 Heating-side control output low limit (in Heating/cooling control) of group 1	-5.0 to 104.9%, (OL<OH), SD: Tight shut In Heating/cooling control: 0.0 to 104.9% (OL<OH)
D4106	MR_L2_1	Manual reset of group 1	Enabled when integral time is OFF. The manual reset value equals the output value when PV = SP. -5.0 to 105.0%
D4107	HYS_L2_1	Hysteresis (in Position proportional control) Heating-side ON/OFF control hysteresis (in Heating/cooling control)	In Heating/cooling control or Position proportional control: 0.0 to 100.0%
D4108			
D4109	HY.UP_L2_1	Upper-side hysteresis (in ON/OFF control) of group 1	0.0 to 100.0% of PV input range span (EUS)
D4110	HY.LO_L2_1	Lower-side hysteresis (in ON/OFF control) of group 1	
D4111	DR_L2_1	Direct/reverse action switch of group 1	0: RVS: Reverse action 1: DIR: Direct action
D4112			
D4113	Pc_L2_1	Cooling-side proportional band of group 1	0.0 to 999.9% (Cooling-side ON/OFF control applies when 0.0% in Heating/cooling control)
D4114	Ic_L2_1	Cooling-side integral time of group 1	0: OFF (Disable) 1 to 6000 s
D4115	Dc_L2_1	Cooling-side derivative time of group 1	0: OFF (Disable) 1 to 6000 s
D4116	OHc_L2_1	Cooling-side control output high limit of group 1	0.1 to 105.0%, (OLc<OHc)
D4117	OLc_L2_1	Cooling-side control output low limit of group 1	0.0 to 104.9%, (OLc<OHc)
D4118	HYSc_L2_1	Cooling-side ON/OFF control hysteresis of group 1	0.0 to 100.0%
D4119	DB_L2_1	Output dead band (in Heating/cooling control or Position proportional control)	In Heating/cooling control: -100.0 to 50.0% In Position proportional control: 1.0 to 10.0%
D4120	PO_L2_1	Preset output of group 1 Heating-side preset output (in Heating/cooling control) of group 1	In STOP mode, fixed control output can be generated. In Position proportional control, Valve opening can be set -5.0 to 105.0%
D4121			
D4122	POc_L2_1	Cooling-side preset output of group 1	In STOP mode, cooling-side fixed control output can be generated. -5.0 to 105.0%
D4123 to D4450			

Register No.	Description		Range and meaning of value
D4151 to D4172	P_L2_2 to POc_L2_2	Proportional band of group 2 Heating-side proportional band (in Heating/cooling control) of group 2 to Cooling-side preset output of group 2	Same as D4101 to D4122
D4173 to D4200			
D4201 to D4222	P_L2_3 to POc_L2_3	Proportional band of group 3 Heating-side proportional band (in Heating/cooling control) of group 3 to Cooling-side preset output of group 3	Same as D4101 to D4122
D4223 to D4250			
D4251 to D4272	P_L2_4 to POc_L2_4	Proportional band of group 4 Heating-side proportional band (in Heating/cooling control) of group 4 to Cooling-side preset output of group 4	Same as D4101 to D4122
D4273 to D4300			
D4301 to D4322	P_L2_5 to POc_L2_5	Proportional band of group 5 Heating-side proportional band (in Heating/cooling control) of group 5 to Cooling-side preset output of group 5	Same as D4101 to D4122
D4323 to D4350			
D4351 to D4372	P_L2_6 to POc_L2_6	Proportional band of group 6 Heating-side proportional band (in Heating/cooling control) of group 6 to Cooling-side preset output of group 6	Same as D4101 to D4122
D4373 to D4400			
D4401 to D4422	P_L2_7 to POc_L2_7	Proportional band of group 7 Heating-side proportional band (in Heating/cooling control) of group 7 to Cooling-side preset output of group 7	Same as D4101 to D4122
D4423 to D4450			
D4451 to D4472	P_L2_8 to POc_L2_8	Proportional band of group 8 Heating-side proportional band (in Heating/cooling control) of group 8 to Cooling-side preset output of group 8	Same as D4101 to D4122
D4473 to D4500			
D4501 to D4522	P_L2_R to POc_L2_R	Proportional band of group R Heating-side proportional band (in Heating/cooling control) of group R to Cooling-side preset output of group R	Same as D4101 to D4122
D4523 to D4600			

14.4 UT75A D Registers

Loop-2 Control Action-related Setting (D4601 to D4690)

Register No.	Description		Range and meaning of value
D4601	SC_L2	Super function	0: OFF (Disable) 1: Overshoot suppressing function (normal mode) 2: Hunting suppressing function (stable mode) Enables to answer the wider characteristic changes compared with response mode. 3: Hunting suppressing function (response mode) Enables quick follow-up and short converging time of PV for the changed SP. 4: Overshoot suppressing function (strong suppressing mode) Note: Setpoints 2 and 3 must be used in PID control or PI control. Disabled in the following controls: 1) ON/OFF control, 2) PD control, 3) P control, 4) Heating/cooling control Do not use the function for the control processes with response such as flow or pressure control.
D4602			
D4603	AT.TY_L2	Auto-tuning type	0: Normal, 1: Stability
D4604	AT.OH_L2	Output high limit in auto-tuning	-5.0 to 105.0% (Disabled in Heating/cooling control)
D4605	AT.OL_L2	Output low limit in auto-tuning	
D4606	AT.BS_L2	SP bias in auto-tuning	-100.0 to 100.0% of PV input range span (EUS)
D4607 to D4612			
D4613	GW_L2	Non-linear control gap width	0: OFF 0.0+1digit to 50.0% of PV input range span (EUS)
D4614	GG_L2	Non-linear control gain	0.001 to 1.000
D4615 to D4625			
D4626	AR_L2	Anti-reset windup (excess integration prevention)	0: AUTO, 50.0 to 200.0%
D4627			
D4628	OLMT_L2	Output limiter switch	0: OFF (Disable output limiter in MAN mode) 1: ON (Enable output limiter in MAN mode)
D4629	OPR.U_L2	Upper-side output velocity limiter	0: OFF (Disable), 0.1 to 100.0%/s
D4630	OPR.L_L2	Lower-side output velocity limiter	
D4631	MPON_L2	Manual preset output number selection	Select the output used in MAN mode when switched from AUTO to MAN mode. 0: OFF (Hold the control output in AUTO mode (bumpless)) 1: Use manual preset output 1 (output bump) 2: Use manual preset output 2 (output bump) 3: Use manual preset output 3 (output bump) 4: Use manual preset output 4 (output bump) 5: Use manual preset output 5 (output bump)
D4632	MPO1_L2	Manual preset output 1	-5.0 to 105.0%
D4633	MPO2_L2	Manual preset output 2	
D4634	MPO3_L2	Manual preset output 3	
D4635	MPO4_L2	Manual preset output 4	
D4636	MPO5_L2	Manual preset output 5	
D4637 to D4652			
D4653	RP1_L2	Reference point 1	0.0 to 100.0% of PV input range (EU) (RP1 ≤ RP2 ≤ RP3 ≤ RP4 ≤ RP5 ≤ RP6 ≤ RP7)
D4654	RP2_L2	Reference point 2	
D4655	RP3_L2	Reference point 3	
D4656	RP4_L2	Reference point 4	
D4657	RP5_L2	Reference point 5	
D4658	RP6_L2	Reference point 6	
D4659	RP7_L2	Reference point 7	
D4660	RHY_L2	Zone PID switching hysteresis	0.0 to 10.0% of PV input range span (EUS)
D4661	RDV_L2	Reference deviation	0: OFF (Disable) 0.0 + 1 digit to 100.0% of PV input range span (EUS)
D4662 to D4690			

14.4.5 P Parameter (D4701 to D4800)

P parameter									
P parameter (Menu: PPAR)									
D-Reg No.	Ref. No.	H No.	Register symbol	R/W	D-Reg No.	Ref. No.	H No.	Register symbol	R/W
				UT75A					UT75A
D4701	44701	125C	P01D	R/W	D4751	44751	128E		
D4702	44702	125D	P02D	R/W	D4752	44752	128F		
D4703	44703	125E	P03D	R/W	D4753	44753	1290		
D4704	44704	125F	P04D	R/W	D4754	44754	1291		
D4705	44705	1260	P05D	R/W	D4755	44755	1292		
D4706	44706	1261	P06D	R/W	D4756	44756	1293		
D4707	44707	1262	P07D	R/W	D4757	44757	1294		
D4708	44708	1263	P08D	R/W	D4758	44758	1295		
D4709	44709	1264	P09D	R/W	D4759	44759	1296		
D4710	44710	1265	P10D	R/W	D4760	44760	1297		
D4711	44711	1266	P11D	R/W	D4761	44761	1298		
D4712	44712	1267	P12D	R/W	D4762	44762	1299		
D4713	44713	1268	P13D	R/W	D4763	44763	129A		
D4714	44714	1269	P14D	R/W	D4764	44764	129B		
D4715	44715	126A	P15D	R/W	D4765	44765	129C		
D4716	44716	126B	P16D	R/W	D4766	44766	129D		
D4717	44717	126C	P17D	R/W	D4767	44767	129E		
D4718	44718	126D	P18D	R/W	D4768	44768	129F		
D4719	44719	126E	P19D	R/W	D4769	44769	12A0		
D4720	44720	126F	P20D	R/W	D4770	44770	12A1		
D4721	44721	1270	P01	R/W	D4771	44771	12A2	P21	R/W
D4722	44722	1271	P02	R/W	D4772	44772	12A3	P22	R/W
D4723	44723	1272	P03	R/W	D4773	44773	12A4	P23	R/W
D4724	44724	1273	P04	R/W	D4774	44774	12A5	P24	R/W
D4725	44725	1274	P05	R/W	D4775	44775	12A6	P25	R/W
D4726	44726	1275	P06	R/W	D4776	44776	12A7	P26	R/W
D4727	44727	1276	P07	R/W	D4777	44777	12A8	P27	R/W
D4728	44728	1277	P08	R/W	D4778	44778	12A9	P28	R/W
D4729	44729	1278	P09	R/W	D4779	44779	12AA	P29	R/W
D4730	44730	1279	P10	R/W	D4780	44780	12AB	P30	R/W
D4731	44731	127A	P11	R/W	D4781	44781	12AC		
D4732	44732	127B	P12	R/W	D4782	44782	12AD		
D4733	44733	127C	P13	R/W	D4783	44783	12AE		
D4734	44734	127D	P14	R/W	D4784	44784	12AF		
D4735	44735	127E	P15	R/W	D4785	44785	12B0		
D4736	44736	127F	P16	R/W	D4786	44786	12B1		
D4737	44737	1280	P17	R/W	D4787	44787	12B2		
D4738	44738	1281	P18	R/W	D4788	44788	12B3		
D4739	44739	1282	P19	R/W	D4789	44789	12B4		
D4740	44740	1283	P20	R/W	D4790	44790	12B5		
D4741	44741	1284	P21D	R/W	D4791	44791	12B6		
D4742	44742	1285	P22D	R/W	D4792	44792	12B7		
D4743	44743	1286	P23D	R/W	D4793	44793	12B8		
D4744	44744	1287	P24D	R/W	D4794	44794	12B9		
D4745	44745	1288	P25D	R/W	D4795	44795	12BA		
D4746	44746	1289	P26D	R/W	D4796	44796	12BB		
D4747	44747	128A	P27D	R/W	D4797	44797	12BC		
D4748	44748	128B	P28D	R/W	D4798	44798	12BD		
D4749	44749	128C	P29D	R/W	D4799	44799	12BE		
D4750	44750	128D	P30D	R/W	D4800	44800	12BF		

14.4 UT75A D Registers

P parameter (D4701 to D4770)

Register No.	Description	Range and meaning of value
D4701	P01D	P01 decimal point position
D4702	P02D	P02 decimal point position
D4703	P03D	P03 decimal point position
D4704	P04D	P04 decimal point position
D4705	P05D	P05 decimal point position
D4706	P06D	P06 decimal point position
D4707	P07D	P07 decimal point position
D4708	P08D	P08 decimal point position
D4709	P09D	P09 decimal point position
D4710	P10D	P10 decimal point position
D4711	P11D	P11 decimal point position
D4712	P12D	P12 decimal point position
D4713	P13D	P13 decimal point position
D4714	P14D	P14 decimal point position
D4715	P15D	P15 decimal point position
D4716	P16D	P16 decimal point position
D4717	P17D	P17 decimal point position
D4718	P18D	P18 decimal point position
D4719	P19D	P19 decimal point position
D4720	P20D	P20 decimal point position
D4721	P01	P01 parameter
D4722	P02	P02 parameter
D4723	P03	P03 parameter
D4724	P04	P04 parameter
D4725	P05	P05 parameter
D4726	P06	P06 parameter
D4727	P07	P07 parameter
D4728	P08	P08 parameter
D4729	P09	P09 parameter
D4730	P10	P10 parameter
D4731	P11	P11 parameter
D4732	P12	P12 parameter
D4733	P13	P13 parameter
D4734	P14	P14 parameter
D4735	P15	P15 parameter
D4736	P16	P16 parameter
D4737	P17	P17 parameter
D4738	P18	P18 parameter
D4739	P19	P19 parameter
D4740	P20	P20 parameter
D4741	P21D	P21 decimal point position
D4742	P22D	P22 decimal point position
D4743	P23D	P23 decimal point position
D4744	P24D	P24 decimal point position
D4745	P25D	P25 decimal point position
D4746	P26D	P26 decimal point position
D4747	P27D	P27 decimal point position
D4748	P28D	P28 decimal point position
D4749	P29D	P29 decimal point position
D4750	P30D	P30 decimal point position
D4751 to D4770		

0: No decimal place
1: One decimal place
2: Two decimal places
3: Three decimal places
4: Four decimal places

0: No decimal place
1: One decimal place
2: Two decimal places
3: Three decimal places
4: Four decimal places

-19999 to 30000 (Set a decimal point position using LL50A Parameter Setting Software.)

-19999 to 30000 (Set a decimal point position using LL50A Parameter Setting Software.)

0: No decimal place
1: One decimal place
2: Two decimal places
3: Three decimal places
4: Four decimal places

P parameter (D4771 to D4800)

Register No.	Description		Range and meaning of value
D4771	P21	P21 parameter	-19999 to 30000 (Set a decimal point position using LL50A Parameter Setting Software.)
D4772	P22	P22 parameter	
D4773	P23	P23 parameter	
D4774	P24	P24 parameter	
D4775	P25	P25 parameter	
D4776	P26	P26 parameter	
D4777	P27	P27 parameter	
D4778	P28	P28 parameter	
D4779	P29	P29 parameter	
D4780	P30	P30 parameter	
D4781 to D4800			

14.4 UT75A D Registers

14.4.6 10-segment Linearizer Setting Parameter (D4801 to D5000)

10-segment linearizer setting parameter									
10-segment linearizer setting (Menu: PYS1, PYS2, PYS3)									
D-Reg No.	Ref. No.	H No.	Register symbol	R/W	D-Reg No.	Ref. No.	H No.	Register symbol	R/W
				UT75A					UT75A
D4801	44801	12C0	PYS_1	R/W	D4851	44851	12F2	B10_2	R/W
D4802	44802	12C1	A1_1	R/W	D4852	44852	12F3	A11_2	R/W
D4803	44803	12C2	B1_1	R/W	D4853	44853	12F4	B11_2	R/W
D4804	44804	12C3	A2_1	R/W	D4854	44854	12F5	PMD_2	R/W
D4805	44805	12C4	B2_1	R/W	D4855	44855	12F6		
D4806	44806	12C5	A3_1	R/W	D4856	44856	12F7		
D4807	44807	12C6	B3_1	R/W	D4857	44857	12F8		
D4808	44808	12C7	A4_1	R/W	D4858	44858	12F9		
D4809	44809	12C8	B4_1	R/W	D4859	44859	12FA		
D4810	44810	12C9	A5_1	R/W	D4860	44860	12FB		
D4811	44811	12CA	B5_1	R/W	D4861	44861	12FC	PYS_3	R/W
D4812	44812	12CB	A6_1	R/W	D4862	44862	12FD	A1_3	R/W
D4813	44813	12CC	B6_1	R/W	D4863	44863	12FE	B1_3	R/W
D4814	44814	12CD	A7_1	R/W	D4864	44864	12FF	A2_3	R/W
D4815	44815	12CE	B7_1	R/W	D4865	44865	1300	B2_3	R/W
D4816	44816	12CF	A8_1	R/W	D4866	44866	1301	A3_3	R/W
D4817	44817	12D0	B8_1	R/W	D4867	44867	1302	B3_3	R/W
D4818	44818	12D1	A9_1	R/W	D4868	44868	1303	A4_3	R/W
D4819	44819	12D2	B9_1	R/W	D4869	44869	1304	B4_3	R/W
D4820	44820	12D3	A10_1	R/W	D4870	44870	1305	A5_3	R/W
D4821	44821	12D4	B10_1	R/W	D4871	44871	1306	B5_3	R/W
D4822	44822	12D5	A11_1	R/W	D4872	44872	1307	A6_3	R/W
D4823	44823	12D6	B11_1	R/W	D4873	44873	1308	B6_3	R/W
D4824	44824	12D7	PMD_1	R/W	D4874	44874	1309	A7_3	R/W
D4825	44825	12D8			D4875	44875	130A	B7_3	R/W
D4826	44826	12D9			D4876	44876	130B	A8_3	R/W
D4827	44827	12DA			D4877	44877	130C	B8_3	R/W
D4828	44828	12DB			D4878	44878	130D	A9_3	R/W
D4829	44829	12DC			D4879	44879	130E	B9_3	R/W
D4830	44830	12DD			D4880	44880	130F	A10_3	R/W
D4831	44831	12DE	PYS_2	R/W	D4881	44881	1310	B10_3	R/W
D4832	44832	12DF	A1_2	R/W	D4882	44882	1311	A11_3	R/W
D4833	44833	12E0	B1_2	R/W	D4883	44883	1312	B11_3	R/W
D4834	44834	12E1	A2_2	R/W	D4884	44884	1313	PMD_3	R/W
D4835	44835	12E2	B2_2	R/W	D4885	44885	1314		
D4836	44836	12E3	A3_2	R/W	D4886	44886	1315		
D4837	44837	12E4	B3_2	R/W	D4887	44887	1316		
D4838	44838	12E5	A4_2	R/W	D4888	44888	1317		
D4839	44839	12E6	B4_2	R/W	D4889	44889	1318		
D4840	44840	12E7	A5_2	R/W	D4890	44890	1319		
D4841	44841	12E8	B5_2	R/W	D4891	44891	131A		
D4842	44842	12E9	A6_2	R/W	D4892	44892	131B		
D4843	44843	12EA	B6_2	R/W	D4893	44893	131C		
D4844	44844	12EB	A7_2	R/W	D4894	44894	131D		
D4845	44845	12EC	B7_2	R/W	D4895	44895	131E		
D4846	44846	12ED	A8_2	R/W	D4896	44896	131F		
D4847	44847	12EE	B8_2	R/W	D4897	44897	1320		
D4848	44848	12EF	A9_2	R/W	D4898	44898	1321		
D4849	44849	12F0	B9_2	R/W	D4899	44899	1322		
D4850	44850	12F1	A10_2	R/W	D4900	44900	1323		

10-segment linearizer setting parameter									
10-segment linearizer setting (Menu: PYS4)									
D-Reg No.	Ref. No.	H No.	Register symbol	R/W	D-Reg No.	Ref. No.	H No.	Register symbol	R/W
				UT75A					UT75A
D4901	44901	1324	PYS_4	R/W	D4951	44951	1356		
D4902	44902	1325	A1_4	R/W	D4952	44952	1357		
D4903	44903	1326	B1_4	R/W	D4953	44953	1358		
D4904	44904	1327	A2_4	R/W	D4954	44954	1359		
D4905	44905	1328	B2_4	R/W	D4955	44955	135A		
D4906	44906	1329	A3_4	R/W	D4956	44956	135B		
D4907	44907	132A	B3_4	R/W	D4957	44957	135C		
D4908	44908	132B	A4_4	R/W	D4958	44958	135D		
D4909	44909	132C	B4_4	R/W	D4959	44959	135E		
D4910	44910	132D	A5_4	R/W	D4960	44960	135F		
D4911	44911	132E	B5_4	R/W	D4961	44961	1360		
D4912	44912	132F	A6_4	R/W	D4962	44962	1361		
D4913	44913	1330	B6_4	R/W	D4963	44963	1362		
D4914	44914	1331	A7_4	R/W	D4964	44964	1363		
D4915	44915	1332	B7_4	R/W	D4965	44965	1364		
D4916	44916	1333	A8_4	R/W	D4966	44966	1365		
D4917	44917	1334	B8_4	R/W	D4967	44967	1366		
D4918	44918	1335	A9_4	R/W	D4968	44968	1367		
D4919	44919	1336	B9_4	R/W	D4969	44969	1368		
D4920	44920	1337	A10_4	R/W	D4970	44970	1369		
D4921	44921	1338	B10_4	R/W	D4971	44971	136A		
D4922	44922	1339	A11_4	R/W	D4972	44972	136B		
D4923	44923	133A	B11_4	R/W	D4973	44973	136C		
D4924	44924	133B	PMD_4	R/W	D4974	44974	136D		
D4925	44925	133C			D4975	44975	136E		
D4926	44926	133D			D4976	44976	136F		
D4927	44927	133E			D4977	44977	1370		
D4928	44928	133F			D4978	44978	1371		
D4929	44929	1340			D4979	44979	1372		
D4930	44930	1341			D4980	44980	1373		
D4931	44931	1342			D4981	44981	1374		
D4932	44932	1343			D4982	44982	1375		
D4933	44933	1344			D4983	44983	1376		
D4934	44934	1345			D4984	44984	1377		
D4935	44935	1346			D4985	44985	1378		
D4936	44936	1347			D4986	44986	1379		
D4937	44937	1348			D4987	44987	137A		
D4938	44938	1349			D4988	44988	137B		
D4939	44939	134A			D4989	44989	137C		
D4940	44940	134B			D4990	44990	137D		
D4941	44941	134C			D4991	44991	137E		
D4942	44942	134D			D4992	44992	137F		
D4943	44943	134E			D4993	44993	1380		
D4944	44944	134F			D4994	44994	1381		
D4945	44945	1350			D4995	44995	1382		
D4946	44946	1351			D4996	44996	1383		
D4947	44947	1352			D4997	44997	1384		
D4948	44948	1353			D4998	44998	1385		
D4949	44949	1354			D4999	44999	1386		
D4950	44950	1355			D5000	45000	1387		

14.4 UT75A D Registers

10-segment Linearizer Setting (D4801 to D5000)

Register No.	Description		Range and meaning of value
D4801	PYS_1	10-segment linearizer selection of group 1	0: OFF (Disable) 1: PV (PV analog input) 2: PV2 (PV2 analog input) 3: AIN2 (AIN2 analog input) 4: AIN4 (AIN4 analog input) 5: PVIN (PV input) 6: OUT (OUT analog output) 7: OUT2 (OUT2 analog output) 8: RET (RET analog output) 9: PV2 input 10: 20-segment linearizer, PV analog input 11: 20-segment linearizer, PV2 analog input 12: 20-segment linearizer, AIN2 analog input 13: 20-segment linearizer, AIN4 analog input 14: 10-segment linearizer, used by the ladder program 15: 20-segment linearizer, used by the ladder program
D4802	A1_1	10-segment linearizer input 1 of group 1	A1_1 to A11_1 -66.7 to 105.0% of input range (EU) Output linearizer: -5.0 to 105.0% B1_1 to B11_1 10-segment linearizer bias: -66.7 to 105.0% of input range span (EUS) 10-segment linearizer approximation: -66.7 to 105.0% of input range (EU) Output linearizer: -5.0 to 105.0%
D4803	B1_1	10-segment linearizer output 1 of group 1	
D4804	A2_1	10-segment linearizer input 2 of group 1	
D4805	B2_1	10-segment linearizer output 2 of group 1	
D4806	A3_1	10-segment linearizer input 3 of group 1	
D4807	B3_1	10-segment linearizer output 3 of group 1	
D4808	A4_1	10-segment linearizer input 4 of group 1	
D4809	B4_1	10-segment linearizer output 4 of group 1	
D4810	A5_1	10-segment linearizer input 5 of group 1	
D4811	B5_1	10-segment linearizer output 5 of group 1	
D4812	A6_1	10-segment linearizer input 6 of group 1	
D4813	B6_1	10-segment linearizer output 6 of group 1	
D4814	A7_1	10-segment linearizer input 7 of group 1	
D4815	B7_1	10-segment linearizer output 7 of group 1	
D4816	A8_1	10-segment linearizer input 8 of group 1	
D4817	B8_1	10-segment linearizer output 8 of group 1	
D4818	A9_1	10-segment linearizer input 9 of group 1	
D4819	B9_1	10-segment linearizer output 9 of group 1	
D4820	A10_1	10-segment linearizer input 10 of group 1	
D4821	B10_1	10-segment linearizer output 10 of group 1	
D4822	A11_1	10-segment linearizer input 11 of group 1	
D4823	B11_1	10-segment linearizer output 11 of group 1	
D4824	PMD_1	10-segment linearizer mode of group 1	0: 10-segment linearizer bias 1: 10-segment linearizer approximation
D4825 to D4830			
D4831	PYS_2	10-segment linearizer selection of group 2	Same as D4801
D4832 to D4853	A1_2 to B11_2	10-segment linearizer input 1 of group 2 to 10-segment linearizer output 11 of group 2	Same as D4802 to D4823
D4854	PMD_2	10-segment linearizer mode of group 2	Same as D4824
D4855 to D4860			
D4861	PYS_3	10-segment linearizer selection of group 3	Same as D4801
D4862 to D4883	A1_3 to B11_3	10-segment linearizer input 1 of group 3 to 10-segment linearizer output 11 of group 3	Same as D4802 to D4823
D4884	PMD_3	10-segment linearizer mode of group 3	Same as D4824
D4885 to D4800			
D4801	PYS_4	10-segment linearizer selection of group 4	Same as D4801
D4802 to D4823	A1_4 to B11_4	10-segment linearizer input 1 of group 4 to 10-segment linearizer output 11 of group 4	Same as D4802 to D4823
D4824	PMD_4	10-segment linearizer mode of group 4	Same as D4824
D4825 to D5000			

14.4.7 Setup Parameters (D5001 to D7000)

Setup parameter									
Control function setting (Menu: CTL)									
D-Reg No.	Ref. No.	H No.	Register symbol	R/W	D-Reg No.	Ref. No.	H No.	Register symbol	R/W
				UT75A					UT75A
D5001	45001	1388	CTLM	R/W	D5051	45051	13BA		
D5002	45002	1389			D5052	45052	13BB		
D5003	45003	138A	CNT_L1	R/W	D5053	45053	13BC		
D5004	45004	138B	CNT_L2	R/W	D5054	45054	13BD		
D5005	45005	138C	ALG_L1	R/W	D5055	45055	13BE		
D5006	45006	138D	ALG_L2	R/W	D5056	45056	13BF		
D5007	45007	138E	SPGR.	R/W	D5057	45057	13C0		
D5008	45008	138F			D5058	45058	13C1		
D5009	45009	1390	ALNO_L1	R/W	D5059	45059	13C2		
D5010	45010	1391	ALNO_L2	R/W	D5060	45060	13C3		
D5011	45011	1392			D5061	45061	13C4		
D5012	45012	1393	ZON	R/W	D5062	45062	13C5		
D5013	45013	1394	PGTY	R/W	D5063	45063	13C6		
D5014	45014	1395	PIDG.	R/W	D5064	45064	13C7		
D5015	45015	1396			D5065	45065	13C8		
D5016	45016	1397			D5066	45066	13C9		
D5017	45017	1398			D5067	45067	13CA		
D5018	45018	1399			D5068	45068	13CB		
D5019	45019	139A	SMP	R/W	D5069	45069	13CC		
D5020	45020	139B			D5070	45070	13CD		
D5021	45021	139C			D5071	45071	13CE		
D5022	45022	139D			D5072	45072	13CF		
D5023	45023	139E			D5073	45073	13D0		
D5024	45024	139F			D5074	45074	13D1		
D5025	45025	13A0			D5075	45075	13D2		
D5026	45026	13A1			D5076	45076	13D3		
D5027	45027	13A2			D5077	45077	13D4		
D5028	45028	13A3			D5078	45078	13D5		
D5029	45029	13A4	SR2L	R/W	D5079	45079	13D6		
D5030	45030	13A5	SRPG	R/W	D5080	45080	13D7		
D5031	45031	13A6			D5081	45081	13D8		
D5032	45032	13A7			D5082	45082	13D9		
D5033	45033	13A8			D5083	45083	13DA		
D5034	45034	13A9			D5084	45084	13DB		
D5035	45035	13AA			D5085	45085	13DC		
D5036	45036	13AB			D5086	45086	13DD		
D5037	45037	13AC			D5087	45087	13DE		
D5038	45038	13AD			D5088	45088	13DF		
D5039	45039	13AE			D5089	45089	13E0		
D5040	45040	13AF			D5090	45090	13E1		
D5041	45041	13B0			D5091	45091	13E2		
D5042	45042	13B1			D5092	45092	13E3		
D5043	45043	13B2			D5093	45093	13E4		
D5044	45044	13B3			D5094	45094	13E5		
D5045	45045	13B4			D5095	45095	13E6		
D5046	45046	13B5			D5096	45096	13E7		
D5047	45047	13B6			D5097	45097	13E8		
D5048	45048	13B7			D5098	45098	13E9		
D5049	45049	13B8			D5099	45099	13EA		
D5050	45050	13B9			D5100	45100	13EB		

14.4 UT75A D Registers

Setup parameter									
Input setting (PV input setting menu: PV) (PV2 input setting menu: PV2)									
D-Reg No.	Ref. No.	H No.	Register symbol	R/W	D-Reg No.	Ref. No.	H No.	Register symbol	R/W
				UT75A					UT75A
D5101	45101	13EC	IN	R/W	D5151	45151	141E		
D5102	45102	13ED	UNIT	R/W	D5152	45152	141F	A.BS_E2	R/W
D5103	45103	13EE	DP	R	D5153	45153	1420	A.FL_E2	R/W
D5104	45104	13EF	RH	R/W	D5154	45154	1421	A.SR_E2	R/W
D5105	45105	13F0	RL	R/W	D5155	45155	1422	A.LC_E2	R/W
D5106	45106	13F1	SDP	R/W	D5156	45156	1423		
D5107	45107	13F2	SH	R/W	D5157	45157	1424	DI6.D_E2	R/W
D5108	45108	13F3	SL	R/W	D5158	45158	1425		
D5109	45109	13F4	BSL	R/W	D5159	45159	1426		
D5110	45110	13F5	RJC	R/W	D5160	45160	1427		
D5111	45111	13F6	ERJC	R/W	D5161	45161	1428		
D5112	45112	13F7	A.BS	R/W	D5162	45162	1429		
D5113	45113	13F8	A.FL	R/W	D5163	45163	142A		
D5114	45114	13F9	A.SR	R/W	D5164	45164	142B		
D5115	45115	13FA	A.LC	R/W	D5165	45165	142C		
D5116	45116	13FB			D5166	45166	142D		
D5117	45117	13FC			D5167	45167	142E		
D5118	45118	13FD			D5168	45168	142F		
D5119	45119	13FE			D5169	45169	1430		
D5120	45120	13FF			D5170	45170	1431		
D5121	45121	1400	IN_E1	R/W	D5171	45171	1432		
D5122	45122	1401	UNIT_E1	R/W	D5172	45172	1433		
D5123	45123	1402	DP_E1	R	D5173	45173	1434		
D5124	45124	1403	RH_E1	R/W	D5174	45174	1435		
D5125	45125	1404	RL_E1	R/W	D5175	45175	1436		
D5126	45126	1405	SDP_E1	R/W	D5176	45176	1437		
D5127	45127	1406	SH_E1	R/W	D5177	45177	1438		
D5128	45128	1407	SL_E1	R/W	D5178	45178	1439		
D5129	45129	1408	BSL_E1	R/W	D5179	45179	143A		
D5130	45130	1409	RJC_E1	R/W	D5180	45180	143B		
D5131	45131	140A	ERJC_E1	R/W	D5181	45181	143C	IN_E4	R/W
D5132	45132	140B	RTD.S_E1	R/W	D5182	45182	143D	UNIT_E4	R/W
D5133	45133	140C	A.BS_E1	R/W	D5183	45183	143E	DP_E4	R
D5134	45134	140D	A.FL_E1	R/W	D5184	45184	143F	RH_E4	R/W
D5135	45135	140E	A.SR_E1	R/W	D5185	45185	1440	RL_E4	R/W
D5136	45136	140F	A.LC_E1	R/W	D5186	45186	1441	SDP_E4	R/W
D5137	45137	1410			D5187	45187	1442	SH_E4	R/W
D5138	45138	1411			D5188	45188	1443	SL_E4	R/W
D5139	45139	1412			D5189	45189	1444	BSL_E4	R/W
D5140	45140	1413			D5190	45190	1445		
D5141	45141	1414	IN_E2	R/W	D5191	45191	1446		
D5142	45142	1415	UNIT_E2	R/W	D5192	45192	1447	A.BS_E4	R/W
D5143	45143	1416	DP_E2	R	D5193	45193	1448	A.FL_E4	R/W
D5144	45144	1417	RH_E2	R/W	D5194	45194	1449	A.SR_E4	R/W
D5145	45145	1418	RL_E2	R/W	D5195	45195	144A	A.LC_E4	R/W
D5146	45146	1419	SDP_E2	R/W	D5196	45196	144B		
D5147	45147	141A	SH_E2	R/W	D5197	45197	144C	DI6.D_E4	R/W
D5148	45148	141B	SL_E2	R/W	D5198	45198	144D		
D5149	45149	141C	BSL_E2	R/W	D5199	45199	144E		
D5150	45150	141D			D5200	45200	144F		

Setup parameter									
Input setting (Input range·SP limiter/input switch/input auto-selector setting parameters menu: MPV)									
D-Reg No.	Ref. No.	H No.	Register symbol	R/W	D-Reg No.	Ref. No.	H No.	Register symbol	R/W
				UT75A					UT75A
D5201	45201	1450	P.UNI_L1	R/W	D5251	45251	1482		
D5202	45202	1451	P.DP_L1	R/W	D5252	45252	1483		
D5203	45203	1452	P.RH_L1	R/W	D5253	45253	1484		
D5204	45204	1453	P.RL_L1	R/W	D5254	45254	1485		
D5205	45205	1454	PV.HL	R/W	D5255	45255	1486		
D5206	45206	1455	PV.LL	R/W	D5256	45256	1487		
D5207	45207	1456	PV.2C	R/W	D5257	45257	1488		
D5208	45208	1457	PV.AS	R/W	D5258	45258	1489		
D5209	45209	1458	PV.NU	R/W	D5259	45259	148A		
D5210	45210	1459	SPH_L1	R/W	D5260	45260	148B		
D5211	45211	145A	SPL_L1	R/W	D5261	45261	148C		
D5212	45212	145B			D5262	45262	148D		
D5213	45213	145C			D5263	45263	148E		
D5214	45214	145D			D5264	45264	148F		
D5215	45215	145E			D5265	45265	1490		
D5216	45216	145F			D5266	45266	1491		
D5217	45217	1460			D5267	45267	1492		
D5218	45218	1461			D5268	45268	1493		
D5219	45219	1462			D5269	45269	1494		
D5220	45220	1463			D5270	45270	1495		
D5221	45221	1464	P.UNI_L2	R/W	D5271	45271	1496		
D5222	45222	1465	P.DP_L2	R/W	D5272	45272	1497		
D5223	45223	1466	P.RH_L2	R/W	D5273	45273	1498		
D5224	45224	1467	P.RL_L2	R/W	D5274	45274	1499		
D5225	45225	1468			D5275	45275	149A		
D5226	45226	1469			D5276	45276	149B		
D5227	45227	146A			D5277	45277	149C		
D5228	45228	146B			D5278	45278	149D		
D5229	45229	146C			D5279	45279	149E		
D5230	45230	146D	SPH_L2	R/W	D5280	45280	149F		
D5231	45231	146E	SPL_L2	R/W	D5281	45281	14A0		
D5232	45232	146F			D5282	45282	14A1		
D5233	45233	1470			D5283	45283	14A2		
D5234	45234	1471			D5284	45284	14A3		
D5235	45235	1472			D5285	45285	14A4		
D5236	45236	1473			D5286	45286	14A5		
D5237	45237	1474			D5287	45287	14A6		
D5238	45238	1475			D5288	45288	14A7		
D5239	45239	1476			D5289	45289	14A8		
D5240	45240	1477			D5290	45290	14A9		
D5241	45241	1478			D5291	45291	14AA		
D5242	45242	1479			D5292	45292	14AB		
D5243	45243	147A			D5293	45293	14AC		
D5244	45244	147B			D5294	45294	14AD		
D5245	45245	147C			D5295	45295	14AE		
D5246	45246	147D			D5296	45296	14AF		
D5247	45247	147E			D5297	45297	14B0		
D5248	45248	147F			D5298	45298	14B1		
D5249	45249	1480			D5299	45299	14B2		
D5250	45250	1481			D5300	45300	14B3		

14.4 UT75A D Registers

Setup parameter									
Output setting (Menu: OUT)									
D-Reg No.	Ref. No.	H No.	Register symbol	R/W	D-Reg No.	Ref. No.	H No.	Register symbol	R/W
				UT75A					UT75A
D5301	45301	14B4	OT.H	R/W	D5351	45351	14E6	MAN.T	R/W
D5302	45302	14B5	OT.C	R/W	D5352	45352	14E7		
D5303	45303	14B6	CT	R/W	D5353	45353	14E8		
D5304	45304	14B7	CTc	R/W	D5354	45354	14E9		
D5305	45305	14B8			D5355	45355	14EA		
D5306	45306	14B9	OT.H_L2	R/W	D5356	45356	14EB		
D5307	45307	14BA	OT.C_L2	R/W	D5357	45357	14EC		
D5308	45308	14BB	CT_L2	R/W	D5358	45358	14ED		
D5309	45309	14BC	CTc_L2	R/W	D5359	45359	14EE		
D5310	45310	14BD			D5360	45360	14EF		
D5311	45311	14BE	V.AT	R/W	D5361	45361	14F0		
D5312	45312	14BF	V.RS	R/W	D5362	45362	14F1		
D5313	45313	14C0	V.L	R	D5363	45363	14F2		
D5314	45314	14C1	V.H	R	D5364	45364	14F3		
D5315	45315	14C2	TR.T	R/W	D5365	45365	14F4		
D5316	45316	14C3	V.MOD	R/W	D5366	45366	14F5		
D5317	45317	14C4			D5367	45367	14F6		
D5318	45318	14C5			D5368	45368	14F7		
D5319	45319	14C6			D5369	45369	14F8		
D5320	45320	14C7			D5370	45370	14F9		
D5321	45321	14C8	RTS	R/W	D5371	45371	14FA		
D5322	45322	14C9	RTH	R/W	D5372	45372	14FB		
D5323	45323	14CA	RTL	R/W	D5373	45373	14FC		
D5324	45324	14CB	O1RS	R/W	D5374	45374	14FD		
D5325	45325	14CC	O1RH	R/W	D5375	45375	14FE		
D5326	45326	14CD	O1RL	R/W	D5376	45376	14FF		
D5327	45327	14CE	O2RS	R/W	D5377	45377	1500		
D5328	45328	14CF	O2RH	R/W	D5378	45378	1501		
D5329	45329	14D0	O2RL	R/W	D5379	45379	1502		
D5330	45330	14D1			D5380	45380	1503		
D5331	45331	14D2	OU.H	R/W	D5381	45381	1504		
D5332	45332	14D3	OU.L	R/W	D5382	45382	1505		
D5333	45333	14D4	OU2.H	R/W	D5383	45383	1506		
D5334	45334	14D5	OU2.L	R/W	D5384	45384	1507		
D5335	45335	14D6	RET.H	R/W	D5385	45385	1508		
D5336	45336	14D7	RET.L	R/W	D5386	45386	1509		
D5337	45337	14D8			D5387	45387	150A		
D5338	45338	14D9			D5388	45388	150B		
D5339	45339	14DA			D5389	45389	150C		
D5340	45340	14DB			D5390	45390	150D		
D5341	45341	14DC	OU.A	R/W	D5391	45391	150E		
D5342	45342	14DD	OU2.A	R/W	D5392	45392	150F		
D5343	45343	14DE	RET.A	R/W	D5393	45393	1510		
D5344	45344	14DF			D5394	45394	1511		
D5345	45345	14E0			D5395	45395	1512		
D5346	45346	14E1			D5396	45396	1513		
D5347	45347	14E2			D5397	45397	1514		
D5348	45348	14E3			D5398	45398	1515		
D5349	45349	14E4			D5399	45399	1516		
D5350	45350	14E5			D5400	45400	1517		

Free area (D5401 to D5500)

Setup parameter									
Communication setting (RS-485 communication setting menu: R485) (Ethernet communication setting menu: ETHR) (Error and version confirmation menu: VER) (CC-Link communication setting menu: CC-L) (DeviceNet communication setting menu: DNET)									
D-Reg No.	Ref. No.	H No.	Register symbol	R/W	D-Reg No.	Ref. No.	H No.	Register symbol	R/W
				UT75A					UT75A
D5501	45501	157C			D5551	45551	15AE	SM4_E3	R/W
D5502	45502	157D			D5552	45552	15AF	DG1_E3	R/W
D5503	45503	157E			D5553	45553	15B0	DG2_E3	R/W
D5504	45504	157F			D5554	45554	15B1	DG3_E3	R/W
D5505	45505	1580			D5555	45555	15B2	DG4_E3	R/W
D5506	45506	1581			D5556	45556	15B3	PRT_E3	R/W
D5507	45507	1582			D5557	45557	15B4	IPAR_E3	R/W
D5508	45508	1583			D5558	45558	15B5	1.IP1_E3	R/W
D5509	45509	1584			D5559	45559	15B6	1.IP2_E3	R/W
D5510	45510	1585			D5560	45560	15B7	1.IP3_E3	R/W
D5511	45511	1586			D5561	45561	15B8	1.IP4_E3	R/W
D5512	45512	1587			D5562	45562	15B9	2.IP1_E3	R/W
D5513	45513	1588			D5563	45563	15BA	2.IP2_E3	R/W
D5514	45514	1589			D5564	45564	15BB	2.IP3_E3	R/W
D5515	45515	158A			D5565	45565	15BC	2.IP4_E3	R/W
D5516	45516	158B			D5566	45566	15BD	ESW_E3	R/W
D5517	45517	158C			D5567	45567	15BE		
D5518	45518	158D			D5568	45568	15BF		
D5519	45519	158E			D5569	45569	15C0		
D5520	45520	158F			D5570	45570	15C1		
D5521	45521	1590	PSL_E3	R/W	D5571	45571	15C2	MAC1_E3	R
D5522	45522	1591	BPS_E3	R/W	D5572	45572	15C3	MAC2_E3	R
D5523	45523	1592	PRI_E3	R/W	D5573	45573	15C4	MAC3_E3	R
D5524	45524	1593	STP_E3	R/W	D5574	45574	15C5		
D5525	45525	1594	DLN_E3	R/W	D5575	45575	15C6		
D5526	45526	1595	ADR_E3	R/W	D5576	45576	15C7		
D5527	45527	1596	RP.T_E3	R/W	D5577	45577	15C8		
D5528	45528	1597			D5578	45578	15C9		
D5529	45529	1598			D5579	45579	15CA		
D5530	45530	1599			D5580	45580	15CB		
D5531	45531	159A	PSL_E4	R/W	D5581	45581	15CC	BR_E3-C *1	R/W
D5532	45532	159B	BPS_E4	R/W	D5582	45582	15CD	ADR_E3-C *1	R/W
D5533	45533	159C	PRI_E4	R/W	D5583	45583	15CE	BPS_E3-C *1	R/W
D5534	45534	159D	STP_E4	R/W	D5584	45584	15CF	FILE_E3-C *1	R/W
D5535	45535	159E	DLN_E4	R/W	D5585	45585	15D0	SCAN_E3-C *1	R/W
D5536	45536	159F	ADR_E4	R/W	D5586	45586	15D1		
D5537	45537	15A0	RP.T_E4	R/W	D5587	45587	15D2		
D5538	45538	15A1			D5588	45588	15D3		
D5539	45539	15A2			D5589	45589	15D4		
D5540	45540	15A3			D5590	45590	15D5		
D5541	45541	15A4	HSR_E3	R/W	D5591	45591	15D6	BR_E3-D *1	R/W
D5542	45542	15A5	BPS_E3	R/W	D5592	45592	15D7	ADR_E3-D *1	R/W
D5543	45543	15A6	PRI_E3	R/W	D5593	45593	15D8	BPS_E3-D *1	R/W
D5544	45544	15A7	IP1_E3	R/W	D5594	45594	15D9	FILE_E3-D *1	R/W
D5545	45545	15A8	IP2_E3	R/W	D5595	45595	15DA	SCAN_E3-D *1	R/W
D5546	45546	15A9	IP3_E3	R/W	D5596	45596	15DB		
D5547	45547	15AA	IP4_E3	R/W	D5597	45597	15DC		
D5548	45548	15AB	SM1_E3	R/W	D5598	45598	15DD		
D5549	45549	15AC	SM2_E3	R/W	D5599	45599	15DE		
D5550	45550	15AD	SM3_E3	R/W	D5600	45600	15DF		

*1: Same parameter exists in other menu. "-C" is added to the end of the parameter in CC-L menu (for CC-Link communication), and "-D" is added to the end of the parameter in DNET menu (for DeviceNet communication).

14.4 UT75A D Registers

Setup parameter									
Communication setting (PROFIBUS-DP communication setting menu: PROF)									
D-Reg No.	Ref. No.	H No.	Register symbol	R/W	D-Reg No.	Ref. No.	H No.	Register symbol	R/W
				UT75A					UT75A
D5601	45601	15E0	BR_E3-P *1	R/W	D5651	45651	1612		
D5602	45602	15E1	ADR_E3-P *1	R/W	D5652	45652	1613		
D5603	45603	15E2	BPS_E3-P *1	R/W	D5653	45653	1614		
D5604	45604	15E3	FILE_E3-P *1	R/W	D5654	45654	1615		
D5605	45605	15E4	SCAN_E3-P *1	R/W	D5655	45655	1616		
D5606	45606	15E5			D5656	45656	1617		
D5607	45607	15E6			D5657	45657	1618		
D5608	45608	15E7			D5658	45658	1619		
D5609	45609	15E8			D5659	45659	161A		
D5610	45610	15E9			D5660	45660	161B		
D5611	45611	15EA			D5661	45661	161C		
D5612	45612	15EB			D5662	45662	161D		
D5613	45613	15EC			D5663	45663	161E		
D5614	45614	15ED			D5664	45664	161F		
D5615	45615	15EE			D5665	45665	1620		
D5616	45616	15EF			D5666	45666	1621		
D5617	45617	15F0			D5667	45667	1622		
D5618	45618	15F1			D5668	45668	1623		
D5619	45619	15F2			D5669	45669	1624		
D5620	45620	15F3			D5670	45670	1625		
D5621	45621	15F4			D5671	45671	1626		
D5622	45622	15F5			D5672	45672	1627		
D5623	45623	15F6			D5673	45673	1628		
D5624	45624	15F7			D5674	45674	1629		
D5625	45625	15F8			D5675	45675	162A		
D5626	45626	15F9			D5676	45676	162B		
D5627	45627	15FA			D5677	45677	162C		
D5628	45628	15FB			D5678	45678	162D		
D5629	45629	15FC			D5679	45679	162E		
D5630	45630	15FD			D5680	45680	162F		
D5631	45631	15FE			D5681	45681	1630		
D5632	45632	15FF			D5682	45682	1631		
D5633	45633	1600			D5683	45683	1632		
D5634	45634	1601			D5684	45684	1633		
D5635	45635	1602			D5685	45685	1634		
D5636	45636	1603			D5686	45686	1635		
D5637	45637	1604			D5687	45687	1636		
D5638	45638	1605			D5688	45688	1637		
D5639	45639	1606			D5689	45689	1638		
D5640	45640	1607			D5690	45690	1639		
D5641	45641	1608			D5691	45691	163A		
D5642	45642	1609			D5692	45692	163B		
D5643	45643	160A			D5693	45693	163C		
D5644	45644	160B			D5694	45694	163D		
D5645	45645	160C			D5695	45695	163E		
D5646	45646	160D			D5696	45696	163F		
D5647	45647	160E			D5697	45697	1640		
D5648	45648	160F			D5698	45698	1641		
D5649	45649	1610			D5699	45699	1642		
D5650	45650	1611			D5700	45700	1643		

*1: Same parameter exists in other menu. "-P" is added to the end of the parameter in PROF menu (for PROFIBUS-DP communication).

Setup parameter									
Key operation setting (Menu: KEY), Display function setting (Menu: DISP), SELECT Display setting (Menu: CSEL)									
D-Reg No.	Ref. No.	H No.	Register symbol	R/W	D-Reg No.	Ref. No.	H No.	Register symbol	R/W
				UT75A					UT75A
D5701	45701	1644	F1-K *1	R/W	D5751	45751	1676	B.STS	R/W
D5702	45702	1645	F2-K *1	R/W	D5752	45752	1677	CTRS	R
D5703	45703	1646	Fn-K *1	R/W	D5753	45753	1678	D.CYC	R/W
D5704	45704	1647	A/M-K *1	R/W	D5754	45754	1679	OP.JP	R/W
D5705	45705	1648			D5755	45755	167A	MLSD	R/W
D5706	45706	1649			D5756	45756	167B	BOFT	R/W
D5707	45707	164A			D5757	45757	167C	SW.LP	R/W
D5708	45708	164B			D5758	45758	167D		
D5709	45709	164C			D5759	45759	167E		
D5710	45710	164D			D5760	45760	167F		
D5711	45711	164E	DVB_L1	R/W	D5761	45761	1680	CS1	R/W
D5712	45712	164F	DVB_L2	R/W	D5762	45762	1681	CS2	R/W
D5713	45713	1650	PCMD_L1	R/W	D5763	45763	1682	CS3	R/W
D5714	45714	1651	PCH_L1	R/W	D5764	45764	1683	CS4	R/W
D5715	45715	1652	PCL_L1	R/W	D5765	45765	1684	CS5	R/W
D5716	45716	1653	PCMD_L2	R/W	D5766	45766	1685		
D5717	45717	1654	PCH_L2	R/W	D5767	45767	1686		
D5718	45718	1655	PCL_L2	R/W	D5768	45768	1687		
D5719	45719	1656	BAR1	R/W	D5769	45769	1688		
D5720	45720	1657	BAR2	R/W	D5770	45770	1689	CS10	R/W
D5721	45721	1658	BDV_L1	R/W	D5771	45771	168A	CS11	R/W
D5722	45722	1659	BDV_L2	R/W	D5772	45772	168B	CS12	R/W
D5723	45723	165A	EV1_L1	R/W	D5773	45773	168C	CS13	R/W
D5724	45724	165B	EV2_L1	R/W	D5774	45774	168D	CS14	R/W
D5725	45725	165C	EV3_L1	R/W	D5775	45775	168E	CS15	R/W
D5726	45726	165D	EV4_L1	R/W	D5776	45776	168F	CS16	R/W
D5727	45727	165E	EV5_L1	R/W	D5777	45777	1690	CS17	R/W
D5728	45728	165F	EV6_L1	R/W	D5778	45778	1691	CS18	R/W
D5729	45729	1660	EV7_L1	R/W	D5779	45779	1692	CS19	R/W
D5730	45730	1661	EV8_L1	R/W	D5780	45780	1693		
D5731	45731	1662	EV1_L2	R/W	D5781	45781	1694		
D5732	45732	1663	EV2_L2	R/W	D5782	45782	1695		
D5733	45733	1664	EV3_L2	R/W	D5783	45783	1696		
D5734	45734	1665	EV4_L2	R/W	D5784	45784	1697		
D5735	45735	1666	EV5_L2	R/W	D5785	45785	1698		
D5736	45736	1667	EV6_L2	R/W	D5786	45786	1699		
D5737	45737	1668	EV7_L2	R/W	D5787	45787	169A		
D5738	45738	1669	EV8_L2	R/W	D5788	45788	169B		
D5739	45739	166A	PV.D	R/W	D5789	45789	169C		
D5740	45740	166B	SP.D	R/W	D5790	45790	169D		
D5741	45741	166C	STS.D	R/W	D5791	45791	169E		
D5742	45742	166D	SPD	R/W	D5792	45792	169F		
D5743	45743	166E	GUID	R/W	D5793	45793	16A0		
D5744	45744	166F	HOME	R/W	D5794	45794	16A1		
D5745	45745	1670	ECO	R/W	D5795	45795	16A2		
D5746	45746	1671	BRI	R/W	D5796	45796	16A3		
D5747	45747	1672	B.PVW	R/W	D5797	45797	16A4		
D5748	45748	1673	B.PVR	R/W	D5798	45798	16A5		
D5749	45749	1674	B.SP	R/W	D5799	45799	16A6		
D5750	45750	1675	B.BAR	R/W	D5800	45800	16A7		

*1: Same parameter exists in other menu. "-K" is added to the end of the parameter in KEY menu.

14.4 UT75A D Registers

Setup parameter									
Lock setting (Key lock setting menu: KLOC) (Menu lock setting menu: MLOC)									
D-Reg No.	Ref. No.	H No.	Register symbol	R/W	D-Reg No.	Ref. No.	H No.	Register symbol	R/W
				UT75A					UT75A
D5801	45801	16A8	U.SP_L1	R/W	D5851	45851	16DA	DI.SL-L *1	R/W
D5802	45802	16A9	U.SP_L2	R/W	D5852	45852	16DB	DI.NU-L *1	R/W
D5803	45803	16AA	U.OUT_L1	R/W	D5853	45853	16DC	DI.D-L *1	R/W
D5804	45804	16AB	U.OUT_L2	R/W	D5854	45854	16DD		
D5805	45805	16AC	U.HCO	R/W	D5855	45855	16DE		
D5806	45806	16AD	U.VP	R/W	D5856	45856	16DF	DI.D_E3-L *1	R/W
D5807	45807	16AE	U.MV	R/W	D5857	45857	16E0	DI.D_E4-L *1	R/W
D5808	45808	16AF			D5858	45858	16E1	ALM-L *1	R/W
D5809	45809	16B0	U.PID_L1	R/W	D5859	45859	16E2		
D5810	45810	16B1	U.PID_L2	R/W	D5860	45860	16E3	DO_E2-L *1	R/W
D5811	45811	16B2			D5861	45861	16E4		
D5812	45812	16B3	U.PV1	R/W	D5862	45862	16E5		
D5813	45813	16B4	U.PV2	R/W	D5863	45863	16E6	I/O-L *1	R/W
D5814	45814	16B5	U.PV	R/W	D5864	45864	16E7	SYS-L *1	R/W
D5815	45815	16B6	U.AP2	R/W	D5865	45865	16E8	INIT-L *1	R/W
D5816	45816	16B7	U.AI2	R/W	D5866	45866	16E9	VER-L *1	R/W
D5817	45817	16B8	U.AI4	R/W	D5867	45867	16EA	LVL-L *1	R/W
D5818	45818	16B9	COM.W	R/W	D5868	45868	16EB	MODE-L *1	R/W
D5819	45819	16BA	DATA-L *1	R/W	D5869	45869	16EC	CS-L *1	R/W
D5820	45820	16BB	A/M-L *1	R/W	D5870	45870	16ED	SP_L1-L *1	R/W
D5821	45821	16BC			D5871	45871	16EE	SPS_L1-L *1	R/W
D5822	45822	16BD			D5872	45872	16EF	ALRM_L1-L *1	R/W
D5823	45823	16BE			D5873	45873	16F0		
D5824	45824	16BF			D5874	45874	16F1	PVS_L1-L *1	R/W
D5825	45825	16C0			D5875	45875	16F2	PID_L1-L *1	R/W
D5826	45826	16C1			D5876	45876	16F3	TUNE_L1-L *1	R/W
D5827	45827	16C2			D5877	45877	16F4	ZONE_L1-L *1	R/W
D5828	45828	16C3			D5878	45878	16F5	SP_L2-L *1	R/W
D5829	45829	16C4	U.PVO	R/W	D5879	45879	16F6	SPS_L2-L *1	R/W
D5830	45830	16C5			D5880	45880	16F7	ALRM_L2-L *1	R/W
D5831	45831	16C6	CTL-L *1	R/W	D5881	45881	16F8	PVS_L2-L *1	R/W
D5832	45832	16C7	PV-L *1	R/W	D5882	45882	16F9	PID_L2-L *1	R/W
D5833	45833	16C8	PV2_E1-L *1	R/W	D5883	45883	16FA	TUNE_L2-L *1	R/W
D5834	45834	16C9	AIN2_E2-L *1	R/W	D5884	45884	16FB	ZONE_L2-L *1	R/W
D5835	45835	16CA	AIN4_E4-L *1	R/W	D5885	45885	16FC	PPAR-L *1	R/W
D5836	45836	16CB	MPV_L1-L *1	R/W	D5886	45886	16FD	PYS1-L *1	R/W
D5837	45837	16CC	MPV_L2-L *1	R/W	D5887	45887	16FE	PYS2-L *1	R/W
D5838	45838	16CD	OUT-L *1	R/W	D5888	45888	16FF	PYS3-L *1	R/W
D5839	45839	16CE			D5889	45889	1700	PYS4-L *1	R/W
D5840	45840	16CF			D5890	45890	1701		
D5841	45841	16D0	R485_E3-L *1	R/W	D5891	45891	1702		
D5842	45842	16D1	R485_E4-L *1	R/W	D5892	45892	1703		
D5843	45843	16D2	ETHR_E3-L *1	R/W	D5893	45893	1704		
D5844	45844	16D3	PROF_E3-L *1	R/W	D5894	45894	1705		
D5845	45845	16D4	DNET_E3-L *1	R/W	D5895	45895	1706		
D5846	45846	16D5	CC-L_E3-L *1	R/W	D5896	45896	1707		
D5847	45847	16D6	KEY-L *1	R/W	D5897	45897	1708		
D5848	45848	16D7	DISP-L *1	R/W	D5898	45898	1709		
D5849	45849	16D8	CSEL-L *1	R/W	D5899	45899	170A		
D5850	45850	16D9	KLOC-L *1	R/W	D5900	45900	170B		

*1: Same parameter exists in other menu. "-L" is added to the end of the parameter in KLOC menu or MLOC menu.

Setup parameter									
DI function setting (DI function registration menu: DI.SL) (DI function numbering menu: DI.NU)									
D-Reg No.	Ref. No.	H No.	Register symbol	R/W	D-Reg No.	Ref. No.	H No.	Register symbol	R/W
				UT75A					UT75A
D5901	45901	170C	A/M-D *1	R/W	D5951	45951	173E	PN.B3	R/W
D5902	45902	170D	R/L_L1-D *1	R/W	D5952	45952	173F	PN.B4	R/W
D5903	45903	170E	R/L_L2-D *1	R/W	D5953	45953	1740		
D5904	45904	170F	S/R-D *1	R/W	D5954	45954	1741		
D5905	45905	1710	CAS-D *1	R/W	D5955	45955	1742		
D5906	45906	1711	AUTO-D *1	R/W	D5956	45956	1743		
D5907	45907	1712	MAN-D *1	R/W	D5957	45957	1744		
D5908	45908	1713	REM_L1-D *1	R/W	D5958	45958	1745		
D5909	45909	1714	LCL_L1-D *1	R/W	D5959	45959	1746		
D5910	45910	1715	REM_L2-D *1	R/W	D5960	45960	1747	MP.BC_L1	R/W
D5911	45911	1716	LCL_L2-D *1	R/W	D5961	45961	1748	MP.B0_L1	R/W
D5912	45912	1717	ADV-D	R/W	D5962	45962	1749	MP.B1_L1	R/W
D5913	45913	1718	HOLD-D	R/W	D5963	45963	174A	MP.B2_L1	R/W
D5914	45914	1719	AT-D *1	R/W	D5964	45964	174B		
D5915	45915	171A	TRK-D *1	R/W	D5965	45965	174C	MP.BC_L2	R/W
D5916	45916	171B	SW-D *1	R/W	D5966	45966	174D	MP.B0_L2	R/W
D5917	45917	171C	PVHD-D *1	R/W	D5967	45967	174E	MP.B1_L2	R/W
D5918	45918	171D	CTOA-D *1	R/W	D5968	45968	174F	MP.B2_L2	R/W
D5919	45919	171E			D5969	45969	1750		
D5920	45920	171F	LAT-D *1	R/W	D5970	45970	1751		
D5921	45921	1720	LCD-D *1	R/W	D5971	45971	1752	PN.BC	R/W
D5922	45922	1721	MG1-D *1	R/W	D5972	45972	1753	PN.B0	R/W
D5923	45923	1722	MG2-D *1	R/W	D5973	45973	1754	PN.B1	R/W
D5924	45924	1723	MG3-D *1	R/W	D5974	45974	1755	PN.B2	R/W
D5925	45925	1724	MG4-D *1	R/W	D5975	45975	1756	PN.B3	R/W
D5926	45926	1725	P.RUN-D	R/W	D5976	45976	1757	PN.B4	R/W
D5927	45927	1726	P.STP-D *1	R/W	D5977	45977	1758		
D5928	45928	1727			D5978	45978	1759		
D5929	45929	1728			D5979	45979	175A		
D5930	45930	1729			D5980	45980	175B		
D5931	45931	172A			D5981	45981	175C	A/M_L2-D *1	R/W
D5932	45932	172B			D5982	45982	175D	S/R_L2-D *1	R/W
D5933	45933	172C			D5983	45983	175E	AUTO_L2-D *1	R/W
D5934	45934	172D			D5984	45984	175F	MAN_L2-D *1	R/W
D5935	45935	172E			D5985	45985	1760	AT_L2-D *1	R/W
D5936	45936	172F			D5986	45986	1761		
D5937	45937	1730	PVRW_L1-D *1	R/W	D5987	45987	1762		
D5938	45938	1731	PVRW_L2-D *1	R/W	D5988	45988	1763		
D5939	45939	1732			D5989	45989	1764		
D5940	45940	1733			D5990	45990	1765		
D5941	45941	1734	SP.BC	R/W	D5991	45991	1766	CS1-D *1	R/W
D5942	45942	1735	SP.B0	R/W	D5992	45992	1767	CS2-D *1	R/W
D5943	45943	1736	SP.B1	R/W	D5993	45993	1768	CS3-D *1	R/W
D5944	45944	1737	SP.B2	R/W	D5994	45994	1769	CS4-D *1	R/W
D5945	45945	1738	SP.B3	R/W	D5995	45995	176A	CS5-D *1	R/W
D5946	45946	1739	SP.B4	R/W	D5996	45996	176B	DP1-D *1	R/W
D5947	45947	173A	PN.BC	R/W	D5997	45997	176C	DP2-D *1	R/W
D5948	45948	173B	PN.B0	R/W	D5998	45998	176D		
D5949	45949	173C	PN.B1	R/W	D5999	45999	176E		
D5950	45950	173D	PN.B2	R/W	D6000	46000	176F		

*1: Same parameter exists in other menu. "-D" is added to the end of the parameter in DI.SL menu.

14.4 UT75A D Registers

Setup parameter									
DI function setting (Message)									
D-Reg No.	Ref. No.	H No.	Register symbol	R/W	D-Reg No.	Ref. No.	H No.	Register symbol	R/W
				UT75A					UT75A
D6001	46001	1770	MSG1	R/W	D6051	46051	17A2	MSG3	R/W
D6002	46002	1771	MSG1	R/W	D6052	46052	17A3		
D6003	46003	1772	MSG1	R/W	D6053	46053	17A4		
D6004	46004	1773	MSG1	R/W	D6054	46054	17A5		
D6005	46005	1774	MSG1	R/W	D6055	46055	17A6		
D6006	46006	1775	MSG1	R/W	D6056	46056	17A7		
D6007	46007	1776	MSG1	R/W	D6057	46057	17A8		
D6008	46008	1777	MSG1	R/W	D6058	46058	17A9		
D6009	46009	1778	MSG1	R/W	D6059	46059	17AA		
D6010	46010	1779	MSG1	R/W	D6060	46060	17AB		
D6011	46011	177A	MSG1	R/W	D6061	46061	17AC	MSG4	R/W
D6012	46012	177B			D6062	46062	17AD	MSG4	R/W
D6013	46013	177C			D6063	46063	17AE	MSG4	R/W
D6014	46014	177D			D6064	46064	17AF	MSG4	R/W
D6015	46015	177E			D6065	46065	17B0	MSG4	R/W
D6016	46016	177F			D6066	46066	17B1	MSG4	R/W
D6017	46017	1780			D6067	46067	17B2	MSG4	R/W
D6018	46018	1781			D6068	46068	17B3	MSG4	R/W
D6019	46019	1782			D6069	46069	17B4	MSG4	R/W
D6020	46020	1783			D6070	46070	17B5	MSG4	R/W
D6021	46021	1784	MSG2	R/W	D6071	46071	17B6	MSG4	R/W
D6022	46022	1785	MSG2	R/W	D6072	46072	17B7		
D6023	46023	1786	MSG2	R/W	D6073	46073	17B8		
D6024	46024	1787	MSG2	R/W	D6074	46074	17B9		
D6025	46025	1788	MSG2	R/W	D6075	46075	17BA		
D6026	46026	1789	MSG2	R/W	D6076	46076	17BB		
D6027	46027	178A	MSG2	R/W	D6077	46077	17BC		
D6028	46028	178B	MSG2	R/W	D6078	46078	17BD		
D6029	46029	178C	MSG2	R/W	D6079	46079	17BE		
D6030	46030	178D	MSG2	R/W	D6080	46080	17BF		
D6031	46031	178E	MSG2	R/W	D6081	46081	17C0		
D6032	46032	178F			D6082	46082	17C1		
D6033	46033	1790			D6083	46083	17C2		
D6034	46034	1791			D6084	46084	17C3		
D6035	46035	1792			D6085	46085	17C4		
D6036	46036	1793			D6086	46086	17C5		
D6037	46037	1794			D6087	46087	17C6		
D6038	46038	1795			D6088	46088	17C7		
D6039	46039	1796			D6089	46089	17C8		
D6040	46040	1797			D6090	46090	17C9		
D6041	46041	1798	MSG3	R/W	D6091	46091	17CA		
D6042	46042	1799	MSG3	R/W	D6092	46092	17CB		
D6043	46043	179A	MSG3	R/W	D6093	46093	17CC		
D6044	46044	179B	MSG3	R/W	D6094	46094	17CD		
D6045	46045	179C	MSG3	R/W	D6095	46095	17CE		
D6046	46046	179D	MSG3	R/W	D6096	46096	17CF		
D6047	46047	179E	MSG3	R/W	D6097	46097	17D0		
D6048	46048	179F	MSG3	R/W	D6098	46098	17D1		
D6049	46049	17A0	MSG3	R/W	D6099	46099	17D2		
D6050	46050	17A1	MSG3	R/W	D6100	46100	17D3		

Setup parameter									
DI function setting (DI1-DI3 contact type setting menu: DI.D) (DI setting menu (E3, E4): DI.D)									
D-Reg No.	Ref. No.	H No.	Register symbol	R/W	D-Reg No.	Ref. No.	H No.	Register symbol	R/W
				UT75A					UT75A
D6101	46101	17D4	DI1.D	R/W	D6151	46151	1806		
D6102	46102	17D5	DI2.D	R/W	D6152	46152	1807		
D6103	46103	17D6	DI3.D	R/W	D6153	46153	1808		
D6104	46104	17D7			D6154	46154	1809		
D6105	46105	17D8			D6155	46155	180A		
D6106	46106	17D9			D6156	46156	180B		
D6107	46107	17DA			D6157	46157	180C		
D6108	46108	17DB			D6158	46158	180D		
D6109	46109	17DC			D6159	46159	180E		
D6110	46110	17DD			D6160	46160	180F		
D6111	46111	17DE			D6161	46161	1810	DI1.D_E3	R/W
D6112	46112	17DF			D6162	46162	1811	DI2.D_E3	R/W
D6113	46113	17E0			D6163	46163	1812	DI3.D_E3	R/W
D6114	46114	17E1			D6164	46164	1813	DI4.D_E3	R/W
D6115	46115	17E2			D6165	46165	1814	DI5.D_E3	R/W
D6116	46116	17E3			D6166	46166	1815		
D6117	46117	17E4			D6167	46167	1816		
D6118	46118	17E5			D6168	46168	1817		
D6119	46119	17E6			D6169	46169	1818		
D6120	46120	17E7			D6170	46170	1819		
D6121	46121	17E8			D6171	46171	181A		
D6122	46122	17E9			D6172	46172	181B		
D6123	46123	17EA			D6173	46173	181C		
D6124	46124	17EB			D6174	46174	181D		
D6125	46125	17EC			D6175	46175	181E		
D6126	46126	17ED			D6176	46176	181F		
D6127	46127	17EE			D6177	46177	1820		
D6128	46128	17EF			D6178	46178	1821		
D6129	46129	17F0			D6179	46179	1822		
D6130	46130	17F1			D6180	46180	1823		
D6131	46131	17F2			D6181	46181	1824	DI1.D_E4	R/W
D6132	46132	17F3			D6182	46182	1825	DI2.D_E4	R/W
D6133	46133	17F4			D6183	46183	1826	DI3.D_E4	R/W
D6134	46134	17F5			D6184	46184	1827	DI4.D_E4	R/W
D6135	46135	17F6			D6185	46185	1828	DI5.D_E4	R/W
D6136	46136	17F7			D6186	46186	1829		
D6137	46137	17F8			D6187	46187	182A		
D6138	46138	17F9			D6188	46188	182B		
D6139	46139	17FA			D6189	46189	182C		
D6140	46140	17FB			D6190	46190	182D		
D6141	46141	17FC			D6191	46191	182E		
D6142	46142	17FD			D6192	46192	182F		
D6143	46143	17FE			D6193	46193	1830		
D6144	46144	17FF			D6194	46194	1831		
D6145	46145	1800			D6195	46195	1832		
D6146	46146	1801			D6196	46196	1833		
D6147	46147	1802			D6197	46197	1834		
D6148	46148	1803			D6198	46198	1835		
D6149	46149	1804			D6199	46199	1836		
D6150	46150	1805			D6200	46200	1837		

14.4 UT75A D Registers

Setup parameter									
DO function setting (AL1-AL3 function registration menu: ALM) (DO setting menu (E2): DO)									
D-Reg No.	Ref. No.	H No.	Register symbol	R/W	D-Reg No.	Ref. No.	H No.	Register symbol	R/W
				UT75A					UT75A
D6201	46201	1838	AL1.S	R/W	D6251	46251	186A		
D6202	46202	1839	AL2.S	R/W	D6252	46252	186B		
D6203	46203	183A	AL3.S	R/W	D6253	46253	186C		
D6204	46204	183B	OR.S	R/W	D6254	46254	186D		
D6205	46205	183C	OR2.S	R/W	D6255	46255	186E		
D6206	46206	183D	AL1.D	R/W	D6256	46256	186F		
D6207	46207	183E	AL2.D	R/W	D6257	46257	1870		
D6208	46208	183F	AL3.D	R/W	D6258	46258	1871		
D6209	46209	1840	OR.D	R/W	D6259	46259	1872		
D6210	46210	1841	OR2.D	R/W	D6260	46260	1873		
D6211	46211	1842			D6261	46261	1874		
D6212	46212	1843			D6262	46262	1875		
D6213	46213	1844			D6263	46263	1876		
D6214	46214	1845			D6264	46264	1877		
D6215	46215	1846			D6265	46265	1878		
D6216	46216	1847			D6266	46266	1879		
D6217	46217	1848			D6267	46267	187A		
D6218	46218	1849			D6268	46268	187B		
D6219	46219	184A			D6269	46269	187C		
D6220	46220	184B			D6270	46270	187D		
D6221	46221	184C			D6271	46271	187E		
D6222	46222	184D			D6272	46272	187F		
D6223	46223	184E			D6273	46273	1880		
D6224	46224	184F			D6274	46274	1881		
D6225	46225	1850			D6275	46275	1882		
D6226	46226	1851			D6276	46276	1883		
D6227	46227	1852			D6277	46277	1884		
D6228	46228	1853			D6278	46278	1885		
D6229	46229	1854			D6279	46279	1886		
D6230	46230	1855			D6280	46280	1887		
D6231	46231	1856			D6281	46281	1888		
D6232	46232	1857			D6282	46282	1889		
D6233	46233	1858			D6283	46283	188A		
D6234	46234	1859			D6284	46284	188B		
D6235	46235	185A			D6285	46285	188C		
D6236	46236	185B			D6286	46286	188D		
D6237	46237	185C			D6287	46287	188E		
D6238	46238	185D			D6288	46288	188F		
D6239	46239	185E			D6289	46289	1890		
D6240	46240	185F			D6290	46290	1891		
D6241	46241	1860	DO1.S_E2	R/W	D6291	46291	1892		
D6242	46242	1861	DO2.S_E2	R/W	D6292	46292	1893		
D6243	46243	1862	DO3.S_E2	R/W	D6293	46293	1894		
D6244	46244	1863	DO4.S_E2	R/W	D6294	46294	1895		
D6245	46245	1864	DO5.S_E2	R/W	D6295	46295	1896		
D6246	46246	1865	DO1.D_E2	R/W	D6296	46296	1897		
D6247	46247	1866	DO2.D_E2	R/W	D6297	46297	1898		
D6248	46248	1867	DO3.D_E2	R/W	D6298	46298	1899		
D6249	46249	1868	DO4.D_E2	R/W	D6299	46299	189A		
D6250	46250	1869	DO5.D_E2	R/W	D6300	46300	189B		

Setup parameter									
I/O display (Menu: I/O)									
D-Reg No.	Ref. No.	H No.	Register symbol	R/W	D-Reg No.	Ref. No.	H No.	Register symbol	R/W
				UT75A					UT75A
D6301	46301	189C	KEY-IO *1	R	D6351	46351	18CE		
D6302	46302	189D			D6352	46352	18CF		
D6303	46303	189E			D6353	46353	18D0		
D6304	46304	189F			D6354	46354	18D1		
D6305	46305	18A0			D6355	46355	18D2		
D6306	46306	18A1			D6356	46356	18D3		
D6307	46307	18A2			D6357	46357	18D4		
D6308	46308	18A3			D6358	46358	18D5		
D6309	46309	18A4			D6359	46359	18D6		
D6310	46310	18A5			D6360	46360	18D7		
D6311	46311	18A6			D6361	46361	18D8		
D6312	46312	18A7			D6362	46362	18D9		
D6313	46313	18A8			D6363	46363	18DA		
D6314	46314	18A9			D6364	46364	18DB		
D6315	46315	18AA			D6365	46365	18DC		
D6316	46316	18AB			D6366	46366	18DD		
D6317	46317	18AC			D6367	46367	18DE		
D6318	46318	18AD			D6368	46368	18DF		
D6319	46319	18AE			D6369	46369	18E0		
D6320	46320	18AF			D6370	46370	18E1		
D6321	46321	18B0			D6371	46371	18E2		
D6322	46322	18B1			D6372	46372	18E3		
D6323	46323	18B2			D6373	46373	18E4		
D6324	46324	18B3			D6374	46374	18E5		
D6325	46325	18B4			D6375	46375	18E6		
D6326	46326	18B5			D6376	46376	18E7		
D6327	46327	18B6			D6377	46377	18E8		
D6328	46328	18B7			D6378	46378	18E9		
D6329	46329	18B8			D6379	46379	18EA		
D6330	46330	18B9			D6380	46380	18EB		
D6331	46331	18BA			D6381	46381	18EC		
D6332	46332	18BB			D6382	46382	18ED		
D6333	46333	18BC			D6383	46383	18EE		
D6334	46334	18BD			D6384	46384	18EF		
D6335	46335	18BE			D6385	46385	18F0		
D6336	46336	18BF			D6386	46386	18F1		
D6337	46337	18C0			D6387	46387	18F2		
D6338	46338	18C1			D6388	46388	18F3		
D6339	46339	18C2			D6389	46389	18F4		
D6340	46340	18C3			D6390	46390	18F5		
D6341	46341	18C4			D6391	46391	18F6		
D6342	46342	18C5			D6392	46392	18F7		
D6343	46343	18C6			D6393	46393	18F8		
D6344	46344	18C7			D6394	46394	18F9		
D6345	46345	18C8			D6395	46395	18FA		
D6346	46346	18C9			D6396	46396	18FB		
D6347	46347	18CA			D6397	46397	18FC		
D6348	46348	18CB			D6398	46398	18FD		
D6349	46349	18CC			D6399	46399	18FE		
D6350	46350	18CD			D6400	46400	18FF		

*1: Same parameter exists in other menu. "-IO" is added to the end of the parameter in I/O menu.

14.4 UT75A D Registers

Setup parameter									
System setting (Menu: SYS)									
D-Reg No.	Ref. No.	H No.	Register symbol	R/W	D-Reg No.	Ref. No.	H No.	Register symbol	R/W
				UT75A					UT75A
D6401	46401	1900	R.MD	R/W	D6451	46451	1932		
D6402	46402	1901	R.TM	R/W	D6452	46452	1933		
D6403	46403	1902			D6453	46453	1934		
D6404	46404	1903			D6454	46454	1935		
D6405	46405	1904			D6455	46455	1936		
D6406	46406	1905			D6456	46456	1937		
D6407	46407	1906			D6457	46457	1938		
D6408	46408	1907	EPO	R/W	D6458	46458	1939		
D6409	46409	1908	C.GRN	R/W	D6459	46459	193A		
D6410	46410	1909	FREQ	R/W	D6460	46460	193B		
D6411	46411	190A			D6461	46461	193C		
D6412	46412	190B			D6462	46462	193D		
D6413	46413	190C			D6463	46463	193E		
D6414	46414	190D			D6464	46464	193F		
D6415	46415	190E			D6465	46465	1940		
D6416	46416	190F			D6466	46466	1941		
D6417	46417	1910	QSM	R/W	D6467	46467	1942		
D6418	46418	1911	LANG	R/W	D6468	46468	1943		
D6419	46419	1912			D6469	46469	1944		
D6420	46420	1913			D6470	46470	1945		
D6421	46421	1914	U.DEF	R/W	D6471	46471	1946		
D6422	46422	1915			D6472	46472	1947		
D6423	46423	1916	F.DEF	R/W	D6473	46473	1948		
D6424	46424	1917			D6474	46474	1949		
D6425	46425	1918			D6475	46475	194A		
D6426	46426	1919			D6476	46476	194B		
D6427	46427	191A			D6477	46477	194C		
D6428	46428	191B			D6478	46478	194D		
D6429	46429	191C			D6479	46479	194E		
D6430	46430	191D			D6480	46480	194F		
D6431	46431	191E	LEVL	R/W	D6481	46481	1950		
D6432	46432	191F			D6482	46482	1951		
D6433	46433	1920			D6483	46483	1952		
D6434	46434	1921			D6484	46484	1953		
D6435	46435	1922			D6485	46485	1954		
D6436	46436	1923			D6486	46486	1955		
D6437	46437	1924			D6487	46487	1956		
D6438	46438	1925			D6488	46488	1957		
D6439	46439	1926			D6489	46489	1958		
D6440	46440	1927			D6490	46490	1959		
D6441	46441	1928			D6491	46491	195A		
D6442	46442	1929			D6492	46492	195B		
D6443	46443	192A			D6493	46493	195C		
D6444	46444	192B			D6494	46494	195D		
D6445	46445	192C			D6495	46495	195E		
D6446	46446	192D			D6496	46496	195F		
D6447	46447	192E			D6497	46497	1960		
D6448	46448	192F			D6498	46498	1961		
D6449	46449	1930			D6499	46499	1962		
D6450	46450	1931			D6500	46500	1963		

D6501 to D6600: Free area

Custom display registers									
Custom display									
D-Reg No.	Ref. No.	H No.	Register symbol	R/W	D-Reg No.	Ref. No.	H No.	Register symbol	R/W
				UT75A					UT75A
D6601	46601	1964	USE_CD1	R	D6651	46651	1996	PVST_CD2	R/W
D6602	46602	1965	USE_CD2	R	D6652	46652	1997	PVST_CD2	R/W
D6603	46603	1966	USE_CD3	R	D6653	46653	1998	PVST_CD2	R/W
D6604	46604	1967			D6654	46654	1999	PVST_CD2	R/W
D6605	46605	1968			D6655	46655	199A	PVST_CD2	R/W
D6606	46606	1969			D6656	46656	199B	PVST_CD2	R/W
D6607	46607	196A			D6657	46657	199C		
D6608	46608	196B			D6658	46658	199D		
D6609	46609	196C			D6659	46659	199E		
D6610	46610	196D			D6660	46660	199F		
D6611	46611	196E	PVST_CD1	R/W	D6661	46661	19A0		
D6612	46612	196F	PVST_CD1	R/W	D6662	46662	19A1		
D6613	46613	1970	PVST_CD1	R/W	D6663	46663	19A2		
D6614	46614	1971	PVST_CD1	R/W	D6664	46664	19A3		
D6615	46615	1972	PVST_CD1	R/W	D6665	46665	19A4		
D6616	46616	1973	PVST_CD1	R/W	D6666	46666	19A5		
D6617	46617	1974	PVST_CD1	R/W	D6667	46667	19A6		
D6618	46618	1975	PVST_CD1	R/W	D6668	46668	19A7		
D6619	46619	1976	PVST_CD1	R/W	D6669	46669	19A8		
D6620	46620	1977	PVST_CD1	R/W	D6670	46670	19A9		
D6621	46621	1978	PVST_CD1	R/W	D6671	46671	19AA	PVST_CD3	R/W
D6622	46622	1979	PVST_CD1	R/W	D6672	46672	19AB	PVST_CD3	R/W
D6623	46623	197A	PVST_CD1	R/W	D6673	46673	19AC	PVST_CD3	R/W
D6624	46624	197B	PVST_CD1	R/W	D6674	46674	19AD	PVST_CD3	R/W
D6625	46625	197C	PVST_CD1	R/W	D6675	46675	19AE	PVST_CD3	R/W
D6626	46626	197D	PVST_CD1	R/W	D6676	46676	19AF	PVST_CD3	R/W
D6627	46627	197E			D6677	46677	19B0	PVST_CD3	R/W
D6628	46628	197F			D6678	46678	19B1	PVST_CD3	R/W
D6629	46629	1980			D6679	46679	19B2	PVST_CD3	R/W
D6630	46630	1981			D6680	46680	19B3	PVST_CD3	R/W
D6631	46631	1982			D6681	46681	19B4	PVST_CD3	R/W
D6632	46632	1983			D6682	46682	19B5	PVST_CD3	R/W
D6633	46633	1984			D6683	46683	19B6	PVST_CD3	R/W
D6634	46634	1985			D6684	46684	19B7	PVST_CD3	R/W
D6635	46635	1986			D6685	46685	19B8	PVST_CD3	R/W
D6636	46636	1987			D6686	46686	19B9	PVST_CD3	R/W
D6637	46637	1988			D6687	46687	19BA		
D6638	46638	1989			D6688	46688	19BB		
D6639	46639	198A			D6689	46689	19BC		
D6640	46640	198B			D6690	46690	19BD		
D6641	46641	198C	PVST_CD2	R/W	D6691	46691	19BE		
D6642	46642	198D	PVST_CD2	R/W	D6692	46692	19BF		
D6643	46643	198E	PVST_CD2	R/W	D6693	46693	19C0		
D6644	46644	198F	PVST_CD2	R/W	D6694	46694	19C1		
D6645	46645	1990	PVST_CD2	R/W	D6695	46695	19C2		
D6646	46646	1991	PVST_CD2	R/W	D6696	46696	19C3		
D6647	46647	1992	PVST_CD2	R/W	D6697	46697	19C4		
D6648	46648	1993	PVST_CD2	R/W	D6698	46698	19C5		
D6649	46649	1994	PVST_CD2	R/W	D6699	46699	19C6		
D6650	46650	1995	PVST_CD2	R/W	D6700	46700	19C7		

D6701 to D7000: Free area

14.4 UT75A D Registers

Control Function Setting (D5001 to D5100)

Register No.		Description	Range and meaning of value
D5001	CTLM	Control mode	1: SGL (Single-loop control) 2: CAS1 (Cascade primary-loop control) 3: CAS2 (Cascade secondary-loop control) 4: CAS (Cascade control) 5: BUM (Loop control for backup) 6: PVSU (Loop control with PV switching) 7: PVSEL (Loop control with PV auto-selector) 8: PVHD (Loop control with PV-hold function) 11: Dual-loop control * When using the ladder program, the control mode cannot be changed.
D5002			
D5003	CNT_L1	Loop-1 control type	0: PID (PID control) 1: ONOF (ON/OFF control (1 point of hysteresis)) 2: ONOF2 (ON/OFF control (2 points of hysteresis)) 3: 2P2L (Two-position two-level control) 4: H/C (Heating/cooling control) 5: S-PI (Sample PI control) 6: BATCH (Batch PID control) 7: FFPI (Feedforward control)
D5004	CNT_L2	Loop-2 control type	0: PID (PID control) 1: ONOF (ON/OFF control (1 point of hysteresis)) 2: ONOF2 (ON/OFF control (2 points of hysteresis)) 4: H/C (Heating/cooling control)
D5005	ALG_L1	Loop-1 PID control mode	0: Standard PID control mode 1: Fixed-point control mode
D5006	ALG_L2	Loop-2 PID control mode	Select "Fixed-point control mode" for pressure or flow rate control.
D5007	SPGR.	Number of SP groups	Set a number of SP groups to use. 1 to 20
D5008			
D5009	ALNO_L1	Loop-1 number of alarms	1 to 8
D5010	ALNO_L2	Loop-2 number of alarms	1 to 8
D5011			
D5012	ZON	Zone PID selection	If set to "SP group number selection," allows PID constants to be selected for each SP group. If set to "Zone PID selection," automatically selects PID constants according to the range set in the Reference point. 0: SP group number selection 1 1: Zone PID selection (selection by PV) 2: Zone PID selection (selection by target SP) 3: SP group number selection 2 4: Zone PID selection (selection by SP)
D5013			
D5014	PIDG.	Number of PID groups	Set a number of PID groups to use. 1 to 16
D5015 to D5018			
D5019	SMP	Input sampling period (control period)	0: 50 (50 ms) 1: 100 (100 ms) 2: 200 (200 ms)
D5020 to D5100			

Input Setting (D5101 to D5300)

Register No.		Description	Range and meaning of value
D5101	IN	PV input type	0: OFF (Disable) 1: K1 (-270.0 to 1370.0°C / -450.0 to 2500.0 F) 2: K2 (-270.0 to 1000.0°C / -450.0 to 2300.0 F) 3: K3 (-200.0 to 500.0°C / -200.0 to 1000.0 F) 4: J (-200.0 to 1200.0°C / -300.0 to 2300.0 F) 5: T1 (-270.0 to 400.0°C / -450.0 to 750.0 F) 6: T2 (0.0 to 400.0°C / -200.0 to 750.0 F) 7: B (0.0 to 1800.0°C / 32 to 3300 F) 8: S (0.0 to 1700.0°C / 32 to 3100 F) 9: R (0.0 to 1700.0°C / 32 to 3100 F) 10: N (-200.0 to 1300.0°C / -300.0 to 2400.0 F) 11: E (-270.0 to 1000.0°C / -450.0 to 1800.0 F) 12: L (-200.0 to 900.0°C / -300.0 to 1600.0 F) 13: U1 (-200.0 to 400.0°C / -300.0 to 750.0 F) 14: U2 (0.0 to 400.0°C / -200.0 to 1000.0 F) 15: W (0.0 to 2300.0°C / 32 to 4200 F) 16: PL2 (0.0 to 1390.0°C / 32.0 to 2500.0 F) 17: P2040 (0.0 to 1900.0°C / 32 to 3400 F) 18: WRE (0.0 to 2000.0°C / 32 to 3600 F) 30: JPT1 (-200.0 to 500.0°C / -300.0 to 1000.0 F) 31: JPT2 (-150.00 to 150.00°C / -200.0 to 300.0 F) 35: PT1 (-200.0 to 850.0°C / -300.0 to 1560.0 F) 36: PT2 (-200.0 to 500.0°C / -300.0 to 1000.0 F) 37: PT3 (-150.00 to 150.00°C / -200.0 to 300.0 F) 40: 0.4-2V (0.400 to 2.000 V) 41: 1-5V (1.000 to 5.000 V) 42: 4-20 (4.00 to 20.00 mA) 50: 0-2V (0.000 to 2.000 V) 51: 0-10V (0.00 to 10.00 V) 52: 0-20 (0.00 to 20.00 mA) 55: -1020 (-10.00 to 20.00 mV) 56: 0-100 (0.0 to 100.0 mV) *W: W-5% Re/W-26% Re(Hoskins Mfg. Co.), ASTM E988 WRE: W97Re3-W75Re25
D5102	UNIT	PV input unit	0, 2, 3, 4: - (No unit) 1: C (Degree Celsius) 5: F (Degree Fahrenheit)
D5103	DP	PV input decimal point position	0: No decimal place 1: One decimal place 2: Two decimal places 3: Three decimal places 4: Four decimal places
D5104	RH	Maximum value of PV input range	Depends on the input type. - For temperature input - Set the temperature range that is actually controlled. (RL<RH) - For voltage / current input - Set the range of a voltage / current signal that is applied. The scale across which the voltage / current signal is actually controlled should be set using the maximum value of input scale (SH) and minimum value of input scale (SL). (Input is always 0% when RL = RH.)
D5105	RL	Minimum value of PV input range	
D5106	SDP	PV input scale decimal point position	Same as D5103
D5107	SH	Maximum value of PV input scale	
D5108	SL	Minimum value of PV input scale	-19999 to 30000, (SL<SH), SH - SL ≤ 30000
D5109	BSL	PV input burnout action	0: OFF (Disable) 1: UP (Upscale) 2: DOWN (Downscale)
D5110	RJC	PV input reference junction compensation	0: OFF (RJC OFF) 1: ON (RJC ON)
D5111	ERJC	PV input external RJC setpoint	-10.0 to 60.0°C
D5112	A.BS	PV analog input bias	-100.0 to 100.0% of PV input range span (EUS)
D5113	A.FL	PV analog input filter	0: OFF 1 to 120 s
D5114	A.SR	PV analog input square root extraction	0: OFF (No square root extraction.) 1: Compute the square root. (The slope equals "1.") 2: Compute the square root. (The slope equals "0.")

14.4 UT75A D Registers

Register No.	Description		Range and meaning of value
D5115	A.LC	PV analog input low signal cutoff	0.0 to 5.0%
D5116 to D5120			
D5121	IN_E1	PV2 input type	40: 0.4-2V (0.400 to 2.000 V) 41: 1-5V (1.000 to 5.000 V) 50: 0-2V (0.000 to 2.000 V) 51: 0-10V (0.00 to 10.00 V) 57: 0-125 (0.000 to 1.250 V)
D5122	UNIT_E1	PV2 input unit	Same as D5102
D5123	DP_E1	PV2 input decimal point position	Same as D5103
D5124	RH_E1	Maximum value of PV2 input range	Depends on the input type. - For temperature input - Set the temperature range that is actually controlled. (RL<RH) - For voltage / current input - Set the range of a voltage / current signal that is applied.
D5125	RL_E1	Minimum value of PV2 input range	The scale across which the voltage / current signal is actually controlled should be set using the maximum value of input scale (SH) and minimum value of input scale (SL). (Input is always 0% when RL = RH.)
D5126	SDP_E1	PV2 input scale decimal point position	Same as D5103
D5127	SH_E1	Maximum value of PV2 input scale	Same as D5107, D5108
D5128	SL_E1	Minimum value of PV2 input scale	
D5129	BSL_E1	PV2 input burnout action	Same as D5109
D5130	RJC_E1	PV2 input reference junction compensation	Same as D5110
D5131	ERJC_E1	PV2 input external RJC setpoint	-10.0 to 60.0°X
D5132	RTD.S_E1	RTD wiring system	0: 3-W (3-wire system) 1: 4-W (4-wire system) (The LL50A Parameter Setting Software is required to use PV2 terminals input as PV.)
D5133	A.BS_E1	PV2 analog input bias	-100.0 to 100.0% of PV2 input range span (EUS)
D5134	A.FL_E1	PV2 analog input filter	Same as D 5113
D5135	A.SR_E1	PV2 analog input square root extraction	Same as D5114
D5136	A.LC_E1	PV2 analog input low signal cutoff	Same as D5115
D5137 to D5140			
D5141	IN_E2	AIN2 aux. analog input type	Same as D5121
D5142	UNIT_E2	AIN2 aux. analog input unit	Same as D5102
D5143	DP_E2	AIN2 aux. analog input decimal point position	Same as D5103
D5144	RH_E2	Maximum value of AIN2 aux. analog input range	Depends on the input type. Set the range of a voltage signal that is applied.
D5145	RL_E2	Minimum value of AIN2 aux. analog input range	The scale across which the voltage signal is actually controlled should be set using the maximum value of input scale (SH) and minimum value of input scale (SL). (Input is always 0% when RL = RH.)
D5146	SDP_E2	AIN2 aux. analog input scale decimal point position	Same as D5103
D5147	SH_E2	Maximum value of AIN2 aux. analog input scale	Same as D5107, D5108
D5148	SL_E2	Minimum value of AIN2 aux. analog input scale	
D5149	BSL_E2	AIN2 aux. analog input burnout action	Same as D5109
D5150 to D5151			
D5152	A.BS_E2	AIN2 aux. analog input bias	-100.0 to 100.0% of AIN2 input range span (EUS)
D5153	A.FL_E2	AIN2 aux. analog input filter	Same as D5113
D5154	A.SR_E2	AIN2 aux. analog input square root extraction	Same as D5114
D5155	A.LC_E2	AIN2 aux. analog input low signal cutoff	Same as D5115
D5156			
D5157	DI6.D_E2	DI26 contact type	Same as D5137
D5158 to D5180			

Register No.	Description		Range and meaning of value
D5181	IN_E4	AIN4 remote (aux. analog) input type	Same as D5121
D5182	UNIT_E4	AIN4 remote (aux. analog) input unit	Same as D5102
D5183	DP_E4	Maximum value of AIN4 remote (aux. analog) input position	Same as D5103
D5184	RH_E4	Maximum value of AIN4 remote (aux. analog) input range	Same as D5144, D5145
D5185	RL_E4	Minimum value of AIN4 remote (aux. analog) input range	
D5186	SDP_E4	AIN4 remote (aux. analog) input scale decimal point position	Same as D5103
D5187	SH_E4	Maximum value of AIN4 remote (aux. analog) input scale	Same as D5107, D5108
D5188	SL_E4	Minimum value of AIN4 remote (aux. analog) input scale	
D5189	BSL_E4	AIN4 remote (aux. analog) input burnout action	Same as D5109
D5190 to D5191			
D5192	A.BS_E4	AIN4 remote (aux. analog) input bias	-100.0 to 100.0% of AIN4 input range span (EUS)
D5193	A.FL_E4	AIN4 remote (aux. analog) input filter	Same as D5113
D5194	A.SR_E4	AIN4 remote (aux. analog) input square root extraction	Same as D5114
D5195	A.LC_E4	AIN4 remote (aux. analog) input low signal cutoff	Same as D5115
D5196			
D5197	DI6.D_E4	DI46 contact type	Same as D5137
D5198 to D5200			
D5201	P.UNI_L1	Loop-1 control PV input unit	0, 2, 3, 4: - (No unit) 1: C (Degree Celsius), 5: F (Degree Fahrenheit)
D5202	P.DP_L1	Loop-1 control PV input decimal point position	0: No decimal place, 1: One decimal place, 2: Two decimal places, 3: Three decimal places 4: Four decimal places
D5203	P.RH_L1	Loop-1 maximum value of control PV input range	-19999 to 30000, (P.RL<P.RH), P.RH - P.RL ≤ 30000
D5204	P.RL_L1	Loop-1 minimum value of control PV input range	
D5205	PV.HL	Input switching PV high limit (in Loop control with PV switching)	0.0 to 100.0% of control PV input range (EU), (PV.HL>PV.LL)
D5206	PV.LL	Input switching PV low limit (in Loop control with PV switching)	
D5207	PV.2C	Input switching action (in Loop control with PV switching)	0: Switch based on low limit of temperature range 1: Switch using the parameter PV.HL 2: Switch using DI 3: Switch based on high limit of temperature range
D5208	PV.AS	Input computation selection (in Loop control with PV auto-selector)	0: Max. value, 1: Min. value, 2: Ave. value, 3: Input 1 - Input 2, 4: Input 2 - Input 1
D5209	PV.NU	Number of inputs (in Loop control with PV auto-selector)	2: Use Input 1 and Input 2, 3: Use Input 1, Input 2, and Input 3 4: Use 4 inputs
D5210	SPH_L1	Loop-1 SP high limit	0.0 to 100.0% of PV input range (EU), (SPL<SPH)
D5211	SPL_L1	Loop-1 SP low limit	
D5210 to D5220			
D5221	P.UNI_L2	Loop-2 control PV input unit (in Cascade control)	Same as D5201
D5222	P.DP_L2	Loop-2 control PV input decimal point position (in Cascade control)	Same as D5202
D5223	P.RH_L2	Loop-2 maximum value of Control PV input range (in Cascade control)	Same as D5203, D5204
D5224	P.RL_L2	Loop-2 minimum value of Control PV input range (in Cascade control)	
D5225 to D5229			
D5230	SPH_L2	Loop-2 SP high limit	Same as D5210, D5211
D5231	SPL_L2	loop-2 SP low limit	
D5225 to D5300			

14.4 UT75A D Registers

Output Setting (D5301 to D5400)

Register No.	Description		Range and meaning of value
D5301	OT.H	Heating-side control output selection	0: OFF 1: OUT terminals (voltage pulse) 2: OUT terminals (current) 3: OUT terminals (relay) 4: OUT2 terminals (voltage pulse)
D5302	OT.C	Cooling-side control output selection	5: OUT2 terminals (current) 6: OUT2 terminals (relay) 7: RET terminals (voltage pulse) 8: RET terminals (current) 9: AL3 terminals (relay) 10: AL2 terminals (relay) When the UTAdvanced parameter is set by key stroke, the heating-side control output selection, and cooling-side control output selection comprise one parameter.
D5303	CT	Control output cycle time Heating-side control output cycle time (in Heating/cooling control)	0.5 to 1000.0 s
D5304	CTc	Cooling-side control output cycle time	
D5305			
D5306	OT.H_L2	Loop-2 heating-side control output selection	0: OFF 1: OUT terminals (voltage pulse) 2: OUT terminals (current) 3: OUT terminals (relay) 4: OUT2 terminals (voltage pulse)
D5307	OT.C_L2	Loop-2 cooling-side control output selection	5: OUT2 terminals (current) 6: OUT2 terminals (relay) 7: RET terminals (voltage pulse) 8: RET terminals (current) 9: AL3 terminals (relay) 10: AL2 terminals (relay) When the UTAdvanced parameter is set by key stroke, the heating-side control output selection, and cooling-side control output selection comprise one parameter.
D5308	CT_L2	Loop-2 control output cycle time Heating-side control output cycle time (in Heating/cooling control)	0.5 to 1000.0 s
D5309	CTc_L2	Loop-2 cooling-side control output cycle time	
D5310			
D5311	V.AT	Automatic valve position adjustment	0: OFF (Stop automatic adjustment) 1: ON (Start automatic adjustment)
D5312	V.RS	Valve position setting reset	0: OFF 1: ON (Resets the valve adjustment settings and causes the indication "V.RS" to blink.)
D5313	V.L	Fully-closed valve position setting	Pressing the SET/ENTER key with valve position set to the fully-closed position by Down arrow key causes the adjusted value to be stored. When V.L adjustment is complete, V.L stops blinking.
D5314	V.H	Fully-opened valve position setting	Pressing the SET/ENTER key with valve position set to the fully-opened position by Up arrow key causes the adjusted value to be stored. When V.H adjustment is complete, V.H stops blinking.
D5315	TR.T	Valve traveling time	5 to 300 s
D5316	V.MOD	Valve adjusting mode	0: Valve position feedback type 1: Valve position feedback type (moves to the estimating type if a feedback input error or break occurs.) 2: Valve position estimating type
D5317 to D5320			

Register No.		Description	Range and meaning of value
D5321	RTS	Retransmission output type of RET	0: OFF (Disable) 1: PV1 (PV) 2: SP1 (SP) 3: OUT1 (OUT (Valve opening: 0 to 100 % in Position proportional control)) 4: LPS (15 V DC loop power supply) 5: PV2 (Loop-2 PV) 6: SP2 (Loop-2 SP) 7: OUT2 (Loop-2 OUT) 8: TSP1 (Target SP) 9: HOUT1 (Heating-side OUT) 10: COUT1 (Cooling-side OUT) 11: MV1 (Position proportional output (internal computed value)) 12: TSP2 (Loop-2 target SP) 13: HOUT2 (Loop-2 heating-side OUT) 14: COUT2 Loop-2 cooling-side OUT 15: MV2 (Loop-2 position proportional output (internal computed value)) 16: PV (PV terminals analog input) 17: A.PV2 (PV2 terminals analog input) 18: AIN2 (AIN2 terminals analog input) 19: ANI4 (AIN4 terminals analog input) Loop-2 setting values are unavailable in Single-loop control.
D5322	RTH	Maximum value of retransmission output scale of RET	When RTS=1 (PV1), 2 (SP1), 5 (PV2), 6 (SP2), 8 (TSP1), 12 (TSP2), 16 (PV), 17 (A.PV2), 18 (AIN2), 19 (AIN4), RTL+1 digit to 30000 Decimal point position: RTS=1 (PV1), 2 (SP1), or 8 (TSP1): decimal point position is same as that of PV input. RTS=5 (PV2), 6 (SP2), or 12 (TSP2): decimal point position is same as that of PV2 input. RTS=16 (PV): decimal point position is same as that of PV input scale. RTS=17 (A.PV2): decimal point position is same as that of PV2 input scale. RTS=18 (AIN2): decimal point position is same as that of AIN2 scale. RTS=19 (AIN4): decimal point position is same as that of AIN4 scale.
D5323	RTL	Minimum value of retransmission output scale of RET	When RTS=1 (PV1), 2 (SP1), 5 (PV2), 6 (SP2), 8 (TSP1), 12 (TSP2), 16 (PV), 17 (A.PV2), 18 (AIN2), or 19 (AIN4), -19999 to RTH-1 digit Decimal point position: RTS=1 (PV1), 2 (SP1), 8 (TSP1): decimal point position is same as that of AIN4 scale. RTS=5 (PV2), 6 (SP2), 12 (TSP2): decimal point position is same as that of PV2 input. RTS=16 (PV): decimal point position is same as that of PV input scale. RTS=17 (A.PV2): decimal point position is same as that of PV2 input scale. RTS=18 (AIN2): decimal point position is same as that of AIN2 scale. RTS=19 (AIN4): decimal point position is same as that of AIN4 scale.
D5324	O1RS	Retransmission output type of OUT current output	Same as D5321

14.4 UT75A D Registers

Register No.	Description		Range and meaning of value
D5325	O1RH	Maximum value of retransmission output scale of OUT current output	When O1RS=1 (PV1), 2 (SP1), 5 (PV2), 6 (SP2), 8 (TSP1), 12 (TSP2), 16 (PV), 17 (A.PV2), 18 (AIN2), or 19 (AIN4), O1RL+1digit to 30000 Decimal point position: O1RS=1 (PV1), 2 (SP1), 8 (TSP1): decimal point position is same as that of PV input. O1RS=5 (PV2), 6 (SP2), 12 (TSP2): decimal point position is same as that of PV2 input. O1RS=16 (PV): decimal point position is same as that of PV input scale. O1RS=17 (A.PV2): decimal point position is same as that of PV2 input scale. O1RS=18 (AIN2): decimal point position is same as that of AIN2 scale. O1RS=19 (AIN4): decimal point position is same as that of AIN4 scale.
D5326	O1RL	Minimum value of retransmission output scale of OUT current output	When O1RS=1 (PV1), 2 (SP1), 5 (PV2), 6 (SP2), 8 (TSP1), 12 (TSP2), 16 (PV), 17 (A.PV2), 18 (AIN2), 19 (AIN4), -19999 to O1RH-1digit O1RS=1 (PV1), 2 (SP1), 8 (TSP1): decimal point position is same as that of PV input. O1RS=5 (PV2), 6 (SP2), 12 (TSP2): decimal point position is same as that of PV2 input. O1RS=16 (PV): decimal point position is same as that of PV input scale. O1RS=17 (A.PV2): decimal point position is same as that of PV2 input scale. O1RS=18 (AIN2): decimal point position is same as that of AIN2 scale. O1RS=19 (AIN4): decimal point position is same as that of AIN4 scale.
D5327	O2RS	Retransmission output type of OUT2 current output	Aame as D5321
D5328	O2RH	Maximum value of retransmission output scale of OUT2 current output	When O2RS=1 (PV1), 2 (SP1), 5 (PV2), 6 (SP2), 8 (TSP1), 12 (TSP2), 16 (PV), 17 (A.PV2), 18 (AIN2), or 19 (AIN4), O2RL+1digit to 30000 Decimal point position: O2RS=1 (PV1), 2 (SP1), 8 (TSP1): decimal point position is same as that of PV input. O2RS=5 (PV2), 6 (SP2), 12 (TSP2): decimal point position is same as that of PV2 input. O2RS=16 (PV): decimal point position is same as that of PV input scale. O2RS=17 (A.PV2): decimal point position is same as that of PV2 input scale. O2RS=18 (AIN2): decimal point position is same as that of AIN2 scale. O2RS=19 (AIN4): decimal point position is same as that of AIN4 scale.
D5329	O2RL	Minimum value of retransmission output scale of OUT2 current output	When O2RS=1 (PV1), 2 (SP1), 5 (PV2), 6 (SP2), 8 (TSP1), 12 (TSP2), 16 (PV), 17 (A.PV2), 18 (AIN2), 19 (AIN4), -19999 to O2RH-1digit Decimal point position: O2RS=1 (PV1), 2 (SP1), 8 (TSP1): decimal point position is same as that of PV input. O2RS=5 (PV2), 6 (SP2), 12 (TSP2): decimal point position is same as that of PV2 input. O2RS=16 (PV): decimal point position is same as that of PV input scale. O2RS=17 (A.PV2): decimal point position is same as that of PV2 input scale. O2RS=18 (AIN2): decimal point position is same as that of AIN2 scale. O2RS=19 (AIN4): decimal point position is same as that of AIN4 scale.
D5330			

Register No.	Description		Range and meaning of value
D5331	OU.H	100% segmental point of OUT current output	-100.0 to 200.0%
D5332	OU.L	0% segmental point of OUT current output	
D5333	OU2.H	100% segmental point of OUT2 current output	
D5334	OU2.L	0% segmental point of OUT2 current output	
D5335	RET.H	100% segmental point of RET current output	
D5336	RET.L	0% segmental point of RET current output	
D5337 to D5340			
D5341	OU.A	OUT current output range	0: 4-20 (4 to 20 mA)
D5342	OU2.A	OUT2 current output range	1: 0-20 (0 to 20 mA) 2: 20-4 (20 to 4 mA)
D5343	RET.A	RET current output range	3: 20-0 (20 to 0 mA)
D5344 to D5400			

Free area (D5401 to D5500)

14.4 UT75A D Registers

Communication Setting (D5501 to D5700)

Register No.		Description	Range and meaning of value
D5501 to D5520			
D5521	PSL_E3	Protocol selection	0: PCL (PC link communication) 1: PCLSM (PC link communication (with checksum)) 2: LADR (Ladder communication) 3: CO-M (Coordinated master station) 4: CO-S (Coordinated slave station) 7: MBASC (Modbus (ASCII)) 8: MBRTU (Modbus (RTU)) 9: CO-M2 (Coordinated master station (Loop-2 mode)) 10: CO-S1 (Coordinated slave station (Loop-1 mode)) 11: CO-S2 (Coordinated slave station (Loop-2 mode)) 12: P-P (Peer-to-peer communication)
D5522	BPS_E3	Baud rate	0: 600 (600 bps) 1: 1200 (1200 bps) 2: 2400 (2400 bps) 3: 4800 (4800 bps) 4: 9600 (9600 bps) 5: 19200 (19.2k bps) 6: 38400 (38.4k bps) * The baud rate for RS-485 is up to 19.2 k bps in E4-terminal area.
D5523	PRI_E3	Parity	0: NONE (None) 1: EVEN (Even) 2: ODD (Odd)
D5524	STP_E3	Stop bit	1: 1 bit, 2: 2 bit
D5525	DLN_E3	Data length	7: 7 bit, 8: 8 bit
D5526	ADR_E3	Address	1 to 99
D5527	RP.T_E3	Minimum response time	0 to 10 (x10ms)
D5528 to D5530			
D5531	PSL_E4	Protocol selection	Same as D5521
D5532	BPS_E4	Baud rate	0: 600 (600 bps) 1: 1200 (1200 bps) 2: 2400 (2400 bps) 3: 4800 (4800 bps) 4: 9600 (9600 bps) 5: 19200 (19.2k bps)
D5533	PRI_E4	Parity	Same as D5523
D5534	STP_E4	Stop bit	1: 1 bit, 2: 2 bit
D5535	DLN_E4	Data length	7: 7 bit, 8: 8 bit
D5536	ADR_E4	Address	1 to 99
D5537	RP.T_E4	Minimum response time	0 to 10 (x10ms)
D5538 to D5540			

Register No.	Description		Range and meaning of value
D5541	HSR_E3	High-speed response mode	0: OFF, 1 to 8
D5542	BPS_E3	Baud rate	4: 9600 (9600 bps) 5: 19200 (19.2k bps) 6: 38400 (38.4k bps)
D5543	PRI_E3	Parity	0: NONE (None) 1: EVEN (Even) 2: ODD (Odd)
D5544	IP1_E3	IP address 1	0 to 255 Address : D5542.D5543.D5544.D5545
D5545	IP2_E3	IP address 2	
D5546	IP3_E3	IP address 3	
D5547	IP4_E3	IP address 4	
D5548	SM1_E3	Subnet mask 1	0 to 255 Address : D5546.D5547.D5548.D5549
D5549	SM2_E3	Subnet mask 2	
D5550	SM3_E3	Subnet mask 3	
D5551	SM4_E3	Subnet mask 4	
D5552	DG1_E3	Default gateway 1	0 to 255 Address : D5550.D5551.D5552.D5553
D5553	DG2_E3	Default gateway 2	
D5554	DG3_E3	Default gateway 3	
D5555	DG4_E3	Default gateway 4	
D5556	PRT_E3	Port number	502, 1024 to 65535
D5557	IPAR_E3	IP access restriction	0: OFF (Disable), 1: ON (Enable)
D5558	1.IP1_E3	Permitted IP address 1-1	0 to 255 Address : D5556.D5557.D5558.D5559
D5559	1.IP2_E3	Permitted IP address 1-2	
D5560	1.IP3_E3	Permitted IP address 1-3	
D5561	1.IP4_E3	Permitted IP address 1-4	
D5562	2.IP1_E3	Permitted IP address 2-1	0 to 255 Address : D5560.D5561.D5562.D5563
D5563	2.IP2_E3	Permitted IP address 2-2	
D5564	2.IP3_E3	Permitted IP address 2-3	
D5565	2.IP4_E3	Permitted IP address 2-4	
D5566	ESW_E3	Ethernet setting switch	0: OFF, 1: ON (Enable) Setting this parameter to "1: ON" enables the Ethernet communication parameter settings. * The parameter ESW automatically returns to "0: OFF" after "1: ON" is set.
D5567 to D5570			
D5571	MAC1_E3	MAC address 1 *1	0000 to FFFF (Hex) Arrangement: D5771, D5772, D5773
D5572	MAC2_E3	MAC address 2 *1	
D5573	MAC3_E3	MAC address 3 *1	
D5574 to D5580			
D5581	BR_E3-C *2	Baud rate (for CC-link communication)	0: 156K (156k bps) 1: 625K (625k bps) 2: 2.5M (2.5M bps) 3: 5M (5M bps) 4: 10M (10M bps)
D5582	ADR_E3-C *2	Address (for CC-link communication)	1 to 64
D5583	BPS_E3-C *2	Baud rate (for CC-link communication)	4: 9600 (9600 bps) 5: 19200 (19.2k bps) 6: 38400 (38.4k bps)
D5584	FILE_E3-C *2	Profile number (for CC-link communication)	0, 21 to 25
D5585	SCAN_E3-C *2	Automatic rescan time (for CC-link communication)	0: OFF 1: 1M (1 minute) 2: 10M (10 minutes) 3: 30M (30 minutes) 4: 60M (60 minutes)
D5586 to D5590			

*1: With regards to the information on D5571 to D5573, three D registers comprise one parameter data.

*2: Same parameter exists in other menu. "-C" is added to the end of the parameter in CC-L menu (for CC-Link communication).

14.4 UT75A D Registers

Register No.	Description		Range and meaning of value
D5591	BR_E3-D *1	Baud rate (for DeviceNet communication)	0: 125K (125k bps) 1: 250K (250k bps) 2: 500K (500k bps)
D5592	ADR_E3-D *1	Address (for DeviceNet communication)	0 to 63
D5593	BPS_E3-D *1	Baud rate (for DeviceNet communication)	Same as D5583
D5594	FILE_E3-D *1	Profile number (for DeviceNet communication)	Same as D5584
D5595	SCAN_E3-C *1	Automatic rescan time (for DeviceNet communication)	Same as D5585
D5596 to D5600			
D5601	BR_E3-P *1	Baud rate (for PROFIBUS-DP communication)	0: 9.6K (9.6k bps) 1: .2K (19.2k bps) 2: 93.75K (93.75k bps) 3: 187.5K (187.5k bps) 4: 0.5M (0.5M bps) 5: 1.5M (1.5M bps) 6: 3M (3M bps) 7: 6M (6M bps) 8: 12M (12M bps) 9: AUTO 10: 45.45K (45.45k bps)
D5602	ADR_E3-P *1	Address (for PROFIBUS-DP communication)	0 to 125
D5603	BPS_E3-P *1	Baud rate (for PROFIBUS-DP communication)	Same as D5583
D5604	FILE_E3-P *1	Profile number (for PROFIBUS-DP communication)	Same as D5584
D5605	SCAN_E3-P *1	Automatic rescan time (for PROFIBUS-DP communication)	Same as D5585
D5606 to D5700			

*1: Same parameter exists in other menu. "-D" is added to the end of the parameter in DNET menu (for DeviceNet communication), and "-P" is added to the end of the parameter in PROF menu (for PROFIBUS-DP communication).

Key Operation Setting, Display Function Setting, and SELECT Display Setting (D5701 to D5800)

Register No.		Description	Range and meaning of value
D5701	F1 *1	User function key-1 action setting	0: OFF (Disable) 1: A/M (AUTO/MAN switch) 2: C/A/M (CAS/AUTO/MAN switch) 3: R/L1 (REM/LCL switch) 4: R/L2 (Loop-2 REM/LCL switch) 5: S/R (STOP/RUN switch) 6: CAS (Switch to CAS) 7: AUTO (Switch to AUTO)
D5702	F2 *1	User function key-2 action setting	8: MAN (Switch to MAN) 9: REM1 (Switch to REM) 10: LCL1 (Switch to LCL) 11: REM2 (Switch to Loop-2 REM) 12: LCL2 (Switch to Loop-2 LCL) 13: STOP (Switch to STOP) 14: RUN (Switch to RUN) 17: AT (Auto-tuning)
D5703	Fn *1	User function key-n action setting	18: LTUP (LCD brightness UP) 19: LTDN (LCD brightness DOWN) 20: BRI (Adjust LCD brightness) 21: LCD (LCD backlight ON/OFF switch) 22: LAT (Latch release) 23: PID (PID tuning switch) 34: Start of hold-mode operation 35: Advance of segment 36: Home display switch 37: Loop-1/Loop-2 display switch 38: Displaying loop AUTO/MAN switch 39: Displaying loop REM/LCL switch 40: Displaying loop STOP/RUN switch 41: Switch to AUTO displaying loop 42: Switch to MAN displaying loop 43: Switch to REM displaying loop 44: Switch to LCL displaying loop 45: Switch to STOP displaying loop 46: Switch to RUN displaying loop 47: Displaying loop auto-tuning 48: PID tuning switch displaying loop 49: Start of program operation 50: Stop of program operation Loop-2 setting values are unavailable in Single-loop control.
D5704	A/M-K *1	A/M key action setting	0: OFF (Disable) 1: A/M (AUTO/MAN switch) 2: C/A/M (CAS/AUTO/MAN switch) 3: R/L1 (REM/LCL switch) 4: R/L2 (Loop-2 REM/LCL switch) 5: S/R (STOP/RUN switch) 6: CAS (Switch to CAS) 7: AUTO (Switch to AUTO) 8: MAN (Switch to MAN)
D5709 to D5710			
D5711	DVB_L1	Loop-1 deviation display band	Permits a change in the span of deviation shown on the front-panel deviation monitor. 0.0 to 100.0% of PV input range span (EUS)
D5712	DVB_L2	Loop-2 deviation display band	

*1: Same parameter exists in other menu. "-K" is added to the end of the parameter in KEY menu.

14.4 UT75A D Registers

Register No.		Description	Range and meaning of value
D5713	PCMD_L1	Loop-1 active color PV display switch	0: Fixed in white 1: Fixed in red 2: Link to alarm 1 (Alarm OFF: white, Alarm ON: red) 3: Link to alarm 1 (Alarm OFF: red, Alarm ON: white) 4: Link to alarm 1 or 2 (Alarm OFF: white, Alarm ON: red) 5: Link to alarm 1 or 2 (Alarm OFF: red, Alarm ON: white) 6: PV limit (Within range: white, Out of range: red) 7: PV limit (Within range: red, Out of range: white) 8: SP deviation (Within deviation: white, Out of deviation: red) 9: SP deviation (Within deviation: red, Out of deviation: white) 10: Link to DI (ON: red, OFF: white)
D5714	PCH_L1	Loop-1 PV color change high limit	Set a display value when in PV limit or SP deviation.
D5715	PCL_L1	Loop-1 PV color change low limit	-19999 to 30000 (Set a value within the input range.)
D5716	PCMD_L2	Loop-2 active color PV display switch	Decimal point position depends on the input type.
D5717	PCH_L2	Loop-2 PV color change high limit	Same as D5713
D5718	PCL_L2	Loop-2 PV color change low limit	Same as D5714
D5719	BAR1	Upper bar-graph display registration	0: Disable 1: OUT, Heating-side OUT, Internal value in Position proportional control 2: Cooling-side OUT 3: PV 4: SP 5: Deviation 6: Loop-2 OUT, Loop-2 heating-side OUT 7: Loop-2 cooling-side OUT 8: Loop-2 PV 9: Loop-2 SP 10: Loop-2 deviation 11 to 16: Disable 17: Feedback input (valve opening) 18: PV terminals analog input 19: PV2 terminals analog input 20: AIN2 terminals analog input 21: AIN4 terminals analog input 22: Display loop Heating-side OUT, Internal value in Position proportional control 23: Display loop Cooling-side OUT 24: Display loop PV 25: Display loop SP 26: Display loop Deviation
D5720	BAR2	Lower bar-graph display registration	
D5721	BDV_L1	Loop-1 bar-graph deviation display band	
D5722	BDV_L2	Loop-2 bar-graph deviation display band	0.0 to 100.0% of PV input range span (EUS)

Register No.	Description	Range and meaning of value
D5723	EV1_L1	Loop-1 EV1 display condition registration Setting range: 4001 to 6304 OFF: Disable 4321: Link to alarm 1 (Lit when the alarm occurs) 4322: Link to alarm 2 (Lit when the alarm occurs) 4323: Link to alarm 3 (Lit when the alarm occurs) 4325: Link to alarm 4 (Lit when the alarm occurs) 4326: Link to alarm 5 (Lit when the alarm occurs) 4327: Link to alarm 6 (Lit when the alarm occurs) 4329: Link to alarm 7 (Lit when the alarm occurs) 4330: Link to alarm 8 (Lit when the alarm occurs) 4337: Link to Loop-2 alarm 1 (Lit when the alarm occurs) 4338: Link to Loop-2 alarm 2 (Lit when the alarm occurs) 4339: Link to Loop-2 alarm 3 (Lit when the alarm occurs) 4341: Link to Loop-2 alarm 4 (Lit when the alarm occurs) 4342: Link to Loop-2 alarm 5 (Lit when the alarm occurs) 4343: Link to Loop-2 alarm 6 (Lit when the alarm occurs) 4345: Link to Loop-2 alarm 7 (Lit when the alarm occurs) 4346: Link to Loop-2 alarm 8 (Lit when the alarm occurs) 4529: Heater break alarm 1 (Lit when the alarm occurs) 4530: Heater break alarm 2 (Lit when the alarm occurs) 5025 to 5027: Link to DI1-DI3 (Lit when the contact is closed)** 5073 to 5077: Link to DI31-DI35 (E3-terminal area) (Lit when the contact is closed)** 5089 to 5094: Link to DI41-DI46 (E4-terminal area) (Lit when the contact is closed)** 5153 to 5155: Link to AL1-AL3 (Lit when the contact is closed)** 5185 to 5189: Link to DO21-DO25 (E2-terminal area) (Lit when the contact is closed)** **: Initial value. The contact action changes by the setting of each "contact type" parameter. For other functions, see the Chapter 15 Functions and Applications of I Relays (for UT75A).
D5724	EV2_L1	
D5725	EV3_L1	
D5726	EV4_L1	
D5727	EV5_L1	
D5728	EV6_L1	
D5729	EV7_L1	
D5730	EV8_L1	
D5731	EV1_L2	
D5732	EV2_L2	
D5733	EV3_L2	
D5734	EV4_L2	
D5735	EV5_L2	
D5736	EV6_L2	
D5737	EV7_L2	
D5738	EV8_L2	

14.4 UT75A D Registers

Register No.		Description	Range and meaning of value
D5739	PV.D	PV display area ON/OFF	0: OFF (Nondisplay) 1: ON (Display)
D5740	SP.D	Setpoint display area ON/OFF	
D5741	STS.D	Status display area ON/OFF	
D5742	SPD	Scroll speed	
D5743	GUID	Guide display ON/OFF	0: OFF (Nondisplay) 1: ON (Display)
D5744	HOME	Home Operation Display setting	0: SP1 (SP Display) 1: SP2 (Loop-2 SP Display) 2: OUT1 (OUT Display) 3: OUT2 (Loop-2 OUT Display) 4: HCO (Heating/cooling OUT Display) 5: VP (Valve Position Display) 6: MV (Position Proportional Computation Output Display) 8: PID1 (PID Number Display) 9: PID2 (Loop-2 PID Number Display) 12: PV1 (PV2/PV1 Display) 13: PV2 (PV1/PV2 Display) 14: PV (PV Analog Input Display) 15: A.PV2 (PV2 Analog Input Display) 16: AIN2 (AIN2 Analog Input Display) 17: AIN4 (AIN4 Analog Input Display) 18: CS1 (SELECT Display 1) 19: CS2 (SELECT Display 2) 20: CS3 (SELECT Display 3) 21: CS4 (SELECT Display 4) 22: CS5 (SELECT Display 5)
D5745	ECO	Economy mode	0: OFF (Disable) 1: Economy mode ON (All indications except PV display OFF) 2: Economy mode ON (All indications OFF) 3: Brightness 10 % (whole indication)
D5746	BRI	Brightness	(Dark) 1 to 5 (Bright)
D5747	B.PVW	White brightness adjustment of PV display	Adjusts the white brightness of PV display. (Dark) -4 to 4 (Bright)
D5748	B.PVR	Red brightness adjustment of PV display	Adjusts the red brightness of PV display. (Dark) -4 to 4 (Bright)
D5749	B.SP	Brightness adjustment of Setpoint display	Adjusts the brightness of SP display. (Dark) -4 to 4 (Bright)
D5750	B.BAR	Brightness adjustment of Bar-graph display	Adjusts the brightness of SP display. (Dark) -4 to 4 (Bright)
D5751	B.STS	Brightness adjustment of Status indicator	Adjusts the brightness of Status display. (Dark) -4 to 4 (Bright)
D5752			
D5753	D.CYC	Display update cycle	1: 100 ms 2: 200 ms 3: 500 ms 4: 1 s 5: 2 s
D5754	OP.JP	AUTORETURN TO OPERATION DISPLAY	Automatically returned to the Operation Display when there has been no keystroke operation for 5 minutes. 0: OFF (Not automatically returned) 1: ON (Automatically returned)
D5755	MLSD	Least significant digital mask of PV display	0: OFF (With least significant digit) 1: ON (Without least significant digit)
D5756	BOFT	Program display pattern selection	0: Disable 1 to 30 (minutes)
D5757	SW.LP	Loop 1/2 display switch	0: 1LP: Loop 1 1: 2LP: Loop 2

Register No.	Description	Range and meaning of value
D5757 to D5760		
D5761	CS1	Register the operation parameter (except the Operation Mode) that is frequently modified to display it in the Operation Display. (Register the register number of the parameter) 0: OFF 2301 to 10000
D5762	CS2	
D5763	CS3	
D5764	CS4	
D5765	CS5	
D5766 to D5770		
D5770	CS10	Register the parameter that is frequently modified in the Operation Parameter Setting Display. (Register the register number of the parameter) 0: OFF 2301 to 10000
D5771	CS11	
D5772	CS12	
D5773	CS13	
D5774	CS14	
D5775	CS15	
D5776	CS16	
D5777	CS17	
D5778	CS18	
D5779	CS19	
D5780 to D5800		

14.4 UT75A D Registers

Lock Setting (Key Lock/Menu Lock) (D5801 to D5900)

Register No.	Description		Range and meaning of value
D5801	U.SP_L1	Loop-1 SP Display lock	0: OFF (Display) 1: ON (Nondisplay)
D5802	U.SP_L2	Loop-2 SP Display lock	
D5803	U.OUT_L1	Loop-1 OUT Display lock	
D5804	U.OUT_L2	Loop-2 OUT Display lock	
D5805	U.HCO	Heating/cooling OUT Display lock	
D5806	U.VP	Valve Position Display lock	
D5807	U.MV	Position Proportional Computation Output Display lock	
D5808			
D5809	U.PID_L1	Loop-1 PID Number Display lock	
D5810	U.PID_L2	Loop-2 PID Number Display lock	
D5811			
D5812	U.PV1	PV2/PV1 Display lock	
D5813	U.PV2	PV1/PV2 Display lock	
D5814	U.PV	PV Analog Input Display lock	
D5815	U.AP2	PV2 Analog Input Display lock	
D5816	U.AI2	AIN2 Analog Input Display lock	
D5817	U.AI4	AIN4 Analog Input Display lock	
D5818	COM.W	Communication write enable/disable	0: OFF (Enable) 1: ON (Disable)
D5819	DATA-L *1	Front panel parameter data key lock	0: OFF (Unlock) 1: ON (Lock)
D5820	A/M-L *1	Front panel A/M key lock	0: OFF (Unlock) 1: ON (Lock)
D5821 to D5828			
D5829	U.PVO	PV1 display lock	0: OFF (Display) 1: ON (Nondisplay)
D5830			
D5831	CTL-L *1	[CTL] menu lock	
D5832	PV-L *1	[PV] menu lock	
D5833	PV2_E1-L *1	[PV2] menu lock (E1-terminal area)	
D5834	AIN2_E2-L *1	[AIN2] menu lock (E2-terminal area)	
D5835	AIN4_E4-L *1	[AIN4] menu lock (E4-terminal area)	
D5836	MPV_L1-L *1	Loop-1 [MPV] menu lock	
D5837	MPV_L2-L *1	Loop-2 [MPV] menu lock	
D5838	OUT-L *1	[OUT] menu lock	
D5839 to D5840			
D5841	R485_E3-L *1	[R485] menu lock (E3-terminal area)	
D5842	R485_E4-L *1	[R485] menu lock (E4-terminal area)	
D5843	ETHR_E3-L *1	[ETHR] menu lock (E3-terminal area)	
D5844	PROF_E3-L *1	[PROF] menu lock (E3-terminal area)	
D5845	DNET_E3-L *1	[DNET] menu lock (E3-terminal area)	
D5846	CC-L_E3-L *1	[CC-L] menu lock (E3-terminal area)	
D5847	KEY-L *1	[KEY] menu lock	
D5848	DISP-L *1	[DISP] menu lock	
D5849	CSEL-L *1	[CSEL] menu lock	
D5850	KLOC-L *1	[KLOC] menu lock	
D5851	DI.SL-L *1	[DI.SL] menu lock	
D5852	DI.NU-L *1	[DI.NU] menu lock	
D5853	DI.D-L *1	[DI.D] menu lock	

*1: Same parameter exists in other menu. "-L" is added to the end of the parameter in KLOC menu or MLOC menu.

Register No.	Description	Range and meaning of value
D5853 to D5855		
D5856	DI.D_E3-L *1	[DI.D] menu lock (E3-terminal area)
D5857	DI.D_E4-L *1	[DI.D] menu lock (E4-terminal area)
D5858	ALM-L *1	[ALM] menu lock
D5859		
D5860	DO_E2-L *1	[DO] menu lock (E2-terminal area)
D5861 to D5862		
D5863	I/O-L *1	[I/O] menu lock
D5864	SYS-L *1	[SYS] menu lock
D5865	INIT-L *1	[INIT] menu lock
D5866	VER-L *1	[VER] menu lock
D5867	LVL-L *1	[LVL] menu lock
D5868	MODE-L *1	[MODE] menu lock
D5869	CS-L *1	[CS] menu lock
D5870	SP_L1-L *1	Loop-1 [SP] menu lock
D5871	SPS_L1-L *1	Loop-1 [SPS] menu lock
D5872	ALRM_L1-L *1	Loop-1 [ALRM] menu lock
D5873	PROG-L	[PROG] menu lock
D5874	PVS_L1-L *1	Loop-1 [PVS] menu lock
D5875	PID_L1-L *1	Loop-1 [PID] menu lock
D5876	TUNE_L1-L *1	Loop-1 [TUNE] menu lock
D5877	ZONE_L1-L *1	Loop-1 [ZONE] menu lock
D5878	SP_L2-L *1	Loop-2 [SP] menu lock
D5879	SPS_L2-L *1	Loop-2 [SPS] menu lock
D5880	ALRM_L2-L *1	Loop-2 [ALRM] menu lock
D5881	PVS_L2-L *1	Loop-2 [PVS] menu lock
D5882	PID_L2-L *1	Loop-2 [PID] menu lock
D5883	TUNE_L2-L *1	Loop-2 [TUNE] menu lock
D5884	ZONE_L2-L *1	Loop-2 [ZONE] menu lock
D5885	PPAR-L *1	[PPAR] menu lock
D5886	PYS1-L *1	[PYS1] menu lock
D5887	PYS2-L *1	[PYS2] menu lock
D5888	PYS3-L *1	[PYS3] menu lock
D5889	PYS4-L *1	[PYS4] menu lock
D5890 to D5900		

0: OFF (Display)
1: ON (Nondisplay)

*1: Same parameter exists in other menu. "-L" is added to the end of the parameter in KLOC menu or MLOC menu.

14.4 UT75A D Registers

DI Function Setting (D5901 to D6200)

Register No.	Description		Range and meaning of value
D5901	A/M-D *1	AUTO/MAN switch	Set an I relay number of contact input. 0: OFF (Disable) Standard terminals DI1: 5025, DI2: 5026, DI3: 5027 E2 -terminal area DI26: 5062 * E3-terminal area DI31: 5073, DI32: 5074, DI33: 5075, DI34: 5076, DI35: 5077 E4-terminal area DI41: 5089, DI42: 5090, DI43: 5091, DI44: 5092, DI45: 5093, DI46: 5094
D5902	R/L_L1-D *1	REMOTE/LOCAL switch	
D5903	R/L_L2-D *1	REMOTE/LOCAL switch	
D5904	S/R-D *1	STOP/RUN switch	
D5905	CAS-D *1	Switch to CAS	
D5906	AUTO-D *1	Switch to AUTO	
D5907	MAN-D *1	Switch to MAN	
D5908	REM_L1-D *1	Switch to REMOTE	
D5909	LCL_L1-D *1	Switch to LOCAL	
D5910	REM_L2-D *1	Switch to REMOTE	
D5911	LCL_L2-D *1	Switch to LOCAL	
D5912	ADV-D *1	Advance of segment	
D5913	HOLD-D *1	Switch to HOLD (Start of hold-mode operation)	
D5914	AT-D *1	Auto-tuning START/STOP switch	
D5915	TRK-D *1	Output tracking switch	
D5916	SW-D *1	PV switch	
D5917	PVHD-D *1	PV hold	
D5918	CTOA-D *1	CAS to AUTO switch	
D5919			
D5920	LAT-D *1	Latch release	
D5921	LCD-D *1	LCD backlight ON/OFF switch	
D5922	MG1-D *1	Message display interruption 1	
D5923	MG2-D *1	Message display interruption 2	
D5924	MG3-D *1	Message display interruption 3	
D5925	MG4-D *1	Message display interruption 4	
D5926	P.RUN-D *1	Switch to PROG (Start of program operation)	
D5927	P.STP-D *1	Switch to RESET (Stop of program operation)	
D5928 to D5936			
D5937	PVRW_L1-D *1	Loop-1 PV red/white switch	
D5938	PVRW_L2-D *1	Loop-2 PV red/white switch	
D5939 to D5940			
D5941	SP.BC	Bit changing method of SP number	0: Status switch 1 (Operation by key keystrokes or via communication is enabled according to the conditions.) 1: Status switch 2 (Operation by key keystrokes or via communication is disabled.)
D5942	SP.B0	Bit-0 of SP number	Set an I relay number of contact input. 0: OFF (Disable)
D5943	SP.B1	Bit-1 of SP number	Standard terminals DI1: 5025, DI2: 5026, DI3: 5027 E2 -terminal area * DI26: 5062 *
D5944	SP.B2	Bit-2 of SP number	E3-terminal area DI31: 5073, DI32: 5074, DI33: 5075, DI34: 5076, DI35: 5077
D5945	SP.B3	Bit-3 of SP number	E4-terminal area DI41: 5089, DI42: 5090, DI43: 5091, DI44: 5092, DI45: 5093, DI46: 5094
D5946	SP.B4	Bit-4 of SP number	

*1: Same parameter exists in other menu. "-D" is added to the end of the parameter in DI.SL menu.

Register No.	Description		Range and meaning of value
D5947	PN.BC	Bit changing method of PID number	Same as D5941
D5948	PN.B0	Bit-0 of PID number	Same as D5942
D5949	PN.B1	Bit-1 of PID number	
D5950	PN.B2	Bit-2 of PID number	
D5951	PN.B3	Bit-3 of PID number	
D5952	PN.B4	Bit-4 of PID number	
D5953 to D5959			
D5960	MP.BC_L1	Bit changing method of manual preset output number	Same as D5941
D5961	MP.B0_L1	Bit-0 of manual preset output number	Same as D5942
D5962	MP.B1_L1	Bit-1 of manual preset output number	
D5963	MP.B2_L1	Bit-2 of manual preset output number	
D5964			
D5965	MP.BC_L2	Bit changing method of manual preset output number	Same as D5941
D5966	MP.B0_L2	Bit-0 of manual preset output number	Same as D5942
D5967	MP.B1_L2	Bit-1 of manual preset output number	
D5968	MP.B2_L2	Bit-2 of manual preset output number	
D5969 to D5970			
D5971	PN.BC_L2	Loop-2 Bit changing method of PID number	Same as D5941
D5972	PN.B0_L2	Loop-2 Bit-0 of PID number	Same as D5942
D5973	PN.B1_L2	Loop-2 Bit-1 of PID number	
D5974	PN.B2_L2	Loop-2 Bit-2 of PID number	
D5975	PN.B3_L2	Loop-2 Bit-3 of PID number	
D5976	PN.B4_L2	Loop-2 Bit-4 of PID number	
D5977 to D5980			
D5981	A/M_L2-D	Loop-2 AUTO/MAN switch	Same as D5942
D5982	S/R_L2-D	Loop-2 STOP/RUN switch	
D5983	AUTO_L2-D	Loop-2 Switch to AUTO	
D5984	MAN_L2-D	Loop-2 Switch to MAN	
D5985	AT_L2-D	Loop-2 Auto-tuning START/STOP switch	
D5986 to D5990			
D5991	CS1	Custom display interruption 1	Same as D5942
D5992	CS2	Custom display interruption 2	
D5993	CS3	Custom display interruption 3	
D5994	CS4	Custom display interruption 4	
D5995	CS5	Custom display interruption 5	
D5996	DP1	Operation display interruption 1	Same as D5942
D5997	DP2	Operation display interruption 2	
D5998 to D6000			
D6001	MSG1	Messege-1 *2	20-digit value of alphanumeric characters can be set. Arrangement: D6001, D6002, D6003, D6004, D6005, D6006, D6007, DD6008, D6009, D6010, D6011 Write "0x00" to the register after the character string.
D6002	MSG1		
D6003	MSG1		
D6004	MSG1		
D6005	MSG1		
D6006	MSG1		
D6007	MSG1		
D6008	MSG1		
D6009	MSG1		
D6010	MSG1		
D6011	MSG1		
D6012 to D6020			

*2: With regards to the information on D6001 to D6011, D6021 to D6031, D6041 to D6051, and D6061 to D6071, 11 D registers comprise one message.

14.4 UT75A D Registers

DO Function Setting (D6201 to D6300)

Register No.	Description	Range and meaning of value
D6021	MSG2	20-digit value of alphanumeric characters can be set. Arrangement: D6021, D6022, D6023, D6024, D6025, D6026, D6027, D6028, D6029, D6030, D6031 Write "0x00" to the register after the character string.
D6022	MSG2	
D6023	MSG2	
D6024	MSG2	
D6025	MSG2	
D6026	MSG2	
D6027	MSG2	
D6028	MSG2	
D6029	MSG2	
D6030	MSG2	
D6031	MSG2	
D6032 to D6040		
D6041	MSG3	20-digit value of alphanumeric characters can be set. Arrangement: D6041, D6042, D6043, D6044, D6045, D6046, D6047, D6048, D6049, D6050, D6051 Write "0x00" to the register after the character string.
D6042	MSG3	
D6043	MSG3	
D6044	MSG3	
D6045	MSG3	
D6046	MSG3	
D6047	MSG3	
D6048	MSG3	
D6049	MSG3	
D6050	MSG3	
D6051	MSG3	
D6052 to D6060		
D6061	MSG4	20-digit value of alphanumeric characters can be set. Arrangement: D6061, D6062, D6063, D6064, D6065, D6066, D6067, D6068, D6069, D6070, D6071 Write "0x00" to the register after the character string.
D6062	MSG4	
D6063	MSG4	
D6064	MSG4	
D6065	MSG4	
D6066	MSG4	
D6067	MSG4	
D6068	MSG4	
D6069	MSG4	
D6070	MSG4	
D6071	MSG4	
D6072 to D6100		
D6101	DI1.D	DI1 contact type
D6102	DI2.D	DI2 contact type
D6103	DI3.D	DI3 contact type
D6104 to D6160		
D6161	DI1.D_E3	DI31 contact type
D6162	DI2.D_E3	DI32 contact type
D6163	DI3.D_E3	DI33 contact type
D6164	DI4.D_E3	DI34 contact type
D6165	DI5.D_E3	DI35 contact type
D6166 to D6180		
D6181	DI1.D_E4	DI41 contact type
D6182	DI2.D_E4	DI42 contact type
D6183	DI3.D_E4	DI43 contact type
D6184	DI4.D_E4	DI44 contact type
D6185	DI5.D_E4	DI45 contact type
D6186 to D6200		

*2: With regards to the information on D6001 to D6011, D6021 to D6031, D6041 to D6051, and D6061 to D6071, 11 D registers comprise one message.

Register No.		Description	Range and meaning of value
D6201	AL1.S	AL1 function selection	Set an I relay number (Setting range: 4001 to 6000, UP55A: 4001 to 6304). Ex.) Set the number 4353 for AL1.S to use the alarm 1.
D6202	AL2.S	AL2 function selection	0: OFF (No function) Alarm 1: 4353 Alarm 2: 4354 Alarm 3: 4355 Alarm 4: 4357 Alarm 5: 4358 Alarm 6: 4359 Alarm 7: 4361 Alarm 8: 4362
D6203	AL3.S	AL3 function selection	0: OFF (No function) Alarm 1: 4353 Alarm 2: 4354 Alarm 3: 4355 Alarm 4: 4357 Alarm 5: 4358 Alarm 6: 4359 Alarm 7: 4361 Alarm 8: 4362
D6204	OR.S	OUT relay function selection	AUTO (ON) / MAN (OFF) status: 4193 REM (ON) / LCL (OFF) status: 4194 STOP (ON) / RUN (OFF) status: 4195
D6205	OR2.S	OUT2 relay function selection	Output tracking (ON) switching signal: 4201 For the items other than below, see the Chapter 15 Functions and Applications of I Relays (for UT75A).
D6206	AL1.D	AL1 contact type	0: When the event of assigned function occurs, the contact is closed.
D6207	AL2.D	AL2 contact type	1: When the event of assigned function occurs, the contact is opened.
D6208	AL3.D	AL3 contact type	
D6209	OR.D	OUT relay contact type	Same as D6206
D6210	OR2.D	OUT2 relay contact type	
D6211 to D6240			
D6241	DO1.S_E2	DO21 function selection	Same as D6201
D6242	DO2.S_E2	DO22 function selection	
D6243	DO3.S_E2	DO23 function selection	
D6244	DO4.S_E2	DO24 function selection	
D6245	DO5.S_E2	DO25 function selection	
D6246	DO1.D_E2	DO21 contact type	Same as D6206
D6247	DO2.D_E2	DO22 contact type	
D6248	DO3.D_E2	DO23 contact type	
D6249	DO4.D_E2	DO24 contact type	
D6250	DO5.D_E2	DO25 contact type	
D6251 to D6300			

14.4 UT75A D Registers

I/O Display (D6301 to D6400)

● Bit Configuration of D6301: KEY-IO*1 (Key status)

Bit	Symbol	Event
0	PARA_KEY	PARAMETER (PARA) key (0: OFF 1: ON)
1	DISP_KEY	DISPLAY (DISP) key (0: OFF 1: ON)
2	RIGHT_KEY	RIGHT key (0: OFF 1: ON)
3	DOWN_KEY	DOWN key (0: OFF 1: ON)
4	SET_KEY	SET/ENTER key (0: OFF 1: ON)
5	UP_KEY	UP key (0: OFF 1: ON)
6	LEFT_KEY	LEFT key (0: OFF 1: ON)
7	F2_KEY	F2 key (0: OFF 1: ON)
8	F1_KEY	F1 key (0: OFF 1: ON)
9	A/M_KEY	A/M key (0: OFF 1: ON)
10	FN_KEY	Fn key (0: OFF 1: ON)
11 to 15		

*1: Same parameter exists in other menu. "-IO" is added to the end of the parameter in I/O menu.

● D6302 to D6400

Register No.	Description	Range and meaning of value
D6302 to D6400	Free area	

System Setting (D6401 to D6500)

Register No.		Description	Range and meaning of value
D6401	R.MD	Restart mode	Set how the controller should recover from a power failure of 5 seconds or more. 0: CONT (Continue action set before power failure.) 1: MAN (Start from MAN.) 2: AUTO (Start from AUTO.) 3: CONT2: Continue action set before power failure. Preset output starts.
D6402	R.TM	Restart timer	Set time between power on and the instant where controller starts computation. 0 to 10 s
D6403 to D6407			
D6408	EPO	Input error preset output	Set preset output value when the input burnout or ADC error occurs. Manual output is prioritized when input burnout occurs in MAN. 0: Preset output 1: 0% output 2: 100% output
D6409	C.GRN	Response as GREEN Series	0: OFF (Works as UT75A in communication of device information response or broadcasting.) 1: ON (Works as GREEN Series in communication of device information response or broadcasting.)
D6410	FREQ	Power frequency	0: AUTO 1: 60 Hz 2: 50 Hz
D6411 to D6416			
D6417	QSM	Quick setting mode	0: OFF (Disable) 1: ON (Enable)
D6418	LANG	Guide display language	0: ENG (English) 1: FRA (French) 2: GER (German) 3: SPA (Spanish)
D6419 to D6420			
D6421	U.DEF	Initialization to user default value	12345: Initialization, automatically returned to "0" after initialization.
D6422			
D6423	F.DEF	Initialization to factory default value	-12345: Initialization, automatically returned to "0" after initialization. *
D6424 to D6430			
D6431	LEVL	Parameter display level	1: EASY (Easy setting mode) 2: STD (Standard setting mode) 3: PRO (Professional setting mode)
D6432 to D6500			

Free Area (D6501 to D7000)

14.4 UT75A D Registers

Custom Display Register (D6501 to D6686)

Register No.	Description	Range and meaning of value
D6501 to D6600	Free area	
D6601 to D6603	Custom display	USE_CD1, USE_CD2, USE_CD3 1: use
D6604 to D6610	Free area	
D6611 to D6626	Custom display-1 characters	PVST_CD1 30-digit value of alphanumeric characters can be set. Arrangement: D6611, D6612, D6613, D6614, ••• D6625, D6626 Write "0x00" to the register after the character string.
D6627 to D6640	Free area	
D6641 to D6656	Custom display-2 characters	PVST_CD2 30-digit value of alphanumeric characters can be set. Arrangement: D6641, D6642, D6643, D6644, ••• D6655, D6656 Write "0x00" to the register after the character string.
D6657 to D6670	Free area	
D6671 to D6686	Custom display-3 characters	PVST_CD3 30-digit value of alphanumeric characters can be set. Arrangement: D6671, D6672, D6673, D6674, ••• D6685, D6686 Write "0x00" to the register after the character string.

● D6687 to D7000

Register No.	Description	Range and meaning of value
D6687 to D7000	Free area	

14.4.8 Registers for Ladder Program (D7001 to D7600)

Registers for ladder program									
For input ladder calculation									
D-Reg No.	Ref. No.	H No.	Register symbol	R/W	D-Reg No.	Ref. No.	H No.	Register symbol	R/W
				UT75A					UT75A
D7001	47001	1B58	X_PV	R	D7051	47051	1B8A	PVIN_CTL	R *
D7002	47002	1B59	X_PV2	R	D7052	47052	1B8B	PVIN1_CTL	R *
D7003	47003	1B5A	X_AIN2	R	D7053	47053	1B8C	PVIN2_CTL	R *
D7004	47004	1B5B			D7054	47054	1B8D	PVIN3_CTL	R *
D7005	47005	1B5C	X_AIN4	R	D7055	47055	1B8E	PVIN4_CTL	R *
D7006	47006	1B5D			D7056	47056	1B8F	RSP_CTL	R *
D7007	47007	1B5E			D7057	47057	1B90	TRK_CTL	R *
D7008	47008	1B5F			D7058	47058	1B91	FF_CTL	R *
D7009	47009	1B60			D7059	47059	1B92		
D7010	47010	1B61			D7060	47060	1B93		
D7011	47011	1B62	X000	R	D7061	47061	1B94	PV2IN_CTL	R *
D7012	47012	1B63			D7062	47062	1B95		
D7013	47013	1B64			D7063	47063	1B96		
D7014	47014	1B65	X300_E3	R	D7064	47064	1B97		
D7015	47015	1B66	X400_E4	R	D7065	47065	1B98		
D7016	47016	1B67			D7066	47066	1B99	RSP2_CTL	R *
D7017	47017	1B68			D7067	47067	1B9A	TRK2_CTL	R *
D7018	47018	1B69			D7068	47068	1B9B		
D7019	47019	1B6A			D7069	47069	1B9C		
D7020	47020	1B6B			D7070	47070	1B9D		
D7021	47021	1B6C			D7071	47071	1B9E		
D7022	47022	1B6D			D7072	47072	1B9F		
D7023	47023	1B6E			D7073	47073	1BA0		
D7024	47024	1B6F			D7074	47074	1BA1		
D7025	47025	1B70			D7075	47075	1BA2		
D7026	47026	1B71			D7076	47076	1BA3		
D7027	47027	1B72			D7077	47077	1BA4		
D7028	47028	1B73			D7078	47078	1BA5		
D7029	47029	1B74			D7079	47079	1BA6		
D7030	47030	1B75			D7080	47080	1BA7		
D7031	47031	1B76			D7081	47081	1BA8		
D7032	47032	1B77			D7082	47082	1BA9		
D7033	47033	1B78			D7083	47083	1BAA		
D7034	47034	1B79			D7084	47084	1BAB		
D7035	47035	1B7A			D7085	47085	1BAC		
D7036	47036	1B7B			D7086	47086	1BAD		
D7037	47037	1B7C			D7087	47087	1BAE		
D7038	47038	1B7D			D7088	47088	1BAF		
D7039	47039	1B7E			D7089	47089	1BB0		
D7040	47040	1B7F			D7090	47090	1BB1		
D7041	47041	1B80			D7091	47091	1BB2		
D7042	47042	1B81			D7092	47092	1BB3		
D7043	47043	1B82			D7093	47093	1BB4		
D7044	47044	1B83			D7094	47094	1BB5		
D7045	47045	1B84			D7095	47095	1BB6		
D7046	47046	1B85			D7096	47096	1BB7		
D7047	47047	1B86			D7097	47097	1BB8		
D7048	47048	1B87			D7098	47098	1BB9		
D7049	47049	1B88			D7099	47099	1BBA		
D7050	47050	1B89			D7100	47100	1BBB		

*: R/W when the LL50A Parameter Setting Software is used.

14.4 UT75A D Registers

Registers for ladder program									
For output ladder calculation									
D-Reg No.	Ref. No.	H No.	Register symbol	R/W	D-Reg No.	Ref. No.	H No.	Register symbol	R/W
				UT75A					UT75A
D7101	47101	1BBC	OUT_CTL	R	D7151	47151	1BEE	Y_OUT	R *
D7102	47102	1BBD	OUT2_CTL	R	D7152	47152	1BEF	Y_OUT2	R *
D7103	47103	1BBE	RET_CTL	R	D7153	47153	1BF0	Y_RET	R *
D7104	47104	1BBF	OUT2R_CTL	R	D7154	47154	1BF1	Y_OUT2R	R *
D7105	47105	1BC0	OUTR_CTL	R	D7155	47155	1BF2	Y_OUTR	R *
D7106	47106	1BC1	ALM3_CTL	R	D7156	47156	1BF3	Y_ALM3	R *
D7107	47107	1BC2	ALM2R_CTL	R	D7157	47157	1BF4	Y_ALM2R	R *
D7108	47108	1BC3			D7158	47158	1BF5		
D7109	47109	1BC4			D7159	47159	1BF6		
D7110	47110	1BC5			D7160	47160	1BF7		
D7111	47111	1BC6	DOAL	R	D7161	47161	1BF8	Y000	R *
D7112	47112	1BC7			D7162	47162	1BF9		
D7113	47113	1BC8	DO20_E2	R	D7163	47163	1BFA	Y200_E2	R *
D7114	47114	1BC9			D7164	47164	1BFB		
D7115	47115	1BCA			D7165	47165	1BFC		
D7116	47116	1BCB			D7166	47166	1BFD		
D7117	47117	1BCC			D7167	47167	1BFE		
D7118	47118	1BCD			D7168	47168	1BFF		
D7119	47119	1BCE			D7169	47169	1C00		
D7120	47120	1BCF			D7170	47170	1C01		
D7121	47121	1BD0			D7171	47171	1C02		
D7122	47122	1BD1			D7172	47172	1C03		
D7123	47123	1BD2			D7173	47173	1C04		
D7124	47124	1BD3			D7174	47174	1C05		
D7125	47125	1BD4			D7175	47175	1C06		
D7126	47126	1BD5			D7176	47176	1C07		
D7127	47127	1BD6			D7177	47177	1C08		
D7128	47128	1BD7			D7178	47178	1C09		
D7129	47129	1BD8			D7179	47179	1C0A		
D7130	47130	1BD9			D7180	47180	1C0B		
D7131	47131	1BDA			D7181	47181	1C0C		
D7132	47132	1BDB			D7182	47182	1C0D		
D7133	47133	1BDC			D7183	47183	1C0E		
D7134	47134	1BDD			D7184	47184	1C0F		
D7135	47135	1BDE			D7185	47185	1C10		
D7136	47136	1BDF			D7186	47186	1C11		
D7137	47137	1BE0			D7187	47187	1C12		
D7138	47138	1BE1			D7188	47188	1C13		
D7139	47139	1BE2			D7189	47189	1C14		
D7140	47140	1BE3			D7190	47190	1C15		
D7141	47141	1BE4			D7191	47191	1C16		
D7142	47142	1BE5			D7192	47192	1C17		
D7143	47143	1BE6			D7193	47193	1C18		
D7144	47144	1BE7			D7194	47194	1C19		
D7145	47145	1BE8			D7195	47195	1C1A		
D7146	47146	1BE9			D7196	47196	1C1B		
D7147	47147	1BEA			D7197	47197	1C1C		
D7148	47148	1BEB			D7198	47198	1C1D		
D7149	47149	1BEC			D7199	47199	1C1E		
D7150	47150	1BED			D7200	47200	1C1F		

*: R/W when the LL50A Parameter Setting Software is used.

Registers for ladder program									
Status register									
D-Reg No.	Ref. No.	H No.	Register symbol	R/W	D-Reg No.	Ref. No.	H No.	Register symbol	R/W
				UT75A					UT75A
D7201	47201	1C20	M1_16	R/W	D7251	47251	1C52		
D7202	47202	1C21	M17_32	R/W	D7252	47252	1C53		
D7203	47203	1C22	M33_48	R/W	D7253	47253	1C54		
D7204	47204	1C23	M49_64	R/W	D7254	47254	1C55		
D7205	47205	1C24	M65_80	R/W	D7255	47255	1C56		
D7206	47206	1C25	M81_96	R/W	D7256	47256	1C57		
D7207	47207	1C26	M97_112	R/W	D7257	47257	1C58		
D7208	47208	1C27	M113_128	R/W	D7258	47258	1C59		
D7209	47209	1C28			D7259	47259	1C5A		
D7210	47210	1C29			D7260	47260	1C5B		
D7211	47211	1C2A	M1_16_B	R/W	D7261	47261	1C5C		
D7212	47212	1C2B	M17_32_B	R/W	D7262	47262	1C5D		
D7213	47213	1C2C	M33_48_B	R/W	D7263	47263	1C5E		
D7214	47214	1C2D	M49_64_B	R/W	D7264	47264	1C5F		
D7215	47215	1C2E	M65_80_B	R/W	D7265	47265	1C60		
D7216	47216	1C2F	M81_96_B	R/W	D7266	47266	1C61		
D7217	47217	1C30	M97_112_B	R/W	D7267	47267	1C62		
D7218	47218	1C31	M113_128_B	R/W	D7268	47268	1C63		
D7219	47219	1C32			D7269	47269	1C64		
D7220	47220	1C33			D7270	47270	1C65		
D7221	47221	1C34	TIM_RELAY	R	D7271	47271	1C66		
D7222	47222	1C35	CNT_RELAY	R	D7272	47272	1C67		
D7223	47223	1C36			D7273	47273	1C68		
D7224	47224	1C37			D7274	47274	1C69		
D7225	47225	1C38			D7275	47275	1C6A		
D7226	47226	1C39			D7276	47276	1C6B		
D7227	47227	1C3A			D7277	47277	1C6C		
D7228	47228	1C3B			D7278	47278	1C6D		
D7229	47229	1C3C			D7279	47279	1C6E		
D7230	47230	1C3D			D7280	47280	1C6F		
D7231	47231	1C3E	TIM_RELAY_B	R	D7281	47281	1C70		
D7232	47232	1C3F	CNT_RELAY_B	R	D7282	47282	1C71		
D7233	47233	1C40			D7283	47283	1C72		
D7234	47234	1C41			D7284	47284	1C73		
D7235	47235	1C42			D7285	47285	1C74		
D7236	47236	1C43			D7286	47286	1C75		
D7237	47237	1C44			D7287	47287	1C76		
D7238	47238	1C45			D7288	47288	1C77		
D7239	47239	1C46			D7289	47289	1C78		
D7240	47240	1C47			D7290	47290	1C79		
D7241	47241	1C48			D7291	47291	1C7A		
D7242	47242	1C49			D7292	47292	1C7B		
D7243	47243	1C4A			D7293	47293	1C7C		
D7244	47244	1C4B			D7294	47294	1C7D		
D7245	47245	1C4C			D7295	47295	1C7E		
D7246	47246	1C4D			D7296	47296	1C7F		
D7247	47247	1C4E			D7297	47297	1C80		
D7248	47248	1C4F			D7298	47298	1C81		
D7249	47249	1C50			D7299	47299	1C82		
D7250	47250	1C51			D7300	47300	1C83		

14.4 UT75A D Registers

Registers for ladder program									
Constant register									
D-Reg No.	Ref. No.	H No.	Register symbol	R/W	D-Reg No.	Ref. No.	H No.	Register symbol	R/W
				UT75A					UT75A
D7301	47301	1C84	K01	R/W	D7351	47351	1CB6		
D7302	47302	1C85	K02	R/W	D7352	47352	1CB7		
D7303	47303	1C86	K03	R/W	D7353	47353	1CB8		
D7304	47304	1C87	K04	R/W	D7354	47354	1CB9		
D7305	47305	1C88	K05	R/W	D7355	47355	1CBA		
D7306	47306	1C89	K06	R/W	D7356	47356	1CBB		
D7307	47307	1C8A	K07	R/W	D7357	47357	1CBC		
D7308	47308	1C8B	K08	R/W	D7358	47358	1CBD		
D7309	47309	1C8C	K09	R/W	D7359	47359	1CBE		
D7310	47310	1C8D	K10	R/W	D7360	47360	1CBF		
D7311	47311	1C8E	K11	R/W	D7361	47361	1CC0		
D7312	47312	1C8F	K12	R/W	D7362	47362	1CC1		
D7313	47313	1C90	K13	R/W	D7363	47363	1CC2		
D7314	47314	1C91	K14	R/W	D7364	47364	1CC3		
D7315	47315	1C92	K15	R/W	D7365	47365	1CC4		
D7316	47316	1C93	K16	R/W	D7366	47366	1CC5		
D7317	47317	1C94	K17	R/W	D7367	47367	1CC6		
D7318	47318	1C95	K18	R/W	D7368	47368	1CC7		
D7319	47319	1C96	K19	R/W	D7369	47369	1CC8		
D7320	47320	1C97	K20	R/W	D7370	47370	1CC9		
D7321	47321	1C98	K21	R/W	D7371	47371	1CCA		
D7322	47322	1C99	K22	R/W	D7372	47372	1CCB		
D7323	47323	1C9A	K23	R/W	D7373	47373	1CCC		
D7324	47324	1C9B	K24	R/W	D7374	47374	1CCD		
D7325	47325	1C9C	K25	R/W	D7375	47375	1CCE		
D7326	47326	1C9D	K26	R/W	D7376	47376	1CCF		
D7327	47327	1C9E	K27	R/W	D7377	47377	1CD0		
D7328	47328	1C9F	K28	R/W	D7378	47378	1CD1		
D7329	47329	1CA0	K29	R/W	D7379	47379	1CD2		
D7330	47330	1CA1	K30	R/W	D7380	47380	1CD3		
D7331	47331	1CA2	K31	R/W	D7381	47381	1CD4		
D7332	47332	1CA3	K32	R/W	D7382	47382	1CD5		
D7333	47333	1CA4	K33	R/W	D7383	47383	1CD6		
D7334	47334	1CA5	K34	R/W	D7384	47384	1CD7		
D7335	47335	1CA6	K35	R/W	D7385	47385	1CD8		
D7336	47336	1CA7	K36	R/W	D7386	47386	1CD9		
D7337	47337	1CA8	K37	R/W	D7387	47387	1CDA		
D7338	47338	1CA9	K38	R/W	D7388	47388	1CDB		
D7339	47339	1CAA	K39	R/W	D7389	47389	1CDC		
D7340	47340	1CAB	K40	R/W	D7390	47390	1CDD		
D7341	47341	1CAC	K41	R/W	D7391	47391	1CDE		
D7342	47342	1CAD	K42	R/W	D7392	47392	1CDF		
D7343	47343	1CAE	K43	R/W	D7393	47393	1CE0		
D7344	47344	1CAF	K44	R/W	D7394	47394	1CE1		
D7345	47345	1CB0	K45	R/W	D7395	47395	1CE2		
D7346	47346	1CB1	K46	R/W	D7396	47396	1CE3		
D7347	47347	1CB2	K47	R/W	D7397	47397	1CE4		
D7348	47348	1CB3	K48	R/W	D7398	47398	1CE5		
D7349	47349	1CB4	K49	R/W	D7399	47399	1CE6		
D7350	47350	1CB5	K50	R/W	D7400	47400	1CE7		

Registers for ladder program									
Constant register									
D-Reg No.	Ref. No.	H No.	Register symbol	R/W	D-Reg No.	Ref. No.	H No.	Register symbol	R/W
				UT75A					UT75A
D7401	47401	1CE8			D7451	47451	1D1A		
D7402	47402	1CE9			D7452	47452	1D1B		
D7403	47403	1CEA			D7453	47453	1D1C		
D7404	47404	1CEB			D7454	47454	1D1D		
D7405	47405	1CEC			D7455	47455	1D1E		
D7406	47406	1CED			D7456	47456	1D1F		
D7407	47407	1CEE			D7457	47457	1D20		
D7408	47408	1CEF			D7458	47458	1D21		
D7409	47409	1CF0			D7459	47459	1D22		
D7410	47410	1CF1	C_1	R	D7460	47460	1D23		
D7411	47411	1CF2	C0	R	D7461	47461	1D24		
D7412	47412	1CF3	C1	R	D7462	47462	1D25		
D7413	47413	1CF4	C2	R	D7463	47463	1D26		
D7414	47414	1CF5	C3	R	D7464	47464	1D27		
D7415	47415	1CF6	C4	R	D7465	47465	1D28		
D7416	47416	1CF7	C5	R	D7466	47466	1D29		
D7417	47417	1CF8	C10	R	D7467	47467	1D2A		
D7418	47418	1CF9	C50	R	D7468	47468	1D2B		
D7419	47419	1CFA	C60	R	D7469	47469	1D2C		
D7420	47420	1CFB	C100	R	D7470	47470	1D2D		
D7421	47421	1CFC	C1000	R	D7471	47471	1D2E		
D7422	47422	1CFD	C10000	R	D7472	47472	1D2F		
D7423	47423	1CFE			D7473	47473	1D30		
D7424	47424	1CFF			D7474	47474	1D31		
D7425	47425	1D00			D7475	47475	1D32		
D7426	47426	1D01			D7476	47476	1D33		
D7427	47427	1D02			D7477	47477	1D34		
D7428	47428	1D03			D7478	47478	1D35		
D7429	47429	1D04			D7479	47479	1D36		
D7430	47430	1D05			D7480	47480	1D37		
D7431	47431	1D06			D7481	47481	1D38		
D7432	47432	1D07			D7482	47482	1D39		
D7433	47433	1D08			D7483	47483	1D3A		
D7434	47434	1D09			D7484	47484	1D3B		
D7435	47435	1D0A			D7485	47485	1D3C		
D7436	47436	1D0B			D7486	47486	1D3D		
D7437	47437	1D0C			D7487	47487	1D3E		
D7438	47438	1D0D			D7488	47488	1D3F		
D7439	47439	1D0E			D7489	47489	1D40		
D7440	47440	1D0F			D7490	47490	1D41		
D7441	47441	1D10			D7491	47491	1D42		
D7442	47442	1D11			D7492	47492	1D43		
D7443	47443	1D12			D7493	47493	1D44		
D7444	47444	1D13			D7494	47494	1D45		
D7445	47445	1D14			D7495	47495	1D46		
D7446	47446	1D15			D7496	47496	1D47		
D7447	47447	1D16			D7497	47497	1D48		
D7448	47448	1D17			D7498	47498	1D49		
D7449	47449	1D18			D7499	47499	1D4A		
D7450	47450	1D19			D7500	47500	1D4B		

14.4 UT75A D Registers

Registers for ladder program									
Input range / scale									
D-Reg No.	Ref. No.	H No.	Register symbol	R/W	D-Reg No.	Ref. No.	H No.	Register symbol	R/W
				UT75A					UT75A
D7501	47501	1D4C	DP_R	R	D7551	47551	1D7E		
D7502	47502	1D4D	RH_R	R	D7552	47552	1D7F		
D7503	47503	1D4E	RL_R	R	D7553	47553	1D80		
D7504	47504	1D4F			D7554	47554	1D81		
D7505	47505	1D50	SDP_R	R	D7555	47555	1D82		
D7506	47506	1D51	SH_R	R	D7556	47556	1D83		
D7507	47507	1D52	SL_R	R	D7557	47557	1D84		
D7508	47508	1D53			D7558	47558	1D85		
D7509	47509	1D54	DP_E1_R	R	D7559	47559	1D86		
D7510	47510	1D55	RH_E1_R	R	D7560	47560	1D87		
D7511	47511	1D56	RL_E1_R	R	D7561	47561	1D88		
D7512	47512	1D57			D7562	47562	1D89		
D7513	47513	1D58	SDP_E1_R	R	D7563	47563	1D8A		
D7514	47514	1D59	SH_E1_R	R	D7564	47564	1D8B		
D7515	47515	1D5A	SL_E1_R	R	D7565	47565	1D8C		
D7516	47516	1D5B			D7566	47566	1D8D		
D7517	47517	1D5C	DP_E2_R	R	D7567	47567	1D8E		
D7518	47518	1D5D	RH_E2_R	R	D7568	47568	1D8F		
D7519	47519	1D5E	RL_E2_R	R	D7569	47569	1D90		
D7520	47520	1D5F			D7570	47570	1D91		
D7521	47521	1D60	SDP_E2_R	R	D7571	47571	1D92		
D7522	47522	1D61	SH_E2_R	R	D7572	47572	1D93		
D7523	47523	1D62	SL_E2_R	R	D7573	47573	1D94		
D7524	47524	1D63			D7574	47574	1D95		
D7525	47525	1D64	DP_E4_R	R	D7575	47575	1D96		
D7526	47526	1D65	RH_E4_R	R	D7576	47576	1D97		
D7527	47527	1D66	RL_E4_R	R	D7577	47577	1D98		
D7528	47528	1D67			D7578	47578	1D99		
D7529	47529	1D68	SDP_E4_R	R	D7579	47579	1D9A		
D7530	47530	1D69	SH_E4_R	R	D7580	47580	1D9B		
D7531	47531	1D6A	SL_E4_R	R	D7581	47581	1D9C		
D7532	47532	1D6B			D7582	47582	1D9D		
D7533	47533	1D6C	P.DP_L1_R	R	D7583	47583	1D9E		
D7534	47534	1D6D	P.RH_L1_R	R	D7584	47584	1D9F		
D7535	47535	1D6E	P.RL_L1_R	R	D7585	47585	1DA0		
D7536	47536	1D6F			D7586	47586	1DA1		
D7537	47537	1D70	P.DP_L2_R	R	D7587	47587	1DA2		
D7538	47538	1D71	P.RH_L2_R	R	D7588	47588	1DA3		
D7539	47539	1D72	P.RL_L2_R	R	D7589	47589	1DA4		
D7540	47540	1D73			D7590	47590	1DA5		
D7541	47541	1D74			D7591	47591	1DA6		
D7542	47542	1D75			D7592	47592	1DA7		
D7543	47543	1D76			D7593	47593	1DA8		
D7544	47544	1D77			D7594	47594	1DA9		
D7545	47545	1D78			D7595	47595	1DAA		
D7546	47546	1D79			D7596	47596	1DAB		
D7547	47547	1D7A			D7597	47597	1DAC		
D7548	47548	1D7B			D7598	47598	1DAD		
D7549	47549	1D7C			D7599	47599	1DAE		
D7550	47550	1D7D			D7600	47600	1DAF		

For Input Ladder Calculation (D7001 to D7100)

● D7001 to D7010

Register No.	Description		Range and meaning of value
D7001	X_PV	PV analog input	-5.0 to 105.0%
D7002	X_PV2	PV2 analog input	-5.0 to 105.0%
D7003	X_AIN2	AIN2 aux. analog input	-5.0 to 105.0%
D7004			
D7005	X_AIN4	AIN4 aux. analog input	-5.0 to 105.0%
D7006 to D7010			

● Bit Configuration of D7011: X000 (DI1-DI3 status: equipped as standard)

Bit	Symbol	Event	
0	X_DI1	DI1 status	(0: OFF 1: ON)
1	X_DI2	DI2 status	(0: OFF 1: ON)
2	X_DI3	DI3 status	(0: OFF 1: ON)
3 to 15			

● Bit Configuration of 7014: X300_E3 (DI31-DI35 status: E3-terminal area)

Bit	Symbol	Event	
0	X_DI31	DI31 status	(0: OFF 1: ON)
1	X_DI32	DI32 status	(0: OFF 1: ON)
2	X_DI33	DI33 status	(0: OFF 1: ON)
3	X_DI34	DI34 status	(0: OFF 1: ON)
4	X_DI35	DI35 status	(0: OFF 1: ON)
5 to 15			

● Bit Configuration of D7015: X400_E4 (DI41-DI46 status: E4-terminal area)

Bit	Symbol	Event	
0	X_DI41	DI41 status	(0: OFF 1: ON)
1	X_DI42	DI42 status	(0: OFF 1: ON)
2	X_DI43	DI43 status	(0: OFF 1: ON)
3	X_DI44	DI44 status	(0: OFF 1: ON)
4	X_DI45	DI45 status	(0: OFF 1: ON)
5	X_DI46	DI46 status	(0: OFF 1: ON)
6 to 15			

● D7051 to D7100

Register No.	Description		Range and meaning of value
D7051	PVIN_CTL	Control PV input	-5.0 to 105.0% of PV input range (EU)
D7052	PVIN1_CTL	Control PV input 1	
D7053	PVIN2_CTL	Control PV input 2	
D7054	PVIN3_CTL	Control PV input 3	
D7055	PVIN4_CTL	Control PV input 4	
D7056	RSP_CTL	Control RSP input	0.0 to 100.0% of RSP input range (EU)
D7057	TRK_CTL	Control tracking input	-5.0 to 105.0% of TRK input range (EU)
D7058	FF_CTL	Control feedforward input	-100.0 to 100.0% of FF input range (EU)
D7059 to D7060			
D7061	PV2IN_CTL	Control PV2 input	-5.0 to 105.0% of PV input range (EU)
D7062 to D7065			
D7066	RSP2_CTL	Control RSP2 input	0.0 to 100.0% of RSP input range (EU)
D7067	TRK2_CTL	Control tracking input 2	-5.0 to 105.0% of TRK input range (EU)
D7068 to D7100			

14.4 UT75A D Registers

For Output Ladder Calculation (D7101 to D7200)

● D7101 to D7110

Register No.	Description		Range and meaning of value
D7101	OUT_CTL	Control OUT output	-5.0 to 105.0% of control OUT output range
D7102	OUT2_CTL	Control OUT2 output	-5.0 to 105.0% of control OUT2 output range
D7103	RET_CTL	Control RET output	-5.0 to 105.0% of control ERT output range
D7104	OUT2R_CTL	Control OUT2R output (Relay)	-5.0 to 105.0% of control OUT2R output range
D7105	OUTR_CTL	Control OUTR output (Relay)	-5.0 to 105.0% of control OUTR output range
D7106	ALM3_CTL	Control ALM3 output (Relay)	-5.0 to 105.0% of control OUT2R output range
D7106	ALM2R_CTL	Control ALM2 output (Relay)	-5.0 to 105.0% of control OUTR output range
D7106 to D7110			

● Bit Configuration of D7111: DOAL (Control AL1-AL3 status: equipped as standard)

Bit	Symbol	Event	
0	AL1_CTL	Control AL1 status	(0: OFF 1: ON)
1	AL2_CTL	Control AL2 status	(0: OFF 1: ON)
2	AL3_CTL	Control AL3 status	(0: OFF 1: ON)
3 to 15			

● Bit Configuration of D7113: DO20_E2 (Control DO21-DO25 status: E2-terminal area)

Bit	Symbol	Event	
0	DO21_CTL	Control DO21 status	(0: OFF 1: ON)
1	DO22_CTL	Control DO22 status	(0: OFF 1: ON)
2	DO23_CTL	Control DO23 status	(0: OFF 1: ON)
3	DO24_CTL	Control DO24 status	(0: OFF 1: ON)
4	DO25_CTL	Control DO25 status	(0: OFF 1: ON)
5 to 15			

● D7116 to D7160

Register No.	Description		Range and meaning of value
D7116 to D7150			
D7151	Y_OUT	OUT control output	-5.0 to 105.0%
D7152	Y_OUT2	OUT2 control output	-5.0 to 105.0%
D7153	Y_RET	RET control output	-5.0 to 105.0%
D7154	Y_OUT2R	OUT2R control output	-5.0 to 105.0%
D7155	Y_OUTR	OUTR control output	-5.0 to 105.0%
D7156	Y_ALM3	OUTR control output	-5.0 to 105.0%
D7157	Y_ALM2R	OUT2R control output	-5.0 to 105.0%
D7158 to D7160			

● Bit Configuration of D7161: Y000 (AL1-AL3 status: equipped as standard)

Bit	Symbol	Event	
0	Y_AL1	AL1 status	(0: OFF 1: ON)
1	Y_AL2	AL2 status	(0: OFF 1: ON)
2	Y_AL3	AL3 status	(0: OFF 1: ON)
3 to 15			

● Bit Configuration of D7163: **Y200_E2** (DO21-DO25 status: E2-terminal area)

Bit	Symbol	Event	
0	Y_DO21	DO11 status	(0: OFF 1: ON)
1	Y_DO22	DO12 status	(0: OFF 1: ON)
2	Y_DO23	DO13 status	(0: OFF 1: ON)
3	Y_DO24	DO14 status	(0: OFF 1: ON)
4	Y_DO25	DO15 status	(0: OFF 1: ON)
5 to 15			

Status Registers (D7201 to D7300)

● Bit Configuration of D7201 to D7208: **M1_16 to M113_128** (Status register (M1-M16 to M113-M128, Non-holding type))

Bit	Symbol								Event	
0	M01	M17	M33	M49	M65	M81	M97	M113	Internal relay (Non-holding type)	(0: OFF 1: ON)
1	M02	M18	M34	M50	M66	M82	M98	M114	Internal relay (Non-holding type)	(0: OFF 1: ON)
2	M03	M19	M35	M51	M67	M83	M99	M115	Internal relay (Non-holding type)	(0: OFF 1: ON)
3	M04	M20	M36	M52	M68	M84	M100	M116	Internal relay (Non-holding type)	(0: OFF 1: ON)
4	M05	M21	M37	M53	M69	M85	M101	M117	Internal relay (Non-holding type)	(0: OFF 1: ON)
5	M06	M22	M38	M54	M70	M86	M102	M118	Internal relay (Non-holding type)	(0: OFF 1: ON)
6	M07	M23	M39	M55	M71	M87	M103	M119	Internal relay (Non-holding type)	(0: OFF 1: ON)
7	M08	M24	M40	M56	M72	M88	M104	M120	Internal relay (Non-holding type)	(0: OFF 1: ON)
8	M09	M25	M41	M57	M73	M89	M105	M121	Internal relay (Non-holding type)	(0: OFF 1: ON)
9	M10	M26	M42	M58	M74	M90	M106	M122	Internal relay (Non-holding type)	(0: OFF 1: ON)
10	M11	M27	M43	M59	M75	M91	M107	M123	Internal relay (Non-holding type)	(0: OFF 1: ON)
11	M12	M28	M44	M60	M76	M92	M108	M124	Internal relay (Non-holding type)	(0: OFF 1: ON)
12	M13	M29	M45	M61	M77	M93	M109	M125	Internal relay (Non-holding type)	(0: OFF 1: ON)
13	M14	M30	M46	M62	M78	M94	M110	M126	Internal relay (Non-holding type)	(0: OFF 1: ON)
14	M15	M31	M47	M63	M79	M95	M111	M127	Internal relay (Non-holding type)	(0: OFF 1: ON)
15	M16	M32	M48	M64	M80	M96	M112	M128	Internal relay (Non-holding type)	(0: OFF 1: ON)

● Bit Configuration of D7211 to D7212: **M1_16_B to M17_32_B** (Status register (M1_B-M16_B to M17_B-M32_B, Holding type))

Bit	Symbol		Event	
0	M01_B	M17_B	Internal relay (Holding type)	(0: OFF 1: ON)
1	M02_B	M18_B	Internal relay (Holding type)	(0: OFF 1: ON)
2	M03_B	M19_B	Internal relay (Holding type)	(0: OFF 1: ON)
3	M04_B	M20_B	Internal relay (Holding type)	(0: OFF 1: ON)
4	M05_B	M21_B	Internal relay (Holding type)	(0: OFF 1: ON)
5	M06_B	M22_B	Internal relay (Holding type)	(0: OFF 1: ON)
6	M07_B	M23_B	Internal relay (Holding type)	(0: OFF 1: ON)
7	M08_B	M24_B	Internal relay (Holding type)	(0: OFF 1: ON)
8	M09_B	M25_B	Internal relay (Holding type)	(0: OFF 1: ON)
9	M10_B	M26_B	Internal relay (Holding type)	(0: OFF 1: ON)
10	M11_B	M27_B	Internal relay (Holding type)	(0: OFF 1: ON)
11	M12_B	M28_B	Internal relay (Holding type)	(0: OFF 1: ON)
12	M13_B	M29_B	Internal relay (Holding type)	(0: OFF 1: ON)
13	M14_B	M30_B	Internal relay (Holding type)	(0: OFF 1: ON)
14	M15_B	M31_B	Internal relay (Holding type)	(0: OFF 1: ON)
15	M16_B	M32_B	Internal relay (Holding type)	(0: OFF 1: ON)

14.4 UT75A D Registers

● Bit Configuration of D7213 to D7218: M33_48_B to M113_128_B (Status register (M33_B-M48_B to M113_B-M128_B, Holding type))

Bit	Symbol						Event
0	M33_B	M49_B	M65_B	M81_B	M97_B	M113_B	Internal relay (Holding type) * (0: OFF 1: ON)
1	M34_B	M50_B	M66_B	M82_B	M98_B	M114_B	Internal relay (Holding type) * (0: OFF 1: ON)
2	M35_B	M51_B	M67_B	M83_B	M99_B	M115_B	Internal relay (Holding type) * (0: OFF 1: ON)
3	M36_B	M52_B	M68_B	M84_B	M100_B	M116_B	Internal relay (Holding type) * (0: OFF 1: ON)
4	M37_B	M53_B	M69_B	M85_B	M101_B	M117_B	Internal relay (Holding type) * (0: OFF 1: ON)
5	M38_B	M54_B	M70_B	M86_B	M102_B	M118_B	Internal relay (Holding type) * (0: OFF 1: ON)
6	M39_B	M55_B	M71_B	M87_B	M103_B	M119_B	Internal relay (Holding type) * (0: OFF 1: ON)
7	M40_B	M56_B	M72_B	M88_B	M104_B	M120_B	Internal relay (Holding type) * (0: OFF 1: ON)
8	M41_B	M57_B	M73_B	M89_B	M105_B	M121_B	Internal relay (Holding type) * (0: OFF 1: ON)
9	M42_B	M58_B	M74_B	M90_B	M106_B	M122_B	Internal relay (Holding type) * (0: OFF 1: ON)
10	M43_B	M59_B	M75_B	M91_B	M107_B	M123_B	Internal relay (Holding type) * (0: OFF 1: ON)
11	M44_B	M60_B	M76_B	M92_B	M108_B	M124_B	Internal relay (Holding type) * (0: OFF 1: ON)
12	M45_B	M61_B	M77_B	M93_B	M109_B	M125_B	Internal relay (Holding type) * (0: OFF 1: ON)
13	M46_B	M62_B	M78_B	M94_B	M110_B	M126_B	Internal relay (Holding type) * (0: OFF 1: ON)
14	M47_B	M63_B	M79_B	M95_B	M111_B	M127_B	Internal relay (Holding type) * (0: OFF 1: ON)
15	M48_B	M64_B	M80_B	M96_B	M112_B	M128_B	Internal relay (Holding type) * (0: OFF 1: ON)

*: It is Non-holding type when the input sampling period (control period) (SMP) is 50 ms.

● Bit Configuration of D7221: TIM_RELAY (Time out flag)

Bit	Symbol	Event
0	TIM1	Timer-1 time out flag (0: OFF 1: ON)
1	TIM2	Timer-2 time out flag (0: OFF 1: ON)
2	TIM3	Timer-3 time out flag (0: OFF 1: ON)
3	TIM4	Timer-4 time out flag (0: OFF 1: ON)
4 to 15		

● Bit Configuration of D7222: CNT_RELAY (Count out relay flag)

Bit	Symbol	Event
0	CNT1	Counter-1 count out flag (0: OFF 1: ON)
1	CNT2	Counter-2 count out flag (0: OFF 1: ON)
2	CNT3	Counter-3 count out flag (0: OFF 1: ON)
3	CNT4	Counter-4 count out flag (0: OFF 1: ON)
4 to 15		

● Bit Configuration of D7231: TIM_RELAY_B (Time out flag)

Bit	Symbol	Event
0	TIM1	Timer-1 time out flag (0: OFF 1: ON)
1	TIM2	Timer-2 time out flag (0: OFF 1: ON)
2	TIM3	Timer-3 time out flag (0: OFF 1: ON)
3	TIM4	Timer-4 time out flag (0: OFF 1: ON)
4 to 15		

● Bit Configuration of D7232: CNT_RELAY_B (Count out relay flag)

Bit	Symbol	Event
0	CNT1	Counter-1 count out flag (0: OFF 1: ON)
1	CNT2	Counter-2 count out flag (0: OFF 1: ON)
2	CNT3	Counter-3 count out flag (0: OFF 1: ON)
3	CNT4	Counter-4 count out flag (0: OFF 1: ON)
4 to 15		

Constant Register (D7301 to D7500)

Register No.	Description		Range and meaning of value
D7301 to D7330	K01 to K50	K01 data register to K50 data register	K01 to K20, K31 to K50: -32768 to 32767 K21 to K30: 0 to 65535
D7331 to D7409			
D7410	C_1	Constant -1	-1
D7411	C0	Constant 0	0
D7412	C1	Constant 1	1
D7413	C2	Constant 2	2
D7414	C3	Constant 3	3
D7415	C4	Constant 4	4
D7416	C5	Constant 5	5
D7417	C10	Constant 10	10
D7418	C50	Constant 50	50
D7419	C60	Constant 60	60
D7420	C100	Constant 100	100
D7421	C1000	Constant 1000	1000
D7422	C10000	Constant 10000	10000
D7423 to D7500			

Input Range / Scale (D7501 to D7600) (Read only)

Register No.	Description		Range and meaning of value
D7501	DP_R	PV input decimal point position	Same as D5103 (DP)
D7502	RH_R	Maximum value of PV input range	Same as D5104 (RH)
D7503	RL_R	Minimum value of PV input range	Same as D5105 (RL)
D7504			
D7505	SDP_R	PV input scale decimal point position	Same as D5106 (SDP)
D7506	SH_R	Maximum value of PV input scale	Same as D5107 (SH)
D7507	SL_R	Minimum value of PV input scale	Same as D5108 (SL)
D7508			
D7509	DP_E1_R	PV2 input decimal point position	Same as D5123 (DP_E1)
D7510	RH_E1_R	Maximum value of PV2 input range	Same as D5124 (RH_E1)
D7511	RL_E1_R	Minimum value of PV2 input range	Same as D5125 (RL_E1)
D7512			
D7513	SDP_E1_R	PV2 input scale decimal point position	Same as D5126 (SDP_E1)
D7514	SH_E1_R	Maximum value of PV2 input scale	Same as D5127 (SH_E1)
D7515	SL_E1_R	Minimum value of PV2 input scale	Same as D5128 (SL_E1)
D7516			
D7517	DP_E2_R	AIN2 aux. analog input decimal point position	Same as D5143 (DP_E2)
D7518	RH_E2_R	Maximum value of AIN2 aux. analog input range	Same as D5144 (RH_E2)
D7519	RL_E2_R	Minimum value of AIN2 aux. analog input range	Same as D5145 (RL_E2)
D7520			
D7521	SDP_E2_R	AIN2 aux. analog input scale decimal point position	Same as D5146 (SDP_E2)
D7522	SH_E2_R	Maximum value of AIN2 aux. analog input scale	Same as D5147 (SH_E2)
D7523	SL_E2_R	Minimum value of AIN2 aux. analog input scale	Same as D5148 (SL_E2)
D7524			

14.4 UT75A D Registers

Register No.	Description		Range and meaning of value
D7525	DP_E4_R	Maximum value of AIN4 remote (aux. analog) input position	Same as D5183 (DP_E4)
D7526	RH_E4_R	Maximum value of AIN4 remote (aux. analog) input range	Same as D5184 (RH_E4)
D7527	RL_E4_R	Minimum value of AIN4 remote (aux. analog) input range	Same as D5185 (RL_E4)
D7528			
D7529	SDP_E4_R	AIN4 remote (aux. analog) input scale decimal point position	Same as D5186 (SDP_E4)
D7530	SH_E4_R	Maximum value of AIN4 remote (aux. analog) input scale	Same as D5187 (SH_E4)
D7531	SL_E4_R	Minimum value of AIN4 remote (aux. analog) input scale	Same as D5188 (SL_E4)
D7532			
D7533	P.DP_L1_R	Loop-1 control PV input decimal point position	Same as D5202 (P.DP_L1)
D7534	P.RH_L1_R	Loop-1 maximum value of control PV input range	Same as D5203 (P.RH_L1)
D7535	P.RL_L1_R	Loop-1 minimum value of control PV input range	Same as D5204 (P.RL_L1)
D7536			
D7537	P.DP_L2_R	Loop-2 control PV input decimal point position (in Cascade control or Dual-loop control)	Same as D5222 (P.DP_L2)
D7538	P.RH_L2_R	Loop-2 maximum value of Control PV input range (in Cascade control or Dual-loop control)	Same as D5223 (P.RH_L2)
D7539	P.RL_L2_R	Loop-2 minimum value of Control PV input range (in Cascade control or Dual-loop control)	Same as D5224 (P.RL_L2)
D7540 to D7600			

14.4.9 Input / Output Terminal Status Register (D7601 to D7700)

Terminal status registers									
Input / output terminal status register									
D-Reg No.	Ref. No.	H No.	Register symbol	R/W	D-Reg No.	Ref. No.	H No.	Register symbol	R/W
				UT75A					UT75A
D7601	47601	1DB0	DI	R	D7651	47651	1DE2		
D7602	47602	1DB1			D7652	47652	1DE3		
D7603	47603	1DB2			D7653	47653	1DE4		
D7604	47604	1DB3	DI_E3	R	D7654	47654	1DE5		
D7605	47605	1DB4	DI_E4	R	D7655	47655	1DE6		
D7606	47606	1DB5			D7656	47656	1DE7		
D7607	47607	1DB6			D7657	47657	1DE8		
D7608	47608	1DB7			D7658	47658	1DE9		
D7609	47609	1DB8			D7659	47659	1DEA		
D7610	47610	1DB9			D7660	47660	1DEB		
D7611	47611	1DBA	OUT_AL	R	D7661	47661	1DEC		
D7612	47612	1DBB			D7662	47662	1DED		
D7613	47613	1DBC	OUT_DO_E2	R	D7663	47663	1DEE		
D7614	47614	1DBD			D7664	47664	1DEF		
D7615	47615	1DBE			D7665	47665	1DF0		
D7616	47616	1DBF			D7666	47666	1DF1		
D7617	47617	1DC0			D7667	47667	1DF2		
D7618	47618	1DC1			D7668	47668	1DF3		
D7619	47619	1DC2			D7669	47669	1DF4		
D7620	47620	1DC3			D7670	47670	1DF5		
D7621	47621	1DC4	OUT_OUT	R	D7671	47671	1DF6		
D7622	47622	1DC5	OUT_OUT2H	R	D7672	47672	1DF7		
D7623	47623	1DC6	OUT_OUT2L	R	D7673	47673	1DF8		
D7624	47624	1DC7	OUT_RET	R	D7674	47674	1DF9		
D7625	47625	1DC8	OUT_OUTR	R	D7675	47675	1DFA		
D7626	47626	1DC9	OUT_OUT2R	R	D7676	47676	1DFB		
D7627	47627	1DCA			D7677	47677	1DFC		
D7628	47628	1DCB			D7678	47678	1DFD		
D7629	47629	1DCC	OUT_ALM2	R	D7679	47679	1DFE		
D7630	47630	1DCD	OUT_ALM3R	R	D7680	47680	1DFF		
D7631	47631	1DCE			D7681	47681	1E00		
D7632	47632	1DCF			D7682	47682	1E01		
D7633	47633	1DD0			D7683	47683	1E02		
D7634	47634	1DD1			D7684	47684	1E03		
D7635	47635	1DD2			D7685	47685	1E04		
D7636	47636	1DD3			D7686	47686	1E05		
D7637	47637	1DD4			D7687	47687	1E06		
D7638	47638	1DD5			D7688	47688	1E07		
D7639	47639	1DD6			D7689	47689	1E08		
D7640	47640	1DD7			D7690	47690	1E09		
D7641	47641	1DD8			D7691	47691	1E0A		
D7642	47642	1DD9			D7692	47692	1E0B		
D7643	47643	1DDA			D7693	47693	1E0C		
D7644	47644	1ddb			D7694	47694	1E0D		
D7645	47645	1DDC			D7695	47695	1E0E		
D7646	47646	1DDD			D7696	47696	1E0F		
D7647	47647	1DDE			D7697	47697	1E10		
D7648	47648	1DDF			D7698	47698	1E11		
D7649	47649	1DE0			D7699	47699	1E12		
D7650	47650	1DE1			D7700	47700	1E13		

14.4 UT75A D Registers

● **Bit Configuration of D7601: DI (DI1-DI3 terminal status: equipped as standard)**

Bit	Symbol	Event	
0	DI1	DI1 terminal status	(0: OFF 1: ON)
1	DI2	DI2 terminal status	(0: OFF 1: ON)
2	DI3	DI3 terminal status	(0: OFF 1: ON)
3 to 15			

● **Bit Configuration of D7604: DI_E3 (DI31- DI35 terminal status: E3-terminal area)**

Bit	Symbol	Event	
0	DI31	DI31 terminal status	(0: OFF 1: ON)
1	DI32	DI32 terminal status	(0: OFF 1: ON)
2	DI33	DI33 terminal status	(0: OFF 1: ON)
3	DI34	DI34 terminal status	(0: OFF 1: ON)
4	DI35	DI35 terminal status	(0: OFF 1: ON)
5 to 15			

● **Bit Configuration of D7605: DI_E4 (DI41-DI46 terminal status: E4-terminal area)**

Bit	Symbol	Event	
0	DI41	DI41 terminal status	(0: OFF 1: ON)
1	DI42	DI42 terminal status	(0: OFF 1: ON)
2	DI43	DI43 terminal status	(0: OFF 1: ON)
3	DI44	DI44 terminal status	(0: OFF 1: ON)
4	DI45	DI45 terminal status	(0: OFF 1: ON)
5	DI46	DI46 terminal status	(0: OFF 1: ON)
6 to 15			

● **Bit Configuration of D7611: OUT_AL (AL1-AL3 terminal status: equipped as standard)**

Bit	Symbol	Event	
0	OUT_AL1	AL1 terminal status	(0: OFF 1: ON)
1	OUT_AL2	AL2 terminal status	(0: OFF 1: ON)
2	OUT_AL3	AL3 terminal status	(0: OFF 1: ON)
3 to 15			

● **Bit Configuration of D7613: OUT_DO_E2 (DO21-DO25 terminal status: E2-terminal area)**

Bit	Symbol	Event	
0	OUT_DO21	DO21 terminal status	(0: OFF 1: ON)
1	OUT_DO22	DO22 terminal status	(0: OFF 1: ON)
2	OUT_DO23	DO23 terminal status	(0: OFF 1: ON)
3	OUT_DO24	DO24 terminal status	(0: OFF 1: ON)
4	OUT_DO25	DO25 terminal status	(0: OFF 1: ON)
5 to 15			

● D7616 to D7700

Register No.	Description		Range and meaning of value
D7616 to D7620			
D7621	OUT_OUT	OUT terminal	-1500 to 31500
D7622	OUT_OUT2H	Cooling-side control output: OUT2 terminal (Relay) Position proportional control output: VALV (HIGH) terminal	0: OFF 30000: ON
D7623	OUT_OUT2L	Cooling-side control output in Heating/cooling control: OUT2 terminal	-1500 to 31500
		Position proportional control output: VALV (LOW) terminal	0: OFF 30000: ON
D7624	OUT_RET	RET terminal	-1500 to 31500
D7625	OUT_OUTR	OUT terminal (Relay)	-1500 to 31500
D7626	OUT_OUT2R	OUT2 terminal (Relay)	-1500 to 31500
D7627 to D7628			
D7629	OUT_ALM3	AL3 terminal (Relay)	-1500 to 31500
D7630	OUT_ALM2R	AL2 terminal (Relay)	-1500 to 31500
D7631 to D7700			

12.4.10 Program Pattern Parameters (D7701 to D7900)

Program pattern parameters									
Program pattern setting (Menu: PROG)									
D-Reg No.	Ref. No.	H No.	Register symbol	R/W	D-Reg No.	Ref. No.	H No.	Register symbol	R/W
				UT75A					UT75A
D7701	47701	1E14	SSP_L1	R/W	D7751	47751	1E46		
D7702	47702	1E15	SSP_L2	R/W	D7752	47752	1E47		
D7703	47703	1E16	STC	R/W	D7753	47753	1E48		
D7704	47704	1E17	WT.SW1	R/W	D7754	47754	1E49		
D7705	47705	1E18	WZ.UP1	R/W	D7755	47755	1E4A		
D7706	47706	1E19	WZ.LO1	R/W	D7756	47756	1E4B		
D7707	47707	1E1A	WT.SW2	R/W	D7757	47757	1E4C		
D7708	47708	1E1B	WZ.UP2	R/W	D7758	47758	1E4D		
D7709	47709	1E1C	WZ.LO2	R/W	D7759	47759	1E4E		
D7710	47710	1E1D	R.CYC	R/W	D7760	47760	1E4F		
D7711	47711	1E1E			D7761	47761	1E50		
D7712	47712	1E1F			D7762	47762	1E51		
D7713	47713	1E20			D7763	47763	1E52		
D7714	47714	1E21			D7764	47764	1E53		
D7715	47715	1E22			D7765	47765	1E54		
D7716	47716	1E23			D7766	47766	1E55		
D7717	47717	1E24			D7767	47767	1E56		
D7718	47718	1E25			D7768	47768	1E57		
D7719	47719	1E26			D7769	47769	1E58		
D7720	47720	1E27			D7770	47770	1E59		
D7721	47721	1E28			D7771	47771	1E5A		
D7722	47722	1E29			D7772	47772	1E5B		
D7723	47723	1E2A			D7773	47773	1E5C		
D7724	47724	1E2B			D7774	47774	1E5D		
D7725	47725	1E2C			D7775	47775	1E5E		
D7726	47726	1E2D			D7776	47776	1E5F		
D7727	47727	1E2E			D7777	47777	1E60		
D7728	47728	1E2F			D7778	47778	1E61		
D7729	47729	1E30			D7779	47779	1E62		
D7730	47730	1E31			D7780	47780	1E63		
D7731	47731	1E32			D7781	47781	1E64		
D7732	47732	1E33			D7782	47782	1E65		
D7733	47733	1E34			D7783	47783	1E66		
D7734	47734	1E35			D7784	47784	1E67		
D7735	47735	1E36			D7785	47785	1E68		
D7736	47736	1E37			D7786	47786	1E69		
D7737	47737	1E38			D7787	47787	1E6A		
D7738	47738	1E39			D7788	47788	1E6B		
D7739	47739	1E3A			D7789	47789	1E6C		
D7740	47740	1E3B			D7790	47790	1E6D		
D7741	47741	1E3C			D7791	47791	1E6E		
D7742	47742	1E3D			D7792	47792	1E6F		
D7743	47743	1E3E			D7793	47793	1E70		
D7744	47744	1E3F			D7794	47794	1E71		
D7745	47745	1E40			D7795	47795	1E72		
D7746	47746	1E41			D7796	47796	1E73		
D7747	47747	1E42			D7797	47797	1E74		
D7748	47748	1E43			D7798	47798	1E75		
D7749	47749	1E44			D7799	47799	1E76		
D7750	47750	1E45			D7800	47800	1E77	JC	R/W

Note

Program pattern parameter cannot be written during program operation (RUN mode).
 Setting the program pattern parameter can be available during STOP or HOLD mode operation.

Program pattern parameters									
Program pattern setting (Menu: PROG)									
D-Reg No.	Ref. No.	H No.	Register symbol	R/W	D-Reg No.	Ref. No.	H No.	Register symbol	R/W
				UT75A					UT75A
D7801	47801	1E78	TSP_L1_1	R/W	D7851	47851	1EAA	TSP_L1_11	R/W
D7802	47802	1E79	TSP_L2_1	R/W	D7852	47852	1EAB	TSP_L2_11	R/W
D7803	47803	1E7A	TIME_1	R/W	D7853	47853	1EAC	TIME_11	R/W
D7804	47804	1E7B	S.PID_L1_1	R/W	D7854	47854	1EAD	S.PID_L1_11	R/W
D7805	47805	1E7C	S.PID_L2_1	R/W	D7855	47855	1EAE	S.PID_L2_11	R/W
D7806	47806	1E7D	TSP_L1_2	R/W	D7856	47856	1EAF	TSP_L1_12	R/W
D7807	47807	1E7E	TSP_L2_2	R/W	D7857	47857	1EB0	TSP_L2_12	R/W
D7808	47808	1E7F	TIME_2	R/W	D7858	47858	1EB1	TIME_12	R/W
D7809	47809	1E80	S.PID_L1_2	R/W	D7859	47859	1EB2	S.PID_L1_12	R/W
D7810	47810	1E81	S.PID_L2_2	R/W	D7860	47860	1EB3	S.PID_L2_12	R/W
D7811	47811	1E82	TSP_L1_3	R/W	D7861	47861	1EB4	TSP_L1_13	R/W
D7812	47812	1E83	TSP_L2_3	R/W	D7862	47862	1EB5	TSP_L2_13	R/W
D7813	47813	1E84	TIME_3	R/W	D7863	47863	1EB6	TIME_13	R/W
D7814	47814	1E85	S.PID_L1_3	R/W	D7864	47864	1EB7	S.PID_L1_13	R/W
D7815	47815	1E86	S.PID_L2_3	R/W	D7865	47865	1EB8	S.PID_L2_13	R/W
D7816	47816	1E87	TSP_L1_4	R/W	D7866	47866	1EB9	TSP_L1_14	R/W
D7817	47817	1E88	TSP_L2_4	R/W	D7867	47867	1EBA	TSP_L2_14	R/W
D7818	47818	1E89	TIME_4	R/W	D7868	47868	1EBB	TIME_14	R/W
D7819	47819	1E8A	S.PID_L1_4	R/W	D7869	47869	1EBC	S.PID_L1_14	R/W
D7820	47820	1E8B	S.PID_L2_4	R/W	D7870	47870	1EBD	S.PID_L2_14	R/W
D7821	47821	1E8C	TSP_L1_5	R/W	D7871	47871	1EBE	TSP_L1_15	R/W
D7822	47822	1E8D	TSP_L2_5	R/W	D7872	47872	1EBF	TSP_L2_15	R/W
D7823	47823	1E8E	TIME_5	R/W	D7873	47873	1EC0	TIME_15	R/W
D7824	47824	1E8F	S.PID_L1_5	R/W	D7874	47874	1EC1	S.PID_L1_15	R/W
D7825	47825	1E90	S.PID_L2_5	R/W	D7875	47875	1EC2	S.PID_L2_15	R/W
D7826	47826	1E91	TSP_L1_6	R/W	D7876	47876	1EC3	TSP_L1_16	R/W
D7827	47827	1E92	TSP_L2_6	R/W	D7877	47877	1EC4	TSP_L2_16	R/W
D7828	47828	1E93	TIME_6	R/W	D7878	47878	1EC5	TIME_16	R/W
D7829	47829	1E94	S.PID_L1_6	R/W	D7879	47879	1EC6	S.PID_L1_16	R/W
D7830	47830	1E95	S.PID_L2_6	R/W	D7880	47880	1EC7	S.PID_L2_16	R/W
D7831	47831	1E96	TSP_L1_7	R/W	D7881	47881	1EC8	TSP_L1_17	R/W
D7832	47832	1E97	TSP_L2_7	R/W	D7882	47882	1EC9	TSP_L2_17	R/W
D7833	47833	1E98	TIME_7	R/W	D7883	47883	1ECA	TIME_17	R/W
D7834	47834	1E99	S.PID_L1_7	R/W	D7884	47884	1ECB	S.PID_L1_17	R/W
D7835	47835	1E9A	S.PID_L2_7	R/W	D7885	47885	1ECC	S.PID_L2_17	R/W
D7836	47836	1E9B	TSP_L1_8	R/W	D7886	47886	1ECD	TSP_L1_18	R/W
D7837	47837	1E9C	TSP_L2_8	R/W	D7887	47887	1ECE	TSP_L2_18	R/W
D7838	47838	1E9D	TIME_8	R/W	D7888	47888	1ECF	TIME_18	R/W
D7839	47839	1E9E	S.PID_L1_8	R/W	D7889	47889	1ED0	S.PID_L1_18	R/W
D7840	47840	1E9F	S.PID_L2_8	R/W	D7890	47890	1ED1	S.PID_L2_18	R/W
D7841	47841	1EA0	TSP_L1_9	R/W	D7891	47891	1ED2	TSP_L1_19	R/W
D7842	47842	1EA1	TSP_L2_9	R/W	D7892	47892	1ED3	TSP_L2_19	R/W
D7843	47843	1EA2	TIME_9	R/W	D7893	47893	1ED4	TIME_19	R/W
D7844	47844	1EA3	S.PID_L1_9	R/W	D7894	47894	1ED5	S.PID_L1_19	R/W
D7845	47845	1EA4	S.PID_L2_9	R/W	D7895	47895	1ED6	S.PID_L2_19	R/W
D7846	47846	1EA5	TSP_L1_10	R/W	D7896	47896	1ED7	TSP_L1_20	R/W
D7847	47847	1EA6	TSP_L2_10	R/W	D7897	47897	1ED8	TSP_L2_20	R/W
D7848	47848	1EA7	TIME_10	R/W	D7898	47898	1ED9	TIME_20	R/W
D7849	47849	1EA8	S.PID_L1_10	R/W	D7899	47899	1EDA	S.PID_L1_20	R/W
D7850	47850	1EA9	S.PID_L2_10	R/W	D7900	47900	1EDB	S.PID_L2_20	R/W

14.4 UT75A D Registers

Program Pattern Setting (D7701 to D7900)

Register No.	Description		Range and meaning of value
D7701	SSP_L1	Loop-1 Starting target setpoint	0.0 to 100.0% of PV input range (EU)
D7702	SSP_L2	Loop-2 Starting target setpoint	(Setting range: P.RL to P.RH)
D7703	STC	Start code	0: SSP (Program operation begins with the starting target setpoint. 1: RAMP (Ramp-prioritized PV start) 2: TIME (Time-prioritized PV start)
D7704	WT.SW1	Loop-1 Wait function ON/OFF	WT.SW_L1, WT.SW_L2 0: OFF (Disable) 1: ON (Enable)
D7705	WZ.UP1	Loop-1 Upper-side wait zone	
D7706	WZ.LO1	Loop-1 Lower-side wait zone	WZ.UP_L1, WZ.UP_L2 WZ.LO_L1, WZ.LO_L2
D7707	WT.SW2	Loop-2 Wait function ON/OFF	0.0 to 10.0% of PV input range (EU)
D7708	WZ.UP2	Loop-2 Upper-side wait zone	* Available only for the wait time at the segment switching. * Use the parameter TMU to set the time unit. (Common in the instrument.)
D7709	WZ.LO2	Loop-2 Lower-side wait zone	
D7710	R.CYCL	Number of repeat cycles	0 to 999, CONT (limitless number of times)
D7711 to D7799			
D7800	JC	Junction code	CONT: Switching for continuation HOLD: Hold-on switching (the controller holds the end-of segment setpoint when the segment is completed, to perform control).
D7801	TSP_L1_1	Loop-1, segment-1 final target setpoint	0.0 to 100.0% of PV input range (EU) (Setting range: P.RL to P.RH)
D7802	TSP_L2_1	Loop-2, segment-1 final target setpoint	
D7803	TIME_1	Segment time setting of segment 1	-: Unregistered 0.00 to 99.59 ("hour.minute" or "minute.second") * Use the parameter TMU to set the time unit. (Common in the instrument.) * If the setting is 0.00, TSP changes in stepwise after one control period.
D7804	S.PID_L1_1	Loop-1, segment-1 segment PID number selection	1 to 16
D7805	S.PID_L2_1	Loop-2, segment-1 segment PID number selection	*However, parameter ZON is set to 0.
D7806 to D7810	TSP_L1_2 to S.PID_L2_2	Loop-1, segment-2 final target setpoint to Loop-2, segment-2 segment PID number selection	Same as D7801 to D7805.
D7806 to D7810	TSP_L1_3 to S.PID_L2_3	Loop-1, segment-3 final target setpoint to Loop-2, segment-3 segment PID number selection	Same as D7801 to D7805.
D7806 to D7810	TSP_L1_4 to S.PID_L2_4	Loop-1, segment-4 final target setpoint to Loop-2, segment-4 segment PID number selection	Same as D7801 to D7805.
D7806 to D7810	TSP_L1_5 to S.PID_L2_5	Loop-1, segment-5 final target setpoint to Loop-2, segment-5 segment PID number selection	Same as D7801 to D7805.
D7806 to D7810	TSP_L1_6 to S.PID_L2_6	Loop-1, segment-6 final target setpoint to Loop-2, segment-6 segment PID number selection	Same as D7801 to D7805.
D7806 to D7810	TSP_L1_7 to S.PID_L2_7	Loop-1, segment-7 final target setpoint to Loop-2, segment-7 segment PID number selection	Same as D7801 to D7805.

Register No.	Description	Range and meaning of value	
D7806 to D7810	TSP_L1_8 to S.PID_L2_8	Loop-1, segment-8 final target setpoint to Loop-2, segment-8 segment PID number selection	Same as D7801 to D7805.
D7806 to D7810	TSP_L1_9 to S.PID_L2_9	Loop-1, segment-9 final target setpoint to Loop-2, segment-9 segment PID number selection	Same as D7801 to D7805.
D7806 to D7810	TSP_L1_10 to S.PID_L2_10	Loop-1, segment-10 final target setpoint to Loop-2, segment-10 segment PID number selection	Same as D7801 to D7805.
D7806 to D7810	TSP_L1_11 to S.PID_L2_11	Loop-1, segment-11 final target setpoint to Loop-2, segment-11 segment PID number selection	Same as D7801 to D7805.
D7806 to D7810	TSP_L1_12 to S.PID_L2_12	Loop-1, segment-12 final target setpoint to Loop-2, segment-12 segment PID number selection	Same as D7801 to D7805.
D7806 to D7810	TSP_L1_13 to S.PID_L2_13	Loop-1, segment-13 final target setpoint to Loop-2, segment-13 segment PID number selection	Same as D7801 to D7805.
D7806 to D7810	TSP_L1_14 to S.PID_L2_14	Loop-1, segment-14 final target setpoint to Loop-2, segment-14 segment PID number selection	Same as D7801 to D7805.
D7806 to D7810	TSP_L1_15 to S.PID_L2_15	Loop-1, segment-15 final target setpoint to Loop-2, segment-15 segment PID number selection	Same as D7801 to D7805.
D7806 to D7810	TSP_L1_16 to S.PID_L2_16	Loop-1, segment-16 final target setpoint to Loop-2, segment-16 segment PID number selection	Same as D7801 to D7805.
D7806 to D7810	TSP_L1_17 to S.PID_L2_17	Loop-1, segment-17 final target setpoint to Loop-2, segment-17 segment PID number selection	Same as D7801 to D7805.
D7806 to D7810	TSP_L1_18 to S.PID_L2_18	Loop-1, segment-18 final target setpoint to Loop-2, segment-18 segment PID number selection	Same as D7801 to D7805.
D7806 to D7810	TSP_L1_19 to S.PID_L2_19	Loop-1, segment-19 final target setpoint to Loop-2, segment-19 segment PID number selection	Same as D7801 to D7805.
D7806 to D7810	TSP_L1_20 to S.PID_L2_20	Loop-1, segment-20 final target setpoint to Loop-2, segment-20 segment PID number selection	Same as D7801 to D7805.

Note

Program pattern parameter cannot be written during program operation (RUN mode).
Setting the program pattern parameter can be available during STOP or HOLD mode operation.

12.4.11 Loop-1/Loop-2 Operation Parameter (D9001 to D10000) Group 9 to 20

Loop-1 operation parameter									
SP and alarm setpoint setting (Menu: SP)									
D-Reg No.	Ref. No.	H No.	Register symbol	R/W	D-Reg No.	Ref. No.	H No.	Register symbol	R/W
				UT75A					UT75A
D9001	49001	2328	SP_L1_9	R/W	D9051	49051	235A	PIDN_L1_12	R/W
D9002	49002	2329	SUB_9	R/W	D9052	49052	235B	A1_L1_12	R/W
D9003	49003	232A	PIDN_L1_9	R/W	D9053	49053	235C	A2_L1_12	R/W
D9004	49004	232B	A1_L1_9	R/W	D9054	49054	235D	A3_L1_12	R/W
D9005	49005	232C	A2_L1_9	R/W	D9055	49055	235E	A4_L1_12	R/W
D9006	49006	232D	A3_L1_9	R/W	D9056	49056	235F	A5_L1_12	R/W
D9007	49007	232E	A4_L1_9	R/W	D9057	49057	2360	A6_L1_12	R/W
D9008	49008	232F	A5_L1_9	R/W	D9058	49058	2361	A7_L1_12	R/W
D9009	49009	2330	A6_L1_9	R/W	D9059	49059	2362	A8_L1_12	R/W
D9010	49010	2331	A7_L1_9	R/W	D9060	49060	2363	UPR_L1_12	R/W
D9011	49011	2332	A8_L1_9	R/W	D9061	49061	2364	DNR_L1_12	R/W
D9012	49012	2333	UPR_L1_9	R/W	D9062	49062	2365		
D9013	49013	2334	DNR_L1_9	R/W	D9063	49063	2366		
D9014	49014	2335			D9064	49064	2367		
D9015	49015	2336			D9065	49065	2368	SP_L1_13	R/W
D9016	49016	2337			D9066	49066	2369	SUB_13	R/W
D9017	49017	2338	SP_L1_10	R/W	D9067	49067	236A	PIDN_L1_13	R/W
D9018	49018	2339	SUB_10	R/W	D9068	49068	236B	A1_L1_13	R/W
D9019	49019	233A	PIDN_L1_10	R/W	D9069	49069	236C	A2_L1_13	R/W
D9020	49020	233B	A1_L1_10	R/W	D9070	49070	236D	A3_L1_13	R/W
D9021	49021	233C	A2_L1_10	R/W	D9071	49071	236E	A4_L1_13	R/W
D9022	49022	233D	A3_L1_10	R/W	D9072	49072	236F	A5_L1_13	R/W
D9023	49023	233E	A4_L1_10	R/W	D9073	49073	2370	A6_L1_13	R/W
D9024	49024	233F	A5_L1_10	R/W	D9074	49074	2371	A7_L1_13	R/W
D9025	49025	2340	A6_L1_10	R/W	D9075	49075	2372	A8_L1_13	R/W
D9026	49026	2341	A7_L1_10	R/W	D9076	49076	2373	UPR_L1_13	R/W
D9027	49027	2342	A8_L1_10	R/W	D9077	49077	2374	DNR_L1_13	R/W
D9028	49028	2343	UPR_L1_10	R/W	D9078	49078	2375		
D9029	49029	2344	DNR_L1_10	R/W	D9079	49079	2376		
D9030	49030	2345			D9080	49080	2377		
D9031	49031	2346			D9081	49081	2378	SP_L1_14	R/W
D9032	49032	2347			D9082	49082	2379	SUB_14	R/W
D9033	49033	2348	SP_L1_11	R/W	D9083	49083	237A	PIDN_L1_14	R/W
D9034	49034	2349	SUB_11	R/W	D9084	49084	237B	A1_L1_14	R/W
D9035	49035	234A	PIDN_L1_11	R/W	D9085	49085	237C	A2_L1_14	R/W
D9036	49036	234B	A1_L1_11	R/W	D9086	49086	237D	A3_L1_14	R/W
D9037	49037	234C	A2_L1_11	R/W	D9087	49087	237E	A4_L1_14	R/W
D9038	49038	234D	A3_L1_11	R/W	D9088	49088	237F	A5_L1_14	R/W
D9039	49039	234E	A4_L1_11	R/W	D9089	49089	2380	A6_L1_14	R/W
D9040	49040	234F	A5_L1_11	R/W	D9090	49090	2381	A7_L1_14	R/W
D9041	49041	2350	A6_L1_11	R/W	D9091	49091	2382	A8_L1_14	R/W
D9042	49042	2351	A7_L1_11	R/W	D9092	49092	2383	UPR_L1_14	R/W
D9043	49043	2352	A8_L1_11	R/W	D9093	49093	2384	DNR_L1_14	R/W
D9044	49044	2353	UPR_L1_11	R/W	D9094	49094	2385		
D9045	49045	2354	DNR_L1_11	R/W	D9095	49095	2386		
D9046	49046	2355			D9096	49096	2387		
D9047	49047	2356			D9097	49097	2388		
D9048	49048	2357			D9098	49098	2389		
D9049	49049	2358	SP_L1_12	R/W	D9099	49099	238A		
D9050	49050	2359	SUB_12	R/W	D9100	49100	238B		

Loop-1 operation parameter									
SP and alarm setpoint setting (Menu: SP)									
D-Reg No.	Ref. No.	H No.	Register symbol	R/W	D-Reg No.	Ref. No.	H No.	Register symbol	R/W
				UT75A					UT75A
D9101	49101	238C	SP_L1_15	R/W	D9151	49151	23BE	PIDN_L1_18	R/W
D9102	49102	238D	SUB_15	R/W	D9152	49152	23BF	A1_L1_18	R/W
D9103	49103	238E	PIDN_L1_15	R/W	D9153	49153	23C0	A2_L1_18	R/W
D9104	49104	238F	A1_L1_15	R/W	D9154	49154	23C1	A3_L1_18	R/W
D9105	49105	2390	A2_L1_15	R/W	D9155	49155	23C2	A4_L1_18	R/W
D9106	49106	2391	A3_L1_15	R/W	D9156	49156	23C3	A5_L1_18	R/W
D9107	49107	2392	A4_L1_15	R/W	D9157	49157	23C4	A6_L1_18	R/W
D9108	49108	2393	A5_L1_15	R/W	D9158	49158	23C5	A7_L1_18	R/W
D9109	49109	2394	A6_L1_15	R/W	D9159	49159	23C6	A8_L1_18	R/W
D9110	49110	2395	A7_L1_15	R/W	D9160	49160	23C7	UPR_L1_18	R/W
D9111	49111	2396	A8_L1_15	R/W	D9161	49161	23C8	DNR_L1_18	R/W
D9112	49112	2397	UPR_L1_15	R/W	D9162	49162	23C9		
D9113	49113	2398	DNR_L1_15	R/W	D9163	49163	23CA		
D9114	49114	2399			D9164	49164	23CB		
D9115	49115	239A			D9165	49165	23CC	SP_L1_19	R/W
D9116	49116	239B			D9166	49166	23CD	SUB_19	R/W
D9117	49117	239C	SP_L1_16	R/W	D9167	49167	23CE	PIDN_L1_19	R/W
D9118	49118	239D	SUB_16	R/W	D9168	49168	23CF	A1_L1_19	R/W
D9119	49119	239E	PIDN_L1_16	R/W	D9169	49169	23D0	A2_L1_19	R/W
D9120	49120	239F	A1_L1_16	R/W	D9170	49170	23D1	A3_L1_19	R/W
D9121	49121	23A0	A2_L1_16	R/W	D9171	49171	23D2	A4_L1_19	R/W
D9122	49122	23A1	A3_L1_16	R/W	D9172	49172	23D3	A5_L1_19	R/W
D9123	49123	23A2	A4_L1_16	R/W	D9173	49173	23D4	A6_L1_19	R/W
D9124	49124	23A3	A5_L1_16	R/W	D9174	49174	23D5	A7_L1_19	R/W
D9125	49125	23A4	A6_L1_16	R/W	D9175	49175	23D6	A8_L1_19	R/W
D9126	49126	23A5	A7_L1_16	R/W	D9176	49176	23D7	UPR_L1_19	R/W
D9127	49127	23A6	A8_L1_16	R/W	D9177	49177	23D8	DNR_L1_19	R/W
D9128	49128	23A7	UPR_L1_16	R/W	D9178	49178	23D9		
D9129	49129	23A8	DNR_L1_16	R/W	D9179	49179	23DA		
D9130	49130	23A9			D9180	49180	23DB		
D9131	49131	23AA			D9181	49181	23DC	SP_L1_20	R/W
D9132	49132	23AB			D9182	49182	23DD	SUB_20	R/W
D9133	49133	23AC	SP_L1_17	R/W	D9183	49183	23DE	PIDN_L1_20	R/W
D9134	49134	23AD	SUB_17	R/W	D9184	49184	23DF	A1_L1_20	R/W
D9135	49135	23AE	PIDN_L1_17	R/W	D9185	49185	23E0	A2_L1_20	R/W
D9136	49136	23AF	A1_L1_17	R/W	D9186	49186	23E1	A3_L1_20	R/W
D9137	49137	23B0	A2_L1_17	R/W	D9187	49187	23E2	A4_L1_20	R/W
D9138	49138	23B1	A3_L1_17	R/W	D9188	49188	23E3	A5_L1_20	R/W
D9139	49139	23B2	A4_L1_17	R/W	D9189	49189	23E4	A6_L1_20	R/W
D9140	49140	23B3	A5_L1_17	R/W	D9190	49190	23E5	A7_L1_20	R/W
D9141	49141	23B4	A6_L1_17	R/W	D9191	49191	23E6	A8_L1_20	R/W
D9142	49142	23B5	A7_L1_17	R/W	D9192	49192	23E7	UPR_L1_20	R/W
D9143	49143	23B6	A8_L1_17	R/W	D9193	49193	23E8	DNR_L1_20	R/W
D9144	49144	23B7	UPR_L1_17	R/W	D9194	49194	23E9		
D9145	49145	23B8	DNR_L1_17	R/W	D9195	49195	23EA		
D9146	49146	23B9			D9196	49196	23EB		
D9147	49147	23BA			D9197	49197	23EC		
D9148	49148	23BB			D9198	49198	23ED		
D9149	49149	23BC	SP_L1_18	R/W	D9199	49199	23EE		
D9150	49150	23BD	SUB_18	R/W	D9200	49200	23EF		

14.4 UT75A D Registers

Loop-1 operation parameter									
PID setting (Menu: PID)									
D-Reg No.	Ref. No.	H No.	Register symbol	R/W	D-Reg No.	Ref. No.	H No.	Register symbol	R/W
				UT75A					UT75A
D9201	49201	23F0	P_L1_9	R/W	D9251	49251	2422	SU.PO_L1_10	R/W
D9202	49202	23F1	I_L1_9	R/W	D9252	49252	2423	POc_L1_10	R/W
D9203	49203	23F2	D_L1_9	R/W	D9253	49253	2424		
D9204	49204	23F3	OH_L1_9	R/W	D9254	49254	2425		
D9205	49205	23F4	OL_L1_9	R/W	D9255	49255	2426		
D9206	49206	23F5	MR_L1_9	R/W	D9256	49256	2427		
D9207	49207	23F6	HYS_L1_9	R/W	D9257	49257	2428		
D9208	49208	23F7	SU.HY_L1_9	R/W	D9258	49258	2429		
D9209	49209	23F8	HY.UP_L1_9	R/W	D9259	49259	242A		
D9210	49210	23F9	HY.LO_L1_9	R/W	D9260	49260	242B		
D9211	49211	23FA	DR_L1_9	R/W	D9261	49261	242C	P_L1_11	R/W
D9212	49212	23FB	SU.DR_L1_9	R/W	D9262	49262	242D	I_L1_11	R/W
D9213	49213	23FC	Pc_L1_9	R/W	D9263	49263	242E	D_L1_11	R/W
D9214	49214	23FD	Ic_L1_9	R/W	D9264	49264	242F	OH_L1_11	R/W
D9215	49215	23FE	Dc_L1_9	R/W	D9265	49265	2430	OL_L1_11	R/W
D9216	49216	23FF	OHc_L1_9	R/W	D9266	49266	2431	MR_L1_11	R/W
D9217	49217	2400	OLc_L1_9	R/W	D9267	49267	2432	HYS_L1_11	R/W
D9218	49218	2401	HYS_L1_9	R/W	D9268	49268	2433	SU.HY_L1_11	R/W
D9219	49219	2402	DB_L1_9	R/W	D9269	49269	2434	HY.UP_L1_11	R/W
D9220	49220	2403	PO_L1_9	R/W	D9270	49270	2435	HY.LO_L1_11	R/W
D9221	49221	2404	SU.PO_L1_9	R/W	D9271	49271	2436	DR_L1_11	R/W
D9222	49222	2405	POc_L1_9	R/W	D9272	49272	2437	SU.DR_L1_11	R/W
D9223	49223	2406			D9273	49273	2438	Pc_L1_11	R/W
D9224	49224	2407			D9274	49274	2439	Ic_L1_11	R/W
D9225	49225	2408			D9275	49275	243A	Dc_L1_11	R/W
D9226	49226	2409			D9276	49276	243B	OHc_L1_11	R/W
D9227	49227	240A			D9277	49277	243C	OLc_L1_11	R/W
D9228	49228	240B			D9278	49278	243D	HYS_L1_11	R/W
D9229	49229	240C			D9279	49279	243E	DB_L1_11	R/W
D9230	49230	240D			D9280	49280	243F	PO_L1_11	R/W
D9231	49231	240E	P_L1_10	R/W	D9281	49281	2440	SU.PO_L1_11	R/W
D9232	49232	240F	I_L1_10	R/W	D9282	49282	2441	POc_L1_11	R/W
D9233	49233	2410	D_L1_10	R/W	D9283	49283	2442		
D9234	49234	2411	OH_L1_10	R/W	D9284	49284	2443		
D9235	49235	2412	OL_L1_10	R/W	D9285	49285	2444		
D9236	49236	2413	MR_L1_10	R/W	D9286	49286	2445		
D9237	49237	2414	HYS_L1_10	R/W	D9287	49287	2446		
D9238	49238	2415	SU.HY_L1_10	R/W	D9288	49288	2447		
D9239	49239	2416	HY.UP_L1_10	R/W	D9289	49289	2448		
D9240	49240	2417	HY.LO_L1_10	R/W	D9290	49290	2449		
D9241	49241	2418	DR_L1_10	R/W	D9291	49291	244A		
D9242	49242	2419	SU.DR_L1_10	R/W	D9292	49292	244B		
D9243	49243	241A	Pc_L1_10	R/W	D9293	49293	244C		
D9244	49244	241B	Ic_L1_10	R/W	D9294	49294	244D		
D9245	49245	241C	Dc_L1_10	R/W	D9295	49295	244E		
D9246	49246	241D	OHc_L1_10	R/W	D9296	49296	244F		
D9247	49247	241E	OLc_L1_10	R/W	D9297	49297	2450		
D9248	49248	241F	HYS_L1_10	R/W	D9298	49298	2451		
D9249	49249	2420	DB_L1_10	R/W	D9299	49299	2452		
D9250	49250	2421	PO_L1_10	R/W	D9300	49300	2453		

Loop-1 operation parameter									
PID setting (Menu: PID)									
D-Reg No.	Ref. No.	H No.	Register symbol	R/W	D-Reg No.	Ref. No.	H No.	Register symbol	R/W
				UT75A					UT75A
D9301	49301	2454	P_L1_12	R/W	D9351	49351	2486	SU.PO_L1_13	R/W
D9302	49302	2455	I_L1_12	R/W	D9352	49352	2487	POc_L1_13	R/W
D9303	49303	2456	D_L1_12	R/W	D9353	49353	2488		
D9304	49304	2457	OH_L1_12	R/W	D9354	49354	2489		
D9305	49305	2458	OL_L1_12	R/W	D9355	49355	248A		
D9306	49306	2459	MR_L1_12	R/W	D9356	49356	248B		
D9307	49307	245A	HYS_L1_12	R/W	D9357	49357	248C		
D9308	49308	245B	SU.HY_L1_12	R/W	D9358	49358	248D		
D9309	49309	245C	HY.UP_L1_12	R/W	D9359	49359	248E		
D9310	49310	245D	HY.LO_L1_12	R/W	D9360	49360	248F		
D9311	49311	245E	DR_L1_12	R/W	D9361	49361	2490	P_L1_14	R/W
D9312	49312	245F	SU.DR_L1_12	R/W	D9362	49362	2491	I_L1_14	R/W
D9313	49313	2460	Pc_L1_12	R/W	D9363	49363	2492	D_L1_14	R/W
D9314	49314	2461	Ic_L1_12	R/W	D9364	49364	2493	OH_L1_14	R/W
D9315	49315	2462	Dc_L1_12	R/W	D9365	49365	2494	OL_L1_14	R/W
D9316	49316	2463	OHc_L1_12	R/W	D9366	49366	2495	MR_L1_14	R/W
D9317	49317	2464	OLc_L1_12	R/W	D9367	49367	2496	HYS_L1_14	R/W
D9318	49318	2465	HYSc_L1_12	R/W	D9368	49368	2497	SU.HY_L1_14	R/W
D9319	49319	2466	DB_L1_12	R/W	D9369	49369	2498	HY.UP_L1_14	R/W
D9320	49320	2467	PO_L1_12	R/W	D9370	49370	2499	HY.LO_L1_14	R/W
D9321	49321	2468	SU.PO_L1_12	R/W	D9371	49371	249A	DR_L1_14	R/W
D9322	49322	2469	POc_L1_12	R/W	D9372	49372	249B	SU.DR_L1_14	R/W
D9323	49323	246A			D9373	49373	249C	Pc_L1_14	R/W
D9324	49324	246B			D9374	49374	249D	Ic_L1_14	R/W
D9325	49325	246C			D9375	49375	249E	Dc_L1_14	R/W
D9326	49326	246D			D9376	49376	249F	OHc_L1_14	R/W
D9327	49327	246E			D9377	49377	24A0	OLc_L1_14	R/W
D9328	49328	246F			D9378	49378	24A1	HYSc_L1_14	R/W
D9329	49329	2470			D9379	49379	24A2	DB_L1_14	R/W
D9330	49330	2471			D9380	49380	24A3	PO_L1_14	R/W
D9331	49331	2472	P_L1_13	R/W	D9381	49381	24A4	SU.PO_L1_14	R/W
D9332	49332	2473	I_L1_13	R/W	D9382	49382	24A5	POc_L1_14	R/W
D9333	49333	2474	D_L1_13	R/W	D9383	49383	24A6		
D9334	49334	2475	OH_L1_13	R/W	D9384	49384	24A7		
D9335	49335	2476	OL_L1_13	R/W	D9385	49385	24A8		
D9336	49336	2477	MR_L1_13	R/W	D9386	49386	24A9		
D9337	49337	2478	HYS_L1_13	R/W	D9387	49387	24AA		
D9338	49338	2479	SU.HY_L1_13	R/W	D9388	49388	24AB		
D9339	49339	247A	HY.UP_L1_13	R/W	D9389	49389	24AC		
D9340	49340	247B	HY.LO_L1_13	R/W	D9390	49390	24AD		
D9341	49341	247C	DR_L1_13	R/W	D9391	49391	24AE		
D9342	49342	247D	SU.DR_L1_13	R/W	D9392	49392	24AF		
D9343	49343	247E	Pc_L1_13	R/W	D9393	49393	24B0		
D9344	49344	247F	Ic_L1_13	R/W	D9394	49394	24B1		
D9345	49345	2480	Dc_L1_13	R/W	D9395	49395	24B2		
D9346	49346	2481	OHc_L1_13	R/W	D9396	49396	24B3		
D9347	49347	2482	OLc_L1_13	R/W	D9397	49397	24B4		
D9348	49348	2483	HYSc_L1_13	R/W	D9398	49398	24B5		
D9349	49349	2484	DB_L1_13	R/W	D9399	49399	24B6		
D9350	49350	2485	PO_L1_13	R/W	D9400	49400	24B7		

14.4 UT75A D Registers

Loop-1 operation parameter									
PID setting (Menu: PID)									
D-Reg No.	Ref. No.	H No.	Register symbol	R/W	D-Reg No.	Ref. No.	H No.	Register symbol	R/W
				UT75A					UT75A
D9401	49401	24B8	P_L1_15	R/W	D9451	49451	24EA	SU.PO_L1_16	R/W
D9402	49402	24B9	I_L1_15	R/W	D9452	49452	24EB	POc_L1_16	R/W
D9403	49403	24BA	D_L1_15	R/W	D9453	49453	24EC		
D9404	49404	24BB	OH_L1_15	R/W	D9454	49454	24ED		
D9405	49405	24BC	OL_L1_15	R/W	D9455	49455	24EE		
D9406	49406	24BD	MR_L1_15	R/W	D9456	49456	24EF		
D9407	49407	24BE	HYS_L1_15	R/W	D9457	49457	24F0		
D9408	49408	24BF	SU.HY_L1_15	R/W	D9458	49458	24F1		
D9409	49409	24C0	HY.UP_L1_15	R/W	D9459	49459	24F2		
D9410	49410	24C1	HY.LO_L1_15	R/W	D9460	49460	24F3		
D9411	49411	24C2	DR_L1_15	R/W	D9461	49461	24F4		
D9412	49412	24C3	SU.DR_L1_15	R/W	D9462	49462	24F5		
D9413	49413	24C4	Pc_L1_15	R/W	D9463	49463	24F6		
D9414	49414	24C5	Ic_L1_15	R/W	D9464	49464	24F7		
D9415	49415	24C6	Dc_L1_15	R/W	D9465	49465	24F8		
D9416	49416	24C7	OHc_L1_15	R/W	D9466	49466	24F9		
D9417	49417	24C8	OLc_L1_15	R/W	D9467	49467	24FA		
D9418	49418	24C9	HYSc_L1_15	R/W	D9468	49468	24FB		
D9419	49419	24CA	DB_L1_15	R/W	D9469	49469	24FC		
D9420	49420	24CB	PO_L1_15	R/W	D9470	49470	24FD		
D9421	49421	24CC	SU.PO_L1_15	R/W	D9471	49471	24FE		
D9422	49422	24CD	POc_L1_15	R/W	D9472	49472	24FF		
D9423	49423	24CE			D9473	49473	2500		
D9424	49424	24CF			D9474	49474	2501		
D9425	49425	24D0			D9475	49475	2502		
D9426	49426	24D1			D9476	49476	2503		
D9427	49427	24D2			D9477	49477	2504		
D9428	49428	24D3			D9478	49478	2505		
D9429	49429	24D4			D9479	49479	2506		
D9430	49430	24D5			D9480	49480	2507		
D9431	49431	24D6	P_L1_16	R/W	D9481	49481	2508		
D9432	49432	24D7	I_L1_16	R/W	D9482	49482	2509		
D9433	49433	24D8	D_L1_16	R/W	D9483	49483	250A		
D9434	49434	24D9	OH_L1_16	R/W	D9484	49484	250B		
D9435	49435	24DA	OL_L1_16	R/W	D9485	49485	250C		
D9436	49436	24DB	MR_L1_16	R/W	D9486	49486	250D		
D9437	49437	24DC	HYS_L1_16	R/W	D9487	49487	250E		
D9438	49438	24DD	SU.HY_L1_16	R/W	D9488	49488	250F		
D9439	49439	24DE	HY.UP_L1_16	R/W	D9489	49489	2510		
D9440	49440	24DF	HY.LO_L1_16	R/W	D9490	49490	2511		
D9441	49441	24E0	DR_L1_16	R/W	D9491	49491	2512		
D9442	49442	24E1	SU.DR_L1_16	R/W	D9492	49492	2513		
D9443	49443	24E2	Pc_L1_16	R/W	D9493	49493	2514		
D9444	49444	24E3	Ic_L1_16	R/W	D9494	49494	2515		
D9445	49445	24E4	Dc_L1_16	R/W	D9495	49495	2516		
D9446	49446	24E5	OHc_L1_16	R/W	D9496	49496	2517		
D9447	49447	24E6	OLc_L1_16	R/W	D9497	49497	2518		
D9448	49448	24E7	HYSc_L1_16	R/W	D9498	49498	2519		
D9449	49449	24E8	DB_L1_16	R/W	D9499	49499	251A		
D9450	49450	24E9	PO_L1_16	R/W	D9500	49500	251B		

Loop-2 operation parameter									
SP and alarm setpoint setting (Menu: SP)									
D-Reg No.	Ref. No.	H No.	Register symbol	R/W	D-Reg No.	Ref. No.	H No.	Register symbol	R/W
				UT75A					UT75A
D9501	49501	251C	SP_L2_9	R/W	D9551	49551	254E	PIDN_L2_12	R/W
D9502	49502	251D			D9552	49552	254F	A1_L2_12	R/W
D9503	49503	251E	PIDN_L2_9	R/W	D9553	49553	2550	A2_L2_12	R/W
D9504	49504	251F	A1_L2_9	R/W	D9554	49554	2551	A3_L2_12	R/W
D9505	49505	2520	A2_L2_9	R/W	D9555	49555	2552	A4_L2_12	R/W
D9506	49506	2521	A3_L2_9	R/W	D9556	49556	2553	A5_L2_12	R/W
D9507	49507	2522	A4_L2_9	R/W	D9557	49557	2554	A6_L2_12	R/W
D9508	49508	2523	A5_L2_9	R/W	D9558	49558	2555	A7_L2_12	R/W
D9509	49509	2524	A6_L2_9	R/W	D9559	49559	2556	A8_L2_12	R/W
D9510	49510	2525	A7_L2_9	R/W	D9560	49560	2557	UPR_L2_12	R/W
D9511	49511	2526	A8_L2_9	R/W	D9561	49561	2558	DNR_L2_12	R/W
D9512	49512	2527	UPR_L2_9	R/W	D9562	49562	2559		
D9513	49513	2528	DNR_L2_9	R/W	D9563	49563	255A		
D9514	49514	2529			D9564	49564	255B		
D9515	49515	252A			D9565	49565	255C	SP_L2_13	R/W
D9516	49516	252B			D9566	49566	255D		
D9517	49517	252C	SP_L2_10	R/W	D9567	49567	255E	PIDN_L2_13	R/W
D9518	49518	252D			D9568	49568	255F	A1_L2_13	R/W
D9519	49519	252E	PIDN_L2_10	R/W	D9569	49569	2560	A2_L2_13	R/W
D9520	49520	252F	A1_L2_10	R/W	D9570	49570	2561	A3_L2_13	R/W
D9521	49521	2530	A2_L2_10	R/W	D9571	49571	2562	A4_L2_13	R/W
D9522	49522	2531	A3_L2_10	R/W	D9572	49572	2563	A5_L2_13	R/W
D9523	49523	2532	A4_L2_10	R/W	D9573	49573	2564	A6_L2_13	R/W
D9524	49524	2533	A5_L2_10	R/W	D9574	49574	2565	A7_L2_13	R/W
D9525	49525	2534	A6_L2_10	R/W	D9575	49575	2566	A8_L2_13	R/W
D9526	49526	2535	A7_L2_10	R/W	D9576	49576	2567	UPR_L2_13	R/W
D9527	49527	2536	A8_L2_10	R/W	D9577	49577	2568	DNR_L2_13	R/W
D9528	49528	2537	UPR_L2_10	R/W	D9578	49578	2569		
D9529	49529	2538	DNR_L2_10	R/W	D9579	49579	256A		
D9530	49530	2539			D9580	49580	256B		
D9531	49531	253A			D9581	49581	256C	SP_L2_14	R/W
D9532	49532	253B			D9582	49582	256D		
D9533	49533	253C	SP_L2_11	R/W	D9583	49583	256E	PIDN_L2_14	R/W
D9534	49534	253D			D9584	49584	256F	A1_L2_14	R/W
D9535	49535	253E	PIDN_L2_11	R/W	D9585	49585	2570	A2_L2_14	R/W
D9536	49536	253F	A1_L2_11	R/W	D9586	49586	2571	A3_L2_14	R/W
D9537	49537	2540	A2_L2_11	R/W	D9587	49587	2572	A4_L2_14	R/W
D9538	49538	2541	A3_L2_11	R/W	D9588	49588	2573	A5_L2_14	R/W
D9539	49539	2542	A4_L2_11	R/W	D9589	49589	2574	A6_L2_14	R/W
D9540	49540	2543	A5_L2_11	R/W	D9590	49590	2575	A7_L2_14	R/W
D9541	49541	2544	A6_L2_11	R/W	D9591	49591	2576	A8_L2_14	R/W
D9542	49542	2545	A7_L2_11	R/W	D9592	49592	2577	UPR_L2_14	R/W
D9543	49543	2546	A8_L2_11	R/W	D9593	49593	2578	DNR_L2_14	R/W
D9544	49544	2547	UPR_L2_11	R/W	D9594	49594	2579		
D9545	49545	2548	DNR_L2_11	R/W	D9595	49595	257A		
D9546	49546	2549			D9596	49596	257B		
D9547	49547	254A			D9597	49597	257C		
D9548	49548	254B			D9598	49598	257D		
D9549	49549	254C	SP_L2_12	R/W	D9599	49599	257E		
D9550	49550	254D			D9600	49600	257F		

14.4 UT75A D Registers

Loop-2 operation parameter									
SP and alarm setpoint setting (Menu: SP)									
D-Reg No.	Ref. No.	H No.	Register symbol	R/W	D-Reg No.	Ref. No.	H No.	Register symbol	R/W
				UT75A					UT75A
D9601	49601	2580	SP_L2_15	R/W	D9651	49651	25B2	PIDN_L2_18	R/W
D9602	49602	2581			D9652	49652	25B3	A1_L2_18	R/W
D9603	49603	2582	PIDN_L2_15	R/W	D9653	49653	25B4	A2_L2_18	R/W
D9604	49604	2583	A1_L2_15	R/W	D9654	49654	25B5	A3_L2_18	R/W
D9605	49605	2584	A2_L2_15	R/W	D9655	49655	25B6	A4_L2_18	R/W
D9606	49606	2585	A3_L2_15	R/W	D9656	49656	25B7	A5_L2_18	R/W
D9607	49607	2586	A4_L2_15	R/W	D9657	49657	25B8	A6_L2_18	R/W
D9608	49608	2587	A5_L2_15	R/W	D9658	49658	25B9	A7_L2_18	R/W
D9609	49609	2588	A6_L2_15	R/W	D9659	49659	25BA	A8_L2_18	R/W
D9610	49610	2589	A7_L2_15	R/W	D9660	49660	25BB	UPR_L2_18	R/W
D9611	49611	258A	A8_L2_15	R/W	D9661	49661	25BC	DNR_L2_18	R/W
D9612	49612	258B	UPR_L2_15	R/W	D9662	49662	25BD		
D9613	49613	258C	DNR_L2_15	R/W	D9663	49663	25BE		
D9614	49614	258D			D9664	49664	25BF		
D9615	49615	258E			D9665	49665	25C0	SP_L2_19	R/W
D9616	49616	258F			D9666	49666	25C1		
D9617	49617	2590	SP_L2_16	R/W	D9667	49667	25C2	PIDN_L2_19	R/W
D9618	49618	2591			D9668	49668	25C3	A1_L2_19	R/W
D9619	49619	2592	PIDN_L2_16	R/W	D9669	49669	25C4	A2_L2_19	R/W
D9620	49620	2593	A1_L2_16	R/W	D9670	49670	25C5	A3_L2_19	R/W
D9621	49621	2594	A2_L2_16	R/W	D9671	49671	25C6	A4_L2_19	R/W
D9622	49622	2595	A3_L2_16	R/W	D9672	49672	25C7	A5_L2_19	R/W
D9623	49623	2596	A4_L2_16	R/W	D9673	49673	25C8	A6_L2_19	R/W
D9624	49624	2597	A5_L2_16	R/W	D9674	49674	25C9	A7_L2_19	R/W
D9625	49625	2598	A6_L2_16	R/W	D9675	49675	25CA	A8_L2_19	R/W
D9626	49626	2599	A7_L2_16	R/W	D9676	49676	25CB	UPR_L2_19	R/W
D9627	49627	259A	A8_L2_16	R/W	D9677	49677	25CC	DNR_L2_19	R/W
D9628	49628	259B	UPR_L2_16	R/W	D9678	49678	25CD		
D9629	49629	259C	DNR_L2_16	R/W	D9679	49679	25CE		
D9630	49630	259D			D9680	49680	25CF		
D9631	49631	259E			D9681	49681	25D0	SP_L2_20	R/W
D9632	49632	259F			D9682	49682	25D1		
D9633	49633	25A0	SP_L2_17	R/W	D9683	49683	25D2	PIDN_L2_20	R/W
D9634	49634	25A1			D9684	49684	25D3	A1_L2_20	R/W
D9635	49635	25A2	PIDN_L2_17	R/W	D9685	49685	25D4	A2_L2_20	R/W
D9636	49636	25A3	A1_L2_17	R/W	D9686	49686	25D5	A3_L2_20	R/W
D9637	49637	25A4	A2_L2_17	R/W	D9687	49687	25D6	A4_L2_20	R/W
D9638	49638	25A5	A3_L2_17	R/W	D9688	49688	25D7	A5_L2_20	R/W
D9639	49639	25A6	A4_L2_17	R/W	D9689	49689	25D8	A6_L2_20	R/W
D9640	49640	25A7	A5_L2_17	R/W	D9690	49690	25D9	A7_L2_20	R/W
D9641	49641	25A8	A6_L2_17	R/W	D9691	49691	25DA	A8_L2_20	R/W
D9642	49642	25A9	A7_L2_17	R/W	D9692	49692	25DB	UPR_L2_20	R/W
D9643	49643	25AA	A8_L2_17	R/W	D9693	49693	25DC	DNR_L2_20	R/W
D9644	49644	25AB	UPR_L2_17	R/W	D9694	49694	25DD		
D9645	49645	25AC	DNR_L2_17	R/W	D9695	49695	25DE		
D9646	49646	25AD			D9696	49696	25DF		
D9647	49647	25AE			D9697	49697	25E0		
D9648	49648	25AF			D9698	49698	25E1		
D9649	49649	25B0	SP_L2_18	R/W	D9699	49699	25E2		
D9650	49650	25B1			D9700	49700	25E3		

Loop-2 operation parameter									
PID setting (Menu: PID)									
D-Reg No.	Ref. No.	H No.	Register symbol	R/W	D-Reg No.	Ref. No.	H No.	Register symbol	R/W
				UT75A					UT75A
D9701	49701	25E4	P_L2_9	R/W	D9751	49751	2616		
D9702	49702	25E5	I_L2_9	R/W	D9752	49752	2617	POc_L2_10	R/W
D9703	49703	25E6	D_L2_9	R/W	D9753	49753	2618		
D9704	49704	25E7	OH_L2_9	R/W	D9754	49754	2619		
D9705	49705	25E8	OL_L2_9	R/W	D9755	49755	261A		
D9706	49706	25E9	MR_L2_9	R/W	D9756	49756	261B		
D9707	49707	25EA	HYS_L2_9	R/W	D9757	49757	261C		
D9708	49708	25EB			D9758	49758	261D		
D9709	49709	25EC	HY.UP_L2_9	R/W	D9759	49759	261E		
D9710	49710	25ED	HY.LO_L2_9	R/W	D9760	49760	261F		
D9711	49711	25EE	DR_L2_9	R/W	D9761	49761	2620	P_L2_11	R/W
D9712	49712	25EF			D9762	49762	2621	I_L2_11	R/W
D9713	49713	25F0	Pc_L2_9	R/W	D9763	49763	2622	D_L2_11	R/W
D9714	49714	25F1	Ic_L2_9	R/W	D9764	49764	2623	OH_L2_11	R/W
D9715	49715	25F2	Dc_L2_9	R/W	D9765	49765	2624	OL_L2_11	R/W
D9716	49716	25F3	OHc_L2_9	R/W	D9766	49766	2625	MR_L2_11	R/W
D9717	49717	25F4	OLc_L2_9	R/W	D9767	49767	2626	HYS_L2_11	R/W
D9718	49718	25F5	HYS_L2_9	R/W	D9768	49768	2627		
D9719	49719	25F6	DB_L2_9	R/W	D9769	49769	2628	HY.UP_L2_11	R/W
D9720	49720	25F7	PO_L2_9	R/W	D9770	49770	2629	HY.LO_L2_11	R/W
D9721	49721	25F8			D9771	49771	262A	DR_L2_11	R/W
D9722	49722	25F9	POc_L2_9	R/W	D9772	49772	262B		
D9723	49723	25FA			D9773	49773	262C	Pc_L2_11	R/W
D9724	49724	25FB			D9774	49774	262D	Ic_L2_11	R/W
D9725	49725	25FC			D9775	49775	262E	Dc_L2_11	R/W
D9726	49726	25FD			D9776	49776	262F	OHc_L2_11	R/W
D9727	49727	25FE			D9777	49777	2630	OLc_L2_11	R/W
D9728	49728	25FF			D9778	49778	2631	HYS_L2_11	R/W
D9729	49729	2600			D9779	49779	2632	DB_L2_11	R/W
D9730	49730	2601			D9780	49780	2633	PO_L2_11	R/W
D9731	49731	2602	P_L2_10	R/W	D9781	49781	2634		
D9732	49732	2603	I_L2_10	R/W	D9782	49782	2635	POc_L2_11	R/W
D9733	49733	2604	D_L2_10	R/W	D9783	49783	2636		
D9734	49734	2605	OH_L2_10	R/W	D9784	49784	2637		
D9735	49735	2606	OL_L2_10	R/W	D9785	49785	2638		
D9736	49736	2607	MR_L2_10	R/W	D9786	49786	2639		
D9737	49737	2608	HYS_L2_10	R/W	D9787	49787	263A		
D9738	49738	2609			D9788	49788	263B		
D9739	49739	260A	HY.UP_L2_10	R/W	D9789	49789	263C		
D9740	49740	260B	HY.LO_L2_10	R/W	D9790	49790	263D		
D9741	49741	260C	DR_L2_10	R/W	D9791	49791	263E		
D9742	49742	260D			D9792	49792	263F		
D9743	49743	260E	Pc_L2_10	R/W	D9793	49793	2640		
D9744	49744	260F	Ic_L2_10	R/W	D9794	49794	2641		
D9745	49745	2610	Dc_L2_10	R/W	D9795	49795	2642		
D9746	49746	2611	OHc_L2_10	R/W	D9796	49796	2643		
D9747	49747	2612	OLc_L2_10	R/W	D9797	49797	2644		
D9748	49748	2613	HYS_L2_10	R/W	D9798	49798	2645		
D9749	49749	2614	DB_L2_10	R/W	D9799	49799	2646		
D9750	49750	2615	PO_L2_10	R/W	D9800	49800	2647		

14.4 UT75A D Registers

Loop-2 operation parameter									
PID setting (Menu: PID)									
D-Reg No.	Ref. No.	H No.	Register symbol	R/W	D-Reg No.	Ref. No.	H No.	Register symbol	R/W
				UT75A					UT75A
D9801	49801	2648	P_L2_12	R/W	D9851	49851	267A		
D9802	49802	2649	I_L2_12	R/W	D9852	49852	267B	POc_L2_13	R/W
D9803	49803	264A	D_L2_12	R/W	D9853	49853	267C		
D9804	49804	264B	OH_L2_12	R/W	D9854	49854	267D		
D9805	49805	264C	OL_L2_12	R/W	D9855	49855	267E		
D9806	49806	264D	MR_L2_12	R/W	D9856	49856	267F		
D9807	49807	264E	HYS_L2_12	R/W	D9857	49857	2680		
D9808	49808	264F			D9858	49858	2681		
D9809	49809	2650	HY.UP_L2_12	R/W	D9859	49859	2682		
D9810	49810	2651	HY.LO_L2_12	R/W	D9860	49860	2683		
D9811	49811	2652	DR_L2_12	R/W	D9861	49861	2684	P_L2_14	R/W
D9812	49812	2653			D9862	49862	2685	I_L2_14	R/W
D9813	49813	2654	Pc_L2_12	R/W	D9863	49863	2686	D_L2_14	R/W
D9814	49814	2655	Ic_L2_12	R/W	D9864	49864	2687	OH_L2_14	R/W
D9815	49815	2656	Dc_L2_12	R/W	D9865	49865	2688	OL_L2_14	R/W
D9816	49816	2657	OHc_L2_12	R/W	D9866	49866	2689	MR_L2_14	R/W
D9817	49817	2658	OLc_L2_12	R/W	D9867	49867	268A	HYS_L2_14	R/W
D9818	49818	2659	HYSc_L2_12	R/W	D9868	49868	268B		
D9819	49819	265A	DB_L2_12	R/W	D9869	49869	268C	HY.UP_L2_14	R/W
D9820	49820	265B	PO_L2_12	R/W	D9870	49870	268D	HY.LO_L2_14	R/W
D9821	49821	265C			D9871	49871	268E	DR_L2_14	R/W
D9822	49822	265D	POc_L2_12	R/W	D9872	49872	268F		
D9823	49823	265E			D9873	49873	2690	Pc_L2_14	R/W
D9824	49824	265F			D9874	49874	2691	Ic_L2_14	R/W
D9825	49825	2660			D9875	49875	2692	Dc_L2_14	R/W
D9826	49826	2661			D9876	49876	2693	OHc_L2_14	R/W
D9827	49827	2662			D9877	49877	2694	OLc_L2_14	R/W
D9828	49828	2663			D9878	49878	2695	HYSc_L2_14	R/W
D9829	49829	2664			D9879	49879	2696	DB_L2_14	R/W
D9830	49830	2665			D9880	49880	2697	PO_L2_14	R/W
D9831	49831	2666	P_L2_13	R/W	D9881	49881	2698		
D9832	49832	2667	I_L2_13	R/W	D9882	49882	2699	POc_L2_14	R/W
D9833	49833	2668	D_L2_13	R/W	D9883	49883	269A		
D9834	49834	2669	OH_L2_13	R/W	D9884	49884	269B		
D9835	49835	266A	OL_L2_13	R/W	D9885	49885	269C		
D9836	49836	266B	MR_L2_13	R/W	D9886	49886	269D		
D9837	49837	266C	HYS_L2_13	R/W	D9887	49887	269E		
D9838	49838	266D			D9888	49888	269F		
D9839	49839	266E	HY.UP_L2_13	R/W	D9889	49889	26A0		
D9840	49840	266F	HY.LO_L2_13	R/W	D9890	49890	26A1		
D9841	49841	2670	DR_L2_13	R/W	D9891	49891	26A2		
D9842	49842	2671			D9892	49892	26A3		
D9843	49843	2672	Pc_L2_13	R/W	D9893	49893	26A4		
D9844	49844	2673	Ic_L2_13	R/W	D9894	49894	26A5		
D9845	49845	2674	Dc_L2_13	R/W	D9895	49895	26A6		
D9846	49846	2675	OHc_L2_13	R/W	D9896	49896	26A7		
D9847	49847	2676	OLc_L2_13	R/W	D9897	49897	26A8		
D9848	49848	2677	HYSc_L2_13	R/W	D9898	49898	26A9		
D9849	49849	2678	DB_L2_13	R/W	D9899	49899	26AA		
D9850	49850	2679	PO_L2_13	R/W	D9900	49900	26AB		

Loop-2 operation parameter									
PID setting (Menu: PID)									
D-Reg No.	Ref. No.	H No.	Register symbol	R/W	D-Reg No.	Ref. No.	H No.	Register symbol	R/W
				UT75A					UT75A
D9901	49901	26AC	P_L2_15	R/W	D9951	49951	26DE		
D9902	49902	26AD	I_L2_15	R/W	D9952	49952	26DF	POc_L2_16	R/W
D9903	49903	26AE	D_L2_15	R/W	D9953	49953	26E0		
D9904	49904	26AF	OH_L2_15	R/W	D9954	49954	26E1		
D9905	49905	26B0	OL_L2_15	R/W	D9955	49955	26E2		
D9906	49906	26B1	MR_L2_15	R/W	D9956	49956	26E3		
D9907	49907	26B2	HYS_L2_15	R/W	D9957	49957	26E4		
D9908	49908	26B3			D9958	49958	26E5		
D9909	49909	26B4	HY.UP_L2_15	R/W	D9959	49959	26E6		
D9910	49910	26B5	HY.LO_L2_15	R/W	D9960	49960	26E7		
D9911	49911	26B6	DR_L2_15	R/W	D9961	49961	26E8		
D9912	49912	26B7			D9962	49962	26E9		
D9913	49913	26B8	Pc_L2_15	R/W	D9963	49963	26EA		
D9914	49914	26B9	Ic_L2_15	R/W	D9964	49964	26EB		
D9915	49915	26BA	Dc_L2_15	R/W	D9965	49965	26EC		
D9916	49916	26BB	OHc_L2_15	R/W	D9966	49966	26ED		
D9917	49917	26BC	OLc_L2_15	R/W	D9967	49967	26EE		
D9918	49918	26BD	HYSc_L2_15	R/W	D9968	49968	26EF		
D9919	49919	26BE	DB_L2_15	R/W	D9969	49969	26F0		
D9920	49920	26BF	PO_L2_15	R/W	D9970	49970	26F1		
D9921	49921	26C0			D9971	49971	26F2		
D9922	49922	26C1	POc_L2_15	R/W	D9972	49972	26F3		
D9923	49923	26C2			D9973	49973	26F4		
D9924	49924	26C3			D9974	49974	26F5		
D9925	49925	26C4			D9975	49975	26F6		
D9926	49926	26C5			D9976	49976	26F7		
D9927	49927	26C6			D9977	49977	26F8		
D9928	49928	26C7			D9978	49978	26F9		
D9929	49929	26C8			D9979	49979	26FA		
D9930	49930	26C9			D9980	49980	26FB		
D9931	49931	26CA	P_L2_16	R/W	D9981	49981	26FC		
D9932	49932	26CB	I_L2_16	R/W	D9982	49982	26FD		
D9933	49933	26CC	D_L2_16	R/W	D9983	49983	26FE		
D9934	49934	26CD	OH_L2_16	R/W	D9984	49984	26FF		
D9935	49935	26CE	OL_L2_16	R/W	D9985	49985	2700		
D9936	49936	26CF	MR_L2_16	R/W	D9986	49986	2701		
D9937	49937	26D0	HYS_L2_16	R/W	D9987	49987	2702		
D9938	49938	26D1			D9988	49988	2703		
D9939	49939	26D2	HY.UP_L2_16	R/W	D9989	49989	2704		
D9940	49940	26D3	HY.LO_L2_16	R/W	D9990	49990	2705		
D9941	49941	26D4	DR_L2_16	R/W	D9991	49991	2706		
D9942	49942	26D5			D9992	49992	2707		
D9943	49943	26D6	Pc_L2_16	R/W	D9993	49993	2708		
D9944	49944	26D7	Ic_L2_16	R/W	D9994	49994	2709		
D9945	49945	26D8	Dc_L2_16	R/W	D9995	49995	270A		
D9946	49946	26D9	OHc_L2_16	R/W	D9996	49996	270B		
D9947	49947	26DA	OLc_L2_16	R/W	D9997	49997	270C		
D9948	49948	26DB	HYSc_L2_16	R/W	D9998	49998	270D		
D9949	49949	26DC	DB_L2_16	R/W	D9999	49999	270E		
D9950	49950	26DD	PO_L2_16	R/W	D10000	50000	270F		

14.4 UT75A D Registers

Loop-1 SP and Alarm Setpoint Setting, Group 9 to 20 (D9001 to D9200)

Register No.	Description	Range and meaning of value
D9001 to D9013	SP_L1_9 to DNR_L1_9 Target setpoint of group 9 to SP ramp-down rate of group 9	Same as D2501 to D2513.
D9014 to D9016		
D9017 to D9029	SP_L1_10 to DNR_L1_10 Target setpoint of group 10 to SP ramp-down rate of group 10	Same as D2501 to D2513.
D9030 to D9032		
D9033 to D9045	SP_L1_11 to DNR_L1_11 Target setpoint of group 11 to SP ramp-down rate of group 11	Same as D2501 to D2513.
D9046 to D9048		
D9049 to D9061	SP_L1_12 to DNR_L1_12 Target setpoint of group 12 to SP ramp-down rate of group 12	Same as D2501 to D2513.
D9062 to D9064		
D9065 to D9077	SP_L1_13 to DNR_L1_13 Target setpoint of group 13 to SP ramp-down rate of group 13	Same as D2501 to D2513.
D9078 to D9080		
D9081 to D9093	SP_L1_14 to DNR_L1_14 Target setpoint of group 14 to SP ramp-down rate of group 14	Same as D2501 to D2513.
D9094 to D9100		
D9101 to D9113	SP_L1_15 to DNR_L1_15 Target setpoint of group 15 to SP ramp-down rate of group 15	Same as D2501 to D2513.
D9114 to D9116		
D9117 to D9129	SP_L1_16 to DNR_L1_16 Target setpoint of group 16 to SP ramp-down rate of group 16	Same as D2501 to D2513.
D9130 to D9132		
D9133 to D9145	SP_L1_17 to DNR_L1_17 Target setpoint of group 17 to SP ramp-down rate of group 17	Same as D2501 to D2513.
D9146 to D9148		
D9149 to D9161	SP_L1_18 to DNR_L1_18 Target setpoint of group 18 to SP ramp-down rate of group 18	Same as D2501 to D2513.
D9162 to D9164		
D9165 to D9177	SP_L1_19 to DNR_L1_19 Target setpoint of group 19 to SP ramp-down rate of group 19	Same as D2501 to D2513.
D9178 to D9180		
D9181 to D9193	SP_L1_20 to DNR_L1_20 Target setpoint of group 20 to SP ramp-down rate of group 20	Same as D2501 to D2513.
D9194 to D9200		

Loop-1 PID Setting, Group 9 to 20 (D9201 to D9500)

Register No.		Description	Range and meaning of value
D9201 to D9222	P_L1_9 to POc_L1_9	Proportional band of group 9 to Cooling-side preset output of group 9	Same as D3002 to D3022.
D9223 to D9230			
D9231 to D9252	P_L1_10 to POc_L1_10	Proportional band of group 10 to Cooling-side preset output of group 10	Same as D3002 to D3022.
D9253 to D9260			
D9261 to D9282	P_L1_11 to POc_L1_11	Proportional band of group 11 to Cooling-side preset output of group 11	Same as D3002 to D3022.
D9283 to D9300			
D9301 to D9322	P_L1_12 to POc_L1_12	Proportional band of group 12 to Cooling-side preset output of group 12	Same as D3002 to D3022.
D9323 to D9330			
D9331 to D9352	P_L1_13 to POc_L1_13	Proportional band of group 13 to Cooling-side preset output of group 13	Same as D3002 to D3022.
D9353 to D9360			
D9361 to D9382	P_L1_14 to POc_L1_14	Proportional band of group 14 to Cooling-side preset output of group 14	Same as D3002 to D3022.
D9383 to D9400			
D9401 to D9422	P_L1_15 to POc_L1_15	Proportional band of group 15 to Cooling-side preset output of group 15	Same as D3002 to D3022.
D9423 to D9430			
D9431 to D9452	P_L1_16 to POc_L1_16	Proportional band of group 16 to Cooling-side preset output of group 16	Same as D3002 to D3022.
D9453 to D9500			

14.4 UT75A D Registers

Loop-2 SP and Alarm Setpoint Setting, Group 9 to 20 (D9501 to D9700)

Register No.	Description	Range and meaning of value
D9501 to D9513	SP_L2_9 to DNR_L2_9 Target setpoint of group 9 to SP ramp-down rate of group 9	Same as D2501 to D2513.
D9514 to D9516		
D9517 to D9529	SP_L2_10 to DNR_L2_10 Target setpoint of group 10 to SP ramp-down rate of group 10	Same as D2501 to D2513.
D9530 to D9532		
D9533 to D9545	SP_L2_11 to DNR_L2_11 Target setpoint of group 11 to SP ramp-down rate of group 11	Same as D2501 to D2513.
D9546 to D9548		
D9549 to D9561	SP_L2_12 to DNR_L2_12 Target setpoint of group 12 to SP ramp-down rate of group 12	Same as D2501 to D2513.
D9562 to D9564		
D9565 to D9577	SP_L2_13 to DNR_L2_13 Target setpoint of group 13 to SP ramp-down rate of group 13	Same as D2501 to D2513.
D9578 to D9580		
D9581 to D9593	SP_L2_14 to DNR_L2_14 Target setpoint of group 14 to SP ramp-down rate of group 14	Same as D2501 to D2513.
D9594 to D9600		
D9601 to D9613	SP_L2_15 to DNR_L2_15 Target setpoint of group 15 to SP ramp-down rate of group 15	Same as D2501 to D2513.
D9614 to D9616		
D9617 to D9629	SP_L2_16 to DNR_L2_16 Target setpoint of group 16 to SP ramp-down rate of group 16	Same as D2501 to D2513.
D9630 to D9632		
D9633 to D9645	SP_L2_17 to DNR_L2_17 Target setpoint of group 17 to SP ramp-down rate of group 17	Same as D2501 to D2513.
D9646 to D9648		
D9649 to D9661	SP_L2_18 to DNR_L2_18 Target setpoint of group 18 to SP ramp-down rate of group 18	Same as D2501 to D2513.
D9662 to D9664		
D9665 to D9677	SP_L2_19 to DNR_L2_19 Target setpoint of group 19 to SP ramp-down rate of group 19	Same as D2501 to D2513.
D9678 to D9680		
D9681 to D9693	SP_L2_20 to DNR_L2_20 Target setpoint of group 20 to SP ramp-down rate of group 20	Same as D2501 to D2513.
D9694 to D9700		

Loop-1 PID Setting, Group 9 to 20 (D9701 to D10000)

Register No.	Description	Range and meaning of value
D9701 to D9722	P_L1_9 to POc_L1_9 Proportional band of group 9 to Cooling-side preset output of group 9	Same as D3002 to D3022.
D9723 to D9730		
D9731 to D9752	P_L1_10 to POc_L1_10 Proportional band of group 10 to Cooling-side preset output of group 10	Same as D3002 to D3022.
D9753 to D9760		
D9761 to D9782	P_L1_11 to POc_L1_11 Proportional band of group 11 to Cooling-side preset output of group 11	Same as D3002 to D3022.
D9783 to D9800		
D9801 to D9822	P_L1_12 to POc_L1_12 Proportional band of group 12 to Cooling-side preset output of group 12	Same as D3002 to D3022.
D9823 to D9830		
D9831 to D9852	P_L1_13 to POc_L1_13 Proportional band of group 13 to Cooling-side preset output of group 13	Same as D3002 to D3022.
D9853 to D9860		
D9861 to D9882	P_L1_14 to POc_L1_14 Proportional band of group 14 to Cooling-side preset output of group 14	Same as D3002 to D3022.
D9883 to D9900		
D9901 to D9922	P_L1_15 to POc_L1_15 Proportional band of group 15 to Cooling-side preset output of group 15	Same as D3002 to D3022.
D9923 to D9930		
D9931 to D9952	P_L1_16 to POc_L1_16 Proportional band of group 16 to Cooling-side preset output of group 16	Same as D3002 to D3022.
D9953 to D10000		

14.5 Writing via Communication

■ Setting Target Setpoint

In LCL (local) mode

- (1) Set the Loop-1 and Loop-2 target setpoints of groups 1 to 8 parameters (SP_L1_1 to SP_L1_8 or SP_L2_1 to SP_L2_8).
- (2) Write the setpoint (1 to 8) in the SPNO. (SP number selection) (depends on the setup parameter SPGR. setting)
- (3) Set the operation mode (R.L_L1, R.L_L2) to LCL (local) (0).

Register No.	Register symbol	Description
D2312	SPNO.	SP number selection

In REM (remote) mode

- (1) The target setpoint can be written via communication only when the operation mode (R.L_L1, R.L_L2) is set to REM (remote) mode.
- (2) Write the setpoint in the C.RSP_L1 or C.RSP_L2.
Example: When setting 150.0°C for the C.RSP_L1, write "1500" to this register.
- (3) Set the operation mode (R.L_L1, R.L_L2) to the REM (remote) mode.

Register No.	Register symbol	Description
D2331	C.RSP_L1	Loop-1 communication remote setpoint
D2332	C.RSP_L2	Loop-2 communication remote setpoint

■ Setting Control Output Value in MAN Mode

The control output value can be written via communication only when the operation mode is set to MAN mode.

- (1) Set the operation mode (A.M) to MAN (1).
- (2) Write the control output value in the MOUT_L1, MOUT_L2, MOUTc_L1, or MOUTc_L2.

Register No.	Register symbol	Description
D2333	MOUT_L1	Loop-1 heating-side control output in MAN mode
D2334	MOUTc_L1	Loop-1 cooling-side control output in MAN mode
D2335	MOUT_L2	Loop-2 heating-side control output in MAN mode
D2336	MOUTc_L2	Loop-2 cooling-side control output in MAN mode

■ Setting Manual Preset Output Number

The manual preset output number can be written via communication only when the operation mode is set to MAN mode.

- (1) Set the Loop-1 and Loop-2 manual preset output 1 to 5 parameters (MPO1_L1 to MPO5_L1 or MPO1_L2 to MPO5_L2).
- (2) Write the setpoint (1 to 5) in the MPON_L1 or MPON_L2.
- (3) Set the operation mode (A.M) to MAN (1).

Register No.	Register symbol	Description
D3531	MPON_L1	Loop-1 manual preset output number selection
D4631	MPON_L2	Loop-2 manual preset output number selection

■ Operating a Valve (for Position proportional type only)

Write a valve position in MOUT_L1 in MAN mode for position proportional PID computation.

■ Setting PID Number (D2503: PIDN_L1_1 to D2643: PIDN_L1_8, D3603: PIDN_L2_1 to D3743: PIDN_L2_8)

PID number can be selected via communication only when the zone PID selection parameter (ZON) is set to 1, 2, or 4.

D2503 to D2643 = 1 to 8, D3603 to D3743 = 1 to 8 (depends on the setup parameter SPGR. setting).

When the PID number is selected using the external contact input, the setting via communication is impossible.

■ Setting Program Pattern Parameter (D7701: SSP_L1 to D7800: S.PID_L2)

Setting the program pattern parameter can be available during STOP or HOLD mode operation.

14.6 GREEN Series Compatible D Registers

14.6.1 Compatibility with GREEN Series Controllers

The D register map configuration of the UTAdvanced is the same as that of the GREEN Series (UT700 Series) controllers that perform access in the 2-byte integer data format. When GREEN Series devices are replaced with the UTAdvanced, communication programs created in the GREEN Series controllers can be used by just carrying out wiring. If existing programs created in the GREEN Series controllers are used, communication is performed using the area from D0001 to D2000.

However, although the function allocation from D0001 to D1300 is the same as that of the GREEN Series (UT700 Series) controllers, the setting ranges and the function operation specifications of registers are subject to the specifications of the UTAdvanced.

Furthermore, the functions have been enhanced from the GREEN Series controllers, so the generic settings and functions for some registers have been changed. For the changed registers, see “14.6.14 D Registers Differing in Content from GREEN Series.”

The register map after D2001 is a D register map allocated for the UTAdvanced.

When you want to newly perform communication, be sure to use the registers after D2001.

14.6.2 Interpretation of D Register Tables

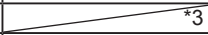
Register map (Categories)					
Register contents					
D-Reg No.	Ref. No.	H No.	Register symbol for GREEN	Register symbol for UTAdvanced	R/W
D0001	40001	0000	ADERROR	AD1.E_G *1	R
D0002	40002	0001	ERROR.1	PV1.E_L1_G *1	R
D0003	40003	0002	PV.1	PV_L1 (D2003)	
⋮	⋮	⋮	⋮	⋮	⋮
D0033	40033	0020	DISTS	DI00 (D7601) *2	R
⋮	⋮	⋮	⋮	⋮	⋮
D0250	40250	00F9	ORB.1	 *3	R
⋮	⋮	⋮	⋮	⋮	⋮
D0310	40310	0135	1.OL	Depends on the conditions *4	R/W
⋮	⋮	⋮	⋮	⋮	⋮
D0915	40915	0392	AL1.1	AL1.T_L1 (D2801)	R/W

(1) D register numbers (2) Reference numbers (for Modbus communication) (3) Hexadecimal numbers (for Modbus communication)

Numbers in parentheses indicate the same register after D2001. Read/write by communication
R: Read enabled
W: Write enabled

■ Interpretation of Cell

*1: AD1.E_G (with _G) indicates a D register converted for the GREEN Series.

Furthermore, PV1.E_L1_G (shaded cell) indicates that it differs in content from that of the GREEN Series.

See “14.6.13 D Registers Converted for GREEN Series” described later.

*2: DI00 (D7601) (shaded cell) indicates that it differs in content from that of the GREEN Series. See “14.6.14 D Registers Differing in Content from GREEN Series” described later.

*3: A cell marked with a diagonal line (“”) indicates that it is not supported by the UTAdvanced.

*4: Depends on the conditions indicates that the D register varies depending on the setting condition of other parameters.

See “14.6.15 D Registers Differing Depending on Condition” described later.

■ D register symbols

- With regards to some D register symbols, the loop number, terminal area, and group number are indicated by adding the underline () to the end of the parameter symbols.

If both the loop number and group number are added to the parameter symbols, they are added in the order of loop number and group number.

□□□□ **Ln**: Loop numbers (L1 or L2)

Y: Group numbers (1 to 8)

□□□□ **En**: Terminal area (E1 to E4)

Example : **SP_L1_3** Indicates Loop-1 SP of group 3.
A2_2 Indicates A2 of group 2.
UNI_E1 Indicates UNI in E1-terminal area.

- With regards to D register symbols from D0001 to D2000, the capital letter G with underline (G) is added to the end of the parameter symbols to indicate that the D register was converted for the GREEN Series.
D registers with G do not appear in the area for the UTAdvanced after D2001.
See “14.6.13 D Registers Converted for GREEN Series.”

□□□□ **G** Example: AD1.E_G, PV1.E_L1_G, ALM_G

- Numbers in parentheses after the register symbols of the UTAdvanced indicate the same D register after D2001.

14.6 GREEN Series Compatible D Registers

14.6.3 Process Data and User Area (D0001 to D0100)

Configuration map for GREEN Series											
Process data						User area					
D-Reg No.	Ref. No.	H No.	Register symbol for GREEN	Register symbol for UTAdvanced	R/W	D-Reg No.	Ref. No.	H No.	Register symbol for GREEN	Register symbol for UTAdvanced	R/W
D0001	40001	0000	ADERROR	AD1.E_G	R	D0051	40051	0032	USER	USER1	R/W
D0002	40002	0001	ERROR.1	PV1.E_L1_G	R	D0052	40052	0033	USER	USER2	R/W
D0003	40003	0002	PV.1	PV_L1 (D2003)	R	D0053	40053	0034	USER	USER3	R/W
D0004	40004	0003	CSP.1	CSP_L1 (D2004)	R	D0054	40054	0035	USER	USER4	R/W
D0005	40005	0004	OUT.1	OUT_L1 (D2005)	R	D0055	40055	0036	USER	USER5	R/W
D0006	40006	0005	HOUT.1	H.OUT_L1 (D2006)	R	D0056	40056	0037	USER	USER6	R/W
D0007	40007	0006	COU.T.1	C.OUT_L1 (D2007)	R	D0057	40057	0038	USER	USER7	R/W
D0008	40008	0007	MOD.1	MOD_L1_G	R	D0058	40058	0039	USER	USER8	R/W
D0009	40009	0008	PIDNO.1	PID_L1 (D2009)	R	D0059	40059	003A	USER	USER9	R/W
D0010	40010	0009	CSPNO	CSPNO. (D2010)	R	D0060	40060	003B	USER	USER10	R/W
D0011	40011	000A	ALM	ALM_G	R	D0061	40061	003C	USER	USER11	R/W
D0012	40012	000B				D0062	40062	003D	USER	USER12	R/W
D0013	40013	000C				D0063	40063	003E	USER	USER13	R/W
D0014	40014	000D				D0064	40064	003F	USER	USER14	R/W
D0015	40015	000E				D0065	40065	0040	USER	USER15	R/W
D0016	40016	000F				D0066	40066	0041	USER	USER16	R/W
D0017	40017	0010				D0067	40067	0042	USER	USER17	R/W
D0018	40018	0011	ERROR.2	PV2.E_L2_G	R	D0068	40068	0043	USER	USER18	R/W
D0019	40019	0012	PV.2	PV_L2 (D2019)	R	D0069	40069	0044	USER	USER19	R/W
D0020	40020	0013	CSP.2	CSP_L2 (D2020)	R	D0070	40070	0045	USER	USER20	R/W
D0021	40021	0014	OUT.2	OUT_L2 (D2021)	R	D0071	40071	0046	USER	USER21	R/W
D0022	40022	0015	HOUT.2	H.OUT_L2 (D2022)	R	D0072	40072	0047	USER	USER22	R/W
D0023	40023	0016	COU.T.2	C.OUT_L2 (D2023)	R	D0073	40073	0048	USER	USER23	R/W
D0024	40024	0017	MOD.2	MOD_L2_G	R	D0074	40074	0049	USER	USER24	R/W
D0025	40025	0018	PIDNO.2	PIDN_L2 (D2025)	R	D0075	40075	004A	USER	USER25	R/W
D0026	40026	0019	DEV.1	DEV_L1 (D2035)	R	D0076	40076	004B	USER	USER26	R/W
D0027	40027	001A	OR.1		R	D0077	40077	004C	USER	USER27	R/W
D0028	40028	001B				D0078	40078	004D	USER	USER28	R/W
D0029	40029	001C				D0079	40079	004E	USER	USER29	R/W
D0030	40030	001D	DEV.2	DEV_L2 (D2036)	R	D0080	40080	004F	USER	USER30	R/W
D0031	40031	001E	OR.2		R	D0081	40081	0050	USER	USER31	R/W
D0032	40032	001F	SMEC		R	D0082	40082	0051	USER	USER32	R/W
D0033	40033	0020	DISTS	DI00 (D7601)	R	D0083	40083	0052	USER	USER33	R/W
D0034	40034	0021	RDISTS		R	D0084	40084	0053	USER	USER34	R/W
D0035	40035	0022	PARAERR	PA.ER_G	R	D0085	40085	0054	USER	USER35	R/W
D0036	40036	0023	ALOSTS	ALO_G	R	D0086	40086	0055	USER	USER36	R/W
D0037	40037	0024	TIM1		R	D0087	40087	0056	USER	USER37	R/W
D0038	40038	0025	TIM2		R	D0088	40088	0057	USER	USER38	R/W
D0039	40039	0026	DISP1		R	D0089	40089	0058	USER	USER39	R/W
D0040	40040	0027	DISP2		R	D0090	40090	0059	USER	USER40	R/W
D0041	40041	0028				D0091	40091	005A	USER	USER41	R/W
D0042	40042	0029				D0092	40092	005B	USER	USER42	R/W
D0043	40043	002A				D0093	40093	005C	USER	USER43	R/W
D0044	40044	002B				D0094	40094	005D	USER	USER44	R/W
D0045	40045	002C				D0095	40095	005E	USER	USER45	R/W
D0046	40046	002D				D0096	40096	005F	USER	USER46	R/W
D0047	40047	002E				D0097	40097	0060	USER	USER47	R/W
D0048	40048	002F				D0098	40098	0061	USER	USER48	R/W
D0049	40049	0030				D0099	40099	0062	USER	USER49	R/W
D0050	40050	0031	USER	USER0	R/W	D0100	40100	0063	USER	USER50	R/W

14.6.4 Operation Mode and Operation-related Parameters (D0201 to D0300)

Configuration map for GREEN Series											
Operation mode / Operation-related parameters											
D-Reg No.	Ref. No.	H No.	Register symbol for GREEN	Register symbol for UTAdvanced	R/W	D-Reg No.	Ref. No.	H No.	Register symbol for GREEN	Register symbol for UTAdvanced	R/W
D0201	40201	00C8	A/M1	A.M (D2301)	R/W	D0251	40251	00FA	ORH.1		R
D0202	40202	00C9	A/M2	A.M (D2302)	R/W	D0252	40252	00FB	ORL.1		R
D0203	40203	00CA	R/L1	R.L_L1 (D2306)	R/W	D0253	40253	00FC			
D0204	40204	00CB	R/L2	R.L_L2 (D2307)	R/W	D0254	40254	00FD			
D0205	40205	00CC	S/R	S.R (D2304)	R/W	D0255	40255	00FE			
D0206	40206	00CD	C.A.M	C.A.M (D2303)	R/W	D0256	40256	00FF			
D0207	40207	00CE	SPN	SPNO. (D2312)	R/W	D0257	40257	0100			
D0208	40208	00CF				D0258	40258	0101			
D0209	40209	00D0				D0259	40259	0102			
D0210	40210	00D1				D0260	40260	0103			
D0211	40211	00D2				D0261	40261	0104			
D0212	40212	00D3				D0262	40262	0105			
D0213	40213	00D4				D0263	40263	0106			
D0214	40214	00D5				D0264	40264	0107			
D0215	40215	00D6	C.RSP.1	C.RSP_L1 (D2331)	R/W	D0265	40265	0108			
D0216	40216	00D7	C.RSP.2	C.RSP_L2 (D2332)	R/W	D0266	40266	0109			
D0217	40217	00D8	MOUT.1	MOUT_L1 (D2333)	R/W	D0267	40267	010A			
D0218	40218	00D9	MOUTc.1	MOUTc_L1 (D2334)	R/W	D0268	40268	010B			
D0219	40219	00DA	MOUT.2	MOUT_L2 (D2335)	R/W	D0269	40269	010C			
D0220	40220	00DB	MOUTc.2	MOUTc_L2 (D2336)	R/W	D0270	40270	010D			
D0221	40221	00DC	HOLDSP.1 (Note 2)	H.SP_L1 (D2337)	R/W	D0271	40271	010E	AT.2	AT_L2 (D2309)	R/W
D0222	40222	00DD	HOLDSP.2 (Note 2)	H.SP_L2 (D2338)	R/W	D0272	40272	010F	SC.2	SC_L2 (D4601)	R/W
D0223	40223	00DE	HOLDTM (Note 2)	H.TM (D2341)	R/W	D0273	40273	0110	BS.2	BS_L2 (D4001)	R/W
D0224	40224	00DF	SST (Note 2)	SST (D2342)	R/W	D0274	40274	0111	FL.2	FL_L2 (D4002)	R/W
D0225	40225	00E0	PNO (Note 1)	PID_G	R/W	D0275	40275	0112	UPR.2		R
D0226	40226	00E1				D0276	40276	0113	DNR.2		R
D0227	40227	00E2				D0277	40277	0114	RT.2	RT_L2 (D3803)	R/W
D0228	40228	00E3				D0278	40278	0115	RBS.2	RBS_L2 (D3804)	R/W
D0229	40229	00E4				D0279	40279	0116	RFL.2	RFL_L2 (D3802)	R/W
D0230	40230	00E5				D0280	40280	0117	ORB.2		R
D0231	40231	00E6				D0281	40281	0118	ORH.2		R
D0232	40232	00E7				D0282	40282	0119	ORL.2		R
D0233	40233	00E8				D0283	40283	011A			
D0234	40234	00E9				D0284	40284	011B			
D0235	40235	00EA				D0285	40285	011C			
D0236	40236	00EB				D0286	40286	011D			
D0237	40237	00EC				D0287	40287	011E			
D0238	40238	00ED				D0288	40288	011F			
D0239	40239	00EE				D0289	40289	0120			
D0240	40240	00EF				D0290	40290	0121			
D0241	40241	00F0	AT.1	AT_L1 (D2308)	R/W	D0291	40291	0122			
D0242	40242	00F1	SC.1	SC_L1 (D3501)	R/W	D0292	40292	0123			
D0243	40243	00F2	BS.1	BS_L1 (D2901)	R/W	D0293	40293	0124			
D0244	40244	00F3	FL.1	FL_L1 (D2902)	R/W	D0294	40294	0125			
D0245	40245	00F4	UPR.1		R	D0295	40295	0126			
D0246	40246	00F5	DNR.1		R	D0296	40296	0127			
D0247	40247	00F6	RT.1	RT_L1 (D2703)	R/W	D0297	40297	0128			
D0248	40248	00F7	RBS.1	RBS_L1 (D2704)	R/W	D0298	40298	0129			
D0249	40249	00F8	RFL.1	RFL_L1 (D2702)	R/W	D0299	40299	012A			
D0250	40250	00F9	ORB.1		R	D0300	40300	012B			

14.6 GREEN Series Compatible D Registers

6.6.5 Loop-1 PID Parameters (D0301 to D0500)

Configuration map for GREEN Series											
Loop-1 SP / AL / PID parameters											
D-Reg No.	Ref. No.	H No.	Register symbol for GREEN	Register symbol for UTAdvanced	R/W	D-Reg No.	Ref. No.	H No.	Register symbol for GREEN	Register symbol for UTAdvanced	R/W
D0301	40301	012C	1.SP	SP_L1_1 (D2501)	R/W	D0351	40351	015E	3.SP	SP_L1_3 (D2541)	R/W
D0302	40302	012D	1.A1	A1_L1_1 (D2504)	R/W	D0352	40352	015F	3.A1	A1_L1_3 (D2544)	R/W
D0303	40303	012E	1.A2	A2_L1_1 (D2505)	R/W	D0353	40353	0160	3.A2	A2_L1_3 (D2545)	R/W
D0304	40304	012F	1.A3	A3_L1_1 (D2506)	R/W	D0354	40354	0161	3.A3	A3_L1_3 (D2546)	R/W
D0305	40305	0130	1.A4	A4_L1_1 (D2507)	R/W	D0355	40355	0162	3.A4	A4_L1_3 (D2547)	R/W
D0306	40306	0131	1.P	P_L1_1 (D3001)	R/W	D0356	40356	0163	3.P	P_L1_3 (D3101)	R/W
D0307	40307	0132	1.I	I_L1_1 (D3002)	R/W	D0357	40357	0164	3.I	I_L1_3 (D3102)	R/W
D0308	40308	0133	1.D	D_L1_1 (D3003)	R/W	D0358	40358	0165	3.D	D_L1_3 (D3103)	R/W
D0309	40309	0134	1.OH	OH_L1_1 (D3004)	R/W	D0359	40359	0166	3.OH	OH_L1_3 (D3104)	R/W
D0310	40310	0135	1.OL	Depends on the conditions (Note1)	R/W	D0360	40360	0167	3.OL	Depends on the conditions (Note1)	R/W
D0311	40311	0136	1.MR	MR_L1_1 (D3006)	R/W	D0361	40361	0168	3.MR	MR_L1_3 (D3106)	R/W
D0312	40312	0137	1.H	HYS_L1_1 (D3007)	R/W	D0362	40362	0169	3.H	HYS_L1_3 (D3107)	R/W
D0313	40313	0138	1.DR	DR_L1_1 (D3011)	R/W	D0363	40363	016A	3.DR	DR_L1_3 (D3111)	R/W
D0314	40314	0139	1.Pc	Pc_L1_1 (D3013)	R/W	D0364	40364	016B	3.Pc	Pc_L1_3 (D3113)	R/W
D0315	40315	013A	1.lc	lc_L1_1 (D3014)	R/W	D0365	40365	016C	3.lc	lc_L1_3 (D3114)	R/W
D0316	40316	013B	1.Dc	Dc_L1_1 (D3015)	R/W	D0366	40366	016D	3.Dc	Dc_L1_3 (D3115)	R/W
D0317	40317	013C	1.Hc	HYS_L1_1 (D3018)	R/W	D0367	40367	016E	3.Hc	HYS_L1_3 (D3118)	R/W
D0318	40318	013D	1.DB	DB_L1_1 (D3019)	R/W	D0368	40368	016F	3.DB	DB_L1_3 (D3119)	R/W
D0319	40319	013E	1.RP	RP1_L1 (D3551)	R/W	D0369	40369	0170	3.RP	RP3_L1 (D3553)	R/W
D0320	40320	013F	1.PO	PO_L1_1 (D3020)	R/W	D0370	40370	0171	3.PO	PO_L1_3 (D3120)	R/W
D0321	40321	0140	1.Oc	POc_L1_1 (D3022)	R/W	D0371	40371	0172	3.Oc	POc_L1_3 (D3122)	R/W
D0322	40322	0141				D0372	40372	0173			
D0323	40323	0142				D0373	40373	0174			
D0324	40324	0143				D0374	40374	0175			
D0325	40325	0144				D0375	40375	0176			
D0326	40326	0145	2.SP	SP_L1_2 (D2521)	R/W	D0376	40376	0177	4.SP	SP_L1_4 (D2561)	R/W
D0327	40327	0146	2.A1	A1_L1_2 (D2524)	R/W	D0377	40377	0178	4.A1	A1_L1_4 (D2564)	R/W
D0328	40328	0147	2.A2	A2_L1_2 (D2525)	R/W	D0378	40378	0179	4.A2	A2_L1_4 (D2565)	R/W
D0329	40329	0148	2.A3	A3_L1_2 (D2526)	R/W	D0379	40379	017A	4.A3	A3_L1_4 (D2566)	R/W
D0330	40330	0149	2.A4	A4_L1_2 (D2527)	R/W	D0380	40380	017B	4.A4	A4_L1_4 (D2567)	R/W
D0331	40331	014A	2.P	P_L1_2 (D3051)	R/W	D0381	40381	017C	4.P	P_L1_4 (D3151)	R/W
D0332	40332	014B	2.I	I_L1_2 (D3052)	R/W	D0382	40382	017D	4.I	I_L1_4 (D3152)	R/W
D0333	40333	014C	2.D	D_L1_2 (D3053)	R/W	D0383	40383	017E	4.D	D_L1_4 (D3153)	R/W
D0334	40334	014D	2.OH	OH_L1_2 (D3054)	R/W	D0384	40384	017F	4.OH	OH_L1_4 (D3154)	R/W
D0335	40335	014E	2.OL	Depends on the conditions (Note1)	R/W	D0385	40385	0180	4.OL	Depends on the conditions (Note1)	R/W
D0336	40336	014F	2.MR	MR_L1_2 (D3056)	R/W	D0386	40386	0181	4.MR	MR_L1_4 (D3156)	R/W
D0337	40337	0150	2.H	HYS_L1_2 (D3057)	R/W	D0387	40387	0182	4.H	HYS_L1_4 (D3157)	R/W
D0338	40338	0151	2.DR	DR_L1_2 (D3061)	R/W	D0388	40388	0183	4.DR	DR_L1_4 (D3161)	R/W
D0339	40339	0152	2.Pc	Pc_L1_2 (D3063)	R/W	D0389	40389	0184	4.Pc	Pc_L1_4 (D3163)	R/W
D0340	40340	0153	2.lc	lc_L1_2 (D3064)	R/W	D0390	40390	0185	4.lc	lc_L1_4 (D3164)	R/W
D0341	40341	0154	2.Dc	Dc_L1_2 (3065)	R/W	D0391	40391	0186	4.Dc	Dc_L1_4 (D3165)	R/W
D0342	40342	0155	2.Hc	HYS_L1_2 (D3068)	R/W	D0392	40392	0187	4.Hc	HYS_L1_4 (D3168)	R/W
D0343	40343	0156	2.DB	DB_L1_2 (D3069)	R/W	D0393	40393	0188	4.DB	DB_L1_4 (D3169)	R/W
D0344	40344	0157	2.RP	RP2_L1 (D3552)	R/W	D0394	40394	0189	4.RP	RP4_L1 (D3554)	R/W
D0345	40345	0158	2.PO	PO_L1_2 (D3070)	R/W	D0395	40395	018A	4.PO	PO_L1_4 (D3170)	R/W
D0346	40346	0159	2.Oc	POc_L1_2 (D3072)	R/W	D0396	40396	018B	4.Oc	POc_L1_4 (D3172)	R/W
D0347	40347	015A				D0397	40397	018C			
D0348	40348	015B				D0398	40398	018D			
D0349	40349	015C				D0399	40399	018E			
D0350	40350	015D				D0400	40400	018F			

(Note 1): See the 14.6.15 D Registers Differing Depending on Conditions

Configuration map for GREEN Series											
Loop-1 SP / AL / PID parameters											
D-Reg No.	Ref. No.	H No.	Register symbol for GREEN	Register symbol for UTAdvanced	R/W	D-Reg No.	Ref. No.	H No.	Register symbol for GREEN	Register symbol for UTAdvanced	R/W
D0401	40401	0190	5.SP	SP_L1_5 (D2581)	R/W	D0451	40451	01C2	7.SP	SP_L1_7 (D2621)	R/W
D0402	40402	0191	5.A1	A1_L1_5 (D2584)	R/W	D0452	40452	01C3	7.A1	A1_L1_7 (D2624)	R/W
D0403	40403	0192	5.A2	A2_L1_5 (D2585)	R/W	D0453	40453	01C4	7.A2	A2_L1_7 (D2625)	R/W
D0404	40404	0193	5.A3	A3_L1_5 (D2586)	R/W	D0454	40454	01C5	7.A3	A3_L1_7 (D2626)	R/W
D0405	40405	0194	5.A4	A4_L1_5 (D2587)	R/W	D0455	40455	01C6	7.A4	A4_L1_7 (D2627)	R/W
D0406	40406	0195	5.P	P_L1_5 (D3201)	R/W	D0456	40456	01C7	7.P	P_L1_7 (D3301)	R/W
D0407	40407	0196	5.I	I_L1_5 (D3202)	R/W	D0457	40457	01C8	7.I	I_L1_7 (D3302)	R/W
D0408	40408	0197	5.D	D_L1_5 (D3203)	R/W	D0458	40458	01C9	7.D	D_L1_7 (D3303)	R/W
D0409	40409	0198	5.OH	OH_L1_5 (D3204)	R/W	D0459	40459	01CA	7.OH	OH_L1_7 (D3304)	R/W
D0410	40410	0199	5.OL	Depends on the conditions (Note1)	R/W	D0460	40460	01CB	7.OL	Depends on the conditions (Note1)	R/W
D0411	40411	019A	5.MR	MR_L1_5 (D3206)	R/W	D0461	40461	01CC	7.MR	MR_L1_7 (D3306)	R/W
D0412	40412	019B	5.H	HYS_L1_5 (D3207)	R/W	D0462	40462	01CD	7.H	HYS_L1_7 (D3307)	R/W
D0413	40413	019C	5.DR	DR_L1_5 (D3211)	R/W	D0463	40463	01CE	7.DR	DR_L1_7 (D3311)	R/W
D0414	40414	019D	5.Pc	Pc_L1_5 (D3213)	R/W	D0464	40464	01CF	7.Pc	Pc_L1_7 (D3313)	R/W
D0415	40415	019E	5.Ic	Ic_L1_5 (D3214)	R/W	D0465	40465	01D0	7.Ic	Ic_L1_7 (D3314)	R/W
D0416	40416	019F	5.Dc	Dc_L1_5 (D3215)	R/W	D0466	40466	01D1	7.Dc	Dc_L1_7 (D3315)	R/W
D0417	40417	01A0	5.Hc	HYS_L1_5 (D3218)	R/W	D0467	40467	01D2	7.Hc	HYS_L1_7 (D3318)	R/W
D0418	40418	01A1	5.DB	DB_L1_5 (D3219)	R/W	D0468	40468	01D3	7.DB	DB_L1_7 (D3319)	R/W
D0419	40419	01A2	5.RP	RP5_L1 (D3555)	R/W	D0469	40469	01D4	RHY	RHY_L1 (D3558)	R/W
D0420	40420	01A3	5.PO	PO_L1_5 (D3220)	R/W	D0470	40470	01D5	7.PO	PO_L1_7 (D3320)	R/W
D0421	40421	01A4	5.Oc	POc_L1_5 (D3222)	R/W	D0471	40471	01D6	7.Oc	POc_L1_7 (D3322)	R/W
D0422	40422	01A5				D0472	40472	01D7			
D0423	40423	01A6				D0473	40473	01D8			
D0424	40424	01A7				D0474	40474	01D9			
D0425	40425	01A8				D0475	40475	01DA			
D0426	40426	01A9	6.SP	SP_L1_6 (D2601)	R/W	D0476	40476	01DB	8.SP	SP_L1_8 (D2641)	R/W
D0427	40427	01AA	6.A1	A1_L1_6 (D2604)	R/W	D0477	40477	01DC	8.A1	A1_L1_8 (D2644)	R/W
D0428	40428	01AB	6.A2	A2_L1_6 (D2605)	R/W	D0478	40478	01DD	8.A2	A2_L1_8 (D2645)	R/W
D0429	40429	01AC	6.A3	A3_L1_6 (D2606)	R/W	D0479	40479	01DE	8.A3	A3_L1_8 (D2646)	R/W
D0430	40430	01AD	6.A4	A4_L1_6 (D2607)	R/W	D0480	40480	01DF	8.A4	A4_L1_8 (D2647)	R/W
D0431	40431	01AE	6.P	P_L1_6 (D3251)	R/W	D0481	40481	01E0	8.P	P_L1_8 (D3351)	R/W
D0432	40432	01AF	6.I	I_L1_6 (D3252)	R/W	D0482	40482	01E1	8.I	I_L1_8 (D2352)	R/W
D0433	40433	01B0	6.D	D_L1_6 (D3253)	R/W	D0483	40483	01E2	8.D	D_L1_8 (D3353)	R/W
D0434	40434	01B1	6.OH	OH_L1_6 (D3254)	R/W	D0484	40484	01E3	8.OH	OH_L1_8 (D3354)	R/W
D0435	40435	01B2	6.OL	Depends on the conditions (Note1)	R/W	D0485	40485	01E4	8.OL	Depends on the conditions (Note1)	R/W
D0436	40436	01B3	6.MR	MR_L1_6 (D3256)	R/W	D0486	40486	01E5	8.MR	MR_L1_8 (D3356)	R/W
D0437	40437	01B4	6.H	HYS_L1_6 (D3257)	R/W	D0487	40487	01E6	8.H	HYS_L1_8 (D3357)	R/W
D0438	40438	01B5	6.DR	DR_L1_6 (D3261)	R/W	D0488	40488	01E7	8.DR	DR_L1_8 (D3361)	R/W
D0439	40439	01B6	6.Pc	Pc_L1_6 (D3263)	R/W	D0489	40489	01E8	8.Pc	Pc_L1_8 (D3363)	R/W
D0440	40440	01B7	6.Ic	Ic_L1_6 (D3264)	R/W	D0490	40490	01E9	8.Ic	Ic_L1_8 (D3364)	R/W
D0441	40441	01B8	6.Dc	Dc_L1_6 (D3265)	R/W	D0491	40491	01EA	8.Dc	Dc_L1_8 (D3365)	R/W
D0442	40442	01B9	6.Hc	HYS_L1_6 (D3268)	R/W	D0492	40492	01EB	8.Hc	HYS_L1_8 (D3368)	R/W
D0443	40443	01BA	6.DB	DB_L1_6 (D3269)	R/W	D0493	40493	01EC	8.DB	DB_L1_8 (D3369)	R/W
D0444	40444	01BB	6.RP	RP6_L1 (D3556)	R/W	D0494	40494	01ED	RDV	RDV_L1 (D3559)	R/W
D0445	40445	01BC	6.PO	PO_L1_6 (D3270)	R/W	D0495	40495	01EE	8.PO	PO_L1_8 (D3370)	R/W
D0446	40446	01BD	6.Oc	POc_L1_6 (D3272)	R/W	D0496	40496	01EF	8.Oc	POc_L1_8 (D3372)	R/W
D0447	40447	01BE				D0497	40497	01F0			
D0448	40448	01BF				D0498	40498	01F1			
D0449	40449	01C0				D0499	40499	01F2			
D0450	40450	01C1				D0500	40500	01F3			

(Note 1): See the 14.6.15 D Registers Differing Depending on Conditions

14.6 GREEN Series Compatible D Registers

14.6.6 Loop-2 PID Parameters (D0501 to D0700)

Configuration map for GREEN Series											
Loop-2 SP / AL / PID parameters											
D-Reg No.	Ref. No.	H No.	Register symbol for GREEN	Register symbol for UTAdvanced	R/W	D-Reg No.	Ref. No.	H No.	Register symbol for GREEN	Register symbol for UTAdvanced	R/W
D0501	40501	01F4	1.SP	SP_L2_1 (D3601)	R/W	D0551	40551	0226	3.SP	SP_L2_3 (D3641)	R/W
D0502	40502	01F5	1.A1	A1_L2_1 (D3604)	R/W	D0552	40552	0227	3.A1	A1_L2_3 (D3644)	R/W
D0503	40503	01F6	1.A2	A2_L2_1 (D3605)	R/W	D0553	40553	0228	3.A2	A2_L2_3 (D3645)	R/W
D0504	40504	01F7	1.A3	A3_L2_1 (D3606)	R/W	D0554	40554	0229	3.A3	A3_L2_3 (D3646)	R/W
D0505	40505	01F8	1.A4	A4_L2_1 (D3607)	R/W	D0555	40555	022A	3.A4	A4_L2_3 (D3647)	R/W
D0506	40506	01F9	1.P	P_L2_1 (D4101)	R/W	D0556	40556	022B	3.P	P_L2_3 (D4201)	R/W
D0507	40507	01FA	1.I	I_L2_1 (D4102)	R/W	D0557	40557	022C	3.I	I_L2_3 (D4202)	R/W
D0508	40508	01FB	1.D	D_L2_1 (D4103)	R/W	D0558	40558	022D	3.D	D_L2_3 (D4203)	R/W
D0509	40509	01FC	1.OH	OH_L2_1 (D4104)	R/W	D0559	40559	022E	3.OH	OH_L2_3 (D4204)	R/W
D0510	40510	01FD	1.OL	Depends on the conditions (Note1)	R/W	D0560	40560	022F	3.OL	Depends on the conditions (Note1)	R/W
D0511	40511	01FE	1.MR	MR_L2_1 (D4106)	R/W	D0561	40561	0230	3.MR	MR_L2_3 (D4206)	R/W
D0512	40512	01FF	1.H	HYS_L2_1 (D4107)	R/W	D0562	40562	0231	3.H	HYS_L2_3 (D4207)	R/W
D0513	40513	0200	1.DR	DR_L2_1 (D4111)	R/W	D0563	40563	0232	3.DR	DR_L2_3 (D4211)	R/W
D0514	40514	0201	1.Pc	Pc_L2_1 (D4113)	R/W	D0564	40564	0233	3.Pc	Pc_L2_3 (D4213)	R/W
D0515	40515	0202	1.lc	lc_L2_1 (D4114)	R/W	D0565	40565	0234	3.lc	lc_L2_3 (D4214)	R/W
D0516	40516	0203	1.Dc	Dc_L2_1 (D4115)	R/W	D0566	40566	0235	3.Dc	Dc_L2_3 (D4215)	R/W
D0517	40517	0204	1.Hc	HYS_L2_1 (D4118)	R/W	D0567	40567	0236	3.Hc	HYS_L2_3 (D4218)	R/W
D0518	40518	0205	1.DB	DB_L2_1 (D4119)	R/W	D0568	40568	0237	3.DB	DB_L2_3 (D4219)	R/W
D0519	40519	0206	1.RP	RP1_L2 (D4653)	R/W	D0569	40569	0238	3.RP	RP3_L2 (D4655)	R/W
D0520	40520	0207	1.PO	PO_L2_1 (D4120)	R/W	D0570	40570	0239	3.PO	PO_L2_3 (D4220)	R/W
D0521	40521	0208	1.Oc	POc_L2_1 (D4122)	R/W	D0571	40571	023A	3.Oc	POc_L2_3 (D4222)	R/W
D0522	40522	0209				D0572	40572	023B			
D0523	40523	020A				D0573	40573	023C			
D0524	40524	020B				D0574	40574	023D			
D0525	40525	020C				D0575	40575	023E			
D0526	40526	020D	2.SP	SP_L2_2 (D3621)	R/W	D0576	40576	023F	4.SP	SP_L2_4 (D3661)	R/W
D0527	40527	020E	2.A1	A1_L2_2 (D3624)	R/W	D0577	40577	0240	4.A1	A1_L2_4 (D3664)	R/W
D0528	40528	020F	2.A2	A2_L2_2 (D3625)	R/W	D0578	40578	0241	4.A2	A2_L2_4 (D3665)	R/W
D0529	40529	0210	2.A3	A3_L2_2 (D3626)	R/W	D0579	40579	0242	4.A3	A3_L2_4 (D3666)	R/W
D0530	40530	0211	2.A4	A4_L2_2 (D3637)	R/W	D0580	40580	0243	4.A4	A4_L2_4 (D3667)	R/W
D0531	40531	0212	2.P	P_L2_2 (D4151)	R/W	D0581	40581	0244	4.P	P_L2_4 (D4251)	R/W
D0532	40532	0213	2.I	I_L2_2 (D4152)	R/W	D0582	40582	0245	4.I	I_L2_4 (D4252)	R/W
D0533	40533	0214	2.D	D_L2_2 (D4153)	R/W	D0583	40583	0246	4.D	D_L2_4 (D4253)	R/W
D0534	40534	0215	2.OH	OH_L2_2 (D4154)	R/W	D0584	40584	0247	4.OH	OH_L2_4 (D4254)	R/W
D0535	40535	0216	2.OL	Depends on the conditions (Note1)	R/W	D0585	40585	0248	4.OL	Depends on the conditions (Note1)	R/W
D0536	40536	0217	2.MR	MR_L2_2 (D4156)	R/W	D0586	40586	0249	4.MR	MR_L2_4 (D4256)	R/W
D0537	40537	0218	2.H	HYS_L2_2 (D4157)	R/W	D0587	40587	024A	4.H	HYS_L2_4 (D4257)	R/W
D0538	40538	0219	2.DR	DR_L2_2 (D4161)	R/W	D0588	40588	024B	4.DR	DR_L2_4 (D4261)	R/W
D0539	40539	021A	2.Pc	Pc_L2_2 (D4163)	R/W	D0589	40589	024C	4.Pc	Pc_L2_4 (D4263)	R/W
D0540	40540	021B	2.lc	lc_L2_2 (D4164)	R/W	D0590	40590	024D	4.lc	lc_L2_4 (D4264)	R/W
D0541	40541	021C	2.Dc	Dc_L2_2 (D4165)	R/W	D0591	40591	024E	4.Dc	Dc_L2_4 (D4265)	R/W
D0542	40542	021D	2.Hc	HYS_L2_2 (D4168)	R/W	D0592	40592	024F	4.Hc	HYS_L2_4 (D4268)	R/W
D0543	40543	021E	2.DB	DB_L2_2 (D4169)	R/W	D0593	40593	0250	4.DB	DB_L2_4 (D4269)	R/W
D0544	40544	021F	2.RP	RP2_L2 (D4654)	R/W	D0594	40594	0251	4.RP	RP4_L2 (D4656)	R/W
D0545	40545	0220	2.PO	PO_L2_2 (D4170)	R/W	D0595	40595	0252	4.PO	PO_L2_4 (D4270)	R/W
D0546	40546	0221	2.Oc	POc_L2_2 (D4172)	R/W	D0596	40596	0253	4.Oc	POc_L2_4 (D4272)	R/W
D0547	40547	0222				D0597	40597	0254			
D0548	40548	0223				D0598	40598	0255			
D0549	40549	0224				D0599	40599	0256			
D0550	40550	0225				D0600	40600	0257			

(Note 1): See the 14.6.15 D Registers Differing Depending on Conditions

Configuration map for GREEN Series											
Loop-2 SP / AL / PID parameters											
D-Reg No.	Ref. No.	H No.	Register symbol for GREEN	Register symbol for UTAdvanced	R/W	D-Reg No.	Ref. No.	H No.	Register symbol for GREEN	Register symbol for UTAdvanced	R/W
D0601	40601	0258	5.SP	SP_L2_5 (D3681)	R/W	D0651	40651	028A	7.SP	SP_L2_7 (D3721)	R/W
D0602	40602	0259	5.A1	A1_L2_5 (D3684)	R/W	D0652	40652	028B	7.A1	A1_L2_7 (D3724)	R/W
D0603	40603	025A	5.A2	A2_L2_5 (D3635)	R/W	D0653	40653	028C	7.A2	A2_L2_7 (D3725)	R/W
D0604	40604	025B	5.A3	A3_L2_5 (D6386)	R/W	D0654	40654	028D	7.A3	A3_L2_7 (D3726)	R/W
D0605	40605	025C	5.A4	A4_L2_5 (D3687)	R/W	D0655	40655	028E	7.A4	A4_L2_7 (D3727)	R/W
D0606	40606	025D	5.P	P_L2_5 (D4301)	R/W	D0656	40656	028F	7.P	P_L2_7 (D4401)	R/W
D0607	40607	025E	5.I	I_L2_5 (D4302)	R/W	D0657	40657	0290	7.I	I_L2_7 (D4402)	R/W
D0608	40608	025F	5.D	D_L2_5 (D4303)	R/W	D0658	40658	0291	7.D	D_L2_7 (D4403)	R/W
D0609	40609	0260	5.OH	OH_L2_5 (D4304)	R/W	D0659	40659	0292	7.OH	OH_L2_7 (D4404)	R/W
D0610	40610	0261	5.OL	Depends on the conditions (Note1)	R/W	D0660	40660	0293	7.OL	Depends on the conditions (Note1)	R/W
D0611	40611	0262	5.MR	MR_L2_5 (D4306)	R/W	D0661	40661	0294	7.MR	MR_L2_7 (D4406)	R/W
D0612	40612	0263	5.H	HYS_L2_5 (D4307)	R/W	D0662	40662	0295	7.H	HYS_L2_7 (D4407)	R/W
D0613	40613	0264	5.DR	DR_L2_5 (D4311)	R/W	D0663	40663	0296	7.DR	DR_L2_7 (D4411)	R/W
D0614	40614	0265	5.Pc	Pc_L2_5 (D4313)	R/W	D0664	40664	0297	7.Pc	Pc_L2_7 (D4413)	R/W
D0615	40615	0266	5.Ic	Ic_L2_5 (D4314)	R/W	D0665	40665	0298	7.Ic	Ic_L2_7 (D4414)	R/W
D0616	40616	0267	5.Dc	Dc_L2_5 (D4315)	R/W	D0666	40666	0299	7.Dc	Dc_L2_7 (D4415)	R/W
D0617	40617	0268	5.Hc	HYS_L2_5 (D4318)	R/W	D0667	40667	029A	7.Hc	HYS_L2_7 (D4418)	R/W
D0618	40618	0269	5.DB	DB_L2_5 (D4319)	R/W	D0668	40668	029B	7.DB	DB_L2_7 (D4419)	R/W
D0619	40619	026A	5.RP	RP5_L2 (D4657)	R/W	D0669	40669	029C	RHY	RHY_L2 (D4660)	R/W
D0620	40620	026B	5.PO	PO_L2_5 (D4320)	R/W	D0670	40670	029D	7.PO	PO_L2_7 (D4420)	R/W
D0621	40621	026C	5.Oc	POc_L2_5 (D4322)	R/W	D0671	40671	029E	7.Oc	POc_L2_7 (D4422)	R/W
D0622	40622	026D				D0672	40672	029F			
D0623	40623	026E				D0673	40673	02A0			
D0624	40624	026F				D0674	40674	02A1			
D0625	40625	0270				D0675	40675	02A2			
D0626	40626	0271	6.SP	SP_L2_6 (D3701)	R/W	D0676	40676	02A3	8.SP	SP_L2_8 (D3741)	R/W
D0627	40627	0272	6.A1	A1_L2_6 (D3704)	R/W	D0677	40677	02A4	8.A1	A1_L2_8 (D3744)	R/W
D0628	40628	0273	6.A2	A2_L2_6 (D3705)	R/W	D0678	40678	02A5	8.A2	A2_L2_8 (D3745)	R/W
D0629	40629	0274	6.A3	A3_L2_6 (D3706)	R/W	D0679	40679	02A6	8.A3	A3_L2_8 (D3746)	R/W
D0630	40630	0275	6.A4	A4_L2_6 (D3707)	R/W	D0680	40680	02A7	8.A4	A4_L2_8 (D3747)	R/W
D0631	40631	0276	6.P	P_L2_6 (D4351)	R/W	D0681	40681	02A8	8.P	P_L2_8 (D4451)	R/W
D0632	40632	0277	6.I	I_L2_6 (D4352)	R/W	D0682	40682	02A9	8.I	I_L2_8 (D4452)	R/W
D0633	40633	0278	6.D	D_L2_6 (D4353)	R/W	D0683	40683	02AA	8.D	D_L2_8 (D4453)	R/W
D0634	40634	0279	6.OH	OH_L2_6 (D4354)	R/W	D0684	40684	02AB	8.OH	OH_L2_8 (D4454)	R/W
D0635	40635	027A	6.OL	Depends on the conditions (Note1)	R/W	D0685	40685	02AC	8.OL	Depends on the conditions (Note1)	R/W
D0636	40636	027B	6.MR	MR_L2_6 (D4356)	R/W	D0686	40686	02AD	8.MR	MR_L2_8 (D4456)	R/W
D0637	40637	027C	6.H	HYS_L2_6 (D4357)	R/W	D0687	40687	02AE	8.H	HYS_L2_8 (D4457)	R/W
D0638	40638	027D	6.DR	DR_L2_6 (D4361)	R/W	D0688	40688	02AF	8.DR	DR_L2_8 (D4461)	R/W
D0639	40639	027E	6.Pc	Pc_L2_6 (D4363)	R/W	D0689	40689	02B0	8.Pc	Pc_L2_8 (D4463)	R/W
D0640	40640	027F	6.Ic	Ic_L2_6 (D4364)	R/W	D0690	40690	02B1	8.Ic	Ic_L2_8 (D4464)	R/W
D0641	40641	0280	6.Dc	Dc_L2_6 (D4365)	R/W	D0691	40691	02B2	8.Dc	Dc_L2_8 (D4465)	R/W
D0642	40642	0281	6.Hc	HYS_L2_6 (D4368)	R/W	D0692	40692	02B3	8.Hc	HYS_L2_8 (D4468)	R/W
D0643	40643	0282	6.DB	DB_L2_6 (D4369)	R/W	D0693	40693	02B4	8.DB	DB_L2_8 (D4469)	R/W
D0644	40644	0283	6.RP	RP6_L2 (D4658)	R/W	D0694	40694	02B5	RDV	RDV_L2 (D4661)	R/W
D0645	40645	0284	6.PO	PO_L2_6 (D4370)	R/W	D0695	40695	02B6	8.PO	PO_L2_8 (D4470)	R/W
D0646	40646	0285	6.Oc	POc_L2_6 (D4372)	R/W	D0696	40696	02B7	8.Oc	POc_L2_8 (D4472)	R/W
D0647	40647	0286				D0697	40697	02B8			
D0648	40648	0287				D0698	40698	02B9			
D0649	40649	0288				D0699	40699	02BA			
D0650	40650	0289				D0700	40700	02BB			

(Note 1): See the 14.6.15D Registers Differing Depending on Conditions

14.6 GREEN Series Compatible D Registers

14.6.7 User Parameters and 10-segment Linearizer Parameters (D0701 to D0800)

Configuration map for GREEN Series											
User parameters / 10-segment linearizer parameters											
D-Reg No.	Ref. No.	H No.	Register symbol for GREEN	Register symbol for UTAdvanced	R/W	D-Reg No.	Ref. No.	H No.	Register symbol for GREEN	Register symbol for UTAdvanced	R/W
D0701	40701	02BC	U1	Depends on the conditions (Note1)	R/W	D0751	40751	02EE	2.A1	A1_2 (D4832)	R/W
D0702	40702	02BD	U2	Depends on the conditions (Note1)	R/W	D0752	40752	02EF	2.B1	B1_2 (D4833)	R/W
D0703	40703	02BE	U3	Depends on the conditions (Note1)	R/W	D0753	40753	02F0	2.A2	A2_2 (D4834)	R/W
D0704	40704	02BF	U4		R	D0754	40754	02F1	2.B2	B2_2 (D4835)	R/W
D0705	40705	02C0	U5		R	D0755	40755	02F2	2.A3	A3_2 (D4836)	R/W
D0706	40706	02C1	U6		R	D0756	40756	02F3	2.B3	B3_2 (D4837)	R/W
D0707	40707	02C2	U7		R	D0757	40757	02F4	2.A4	A4_2 (D4838)	R/W
D0708	40708	02C3	U8		R	D0758	40758	02F5	2.B4	B4_2 (D4839)	R/W
D0709	40709	02C4				D0759	40759	02F6	2.A5	A5_2 (D4840)	R/W
D0710	40710	02C5				D0760	40760	02F7	2.B5	B5_2 (D4841)	R/W
D0711	40711	02C6				D0761	40761	02F8	2.A6	A6_2 (D4842)	R/W
D0712	40712	02C7				D0762	40762	02F9	2.B6	B6_2 (D4843)	R/W
D0713	40713	02C8				D0763	40763	02FA	2.A7	A7_2 (D4844)	R/W
D0714	40714	02C9				D0764	40764	02FB	2.B7	B7_2 (D4845)	R/W
D0715	40715	02CA				D0765	40765	02FC	2.A8	A8_2 (D4846)	R/W
D0716	40716	02CB				D0766	40766	02FD	2.B8	B8_2 (D4847)	R/W
D0717	40717	02CC				D0767	40767	02FE	2.A9	A9_2 (D4848)	R/W
D0718	40718	02CD				D0768	40768	02FF	2.B9	B9_2 (D4849)	R/W
D0719	40719	02CE				D0769	40769	0300	2.A10	A10_2 (D4850)	R/W
D0720	40720	02CF				D0770	40770	0301	2.B10	B10_2 (D4851)	R/W
D0721	40721	02D0				D0771	40771	0302	2.A11	A11_2 (D4852)	R/W
D0722	40722	02D1				D0772	40772	0303	2.B11	B11_2 (D4853)	R/W
D0723	40723	02D2				D0773	40773	0304	2.PMD	PMD_2 (D4854)	R/W
D0724	40724	02D3				D0774	40774	0305			
D0725	40725	02D4				D0775	40775	0306			
D0726	40726	02D5	1.A1	A1_1 (D4802)	R/W	D0776	40776	0307			
D0727	40727	02D6	1.B1	B1_1 (D4803)	R/W	D0777	40777	0308			
D0728	40728	02D7	1.A2	A2_1 (D4804)	R/W	D0778	40778	0309			
D0729	40729	02D8	1.B2	B2_1 (D4805)	R/W	D0779	40779	030A			
D0730	40730	02D9	1.A3	A3_1 (D4806)	R/W	D0780	40780	030B			
D0731	40731	02DA	1.B3	B3_1 (D4807)	R/W	D0781	40781	030C			
D0732	40732	02DB	1.A4	A4_1 (D4808)	R/W	D0782	40782	030D			
D0733	40733	02DC	1.B4	B4_1 (D4809)	R/W	D0783	40783	030E			
D0734	40734	02DD	1.A5	A5_1 (D4810)	R/W	D0784	40784	030F			
D0735	40735	02DE	1.B5	B5_1 (D4811)	R/W	D0785	40785	0310			
D0736	40736	02DF	1.A6	A6_1 (D4812)	R/W	D0786	40786	0311			
D0737	40737	02E0	1.B6	B6_1 (D4813)	R/W	D0787	40787	0312			
D0738	40738	02E1	1.A7	A7_1 (D4814)	R/W	D0788	40788	0313			
D0739	40739	02E2	1.B7	B7_1 (D4815)	R/W	D0789	40789	0314			
D0740	40740	02E3	1.A8	A8_1 (D4816)	R/W	D0790	40790	0315			
D0741	40741	02E4	1.B8	B8_1 (D4817)	R/W	D0791	40791	0316			
D0742	40742	02E5	1.A9	A9_1 (D4818)	R/W	D0792	40792	0317			
D0743	40743	02E6	1.B9	B9_1 (D4819)	R/W	D0793	40793	0318			
D0744	40744	02E7	1.A10	A10_1 (D4820)	R/W	D0794	40794	0319			
D0745	40745	02E8	1.B10	B10_1 (D4821)	R/W	D0795	40795	031A			
D0746	40746	02E9	1.A11	A11_1 (D4822)	R/W	D0796	40796	031B			
D0747	40747	02EA	1.B11	B11_1 (D4823)	R/W	D0797	40797	031C			
D0748	40748	02EB	1.PMD	PMD_1 (D4824)	R/W	D0798	40798	031D			
D0749	40749	02EC				D0799	40799	031E			
D0750	40750	02ED				D0800	40800	031F			

(Note 1): See the 14.6.15 D Registers Differing Depending on Conditions

6.6.8 Message (D0801 to D0900)

Configuration map for GREEN Series											
Message											
D-Reg No.	Ref. No.	H No.	Register symbol for GREEN	Register symbol for UTAdvanced	R/W	D-Reg No.	Ref. No.	H No.	Register symbol for GREEN	Register symbol for UTAdvanced	R/W
D0801	40801	0320	MG10		R	D0851	40851	0352			
D0802	40802	0321	MG11		R	D0852	40852	0353			
D0803	40803	0322	MG12		R	D0853	40853	0354			
D0804	40804	0323	MG13		R	D0854	40854	0355			
D0805	40805	0324	MG14		R	D0855	40855	0356			
D0806	40806	0325	MG15		R	D0856	40856	0357			
D0807	40807	0326	MG16		R	D0857	40857	0358			
D0808	40808	0327	MG17		R	D0858	40858	0359			
D0809	40809	0328	MG18		R	D0859	40859	035A			
D0810	40810	0329	MG19		R	D0860	40860	035B			
D0811	40811	032A	MG20		R	D0861	40861	035C			
D0812	40812	032B	MG21		R	D0862	40862	035D			
D0813	40813	032C	MG22		R	D0863	40863	035E			
D0814	40814	032D	MG23		R	D0864	40864	035F			
D0815	40815	032E	MG24		R	D0865	40865	0360			
D0816	40816	032F	MG25		R	D0866	40866	0361			
D0817	40817	0330	MG26		R	D0867	40867	0362			
D0818	40818	0331	MG27		R	D0868	40868	0363			
D0819	40819	0332	MG28		R	D0869	40869	0364			
D0820	40820	0333	MG29		R	D0870	40870	0365			
D0821	40821	0334	MG30		R	D0871	40871	0366			
D0822	40822	0335	MG31		R	D0872	40872	0367			
D0823	40823	0336	MG32		R	D0873	40873	0368			
D0824	40824	0337	MG33		R	D0874	40874	0369			
D0825	40825	0338	MG34		R	D0875	40875	036A			
D0826	40826	0339	MG35		R	D0876	40876	036B			
D0827	40827	033A	MG36		R	D0877	40877	036C			
D0828	40828	033B	MG37		R	D0878	40878	036D			
D0829	40829	033C	MG38		R	D0879	40879	036E			
D0830	40830	033D	MG39		R	D0880	40880	036F			
D0831	40831	033E	MG40		R	D0881	40881	0370			
D0832	40832	033F	MG41		R	D0882	40882	0371			
D0833	40833	0340	MG42		R	D0883	40883	0372			
D0834	40834	0341	MG43		R	D0884	40884	0373			
D0835	40835	0342	MG44		R	D0885	40885	0374			
D0836	40836	0343	MG45		R	D0886	40886	0375			
D0837	40837	0344	MG46		R	D0887	40887	0376			
D0838	40838	0345	MG47		R	D0888	40888	0377			
D0839	40839	0346	MG48		R	D0889	40889	0378			
D0840	40840	0347	MG49		R	D0890	40890	0379			
D0841	40841	0348	NAME1		R/W	D0891	40891	037A			
D0842	40842	0349	NAME2		R/W	D0892	40892	037B			
D0843	40843	034A	NAME3		R/W	D0893	40893	037C			
D0844	40844	034B	NAME4		R/W	D0894	40894	037D			
D0845	40845	034C	NAME5		R/W	D0895	40895	037E			
D0846	40846	034D	NAME6		R/W	D0896	40896	037F			
D0847	40847	034E	NAME7		R/W	D0897	40897	0380			
D0848	40848	034F	NAME8		R/W	D0898	40898	0381			
D0849	40849	0350	NAME9		R/W	D0899	40899	0382			
D0850	40850	0351	NAME10		R/W	D0900	40900	0383			

14.6 GREEN Series Compatible D Registers

14.6.9 Control Action Parameters (D0901 to D1000)

Configuration map for GREEN Series											
Control action parameters											
D-Reg No.	Ref. No.	H No.	Register symbol for GREEN	Register symbol for UTAdvanced	R/W	D-Reg No.	Ref. No.	H No.	Register symbol for GREEN	Register symbol for UTAdvanced	R/W
D0901	40901	0384	RMS.1	RMS_L1 (D2701)	R/W	D0951	40951	03B6			
D0902	40902	0385	SPT.1	SPT_L1 (D2710)	R/W	D0952	40952	03B7			
D0903	40903	0386	PVT.1	PVT_L1 (D2711)	R/W	D0953	40953	03B8			
D0904	40904	0387	TMU.1	TMU_L1 (D2707)	R/W	D0954	40954	03B9			
D0905	40905	0388				D0955	40955	03BA	AL1.2	AL1.T_L2 (D3901)	R/W
D0906	40906	0389				D0956	40956	03BB	AL2.2	AL2.T_L2 (D3905)	R/W
D0907	40907	038A				D0957	40957	03BC	AL3.2	AL3.T_L2 (D3909)	R/W
D0908	40908	038B				D0958	40958	03BD	AL4.2	AL4.T_L2 (D3913)	R/W
D0909	40909	038C				D0959	40959	03BE	HY1.2	HY1_L2 (D3941)	R/W
D0910	40910	038D				D0960	40960	03BF	HY2.2	HY2_L2 (D3942)	R/W
D0911	40911	038E				D0961	40961	03C0	HY3.2	HY3_L2 (D3943)	R/W
D0912	40912	038F				D0962	40962	03C1	HY4.2	HY4_L2 (D3944)	R/W
D0913	40913	0390				D0963	40963	03C2	AMD.2	AMD_L2 (D3966)	R/W
D0914	40914	0391				D0964	40964	03C3			
D0915	40915	0392	AL1.1	AL1.T_L1 (D2801)	R/W	D0965	40965	03C4			
D0916	40916	0393	AL2.1	AL2.T_L1 (D2805)	R/W	D0966	40966	03C5			
D0917	40917	0394	AL3.1	AL3.T_L1 (D2809)	R/W	D0967	40967	03C6	MOD.2	ALG_L2 (D5006)	R/W
D0918	40918	0395	AL4.1	AL4.T_L1 (D2813)	R/W	D0968	40968	03C7	AR.2	AR_L2 (D4626)	R/W
D0919	40919	0396	HY1.1	HY1_L1 (D2841)	R/W	D0969	40969	03C8			
D0920	40920	0397	HY2.1	HY2_L1 (D2842)	R/W	D0970	40970	03C9			
D0921	40921	0398	HY3.1	HY3_L1 (D2843)	R/W	D0971	40971	03CA			
D0922	40922	0399	HY4.1	HY4_L1 (D2844)	R/W	D0972	40972	03CB			
D0923	40923	039A	AMD.1	AMD_L1 (D2866)	R/W	D0973	40973	03CC	SPH.2	SPH_L2 (D5230)	R/W
D0924	40924	039B				D0974	40974	03CD	SPL.2	SPL_L2 (D5231)	R/W
D0925	40925	039C				D0975	40975	03CE	DY1.2	DYN1_L2 (D3949)	R/W
D0926	40926	039D				D0976	40976	03CF	DY2.2	DYN2_L2 (D3950)	R/W
D0927	40927	039E	MOD.1	ALG_L1 (D5005)	R/W	D0977	40977	03D0	DY3.2	DYN3_L2 (D3951)	R/W
D0928	40928	039F	AR.1	AR_L1 (D3526)	R/W	D0978	40978	03D1	DY4.2	DYN4_L2 (D3952)	R/W
D0929	40929	03A0	ZON	ZON (D5012)	R/W	D0979	40979	03D2			
D0930	40930	03A1	R.MD	R.MD (D6401)	R/W	D0980	40980	03D3			
D0931	40931	03A2	R.TM	R.TM (D6402)	R/W	D0981	40981	03D4			
D0932	40932	03A3				D0982	40982	03D5			
D0933	40933	03A4	SPH.1	SPH_L1 (D5210)	R/W	D0983	40983	03D6			
D0934	40934	03A5	SPL.1	SPL_L1 (D5211)	R/W	D0984	40984	03D7			
D0935	40935	03A6	DY1.1	DYN1_L1 (D2849)	R/W	D0985	40985	03D8			
D0936	40936	03A7	DY2.1	DYN2_L1 (D2850)	R/W	D0986	40986	03D9			
D0937	40937	03A8	DY3.1	DYN3_L1 (D2851)	R/W	D0987	40987	03DA			
D0938	40938	03A9	DY4.1	DYN4_L1 (D2852)	R/W	D0988	40988	03DB			
D0939	40939	03AA				D0989	40989	03DC			
D0940	40940	03AB	GRP	SPGR. (D5007)	R/W	D0990	40990	03DD			
D0941	40941	03AC	RMS.2	RMS_L2 (D3801)	R/W	D0991	40991	03DE			
D0942	40942	03AD	SPT.2	SPT_L2 (D3810)	R/W	D0992	40992	03DF			
D0943	40943	03AE	PVT.2	PVT_L2 (D3811)	R/W	D0993	40993	03E0			
D0944	40944	03AF	TMU.2	TMU_L2 (D3807)	R/W	D0994	40994	03E1			
D0945	40945	03B0				D0995	40995	03E2			
D0946	40946	03B1				D0996	40996	03E3			
D0947	40947	03B2				D0997	40997	03E4			
D0948	40948	03B3				D0998	40998	03E5			
D0949	40949	03B4				D0999	40999	03E6			
D0950	40950	03B5				D1000	41000	03E7			

14.6.10 Common Function Parameters (D1001 to D1100)

Configuration map for GREEN Series											
Common function parameters											
D-Reg No.	Ref. No.	H No.	Register symbol for GREEN	Register symbol for UTAdvanced	R/W	D-Reg No.	Ref. No.	H No.	Register symbol for GREEN	Register symbol for UTAdvanced	R/W
D1001	41001	03E8	A.BS1	A.BS (D5112)	R/W	D1051	41051	041A			
D1002	41002	03E9	A.FL1	A.FL (D5113)	R/W	D1052	41052	041B			
D1003	41003	03EA	A.SR1	A.SR (D5114)	R/W	D1053	41053	041C			
D1004	41004	03EB	A.LC1	A.LC (D5115)	R/W	D1054	41054	041D			
D1005	41005	03EC	A.BS2	A.BS_E1 (D5133)	R	D1055	41055	041E			
D1006	41006	03ED	A.FL2	A.FL_E1 (D5134)	R	D1056	41056	041F			
D1007	41007	03EE	A.SR2	A.SR_E1 (D5135)	R	D1057	41057	0420			
D1008	41008	03EF	A.LC2	A.LC_E1 (D5136)	R	D1058	41058	0421			
D1009	41009	03F0	A.BS3	A.BS_E4 (D5192)	R/W	D1059	41059	0422			
D1010	41010	03F1	A.FL3	A.FL_E4 (D5193)	R/W	D1060	41060	0423			
D1011	41011	03F2	A.SR3	A.SR_E4 (D5194)	R/W	D1061	41061	0424			
D1012	41012	03F3	A.LC3	A.LC_E4 (D5195)	R/W	D1062	41062	0425			
D1013	41013	03F4	RET1	RTS (D5321)	R/W	D1063	41063	0426			
D1014	41014	03F5	RTH1	RTH (D5322)	R/W	D1064	41064	0427			
D1015	41015	03F6	RTL1	RTL (D5323)	R/W	D1065	41065	0428			
D1016	41016	03F7	RET2	O1RS (D5324)	R/W	D1066	41066	0429			
D1017	41017	03F8	RTH2	O1RH (D5325)	R/W	D1067	41067	042A			
D1018	41018	03F9	RTL2	O1RL (D5326)	R/W	D1068	41068	042B			
D1019	41019	03FA	DVB1	DVB_L1 (D5711)	R/W	D1069	41069	042C			
D1020	41020	03FB	DVB2	DVB_L2 (D5712)	R/W	D1070	41070	042D			
D1021	41021	03FC	TSC1		R	D1071	41071	042E			
D1022	41022	03FD	TSC2		R	D1072	41072	042F			
D1023	41023	03FE	TTM		R	D1073	41073	0430			
D1024	41024	03FF	▲▼	DATA-L (D5819)	R/W	D1074	41074	0431			
D1025	41025	0400	A/M	A/M-L (D5820)	R/W	D1075	41075	0432			
D1026	41026	0401				D1076	41076	0433			
D1027	41027	0402				D1077	41077	0434			
D1028	41028	0403	MODE		R	D1078	41078	0435			
D1029	41029	0404				D1079	41079	0436			
D1030	41030	0405	LP1		R	D1080	41080	0437			
D1031	41031	0406	LP2		R	D1081	41081	0438			
D1032	41032	0407	PID		R	D1082	41082	0439			
D1033	41033	0408	USR		R	D1083	41083	043A			
D1034	41034	0409	PYS1		R	D1084	41084	043B			
D1035	41035	040A	PYS2		R	D1085	41085	043C			
D1036	41036	040B				D1086	41086	043D			
D1037	41037	040C				D1087	41087	043E			
D1038	41038	040D				D1088	41088	043F			
D1039	41039	040E				D1089	41089	0440			
D1040	41040	040F				D1090	41090	0441			
D1041	41041	0410				D1091	41091	0442			
D1042	41042	0411				D1092	41092	0443			
D1043	41043	0412				D1093	41093	0444			
D1044	41044	0413				D1094	41094	0445			
D1045	41045	0414				D1095	41095	0446			
D1046	41046	0415				D1096	41096	0447			
D1047	41047	0416				D1097	41097	0448			
D1048	41048	0417				D1098	41098	0449			
D1049	41049	0418				D1099	41099	044A			
D1050	41050	0419				D1100	41100	044B			

14.6 GREEN Series Compatible D Registers

14.6.11 Display and Input / Output Parameters (D1101 to D1200)

Configuration map for GREEN Series											
Display and input / Output parameters											
D-Reg No.	Ref. No.	H No.	Register symbol for GREEN	Register symbol for UTAdvanced	R/W	D-Reg No.	Ref. No.	H No.	Register symbol for GREEN	Register symbol for UTAdvanced	R/W
D1101	41101	044C	C.S1		R	D1151	41151	047E			
D1102	41102	044D	C.S2		R	D1152	41152	047F			
D1103	41103	044E	C.S3		R	D1153	41153	0480			
D1104	41104	044F	C.S4		R	D1154	41154	0481			
D1105	41105	0450	C.S5		R	D1155	41155	0482			
D1106	41106	0451	DO1		R	D1156	41156	0483			
D1107	41107	0452	DO2		R	D1157	41157	0484			
D1108	41108	0453	DO3		R	D1158	41158	0485			
D1109	41109	0454	DO4		R	D1159	41159	0486			
D1110	41110	0455	DO5		R	D1160	41160	0487			
D1111	41111	0456	DO6		R	D1161	41161	0488			
D1112	41112	0457	DO7		R	D1162	41162	0489			
D1113	41113	0458	R151		R	D1163	41163	048A			
D1114	41114	0459	R152		R	D1164	41164	048B			
D1115	41115	045A	R153		R	D1165	41165	048C			
D1116	41116	045B	R154		R	D1166	41166	048D			
D1117	41117	045C	R155		R	D1167	41167	048E			
D1118	41118	045D	R156		R	D1168	41168	048F			
D1119	41119	045E	R157		R	D1169	41169	0490			
D1120	41120	045F	R158		R	D1170	41170	0491	PYA1		R
D1121	41121	0460	R251		R	D1171	41171	0492	PYB1		R
D1122	41122	0461	R252		R	D1172	41172	0493	PYA2		R
D1123	41123	0462	R253		R	D1173	41173	0494	PYB2		R
D1124	41124	0463	R254		R	D1174	41174	0495			
D1125	41125	0464	R255		R	D1175	41175	0496			
D1126	41126	0465	R256		R	D1176	41176	0497			
D1127	41127	0466	R257		R	D1177	41177	0498			
D1128	41128	0467	R258		R	D1178	41178	0499			
D1129	41129	0468	A/M.1		R	D1179	41179	049A			
D1130	41130	0469	A/M.2		R	D1180	41180	049B			
D1131	41131	046A	R/L.1		R	D1181	41181	049C			
D1132	41132	046B	R/L.2		R	D1182	41182	049D			
D1133	41133	046C	S/R		R	D1183	41183	049E			
D1134	41134	046D	CAS		R	D1184	41184	049F			
D1135	41135	046E	AUT		R	D1185	41185	04A0			
D1136	41136	046F	MAN		R	D1186	41186	04A1			
D1137	41137	0470	SP.b0		R	D1187	41187	04A2			
D1138	41138	0471	SP.b1		R	D1188	41188	04A3			
D1139	41139	0472	SP.b2		R	D1189	41189	04A4			
D1140	41140	0473	SP.b3		R	D1190	41190	04A5			
D1141	41141	0474	DP1		R	D1191	41191	04A6			
D1142	41142	0475	DP2		R	D1192	41192	04A7			
D1143	41143	0476	MG1		R	D1193	41193	04A8			
D1144	41144	0477	MG2		R	D1194	41194	04A9			
D1145	41145	0478	MG3		R	D1195	41195	04AA			
D1146	41146	0479	MG4		R	D1196	41196	04AB			
D1147	41147	047A				D1197	41197	04AC			
D1148	41148	047B				D1198	41198	04AD			
D1149	41149	047C				D1199	41199	04AE			
D1150	41150	047D				D1200	41200	04AF			

14.6.12 Control Mode, PV Input, and Control Output Parameters (D1201 to D1300)

Configuration map for GREEN Series											
Control mmode, PV input, and Control output parameters											
D-Reg No.	Ref. No.	H No.	Register symbol for GREEN	Register symbol for UTAdvanced	R/W	D-Reg No.	Ref. No.	H No.	Register symbol for GREEN	Register symbol for UTAdvanced	R/W
D1201	41201	04B0	IN1	IN (D5101)	R/W	D1251	41251	04E2	DLN1	Depends on the conditions (Note1)	R/W
D1202	41202	04B1	UNI1	UNI (D5102)	R/W	D1252	41252	04E3	ADR1	Depends on the conditions (Note1)	R/W
D1203	41203	04B2	DP1	DP (D5103)	R	D1253	41253	04E4	RP.T1	Depends on the conditions (Note1)	R/W
D1204	41204	04B3	RH1	RH (D5104)	R/W	D1254	41254	04E5	PSL2	PSL_E4	R/W
D1205	41205	04B4	RL1	RL (D5105)	R/W	D1255	41255	04E6	BPS2	PRI_E4	R/W
D1206	41206	04B5	SDP1	SDP (D5106)	R/W	D1256	41256	04E7	PRI2	STP_E4	R/W
D1207	41207	04B6	SH1	SH (D5107)	R/W	D1257	41257	04E8	STP2	STP_E4	R/W
D1208	41208	04B7	SL1	SL (D5108)	R/W	D1258	41258	04E9	DLN2	DLN_E4	R/W
D1209	41209	04B8	BSL1	BSL (D5109)	R/W	D1259	41259	04EA	ADR2	ADR_E4	R/W
D1210	41210	04B9	RJC1	RJC (D5110)	R/W	D1260	41260	04EB	RP.T2	RP.T_E4	R/W
D1211	41211	04BA	IN2	IN_E1 (D5121)	R/W	D1261	41261	04EC	V.RS	V.RS (D5312)	R/W
D1212	41212	04BB	UNI2	UNI_E1 (D5122)	R/W	D1262	41262	04ED	V.L	V.L (D5313)	R
D1213	41213	04BC	DP2	DP_E1 (D5123)	R	D1263	41263	04EE	V.H	V.H (D5314)	R
D1214	41214	04BD	RH2	RH_E1 (D5124)	R	D1264	41264	04EF	TR.T	TR.T (D5315)	R/W
D1215	41215	04BE	RL2	RL_E1 (D5125)	R	D1265	41265	04F0	V.MOD	V.MOD (D5316)	R/W
D1216	41216	04BF	SDP2	SDP_E1 (D5126)	R	D1266	41266	04F1	INI	F.DEF (D6423)	R/W
D1217	41217	04C0	SH2	SH_E1 (D5127)	R	D1267	41267	04F2	V.AT	V.AT (D5311)	R/W
D1218	41218	04C1	SL2	SL_E1 (D5128)	R	D1268	41268	04F3	A1H	OU.H (D5331)	R/W
D1219	41219	04C2	BSL2	BSL_E1 (D5129)	R	D1269	41269	04F4	A1L	OU.L (D5332)	R/W
D1220	41220	04C3	RJC2	RJC_E1 (D5130)	R	D1270	41270	04F5	A2H	OU2.H (D5333)	R/W
D1221	41221	04C4	IN3	IN_E4 (D5181)	R/W	D1271	41271	04F6	A2L	OU2.L (D5334)	R/W
D1222	41222	04C5	UNI3	UNI_E4 (D5182)	R/W	D1272	41272	04F7	A3H	RET.H (D5335)	R/W
D1223	41223	04C6	DP3	DP_E4 (D5183)	R	D1273	41273	04F8	A3L	RET.L (D5336)	R/W
D1224	41224	04C7	RH3	RH_E4 (D5184)	R/W	D1274	41274	04F9			
D1225	41225	04C8	RL3	RL_E4 (D5185)	R/W	D1275	41275	04FA			
D1226	41226	04C9	SDP3	SDP_E4 (D5186)	R/W	D1276	41276	04FB			
D1227	41227	04CA	SH3	SH_E4 (D5187)	R/W	D1277	41277	04FC			
D1228	41228	04CB	SL3	SL_E4 (D5188)	R/W	D1278	41278	04FD			
D1229	41229	04CC	BSL3	BSL_E4 (5189)	R/W	D1279	41279	04FE			
D1230	41230	04CD	PUNI1	P.UNI_L1 (D5201)	R/W	D1280	41280	04FF	UTM	CTLM (D5001)	R/W
D1231	41231	04CE	PDP1	P.DP_L1 (D5202)	R/W	D1281	41281	0500	SMP	SMP (D5019)	R/W
D1232	41232	04CF	PRH1	P.RH_L1 (D5203)	R/W	D1282	41282	0501			
D1233	41233	04D0	PRL1	P.RL_L1 (D5204)	R/W	D1283	41283	0502			
D1234	41234	04D1	PUNI2	P.UNI_L2 (D5221)	R/W	D1284	41284	0503			
D1235	41235	04D2	PDP2	P.DP_L2 (D5222)	R/W	D1285	41285	0504			
D1236	41236	04D3	PRH2	P.RH_L2 (D5223)	R/W	D1286	41286	0505			
D1237	41237	04D4	PRL2	P.RL_L2 (D5224)	R/W	D1287	41287	0506			
D1238	41238	04D5	OT1		R	D1288	41288	0507			
D1239	41239	04D6	OT2		R	D1289	41289	0508			
D1240	41240	04D7	CT1	CT (D5303)	R/W	D1290	41290	0509			
D1241	41241	04D8	CT2	CT_L2 (D5308)	R/W	D1291	41291	050A			
D1242	41242	04D9	CTc1	CTc (D5304)	R/W	D1292	41292	050B			
D1243	41243	04DA	CTc2	CT_L2 (D5309)	R/W	D1293	41293	050C			
D1244	41244	04DB	AO1	OU.A (D5341)	R/W	D1294	41294	050D			
D1245	41245	04DC	AO2	OU2.A (D5342)	R/W	D1295	41295	050E			
D1246	41246	04DD	AO3	RET.A (D5343)	R/W	D1296	41296	050F			
D1247	41247	04DE	PSL1	Depends on the conditions (Note1)	R/W	D1297	41297	0510			
D1248	41248	04DF	BPS1	Depends on the conditions (Note1)	R/W	D1298	41298	0511			
D1249	41249	04E0	PRI1	Depends on the conditions (Note1)	R/W	D1299	41299	0512			
D1250	41250	04E1	STP1	Depends on the conditions (Note1)	R/W	D1300	41300	0513			

(Note 1): See the 14.6.15 D Registers Differing Depending on Conditions D1301 to D2000: Free area

14.6.13 D Registers Converted for GREEN Series

● Bit Configuration of D0001: AD1.E_G (A/D converter error status for GREEN Series)

Bit	Symbol		Event
	GREEN Series	UTAdvanced	
0	AD1ERR.st	ADERR (I4065)	PV input A/D converter error
1	AD2ERR.st		(Not used)
2	AD3ERR.st	ADERR_E1 (I4069)	AIN4 input (E4-terminal area) A/D converter error
3			
4	AD1BO.st	ADBO (I4073)	PV input burnout error
5	AD2BO.st		(Not used)
6	AD3BO.st	ADBO_E1 (I4077)	AIN4 input (E4-terminal area) burnout error
7			
8	RJC1ERR.st	RJCERR (I4070)	PV input RJC error
9	RJC2ERR.st		(Not used)
10			
11	VLV.ATERR.st	VALV_ATERR (I4082)	Valve position automatic adjustment error
12	VLV.BOUT.st	VALVBO (I4081)	Feedback input resistor/current burnout
13 to 15			

● Bit Configuration of D0002: PV1.E_L1_G (Loop-1 PV input error status for GREEN Series)

Bit	Symbol		Event
	GREEN Series	UTAdvanced	
0	PV1ADC.st		(Not used)
1	PV1BO.st	PVBO_L1 (I4097)	Loop-1 PV input burnout error
2	RJC1ERR.st		(Not used)
3			
4	PV1+over.st	PVPOV_L1 (I4101)	Loop-1 PV input over-scale
5	PV1-over.st	PVMOV_L1 (I4102)	Loop-1 PV input under-scale
6 to 7			
8	RSP1ADC.st		(Not used)
9	RSP1BO.st	RSPBO_L1 (I4098)	Loop-1 RSP input burnout error
10 to 11			
12	C.RSP1ADC.st		(Not used)
13	C.RSP1BO.st	CRSPB_L1 (I4099)	Burnout error when the Loop-1 RSP input is used for control.
14	AT1ERR.st	ATERR_L1 (I4111)	Loop-1 auto-tuning timeout error
15			

● Bit Configuration of D0008: MOD_L1_G (Loop-1 operation mode status for GREEN Series)

Bit	Symbol		Event
	GREEN Series	UTAdvanced	
0	A/M1.st	A.M (I4193)	0: AUTO, 1: MAN *1
1	R/L1.st	R.L_L1 (I4194)	0: Local, 1: Remote
2	R/S1.st	S.R (I4195)	0: Run, 1: Stop
3			
4	CAS.st	CAS_ON (I4197)	1: CAS *2
5	AUT.st	AUTO_ON (I4198)	1: AUTO *2
6	MAN.st	MAN_ON (I4199)	1: MAN *2
7 to 13			
14	AT1.st	AT_L1_ON (I4207)	0: Auto-tuning is OFF, 1: Auto-tuning is ON
15			

*1: Effective for the control modes except for cascade control and cascade secondary-loop control.

*2: Effective for cascade control mode and cascade secondary-loop control mode.

● Bit Configuration of D0011: ALM_G (Alarm status for GREEN Series)

Bit	Symbol		Event
	GREEN Series	UTAdvanced	
0	ALM11.st	ALM1_L1 (I4321)	'1' when Loop-1 alarm 1 is ON; '0' when OFF
1	ALM12.st	ALM2_L1 (I4322)	'1' when Loop-1 alarm 2 is ON; '0' when OFF
2	ALM13.st	ALM3_L1 (I4323)	'1' when Loop-1 alarm 3 is ON; '0' when OFF
3			
4	ALM14.st	ALM4_L1 (I4325)	'1' when Loop-1 alarm 4 is ON; '0' when OFF
5	OR1.st		(Not used)
6 to 7			
8	ALM21.st	ALM1_L2 (I4337)	'1' when Loop-1 alarm 1 is ON; '0' when OFF
9	ALM22.st	ALM2_L2 (I4338)	'1' when Loop-1 alarm 2 is ON; '0' when OFF
10	ALM23.st	ALM3_L2 (I4339)	'1' when Loop-1 alarm 3 is ON; '0' when OFF
11			
12	ALM24.st	ALM4_L2 (I4341)	'1' when Loop-1 alarm 4 is ON; '0' when OFF
13	OR2.st		(Not used)
14 to 15			

14.6 GREEN Series Compatible D Registers

● Bit Configuration of D0018: PV1.E_L2_G (Loop-2 PV input error status for GREEN Series)

Bit	Symbol		Event
	GREEN Series	UTAdvanced	
0	PV2ADC.st		(Not used)
1	PV2BO.st	PVBO_L2 (I4113)	Loop-2 PV input burnout error
2	RJC2ERR.st		(Not used)
3			
4	PV2+over.st	PVPOV_L2 (I4117)	Loop-2 PV input over-scale
5	PV2-over.st	PVMOV_L2 (I4118)	Loop-2 PV input under-scale
6 to 7			
8	RSP2ADC.st		(Not used)
9	RSP2BO.st	RSPBO_L2 (I4114)	Loop-2 RSP input burnout error
10 to 11			
12	C.RSP2ADC.st		(Not used)
13	C.RSP2BO.st	CRSPB_L2 (I4115)	Burnout error when the Loop-2 RSP input is used for control.
14	AT2ERR.st	ATERR_L2 (I4127)	Loop-2 auto-tuning timeout error
15			

● Bit Configuration of D0024: MOD_L2_G (Loop-2 operation mode status for GREEN Series)

Bit	Symbol		Event
	GREEN Series	UTAdvanced	
0	A/M2.st	A.M_L2 (I4225)	0: AUTO, 1: MAN
1	R/L2.st	R.L_L2 (I4226)	0: Local, 1: Remote
2 to 13			
14	AT2.st	AT_L2_ON (I4239)	0: Auto-tuning is OFF, 1: Auto-tuning is ON
15			

● Bit Configuration of D0035: PA.ER_G (Parameter error status for GREEN Series)

Bit	Symbol		Event
	GREEN Series	UTAdvanced	
0	CALB.E.st	CALB_ERR (I4002)	Calibration value error
1	UCALB.E.st		(Not used)
2	USER.E.st		(Not used)
3			
4	UTMD.st	SETPA_ERR (I4005)	Setup parameter error
5	RANGE.st	SETPA_ERR (I4005)	Setup parameter error
6	SETUP.st	SETPA_ERR (I4005)	Setup parameter error
7			
8	PARA.E.st	OPEPA_ERR (I4006)	Operation parameter error
9	MODE.E.st	CTLPA_ERR (I4011)	Control parameter error
10 to 13			
14	SYSTEM.E.st	SYSTEM_ERR (I4001)	System data error
15			

● Bit Configuration of D0036: ALO_G (Alarm-1 to alarm-4 output status for GREEN Series)

Bit	Symbol		Event
	GREEN Series	UTAdvanced	
0	ALO11	ALO1_L1 (I4353)	Output status where Loop-1 alarm output 1 is assigned. 0: When the alarm is turned off (alarm type: energized), or the alarm is turned on (alarm type: de-energized). (The relay contact is open.) 1: When the alarm is turned on (alarm type: energized), or the alarm is turned off (alarm type: de-energized). (The relay contact is closed.)
1	ALO12	ALO2_L1 (I4354)	Output status where Loop-1 alarm output 2 is assigned. For bit information, same as bit 0.
2	ALO13	ALO3_L1 (I4355)	Output status where Loop-1 alarm output 3 is assigned. For bit information, same as bit 0.
3			
4	ALO14	ALO4_L1 (I4357)	Output status where Loop-1 alarm output 4 is assigned. For bit information, same as bit 0.
5 to 7			
8	ALO21	ALO1_L2 (I4369)	Output status where Loop-2 alarm output 1 is assigned. For bit information, same as bit 0.
9	ALO22	ALO2_L2 (I4370)	Output status where Loop-2 alarm output 2 is assigned. For bit information, same as bit 0.
10	ALO23	ALO3_L2 (I4371)	Output status where Loop-2 alarm output 3 is assigned. For bit information, same as bit 0.
11			
12	ALO24	ALO4_L2 (I4373)	Output status where Loop-2 alarm output 4 is assigned. For bit information, same as bit 0.
13 to 15			

14.6.14 D Registers Differing in Content from GREEN Series

● Bit Configuration of D0033: DI00 (DI1 to DI3 terminal status)

Bit	Symbol		Event
	GREEN Series	UTAdvanced	
0	DI1.st	DI1	0: OFF 1: ON
1	DI2.st	DI2	0: OFF 1: ON
2	DI3.st	DI3	0: OFF 1: ON
3	DI4.st		(Not used)
4	DI5.st		(Not used)
5	DI6.st		(Not used)
6	DI7.st		(Not used)
7 to 15			

● D0302 to D0480: A1_L1_1 to A4_L1_8 (Loop-1 Alarm-1 setpoint to Alarm-8 setpoint of Groups 1 to 4)

When the Loop-1 Alarm-1 setpoint to Alarm-4 setpoint (D0915: AL1.1, D0916: AL2.1, D0917: AL3.1, D0918: AL4.1) are the following values (Deviation low limit alarm), the sign of the alarm setpoint is reversed and is set to UTAdvanced.

AL1.1, AL2.1, AL3.1, AL4.1 = 4, 6, 14, 16

- 4: Deviation low limit (energized, no stand-by action)
- 6: Deviation low limit (de-energized, no stand-by action)
- 14: Deviation low limit (energized, with stand-by action)
- 16: Deviation low limit (de-energized, with stand-by action)

(If the setting value is other than the above, the alarm setpoint is not changed.)

Loop-1 Alarm-1 setpoint to Alarm-8 setpoint of Groups 1

When D0915 (AL1.1) = 4, 6, 14, 16

	Symbol		Event
	GREEN Series	UTAdvanced	
D0302	1.A1	A1_L1_1 (D2504)	The sign of the alarm setpoint is reversed and is set to UTAdvanced. (Example: 1.A1=10 → 1.A1=-10)
D0327	2.A1	A1_L1_2 (D2524)	
D0352	3.A1	A1_L1_3 (D2544)	
D0377	4.A1	A1_L1_4 (D2564)	
D0402	5.A1	A1_L1_5 (D2584)	
D0427	6.A1	A1_L1_6 (D2604)	
D0452	7.A1	A1_L1_7 (D2624)	
D0477	8.A1	A1_L1_8 (D2644)	

Loop-1 Alarm-1 setpoint to Alarm-8 setpoint of Groups 2

When D0916 (AL2.1) = 4, 6, 14, 16

	Symbol		Event
	GREEN Series	UTAdvanced	
D0303	1.A2	A2_L1_1 (D2505)	The sign of the alarm setpoint is reversed and is set to UTAdvanced. (Example: 1.A2=10 → 1.A2=-10)
D0328	2.A2	A2_L1_2 (D2525)	
D0353	3.A2	A2_L1_3 (D2545)	
D0378	4.A2	A2_L1_4 (D2565)	
D0403	5.A2	A2_L1_5 (D2585)	
D0428	6.A2	A2_L1_6 (D2605)	
D0453	7.A2	A2_L1_7 (D2625)	
D0478	8.A2	A2_L1_8 (D2645)	

Loop-1 Alarm-1 setpoint to Alarm-8 setpoint of Groups 3

When D0917 (AL3.1) = 4, 6, 14, 16

	Symbol		Event
	GREEN Series	UTAdvanced	
D0304	1.A3	A3_L1_1 (D2506)	The sign of the alarm setpoint is reversed and is set to UTAdvanced. (Example: 1.A3=10 → 1.A3=-10)
D0329	2.A3	A3_L1_2 (D2526)	
D0354	3.A3	A3_L1_3 (D2546)	
D0379	4.A3	A3_L1_4 (D2566)	
D0404	5.A3	A3_L1_5 (D2586)	
D0429	6.A3	A3_L1_6 (D2606)	
D0454	7.A3	A3_L1_7 (D2626)	
D0479	8.A3	A3_L1_8 (D2646)	

Loop-1 Alarm-1 setpoint to Alarm-8 setpoint of Groups 4

When D0918 (AL4.1) = 4, 6, 14

	Symbol		Event
	GREEN Series	UTAdvanced	
D0305	1.A4	A4_L1_1 (D2507)	The sign of the alarm setpoint is reversed and is set to UTAdvanced. (Example: 1.A4=10 → 1.A4=-10)
D0330	2.A4	A4_L1_2 (D2527)	
D0355	3.A4	A4_L1_3 (D2547)	
D0380	4.A4	A4_L1_4 (D2567)	
D0405	5.A4	A4_L1_5 (D2587)	
D0430	6.A4	A4_L1_6 (D2607)	
D0455	7.A4	A4_L1_7 (D2627)	
D0480	8.A4	A4_L1_8 (D2647)	

● **D0502 to D0680: A1_L2_1 to A4_L2_8 (Loop-2 Alarm-1 setpoint to Alarm-8 setpoint of Groups 1 to 4)**

When the Loop-2 Alarm-1 setpoint to Alarm-4 setpoint (D0955: AL1.2, D0956: AL2.2, D0957: AL3.2, D0958: AL4.2) are the following values (Deviation low limit alarm), the sign of the alarm setpoint is reversed and is set to UTAdvanced.

AL1.2, AL2.2, AL3.2, AL4.2 = 4, 6, 14, 16

(For 4 to 46, refer to "●D0302 to D0480: A1_L1_1 to A4_L1_8" in the previous section.)

(If the setting value is other than the above, the alarm setpoint is not changed.)

Loop-2 Alarm-1 setpoint to Alarm-8 setpoint of Groups 1

When D0955 (AL1.2) = 4, 6, 14, 16

	Symbol		Event
	GREEN Series	UTAdvanced	
D0502	1.A1	A1_L2_1 (D3604)	The sign of the alarm setpoint is reversed and is set to UTAdvanced. (Example: 1.A1=10 → 1.A1=-10)
D0527	2.A1	A1_L2_2 (D3624)	
D0552	3.A1	A1_L2_3 (D3644)	
D0577	4.A1	A1_L2_4 (D3664)	
D0602	5.A1	A1_L2_5 (D3684)	
D0627	6.A1	A1_L2_6 (D3704)	
D0652	7.A1	A1_L2_7 (D3724)	
D0677	8.A1	A1_L2_8 (D3744)	

Loop-2 Alarm-1 setpoint to Alarm-8 setpoint of Groups 2

When D0956 (AL2.2) = 4, 6, 14, 16

	Symbol		Event
	GREEN Series	UTAdvanced	
D0503	1.A2	A2_L2_1 (D3605)	The sign of the alarm setpoint is reversed and is set to UTAdvanced. (Example: 1.A2=10 → 1.A2=-10)
D0528	2.A2	A2_L2_2 (D3625)	
D0553	3.A2	A2_L2_3 (D3645)	
D0578	4.A2	A2_L2_4 (D3665)	
D0603	5.A2	A2_L2_5 (D3685)	
D0628	6.A2	A2_L2_6 (D3705)	
D0653	7.A2	A2_L2_7 (D3725)	
D0678	8.A2	A2_L2_8 (D3745)	

14.6 GREEN Series Compatible D Registers

Loop-2 Alarm-1 setpoint to Alarm-8 setpoint of Groups 3

When D0957 (AL3.2) = 4, 6, 14, 16

	Symbol		Event
	GREEN Series	UTAdvanced	
D0504	1.A3	A3_L2_1 (D3606)	The sign of the alarm setpoint is reversed and is set to UTAdvanced. (Example: 1.A3=10 → 1.A3=-10)
D0529	2.A3	A3_L2_2 (D3626)	
D0554	3.A3	A3_L2_3 (D3646)	
D0579	4.A3	A3_L2_4 (D3666)	
D0604	5.A3	A3_L2_5 (D3686)	
D0629	6.A3	A3_L2_6 (D3706)	
D0654	7.A3	A3_L2_7 (D3726)	
D0679	8.A3	A3_L2_8 (D3746)	

Loop-2 Alarm-1 setpoint to Alarm-8 setpoint of Groups 4

When D0958 (AL4.2) = 4, 6, 14, 16

	Symbol		Event
	GREEN Series	UTAdvanced	
D0505	1.A4	A4_L2_1 (D3607)	The sign of the alarm setpoint is reversed and is set to UTAdvanced. (Example: 1.A4=10 → 1.A4=-10)
D0530	2.A4	A4_L2_2 (D3627)	
D0555	3.A4	A4_L2_3 (D3647)	
D0580	4.A4	A4_L2_4 (D3667)	
D0605	5.A4	A4_L2_5 (D3687)	
D0630	6.A4	A4_L2_6 (D3707)	
D0655	7.A4	A4_L2_7 (D3727)	
D0680	8.A4	A4_L2_8 (D3747)	

● D0915 to D0918: Loop-1 alarm-1 type to alarm-4 type

UTAdvanced

Register No.	Description		Range and meaning of value
D0915	AL1.T_L1	Loop-1 alarm-1 type	0: Disable 01: PV high limit 02: PV low limit 03: SP high limit 04: SP low limit 05: Deviation high limit 06: Deviation low limit 07: Deviation high and low limits
D0916	AL2.T_L1	Loop-1 alarm-2 type	08: Deviation within high and low limits 09: Target SP high limit 10: Target SP low limit 11: Target SP deviation high limit 12: Target SP deviation low limit 13: Target SP deviation high and low limits 14: Target SP deviation within high and low limits
D0917	AL3.T_L1	Loop-1 alarm-3 type	15: OUT high limit 16: OUT low limit 17: Cooling-side OUT high limit 18: Cooling-side OUT low limit 19: Analog input PV high limit 20: Analog input PV low limit 21: Analog input PV2 high limit 22: Analog input PV2 low limit 23: Analog input AIN2 high limit
D0918	AL4.T_L1	Loop-1 alarm-4 type	24: Analog input AIN2 low limit 25: Analog input AIN4 high limit 26: Analog input AIN4 low limit 27: Feedback input high limit 28: Feedback input low limit 29: PV velocity 30: Fault diagnosis 31: FAIL

GREEN Series

Register No.	Description		Range and meaning of value
D0915	AL1.1	Loop-1 alarm-1 type	OFF (0), 1 to 31 1: PV high limit (energized, no stand-by action) 2: PV low limit (energized, no stand-by action) 3: Deviation high limit (energized, no stand-by action) 4: Deviation low limit (energized, no stand-by action) 5: Deviation high limit (de-energized, no stand-by action) 6: Deviation low limit (de-energized, no stand-by action) For other alarm types, see "Changing Alarm Type" of GREEN series (UT750) User's manual.
D0916	AL2.1	Loop-1 alarm-2 type	OFF (0), 1 to 20, 25 to 31 1: PV high limit (energized, no stand-by action) 2: PV low limit (energized, no stand-by action)
D0917	AL3.1	Loop-1 alarm-3 type	3: Deviation high limit (energized, no stand-by action) 4: Deviation low limit (energized, no stand-by action) 5: Deviation high limit (de-energized, no stand-by action)
D0918	AL4.1	Loop-1 alarm-4 type	6: Deviation low limit (de-energized, no stand-by action) For other alarm types, see "Changing Alarm Type" of GREEN series (UT750) User's manual.

● D0940: SPGR. (Number of SP groups)

UTAdvanced

Register No.	Description		Range and meaning of value
D0940	SPGR.	Number of SP groups	Set a number of SP groups to use. 1 to 8

GREEN Series

Register No.	Description		Range and meaning of value
D0940	GRP	PID group number	Allows you to determine how many groups of setpoint, alarm and PID parameters the controller should show. 1: Show one set. 2: Show two sets. 3: Show three sets. 4: Show four sets. 5 to 8: Show as many groups of parameters as have been set.

14.6 GREEN Series Compatible D Registers

● D0955 to D0958: Loop-2 alarm-1 type to alarm-4 type
UTAdvanced

Register No.	Description		Range and meaning of value
D0955	AL1.T_L2	Loop-2 alarm-1 type	00: Disable 01: PV high limit 02: PV low limit 03: SP high limit 04: SP low limit 05: Deviation high limit 06: Deviation low limit 07: Deviation high and low limits 08: Deviation within high and low limits 09: Target SP high limit 10: Target SP low limit 11: Target SP deviation high limit 12: Target SP deviation low limit 13: Target SP deviation high and low limits 14: Target SP deviation within high and low limits 15: OUT high limit 16: OUT low limit 17: Cooling-side OUT high limit 18: Cooling-side OUT low limit 19: Analog input PV high limit 20: Analog input PV low limit 21: Analog input PV2 high limit 22: Analog input PV2 low limit 23: Analog input AIN2 high limit 24: Analog input AIN2 low limit 25: Analog input AIN4 high limit 26: Analog input AIN4 low limit 27: Feedback input high limit 28: Feedback input low limit 29: PV velocity 30: Fault diagnosis 31: FAIL
D0956	AL2.T_L2	Loop-2 alarm-2 type	
D0957	AL3.T_L2	Loop-2 alarm-2 type	
D0958	AL4.T_L2	Loop-2 alarm-4 type	

GREEN Series

Register No.	Description		Range and meaning of value
D0955	AL1.1	Loop-2 alarm-1 type	OFF (0), 1 to 31 1: PV high limit (energized, no stand-by action) 2: PV low limit (energized, no stand-by action) 3: Deviation high limit (energized, no stand-by action) 4: Deviation low limit (energized, no stand-by action) 5: Deviation high limit (de-energized, no stand-by action) 6: Deviation low limit (de-energized, no stand-by action) For other alarm types, see "Changing Alarm Type" of GREEN series (UT750) User's manual.
D0956	AL2.1	Loop-2 alarm-2 type	OFF (0), 1 to 20, 25 to 31 1: PV high limit (energized, no stand-by action) 2: PV low limit (energized, no stand-by action) 3: Deviation high limit (energized, no stand-by action) 4: Deviation low limit (energized, no stand-by action) 5: Deviation high limit (de-energized, no stand-by action) 6: Deviation low limit (de-energized, no stand-by action) For other alarm types, see "Changing Alarm Type" of GREEN series (UT750) User's manual.
D0957	AL3.1	Loop-2 alarm-3 type	
D0958	AL4.1	Loop-2 alarm-4 type	

● **D1240, D1241:**
D1242, D1243:
UTAdvanced

Register No.	Description		Range and meaning of value
D1240	CT	Control output cycle time Heating-side control output cycle time (in Heating/cooling control)	0.5 to 1000.0 s
D1241	CT_L2	Loop-1 Control output cycle time Heating-side control output cycle time (in Heating/cooling control)	
D1242	CTc	Cooling-side control output cycle time	
D1243	CTc_L2	Loop-2 Cooling-side control output cycle time	

GREEN Series

Register No.	Description		Range and meaning of value
D1240	CT1	Control output cycle time Heating-side control output cycle time (in Heating/cooling control)	1 to 1000 s
D1241	CT2	Loop-1 Control output cycle time Heating-side control output cycle time (in Heating/cooling control)	
D1242	CTc1	Cooling-side control output cycle time	
D1243	CTc2	Loop-2 Cooling-side control output cycle time	

● **D1266: Initialization to factory default value**
UTAdvanced

Register No.	Description		Range and meaning of value
D1266	F.DEF	Initialization to factory default value	-12345: Initialization, automatically returned to "0" after initialization.

GREEN Series

Register No.	Description		Range and meaning of value
D1266	INI	Parameter initialization	0: OFF 1: ON (Initialize parameters)

● **D1280: Control mode**
UTAdvanced

Register No.	Description		Range and meaning of value
D1280	CTLM	Control mode	1: SGL (Single-loop control) 2: CAS1 (Cascade primary-loop control) 3: CAS2 (Cascade secondary-loop control) 4: CAS (Cascade control) 5: BUM (Loop control for backup) 6: PVSW (Loop control with PV switching) 7: PVSEL (Loop control with PV auto-selector) 8: PVHD (Loop control with PV-hold function) 11: 2LP (Dual-loop control)

14.6 GREEN Series Compatible D Registers

GREEN Series

Register No.	Description		Range and meaning of value
D1280	UTM	Controller mode (UT mode)	1: Single-loop control 2: Cascade primary-loop control 3: Cascade secondary-loop control 4: Cascade control 5: Loop control for backup 6: Loop control with PV switching 7: Loop control with PV auto-selector 11: Dual-loop control 12: Temperature and Humidity Control 13: Cascade Control with Two Universal Inputs 14: Loop Control with PV Switching and Two Universal Inputs 15: Loop Control with PV Auto-selector and Two Universal Inputs

● D1281: PV input sampling period (control period)

UTAdvanced

Register No.	Description		Range and meaning of value
D1281	SMP	Input sampling period (control period)	0: 50 (50 ms) 1: 100 (100 ms) 2: 200 (200 ms)

GREEN Series

Register No.	Description		Range and meaning of value
D1281	SMP	PV sampling period setting	0: 50 (50 ms) 1: 100 (100 ms) 2: 200 (200 ms) 3: 500 (500 ms)

14.6.15 D Registers Differing Depending on Conditions

● D registers differing depending on the setting of the control type (CNT_L1)

Example: When CNT_L1 = 0, 1, 2, 5, 6, or 7, D0310 is D3005 (OL_L1_1) data.

When CNT_L1 = 3 or 4, D0310 is D3016 (OHc_L1_1) data.

Register No.	Name of GREEN	PID	ONOF	ONOF2	2P2L	H/C	S-PI	BATCH	FFPID
		PID control	ON/OFF control (1 point of hysteresis)	ON/OFF control (2 points of hysteresis)	Two-position two-level control	Heating/cooling control	Sample PI control	Batch PID control	Feedforward control
		CNT_L1: 0	CNT_L1: 1	CNT_L1: 2	CNT_L1: 3	CNT_L1: 4	CNT_L1: 5	CNT_L1: 6	CNT_L1: 7
D0310	1.OL	D3005 (OL_L1_1)			D3016 (OHc_L1_1)		D3005 (OL_L1_1)		
D0335	2.OL	D3055 (OL_L1_2)			D3066 (OHc_L1_2)		D3055 (OL_L1_2)		
D0360	3.OL	D3105 (OL_L1_3)			D3116 (OHc_L1_3)		D3105 (OL_L1_3)		
D0385	4.OL	D3155 (OL_L1_4)			D3166 (OHc_L1_4)		D3155 (OL_L1_4)		
D0410	5.OL	D3205 (OL_L1_5)			D3216 (OHc_L1_5)		D3205 (OL_L1_5)		
D0435	6.OL	D3255 (OL_L1_6)			D3266 (OHc_L1_6)		D3255 (OL_L1_6)		
D0460	7.OL	D3305 (OL_L1_7)			D3316 (OHc_L1_7)		D3305 (OL_L1_7)		
D0485	8.OL	D3355 (OL_L1_8)			D3366 (OHc_L1_8)		D3355 (OL_L1_8)		

● D registers differing depending on the setting of the control type (CNT_L2)

Example: When CNT_L2 = 0, D0510 is D4105 (OL_L2_1) data.

When CNT_L2 = 4, D0510 is D4116 (OHc_L2_1) data.

Register No.	Name of GREEN	PID	H/C
		PID control	Heating/cooling control
		CNT_L2: 0	CNT_L2: 4
D0510	1.OL	D4105 (OL_L2_1)	D4116 (OHc_L2_1)
D0535	2.OL	D4155 (OL_L2_2)	D4166 (OHc_L2_2)
D0560	3.OL	D4205 (OL_L2_3)	D4216 (OHc_L2_3)
D0585	4.OL	D4255 (OL_L2_4)	D4266 (OHc_L2_4)
D0610	5.OL	D4305 (OL_L2_5)	D4316 (OHc_L2_5)
D0635	6.OL	D4355 (OL_L2_6)	D4366 (OHc_L2_6)
D0660	7.OL	D4405 (OL_L2_7)	D4416 (OHc_L2_7)
D0685	8.OL	D4455 (OL_L2_8)	D4466 (OHc_L2_8)

● D registers differing depending on the setting of the control mode (CTLM)

Example: When CTLM = 1, 2, 3, 4, or 5, D0701 is 0.

When CTLM = 6, D0701 is PV.HL.

When CTLM = 7, D0701 is PV.AS.

Register No.	Name of GREEN	Single-loop control	Cascade primary-loop control	Cascade secondary-loop control	Cascade control	Loop control for backup	Loop control with PV switching	Loop control with PV auto-selector
		CTLM: 1	CTLM: 2	CTLM: 3	CTLM: 4	CTLM: 5	CTLM: 6	CTLM: 7
D0701	U1	0	0	0	0	0	D5205 (PV.HL)	D5208 (PV.AS)
D0702	U2	0	0	0	0	0	D5206 (PV.LL)	0
D0703	U3	0	0	0	0	0	D5207 (PV.2C)	0

Register No.	Name of GREEN	Dual-loop control	Temperature and Humidity Control	Cascade Control with Two Universal Inputs	Loop Control with PV Switching and Two Universal Inputs	Loop Control with PV Auto-selector and Two Universal Inputs
		CTLM: 11	CTLM: 12	CTLM: 13	CTLM: 14	CTLM: 15
D0701	U1	0	Unavailable			
D0702	U2	0				
D0703	U3	0				

Note: "0" indicates on parameter specification. In communication, "0" is returned.

14.6 GREEN Series Compatible D Registers

- D registers differing depending on the model

Example: D1247 is PSL_E4.

Register No.	Name of GREEN	UT75A
D1247	PSL1	D5521 (PSL_E3)
D1248	BPS1	D5522 (BPS_E3)
D1249	PRI1	D5523 (PRI_E3)
D1250	STP1	D5524 (STP_E3)
D1251	DLN1	D5525 (DLN_E3)
D1252	ADR1	D5526 (ADR_E3)
D1253	RPT1	D5527 (RPT_E3)

15.1 Overview

This chapter describes the functions and applications of the I relays.

I relays are used in ladder program, Modbus communication, PC link communication, and contact input / output functions.

I relays contain status information of errors, operation, and alarms. Contents of I relays can be read only by means of communication using a host computer. (Note that the I relays have the same information as the D registers but with I relays, some of the information is read-only.)

- ▶ [Contact input and output functions: Chapter 12 Contact Input and Output Functions of the UTAdvanced User's Manual](#)

Use of the I relays enables the following:

- Centralized control by the host computer

D registers and I relays on the UTAdvanced are used for parameter settings or ladder program creations of LL50A Parameter Setting Software.

15.2 Classification of I Relays

I relays are classified as shown below.

Classification of I Relay Map

I relay No.	Area and data categories	Description	
1 to 192	GREEN series (See 15.5 I Relays Corresponding to GREEN Series)	Status	Each bit information is the same as that of D register.
193 to 576		Free area	
577 to 640		SP number, PID number, Pattern number, Segment number (Note 1)	Each bit information is the same as that of D register.
641 to 720		Status	Each bit information is the same as that of D register.
721 to 2048		User area	
2049 to 4000		Free area	
4001 to 4064	Function status	System error	Each bit information is the same as that of D register.
4065 to 4128		Input error	Each bit information is the same as that of D register.
4129 to 4192		Free area	
4193 to 4256		Operation Mode	Each bit information of 4193 to 4240 is the same as that of D register. For 4241 to 4256, see the section 15.3.1.
4257 to 4320		Pattern signal	See the section 15.3.1.
4321 to 4384		Alarm	Each bit information is the same as that of D register.
4385 to 4528		Alarm latch	Each bit information of 4385 to 4512 is the same as that of D register. For 4385 to 4512, see the section 15.3.1.
4529 to 4576		Free area	
4577 to 4704		SP number, PID number, Segment number, Program operation status	Each bit information is the same as that of D register. For 4673 to 4679, see the section 15.3.1.
4705 to 4768		Key	Each bit information is the same as that of D register.
4769 to 4784		Display	Each bit information is the same as that of D register.
4785 to 4896		Free area	
4897 to 4916		Pattern segment	
4917 to 5024		Free area	
5025 to 5152	Status for ladder program	Input (status) relay	Each bit information is the same as that of D register.
5153 to 5280		Output (status) relay	Each bit information is the same as that of D register.
5281 to 5536		Control (status) relay	Each bit information is the same as that of D register.
5537 to 5600		Special relay	Each bit information of 5409 to 5540 is the same as that of D register. For 5441 to 5472, see the section 15.3.2.
5473 to 5536		Free area	
5537 to 5792		Internal relay	Each bit information is the same as that of D register.
5793 to 6048		Free area	
6049 to 6240		Peer-to-peer communication register	See the section 15.3.2.
6241 to 6304		Free area	
6305 to 6432	Input / Output terminal status	DI terminal	Each bit information is the same as that of D register.
6433 to 6560		DO terminal	Each bit information is the same as that of D register.
6561 to 7072		Free area	

For Ladder

CAUTION

- Check the model and suffix codes and parameter settings before writing to or read from the registers to be used.
 - In the area for I relay numbers 4001 to 6560, it is prohibited to write data to I relays with blank cells in I relay map tables. If you attempt to do so, the UTAdvanced may not operate properly.
-

Note

- I relay numbers 4001 to 6560 store ON/OFF status information and are normally read for ON/OFF status information.
-

■ How to Specify I Relay Numbers

When specifying an I relay number for communication, begin the number with the character "I."

Example: Set "I4066" to specify the ADERR_E1 (I relay No.: 4066).

■ I relay symbol

- With regards to some register symbols, the loop number and terminal area are indicated by adding the underline () to the end of the parameter symbols.

□□□□_Ln Ln: Loop numbers (L1 or L2)
 □□□□_En En: Terminal area (E1 to E4)

Example : **PVBO_L1** Indicates Loop-1 PVBO.
ADERR_E1 Indicates ADERR in E1-terminal area.

15.3 UT75A I Relays

15.3.1 Function Status (4001 to 5024)

Note

When specifying an I relay number for communication, begin the number with the character "I."
Example: Set "I4065" to specify the ADERR (I relay No.: 4065).

System error			Input error		
NO.	I relay symbol	R/W UT75A	NO.	I relay symbol	R/W UT75A
4001	SYSTEM_ERR	R	4065	ADERR	R
4002	CALB_ERR	R	4066	ADERR_E1	R
4003	UPARA_ERR	R	4067	ADERR_E2	R
4004			4068		
4005	SETPA_ERR	R	4069	ADERR_E4	R
4006	OPEPA_ERR	R	4070	RJCERR	R
4007			4071	RJCERR_E1	R
4008			4072		
4009	FRAM_ERR	R	4073	ADBO	R
4010			4074	ADBO_E1	R
4011	CTLPA_ERR	R	4075	ADBO_E2	R
4012			4076		
4013			4077	ADBO_E4	R
4014			4078		
4015			4079		
4016			4080		
4017	LAD_ERR	R	4081	VALVBO	R
4018	LAD_OVER	R	4082	VALV_ATERR	R
4019	LAD_P_ERR	R	4083		
4020			4084		
4021	LD100_OVER	R	4085		
4022	LD200_OVER	R	4086		
4023			4087		
4024			4088		
4025			4089		
4026			4090		
4027			4091		
4028			4092		
4029			4093		
4030			4094		
4031			4095		
4032			4096		
4033	E1_ERR	R	4097	PVBO_L1	R
4034	E2_ERR	R	4098	RSPBO_L1	R
4035	E3_ERR	R	4099	CRSPBO_L1	R
4036			4100		
4037	E4_ERR	R	4101	PVPOVER_L1	R
4038			4102	PVMOVER_L1	R
4039			4103		
4040			4104		
4041			4105		
4042			4106		
4043	COM_E3_ERR	R	4107		
4044			4108		
4045	COM_E4_ERR	R	4109		
4046			4110		
4047			4111	ATERR_L1	R
4048			4112		
4049			4113	PVBO_L2	R
4050			4114	RSPBO_L2	R
4051			4115	CRSPBO_L2	R
4052			4116		
4053			4117	PVPOVER_L2	R
4054			4118	PVMOVER_L2	R
4055			4119		
4056			4120		
4057			4121		
4058			4122		
4059			4123		
4060			4124		
4061			4125		
4062			4126		
4063			4127	ATERR_L2	R
4064			4128		

15.3 UT75A I Relays

Operation mode			Operation mode			Operation mode		
NO.	I relay symbol	R/W UT75A	NO.	I relay symbol	R/W UT75A	NO.	I relay symbol	R/W UT75A
4129			4193	A.M *1	R/W	4257		
4130			4194	R.L_L1	R/W	4258		
4131			4195	S.R	R/W	4259		
4132			4196			4260		
4133			4197	CAS_ON *2	R/W	4261		
4134			4198	AUTO_ON *2	R/W	4262		
4135			4199	MAN_ON *2	R/W	4263		
4136			4200			4264		
4137			4201	TRK_ON_L1	R/W	4265		
4138			4202			4266		
4139			4203			4267		
4140			4204			4268		
4141			4205			4269		
4142			4206			4270		
4143			4207	AT_L1_ON	R/W	4271		
4144			4208			4272		
4145			4209	VALV_AT	R	4273		
4146			4210	VALV_GUSS	R	4274		
4147			4211			4275		
4148			4212			4276		
4149			4213	VALV_OPEN	R	4277		
4150			4214	VALV_CLOSE	R	4278		
4151			4215			4279		
4152			4216			4280		
4153			4217			4281		
4154			4218			4282		
4155			4219			4283		
4156			4220			4284		
4157			4221			4285		
4158			4222			4286		
4159			4223			4287		
4160			4224			4288		
4161			4225	A.M_L2 *3	R/W	4289		
4162			4226	R.L_L2 *3	R/W	4290		
4163			4227	S.R_L2 *3	R/W	4291		
4164			4228			4292		
4165			4229			4293		
4166			4230			4294		
4167			4231			4295		
4168			4232			4296		
4169			4233			4297		
4170			4234			4298		
4171			4235			4299		
4172			4236			4300		
4173			4237			4301		
4174			4238			4302		
4175			4239	AT_L2_ON *3	R/W	4303		
4176			4240			4304		
4177			4241	C2_AMS_ON	R	4305	WTEND1	R
4178			4242			4306	WTEND3	R
4179			4243			4307	WTEND5	R
4180			4244			4308		
4181			4245	PROG	R/W	4309		
4182			4246	HOLD	R/W	4310		
4183			4247	ADV	R/W	4311		
4184			4248			4312		
4185			4249	WAITF	R	4313	PTEND1	R
4186			4250			4314	PTEND3	R
4187			4251			4315	PTEND5	R
4188			4252			4316		
4189			4253			4317		
4190			4254			4318		
4191			4255			4319		
4192			4256	FAIL_ALARM	R	4320		

*1: Effective for the control modes except for cascade control and cascade secondary-loop control.

*2: Effective for cascade control mode and cascade secondary-loop control mode.

*3: Effective for dual-loop control mode.

Alarm			Alarm latch			Alarm latch		
NO.	I relay symbol	R/W UT75A	NO.	I relay symbol	R/W UT75A	NO.	I relay symbol	R/W UT75A
4321	ALM1_L1	R	4385	ALO1LA1_L1	R	4449	ALO1LA3_L1	R
4322	ALM2_L1	R	4386	ALO2LA1_L1	R	4450	ALO2LA3_L1	R
4323	ALM3_L1	R	4387	ALO3LA1_L1	R	4451	ALO3LA3_L1	R
4324			4388			4452		
4325	ALM4_L1	R	4389	ALO4LA1_L1	R	4453	ALO4LA3_L1	R
4326	ALM5_L1	R	4390	ALO5LA1_L1	R	4454	ALO5LA3_L1	R
4327	ALM6_L1	R	4391	ALO6LA1_L1	R	4455	ALO6LA3_L1	R
4328			4392			4456		
4329	ALM7_L1	R	4393	ALO7LA1_L1	R	4457	ALO7LA3_L1	R
4330	ALM8_L1	R	4394	ALO8LA1_L1	R	4458	ALO8LA3_L1	R
4331			4395			4459		
4332			4396			4460		
4333			4397			4461		
4334			4398			4462		
4335			4399			4463		
4336			4400			4464		
4337	ALM1_L2	R	4401	ALO1LA1_L2	R	4465	ALO1LA3_L2	R
4338	ALM2_L2	R	4402	ALO2LA1_L2	R	4466	ALO2LA3_L2	R
4339	ALM3_L2	R	4403	ALO3LA1_L2	R	4467	ALO3LA3_L2	R
4340			4404			4468		
4341	ALM4_L2	R	4405	ALO4LA1_L2	R	4469	ALO4LA3_L2	R
4342	ALM5_L2	R	4406	ALO5LA1_L2	R	4470	ALO5LA3_L2	R
4343	ALM6_L2	R	4407	ALO6LA1_L2	R	4471	ALO6LA3_L2	R
4344			4408			4472		
4345	ALM7_L2	R	4409	ALO7LA1_L2	R	4473	ALO7LA3_L2	R
4346	ALM8_L2	R	4410	ALO8LA1_L2	R	4474	ALO8LA3_L2	R
4347			4411			4475		
4348			4412			4476		
4349			4413			4477		
4350			4414			4478		
4351			4415			4479		
4352			4416			4480		
4353	ALO1_L1	R	4417	ALO1LA2_L1	R	4481	ALO1LA4_L1	R
4354	ALO2_L1	R	4418	ALO2LA2_L1	R	4482	ALO2LA4_L1	R
4355	ALO3_L1	R	4419	ALO3LA2_L1	R	4483	ALO3LA4_L1	R
4356			4420			4484		
4357	ALO4_L1	R	4421	ALO4LA2_L1	R	4485	ALO4LA4_L1	R
4358	ALO5_L1	R	4422	ALO5LA2_L1	R	4486	ALO5LA4_L1	R
4359	ALO6_L1	R	4423	ALO6LA2_L1	R	4487	ALO6LA4_L1	R
4360			4424			4488		
4361	ALO7_L1	R	4425	ALO7LA2_L1	R	4489	ALO7LA4_L1	R
4362	ALO8_L1	R	4426	ALO8LA2_L1	R	4490	ALO8LA4_L1	R
4363			4427			4491		
4364			4428			4492		
4365			4429			4493		
4366			4430			4494		
4367			4431			4495		
4368			4432			4496		
4369	ALO1_L2	R	4433	ALO1LA2_L2	R	4497	ALO1LA4_L2	R
4370	ALO2_L2	R	4434	ALO2LA2_L2	R	4498	ALO2LA4_L2	R
4371	ALO3_L2	R	4435	ALO3LA2_L2	R	4499	ALO3LA4_L2	R
4372			4436			4500		
4373	ALO4_L2	R	4437	ALO4LA2_L2	R	4501	ALO4LA4_L2	R
4374	ALO5_L2	R	4438	ALO5LA2_L2	R	4502	ALO5LA4_L2	R
4375	ALO6_L2	R	4439	ALO6LA2_L2	R	4503	ALO6LA4_L2	R
4376			4440			4504		
4377	ALO7_L2	R	4441	ALO7LA2_L2	R	4505	ALO7LA4_L2	R
4378	ALO8_L2	R	4442	ALO8LA2_L2	R	4506	ALO8LA4_L2	R
4379			4443			4507		
4380			4444			4508		
4381			4445			4509		
4382			4446			4510		
4383			4447			4511		
4384			4448			4512		

15.3 UT75A I Relays

Alarm latch			SP number and PID number			Segment number, Operation status		
NO.	I relay symbol	R/W UT75A	NO.	I relay symbol	R/W UT75A	NO.	I relay symbol	R/W UT75A
4513	ALOLA_RLS	R/W	4577	CSPN.B0	R	4641		
4514	ALM_WAIT	R/W	4578	CSPN.B1	R	4642		
4515			4579	CSPN.B2	R	4643		
4516			4580	CSPN.B3	R	4644		
4517			4581	CSPN.B4	R	4645		
4518			4582			4646		
4519			4583			4647		
4520			4584			4648		
4521			4585			4649		
4522			4586			4650		
4523			4587			4651		
4524			4588			4652		
4525			4589			4653		
4526			4590			4654		
4527			4591			4655		
4528			4592			4656		
4529			4593			4657	SEGNO.B0	R
4530			4594			4658	SEGNO.B1	R
4531			4595			4659	SEGNO.B2	R
4532			4596			4660	SEGNO.B3	R
4533			4597			4661	SEGNO.B4	R
4534			4598			4662		
4535			4599			4663		
4536			4600			4664		
4537			4601			4665		
4538			4602			4666		
4539			4603			4667		
4540			4604			4668		
4541			4605			4669		
4542			4606			4670		
4543			4607			4671		
4544			4608			4672		
4545			4609	PIDN.B0_L1	R	4673	RAMP_UP_L	R
4546			4610	PIDN.B1_L1	R	4674	SOAK_L	R
4547			4611	PIDN.B2_L1	R	4675	PAMP_DN_L	R
4548			4612	PIDN.B3_L1	R	4676		
4549			4613	PIDN.B4_L1	R	4677	RAMP_UP2_L	R
4550			4614			4678	SOAK2_L	R
4551			4615			4679	RAMP_DN2_L	R
4552			4616			4680		
4553			4617			4681		
4554			4618			4682		
4555			4619			4683		
4556			4620			4684		
4557			4621			4685		
4558			4622			4686		
4559			4623			4687		
4560			4624			4688		
4561			4625	PIDN.B0_L2	R	4689		
4562			4626	PIDN.B1_L2	R	4690		
4563			4627	PIDN.B2_L2	R	4691		
4564			4628	PIDN.B3_L2	R	4692		
4565			4629	PIDN.B4_L2	R	4693		
4566			4630			4694		
4567			4631			4695		
4568			4632			4696		
4569			4633			4697		
4570			4634			4698		
4571			4635			4699		
4572			4636			4700		
4573			4637			4701		
4574			4638			4702		
4575			4639			4703		
4576			4640			4704		

Key			Display		
NO.	I relay symbol	R/W	NO.	I relay symbol	R/W
		UT75A			UT75A
4705	PARA_KEY	R	4769	MG1.B	R
4706	DISP_KEY	R	4770	MG2.B	R
4707	RIGHT_KEY	R	4771	MG3.B	R
4708	DOWN_KEY	R	4772		
4709	SET_KEY	R	4773	MG4.B	R
4710	UP_KEY	R	4774		
4711	LEFT_KEY	R	4775		
4712	F2_KEY	R	4776		
4713	F1_KEY	R	4777		
4714	A/M_KEY	R	4778		
4715	FN_KEY	R	4779	PVRW1	R
4716			4780	PVRW2	R
4717			4781	DP1	R
4718			4782	DP2	R
4719			4783		
4720			4784		
4721			4785		
4722			4786		
4723			4787		
4724			4788		
4725			4789		
4726			4790		
4727			4791		
4728			4792		
4729			4793		
4730			4794		
4731			4795		
4732			4796		
4733			4797		
4734			4798		
4735			4799		
4736			4800		
4737			4801		
4738			4802		
4739			4803		
4740			4804		
4741			4805		
4742			4806		
4743			4807		
4744			4808		
4745			4809		
4746			4810		
4747			4811		
4748			4812		
4749			4813		
4750			4814		
4751			4815		
4752			4816		
4753			4817		
4754			4818		
4755			4819		
4756			4820		
4757			4821		
4758			4822		
4759			4823		
4760			4824		
4761			4825		
4762			4826		
4763			4827		
4764			4828		
4765			4829		
4766			4830		
4767			4831		
4768			4832		

15.3 UT75A I Relays

Free area			Segment number status		
NO.	I relay symbol	R/W UT75A	NO.	I relay symbol	R/W UT75A
4833			4897	SEG1	R
4834			4898	SEG2	R
4835			4899	SEG3	R
4836			4900	SEG4	R
4837			4901	SEG5	R
4838			4902	SEG6	R
4839			4903	SEG7	R
4840			4904	SEG8	R
4841			4905	SEG9	R
4842			4906	SEG10	R
4843			4907	SEG11	R
4844			4908	SEG12	R
4845			4909	SEG13	R
4846			4910	SEG14	R
4847			4911	SEG15	R
4848			4912	SEG16	R
4849			4913	SEG17	R
4850			4914	SEG18	R
4851			4915	SEG19	R
4852			4916	SEG20	R
4853			4917		
4854			4918		
4855			4919		
4856			4920		
4857			4921		
4858			4922		
4859			4923		
4860			4924		
4861			4925		
4862			4926		
4863			4927		
4864			4928		
4865			4929		
4866			4930		
4867			4931		
4868			4932		
4869			4933		
4870			4934		
4871			4935		
4872			4936		
4873			4937		
4874			4938		
4875			4939		
4876			4940		
4877			4941		
4878			4942		
4879			4943		
4880			4944		
4881			4945		
4882			4946		
4883			4947		
4884			4948		
4885			4949		
4886			4950		
4887			4951		
4888			4952		
4889			4953		
4890			4954		
4891			4955		
4892			4956		
4893			4957		
4894			4958		
4895			4959		
4896			4960		

System Error, Input Error, and Operation Mode (4001 to 4320)

I relay No.	Symbol	Event	
4001 to 4016	SYSTEM_ERR to CTLPA_ERR	Parameter error status (Same as D2068)	
4017 to 4032	LAD_ERR to LD200_OVER	Ladder error status (Same as D2012)	
4033 to 4048	E1_ERR to COM_E4_ERR	Option error status (Same as D2070)	
4049 to 4064			
4065 to 4128	ADERR to ADBO_E4	A/D converter error status 1 (Same as D2001)	
	VALVBO to VALV_ATERR	A/D converter error status 2 (Same as D2065)	
	PVBO_L1 to ATERR_L1	Loop-1 PV input error status (Same as D2002)	
	PVBO_L2 to ATERR_L2	Loop-2 PV input error status (Same as D2018)	
4129 to 4192	Free Area		
4193 to 4208	A.M_L1 to AT_L1_ON	Loop-1 operation mode status (Same as D2008)	
4209 to 4224	VALV_AT to VALV_CLOSE	Valve status (Same as D2064)	
4225 to 4240	A.M_L2 to AT_L2_ON	Loop-2 operation mode status (Same as D2024)	
4241 to 4256	C2_AMS_ON	AUTO/MAN/STOP status (Cascade secondary-loop)	0: OFF 1: ON
	PROG	Program operation status	0: Stop of program operation 1: Start of program operation
	HOLD	Hold operation status	1: Pause
	ADV	Advance status	1: Advance of segment
	WAITF	Wait status	1: Wait
	FAIL_ALARM	FAIL alarm status (For contact output. Not available for the communication or the ladder program.)	0: FAIL alarm 1: OFF (Normal)
4257 to 4304	Free area		
4305 to 4320	WTEND1	Wait end signal (1 second)	0: OFF 1: ON
	WTEND3	Wait end signal (3 seconds)	
	WTEND5	Wait end signal (5 seconds)	
	PTEND1	Pattern end signal (1 second)	
	PTEND3	Pattern end signal (3 seconds)	
	PTEND5	Pattern end signal (5 seconds)	

15.3 UT75A I Relays

Alarm and Alarm Latch (4321 to 4576)

I relay No.	Symbol	Event	
4321 to 4336	ALM1_L1~ALM8_L1	Loop-1 alarm-1 to alarm-8 status (Same as D2011)	
4337 to 4352	ALM1_L2~ALM8_L2	Loop-2 alarm-1 to alarm-8 status (Same as D2013)	
4353 to 4368	ALO1_L1 to ALO8_L1	Loop-1 alarm-1 to alarm-8 output status (Same as D2037)	
4369 to 4384	ALO1_L2 to ALO8_L2	Loop-2 alarm-1 to alarm-8 output status (Same as D2038)	
4385 to 4400	ALO1LA1_L1 to ALO8LA1_L1	Loop-1 alarm-1 to alarm-8 latch output status (Same as D2071)	
4401 to 4416	ALO1LA1_L2 to ALO8LA1_L2	Loop-2 alarm-1 to alarm-8 latch output status (Same as D2072)	
4417 to 4432	ALO1LA2_L1 to ALO8LA2_L1	Loop-1 alarm-1 to alarm-8 latch-2 output status (Same as D2073)	
4433 to 4448	ALO1LA2_L2 to ALO8LA2_L2	Loop-2 alarm-1 to alarm-8 latch-2 output status (Same as D2074)	
4449 to 4464	ALO1LA3_L1 to ALO8LA3_L1	Loop-1 alarm-1 to alarm-8 latch-3 output status (Same as D2075)	
4465 to 4480	ALO1LA3_L2 to ALO8LA3_L2	Loop-2 alarm-1 to alarm-8 latch-3 output status (Same as D2076)	
4481 to 4496	ALO1LA4_L1 to ALO8LA4_L1	Loop-1 alarm-1 to alarm-8 latch-4 output status (Same as D2077)	
4497 to 4512	ALO1LA4_L2 to ALO8LA4_L2	Loop-2 alarm-1 to alarm-8 latch-4 output status (Same as D2078)	
4513	ALOLA_RLS	Alarm latch release flag	0: OFF 1: Latch release Automatically returned to "0".
4514	ALM_WAIT	Forced stand-by alarm flag	0: OFF 1: Forced stand-by Automatically returned to "0".
4529 to 4576			

SP Number, PID Number, Segment Number, and Program Operation Status (4577 to 4704)

I relay No.	Symbol	Event
4577 to 4592 *1	CSPN.B0 to CSPN.B4	SP number (Same as D2010)
4593 to 4608		
4609 to 4624 *1	PIDN.B0_L1 to PIDN.B4_L1	Loop-1 PID number (Same as D2009)
4625 to 4640 *1	PIDN.B0_L2 to PIDN.B4_L2	Loop-2 PID number (Same as D2025)
4641 to 4756	Free area	
4657 to 4661	SEGNO.B0 to SEGNO.B4	Segment number (Same as D2029)
4662 to 4672	Free area	
4673	RAMP_UP_L1	Ramp-up status lamp
4674	SOAK_L1	Soak status lamp
4675	RAMP_DN_L1	Ramp-down status lamp
4676	Free area	
4677	RAMP_UP_L2	Ramp-up status lamp (Program pattern-2 retransmission)
4678	SOAK_L2	Soak status lamp (Program pattern-2 retransmission)
4679	RAMP_DN_L2	Ramp-down status lamp (Program pattern-2 retransmission)
4680 to 4704	Free area	

*1: The information of I relays 4577 to 4592 and 4609 to 4640 is represented by 4-digit binary codes, from 0000 (0 in decimal) to 1000 (8 in decimal), which are formed by the bit combination of four I relays. The lowest-numbered I relay in each set signifies the LSB.

Key (4705 to 4768)

I relay No.	Symbol	Event
4705 to 4720	PARA_KEY to FN_KEY	Key status (Same as D6301)

15.3 UT75A I Relays

Display and Program Segment (4769 to 5024)

I relay No.	Symbol	Event	
4769 to 4773	MG1.B to MG4.B	Message display interruption status (Same as D2066)	
4779	PVRW1	Loop-1 PV red/white switch	0: White color
4780	PVRW2	Loop-2 PV red/white switch	1: Red color
4781	DP1	Operation display interruption 1	1: Displaying
4782	DP2	Operation display interruption 2	
4783 to 4896			
4797 to 4916	SEG1 to SEG20	Program segment	1: Running
4917 to 5024	Free area		

15.3.2 Status for Ladder Program (5025 to 5664)

Note

When specifying an I relay number for communication, begin the number with the character "I."
Example: Set "I5025" to specify the X_D11 (I relay No.: 5025).

15.3 UT75A I Relays

Input (status) relay			Input (status) relay		
NO.	I relay symbol	R/W UT75A	NO.	I relay symbol	R/W UT75A
5025	X_DI1	R	5089		
5026	X_DI2	R	5090		
5027	X_DI3	R	5091		
5028			5092		
5029			5093		
5030			5094	X_DI46	R
5031			5095		
5032			5096		
5033			5097		
5034			5098		
5035			5099		
5036			5100		
5037			5101		
5038			5102		
5039			5103		
5040			5104		
5041			5105		
5042			5106		
5043			5107		
5044			5108		
5045			5109		
5046			5110		
5047			5111		
5048			5112		
5049			5113		
5050			5114		
5051			5115		
5052			5116		
5053			5117		
5054			5118		
5055			5119		
5056			5120		
5057			5121		
5058			5122		
5059			5123		
5060			5124		
5061			5125		
5062	X_DI26	R	5126		
5063			5127		
5064			5128		
5065			5129		
5066			5130		
5067			5131		
5068			5132		
5069			5133		
5070			5134		
5071			5135		
5072			5136		
5073	X_DI31	R	5137		
5074	X_DI32	R	5138		
5075	X_DI33	R	5139		
5076	X_DI34	R	5140		
5077	X_DI35	R	5141		
5078			5142		
5079			5143		
5080			5144		
5081			5145		
5082			5146		
5083			5147		
5084			5148		
5085			5149		
5086			5150		
5087			5151		
5088			5152		

Output (status) relay			Output (status) relay		
NO.	I relay symbol	R/W	NO.	I relay symbol	R/W
		UT75A			UT75A
5153	Y_AL1	R/W	5217		
5154	Y_AL2	R/W	5218		
5155	Y_AL3	R/W	5219		
5156			5220		
5157			5221		
5158			5222		
5159			5223		
5160			5224		
5161			5225		
5162			5226		
5163			5227		
5164			5228		
5165			5229		
5166			5230		
5167			5231		
5168			5232		
5169			5233		
5170			5234		
5171			5235		
5172			5236		
5173			5237		
5174			5238		
5175			5239		
5176			5240		
5177			5241		
5178			5242		
5179			5243		
5180			5244		
5181			5245		
5182			5246		
5183			5247		
5184			5248		
5185	Y_DO21	R/W	5249		
5186	Y_DO22	R/W	5250		
5187	Y_DO23	R/W	5251		
5188	Y_DO24	R/W	5252		
5189	Y_DO25	R/W	5253		
5190			5254		
5191			5255		
5192			5256		
5193			5257		
5194			5258		
5195			5259		
5196			5260		
5197			5261		
5198			5262		
5199			5263		
5200			5264		
5201			5265		
5202			5266		
5203			5267		
5204			5268		
5205			5269		
5206			5270		
5207			5271		
5208			5272		
5209			5273		
5210			5274		
5211			5275		
5212			5276		
5213			5277		
5214			5278		
5215			5279		
5216			5280		

15.3 UT75A I Relays

Control (status) relay			Control (status) relay		
NO.	I relay symbol	R/W	NO.	I relay symbol	R/W
		UT75A			UT75A
5281	AL1_CTL	R	5345		
5282	AL2_CTL	R	5346		
5283	AL3_CTL	R	5347		
5284			5348		
5285			5349		
5286			5350		
5287			5351		
5288			5352		
5289			5353		
5290			5354		
5291			5355		
5292			5356		
5293			5357		
5294			5358		
5295			5359		
5296			5360		
5297			5361		
5298			5362		
5299			5363		
5300			5364		
5301			5365		
5302			5366		
5303			5367		
5304			5368		
5305			5369		
5306			5370		
5307			5371		
5308			5372		
5309			5373		
5310			5374		
5311			5375		
5312			5376		
5313	DO21_CTL	R	5377		
5314	DO22_CTL	R	5378		
5315	DO23_CTL	R	5379		
5316	DO24_CTL	R	5380		
5317	DO25_CTL	R	5381		
5318			5382		
5319			5383		
5320			5384		
5321			5385		
5322			5386		
5323			5387		
5324			5388		
5325			5389		
5326			5390		
5327			5391		
5328			5392		
5329			5393		
5330			5394		
5331			5395		
5332			5396		
5333			5397		
5334			5398		
5335			5399		
5336			5400		
5337			5401		
5338			5402		
5339			5403		
5340			5404		
5341			5405		
5342			5406		
5343			5407		
5344			5408		

Special relay			Free area		
NO.	I relay symbol	R/W	NO.	I relay symbol	R/W
		UT75A			UT75A
5409	TIM1	R	5473		
5410	TIM2	R	5474		
5411	TIM3	R	5475		
5412	TIM4	R	5476		
5413			5477		
5414			5478		
5415			5479		
5416			5480		
5417	TIM1_B	R	5481		
5418	TIM2_B	R	5482		
5419			5483		
5420			5484		
5421			5485		
5422			5486		
5423			5487		
5424			5488		
5425	CNT1	R	5489		
5426	CNT2	R	5490		
5427	CNT3	R	5491		
5428	CNT4	R	5492		
5429			5493		
5430			5494		
5431			5495		
5432			5496		
5433	CNT1_B	R	5497		
5434	CNT2_B	R	5498		
5435			5499		
5436			5500		
5437			5501		
5438			5502		
5439			5503		
5440			5504		
5441	SMPCLK	R	5505		
5442	CLK1	R	5506		
5443	CLK2	R	5507		
5444	CLK10	R	5508		
5445	CLK60	R	5509		
5446			5510		
5447	CLK1P	R	5511		
5448	CLK2P	R	5512		
5449	CLK10P	R	5513		
5450	CLK60P	R	5514		
5451			5515		
5452			5516		
5453			5517		
5454			5518		
5455			5519		
5456			5520		
5457	PON	R	5521		
5458	PLS1	R	5522		
5459	ZERO	R	5523		
5460			5524		
5461	PDLVL	R	5525		
5462			5526		
5463			5527		
5464			5528		
5465			5529		
5466			5530		
5467			5531		
5468			5532		
5469			5533		
5470			5534		
5471			5535		
5472			5536		

15.3 UT75A I Relays

Internal relay			Internal relay		
NO.	I relay symbol	R/W	NO.	I relay symbol	R/W
5537	M01	R/W	5601	M65	R/W
5538	M02	R/W	5602	M66	R/W
5539	M03	R/W	5603	M67	R/W
5540	M04	R/W	5604	M68	R/W
5541	M05	R/W	5605	M69	R/W
5542	M06	R/W	5606	M70	R/W
5543	M07	R/W	5607	M71	R/W
5544	M08	R/W	5608	M72	R/W
5545	M09	R/W	5609	M73	R/W
5546	M10	R/W	5610	M74	R/W
5547	M11	R/W	5611	M75	R/W
5548	M12	R/W	5612	M76	R/W
5549	M13	R/W	5613	M77	R/W
5550	M14	R/W	5614	M78	R/W
5551	M15	R/W	5615	M79	R/W
5552	M16	R/W	5616	M80	R/W
5553	M17	R/W	5617	M81	R/W
5554	M18	R/W	5618	M82	R/W
5555	M19	R/W	5619	M83	R/W
5556	M20	R/W	5620	M84	R/W
5557	M21	R/W	5621	M85	R/W
5558	M22	R/W	5622	M86	R/W
5559	M23	R/W	5623	M87	R/W
5560	M24	R/W	5624	M88	R/W
5561	M25	R/W	5625	M89	R/W
5562	M26	R/W	5626	M90	R/W
5563	M27	R/W	5627	M91	R/W
5564	M28	R/W	5628	M92	R/W
5565	M29	R/W	5629	M93	R/W
5566	M30	R/W	5630	M94	R/W
5567	M31	R/W	5631	M95	R/W
5568	M32	R/W	5632	M96	R/W
5569	M33	R/W	5633	M97	R/W
5570	M34	R/W	5634	M98	R/W
5571	M35	R/W	5635	M99	R/W
5572	M36	R/W	5636	M100	R/W
5573	M37	R/W	5637	M101	R/W
5574	M38	R/W	5638	M102	R/W
5575	M39	R/W	5639	M103	R/W
5576	M40	R/W	5640	M104	R/W
5577	M41	R/W	5641	M105	R/W
5578	M42	R/W	5642	M106	R/W
5579	M43	R/W	5643	M107	R/W
5580	M44	R/W	5644	M108	R/W
5581	M45	R/W	5645	M109	R/W
5582	M46	R/W	5646	M110	R/W
5583	M47	R/W	5647	M111	R/W
5584	M48	R/W	5648	M112	R/W
5585	M49	R/W	5649	M113	R/W
5586	M50	R/W	5650	M114	R/W
5587	M51	R/W	5651	M115	R/W
5588	M52	R/W	5652	M116	R/W
5589	M53	R/W	5653	M117	R/W
5590	M54	R/W	5654	M118	R/W
5591	M55	R/W	5655	M119	R/W
5592	M56	R/W	5656	M120	R/W
5593	M57	R/W	5657	M121	R/W
5594	M58	R/W	5658	M122	R/W
5595	M59	R/W	5659	M123	R/W
5596	M60	R/W	5660	M124	R/W
5597	M61	R/W	5661	M125	R/W
5598	M62	R/W	5662	M126	R/W
5599	M63	R/W	5663	M127	R/W
5600	M64	R/W	5664	M128	R/W

Internal relay			Internal relay		
NO.	I relay symbol	R/W	NO.	I relay symbol	R/W
		UT75A			UT75A
5665	M01_B	R/W	5729	M65_B	R/W
5666	M02_B	R/W	5730	M66_B	R/W
5667	M03_B	R/W	5731	M67_B	R/W
5668	M04_B	R/W	5732	M68_B	R/W
5669	M05_B	R/W	5733	M69_B	R/W
5670	M06_B	R/W	5734	M70_B	R/W
5671	M07_B	R/W	5735	M71_B	R/W
5672	M08_B	R/W	5736	M72_B	R/W
5673	M09_B	R/W	5737	M73_B	R/W
5674	M10_B	R/W	5738	M74_B	R/W
5675	M11_B	R/W	5739	M75_B	R/W
5676	M12_B	R/W	5740	M76_B	R/W
5677	M13_B	R/W	5741	M77_B	R/W
5678	M14_B	R/W	5742	M78_B	R/W
5679	M15_B	R/W	5743	M79_B	R/W
5680	M16_B	R/W	5744	M80_B	R/W
5681	M17_B	R/W	5745	M81_B	R/W
5682	M18_B	R/W	5746	M82_B	R/W
5683	M19_B	R/W	5747	M83_B	R/W
5684	M20_B	R/W	5748	M84_B	R/W
5685	M21_B	R/W	5749	M85_B	R/W
5686	M22_B	R/W	5750	M86_B	R/W
5687	M23_B	R/W	5751	M87_B	R/W
5688	M24_B	R/W	5752	M88_B	R/W
5689	M25_B	R/W	5753	M89_B	R/W
5690	M26_B	R/W	5754	M90_B	R/W
5691	M27_B	R/W	5755	M91_B	R/W
5692	M28_B	R/W	5756	M92_B	R/W
5693	M29_B	R/W	5757	M93_B	R/W
5694	M30_B	R/W	5758	M94_B	R/W
5695	M31_B	R/W	5759	M95_B	R/W
5696	M32_B	R/W	5760	M96_B	R/W
5697	M33_B	R/W	5761	M97_B	R/W
5698	M34_B	R/W	5762	M98_B	R/W
5699	M35_B	R/W	5763	M99_B	R/W
5700	M36_B	R/W	5764	M100_B	R/W
5701	M37_B	R/W	5765	M101_B	R/W
5702	M38_B	R/W	5766	M102_B	R/W
5703	M39_B	R/W	5767	M103_B	R/W
5704	M40_B	R/W	5768	M104_B	R/W
5705	M41_B	R/W	5769	M105_B	R/W
5706	M42_B	R/W	5770	M106_B	R/W
5707	M43_B	R/W	5771	M107_B	R/W
5708	M44_B	R/W	5772	M108_B	R/W
5709	M45_B	R/W	5773	M109_B	R/W
5710	M46_B	R/W	5774	M110_B	R/W
5711	M47_B	R/W	5775	M111_B	R/W
5712	M48_B	R/W	5776	M112_B	R/W
5713	M49_B	R/W	5777	M113_B	R/W
5714	M50_B	R/W	5778	M114_B	R/W
5715	M51_B	R/W	5779	M115_B	R/W
5716	M52_B	R/W	5780	M116_B	R/W
5717	M53_B	R/W	5781	M117_B	R/W
5718	M54_B	R/W	5782	M118_B	R/W
5719	M55_B	R/W	5783	M119_B	R/W
5720	M56_B	R/W	5784	M120_B	R/W
5721	M57_B	R/W	5785	M121_B	R/W
5722	M58_B	R/W	5786	M122_B	R/W
5723	M59_B	R/W	5787	M123_B	R/W
5724	M60_B	R/W	5788	M124_B	R/W
5725	M61_B	R/W	5789	M125_B	R/W
5726	M62_B	R/W	5790	M126_B	R/W
5727	M63_B	R/W	5791	M127_B	R/W
5728	M64_B	R/W	5792	M128_B	R/W

5793 to 6048: Free area

15.3 UT75A I Relays

Peer-to-peer communication register			Peer-to-peer communication register		
NO.	I relay symbol	R/W	NO.	I relay symbol	R/W
		UT75A			UT75A
6049	CF01	R	6113	CI01	R
6050	CF02	R	6114	CI02	R
6051	CF03	R	6115	CI03	R
6052	CF04	R	6116	CI04	R
6053			6117	CI05	R
6054			6118	CI06	R
6055			6119	CI07	R
6056			6120	CI08	R
6057			6121	CI09	R
6058			6122	CI10	R
6059			6123	CI11	R
6060			6124	CI12	R
6061			6125	CI13	R
6062			6126	CI14	R
6063			6127	CI15	R
6064			6128	CI16	R
6065	CE01	R	6129	CI17	R
6066	CE02	R	6130	CI18	R
6067	CE03	R	6131	CI19	R
6068	CE04	R	6132	CI20	R
6069			6133	CI21	R
6070			6134	CI22	R
6071			6135	CI23	R
6072			6136	CI24	R
6073			6137	CI25	R
6074			6138	CI26	R
6075			6139	CI27	R
6076			6140	CI28	R
6077			6141	CI29	R
6078			6142	CI30	R
6079			6143	CI31	R
6080			6144	CI32	R
6081	CTL_STOP	R *	6145	CI33	R
6082			6146	CI34	R
6083			6147	CI35	R
6084			6148	CI36	R
6085			6149	CI37	R
6086			6150	CI38	R
6087			6151	CI39	R
6088			6152	CI40	R
6089			6153	CI41	R
6090			6154	CI42	R
6091			6155	CI43	R
6092			6156	CI44	R
6093			6157	CI45	R
6094			6158	CI46	R
6095			6159	CI47	R
6096			6160	CI48	R
6097			6161	CI49	R
6098			6162	CI50	R
6099			6163	CI51	R
6100			6164	CI52	R
6101			6165	CI53	R
6102			6166	CI54	R
6103			6167	CI55	R
6104			6168	CI56	R
6105			6169	CI57	R
6106			6170	CI58	R
6107			6171	CI59	R
6108			6172	CI60	R
6109			6173	CI61	R
6110			6174	CI62	R
6111			6175	CI63	R
6112			6176	CI64	R

*: R/W when the LL50A Parameter Setting Software is used.

Peer-to-peer communication register			Free area		
NO.	I relay symbol	R/W	NO.	I relay symbol	R/W
		UT75A			UT75A
6177	CO01	R *	6241		
6178	CO02	R *	6242		
6179	CO03	R *	6243		
6180	CO04	R *	6244		
6181	CO05	R *	6245		
6182	CO06	R *	6246		
6183	CO07	R *	6247		
6184	CO08	R *	6248		
6185	CO09	R *	6249		
6186	CO10	R *	6250		
6187	CO11	R *	6251		
6188	CO12	R *	6252		
6189	CO13	R *	6253		
6190	CO14	R *	6254		
6191	CO15	R *	6255		
6192	CO16	R *	6256		
6193			6257		
6194			6258		
6195			6259		
6196			6260		
6197			6261		
6198			6262		
6199			6263		
6200			6264		
6201			6265		
6202			6266		
6203			6267		
6204			6268		
6205			6269		
6206			6270		
6207			6271		
6208			6272		
6209			6273		
6210			6274		
6211			6275		
6212			6276		
6213			6277		
6214			6278		
6215			6279		
6216			6280		
6217			6281		
6218			6282		
6219			6283		
6220			6284		
6221			6285		
6222			6286		
6223			6287		
6224			6288		
6225			6289		
6226			6290		
6227			6291		
6228			6292		
6229			6293		
6230			6294		
6231			6295		
6232			6296		
6233			6297		
6234			6298		
6235			6299		
6236			6300		
6237			6301		
6238			6302		
6239			6303		
6240			6304		

*: R/W when the LL50A Parameter Setting Software is used.

15.3 UT75A I Relays

Input (Status) Relay and Output (Status) Relay (5025 to 5280)

I relay No.	Symbol	Description
5025 to 5040	X_DI1 to X_DI3	DI1-DI3 status (Same as D7011)
5057 to 5072	X_DI26	DI26 status (Same as D7013)
5073 to 5088	X_DI31 to X_DI35	DI31-DI35 status (Same as D7014)
5089 to 5104	X_DI46	DI46 status (Same as D7015)
5105 to 5152		
5153 to 5168	Y_AL1 to Y_AL3	AL1-AL3 status (Same as D7161)
5169 to 5184		
5185 to 5200	Y_DO21 to Y_DO25	DO21-DO25 status (Same as D7163)
5201 to 5280		

Control (Status) Relay (5281 to 5408)

I relay No.	Symbol	Description
5281 to 5296	AL1_CTL to AL3_CTL	Control AL1-AL3 status (Same as D7111)
5297 to 5312		
5313 to 5328	DO21_CTL to DO25_CTL	Control DO21-DO25 status (Same as D7113)
5329 to 5408		

Special Relay (5409 to 5536)

I relay No.	Symbol	Description	
5409 to 5424	TIM1 to TIM4	Time out flag (Same as D7221)	
	TIM1_B to TIM2_B	Time out flag 1/2	
5425 to 5440	CNT1 to CNT4	Time out flag (Same as D7222)	
	CNT1_B to CNT2_B	Time out flag 1/2	
5441	SMPCLK	Input sampling period (control period) clock	
5442	CLK1	1-second clock	
5443	CLK2	2-second clock	
5444	CLK10	10-second clock	
5445	CLK60	60-second clock	
5447	CLK1P	1-second clock pulse	
5448	CLK2P	2-second clock pulse	
5449	CLK10P	10-second clock pulse	
5450	CLK60P	60-second clock pulse	
5457	PON	Power on flag	0: Power-on and initializing 1: During operation
5458	PLS1	Always ON	1: ON
5459	ZERO	Always OFF	0: OFF
5461	PDLVL	Power failure detection level *1	0: Power failure of about 5 seconds or more 1: Power failure of about less than 5 seconds
5473 to 5536	Free area		

- *1: No power failure is detected in the following cases, and the unit maintains normal operations.
- A momentary power failure of 20 ms or less in the case of 100 – 240 V AC
 - A momentary power failure of 1 ms in the case of 24 V AC/DC

Internal Relay (5537 to 5792)

I relay No.	Symbol	Description
5537 to 5664	M01 to M128	You can read/write data from/to the area via communication. (Same as D7201 to D7208) That is, you can use the area freely without affecting the control function of the UTAdvanced
5665 to 5696	M01_B to M32_B	You can read/write data from/to the area via communication. (Same as D7211 to D7212) That is, you can use the area freely without affecting the control function of the UTAdvanced
5697 to 5792	M33_B to M128_B	You can read/write data from/to the area via communication. (Same as D7213 to D7218) That is, you can use the area freely without affecting the control function of the UTAdvanced
5793 to 6048		

Peer-to-peer Communication Register (6049 to 6304)

I relay No.	Symbol	Description
6049 to 6064	CF01 to CF04	Reception timeout flag-1 for peer-to-peer communication to Reception timeout flag-4 for peer-to-peer communication 0: OFF 1: ON
6065 to 6080	CE01 to CE04	End of data reception flag-1 for peer-to-peer communication to End of data reception flag-4 for peer-to-peer communication 0: OFF 1: ON
6081	CTL_STOP	Control computation start/stop flag for peer-to-peer communication 0: Normal operation 1: Stop control computation
6097 to 6112		
6113 to 6176	CI01 to CI64	Status input relay-1 for peer-to-peer communication to Status input relay-64 for peer-to-peer communication 0: OFF 1: ON
6177 to 6192	CO01 to CO16	Status output relay-1 for peer-to-peer communication to Status output relay-16 for peer-to-peer communication 0: OFF 1: ON
6193 to 6240		
6241 to 6304	Free area	

15.3.3 Input / Output Terminal Status (6305 to 6560)

Note

When specifying an I relay number for communication, begin the number with the character "I."
Example: Set "I6305" to specify the DI1 (I relay No.: 6305).

DI terminals			DI terminals		
NO.	I relay symbol	R/W	NO.	I relay symbol	R/W
		UT75A			UT75A
6305	DI1	R	6369		
6306	DI2	R	6370		
6307	DI3	R	6371		
6308			6372		
6309			6373		
6310			6374	DI46	R
6311			6375		
6312			6376		
6313			6377		
6314			6378		
6315			6379		
6316			6380		
6317			6381		
6318			6382		
6319			6383		
6320			6384		
6321			6385		
6322			6386		
6323			6387		
6324			6388		
6325			6389		
6326			6390		
6327			6391		
6328			6392		
6329			6393		
6330			6394		
6331			6395		
6332			6396		
6333			6397		
6334			6398		
6335			6399		
6336			6400		
6337			6401		
6338			6402		
6339			6403		
6340			6404		
6341			6405		
6342			6406		
6343			6407		
6344			6408		
6345			6409		
6346			6410		
6347			6411		
6348			6412		
6349			6413		
6350			6414		
6351			6415		
6352			6416		
6353	DI31	R	6417		
6354	DI32	R	6418		
6355	DI33	R	6419		
6356	DI34	R	6420		
6357	DI35	R	6421		
6358			6422		
6359			6423		
6360			6424		
6361			6425		
6362			6426		
6363			6427		
6364			6428		
6365			6429		
6366			6430		
6367			6431		
6368			6432		

15.3 UT75A I Relays

DO terminals			DO terminals		
NO.	I relay symbol	R/W UT75A	NO.	I relay symbol	R/W UT75A
6433	OUT_AL1	R	6497		
6434	OUT_AL2	R	6498		
6435	OUT_AL3	R	6499		
6436			6500		
6437			6501		
6438			6502		
6439			6503		
6440			6504		
6441			6505		
6442			6506		
6443			6507		
6444			6508		
6445			6509		
6446			6510		
6447			6511		
6448			6512		
6449			6513		
6450			6514		
6451			6515		
6452			6516		
6453			6517		
6454			6518		
6455			6519		
6456			6520		
6457			6521		
6458			6522		
6459			6523		
6460			6524		
6461			6525		
6462			6526		
6463			6527		
6464			6528		
6465	OUT_DO21	R	6529		
6466	OUT_DO22	R	6530		
6467	OUT_DO23	R	6531		
6468	OUT_DO24	R	6532		
6469	OUT_DO25	R	6533		
6470			6534		
6471			6535		
6472			6536		
6473			6537		
6474			6538		
6475			6539		
6476			6540		
6477			6541		
6478			6542		
6479			6543		
6480			6544		
6481			6545		
6482			6546		
6483			6547		
6484			6548		
6485			6549		
6486			6550		
6487			6551		
6488			6552		
6489			6553		
6490			6554		
6491			6555		
6492			6556		
6493			6557		
6494			6558		
6495			6559		
6496			6560		

6561 to 7072: Free area

DI Terminals and DO Terminals (6305 to 6560)

I relay No.	Symbol	Description
6305 to 6320	DI1 to DI3	DI1-DI3 status (Same as D7601)
6321 to 6352		
6353 to 6368	DI31 to DI35	DI31-DI35 status (Same as D7604)
6369 to 6384	DI46	DI46 status (Same as D7605)
6385 to 6432		
6433 to 6448	OUT_AL1 to OUT_AL3	AL1-AL3 status (Same as D7611)
6449 to 6464		
6465 to 6480	OUT_DO21 to OUT_DO25	DO21-DO25 status (Same as D7613)
6481 to 6560		

15.4 Reading via Communication

■ When reading the alarm status

Read I relay numbers 4321 to 4336 for Loop-1 alarm-1 to alarm-8 status.

I relay No.	Symbol	Event
4321 to 4336	ALM1_L1~ALM8_L1	Loop-1 alarm-1 to alarm-8 status (Same as D2011) *
4337 to 4352	ALM1_L2~ALM8_L2	Loop-2 alarm-1 to alarm-8 status (Same as D2013)
⋮	⋮	⋮
4545 to 4576		

*: The contents of Loop-1 alarm-1 to alarm-8 status (I relay numbers 4321 to 4336: ALM1_L1 to ALM8_L1) are the same as the bit configuration of D register number D2011 (Loop-1 alarm-1 to alarm-8 status). Refer to the bit configuration of D2011 described in “Chapter 14 Functions and Applications of D Registers (for UT75A).” The following shows the bit configuration of D2011 described in “Chapter 14 Functions and Applications of D Registers (for UT75A).”

● Bit Configuration of D2011: ALM_L1 (Loop-1 alarm-1 to alarm-8 status)

Bit	Symbol	Event
0	ALM1_L1	'1' when Loop-1 alarm 1 is ON; '0' when OFF
1	ALM2_L1	'1' when Loop-1 alarm 2 is ON; '0' when OFF
2	ALM3_L1	'1' when Loop-1 alarm 3 is ON; '0' when OFF
3		
4	ALM4_L1	'1' when Loop-1 alarm 4 is ON; '0' when OFF
5	ALM5_L1	'1' when Loop-1 alarm 5 is ON; '0' when OFF
6	ALM6_L1	'1' when Loop-1 alarm 6 is ON; '0' when OFF
7		
8	ALM7_L1	'1' when Loop-1 alarm 7 is ON; '0' when OFF
9	ALM8_L1	'1' when Loop-1 alarm 7 is ON; '0' when OFF
10 to 15		

Note

When specifying an I relay number for communication, begin the number with the character “I.”
Example: Set “I4321” to specify the ALM1_L1 (I relay No.: 4321).

15.5 GREEN Series Compatible I Relays

15.5.1 Compatibility with GREEN Series Controllers

The map configuration from 1 to 2048 of the I relay map is the same as that of the GREEN Series (UT700 Series) controllers.

If existing programs created in the GREEN Series controllers are used, communication is performed using the area from 0001 to 2048.

The I relay map after 4001 is allocated for the UTAdvanced.

If you want to newly perform communication, be sure to use the registers after 4001.

15.5.2 Conventions Used in I Relay Tables

■ How to Specify I Relay Numbers

When specifying an I relay number for communication, begin the number with the character "I."

Example: Set "I0003" to specify the ADERR_E1 (I relay No.: 0003).

■ Interpretation of Cell

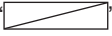
A cell marked with a diagonal line () indicates that it is not supported by the UTAdvanced.

■ I relay symbol

- With regards to some register symbols, the loop number and terminal area are indicated by adding the underline () to the end of the parameter symbols.

□□□□_Ln Ln: Loop numbers (L1 or L2)
□□□□_En En: Terminal area (E1 to E4)

Example : **PVBO_L1** Indicates Loop-1 PVBO.
ADERR_E1 Indicates ADERR in E1-terminal area.

- Numbers in parentheses after the register symbols of the UTAdvanced indicate the same I relay after I4001.

Note

- I relay numbers 1 to 192 store ON/OFF status information and are normally read for ON/OFF status information. I relay numbers 1 to 192 also exists in D registers. They have the same function data as D registers.
- In the area for I relay numbers 1 to 720, it is prohibited to write data to I relays with blank cells in I relay map tables. If you attempt to do so, the UTAdvanced may not operate properly.

15.5 I Relays Corresponding to GREEN Series

15.5.3 Status (0001 to 0192)
UT55A/UT52A

Status								
NO.	I relay symbol		NO.	I relay symbol		NO.	I relay symbol	
	GREEN	UTAdvanced		GREEN	UTAdvanced		GREEN	UTAdvanced
1	AD1 ERR	ADERR (4065)	65	A/M1	A.M (4193) *1	129		
2	AD2 ERR		66	R/L1	R.L_L1 (4194)	130		
3	AD3 ERR	ADERR_E1 (4066)	67	R/S1	S.R (4193)	131		
4			68			132		
5	AD1 BO	ADBO (4073)	69	CAS	CAS_ON (4197) *2	133		
6	AD2 BO		70	AUT	AUTO_ON (4198) *2	134		
7	AD3 BO	ADBO_E1 (4074)	71	MAN	MAN_ON (4199) *2	135		
8			72			136		
9	RJC1 ERR	RJCERR (4070)	73			137		
10	RJC2 ERR		74			138		
11			75			139		
12	VLV.AT ERR	VALV_ATERR (4082)	76			140		
13	VLV.BOUT	VALVBO (4081)	77			141		
14			78			142		
15			79	AT1	AT_L1_ON (4207)	143		
16			80			144		
17	PV1 ADC		81	A/M2	A.M_L2 (4225) *3	145		
18	PV1 BO	PVBO_L1 (4097)	82	R/L2	R.L_L2 (4226)	146		
19	RJC1 ERR		83			147		
20			84			148		
21	PV1+over	PVPOVER_L1 (4101)	85			149		
22	PV1-over	PVMOVER_L1 (4102)	86			150		
23			87			151		
24			88			152		
25	RSP1 ADC		89			153		
26	RSP1 BO	RSPBO_L1 (4098)	90			154		
27			91			155		
28			92			156		
29	C.RSP1 ADC		93			157		
30	C.RSP1 BO	CRSPBO_L1 (4099)	94			158		
31	AT1 ERR	ATERR_L1 (4111)	95	AT2	AT_L2_ON (4239)	159		
32			96			160		
33	PV2 ADC		97	ALM11	ALM1_L1 (4321)	161	DI1	X_DI1 (5025)
34	PV2 BO	PVBO_L2 (4113)	98	ALM12	ALM2_L1 (4322)	162	DI2	X_DI2 (5026)
35	RJC2 ERR		99	ALM13	ALM3_L1 (4323)	163	DI3	X_DI3 (5027)
36			100			164	DI4	
37	PV2+over	PVPOVER_L2 (4117)	101	ALM14	ALM4_L1 (4325)	165	DI5	
38	PV2-over	PVMOVER_L2 (4118)	102	OR1		166	DI6	
39			103			167	DI7	
40			104			168	DI8	
41	RSP2 ADC		105	ALM21	ALM1_L2 (4337)	169		
42	RSP2 BO	RSPBO_L2 (4114)	106	ALM22	ALM2_L2 (4338)	170	DP1	DP1 (4781)
43			107	ALM23	ALM3_L2 (4339)	171	DP2	DP2 (4782)
44			108			172	MG1	MG1.B (4769)
45	C.RSP2 ADC		109	ALM24	ALM4_L2 (4341)	173	MG2	MG2.B (4770)
46	C.RSP2 BO	CRSPBO_L2 (4115)	110	OR2		174	MG3	MG3.B (4771)
47	AT2 ERR	ATERR_L2 (4127)	111			175	MG4	MG4.B (4773)
48			112			176		
49	CALB.E	CALB_ERR (4002)	113			177		
50	UCALB.E		114			178		
51	USER.E		115			179		
52			116			180		
53	UTMD	SETPA_ERR (4005)	117			181		
54	RANGE	SETPA_ERR (4005)	118			182		
55	SETUP	SETPA_ERR (4005)	119			183		
56			120			184		
57	PARA.E	OPEPA_ERR (4006)	121			185		
58	MODE.E	CTLPA_ERR (4011)	122			186		
59	FILE.E		123			187		
60			124			188		
61	EEP.E	FRAM_ERR (4009)	125			189		
62			126			190		
63	SYSTEM.E	SYSTEM_ERR (4001)	127			191		
64			128			192		

193 to 576: Free area

See the next page regarding “*1” and “*2.”

15.5 I Relays Corresponding to GREEN Series

*1: Effective for the control modes except for cascade control and cascade secondary-loop control.

*2: Effective for cascade control mode and cascade secondary-loop control mode.

I relay No.	Symbol	Description
1 to 16	ADERR to VALVBO	A/D converter error status for GREEN Series (Same as D0001)
17 to 32	PVBO_L1 to ATERR_L1	Loop-1 PV input error status for GREEN Series (Same as D0002)
33 to 48	PVBO_L2 to ATERR_L2	Loop-2 PV input error status for GREEN Series (Same as D0018)
49 to 64	CALB_ERR to SYSTEM_ERR	Parameter error status for GREEN Series (Same as D0035)
65 to 80	A.M to AT_L1_ON	Loop-1 operation mode status for GREEN Series (Same as D0008)
81 to 96	A.M_L2 to AT_L2_ON	Loop-2 operation mode status for GREEN Series (Same as D0024)
97 to 112	ALM1_L1 to ALM4_L2	Alarm status for GREEN Series (Same as D0011)
113 to 160		
161 to 176	X_DI to X_DI3	DI1-DI3 status (D0033)
177 to 192		

193 to 576: Free area

7.5.4 SP Number, PID Number, and Status (0577 to 0720)

UT55A/UP55A

SP number, PID number, and status					
NO.	I relay symbol		NO.	I relay symbol	
	GREEN	UTAdvanced		GREEN	UTAdvanced
577	CSPNO.0	CSPN.B0 (4577)	641		
578	CSPNO.1	CSPN.B1 (4578)	642		
579	CSPNO.2	CSPN.B2 (4579)	643		
580	CSPNO.3	CSPN.B3 (4580)	644		
581			645		
582			646		
583			647		
584			648		
585			649		
586			650		
587			651		
588			652		
589			653		
590			654		
591			655		
592			656		
593	PIDNO1.0	PIDN.B0_L1 (4609)	657	TIM.1S	
594	PIDNO1.1	PIDN.B1_L1 (4610)	658	TIM.5S	
595	PIDNO1.2	PIDN.B2_L1 (4611)	659	TIM.10S	
596	PIDNO1.3	PIDN.B3_L1 (4612)	660		
597			661	TIM.10M	
598			662	/DI1	
599			663	/DI2	
600			664	/DI3	
601			665	V.GUE	VALV_GUSS (4210)
602			666		
603			667		
604			668		
605			669		
606			670		
607			671		
608			672	PON	
609	PIDNO2.0	PIDN.B0_L2 (4625)	673	PV2	
610	PIDNO2.1	PIDN.B1_L2 (4626)	674	LP2	LP2_LAMP
611	PIDNO2.2	PIDN.B2_L2 (4627)	675	/DI4	
612	PIDNO2.3	PIDN.B3_L2 (4628)	676	/DI5	
613			677	/DI6	
614			678	/DI7	
615			679		
616			680		
617			681	DEV1-	DEV1M
618			682	DEV1Z	DEV1Z
619			683	DEV1+	DEV1P
620			684		
621			685	DEV2-	DEV2M
622			686	DEV2Z	DEV2Z
623			687	DEV2+	DEV2P
624			688		
625			689	ALO11	ALO1_L1 (4353)
626			690	ALO12	ALO2_L1 (4354)
627			691	ALO13	ALO3_L1 (4355)
628			692		
629			693	ALO14	ALO4_L1 (4357)
630			694		
631			695		
632			696		
633			697	ALO21	ALO1_L2 (4369)
634			698	ALO22	ALO2_L2 (4370)
635			699	ALO23	ALO3_L2 (4371)
636			700		
637			701	ALO24	ALO4_L2 (4373)
638			702		
639			703		
640			704		

15.5 I Relays Corresponding to GREEN Series

I relay No.	Symbol	Description	
577 to 592	CSPN.B0 to CSPN.B3	SPnumber (Same as 2010)	
593 to 608	PIDN.B0_L1 to PIDN.B3_L1	Loop-1 PID number (Same as 2009)	
609 to 624	PIDN.B0_L2 to PIDN.B3_L2	Loop-2 PID number (Same as 2025)	
625 to 664			
665	VALV_GUSS	Valve position estimating	0: Operation by feedback input 1: Operation by estimating type
674	LP2_LAMP	LP2 lamp	0: Unlit 1: Lit
681	DEV1M	Loop-1 Deviation low limit indicator lamp	
682	DEV1Z	Loop-1 deviation within high and low limits indicator lamp	
683	DEV1P	Loop-1 Deviation high limit indicator lamp	
685	DEV2M	Loop-2 Deviation low limit indicator lamp	
686	DEV2Z	Loop-2 deviation within high and low limits indicator lamp	
687	DEV2P	Loop-2 Deviation high limit indicator lamp	
689 to 704	ALO1_L1 to ALO4_L2	Alarm-1 to alarm-4 output status for GREEN Seriese (Same as D0036)	
705 to 720			

15.5.5 User Area (0721 to 2048)

I relay No.	I relay symbol	Description	
721 to 2048	USER	User area	You can read/write data from/to the area for I relays 721 to 2048 via communication. That is, you can use the area freely without affecting the control function of the UTAdvanced. However, the data cannot be saved.

Appendix ASCII Code Table

Hex.	Dec.	Symbol	Hex.	Dec.	Symbol	Hex.	Dec.	Symbol	Hex.	Dec.	Symbol
00	0	^@ NUL	20	32	SPC	40	64	@	60	96	`
01	1	^A SOH	21	33	!	41	65	A	61	97	a
02	2	^B STX	22	34	"	42	66	B	62	98	b
03	3	^C ETX	23	35	#	43	67	C	63	99	c
04	4	^D EOT	24	36	\$	44	68	D	64	100	d
05	5	^E ENQ	25	37	%	45	69	E	65	101	e
06	6	^F ACK	26	38	&	46	70	F	66	102	f
07	7	^G BEL	27	39	'	47	71	G	67	103	g
08	8	^H BS	28	40	(48	72	H	68	104	h
09	9	^I HT	29	41)	49	73	I	69	105	i
0A	10	^J LF	2A	42	*	4A	74	J	6A	106	j
0B	11	^K VT	2B	43	+	4B	75	K	6B	107	k
0C	12	^L FF	2C	44	,	4C	76	L	6C	108	l
0D	13	^M CR	2D	45	-	4D	77	M	6D	109	m
0E	14	^N SO	2E	46	.	4E	78	N	6E	110	n
0F	15	^O SI	2F	47	/	4F	79	O	6F	111	o
10	16	^P DLE	30	48	0	50	80	P	70	112	p
11	17	^Q DC1	31	49	1	51	81	Q	71	113	q
12	18	^R DC2	32	50	2	52	82	R	72	114	r
13	19	^S DC3	33	51	3	53	83	S	73	115	s
14	20	^T DC4	34	52	4	54	84	T	74	116	t
15	21	^U NAK	35	53	5	55	85	U	75	117	u
16	22	^V SYN	36	54	6	56	86	V	76	118	v
17	23	^W ETB	37	55	7	57	87	W	77	119	w
18	24	^X CAN	38	56	8	58	88	X	78	120	x
19	25	^Y EM	39	57	9	59	89	Y	79	121	y
1A	26	^Z SUB	3A	58	:	5A	90	Z	7A	122	z
1B	27	^[ESC	3B	59	;	5B	91	[7B	123	{
1C	28	^FS	3C	60	<	5C	92	\	7C	124	
1D	29	^] GS	3D	61	=	5D	93]	7D	125	}
1E	30	^^ RS	3E	62	>	5E	94	^	7E	126	~
1F	31	^_ US	3F	63	?	5F	95	_	7F	127	DEL

Revision Information

- Title : UTAdvanced Series Communication Interface (RS-485, Ethernet)
User's Manual
- Manual No. : IM 05P07A01-01EN

May 2009/1st Edition

Newly published

Sep. 2009/2nd Edition

Error correction

Jan. 2010/3rd Edition

Addition of UT35A/UT32A

June 2010/4th Edition

Addition of CC-Link communication

Aug. 2010/5th Edition

Addition of UP55A/UP35A and DeviceNet communication

Sep. 2010/6th Edition

Error correction

Jan. 2011/7th Edition

Functional improvement and error correction

June 2011/8th Edition

Addition of UT35A-L

Feb. 2013/9th Edition

Addition of UT75A

-
- Written by Yokogawa Electric Corporation
 - Published by Yokogawa Electric Corporation
2-9-32 Nakacho, Musashino-shi, Tokyo 180-8750, JAPAN
-

Blank Page



YOKOGAWA ELECTRIC CORPORATION**Headquarters**

2-9-32, Nakacho, Musashino-shi, Tokyo, 180-8750 JAPAN

Branch Sales Offices

Nagoya, Osaka, Hiroshima, Fukuoka, Sendai, Ichihara, Toyota, Kanazawa, and Kitakyusyu.

YOKOGAWA CORPORATION OF AMERICA

2 Dart Road, Newnan, Georgia 30265-1094, U.S.A.

Phone : 1-800-888-6400

Fax : 1-770-254-0928

YOKOGAWA EUROPE B. V.

Euroweg 2, 3825 HD Amersfoort, THE NETHERLANDS

Phone : 31-88-4641000 Fax : 31-88-4641111

Branch Sales Offices / Wien (Austria), Zaventem (Belgium), Ratingen (Germany), Madrid (Spain), Runcorn (United Kingdom), Milano (Italy), Velizy-Villacoublay (France), Budapest (Hungary), Stockholm (Sweden), Sola (Norway), Warszawa (Poland), Vila Nova de Gaia (Portugal), Bucharest (Romania), Dublin (Ireland)

YOKOGAWA AMERICA DO SUL LTDA.

Praca Acapulco, 31 - Santo Amaro. Sao Paulo/SP - BRAZIL

Phone : 55-11-5681-2400 Fax : 55-11-5681-4434

YOKOGAWA ENGINEERING ASIA PTE. LTD.

5 Bedok South Road, 469270 SINGAPORE

Phone : 65-6241-9933 Fax : 65-6241-2606

YOKOGAWA ELECTRIC KOREA CO., LTD.

14-1, Yangpyongdong-4Ga, Youngdeungpo-Gu, Seoul, 150-866 KOREA

Phone : 82-2-2628-6000 Fax : 82-2-2628-6400

YOKOGAWA AUSTRALIA PTY. LTD.

Tower A, 112-118 Talavera Road, Macquarie Park, N.S.W.2113, AUSTRALIA

Phone : 61-2-8870-1100 Fax : 61-2-8870-1111

YOKOGAWA INDIA LTD.

Plot No.96 Electronic City Complex, Hosur Road, Bangalore 560100, INDIA

Phone : 91-80-4158-6000 Fax : 91-80-2852-1442

YOKOGAWA CHINA CO., LTD.

3F TowerD Cartelo Crocodile Building

No.568 West Tianshan Road, Shanghai 200335, CHINA

Phone : 86-21-62396262 Fax : 86-21-62387866