

Combustion Analyzer w/ EOS CO2 Sensor Technology and High-Altitude Compensation



INSTRUCTION MANUAL

ENGLISH

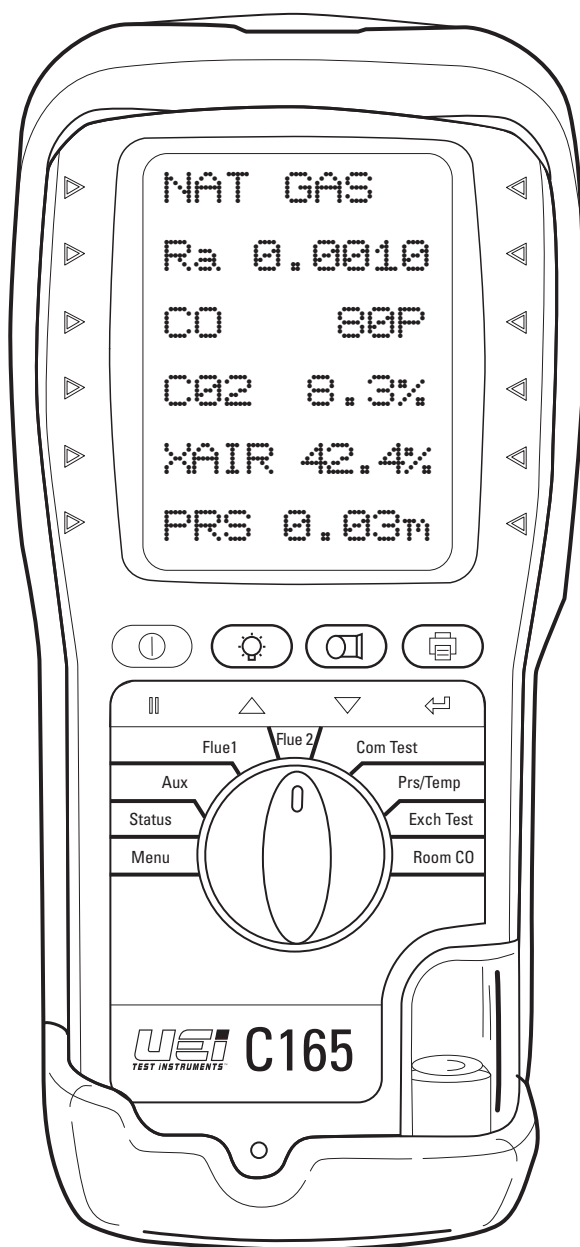

TABLE OF CONTENTS

Analyzer Overview	4	Annual Service & Recertification	25
C165 Overview	5	Recertification Services	25
Warnings	6	Online Booking Procedure	25
Batteries	6	Returning Your Analyzer	26
Before Using The Analyzer Every Time	7	Where to Send Your Analyzer	26
Fresh Air Purge	7	Cold Weather Precautions	26
Status Display	7	Analyzer Specification	27-28
Display Parameters	8	Electromagnetic Compatibility	28
Using The Four Function Buttons	9	End of Life Disposal	28
Using the Analyzer	10-17	Product Registration	29
Combustion Test	10-11	Survey	30
Combustion Test - Optional Nitric Oxide Sensor	12	EN50379 Regulated Instructions	31
Commissioning Test	13	Warranty Information	32
Pressure/Temperature Test	13-14		
Heat Exchange Integrity Test	14-15		
Room CO Test	15-16		
C165 Printouts	17		
Using The Menu	18-19		
Using The C165 as a Thermometer or Pressure Meter	20		
Measuring Flue Gases (CO Protection Pump Operation)	21		
Where to Test	22-23		
Analyzer Problem Solving	24		
Frequently Asked Questions	24		
Product Registration	24		

ANALYZER OVERVIEW

The C165 has a dilution pump which helps to protect the CO sensor from high concentration that otherwise might damage the sensor and is designed specifically for higher altitude applications and use.

The C165 Combustion Analyzer measures carbon dioxide (CO₂), carbon monoxide (CO), differential temperature and differential pressure. The direct measurement of CO₂ is achieved using an infrared sensing system. Below 1% CO₂ the readings of CO₂ are displayed to two decimal places.

CO₂ is set to zero in fresh air automatically after the initial countdown. The countdown varies between 90 and 60 seconds dependent on ambient temperature.

If "RESET GAS ZERO" is indicated ensure that the unit is in outside fresh air before pressing the button with an "Enter" symbol.

It is important that re-zeroing is done in outside fresh air as indoor CO₂ levels are affected by human breath.

It calculates oxygen (O₂), CO/CO₂ ratio, losses, combustion efficiency (Gross, Gross Condensing, Net or Net Condensing).

The C165 Combustion Analyzer can also measure CO levels in ambient air - useful when a CO Alarm is triggered. It can also perform a Room CO Test for up to 30 minutes duration.

A structured Commissioning Test has been included for the installation of boilers.

The analyzer has a protective rubber cover with a magnet for "hands-free" operation and is supplied with a flue probe with integral temperature sensor.

A low flow detection system warns of low flow and switches the pump off. This also helps to prevent water ingress from overfilled water traps.

Its LCD display is protected with a toughened screen.

The large display shows 6 readings at a time and all data can be printed via an optional infrared printer. The printed data can be 'live' data or 'stored' data.

The memory can store up to:

- 60 combustion tests
- 20 AUX tests
- 20 heat exchange tests
- 20 temperature & pressure tests
- 20 room CO tests
- 20 commissioning Tests

Two lines of 20 characters can be added to the header of printouts. Printouts can be made on the optional UEi printers with 'fast print' capability. Alternatively, the analyzer can be equipped with optional wireless communications to either Android™ or Apple® devices.

The analyzer is controlled using 4 function buttons and a rotary dial.

The four buttons (from left to right) switch on and off the analyzer, switch on and off the worklight, switch on and off the pump and send data to a printer or to the memory. The buttons with "UP", "DOWN" and "ENTER" arrows also change settings such as date, time, fuel, etc. when in "MENU" mode.

C165 OVERVIEW

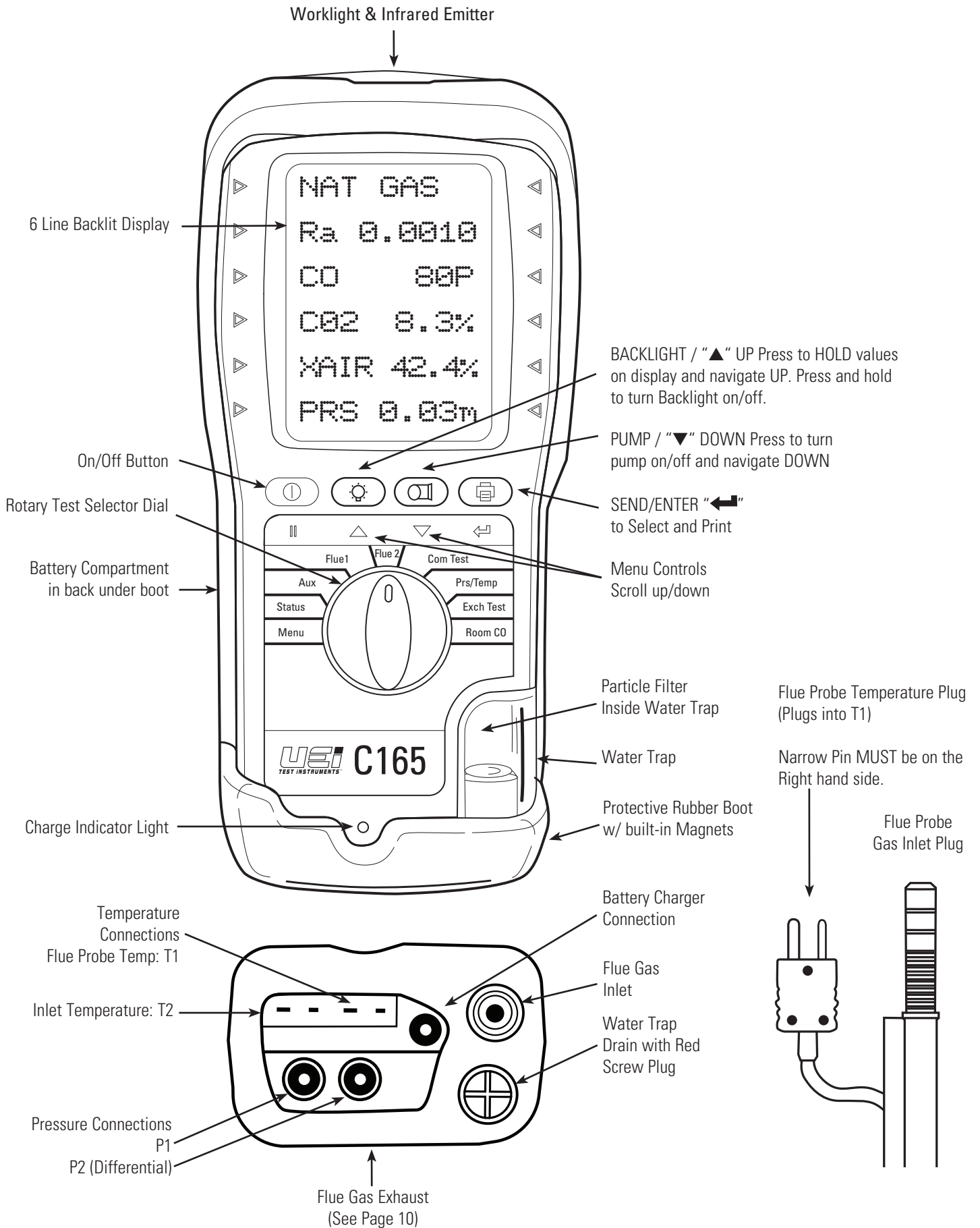

WARNINGS



SAFETY NOTES

Before using this meter, read all safety information carefully.

“WARNING” is used to indicate conditions or actions that may pose physical hazards to the user.

“CAUTION” is used to indicate conditions or actions that may damage this instrument.



WARNING!

This analyzer extracts combustion gases that may be toxic in relatively low concentrations. These gases are exhausted from the back of the instrument. **This analyzer must only be used in well-ventilated locations by trained and competent persons after due consideration of all the potential hazards.**

Users of portable gas detectors are recommended to conduct a “bump” check before relying on the unit to verify an atmosphere is free from hazard. A “bump” test is a means of verifying that an instrument is working within acceptable limits by briefly exposing to a known gas mixture formulated to change the output of all the sensors present. (This is different from a calibration where the instrument is also exposed to a known gas mixture but is allowed to settle to a steady figure and the reading adjusted to the stated gas concentration of the test gas).

BATTERIES

BATTERY TYPE

This analyzer has been designed for use with disposable alkaline batteries or rechargeable Nickel Metal Hydride (NiMH) batteries. No other battery types are recommended.



WARNING!

The battery charger unit must only be used when NiMH batteries are fitted. Do not mix NiMH cells of different capacities or from different manufacturers. All four cells must be identical

REPLACING BATTERIES

Turn over the analyzer, remove its protective rubber cover and fit 4 “AA” batteries in the battery compartment. **Take great care to ensure they are fitted with the correct battery polarity.** Replace the battery cover and protective rubber cover.

Note: When changing the batteries on the instrument the memory will store the date and time for up to one minute, if outside this time it may be necessary to re-enter the details. Date and time may also need to be reset if re-chargeable batteries are allowed to totally discharge.

Switch the analyzer on and check that the analyzer’s time and date are correct. To reset see **USING THE MENU, Section 5.**

CHARGING NIMH BATTERIES

Ensure that you use the correct charger. The part number is AAC4.

To fully charge NiMH batteries:

The charger must be connected and switched on.

When charging, the red Battery Charging Indicator will illuminate.

After a few seconds, the display will show “CHARGING BATTERY” if they need extra charge. If they are already fully charged this message will not appear.

The first charge should be for 12 hours continuously. NiMH batteries are suitable for top up charging at any time, even for short periods.

BATTERY DISPOSAL

Always dispose of depleted batteries using approved disposal methods that protect the environment.

BEFORE USING THE ANALYZER EVERY TIME

Check the water trap is empty and the particle filter is not dirty:

To empty water trap, unscrew the red screw plug and re-tighten once it is empty.

To change the particle filter, remove protective rubber cover, slide the water trap unit from the analyzer, remove the particle filter from its spigot and replace. Reconnect the water trap unit and rubber protective cover.

Connect the flue probe hose to the analyzer's flue gas inlet and connect the flue probe's temperature plug to the T1 socket – check the plug's orientation is correct - see Page 5.

FRESH AIR PURGE

Position the flue probe in outside fresh air, then press . The analyzer's pump starts and auto-calibrates. When complete:

Select "FLUE 1" on the dial. In fresh air the O₂ reading should be 20.9% ± 0.3%.

Select "FLUE 2" on the dial. In fresh air the CO reading should be zero.

**FRESH AIR
PURGE
REMOVE
PROBE
FROM FLUE
PRESS** 

WARNING!

This message indicates that the analyzer needs to be reset in fresh air. To do so, ensure that the analyzer is in **outside fresh air** and press 

To perform a manual "Gas Zero", select "FLUE 2" on the dial, hold down the  key and you will see the message above.

STATUS DISPLAY

Select "STATUS" on the dial to view the following:

NAT GAS
14:56:29
09/03/18
Ta **74.8F**
CAL **283**
BAT 

Current fuel selection. Press up/down to change the fuel selection.

Current time. Can be re-set via the "Menu"

Current date. Can be re-set via the "Menu"

Ambient temperature of the analyzer

Shows number of days until next calibration is due

Shows the charge level of the batteries

DISPLAY PARAMETERS









Here are the legends used and what they mean:

BAT:	Displays the Battery power available. Readings may be affected if used with low power batteries.
CAL:	Number of days left before recalibration is due
CO:	Carbon monoxide (Measured) reading displayed in ppm (parts per million). If ' - - - ' is displayed there is a fault with the CO sensor or the instrument has not set to zero correctly. Switch off instrument and try again.
CO_n:	Carbon monoxide normalized
CO₂:	Carbon dioxide (Measured) reading in percentage (%).
CO/CO₂:	CO/CO ₂ Ratio: measured CO (ppm) divided by (CO ₂ (%) x 10,000).
DATE:	Date shown as month, day and year, MM/DD/YY. Date is recorded when each combustion test is printed or stored.
EFF:	Combustion efficiency calculation displayed in percentage either as Gross Ef(G), Net Ef(N), Gross Condensing Ef(GC) or Net Condensing Ef(NC) - Use MENU to change. The calculation is determined by fuel type and uses the calculation in British Standard BS845. The efficiency is displayed during a combustion test, ' - - - ' is displayed while in fresh air.
EFG:	Gross efficiency
EfCG:	Gross condensing Efficiency
EfN:	Net efficiency
EfCN:	Net condensing efficiency
FULL:	The maximum number of tests have been stored in the memory. To delete the stored memory, Select Reports then select the tests to be deleted (see Page 19).
INT:	Interval in seconds
LOSS:	Losses calculated from oxygen and type of fuel. Displays reading during a combustion test. ' - - - ' is displayed while in fresh air.
mg/m³:	Milligrams per meter cubed
mg/m³(n):	Milligrams per meter cubed normalized
mg/kWh:	Milligrams per kilowatt hour
mg/kWh(n):	Milligrams per kilowatt hour normalized
N/F:	Not fitted
O₂:	Oxygen (Calculated) reading in percentage (%)
O₂ ++%:	Calculated oxygen greater than 18% so calculation is disabled
O₂ ref:	reference level in % for normalization calculation
p:	Parts per million
ppm:	Parts per million
ppm(n):	Parts per million normalized
-P-OFF:	Pump off
PRS:	Pressure reading, either single point or differential.
Ra:	CO to CO ₂ ratio
Tf:	Temperature measured by the flue gas probe in Fahrenheit (°F) and Centigrade (°C). It displays ' - OC - ' if the flue probe is disconnected or faulty.
Ta:	If an inlet temperature probe (optional) is connected into the T1 socket during its countdown, the measured temperature from the inlet probe will be used as the inlet temperature. If an inlet temperature probe is not connected to the analyzer during countdown the measured temperature from the flue probe will be used as the inlet temperature. If neither probe is connected during countdown the analyzer's internal ambient temperature will be used as the inlet temperature.
ΔT:	Net temperature calculated by deducting the INLET temperature from the measured FLUE temperature. It displays ' - OC - ' if the flue probe is not connected or broken.
TIME:	The time shown is expressed in "Military" time HH:MM:SS. Time is recorded when each test is printed or stored.
X - AIR:	Excess air calculated from the calculated oxygen and type of fuel. Displays reading during a combustion test. ' - - - ' is displayed while in fresh air.

Pressure units:

m:	millibar
s:	psi
h:	hPa
P:	Pa
g:	mmHg
i:	inH ₂ O
w:	mmH ₂ O
k:	kPa

USING THE FOUR FUNCTION BUTTONS

<p>Switching ON the Analyzer</p>	<p>Rotate the dial to the mode you want to use before switching on. This may eliminate the need for a full countdown in some of the modes and save you time.</p> <p>Press  button to switch the unit ON. This must be done in fresh air to ensure that the analyzer auto calibrates its sensors properly.</p> <p>When switched on, the analyzer beeps and briefly displays software version, date and time. Its bottom line counts down until the sensors are ready to use. If the analyzer will not auto calibrate, its sensors need to be replaced or recalibrated by an authorized repair center.</p> <p>If an inlet temperature probe (optional) is connected into the T2 socket during its countdown, the measured temperature from the inlet probe will be used as the inlet temperature.</p> <p>If an inlet temperature probe is not connected to the analyzer during countdown the measured temperature from the flue probe will be used as the inlet temperature.</p> <p>If neither probe is connected during countdown the analyzer's internal ambient temperature will be used as the inlet temperature.</p>
<p>Switching OFF the Analyzer</p>	<p>Press  & hold for 2 seconds to switch the analyzer OFF. The display counts down from 30 or less with the pump on to clear the sensors with fresh air – If the probe is still connected, make sure analyzer and probe are in fresh air.</p> <p>Press  if you want to stop the countdown and return to making measurements.</p> <p>Note: The analyzer will not switch off unless the CO reading is below 40ppm.</p>
<p>Worklight</p>	<p>Press  to switch the worklight on and off.</p> <p>NOTE: Use of the worklight significantly increases the current drain on the batteries.</p>
<p>Switching PUMP on / off</p>	<p>The analyzer normally operates with the pump on.</p> <p>Press  to switch the pump off and on.</p> <p>When the pump is switched off "-PO-" is displayed instead of the O₂, CO & CO₂ readings. The analyzer also displays "PUMP OFF" on the top line approx. every 30 seconds.</p> <p>NOTE: The pump will automatically switch itself off when the rotary switch is set to Menu, Status, Pressure, Exchange or Differential Temperature.</p>
<p>Zeroing the pressure sensor</p>	<p>To re-zero the pressure sensor when "PRS/TEMP" is selected on the dial, press and hold  until the top line display shows CAL ZERO.</p> <p>Always disconnect the pressure hose before zeroing.</p>
<p>Printing Data</p>	<p>Press and quickly release  to start the analyzer printing. The analyzer displays a series of bars until this is completed. Press and release the key again to abort printing.</p> <p>Make sure the printer is switched on, ready to accept data and its infrared receiver is in line with the analyzer's emitter (on top of the analyzer).</p>
<p>Storing a set of readings</p>	<p>Press and hold  for approx. 2 seconds.</p> <p>The top line briefly displays the log number.</p> <p>Note: This STORE function is inhibited in normal operation if the pump is switched off.</p>
<p>Using ▲/▼/↩ Buttons</p>	<p>The function buttons below the symbols ▲/▼/↩ are used to navigate through the menu when the rotary switch is set to "MENU" – See USING THE MENU, Pg. 18.</p>

COMBUSTION TESTS

Insert the tip of the flue probe into the center of the flue. The readings will stabilize within 60 seconds assuming the boiler conditions are stable.

The rotary switch can be used to display the following information:

FLUE 1

NAT	GAS
CO2	6.3%
O2	9.8%
EfG	81.1%
Tf	293.1F
Ta	73.5F

Fuel type can be changed via "MENU" or "STATUS" setting.
Carbon Dioxide (%)
Oxygen (%) left after combustion. Should be 20.9% ± 0.3% in fresh air.
Gross efficiency
Flue temperature (°F).
Inlet temperature (°F). Normally set by flue probe during fresh air purge.

Press  to print a full combustion test, (or send to PC via optional Wireless module).

Hold  for 2+ seconds to log a full combustion report.

FLUE 2

NAT GAS	
CO	52p
COa	83p
LOSS	17.8%
XAIR	88.7
PRS	0.04i

Fuel type can be changed via "Menu" or "STATUS" setting.
Carbon monoxide (ppm).
Losses calculated
Excess air %
Pressure reading

Press  to print a full combustion test, (or send to PC via optional Wireless module).

Hold  for 2+ seconds to log a full combustion report.

AUX display

PRS	0.00m
O2	9.8%
CO	52p
CO2	6.3%
NO	-N/F-
NOx	-N/F-

The AUX (auxiliary) display can be customized via "MENU" / "SCREEN" / "AUX".
The parameters displayed on lines 1, 2, 3, 4, 5 and 6 can be set by the user.
They remain the AUX parameters until changed by the user.
NO sensor not fitted
NO sensor not fitted

Press  to print a full combustion test, (or send to PC via optional Wireless module).

Hold  for 2+ seconds to log a full combustion report.

VIEWING/PRINTING OVERVIEW

The side lights on the display point to the active line.

Use ▲/▼ to change the pointer.

Press  to select a line. The side lights now flash.

Use ▲/▼ to scroll or change the selected line.

Press  to exit a line.

TO VIEW/PRINT A LOGGED REPORT

Select "MENU" / "REPORT" / "COMBUSTION" / "VIEW".

The side lights will point to the top line.

Press  to select this line. The side lights will flash.

Use ▲/▼ to scroll or change the Log No. (If only one report is logged, number will not change).

Press  to confirm a Log No. The side lights will stop flashing.

To view logged data press ▲/▼ to move the pointer to another line.

Press . Sidelights will flash on that line.

Use ▲/▼ to scroll through data.

To finish, press . Sidelights stop flashing.

Use ▲/▼ to scroll down to "PRINT"

Press  to print.

VIEWING/PRINTING A LONGED COMBUSTION TEST

Press  to print the test, (or send to PC via optional Wireless module).

COMBUSTION TEST - OPTIONAL NITRIC OXIDE SENSOR

Instructions for C165 Analyzers fitted with optional Nitric Oxide (NO) sensors

Displaying the Nitric Oxide (NO) reading

Select "Menu" on the rotary switch and navigate using the function buttons:

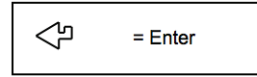
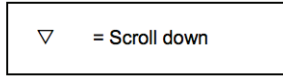
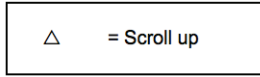

Select SCREEN and then select AUX

Choose a line to display the required readings as below

AUX display

PRS	0.00m
O2	20.9%
CO	52p
CO2	6.3%
NO	100p
NOx	105p

The AUX (auxiliary) display can be customized via MENU / SCREEN / AUX. The parameters displayed on lines 1, 2, 3, 4, 5 and 6 can be set by the user. They remain the AUX parameters until changed by the user.

NOTE: To EXIT the MENU at any time simply move the rotary switch to any position other than MENU. Any changes that have not been "entered" will be ignored.

Use ▲/▼ to navigate to the main menu option SCREEN. Press

Use ▲/▼ to navigate to the sub menu option AUX. Press

The display will show

AUX	
LINE	1

Press and a third line will appear.

Use ▲/▼ to navigate to the desired parameter to be displayed on line 1.

Press to select the parameter for Line 1 and repeat the process to select the display parameter for all four lines and then EXIT. Rotate the dial from MENU to AUX to display all your chosen settings.

PRINTING and STORING

The NO readings are printed and stored in the same way as the other combustion gas readings. On the printouts the NO readings appear directly below the flue CO readings.

The dial needs to be in the AUX, Flue 1 or Flue 2 positions to print or store flue combustion readings. When the dilution pump is operating to protect the CO sensor the NO readings are also affected by an unspecified amount. The screen will typically show:

P	0.00
O2	P-OFF
CO	P-OFF
CO2	P-OFF
NO	P-OFF
NOx	P-OFF

COMMISSIONING TEST

The Commissioning Test is based on TB143

Introduced in April 2013, Technical Bulletin 143 from the Heating and Hotwater Industry Council (HHIC), outlines a safer, clear and comprehensive procedure for commissioning condensing boilers without airgas ratio valves.

Rotate the dial to "COM TEST" position and follow the instructions on the screen

TEST 1 check the boiler at High Fire rate.

The boiler is switched on at High Fire rate.

The analyzer is first zeroed in **outside fresh air**.

Once the boiler is stable at high fire rate the probe is inserted into the air inlet of the flue and the CO₂ level is measured. The reading needs to be stable and less than or equal to 0.20%.

TEST 2

The probe is then inserted into the exhaust outlet of the boiler and the Ratio, CO and CO₂ levels are measured. These levels must be as per manufacturers instruction. Where manufacturer's instructions are not available the CO must be less than 350 ppm and the RATIO must be less than 0.0040.

TEST 3 checks the boiler at Low Fire flow rate where this is possible.

With the boiler operating stably at Low Fire rate the Ratio, CO and CO₂ levels are measured.

These levels must be as per manufacturers instruction. Where manufacturers' instructions are not available the CO must be less than 350 ppm and the Flue 2 must be less than 0.0040.

TEST 4 Measures Flow and Return Temperatures from the boiler

All the measured readings are logged and can be printed or transmitted to PC if an optional wireless module is fitted.

PRESSURE/TEMPERATURE TESTING

WARNING!

NEVER ATTEMPT TO TAKE A PRESSURE READING WITHOUT KNOWING THE MAXIMUM PRESSURE THAT MIGHT BE PRESENT. THIS INSTRUMENT'S PRESSURE TRANSDUCER IS **RATED AT 1.1 PSI WITH A MAXIMUM OVER RANGE OF 5.8 PSI**.

Select "PRS/TEMP". The pump stops automatically. Press  to auto-zero the pressure sensor. Using the black connectors and manometer hose, connect to P1 for single pressure or P1 and P2 for differential pressure.

PRS	0.004 i	Normal response or smoothed (damped) response can be selected via "MENU". 'High' or 'Low' resolution readings can be selected via "MENU". Pressure units can be selected via "MENU". Eg Flow Temp Eg Return Temp Differential Temp
i =	inH2O	
T1	167.1F	
T2	104.3F	
ΔT	62.8F	

Press  to print a full pressure test, (or send to PC via optional Wireless module).

Hold  for 2+ seconds to log a pressure report.

PRESSURE/TEMPERATURE TESTING CONT.

Viewing / printing a logged pressure/temp test

Select "MENU" / "REPORT" / "PRS-TEMP" / "VIEW"

Use ▲/▼ to select the log number to be printed.

Press  to print the test, (or send to PC via optional Wireless module).

WARNING!

Before using the C165 to measure the pressure of a gas/air ratio valve, read the boiler manufacturer's instructions thoroughly. If in doubt contact the boiler manufacturer. After adjusting a gas/air ratio valve it is essential that the CO, CO₂ and CO/CO₂ ratio readings are within the boiler manufacturer's specified limits.

If using larger bore tubing when performing pressure tests:

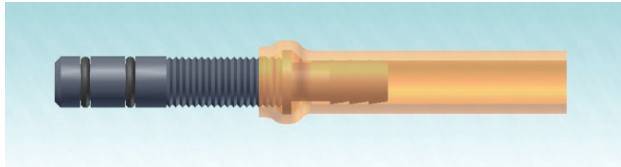

Push 'orange' tube over the rim of the spigot to ensure a gas tight seal.



This may not produce a gas tight seal.

HEAT EXCHANGE INTEGRITY TEST

There are many methods to test heat exchange integrity. One of these is to observe the Excess Air, O₂ and CO readings both before and after the blower turns on. If the heat exchanger is sealed, your O₂ and CO readings should remain fairly stable. A breach in the heat exchanger may allow fresh air to be forced into the flue after the blower turns on due to pressure increase in the plenum. The result may be a rise in the measured O₂ in the stack gas and an increase in Excess Air. In some sealed systems the fresh air drawn in through the breach may reduce the combustion air available leading to an increase in the CO reading. If either of these situations are present it is probable there is a problem with the Heat Exchanger which may require additional testing and inspections.

NOTE: Many cracks are invisible to borescopes or the naked eye, and only open or separate from pressure or temperature changes during operations.

Rotate dial to "EXCH TEST" Rotate test selector to "EXCH TEST". Call for heat on the system. Observe and wait for O₂ readings to stabilize.

HEAT EXCHANGE INTEGRITY TEST CONT.

Prior to the blower turning on, and after readings have stabilized, press  to store Pre-Blower test segment.

COp	000	Carbon monoxide (ppm).
O2%	20.09	Oxygen (%).
X	00	Excess Air.
PRESS	↓	Press  for Pre-Blower readings

Once the blower turns on press  to start the Post- Blower test.

EXC TEST
TO START
PRESS
↓

The C165 will wait 60 seconds and then record the Post-Blower values for CO, O₂ and Excess Air.

VARIANCE	
ΔCO	00
ΔO2%	00
ΔX	00

Test results will automatically be stored to exchange reports. Report includes both Pre and Post Blower test segments and differences.

Viewing / printing a logged Heat Exchange test

Select "MENU" / "REPORT" / "EXCH" / "VIEW"

Use ▲/▼ to select the log number to be printed.

Press  to print the test, (or send to PC via optional Wireless module).

Note: The analyzer's memory can store up to 20 Heat exchange integrity tests. To clear heat exchange memory select "MENU" / "REPORT" / "EXCH" / "DEL ALL" / "YES" then press .

ROOM CO TESTING

Select "ROOM CO" to measure and record CO readings for up to 30 minutes. (Tests every 120 seconds, 15 total tests)

SELECT	
ROOM	CO
TEST TYPE	
GENERAL	

Use ▲/▼ to select the test type from the following:

Press  to start Room CO testing.

ROOM CO TESTING CONT.

ROOM CO display

ROOM	CO
TEST	1/15
INT.	31s
CO	0p
LIMIT	10p
ALARM	30p

CO readings are recorded every 2 minutes for up to 30 minutes.
Test 00 = initial CO test in series.
Test Interval Time
Real time CO reading (ppm).

The user can stop the Room CO test at any time by pressing .

If not stopped earlier, the Room CO test will automatically end after the designated time.

The CO test series is automatically stored in the memory as a log number.

When completed the log can be printed immediately by pressing .

VIEWING/PRINTING A LOGGED ROOM CO TEST

Select "MENU" / "REPORT" / "ROOM CO" / "VIEW"

When LEDs are not flashing

Use the ▲/▼ keys to change line.

Press  to cause the LEDs on that line to flash.

With the LEDs flashing, press ▲/▼ to allow the parameter on that line to be changed.

Press  to select that change.

The LEDs stop flashing and ▲/▼

Use ▲/▼ to change the line again.

ROOM	CO
LOG	01
TEST	3
CO	0p
GENERAL	
PRINT	↓

TEST TYPE

With no LEDs flashing

Use the ▲/▼ keys to move the lit LEDs to the line you want.

You can change the LOG number and the TEST number so that you can view individual test results.

Press  to select the line you want, and the LEDs will start to flash.

Now use the ▲/▼ keys to change the number (the TEST number or the LOG number).

Press  when you are happy with the changes. The LEDs will stop flashing. Now use the ▲/▼ keys to move the LEDs to the PRINT line.

Sending to the printer or wireless device will only occur when you move the LEDs to the print line and press .

Press  to print the test, (or send to PC via optional Wireless module).

PRINTOUTS

COMBUSTION

COMMISSION TEST

PRS/TEMP

HEAT EXCHANGE

AUX

C165	SW19392	V1.00
YOUR COMPANY NAME & PHONE NUMBER HERE		
SERIAL NO.	9876543210	
LOG NO.	01	
DATE	19/01/18	
TIME	11:06:09	
CAL DUE ON ----- 18/12/18		
COMBUSTION		
FUEL TYPE ----- NAT GAS		
CO2	%	9.0
O2	%	5.1
CO	ppm	50
NO	ppm	-N/F-
NOx	ppm	-N/F-
FLUE	°F	149.4
INLET	°F	62.9
NETT	°F	86.5
CO/CO2		0.0005
NET	%	97.9
LOSS	%	2.1
XAIR	%	32
PRS	mbar	0.21

CUSTOMER		
APPLIANCE		
REFERENCE		

C165	SW19392	V1.00
YOUR COMPANY NAME & PHONE NUMBER HERE		
SERIAL NO.	9876543210	
LOG NO.	08	
DATE	19/01/18	
TIME	11:50:04	
CAL DUE ON ----- 18/12/18		
COMMISSION TEST		
ANALYZER ZERO		
CO2	%	0.00
CO	ppm	0
FLUE INTEGRITY		
CO2	%	0.00
MAX GAS FLOW		
CO2	%	9.1
CO	ppm	50
CO/CO2		0.0005
MIN GAS FLOW		
CO2	%	9.0
CO	ppm	48
CO/CO2		0.0005
FLOW & RETURN		
T1	°F	149.9
T2	°F	62.9
ΔT	°F	86.5

CUSTOMER		
APPLIANCE		
REFERENCE		

C165	SW19392	V1.00
YOUR COMPANY NAME & PHONE NUMBER HERE		
SERIAL NO.	9876543210	
LOG NO.	20	
DATE	19/01/18	
TIME	12:23:59	
CAL DUE ON ----- 18/12/18		
PRS/TEMP		
PRS	mbar	18.01
T1	°F	167.9
T2	°F	149.4
ΔT	°F	18.5

CUSTOMER		
APPLIANCE		
REFERENCE		

C165	SW19392	V1.00
YOUR COMPANY NAME & PHONE NUMBER HERE		
SERIAL NO.	9876543210	
LOG NO.	04	
DATE	19/01/16	
TIME	11:09:16	
CAL DUE ON ----- 18/12/18		
EXCHANGE		
PRIOR TO BLOWER ON		
CO	ppm	23
O2	%	7.0
XAIR	%	50.3
DATE	19/01/16	
TIME	11:09:16	

AFTER BLOWER ON		
CO	ppm	14
O2	%	7.5
XAIR	%	5
DATE	19/01/16	
TIGHTNESS	MINS	TIME

VARIANCE		
ΔCO	ppm	-9
ΔO2	%	0.5
ΔXAIR	%	5.6

CUSTOMER		
APPLIANCE		
REFERENCE		

C165	SW19392	V1.00
YOUR COMPANY NAME & PHONE NUMBER HERE		
SERIAL NO.	9876543210	
LOG NO.	01	
DATE	19/01/18	
TIME	09:46:53	
CAL DUE ON ----- 18/12/18		
AUX		
FUEL TYPE ----- LIGHT OIL		
CO2	%	0.53
CO(n)	ppm	02++
CO/CO2		0.0000
O2	%	20.2
FLUE	°F	-N/F-
INLET	°F	-N/F-

CUSTOMER		
APPLIANCE		
REFERENCE		

USING THE MENU

Select "Menu" on the rotary switch and navigate using the function buttons:

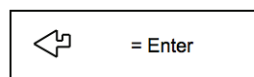
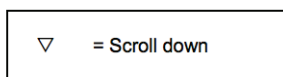
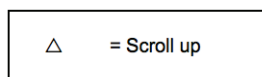

NOTE: To "EXIT" the "MENU" at any time simply move the rotary switch to any position other than "Menu". Any changes that have not been "entered" will be ignored.

MENU
SETUP
UNITS
SCREEN
REPORT
SERVICE

As you scroll up or down the side LEDs illuminate to point to the active line

MAIN MENU	SUB MENU	OPTIONS / COMMENTS
SETUP	LANGUAGE	English
	SET TIME	HH:MM:SS format e.g. 7 am = 07:00:00, 7pm = 19:00:00
	SET DATE	MM/DD/YY format
	PRINTER	KM IRP KANE IRP-2 WIRELESS (if installed) SERIAL
	PASSKEY	1111 (wait 5 secs after entering last digit)
	BACK	

As you scroll up or down the side LEDs illuminate to point to the active line

NOTE: To "EXIT" the "MENU" at any time simply move the rotary switch to any position other than "Menu". Any changes that have not been "entered" will be ignored.

MAIN MENU	SUB MENU	OPTIONS / COMMENTS
UNITS	FUEL TYPE	NAT GAS, TOWN GAS, COKE GAS, PROPANE, BUTANE, LPG, LIGHT OIL, BIO OIL, WOOD PELLETS, BIO GAS, USER 1 to 5
	FUEL ORIGIN	UK, FRANCE, SPAIN, N AMERICA, BELGIUM, NETHERLAND
	EFFICIENCY	GROSS, NET, GROSS COND, NET COND
	PRESSURE	See next table below
	GAS	ppm, ppm(n), mg/m3, mg/m3(n), mg/kWh, mg/kWh(n)
	TEMP	C, F
	O ₂ REF	Up/down to set value (3% default)
	NO _x CALC	Up/down to set value (5% default)
BACK		

As you scroll up or down the side LEDs illuminate to point to the active line

NOTE: To "EXIT" the "MENU" at any time simply move the rotary switch to any position other than "Menu". Any changes that have not been "entered" will be ignored.

USING THE MENU CONT.

MAIN MENU	SUB MENU	OPTIONS / COMMENTS
PRESSURE	FILTER	FILTER OFF = normal response. ON = slower (damped) response
	RESOLUTION	LOW = e.g. 0.00i inH2O resolution. HIGH = displays to an extra decimal place
	UNITS	mbar, Pa, PSI, mmHg, hPa, inH2O, mmH2O, kPa, psi
	BACK	

As you scroll up or down the side LEDs illuminate to point to the active line

NOTE: To "EXIT" the "MENU" at any time simply move the rotary switch to any position other than "Menu". Any changes that have not been "entered" will be ignored.

MAIN MENU	SUB MENU	OPTIONS / COMMENTS
SCREEN	CONTRAST	Factory setting is 14
	BACKLIGHT	0 to 300 secs
	AUX	Enables users to customize the parameters on the AUX display: LINE 1, LINE 2, LINE 3, LINE 4, LINE 5, LINE 6, BACK
	BACK	

As you scroll up or down the side LEDs illuminate to point to the active line

NOTE: To "EXIT" the "MENU" at any time simply move the rotary switch to any position other than "Menu". Any changes that have not been "entered" will be ignored.

MAIN MENU	SUB MENU	OPTIONS / COMMENTS
REPORT	AUX	Stored AUX tests VIEW, DEL ALL, BACK
	COMBUSTION	Stored combustion tests: VIEW, DEL ALL, BACK
	COMMISSION	Stored commission tests: VIEW, DEL ALL, BACK
	PRS/TEMP	Stored pressure tests: VIEW, DEL ALL, BACK
	EXCH	Stored exchange tests: VIEW, DEL ALL, BACK
	ROOM CO	Stored room CO tests: VIEW, DEL ALL, BACK
	HEADER	LINE 1 LINE 2 BACK
	BACK	

As you scroll up or down the side LEDs illuminate to point to the active line

NOTE: To "EXIT" the "MENU" at any time simply move the rotary switch to any position other than "Menu". Any changes that have not been "entered" will be ignored.

MAIN MENU	SUB MENU	OPTIONS / COMMENTS
SERVICE	CODE	Password protected for authorized service agents only. Leave set to 000000.

As you scroll up or down the side LEDs illuminate to point to the active line

NOTE: To "EXIT" the "MENU" at any time simply move the rotary switch to any position other than "Menu". Any changes that have not been "entered" will be ignored.

USING THE C165 AS A THERMOMETER OR PRESSURE METER

Rotate the dial to the "PRS/TEMP" position.

The display will show:

P	0.004 i	Real time pressure reading.
i =	inH2O	Use the P1 connection for pressure sensor.
T1	70.3F	Use the T1 connection for the flow temperature sensor.
T2	70.3F	Use the T2 connection for the return temperature sensor.
ΔT	0.0F	Real time temperature difference.

If using larger bore tubing when performing pressure tests:

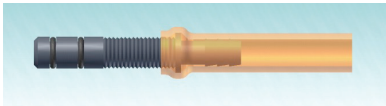

Push 'orange' tube over the rim of the spigot to ensure a gas tight seal.



This may not produce a gas tight seal.

The standard printout for this mode is as follows:

C165	SW19392	V1.00
YOUR COMPANY NAME & PHONE NUMBER HERE		
SERIAL NO.	9876543210	
LOG NO.	01	
DATE	19/01/18	
TIME	09:46:53	
CAL DUE ON	18/12/18	
AUX		
FUEL TYPE	LIGHT OIL	
CO2	%	0.53
CO(n)	ppm	02++
CO/CO2	0.0000	
O2	%	20.2
FLUE	°F	-N/F-
INLET	°F	-N/F-
CUSTOMER		
<div style="border: 1px dashed black; height: 20px; width: 100%;"></div>		
APPLIANCE		
<div style="border: 1px dashed black; height: 20px; width: 100%;"></div>		
REFERENCE		
<div style="border: 1px dashed black; height: 20px; width: 100%;"></div>		

MEASURING FLUE GASES

After the countdown is finished and the analyzer is correctly set up, put its flue probe into the appliance's sampling point. The tip of the probe should be at the center of the flue. Use the flue probe's depth stop cone to set the position.

With balanced flues, make sure the probe is positioned far enough into the flue, so no air can 'back flush' into the probe.

NOTE: Ensure that the flue probe handle does not get hot!

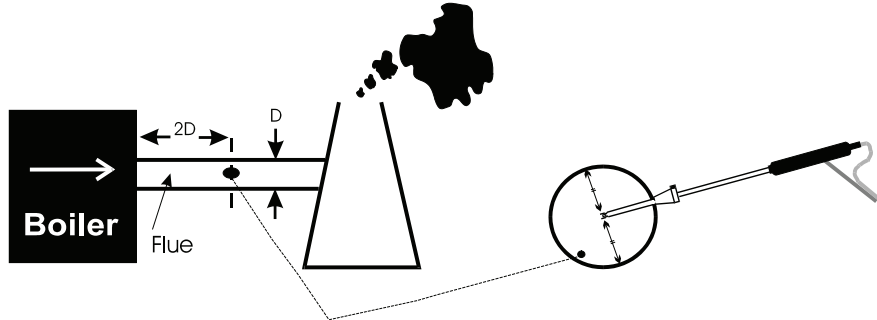

Make sure you do not exceed the analyzer's operating specifications. In particular:

- Do not exceed the flue probe's maximum temperature (1112°F)
- Do not exceed the analyzer's internal temperature operating range
- Do not put the analyzer on a hot surface
- Do not exceed the water trap's levels
- Do not let the analyzer's particle filter become dirty and blocked

View the displayed data to ensure that stable operating conditions have been achieved and the readings are within the expected range.

Press and quickly release  to start the analyzer printing. The analyzer displays a series of bars until this is completed. Press and release the key again to abort printing.

Make sure the printer is switched on, ready to accept data and its infrared receiver is in line with the analyzer's emitter (on top of the analyzer).

CO PROTECTION PUMP OPERATION

CO Protection pump operation is totally automatic. When the analyzer measures a CO concentration of 2000ppm the pump is switched on. The main pump is switched off and the display shows P-OFF until the gas in the sensor is below 2000ppm.

WOOD PELLETS

WOOD PELLETS		Fuel type can be changed via "MENU" or "STATUS"
R	0.0448	CO/CO ₂ ratio.
CO	P-OFF	Pump Off pump operating
CO ₂	P-OFF	Carbon dioxide (%).
XAIR	88.7	Excess air %
PRS	0.004 i	Pressure reading

"DILUTE" flashes on the screen to indicate that the CO measurement has been diluted.

The time taken for the CO sensor to return to zero takes much longer after it has been exposed to high levels of CO.

The CO high warning still operates whenever the CO reading is above 400 ppm until the dilution pump operates.

WHERE TO TEST

AIR CONDITIONING / HEAT PUMP

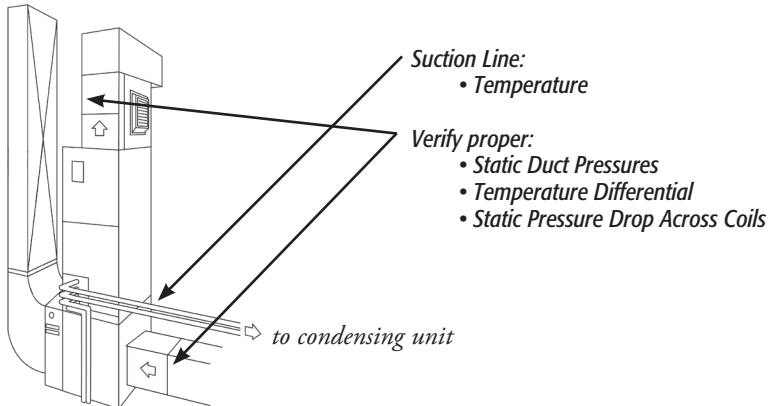

BOILER & WATER HEATERS & HIGH EFFICIENCY MODULATING HOT WATER SYSTEMS

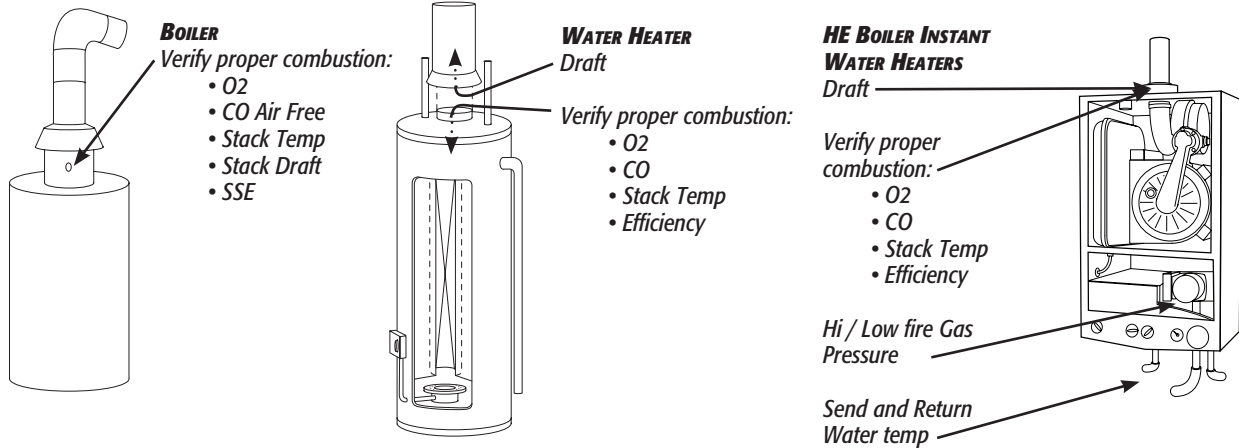

FURNACES: 80%

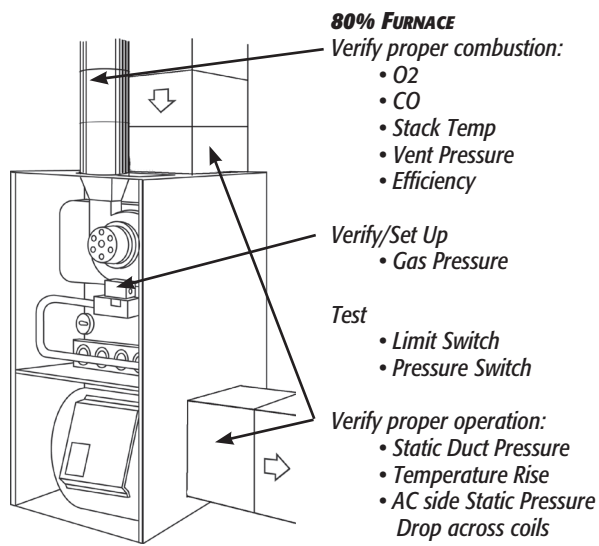

FURNACES: 90%

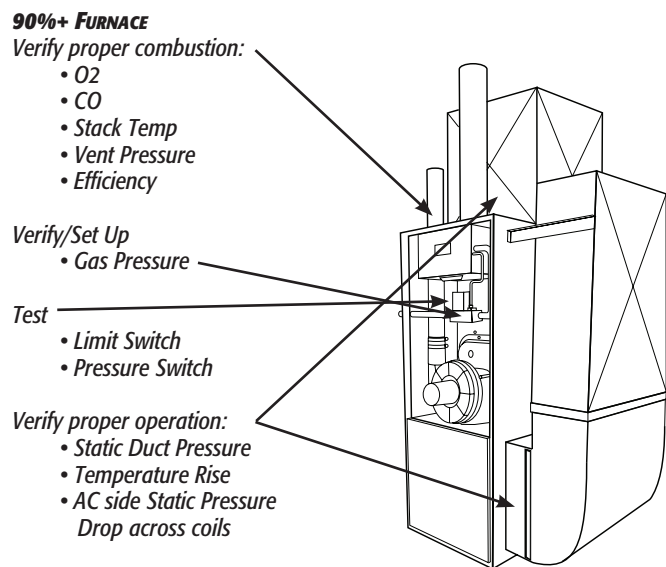

FURNACES (CONTINUED): ATMOSPHERIC, GAS & OIL

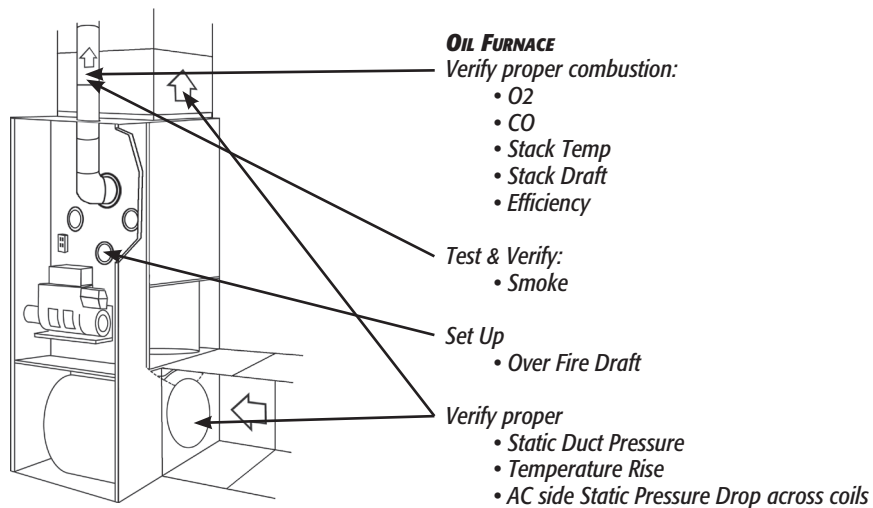
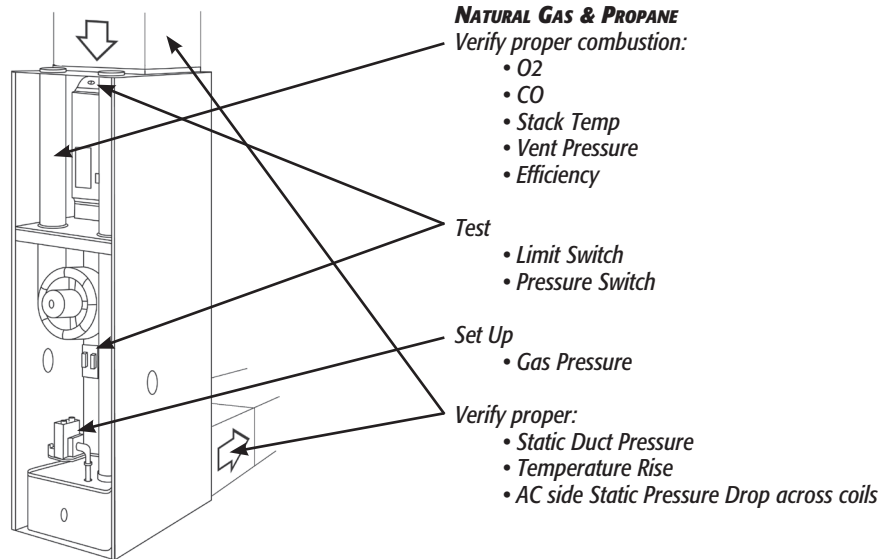
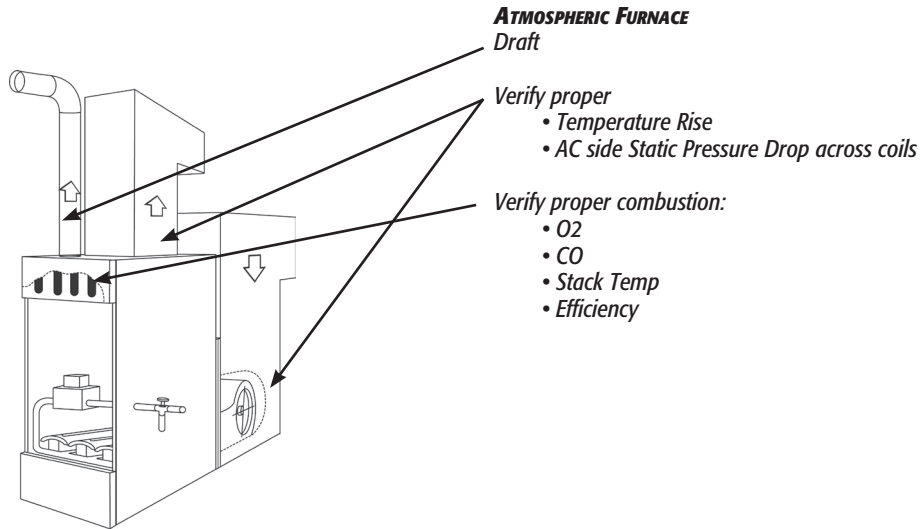

ANALYZER PROBLEM SOLVING

If any problems are not solved with these solutions, contact us or an authorized repair center.

FAULT SYMPTOM	CAUSES / SOLUTIONS
Oxygen too high CO ₂ too low	Air leaking into probe, tubing, water trap, connectors or internal to analyzer.
Batteries not holding charge Analyzer not running on mains adapter.	Batteries exhausted. AC charger not giving correct output. No fuse
Analyzer does not respond to flue gas	Particle filter blocked. Probe or tubing blocked. Pump not working or damaged with contaminants.
Net temperature or Efficiency calculation incorrect.	Ambient temperature set wrong during Automatic Calibration
Flue temperature readings erratic	Temperature plug reversed in socket. Faulty connection or break in cable or plug.
T flue or ΔT displays (-N/F-)	Probe not connected. Faulty connection or break in cable or plug.
EFF or X-Air displays (- O ₂ 2++)	CO ₂ reading is below 2%. O ₂ > 18%
Analyzer just continually beeps	Turn dial back to "MENU" and press "ENTER" Turn dial back to "EXCH TEST" and press "ENTER"

FREQUENTLY ASKED QUESTIONS

Q: What is the countdown time on a C165

A: There are two levels of countdown (aka fresh air purge) on a C165.
From first switch on if 'cold' (more than 41°F from the temperature at which calibrated) = 90 secs.
From first switch on if 'warm' (within 41°F of the temperature at which calibrated) = 60 secs

PRODUCT REGISTRATION

Register Your Analyzer

Product registration allows us to contact you regarding potential updates or safety information related to your analyzer. It also speeds up the recertification process when you send your analyzer in for annual service. Finally users have the option to be notified of related news or new product information.

Register Online

Visit UEITEST.COM

Click the Product Registration banner on the home page & fill out the form

Upload a scan or photo of your proof of purchase

Enter the Captcha form & send

Register by Mail

Fill out the form at the back of this manual

Mail it to UEi Test Instruments

Find the Serial Number by removing the protective boot from the analyzer

The serial number will be found on the back label

ANNUAL SERVICE & RECERTIFICATION

What You Get

Sensor replacement (or calibration)
30-point inspection by factory trained professionals
Firmware and software updates
Certificate of calibration
Another 12-month warranty on the analyzer
Return unit freight paid – within continental US and Canada
List of work performed, and parts replaced

RECERTIFICATION SERVICES

Turnaround

Before starting any service work, we stabilize your analyzer in ambient air

Our standard turnaround is 2 working days

If your unit arrives on Monday, and the recertification service is paid for, our aim is to ship it back to you no later than Wednesday. If your unit requires extensive diagnostic or repair work, we will contact you with a quotation and estimated repair time.

Pre-authorizing payment for your repair on a credit card saves time. We will ask you for authority to charge the full cost of a service but if we only calibrate your unit, we'll only charge the calibration fee - no tricks!

Charges will be applied upon completion of the recertification service

Shipping time for most repairs is 1 to 3 days. UEi pays return freight.

ONLINE BOOKING PROCEDURE

How to Request Service Online

Visit UEITEST.COM

Click the Recertification & Service banner on the home page

US Pricing is listed up front

Scroll down to Service Request Form and click GO

Canadian customers need to click UEi Canada Service Info

Fill out the form

Upload a scan or photo of your proof of purchase

Enter the Captcha form & Send

We'll send an acknowledgment of your registration within 24 business hours

Find the Serial Number by removing the protective boot from the analyzer

The serial number will be found on the back label

RETURNING YOUR ANALYZER

Before returning your analyzer to UEi Test Instruments, please ensure that you enclose:

- RMA label if you have used our online booking in process
- Your full contact details
- A daytime telephone number
- Details of faults you might have experienced
- Any relevant accessories (i.e. probe, printer, adaptor & leak detectors). Any accessories that are returned will be checked

Packing Your Analyzer

Put analyzer and probes back in their cases

The case should be put into a box with 1-2 inches of packing on each side for protection. When shipping an analyzer only, use a shoe-box size container with enough packing to fill the empty space.

Print out the service paperwork sent to you and include it in the packaging.

NOTE: If you are having specific problems that you want evaluated, please add those comments on the paper work in detail.

Include any accessories that may be related to issues with the analyzer

Please be sure no personal items are packed with the return equipment

You pay to ship your analyzer to us and we'll pay the return freight back to you – within continental US and Canada.

We advise the use of couriers that provide insurance and tracking services

WHEN WE RECEIVE YOUR ANALYZER:

Our Service Engineers will inspect the analyzer & accessories. If you haven't booked and paid online, they will contact you to confirm the total recertification cost.

Once accepted, the work will be carried out and on completion, returned to you.

WHERE TO SEND YOUR ANALYZER

USA	Canada
UEi Test Instruments	Kane Canada Measurement Solutions
800-547-5740	877-475-0648
7601 East 88th Place	150-13571 Verdun Place
Indianapolis, IN 46256	Richmond, BC V6V 1W5

COLD WEATHER PRECAUTIONS

It is important you keep your flue gas analyzer in a warm place overnight

Electronic devices that become really cold, by being left in a vehicle overnight, suffer when taken into a warm room the next morning. Condensation may form which can affect the analyzer's performance & cause permanent damage. See operating and storage temperature specifications.

Electrochemical sensors used in flue gas analyzers can be affected by condensation or water being sucked into the analyzer, as the small apertures on top of sensors can become blocked with water, stopping sensors seeing flue gas. When this happens, oxygen or carbon dioxide reading will display as "—" & sensors may be permanently damaged

If you think that your analyzer is affected by condensation or water ingress, it may be possible to rectify the problem yourself. Simple leave the analyzer running in a warm place, with the pump 'ON' sampling fresh air for a few hours (use mains adapter/battery charger if needed). If, after doing this, you still experience problems please contact our Service Centers.

ANALYZER SPECIFICATION

PARAMETER	RANGE	RESOLUTION	ACCURACY
Temp Measurement			
Flue Temperature	32-1112°F	0.1°F	±3.6°F ±0.3% reading
Inlet Temperature (Internal sensor)	32-122°F	0.1°F	±1.8°C ±0.3% reading
Inlet Temperature (External sensor)	32-1112°F	0.1°F	±3.6°F ±0.3% reading
Flue Gas Measurement			
Oxygen* ²	0-21%	0.1%	±0.3%
Carbon monoxide* ¹	0-20ppm 21-2,000ppm	1ppm	±3ppm ±5% reading
	Above 2000ppm Purge pump operates		unspecified
Carbon dioxide* ¹	0-20%	0.1%	±0.3% volume
Efficiency (Net or Gross)* ²	0-99.9%	0.1%	±1.0% reading
Efficiency High (C)* ²	0-119.9%	0.1%	±1.0% reading
Excess Air* ²	0-250%	0.1%	±0.2% reading
CO/CO ₂ ratio* ²	0-0.999	0.0001	±5% reading
Nitric Oxide Sensor (optional)	0 to 100ppm	1ppm	+ 2ppm <30ppm* ¹ +5ppm <100ppm* ¹
	Overrange to 1500ppm		+5% reading >100ppm
Pressure (differential)			
Nominal range 32"	±0.2 mbar (±0.080 inWC)		±0.005 mbar (±0.002 inWC)
Maximum over range without damage to sensor is 60"	±1 mbar (±0.401 inWC) ±80 mbar (±32 inWC)	Maximum 0.001 mbar <25 mbar (0.001 inWC < 10.016)	±0.03 mbar (±0.080 inWC) ±3% of reading: same
Pre-programmed Fuels	Natural gas, Propane, Butane, LPG, Light Oils (28/35 sec), Wood Pellets, Town Gas, Coke Gas, Bio Oil, Bio Gas		
User programmed Fuels	5 user defined fuels		
Storage Capacity	60 Combustion tests 20 Pressure & Temperature tests 20 Heat Exchange tests 20 Temperature tests 20 Room CO tests 20 Commissioning tests		

*1 Using dry gases at STP

*2 Calculated

ANALYZER SPECIFICATION CONT.

Carbon Dioxide resolution is 0.01% below 1% measured value.

Ambient Operating Range	32°F to 113°F 10% to 90% RH non-condensing
Storage Temperature Range	0°F to 120°F (-18°C to 50°C)
Battery Type / Life	4 AA cells >8 hours using Alkaline AA cells
Chargers (optional)	100-240v charger, for NiMH batteries only
Dimensions Weight: Handset: Probe:	0.8kg handset with protective rubber cover 7.87 x 1.77 x 3.5 in (200 x 45 x 90mm) 11.8 in (300mm) long including handle. 2.3 dia. x 9.4 in (6mm dia. x 240mm) long stainless-steel shaft with 6.5ft (2m) long neoprene hose. Type K thermocouple
CO Protection Pump:	Operates at 2000ppm measured CO.

ELECTROMAGNETIC COMPATIBILITY

European Council Directive 89/336/EEC requires electronic equipment not to generate electromagnetic disturbances exceeding defined levels and have adequate immunity levels for normal operation. Specific standards applicable to this analyzer are stated below.

As there are electrical products in use pre-dating this Directive, they may emit excess electromagnetic radiation levels and, occasionally, it may be appropriate to check the analyzer before use by:

Use the normal start up sequence in the location where the analyzer will be used.

Switch on all localized electrical equipment capable of causing interference.

Check all readings are as expected. A level of disturbance is acceptable.

If not acceptable, adjust the analyzer's position to minimize interference or switch off, if possible, the offending equipment during your test.

At the time of writing this manual (July 2018) Uei Test Instruments is not aware of any field-based situation where such interference has occurred, and this advice is only given to satisfy the requirements of the Directive. This product has been tested for compliance with the following generic standards and is certified to be compliant.



EN 61000-6-3 : 2011

EN 61000-6-1 : 2007

Specification EC/EMC/KI/KANE458 details the specific test configuration, performance and conditions of use.

END OF LIFE DISPOSAL

The Waste Electrical or Electronic Equipment (WEEE) Directive requires countries in the EU to maximize collection and environmentally responsible processing of these items. Products are now labelled with a crossed out wheeled bin symbol to remind you that they can be recycled.

Note: Batteries used in this instrument should be disposed of in accordance with current legislation and local guidelines.

PRODUCT REGISTRATION

Before use, please register your analyzer at www.ueitest.com or complete, detach and mail in

Your Details	
Name:	
Job Title:	
Company Name:	
Company Address 1:	
Address 2:	
Town/City:	
County:	
Zip Code:	
Country:	
Phone Number:	
Fax Number:	
Mobile Number:	
Email Address:	

Product Details <i>Note: Proof of Purchase is required for warranty claims.</i>	
Date Purchased (mm/dd/yy):	
Purchased From:	
Model Number:	C165KIT
Product Serial Number: (located on back label beneath rubber boot)	



Scan the QR code to go directly to Register your Product on-line or complete, detach and return the Product Registration form in this manual.

Privacy

Your feedback is important to us, please add any additional comments you would like to make with regard to your recent UEi purchase:

Thank you for completing this survey. All the information we have collected is confidential. We do not sell or share data with any other company or organization.

Send Completed form to:

USA
UEi Test Instruments
7601 East 88th Place
Indianapolis, IN 46226

Canada
Kane Canada Measurement Solutions
150-12571 Verdun Place
Richmond, BC V6V 1W5

Thank you for buying this analyzer.



SURVEY

Why did you buy a UEi Product? (Select all that apply)

- | | | |
|--|--|--|
| <input type="checkbox"/> UEi Brand | <input type="checkbox"/> Cost of Ownership | <input type="checkbox"/> Value for Money |
| <input type="checkbox"/> Dealer Recommendation | <input type="checkbox"/> Our Fixed Price Servicing Program | <input type="checkbox"/> Cost of Ownership |
| <input type="checkbox"/> Not your Decision | <input type="checkbox"/> Other: | |

What brand was your previous analyzer?

- | | | |
|--|--|------------------------------------|
| <input type="checkbox"/> 1st time purchase | <input type="checkbox"/> UEi | <input type="checkbox"/> TPI |
| <input type="checkbox"/> Testo | <input type="checkbox"/> E Instruments | <input type="checkbox"/> Bacharach |
| <input type="checkbox"/> Other: | | |

Which magazines do you read?

USA

- | | |
|--|--|
| <input type="checkbox"/> Supply House Times | <input type="checkbox"/> Contracting Business |
| <input type="checkbox"/> ACHR News | <input type="checkbox"/> Oil and Energy |
| <input type="checkbox"/> RSES Journal | <input type="checkbox"/> National HVAC Insider |
| <input type="checkbox"/> Engineered Systems Magazine | |

Canada

- | | |
|---|--|
| <input type="checkbox"/> Contracting Canada | <input type="checkbox"/> HVAC XCHANGER |
| <input type="checkbox"/> HRAI Insight Magazine | <input type="checkbox"/> HPAC/PCC Magazine |
| <input type="checkbox"/> Plumbing + HVAC Magazine | |

EN 50379 REGULATED INSTRUCTIONS

EN 50379 Section 4.3.2 "Instructions" defines a number of specific points that must be included in the relevant instruction manuals. The paragraph numbering below relates to that section of EN 50379.

- a) The C165 is compliant the EN 50379 Part 2 and Part 3.
- b) The C165 is intended to be used with the following fuels:
Natural gas, Propane, Butane, Light oil (28/35 sec), Wood pellets, Town Gas, Coke Gas, Bio Oil, Bio Gas
- c) The C165 is designed for use with either non-rechargeable alkaline AA cells or rechargeable NiMH AA cells. Four cells are needed. Types cannot be mixed. Under no circumstances should any attempt be made to recharge alkaline cells.

The battery charger supplied with the C165 is rated for indoor use only. Its voltage input must be in the range 100 – 240V AC at 50 – 60Hz with a current capability of 0.3 A. The chargers output voltage is 9V DC at a maximum of 0.66A.

The charger has no user serviceable components.

Only a correctly specified and rated charger must be used with the C165.

- d) The C165 is not designed for continuous use and is not suitable for use as a fixed safety alarm.
- e) An explanation of all the symbols used on the analyzer's display is given in Display Parameters Pg. 8 of this manual.
- f) The recommended minimum time required to perform one complete measurement cycle and achieve correct indication of the measured values in EN 50379 Part 2 is 110 seconds. This is based on the T90 times defined in the standard, always assuming that parameters being measured have reached stability. This time is the summation of the times for a draught test (10 secs) and a combustion test (90 secs) plus the time to move the hose connection from the pressure input to the water trap (10 secs)
- g) The recommended minimum time required to perform one checking procedure in EN 50379 Part 3 is 110 seconds as described in section f) above.
- h) Some commonly occurring materials, vapor or gases may affect the operation of the C165 in the long or the short term though in normal use UEi is not aware of any specific issues that have affected the product. The following list is included to satisfy the stated requirements of EN 50379: Solvents, Cleaning fluids, Polishes, Paints, Petrochemicals, Corrosive gases
- i) The C165 is fitted with an electrochemical CO sensor and an infra-red CO₂ sensor which have an expected life of more than 5 years. The calibration of these sensors must be confirmed on an annual basis. The batteries have an expected operational life of more than 500 re-charge cycles.
- j) The C165 is designed to operate at ambient temperatures in the range 32°F to 113°F with relative humidity of 10% to 90% non-condensing. While it is recommended that the analyzer is given the protection of a carry case during transportation it is not required for normal operation.
- k) The C165 has an initial start-up delay following switch on of between 90 and 60 seconds dependent on ambient temperature. There is no additional delay after battery replacement.
- l) Most sensors used in combustion analyzers give a zero output when they fail, and it is widely recommended that analyzers are regularly checked (also known as a bump test) using either a can of test gas or a known source of combustion products.

The C165 must have its calibration checked on an annual basis and be issued with a Certificate of Calibration.

The sensor within the C165 can only be replaced by UEi Test Instruments.

The water trap should be checked on a regular basis while the analyzer is in use (every few minutes) as the amount of condensate generated varies with the fuel type, atmospheric conditions and the appliances operating characteristics.

The particle filter should be checked at least on a daily basis when using 'clean' fuels and more often when using liquid or solid fuels.

Detailed instructions regarding the changing of the filter and the emptying of the water trap are given in "Before Using the Analyzer" Pg. 7 of this manual.

- m)  **WARNING!**

When using a C165 to test an appliance a full visual inspection of the appliance, in accordance with its manufacturer's instructions, must also be carried out.

WARRANTY INFORMATION

The C165 combustion analyzer is warranted for one year including sensors. If within the warranty period your instrument should become inoperative from such defects, the unit will be repaired or replaced at UEI's option. This warranty covers normal use and does not cover damage which occurs in shipment or failure which results from alteration, tampering, accident, misuse, abuse, neglect or improper maintenance (calibration). Batteries and consequential damage resulting from failed batteries are not covered by warranty. Any implied warranties, including but not limited to implied warranties of merchantability and fitness for a particular purpose, are limited to the express warranty. UEI shall not be liable for loss of use of the instrument or other incidental or consequential damages, expenses, or economic loss, or for any claim or claims for such damage, expenses or economic loss. A purchase receipt or other proof of original purchase date will be required before warranty repairs will be rendered. Instruments out of warranty will be repaired (when repairable) for a service charge. Warranty only covers hardware and does not extend to software applications. Contact UEI for specific warranty and service information.

UEI Test Instruments
1-800-547-5740 • info@ueitest.com

This warranty gives you specific legal rights. You may also have other rights which vary from state to state.