



205 Westwood Ave, Long Branch, NJ 07740  
Phone: 866-94 BOARDS (26273) / (732)-222-1511  
Fax: (732)-222-7088 | E-mail: [sales@touchboards.com](mailto:sales@touchboards.com)

# BrightLink<sup>®</sup> 685Wi/695Wi User's Guide



---

# Contents

<b>BrightLink 685Wi/695Wi User's Guide</b> .....	<b>11</b>
<b>Introduction to Your Projector</b> .....	<b>12</b>
Projector Features.....	12
Product Box Contents.....	14
Additional Components .....	15
Additional Projector Software and Manuals .....	16
Optional Equipment and Replacement Parts.....	17
Warranty and Registration Information .....	18
Notations Used in the Documentation .....	19
Where to Go for Additional Information .....	19
Projector Part Locations .....	19
Projector Parts - Front/Top .....	20
Projector Parts - Side.....	21
Projector Parts - Interface Panel.....	22
Projector Parts - Base.....	24
Projector Parts - Control Panel .....	25
Projector Parts - Interactive Pens and Pen Tray .....	26
Projector Parts - Remote Control.....	28
Projector Parts - Touch Unit .....	30
<b>Setting Up the Projector</b> .....	<b>32</b>
Projector Placement.....	32
Projector Setup and Installation Options .....	33
Projection Distance.....	34
Removing and Attaching the Cable Cover.....	34
Projector Connections .....	36
Connecting to Computer Sources.....	36
Connecting to a Computer for USB Video and Audio.....	37
Connecting to a Computer for VGA Video.....	38
Connecting to a Computer for HDMI Video and Audio .....	39
Connecting to a Computer for USB Mouse Control.....	39

Connecting to a Computer for Sound.....	40
Connecting to Video Sources .....	41
Connecting to an HDMI Video Source .....	41
Connecting to an MHL-Compatible Device .....	42
Connecting to a Component Video Source .....	43
Connecting to a Composite Video Source .....	44
Connecting to a Video Source for Sound .....	44
Connecting to an External Computer Monitor.....	45
Connecting to External Speakers .....	46
Connecting a Microphone.....	47
Connecting to External USB Devices .....	48
USB Device Projection.....	48
Connecting a USB Device or Camera to the Projector.....	49
Selecting the Connected USB Source .....	50
Disconnecting a USB Device or Camera From the Projector.....	50
Connecting to a Document Camera .....	50
Connecting Multiple Projectors of the Same Model .....	51
Installing Batteries in the Remote Control .....	52
Installing Batteries in the Pens .....	53
<b>Using the Projector on a Network .....</b>	<b>56</b>
Wired Network Projection.....	56
Connecting to a Wired Network.....	56
Selecting Wired Network Settings .....	57
Wireless Network Projection .....	60
Installing the Wireless LAN Module.....	61
Using Quick Wireless Connection (Windows).....	63
Selecting Wireless Network Settings Manually.....	65
Wireless LAN Menu Settings .....	68
Selecting Wireless Network Settings in Windows.....	69
Selecting Wireless Network Settings on Mac .....	69
Setting Up Wireless Network Security .....	69
Connecting Directly to a Smartphone or Tablet.....	70
Setting Up Projector Network E-Mail Alerts .....	72

Network Projector E-mail Alert Messages .....	74
Setting Up Monitoring Using SNMP .....	74
Controlling a Networked Projector Using a Web Browser .....	76
Crestron RoomView Support.....	79
Setting Up Crestron RoomView Support .....	79
Controlling a Networked Projector Using Crestron RoomView .....	80
<b>Using Basic Projector Features .....</b>	<b>82</b>
Turning On the Projector .....	82
Turning Off the Projector .....	84
Selecting the Language for the Projector Menus.....	85
Image Shape .....	86
Correcting Image Shape with the Keystone Buttons.....	86
Correcting Image Shape with Quick Corner .....	89
Correcting Image Shape with Arc Correction.....	91
Resizing the Image with the Wide and Tele Buttons .....	92
Adjusting the Image Position .....	93
Focusing the Image.....	94
Remote Control Operation .....	96
Using the Remote Control as a Wireless Mouse .....	97
Using the Remote Control as a Pointer.....	98
Selecting an Image Source .....	99
Projection Modes .....	101
Changing the Projection Mode Using the Remote Control .....	101
Changing the Projection Mode Using the Menus.....	102
Image Aspect Ratio .....	103
Changing the Image Aspect Ratio .....	103
Available Image Aspect Ratios .....	103
Color Mode.....	104
Changing the Color Mode.....	104
Available Color Modes.....	105
Turning On Auto Iris.....	106
Controlling the Volume with the Volume Buttons.....	107
Projecting a PC Free Presentation .....	107

Supported PC Free File Types .....	108
Starting a PC Free Slide Show .....	109
Starting a PC Free Movie Presentation .....	111
PC Free Display Options .....	112
<b>Adjusting Projector Features .....</b>	<b>114</b>
Projecting Two Images Simultaneously.....	114
Input Sources for Split Screen Projection .....	117
Using Multiple Projectors.....	117
Projector Identification System for Multiple Projector Control .....	118
Setting the Projector ID.....	118
Setting the Remote Control ID .....	119
Adjusting Color Uniformity .....	120
Adjusting the Lamp's Brightness .....	122
Matching the Image Colors .....	124
Adjusting RBGCMY .....	126
Shutting Off the Picture and Sound Temporarily .....	129
Stopping Video Action Temporarily .....	129
Zooming Into and Out of Images .....	130
Projector Security Features.....	131
Password Security Types .....	132
Setting a Password .....	132
Selecting Password Security Types.....	134
Entering a Password to Use the Projector.....	135
Saving a User's Logo Image to Display.....	136
Locking the Projector's Buttons .....	138
Unlocking the Projector's Buttons .....	139
Installing a Security Cable .....	139
Creating a User Pattern to Display .....	140
Copying Menu Settings Between Projectors .....	141
Saving Settings to a USB Flash Drive.....	142
Transferring Settings From a USB Flash Drive.....	143
Saving Settings to a Computer .....	144
Transferring Settings From a Computer .....	146

<b>Using the Interactive Features .....</b>	<b>148</b>
Interactive Modes .....	148
Using the Projected Screen as a Whiteboard (Built-in Whiteboard Mode).....	149
Drawing on a Projected Image (Built-in Annotation Mode) .....	150
Controlling Computer Features from a Projected Screen (PC Interactive Mode).....	152
PC Interactive Mode System Requirements .....	154
Using the Interactive Pens .....	155
Using the Pens .....	155
Pen Calibration .....	158
Calibrating Automatically .....	159
Calibrating Manually .....	161
Using Finger Touch Interactivity .....	164
Touch Unit Safety Instructions.....	164
Calibrating for Finger Touch Interactivity .....	166
Using Finger Touch Operations.....	169
Using BrightLink with a Computer .....	171
Adjusting the Pen Operation Area .....	172
Easy Interactive Tools .....	174
Windows Pen Input and Ink Tools .....	175
Enabling Windows Pen Input and Ink Tools.....	175
Using Windows Pen Input and Ink Tools .....	176
Using BrightLink Without a Computer .....	177
Using the Built-in Annotation Mode .....	178
Built-in Tools for Use Without a Computer.....	179
Using the Built-in Whiteboard Mode .....	181
Changing Pen Width and Color Using the Built-in Toolbar .....	182
Projector Control Toolbar .....	182
Selecting a Networked Device Source .....	185
Splitting the Screen .....	187
Selecting Interactive Split Screen Settings .....	189
Interactive Features when Projecting with Two Projectors .....	190
Using Interactive Features Temporarily on One Projector .....	190

<b>Adjusting the Menu Settings .....</b>	<b>192</b>
Using the Projector's Menus.....	192
Image Quality Settings - Image Menu .....	194
Input Signal Settings - Signal Menu.....	196
Projector Feature Settings - Settings Menu.....	199
Projector Setup Settings - Extended Menu.....	203
Projector Network Settings - Network Menu.....	213
Projector Setup Settings - ECO Menu .....	215
Projector Information Display - Info Menu .....	217
Event ID Code List.....	218
Projector Reset Options - Reset Menu .....	219
<b>Maintaining and Transporting the Projector .....</b>	<b>221</b>
Projector Maintenance .....	221
Cleaning the Projection Window.....	221
Cleaning the Obstacle Sensor .....	222
Cleaning the Projector Case.....	223
Air Filter and Vent Maintenance .....	223
Cleaning the Air Filter and Vents.....	223
Replacing the Air Filter.....	227
Projector Lamp Maintenance.....	230
Replacing the Lamp .....	231
Resetting the Lamp Timer.....	235
Replacing the Remote Control Batteries .....	236
Replacing the Soft Pen Tips .....	238
Replacing the Hard Pen Tips.....	241
Transporting the Projector.....	242
<b>Solving Problems .....</b>	<b>243</b>
Projection Problem Tips .....	243
Projector Light Status .....	244
Using the Projector Help Displays .....	247
Solving Image or Sound Problems .....	247
Solutions When No Image Appears.....	248
Solutions When Image is Incorrect Using the USB Display Function .....	249



Solutions When "No Signal" Message Appears.....	249
Displaying From a PC Laptop .....	250
Displaying From a Mac Laptop .....	250
Solutions When "Not Supported" Message Appears .....	250
Solutions When Only a Partial Image Appears .....	251
Solutions When the Image is Not Rectangular .....	251
Solutions When the Image Contains Noise or Static .....	252
Solutions When the Image is Fuzzy or Blurry .....	253
Solutions When the Image Brightness or Colors are Incorrect .....	253
Solutions to Sound Problems .....	254
Solutions to Microphone Problems .....	255
Solving Projector or Remote Control Operation Problems .....	255
Solutions to Projector Power or Shut-Off Problems .....	255
Solutions to Problems with the Remote Control.....	256
Solutions to Password Problems .....	257
Solving Interactive Problems.....	257
Solutions When "Error Occurred in the Easy Interactive Function" Message Appears.....	258
Solutions When the Interactive Pens Do Not Work.....	258
Solutions When the Interactive Pen Position Is Not Accurate.....	259
Solutions When Manual Calibration Does Not Work.....	259
Solutions When the Interactive Pens Are Slow or Difficult to Use.....	259
Solutions When the Interactive Pens Cause Interference or Unwanted Effects .....	260
Solutions When Finger Touch Interactivity Does Not Work .....	260
Solving Network Problems .....	261
Solutions When Network Alert E-Mails are Not Received.....	261
Solutions When You Cannot Access the Projector Through the Web .....	261
Where to Get Help.....	262
<b>Technical Specifications .....</b>	<b>264</b>
General Projector Specifications .....	264
Projector Lamp Specifications .....	265
Remote Control Specifications .....	266
Projector Dimension Specifications .....	266
Projector Electrical Specifications .....	266

Projector Environmental Specifications.....	267
Projector Safety and Approvals Specifications.....	268
Supported Video Display Formats.....	268
USB Display System Requirements.....	270
<b>Notices .....</b>	<b>272</b>
Recycling.....	272
Important Safety Information .....	272
Important Safety Instructions.....	273
Restriction of Use .....	276
List of Safety Symbols (corresponding to IEC60950-1 A2).....	276
FCC Compliance Statement.....	280
Open Source Software License.....	280
Binding Arbitration and Class Waiver .....	327
Trademarks .....	330
Copyright Notice.....	330
A Note Concerning Responsible Use of Copyrighted Materials.....	331
Copyright Attribution .....	331

---

# BrightLink 685Wi/695Wi User's Guide

Welcome to the BrightLink 685Wi/695Wi *User's Guide*.

For a printable PDF copy of this guide, [click here](#).

---

# Introduction to Your Projector

Refer to these sections to learn more about your projector and this manual.

[Projector Features](#)

[Notations Used in the Documentation](#)

[Where to Go for Additional Information](#)

[Projector Part Locations](#)

## Projector Features

The BrightLink 685Wi/695Wi projectors include these special features:

### Unique interactive functions

- Annotation with or without a computer
- Annotation with two pens at the same time
- Enhanced Easy Interactive toolbar for Windows and Mac
- BrightLink 695Wi: Touch-based interactivity for as many as six users

### Ultra short throw projection system

- Project a 99-inch (251-cm) image (WXGA) from just 11 inches (279 mm) away
- Easily mounted on a wall or table (with the optional table projection mount) for fast, low-cost installations
- Can be mounted vertically to create an interactive workspace directly on a table surface
- Reduced shadow interference and glare

### Bright, high-resolution images

- Up to 3500 lumens of color brightness (color light output) and 3500 lumens of white brightness (white light output)

**Note:** Color brightness (color light output) and white brightness (white light output) will vary depending on usage conditions. Color light output measured in accordance with IDMS 15.4; white light output measured in accordance with ISO 21118.

- Native resolution of 1280 × 800 pixels (WXGA)

### **Flexible connectivity**

- Three HDMI ports (one with MHL support) for computer or video device connection
- Plug-and-play 3-in-1 USB projection, audio, and mouse control for instant setup
- Wired network support for projection
- Projector monitoring and control via remote network computer
- Optional wireless network support, including video and audio transfer
- PC Free photo slide shows via connected USB memory devices or Epson document camera
- Dual VGA ports for connections by multiple presenters
- Port for connecting an external monitor
- Port for connecting a microphone
- Projection from iOS or Android devices with the wireless LAN module and free Epson iProjection app; visit [epson.com/iprojection](http://epson.com/iprojection) (U.S.) or [epson.ca/iprojection](http://epson.ca/iprojection) (Canada) for more information

### **Innovative display and operation features**

- Support for side-by-side projector mounting with continuous annotation
- Low total cost of ownership with long-life projector lamp and high-efficiency air filter
- High digital zoom ratio for larger images in shorter projection distances
- 14000:1 contrast ratio and Auto Iris control for sharp, detailed images
- Built-in closed captioning decoder
- Powerful 16 W speaker system with audio out port for connecting external speakers
- Epson's Instant Off and Direct Power On features for quick setup and shut down
- Support for Crestron RoomView network monitoring systems
- Network message broadcast system to project timely messages to all networked projectors

[Product Box Contents](#)

[Additional Components](#)

[Additional Projector Software and Manuals](#)

[Optional Equipment and Replacement Parts](#)

[Warranty and Registration Information](#)

**Parent topic:** [Introduction to Your Projector](#)

## Related concepts

[Projector Part Locations](#)

## Product Box Contents

Save all the packaging in case you need to ship the projector. Always use the original packaging (or equivalent) when shipping.

Make sure your projector boxes included all of these parts:

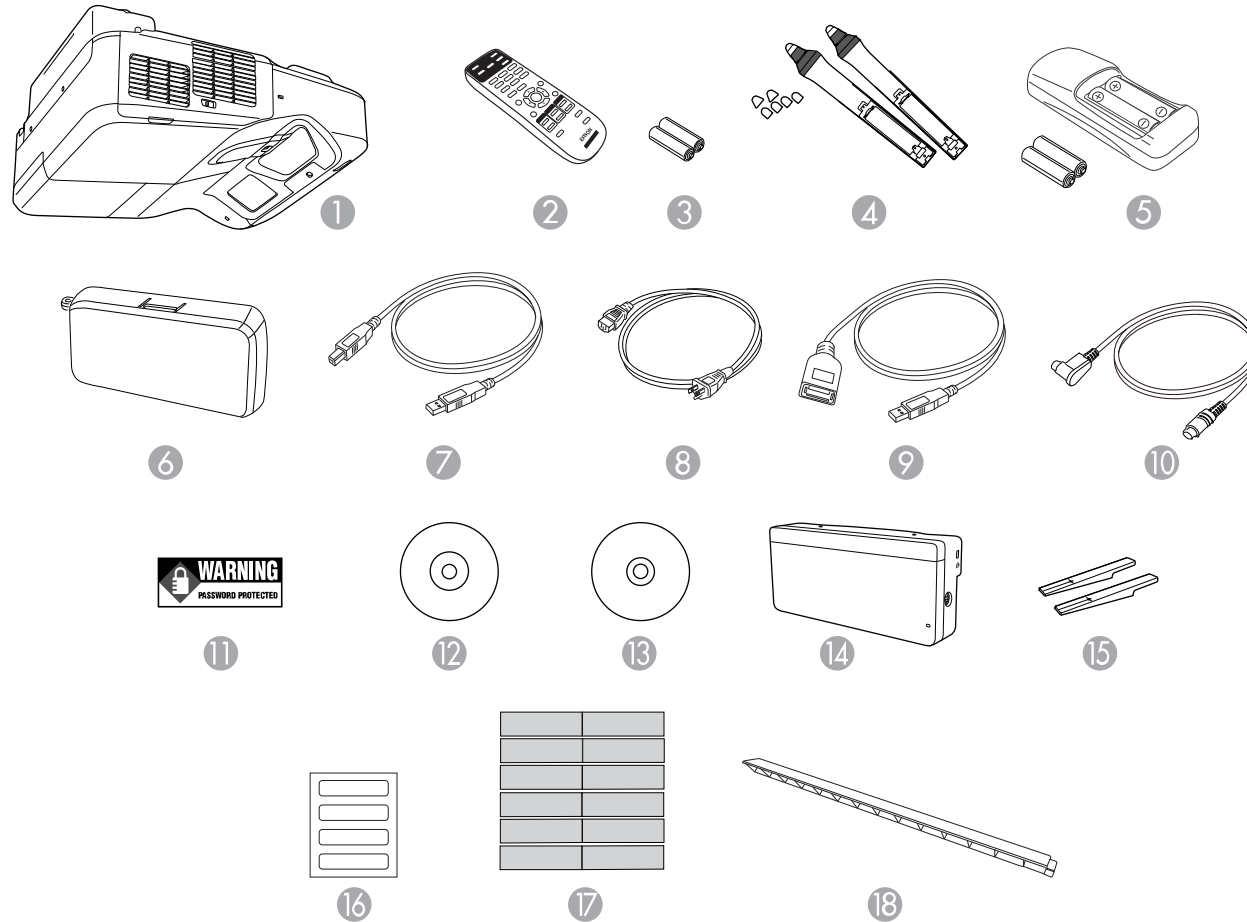

- 1 Projector
- 2 Remote control
- 3 Remote control batteries (two AA alkaline)
- 4 Pens and replacement pen tips (two hard tips and four soft tips)
- 5 Battery charger and two rechargeable batteries
- 6 Pen tray
- 7 USB cable
- 8 Power cord
- 9 USB extension cable
- 10 Touch Unit connection cable (BrightLink 695Wi)
- 11 Password Protected sticker
- 12 Projector manuals and software download links CD
- 13 Projector software for Easy Interactive Function CD
- 14 Touch Unit (BrightLink 695Wi)
- 15 Markers (x2) (BrightLink 695Wi)
- 16 Labels (x4) (BrightLink 695Wi)
- 17 Tape for securing markers (BrightLink 695Wi)
- 18 Infrared deflectors (x8) (BrightLink 695Wi)

**Parent topic:** [Projector Features](#)

**Related concepts**

[Projector Part Locations](#)

## Additional Components

Depending on how you plan to use the projector, you may need to obtain additional components.

**Note:** To connect a Mac that does not include a compatible video output port, you need to obtain an adapter that allows you to connect to an input port on the projector. Contact Apple for compatible adapter options. To connect a smartphone or tablet, you may need to obtain an adapter that allows you to connect to the projector. This allows you to mirror your smartphone or tablet screens, watch movies, and more. Contact your device manufacturer for compatible adapter options.

Unless listed as available from Epson in this table, see your local computer or electronics dealer for purchase information.

Signal or connection type	Additional component necessary
Composite video	RCA-style video or A/V cable
Component video	D-sub, 15-pin, component-to-VGA video cable or adapter Available for purchase from Epson or an authorized Epson reseller.
HDMI	Compatible HDMI cable Available for purchase from Epson or an authorized Epson reseller.  <b>Note:</b> Older Mac computers (2009 and earlier) may not support HDMI audio.
MHL	MHL-compatible device or device with an integrated MHL connector, MHL cable, or HDMI cable and MHL adapter compatible with your device Available for purchase from Epson or an authorized Epson reseller.
Audio from certain ports	Commercially available audio cable compatible with your device

Parent topic: [Projector Features](#)

## Additional Projector Software and Manuals

After connecting and setting up the projector, install the projector software from the included software CD, or download the software and manuals as necessary.

You can install the projector software programs listed here and view their manuals for instructions on using them.

**Note:** If you still need help after checking this manual and the sources listed here, you can use the Epson PrivateLine Support service to get help fast. For details, see "Where to Get Help".



Projector software	Manual	Description
EasyMP Monitor (Windows only)	<i>EasyMP Monitor Operation Guide</i>	Lets you monitor and control your projector through the network.  You can download the latest software and documentation from the Epson web site. Go to <a href="http://epson.com/support">epson.com/support</a> (U.S.) or <a href="http://epson.ca/support">epson.ca/support</a> (Canada) and select your projector.
EasyMP Multi PC Projection	<i>EasyMP Multi PC Projection Operation Guide</i>	Lets you hold interactive meetings by projecting the computer screens of users over a network.
EasyMP Network Updater (Windows only)	<i>EasyMP Network Updater Operation Guide</i>	Lets you update firmware for a projector over a wired LAN.  You can download the latest software and documentation from the Epson web site. Go to <a href="http://epson.com/support">epson.com/support</a> (U.S.) or <a href="http://epson.ca/support">epson.ca/support</a> (Canada) and select your projector.
Epson iProjection app	Instructions are included with the app	Lets you project from an iOS device, Android device, or Chromebook if your projector is connected to a network that includes a wireless access point.  Visit <a href="http://epson.com/iprojection">epson.com/iprojection</a> (U.S.) or <a href="http://epson.ca/iprojection">epson.ca/iprojection</a> (Canada) for more information.
Easy Interactive Tools	<i>Easy Interactive Tools Operation Guide</i>	Lets you use your computer to interactively draw on projected images

Parent topic: [Projector Features](#)

## Optional Equipment and Replacement Parts

You can purchase screens, other optional accessories, and replacement parts from an Epson authorized reseller. To find the nearest reseller, call 800-GO-EPSON (800-463-7766) in the U.S. or 800-807-7766 in Canada. Or you can purchase online at [epsonstore.com](http://epsonstore.com) (U.S. sales) or [epsonstore.ca](http://epsonstore.ca) (Canadian sales).

Epson offers the following optional accessories and replacement parts for your projector:

<b>Option or part</b>	<b>Part number</b>
Genuine Epson replacement lamp (ELPLP91)	V13H010L91
Replacement air filter (ELPAF49)	V13H134A49
Wireless LAN module (ELPAP10)	V12H731P02
Additional interactive pen A (ELPPN05A) (orange)	V12H773010
Additional interactive pen B (ELPPN05B) (blue)	V12H774010
Replacement set of hard pen tips (ELPPS03)	V12H775010
Replacement set of soft pen tips (ELPPS04)	V12H776010
Ultra-short throw wall mount (ELPMB46)	V12H777020
Table projection mount (ELPMB29)	V12H516020
Epson DC-07 USB document camera (ELPDC07)	V12H759020
Epson DC-13 document camera (ELPDC13)	V12H757020
Epson DC-21 document camera (ELPDC21)	V12H758020
PowerLite Pilot 2 (ELPCB02)	V12H614020
Active speakers (ELPSP02)	V12H467020
100-inch whiteboard	V12H831000
Pixie Plus	ELPSP10
6 ft. (1.8 m) VGA computer cable	F3H982-06
10 ft. (3.0 m) VGA computer cable	F3H982-10
10 ft. (3.0 m) Component-to-VGA video cable	ELPKC19

In addition to the accessories listed above, 1-year and 2-year extended service plans are available.

**Parent topic:** [Projector Features](#)

## **Warranty and Registration Information**

Your projector comes with a basic warranty that lets you project with confidence. For details, see the warranty that came with your projector.

In addition, Epson offers free Extra Care Road Service. In the unlikely event of an equipment failure, you won't have to wait for your unit to be repaired. Instead, Epson will ship you a replacement unit anywhere in the United States, Canada, or Puerto Rico. See the Extra Care Road Service brochure for details.

Register your product online using the projector CD or at this site: [epson.com/webreg](http://epson.com/webreg).

Registering also lets you receive special updates on new accessories, products, and services.

**Parent topic:** [Projector Features](#)

## Notations Used in the Documentation

Follow the guidelines in these notations as you read your documentation:

- **Warnings** must be followed carefully to avoid bodily injury.
- **Cautions** must be observed to avoid damage to your equipment.
- **Notes** contain important information about your projector.
- **Tips** contain additional projection information.

**Parent topic:** [Introduction to Your Projector](#)

## Where to Go for Additional Information

Need quick help on using your projector? Here's where to look for help:

- Built-in help system

Press the **Home** button on the remote control or projector, select **Help**, and press **Enter** to get quick solutions to common problems.

- [epson.com/support](http://epson.com/support) (U.S) or [epson.ca/support](http://epson.ca/support) (Canada)

View FAQs (frequently asked questions) and e-mail your questions to Epson technical support 24 hours a day.

- If you still need help after checking this manual and any other sources listed here, you can use the Epson PrivateLine Support service to get help fast. For details, see "Where to Get Help".

**Parent topic:** [Introduction to Your Projector](#)

### Related references

[Where to Get Help](#)

## Projector Part Locations

Check the projector part illustrations to learn about the parts on your projector.

- Projector Parts - Front/Top
- Projector Parts - Side
- Projector Parts - Interface Panel
- Projector Parts - Base
- Projector Parts - Control Panel
- Projector Parts - Interactive Pens and Pen Tray
- Projector Parts - Remote Control
- Projector Parts - Touch Unit

**Parent topic:** Introduction to Your Projector

## Projector Parts - Front/Top

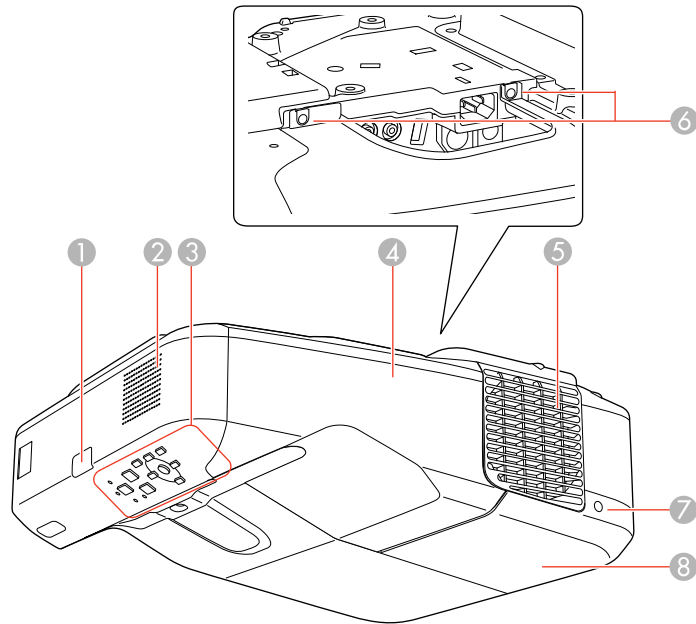

- 1 Remote control receiver
- 2 Speaker
- 3 Control panel

- 4 Cable cover
- 5 Exhaust vent
- 6 Lamp screws
- 7 Lamp cover screw
- 8 Lamp cover

Parent topic: [Projector Part Locations](#)

## Projector Parts - Side

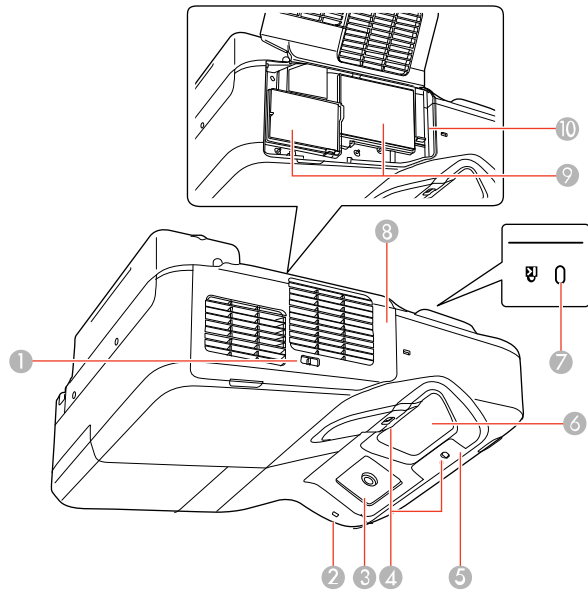

- 1 Air filter cover switch
- 2 Wireless LAN light
- 3 Interactive pen receiver
- 4 Obstacle sensors
- 5 Remote receiver

- 6 Projection window
- 7 Security lock port
- 8 Air filter cover
- 9 Air intake vents (air filter)
- 10 Focus lever

Parent topic: [Projector Part Locations](#)

## Projector Parts - Interface Panel

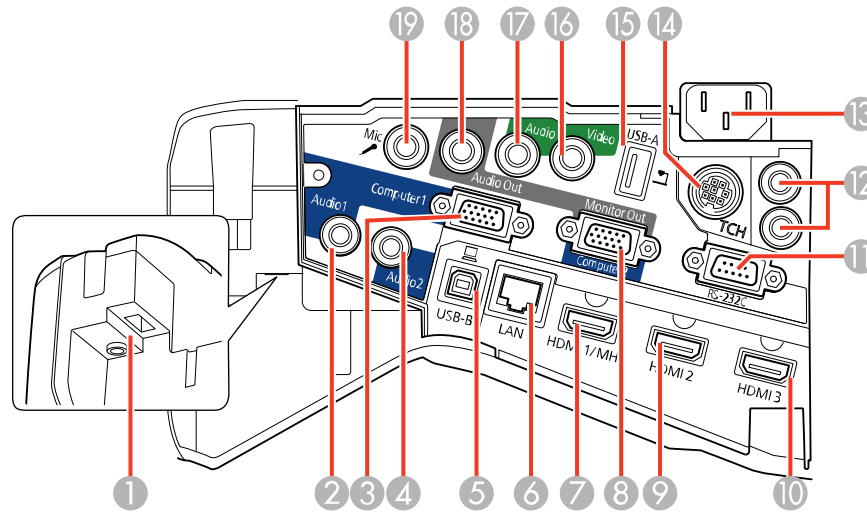

- 1 Optional wireless LAN module slot
- 2 **Audio1** port
- 3 **Computer1** port
- 4 **Audio2** port
- 5 **USB-B** port
- 6 Network (**LAN**) port
- 7 **HDMI 1/MHL** port

- 8 **Monitor Out/Computer2** port
- 9 **HDMI 2** port
- 10 **HDMI 3** port
- 11 **RS-232C** port
- 12 **SYNC In/Out** port
- 13 Power inlet
- 14 Touch unit (**TCH**) port (BrightLink 695Wi)
- 15 **USB-A** port
- 16 **Video** port
- 17 **Audio** port
- 18 **Audio Out** port
- 19 **Mic** (microphone) port

**Parent topic:** [Projector Part Locations](#)

**Related references**

[Projector Light Status](#)

## Projector Parts - Base

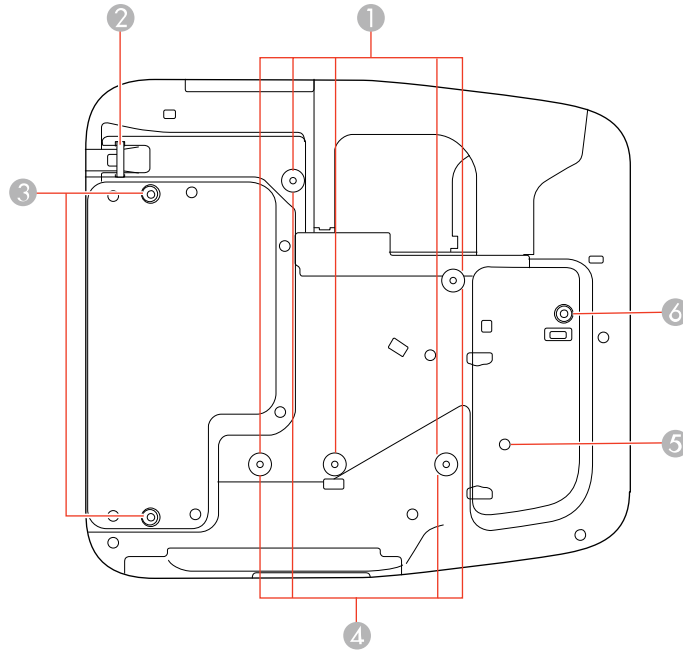

- 1 Ceiling mount holes (5)
- 2 Security cable attachment point
- 3 Rear foot holes
- 4 Wall mount plate holes (4)
- 5 Illumination sensor
- 6 Front foot hole

Parent topic: [Projector Part Locations](#)



## Projector Parts - Control Panel

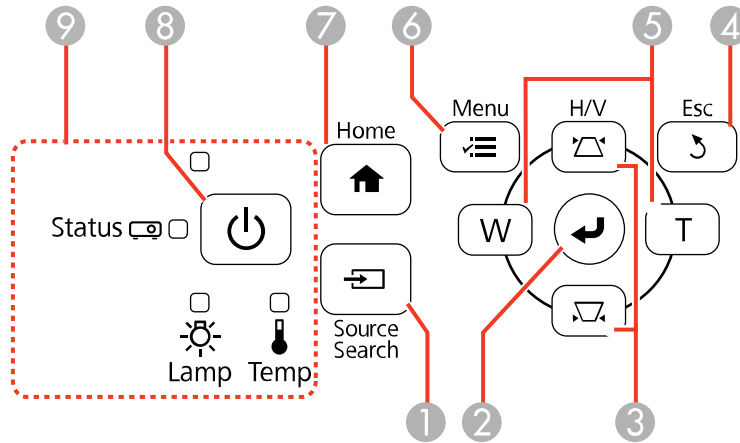

- 1 **Source Search** button (searches for connected video sources)
- 2 **Enter** button (selects options)
- 3 Horizontal/Vertical keystone adjustment buttons (display the adjustment screen and adjust screen shape) and arrow buttons
- 4 **Esc** button (cancels/exits functions)
- 5 **W/T** buttons (Wide/Tele; adjust projected image size) and arrow buttons
- 6 **Menu** button (accesses projector menu system)
- 7 **Home** button (displays home screen)
- 8 Power button
- 9 Projector status lights (power, Status, Lamp, and Temp)

Parent topic: [Projector Part Locations](#)

## Projector Parts - Interactive Pens and Pen Tray

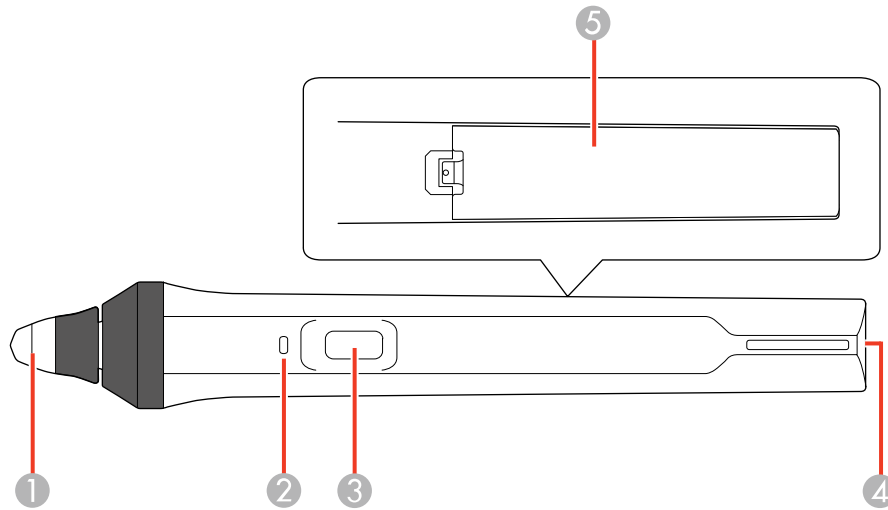

- 1 Pen tip
- 2 Battery light
- 3 Function button
- 4 Attachment for optional strap or cord

5 Battery cover

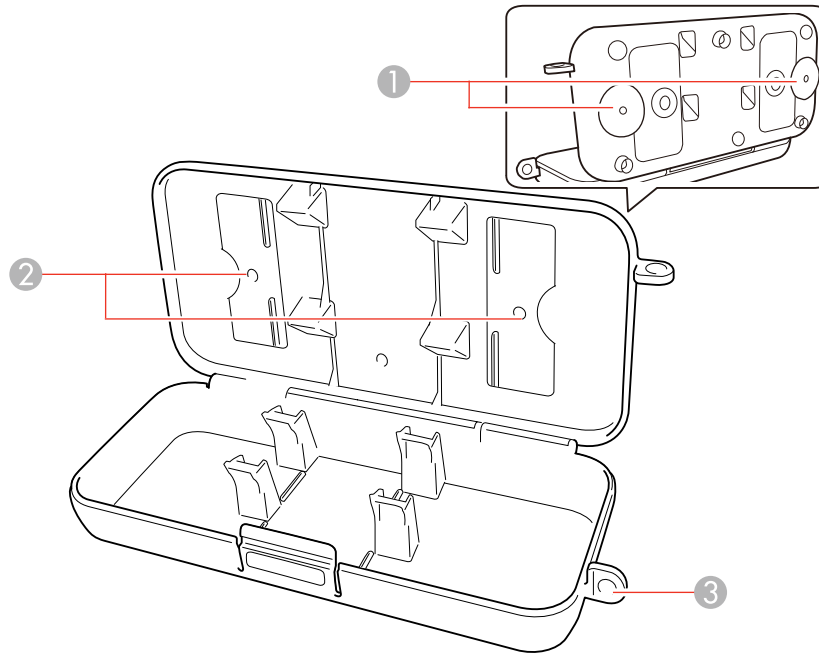

- 1 Installation magnets
- 2 Mounting holes
- 3 Security lock hole

**Parent topic:** [Projector Part Locations](#)

# Projector Parts - Remote Control

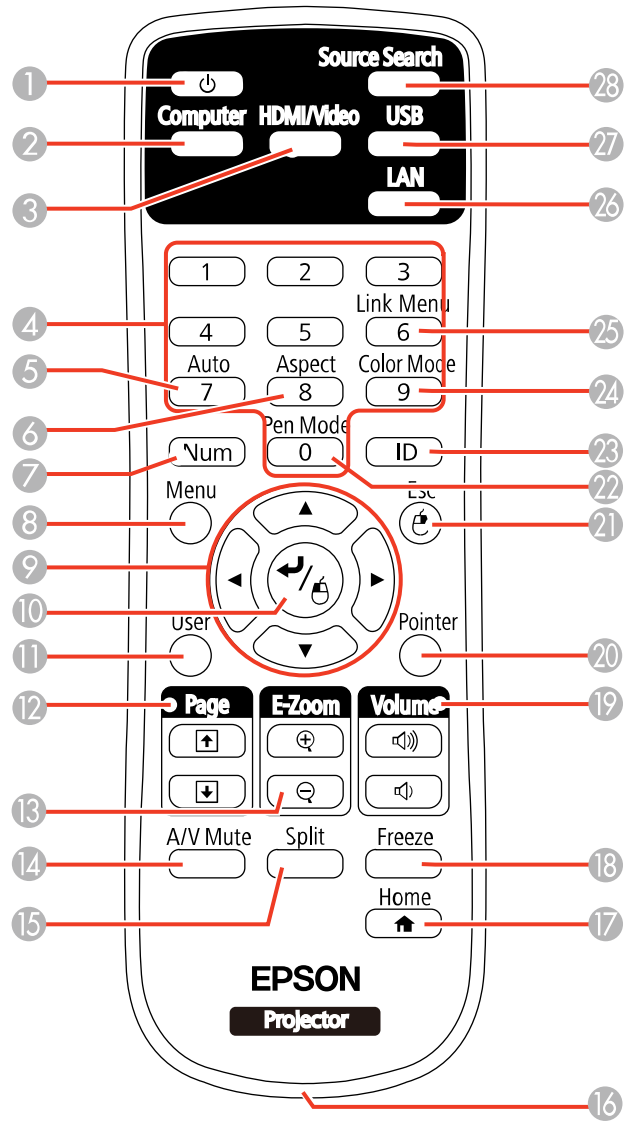

- 1 Power button
- 2 **Computer** button (cycles through connected computer sources)
- 3 **HDMI/Video** button (cycles through connected HDMI/video sources)
- 4 Numeric buttons (enter numbers)
- 5 **Auto** button (automatically adjusts position, tracking, and sync settings)
- 6 **Aspect** button (selects the image aspect ratio)
- 7 **Num** button (when held down, switches numeric buttons to number function)
- 8 **Menu** button (accesses projector menu system)
- 9 Arrow buttons (move through on-screen options and control wireless mouse functions)
- 10 Enter button (selects options and controls wireless mouse functions)
- 11 **User** button (customizable for different functions)
- 12 **Page** up/down buttons (control presentation slides)
- 13 **E-Zoom +/-** buttons (zoom into and out of the image)
- 14 **A/V Mute** button (turns off picture and sound)
- 15 **Split** button (splits the screen between two image sources)
- 16 Strap attachment point
- 17 **Home** button (accesses source selection, projector help information, and other features)
- 18 **Freeze** button (stops video action)
- 19 **Volume** up/down buttons (adjust speaker volume)
- 20 **Pointer** button (activates on-screen pointer)
- 21 **Esc** button (cancels/exits functions and controls wireless mouse functions)
- 22 **Pen Mode** button (switches between annotation and computer interactive modes)
- 23 **Color Mode** button (selects display modes)
- 24 **ID** button (selects which projector you want to control)
- 25 **Link Menu** button (displays the main menu of the connected HDMI device)
- 26 **LAN** button
- 27 **USB** button (cycles through connected USB sources)

28 **Source Search** button (searches for connected sources)

Parent topic: [Projector Part Locations](#)

## Projector Parts - Touch Unit

The Touch Unit comes with the BrightLink 695Wi projector only.

### Front (Cover On)

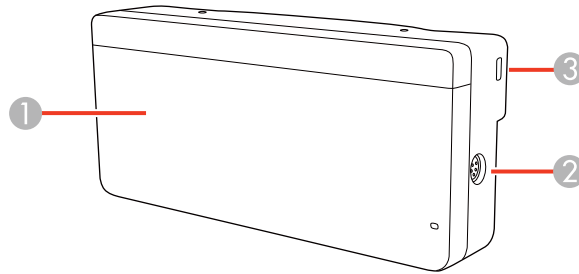

### Front (Cover Off)

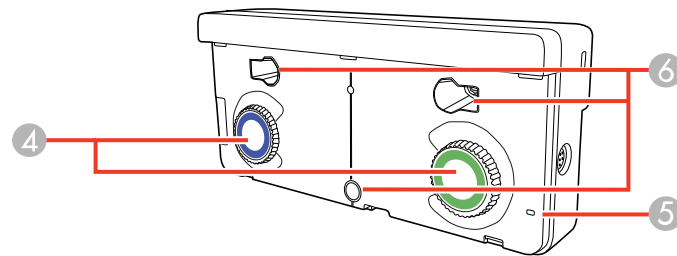

- 1 Dial cover
- 2 Touch unit (TCH) port
- 3 Security slot
- 4 Adjustment dials
- 5 Power light

## 6 Mounting holes

### Rear

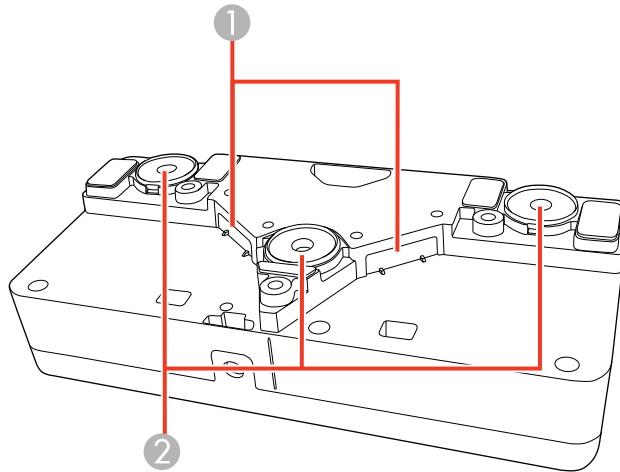

- 1 Laser diffusion ports
- 2 Installation magnets

Parent topic: [Projector Part Locations](#)

---

# Setting Up the Projector

Follow the instructions in these sections to set up your projector for use.

[Projector Placement](#)

[Removing and Attaching the Cable Cover](#)

[Projector Connections](#)

[Installing Batteries in the Remote Control](#)

[Installing Batteries in the Pens](#)

## Projector Placement

Your ultra-short throw projector is designed to be installed on a wall (with a wall mount) or vertically on a table (with a table mount) to create an interactive tabletop workspace.

You can also place the projector on a flat surface such as a desk or table to project in a portable setup.

**Note:** Finger touch (BrightLink 695Wi) is only available if the projector is installed on a wall (with a wall mount) or vertically on a table (with a table mount).

Keep these considerations in mind as you select a projector location:

- Follow the instructions in the *Installation Guide* provided with your mounting hardware to install the projector using the included mounting equipment.
- Leave plenty of space around and under the projector for ventilation, and do not place it on top of or next to anything that could block the vents.
- Position the projector within reach of a grounded electrical outlet or extension cord.
- If installing vertically on a desk or table, the table projection mount (V12H516020) is required.
- If installing on a wall, the wall mount (V12H777020) is required.
- If the projector is not mounted, place it on a sturdy, level surface.
- For finger touch (BrightLink 695Wi), make sure the projection surface is flat, smooth, and unwarped with no more than 0.2 inch (5 mm) of unevenness in any direction.

[Projector Setup and Installation Options](#)

[Projection Distance](#)

**Parent topic:** [Setting Up the Projector](#)



## Projector Setup and Installation Options

You can set up or install your projector in the following ways:

Mounted on the wall or ceiling

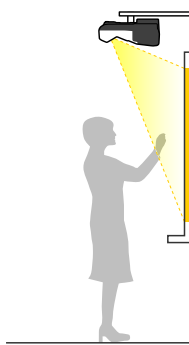

Mounted vertically on a table to create an interactive workspace

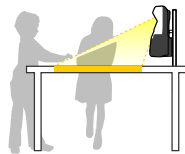

Front projection from a table or portable cart (BrightLink 685Wi)

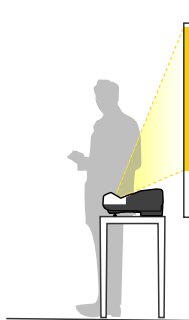

Wherever you set up the projector, make sure to position it squarely in front of the screen, not at an angle.

If you project from a table or portable cart, be sure to select the correct **Projection** option in the projector's menu system.

**Parent topic:** [Projector Placement](#)

**Related references**

[Projector Setup Settings - Extended Menu](#)

## Projection Distance

The distance at which you place the projector from the screen determines the approximate size of the image. The image size increases the farther the projector is from the screen, but can vary depending on the zoom factor, aspect ratio, and other settings.

Refer to the tables in the *Installation Guide* included with your mount to determine approximately how far to place the projector from the screen based on the size of the projected image. (Conversion figures may have been rounded up or down.) You can also use the projector Throw Distance Calculator at [epson.com/support](http://epson.com/support) (U.S.) or [epson.ca/support](http://epson.ca/support) (Canada).

**Parent topic:** [Projector Placement](#)

## Removing and Attaching the Cable Cover

Before you can connect equipment to your projector, you need to remove the cable cover.

1. Use a screwdriver to remove both of the cable cover screws.
2. Slide off the cable cover.

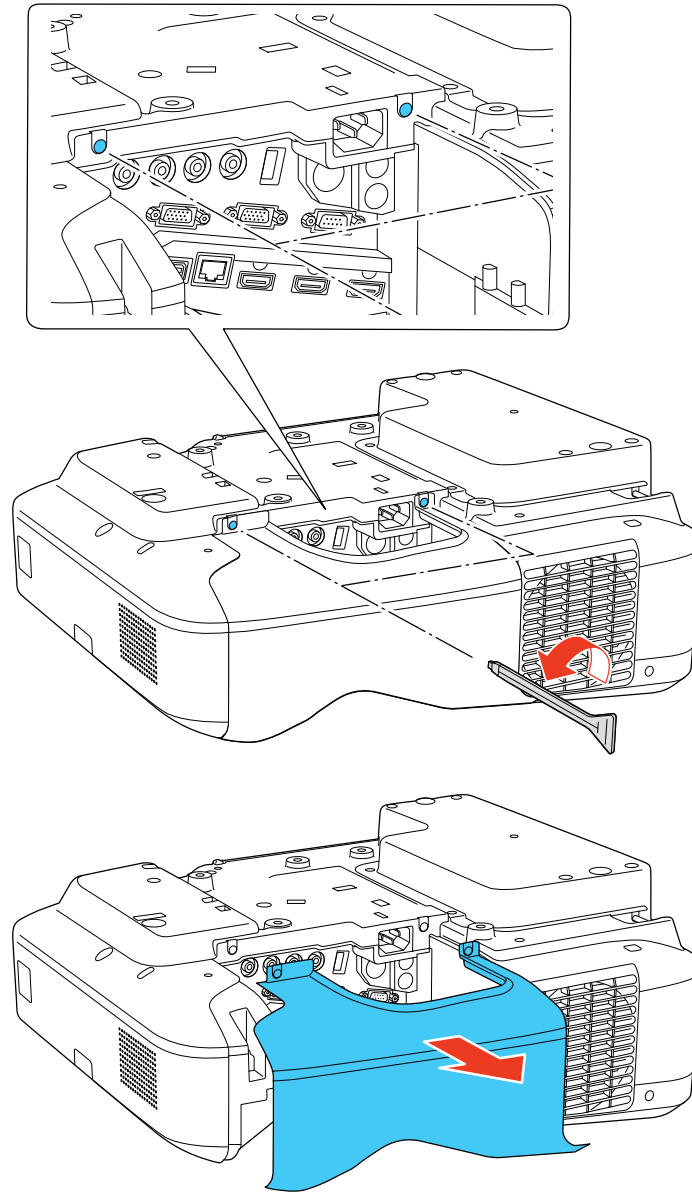

To attach the cable cover, slide it into position and tighten the screws with a screwdriver.

**Parent topic:** [Setting Up the Projector](#)

## Projector Connections

See these sections to connect the projector to a variety of projection sources.

**Caution:** If you will use the projector at altitudes above 4921 feet (1500 m), turn on **High Altitude Mode** to ensure the projector's internal temperature is regulated properly.

[Connecting to Computer Sources](#)

[Connecting to Video Sources](#)

[Connecting to an External Computer Monitor](#)

[Connecting to External Speakers](#)

[Connecting a Microphone](#)

[Connecting to External USB Devices](#)

[Connecting to a Document Camera](#)

[Connecting Multiple Projectors of the Same Model](#)

**Parent topic:** [Setting Up the Projector](#)

### Related references

[Projector Setup Settings - Extended Menu](#)

[Product Box Contents](#)

## Connecting to Computer Sources

Follow the instructions in these sections to connect a computer to the projector.

[Connecting to a Computer for USB Video and Audio](#)

[Connecting to a Computer for VGA Video](#)

[Connecting to a Computer for HDMI Video and Audio](#)

[Connecting to a Computer for USB Mouse Control](#)

[Connecting to a Computer for Sound](#)

**Parent topic:** [Projector Connections](#)

## Connecting to a Computer for USB Video and Audio

If your computer meets the system requirements, you can send video and audio output to the projector through the computer's USB port (preferably USB 2.0). Connect the projector to your computer using a USB cable.

**Note:** This also lets you use the interactive pens with your computer. You need to change the **USB Type B** setting in the projector's Extended menu before you can project through the USB port. Note that using USB Display will slow interactive pen function. For the best performance, VGA or HDMI connections are recommended.

**Note:** A USB connection may cause a delay for content requiring high bandwidth, such as movies. An HDMI connection is recommended for projecting movies, video games, and other home entertainment content.

1. Turn on your computer.
2. Connect the cable to your projector's **USB-B** port.

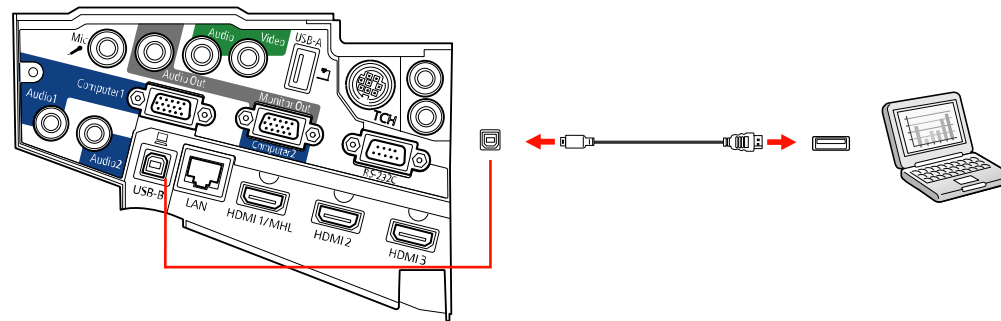

3. Connect the other end to any available USB port on your computer.
4. To use USB Display, do one of the following:
  - **Windows 10/8.x:** Click **EPSON\_PJ\_UD** in the upper right-corner, then select **Run EMP\_UDSE.exe** in the dialog box that appears to install the Epson USB Display software.
  - **Windows 7/Windows Vista:** Select **Run EMP\_UDSE.exe** in the dialog box that appears to install the Epson USB Display software.

- **Mac:** The USB Display setup folder appears on your screen. Select **USB Display Installer** and follow the on-screen instructions to install the Epson USB Display software.

Follow any on-screen instructions. You need to install this software only the first time you connect the projector to the computer.

The projector displays the image from your computer's desktop and outputs sound, if your presentation contains audio.

**Parent topic:** [Connecting to Computer Sources](#)

### Connecting to a Computer for VGA Video

You can connect the projector to your computer using a VGA computer cable.

**Note:** To connect a Mac that includes only a Mini DisplayPort, Thunderbolt port, or Mini-DVI port for video output, you need to obtain an adapter that allows you to connect to the projector's VGA video port. Contact Apple for compatible adapter options.

1. If necessary, disconnect your computer's monitor cable.
2. Connect the VGA computer cable to your computer's monitor port.
3. Connect the other end to a **Computer** port on the projector.

**Note:** If you choose the **Computer2** port, you may need to change the **Monitor Out Port** setting in the projector's Extended menu.

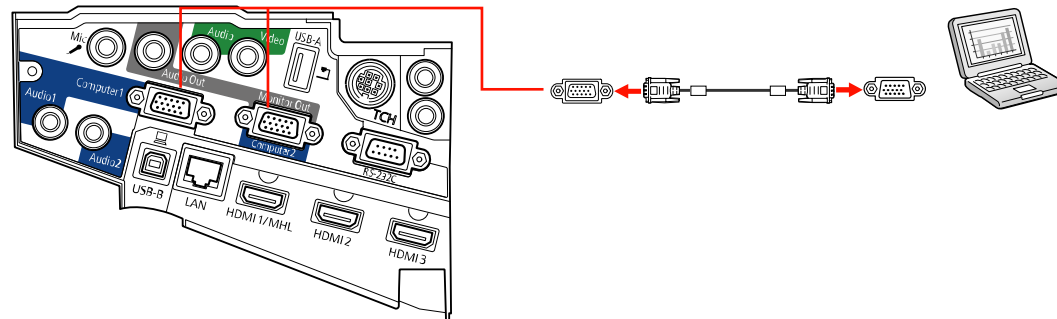

4. Tighten the screws on the VGA connector.

**Parent topic:** [Connecting to Computer Sources](#)

## Connecting to a Computer for HDMI Video and Audio

If your computer has an HDMI port, you can connect it to the projector using an optional HDMI cable.

**Note:** To connect a Mac that includes only a Mini DisplayPort, Thunderbolt port, or Mini-DVI port for video output, you need to obtain an adapter that allows you to connect to the projector's **HDMI** port. Contact Apple for compatible adapter options. Older Mac computers (2009 and earlier) may not support audio through the **HDMI** port.

1. Connect the HDMI cable to your computer's HDMI output port.
2. Connect the other end to one of the projector's HDMI ports.

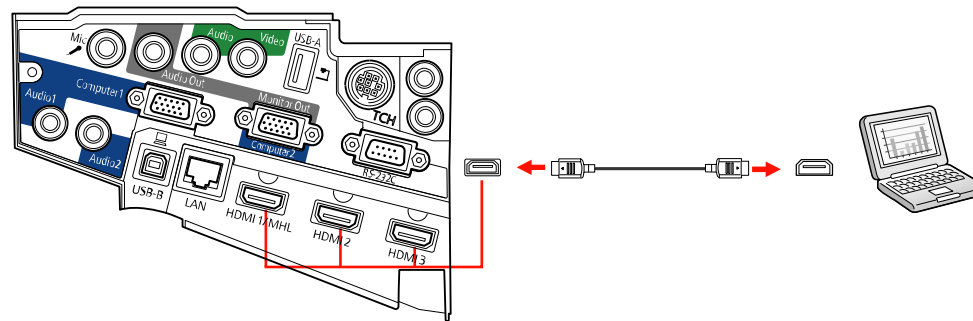

**Note:** The projector converts the digital audio signal sent from your computer into a mono analog signal for the internal speaker or a stereo analog signal if you are connecting to external speakers.

**Parent topic:** [Connecting to Computer Sources](#)

## Connecting to a Computer for USB Mouse Control

If you connected your computer to a **Computer**, **USB-B**, or **HDMI** port on the projector, you can set up the remote control to act as a wireless mouse. This lets you control projection at a distance from your computer. To do this, connect the projector to your computer using a USB cable, if it is not connected already.

1. Set the **USB Type B** setting to **Wireless Mouse/USB Display** in the Extended menu.

2. Connect the USB cable to your projector's **USB-B** port.

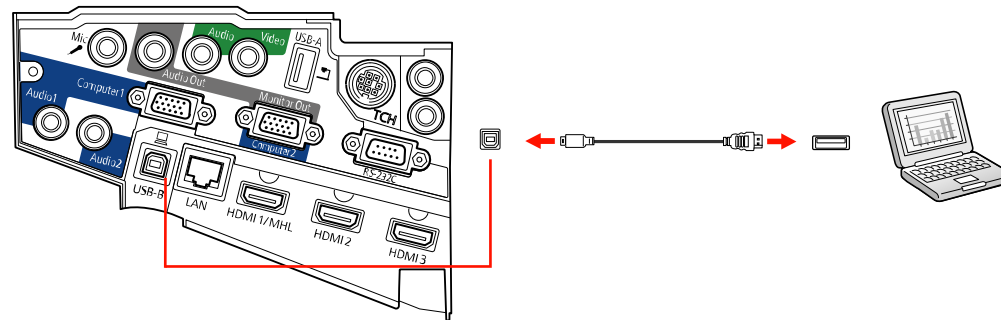

3. Connect the other end to any available USB port on your computer.
4. If necessary, configure your computer to work with an external USB mouse. See your computer documentation for details.

**Parent topic:** [Connecting to Computer Sources](#)

#### **Related references**

[Projector Setup Settings - Extended Menu](#)

[Projector Parts - Remote Control](#)

#### **Related tasks**

[Using the Remote Control as a Wireless Mouse](#)

### **Connecting to a Computer for Sound**

If your computer presentation includes sound and you did not connect it to the projector's **USB-B** or **HDMI** port, you can still play sound through the projector's speaker system. Just connect an optional 3.5 mm stereo mini-jack audio cable as described here.

1. Connect the audio cable to your laptop's headphone or audio-out jack, or your desktop's speaker or audio-out port.



2. Connect the other end to the **Audio** port that corresponds to the **Computer** port you are using.

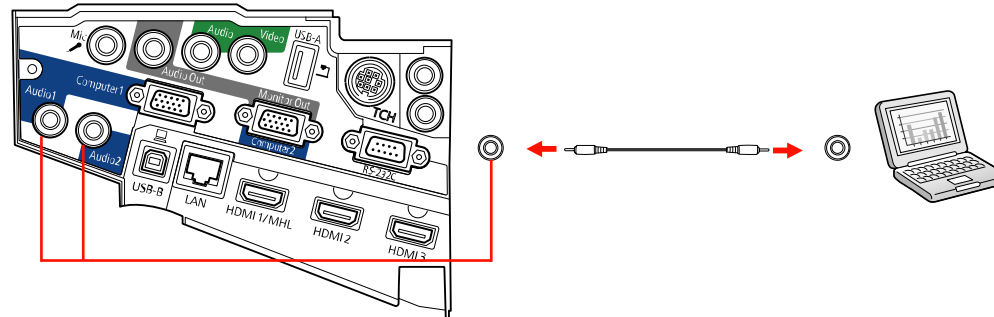

**Parent topic:** [Connecting to Computer Sources](#)

## Connecting to Video Sources

Follow the instructions in these sections to connect video devices to the projector.

[Connecting to an HDMI Video Source](#)

[Connecting to an MHL-Compatible Device](#)

[Connecting to a Component Video Source](#)

[Connecting to a Composite Video Source](#)

[Connecting to a Video Source for Sound](#)

**Parent topic:** [Projector Connections](#)

## Connecting to an HDMI Video Source

If your video source has an HDMI port, you can connect it to the projector using an optional HDMI cable. The HDMI connection provides the best image quality.

1. Connect the HDMI cable to your video source's HDMI output port.

2. Connect the other end to one of the projector's HDMI ports.

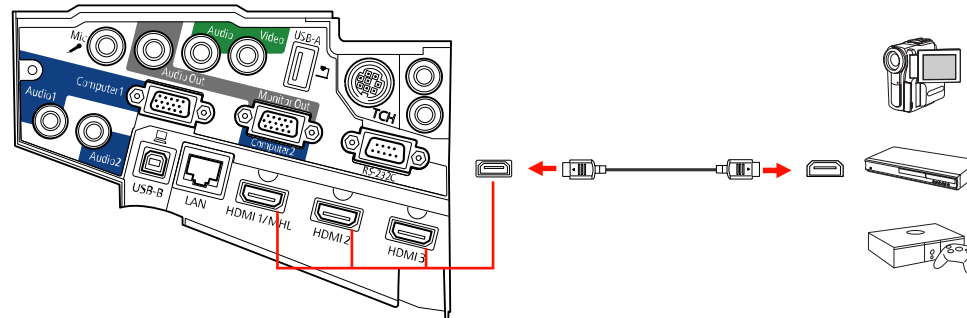

**Note:** The projector converts the digital audio signal sent from your video source into a mono analog signal for the internal speaker or a stereo analog signal if you are connecting to external speakers.

**Parent topic:** [Connecting to Video Sources](#)

### Connecting to an MHL-Compatible Device

If you have an MHL-compatible smartphone or tablet, you can connect it to the projector using either an MHL cable or an HDMI cable with a device-compatible MHL adapter. If you have a device with a built-in MHL connector, plug it directly into the **HDMI 1/MHL** port.

**Note:** Some connected devices may not charge when using an MHL adapter.

1. Connect the MHL cable or adapter to your device's Micro-USB port.
2. If you are using an MHL adapter, connect it to an MHL-compatible HDMI cable.

3. Connect the other end of the cable to the projector's **HDMI 1/MHL** port.

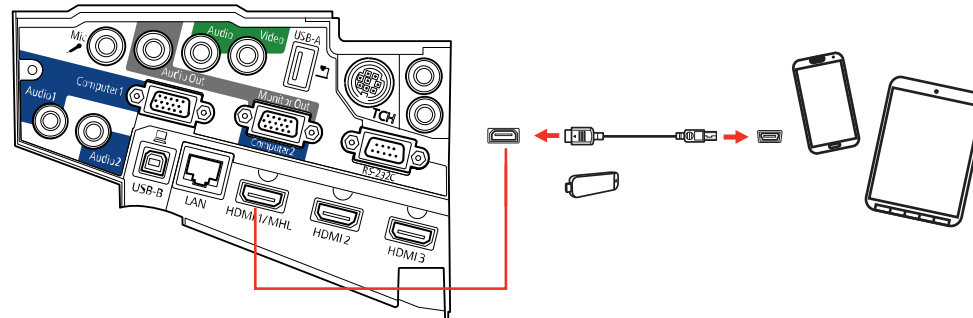

**Note:** The projector converts the digital audio signal sent from your video source into a mono analog signal for the internal speaker or a stereo analog signal if you are connecting to external speakers.

**Parent topic:** [Connecting to Video Sources](#)

### Connecting to a Component Video Source

If your video source has component video ports, you can connect it to the projector using an optional component-to-VGA video cable. Depending on your component ports, you may need to use an adapter cable along with a component video cable.

1. Connect the component connectors to your video source's color-coded component video output ports, usually labeled **Y**, **Pb**, **Pr** or **Y**, **Cb**, **Cr**. If you are using an adapter, connect these connectors to your component video cable.
2. Connect the VGA connector to a **Computer** port on the projector.

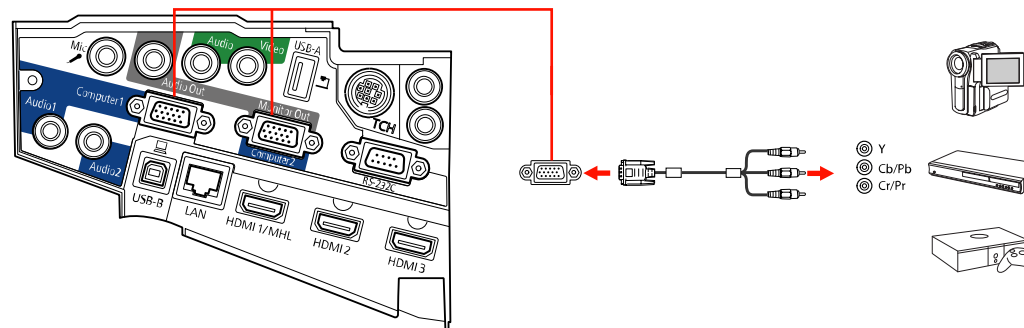

**Note:** If you choose the **Computer2** port, you may need to change the **Monitor Out Port** setting in the projector's Extended menu.

3. Tighten the screws on the VGA connector.

If your image colors appear incorrect, you may need to change the **Input Signal** setting in the projector's Signal menu.

**Parent topic:** [Connecting to Video Sources](#)

**Related references**

[Input Signal Settings - Signal Menu](#)

### Connecting to a Composite Video Source

If your video source has a composite video port, you can connect it to the projector using an optional RCA-style video or A/V cable.

1. Connect the cable with the yellow connector to your video source's yellow video output port.
2. Connect the other end to the projector's **Video** port.

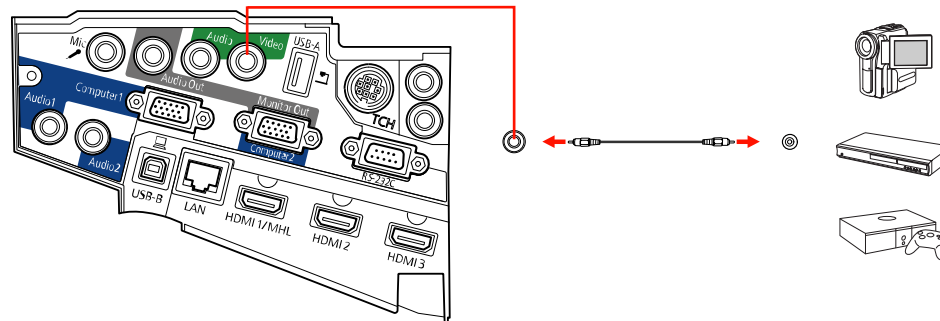

**Parent topic:** [Connecting to Video Sources](#)

### Connecting to a Video Source for Sound

You can play sound through the projector's speaker system if your video source has audio output ports. If you are projecting video using the **Video** or a **Computer** port, connect the projector to the video source using an optional stereo mini-jack audio cable.

**Note:** If you connected your video source to the projector using an HDMI cable, the audio signal is transferred with the video signal; you do not need an additional cable for sound.

1. Connect the audio cable to your video source's audio-out ports.
2. Connect the other end of the cable to the projector's **Audio** port that corresponds to the port you are using for video.

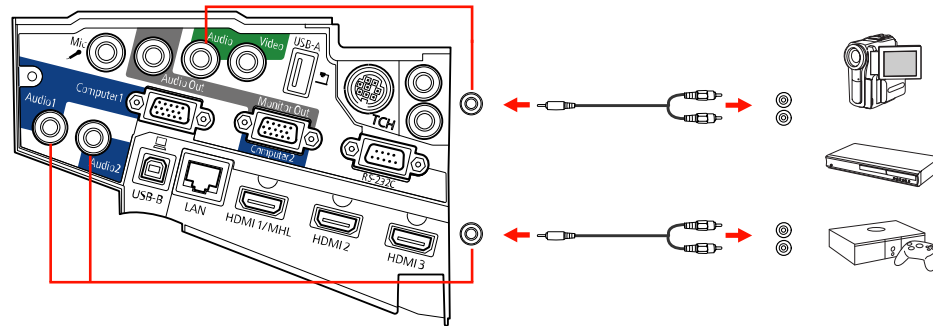

Parent topic: [Connecting to Video Sources](#)

## Connecting to an External Computer Monitor

If you connected a computer to the projector's **Computer** port, you can also connect an external monitor to the projector. This lets you see your presentation on the external monitor even when the projected image is not visible.

If you want to output images to an external monitor when the projector is turned off, you need to select **Communication On** as the **Standby Mode** setting and **Always On** as the **A/V Output** setting in the projector's menu system.

**Note:** Monitors that use a refresh rate less than 60 Hz may not be able to display images correctly.

1. Make sure your computer is connected to the projector's **Computer** port. If there are two computer ports, make sure you use the **Computer1** port.

2. Connect the external monitor's cable to your projector's **Monitor Out/Computer 2** port.

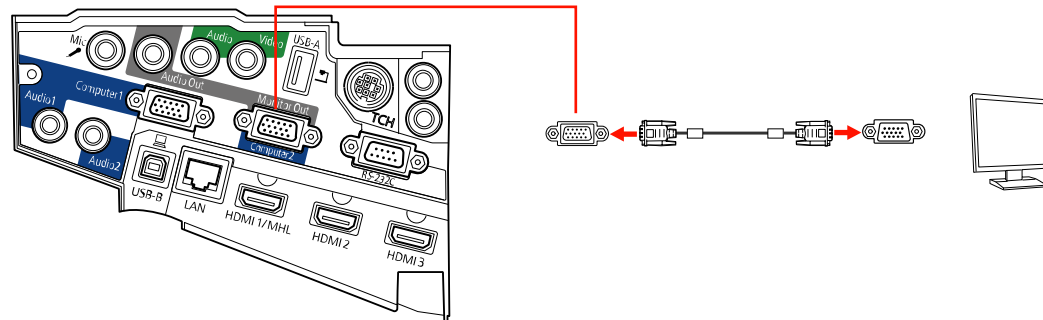

**Note:** You may need to change the **Monitor Out Port** setting in the projector's Extended menu and restart the computer.

**Note:** Content you draw using the interactive features is not displayed on an external monitor unless you draw it using Easy Interactive Tools.

Parent topic: [Projector Connections](#)

## Connecting to External Speakers

To enhance the sound from your presentation, you can connect the projector to external self-powered speakers. You can control the volume using the projector's remote control.

You can also connect the projector to an amplifier with speakers.

If you want to output audio from the external speakers when the projector is turned off, you need to select **Communication On** for the **Standby Mode** setting and **Always On** for the **A/V Output** setting in the projector's menu system.

**Note:** The projector's built-in speaker system is disabled when you connect external speakers.

1. Make sure your computer or video source is connected to the projector with both audio and video cables as necessary.
2. Locate the appropriate cable to connect your external speakers, such as a stereo mini-jack-to-pin-jack cable, or another type of cable or adapter.

3. Connect one end of the cable to your external speakers as necessary.
4. Connect the stereo mini-jack end of the cable to your projector's **Audio Out** port.

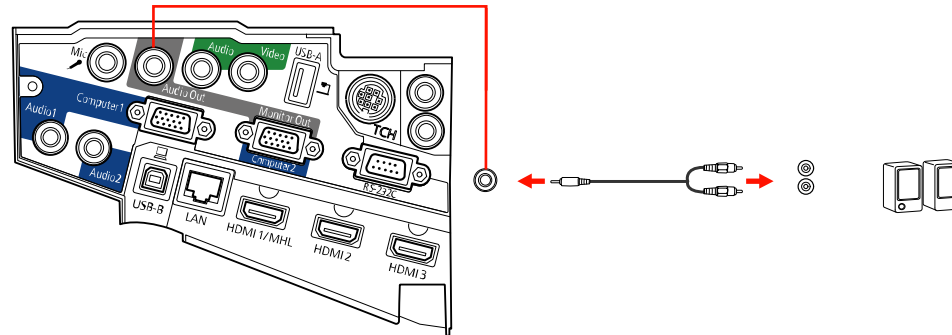

**Parent topic:** [Projector Connections](#)

**Related references**

[Projector Setup Settings - Extended Menu](#)

## Connecting a Microphone

You can connect a microphone to the projector's **Mic** port to provide audio support during presentations .

**Note:** If you want to output audio from the microphone when the projector is turned off, you need to select **Communication On** for the **Standby Mode** setting and **Always On** for the **A/V Output** setting in the projector's menu system. Plug-in power is not supported.

1. Connect the microphone cable to the projector's **Mic** port.

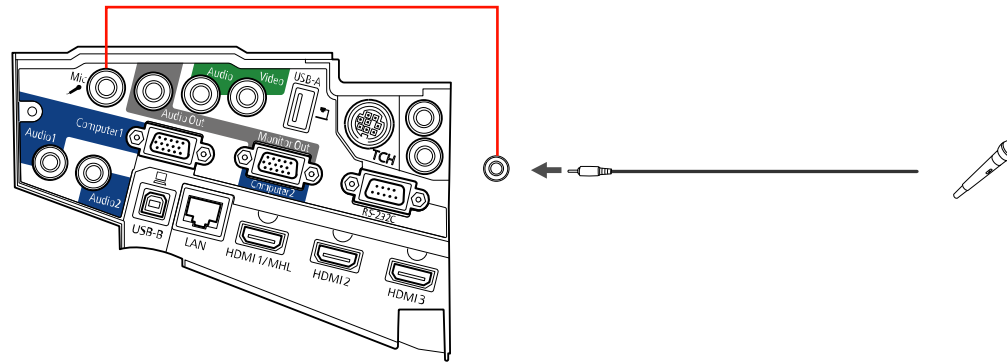

2. Turn on the microphone, if necessary.
3. If you hear a crackling noise or the volume is too high or low, adjust the **Mic Input Level** setting in the Settings menu.

**Parent topic:** [Projector Connections](#)

**Related references**

[Projector Setup Settings - Extended Menu](#)

## Connecting to External USB Devices

Follow the instructions in these sections to connect external USB devices to the projector.

[USB Device Projection](#)

[Connecting a USB Device or Camera to the Projector](#)

[Selecting the Connected USB Source](#)

[Disconnecting a USB Device or Camera From the Projector](#)

**Parent topic:** [Projector Connections](#)

### USB Device Projection

You can project images and other content without using a computer or video device by connecting any of these devices to your projector:

- USB flash drive
- Digital camera or smartphone



- USB hard drive
- Multimedia storage viewer

**Note:** Digital cameras or smartphones must be USB-mounted devices, not TWAIN-compliant devices, and must be USB Mass Storage Class-compliant.

**Note:** USB hard drives must meet these requirements:

- USB Mass Storage Class-compliant (not all USB Mass Storage Class devices are supported)
- Formatted in FAT or FAT32
- Self-powered by their own AC power supplies (bus-powered hard drives are not recommended)
- Does not have multiple partitions

You can project slide shows from image files on a connected USB device.

**Parent topic:** [Connecting to External USB Devices](#)

**Related topics**

[Projecting a PC Free Presentation](#)

## Connecting a USB Device or Camera to the Projector

You can connect your USB device or camera to the projector's **USB-A** port and use it to project images and other content.

1. If your USB device came with a power adapter, plug the device into an electrical outlet.
2. Connect the USB cable (or USB flash drive or USB memory card reader) to the projector's **USB-A** port.

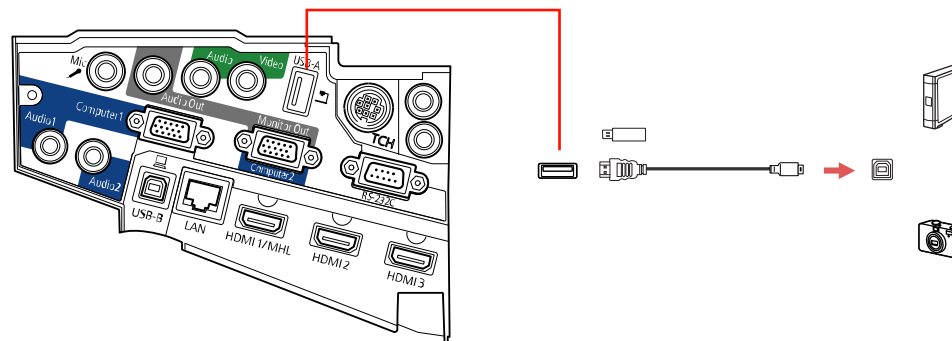

**Note:** Do not connect a USB hub or a USB cable longer than 10 feet (3 m), or the device may not operate correctly.

3. Connect the other end of the cable (if applicable) to your device.

**Parent topic:** [Connecting to External USB Devices](#)

**Related topics**

[Projecting a PC Free Presentation](#)

### Selecting the Connected USB Source

You can switch the projector's display to the source you connected to the **USB-A** port.

1. Make sure the connected USB source is turned on, if necessary.
2. Press the **USB** button on the remote control.
3. Press the button again to cycle through other USB sources, if available.

**Parent topic:** [Connecting to External USB Devices](#)

### Disconnecting a USB Device or Camera From the Projector

When you finish presenting with a connected USB device or camera, you must prepare to disconnect the device from the projector.

1. If the device has a power button, turn off and unplug the device.
2. Disconnect the USB device or camera from the projector.

**Parent topic:** [Connecting to External USB Devices](#)

## Connecting to a Document Camera

You can connect a document camera to your projector to project images viewed by the camera.

Depending on your Epson document camera model, do one of the following to connect the document camera to your projector:

- For the Epson DC-07 document camera, locate the USB cable that came with the camera and connect it to the projector's **USB-A** port and to the document camera's USB Type B port.
- For the Epson DC-13 document camera, connect it to the projector's **HDMI**, **Computer**, or **Video** port and to the corresponding port on the document camera. See the document camera manual for details.

- For the Epson DC-21 document camera, connect it to the projector's **HDMI**, **Computer**, or **Video** port and to the corresponding port on the document camera. See the document camera manual for details.

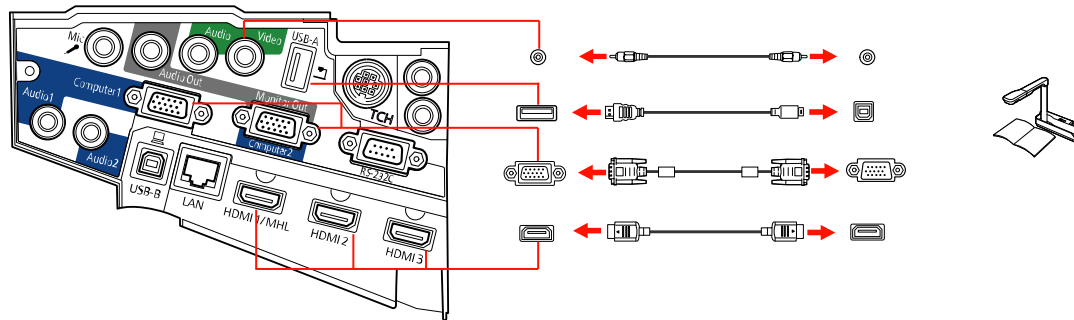

**Note:** For additional features supported by software, connect your document camera to your computer instead of the projector. See the document camera manual for details.

**Parent topic:** [Projector Connections](#)

**Related references**

[Optional Equipment and Replacement Parts](#)

## Connecting Multiple Projectors of the Same Model

If you use the interactive features of multiple projectors of the same model in the same room, you need to synchronize the projectors. To do this, connect the optional remote control cable set (V12H005C28) or a stereo mini cable to the **SYNC** port on each projector.

1. Connect one end of the cable to the **SYNC In** port on one projector, and connect the other end to the **SYNC Out** port on the other projector.

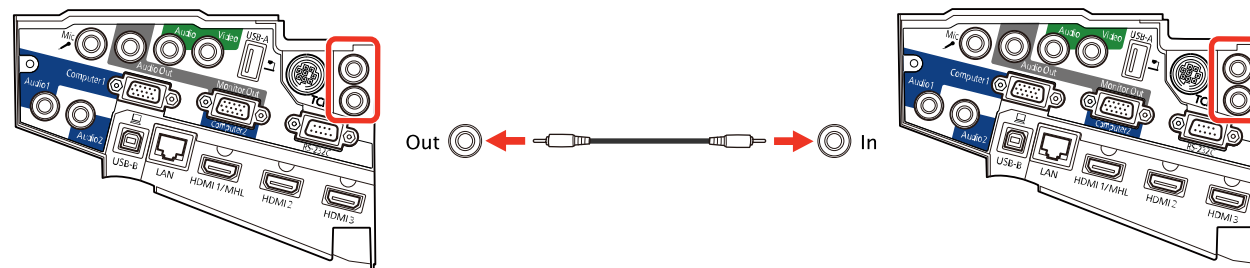

**Note:** If you are connecting three or more projectors, connect the projectors in a chain as shown.

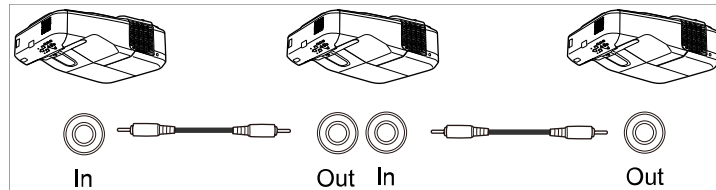

2. In the Extended menu, set the **Sync of Projectors** setting to **Wired**.

**Note:** If you are using the projector in the same room as another projector that does not support cable connection or if you do not have the optional remote control cable or a stereo mini cable, set the **Wired Sync Mode** setting to **Mode 2** in the projector's Extended menu.

**Note:** If you do not have the optional remote control cable set, change the **Distance of Projectors** setting in the projector's Extended menu.

Parent topic: [Projector Connections](#)

## Installing Batteries in the Remote Control

The remote control uses the two AA batteries that came with the projector.

**Caution:** Use only the type of batteries specified in this manual. Do not install batteries of different types, or mix new and old batteries.

1. Remove the battery cover.

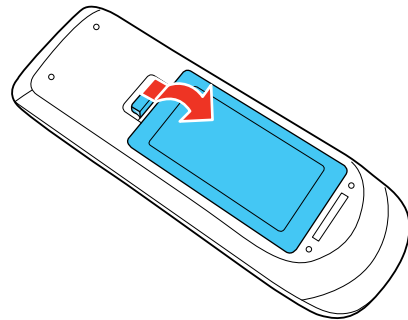

2. Insert the batteries with the + and – ends facing as shown.

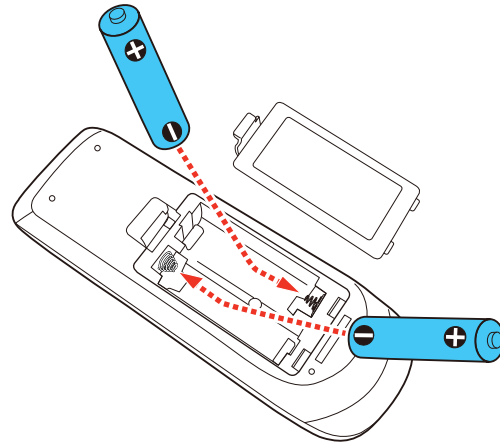

3. Replace the battery cover and press it down until it clicks into place.

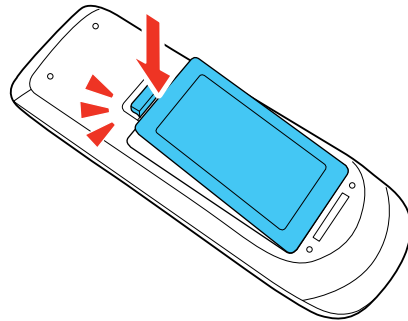

**Warning:** Dispose of used batteries according to local regulations. Do not expose batteries to heat or flame. Keep batteries out of the reach of children; they are choking hazards and are very dangerous if swallowed.

Parent topic: [Setting Up the Projector](#)

## Installing Batteries in the Pens

Each pen uses one AA battery.

1. Open the battery cover as shown.

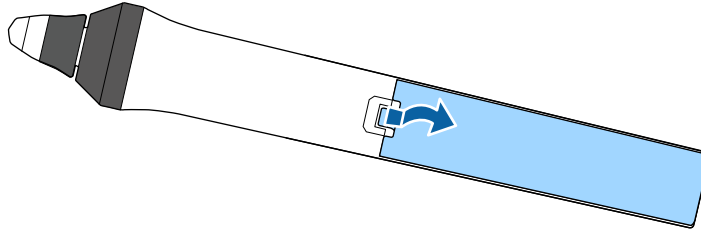

2. Insert the battery with the + and - ends facing as shown.

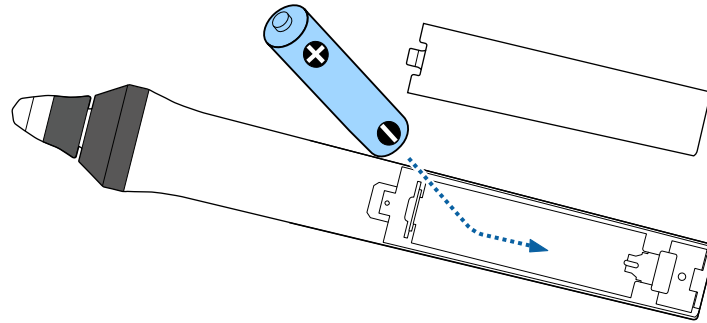

3. Replace the battery cover and press it down until it clicks into place.

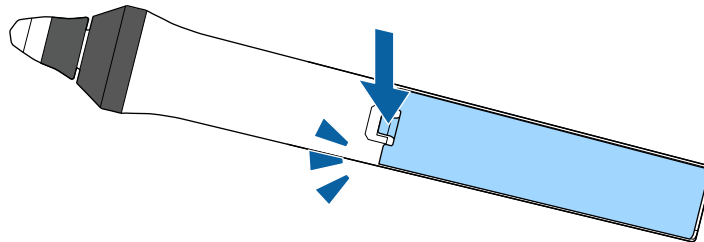

**Warning:** Dispose of used batteries according to local regulations. Do not expose batteries to heat or flame. Keep batteries out of the reach of children; they are choking hazards and are very dangerous if swallowed.

**Parent topic:** [Setting Up the Projector](#)

---

# Using the Projector on a Network

Follow the instructions in these sections to set up your projector for use on a network.

**Note:** The interactive features may be slower over a network connection than over a USB connection.

[Wired Network Projection](#)

[Wireless Network Projection](#)

[Setting Up Projector Network E-Mail Alerts](#)

[Setting Up Monitoring Using SNMP](#)

[Controlling a Networked Projector Using a Web Browser](#)

[Crestron RoomView Support](#)

## Wired Network Projection

You can project through a wired network. To do this, you connect the projector to your network, and then set up your projector and computer for network projection.

After connecting and setting up the projector as described here, install the network software from the included CD or download the software and manuals as necessary.

**Note:** If your projector is connected via a LAN cable to a network that includes a wireless access point, you can connect to the projector wirelessly through the access point using the Epson network software.

[Connecting to a Wired Network](#)

[Selecting Wired Network Settings](#)

**Parent topic:** [Using the Projector on a Network](#)

### Related references

[Additional Projector Software and Manuals](#)

[Projector Network Settings - Network Menu](#)

## Connecting to a Wired Network

To connect the projector to a wired local area network (LAN), use a 100Base-TX or 10Base-T network cable. To ensure proper data transmission, use a Category 5 shielded cable or better.

1. Connect one end of the network cable to your network hub, switch, or router.



2. Connect the other end of the cable to the projector's **LAN** port.

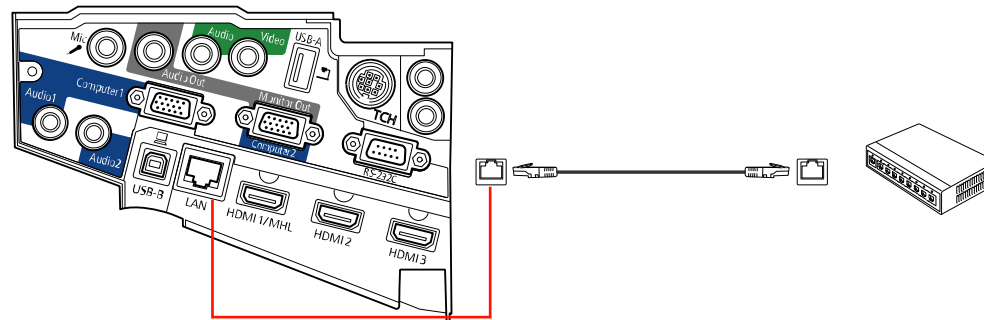

Parent topic: [Wired Network Projection](#)

## Selecting Wired Network Settings

Before you can project from computers on your network, you must select the network settings for the projector using its menu system.

**Note:** Make sure you already connected the projector to your wired network using the **LAN** port.

1. Turn on the projector.
2. Press the **Menu** button.

3. Select the **Network** menu and press **Enter**.

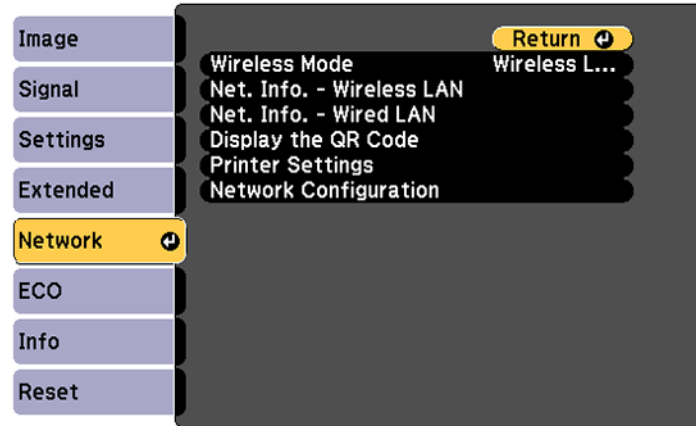

4. Select **Network Configuration** and press **Enter**.
5. Select the **Basic** menu and press **Enter**.

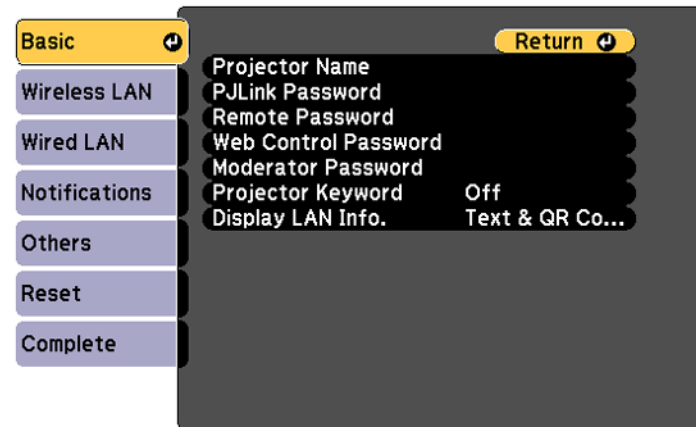

6. Select the following basic options as necessary:
  - **Projector Name** lets you enter a name up to 16 alphanumeric characters long to identify the projector over the network.

- **PJLink Password** lets you enter a password up to 32 alphanumeric characters long for using the PJLink protocol for projector control.
- **Remote Password** lets you enter a password up to 8 alphanumeric characters long for accessing the Remote or Basic Control screen in Epson Web Control. (Default user name is **EPSONREMOTE**; default password is **guest**.)
- **Web Control Password** lets you enter a password up to 8 alphanumeric characters long for accessing the projector over the web. (Default user name is **EPSONWEB**; default password is **admin**.)
- **Moderator Password** lets you enter a password up to 4 numbers long for accessing the projector as a moderator using EasyMP Multi PC Projection or the Epson iProjection app.
- **Projector Keyword** lets you turn on a security password to prevent access to the projector by anyone not in the room with it. You must enter a displayed, randomized keyword from a computer using the EasyMP Multi PC Projection software to access the projector.
- **Display LAN Info** lets you select how the projector displays network information. You can select an option to display a QR code that lets you quickly connect your iOS or Android devices using the Epson iProjection app.

**Note:** Use the displayed keyboard to enter the name, passwords, and keyword. Press the arrow buttons on the remote control to highlight characters and press **Enter** to select them.

7. Select the **Wired LAN** menu and press **Enter**.

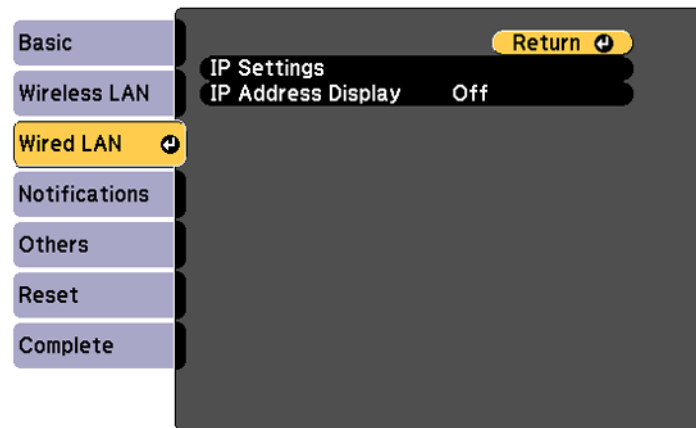

8. If necessary, select **IP Settings** and press **Enter**.
9. Select your IP Settings as necessary:
  - If your network assigns addresses automatically, turn on the **DHCP** setting.
  - If you must set addresses manually, turn off **DHCP** and enter the projector's **IP Address**, **Subnet Mask**, and **Gateway Address** as needed.

**Note:** To highlight the numbers you want from the displayed keyboard, press the arrow buttons on the remote control. To select a highlighted number, press **Enter**. Or, press and hold the **Num** button on the remote control while entering the desired numbers.

10. To prevent display of the IP address on the standby screen, turn off **IP Address Display**.
11. When you finish selecting settings, select **Complete** and follow the on-screen instructions to save your settings and exit the menus.

**Parent topic:** [Wired Network Projection](#)

#### **Related references**

[Projector Network Settings - Network Menu](#)

## **Wireless Network Projection**

You can project over a wireless network. To do this, you must set up your projector and computer for wireless projection.

After setting up the projector as described here, install the network software from the included CD or download the software and manuals as necessary.

**Note:** If your projector is connected via a LAN cable to a network that includes a wireless access point, you can connect to the projector wirelessly through the access point using the Epson network software.

[Installing the Wireless LAN Module](#)

[Using Quick Wireless Connection \(Windows\)](#)

[Selecting Wireless Network Settings Manually](#)

[Selecting Wireless Network Settings in Windows](#)

[Selecting Wireless Network Settings on Mac](#)

[Setting Up Wireless Network Security](#)

[Connecting Directly to a Smartphone or Tablet](#)

**Parent topic:** [Using the Projector on a Network](#)

### **Related references**

[Projector Network Settings - Network Menu](#)

[Additional Projector Software and Manuals](#)

[Projector Network Settings - Network Menu](#)

## **Installing the Wireless LAN Module**

To use the projector over a wireless network, install the Epson 802.11b/g/n wireless module in the projector. Do not install any other type of wireless module.

**Caution:** Never remove the module while its indicator light is blue or flashing, or while you are projecting wirelessly. You may damage the module or lose data.

**Note:** The wireless LAN module is not included with your projector.

1. Turn off the projector and unplug the power cord.

2. Unscrew and remove the cable cover if it is attached (screwdriver not included).

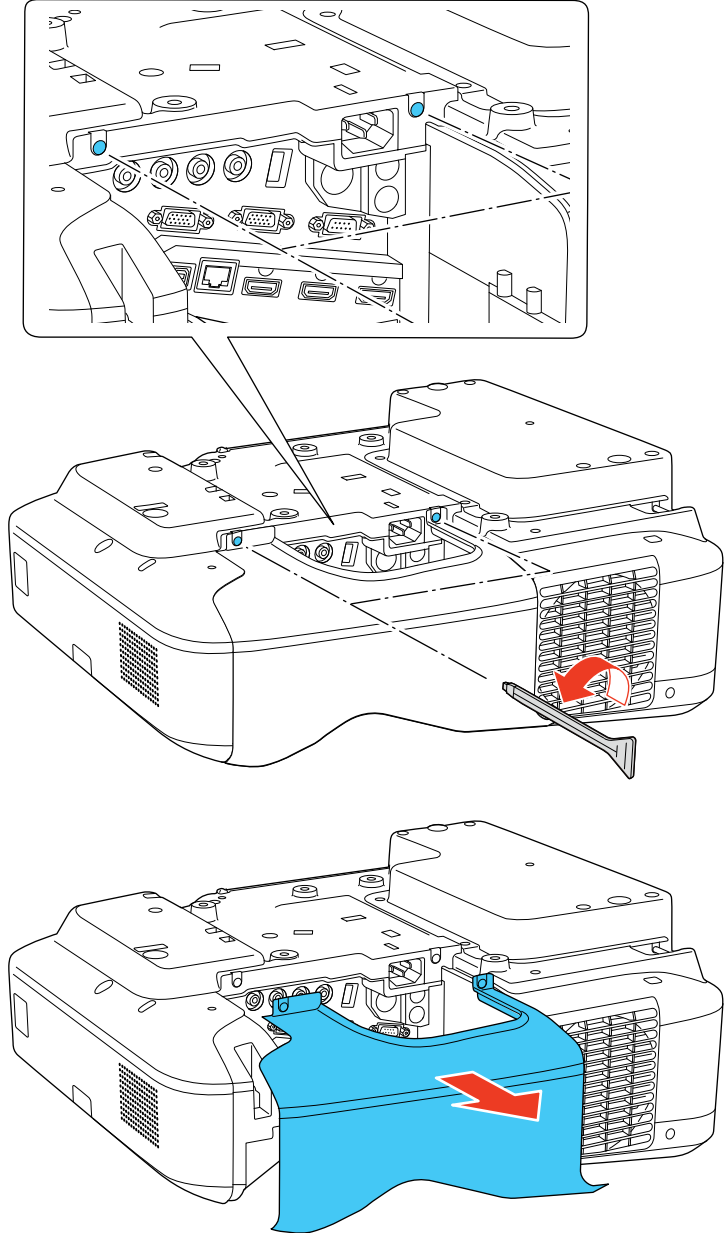

3. Insert the wireless LAN module into the port shown here.

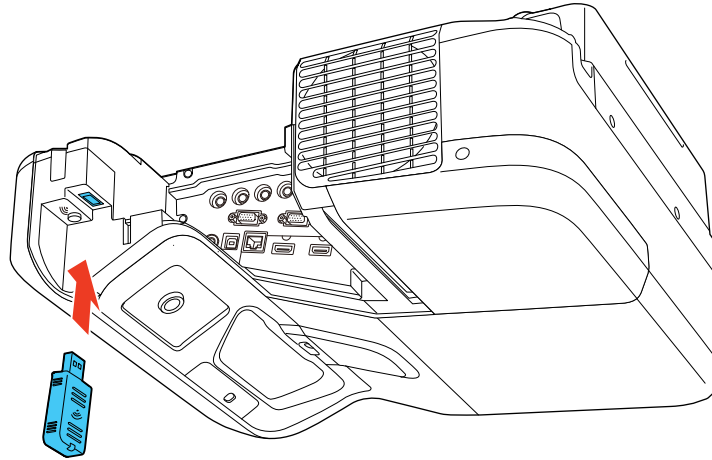

4. Replace the cable cover and tighten the screws.
5. Plug in and turn on the projector.

Parent topic: [Wireless Network Projection](#)

## Using Quick Wireless Connection (Windows)

You can create a Quick Wireless Connection USB Key to quickly connect the projector to a Windows computer wirelessly. Then you can project your presentation and remove the key when you are done.

**Note:** A USB flash drive is not included with your projector.

1. Create a Quick Wireless Connection USB Key with a USB flash drive and the EasyMP Multi PC Projection software.

**Note:** See the *EasyMP Multi PC Projection Operation Guide* for instructions.

2. Turn on the projector.

3. Insert the USB key into the projector's **USB-A** port.

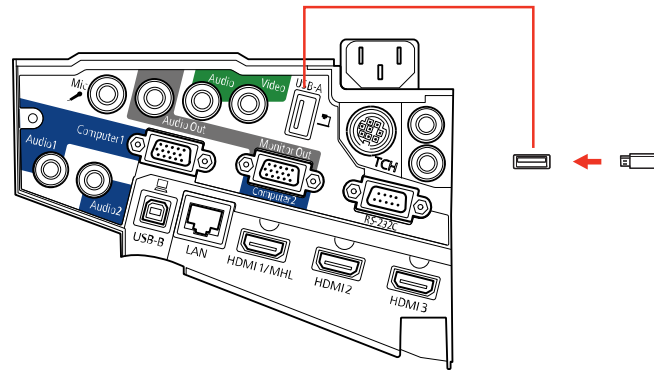

You see a projected message that the network information update is complete.

4. Remove the USB key.
5. Insert the USB key into a USB port on your computer.

**Note:** In Windows Vista, if you see the AutoPlay window, select **Run MPPLaunch.exe**, then select **Allow** on the next screen.

6. Follow the on-screen instructions to install the EasyMP Multi PC Projection software.

**Note:** If you see a Windows Firewall message, click **Yes** to disable the firewall. You need administrator authority to install the software. If it is not installed automatically, double-click **MPPLaunch.exe** in the USB key.

After a few minutes, your computer image is displayed by the projector. If it does not appear, press the **LAN** or **Source Search** button on your remote control or restart your computer.

7. Run your presentation as necessary.
8. When you finish projecting wirelessly, select the **Safely Remove Hardware** option in the Windows taskbar, then remove the USB key from your computer.

**Note:** You can share the USB key with other computers without disconnecting your computer. You may need to restart your computer to reactivate your wireless LAN connection.



Parent topic: [Wireless Network Projection](#)

## Selecting Wireless Network Settings Manually

Before you can project from your wireless network, you must select the network settings for the projector using its menu system.

1. Turn on the projector.
2. Press the **Menu** button.
3. Select the **Network** menu and press **Enter**.

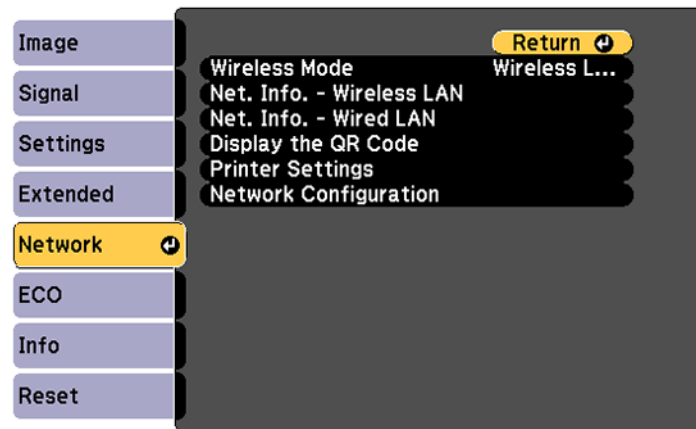

4. Make sure the **Wireless Mode** setting is set to **Wireless LAN On**.
5. Select **Network Configuration** and press **Enter**.

6. Select the **Basic** menu and press **Enter**.

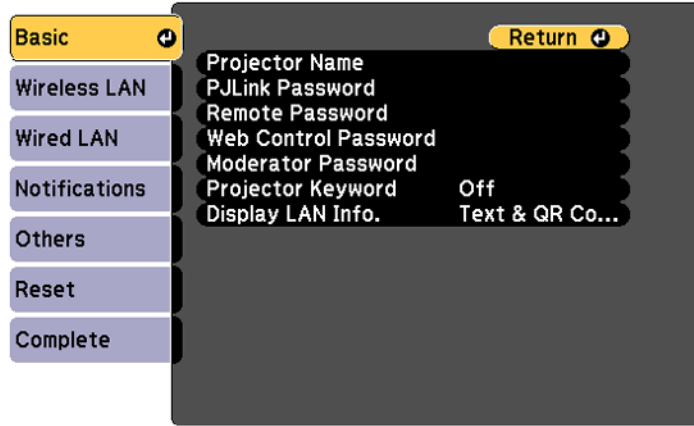

7. Select the following basic options as necessary:

- **Projector Name** lets you enter a name up to 16 alphanumeric characters long to identify the projector over the network.
- **PJLink Password** lets you enter a password up to 32 alphanumeric characters long for using the PJLink protocol for projector control.
- **Remote Password** lets you enter a password up to 8 alphanumeric characters long for accessing the Remote or Basic Control screen in the Epson Web Control. (Default user name is **EPSONREMOTE**; default password is **guest**.)
- **Web Control Password** lets you enter a password up to 8 alphanumeric characters long for accessing the projector over the web. (Default user name is **EPSONWEB**; default password is **admin**.)
- **Moderator Password** lets you enter a password up to 4 numbers long for accessing the projector as a moderator with EasyMP Multi PC Projection or the Epson iProjection app.
- **Projector Keyword** lets you turn on a security password to prevent access to the projector by anyone not in the room with it. The projector displays a random keyword that you must enter from a computer using the EasyMP Multi PC Projection software or an iOS or Android device using iProjection.

- **Display LAN Info** lets you select how the projector displays network information. You can select an option to display a QR code that lets you quickly connect your iOS or Android devices using the Epson iProjection app.

**Note:** Use the displayed keyboard to enter the name, passwords and keyword. Press the arrow buttons on the remote control to highlight characters and press **Enter** to select them.

8. Select the **Wireless LAN** menu and press **Enter**.

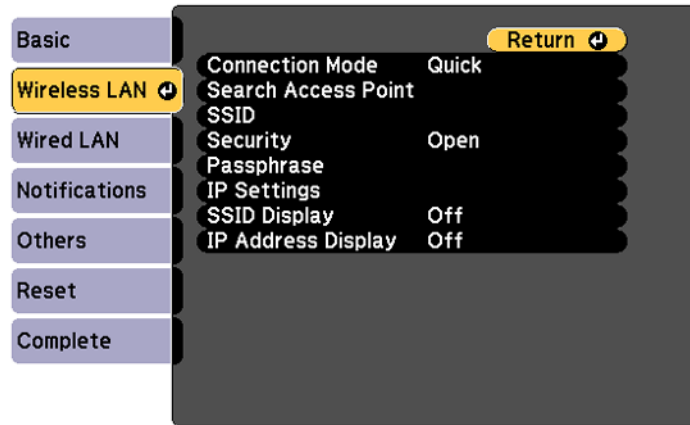

9. Select the settings on the **Wireless LAN** menu as necessary for your network.
10. When you finish selecting settings, select **Complete** and follow the on-screen instructions to save your settings and exit the menus.

After you complete the wireless settings for your projector, you need to select the wireless network on your computer, or iOS or Android device.

[Wireless LAN Menu Settings](#)

**Parent topic:** [Wireless Network Projection](#)

## Wireless LAN Menu Settings

Setting	Options	Description
<b>Connection Mode</b>	<b>Quick</b> <b>Advanced</b>	Selects the type of wireless connection: <b>Quick:</b> lets you quickly connect to multiple computers or devices directly or use a Quick Wireless Connection USB Key to connect <b>Advanced:</b> lets you connect to multiple computers or devices via a wireless network access point
<b>Search Access Point</b>	<b>To Search View</b>	Search for available wireless network access points in <b>Advanced</b> connection mode
<b>SSID</b>	Up 32 alphanumeric characters	Sets the SSID (network name) of the wireless LAN system the projector is connecting to
<b>Security</b>	<b>Open</b> <b>WPA2-PSK</b> <b>WPA/WPA2-PSK</b>	Selects the type of wireless security used in the wireless network (some options are only available when the <b>Connection Mode</b> setting is set to <b>Advanced</b> )
<b>Passphrase</b>	Between 8 to 63 alphanumeric characters	Enter a paraphrase for the wireless network
<b>IP Settings</b>	<b>DHCP (On or Off)</b> <b>IP Address</b> <b>Subnet Mask</b> <b>Gateway Address</b>	Selects DHCP if your network assigns addresses automatically, or turns off DHCP so you can enter the network's IP address, subnet mask, and gateway address as needed
<b>SSID Display</b>	<b>On</b> <b>Off</b>	Selects whether to display the SSID on the network standby screen

Setting	Options	Description
IP Address Display	On Off	Selects whether to display the IP address on the network standby screen

Parent topic: [Selecting Wireless Network Settings Manually](#)

## Selecting Wireless Network Settings in Windows

Before connecting to the projector, select the correct wireless network on your computer.

1. To access your wireless utility software, access the Desktop and double-click the network icon on the Windows taskbar.
2. Do one of the following:
  - If your projector is set up on an existing network (Advanced mode), select the network name (SSID).
  - If your projector is configured for Quick mode, select the projector's SSID.
3. Click **Connect**.

Parent topic: [Wireless Network Projection](#)

## Selecting Wireless Network Settings on Mac

Before connecting to the projector, select the correct wireless network on your Mac.

1. Click the AirPort icon on the menu bar at the top of the screen.
2. Make sure AirPort is turned on, then do one of the following:
  - If your projector is set up on an existing network (Advanced mode), select the network name (SSID).
  - If your projector is configured for Quick mode, select the projector's SSID.

Parent topic: [Wireless Network Projection](#)

## Setting Up Wireless Network Security

You can set up security for your projector to use on the wireless network. Set up one of the following security options to match the settings used on your network:

- WPA/WPA2-PSK security (Advanced connection mode)
- WPA2-PSK security (Advanced and Quick connection mode)

Check with your network administrator for guidance on entering the correct information.

1. Press the **Menu** button.
2. Select the **Network** menu and press **Enter**.
3. Select **Network Configuration** and press **Enter**.
4. Select the **Wireless LAN** menu and press **Enter**.

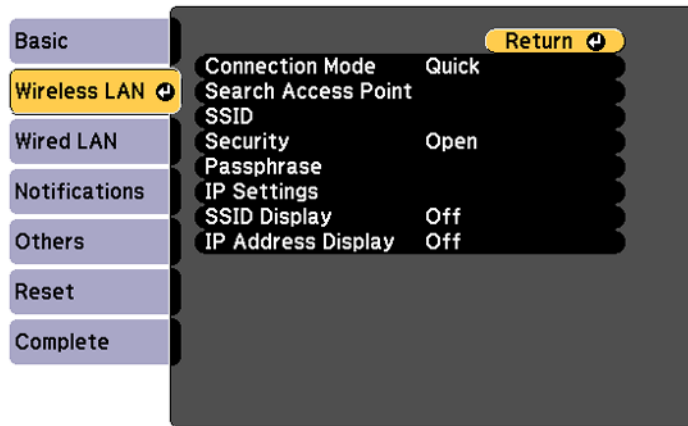

5. Select the **Security** setting and press **Enter**.
6. Select the security settings for your network.
7. When you finish selecting settings, select **Complete** and follow the on-screen instructions to save your settings and exit the menus.

Parent topic: [Wireless Network Projection](#)

## Connecting Directly to a Smartphone or Tablet

You can display a QR code on the screen and use it to connect a single smartphone or tablet to your projector with the Epson iProjection app.

1. Download the latest version of Epson iProjection from the App Store or Google Play and install it on your smartphone or tablet.
2. Press the **Menu** button on the projector or the remote control.

3. Select the **Network** menu and press **Enter**.

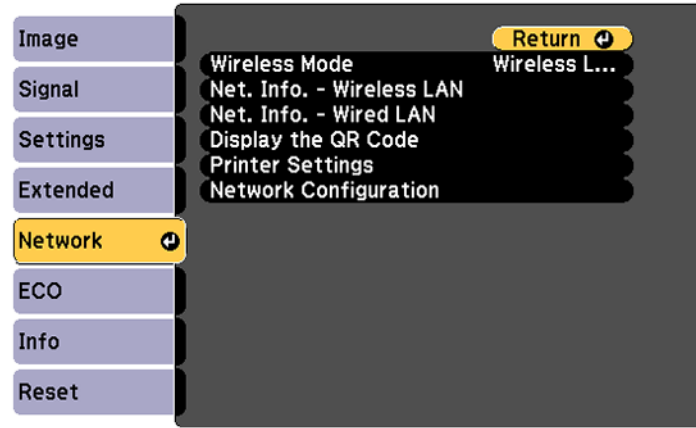

4. Select **Network Configuration** and press **Enter**.
5. Select the **Wireless LAN** menu and press **Enter**.

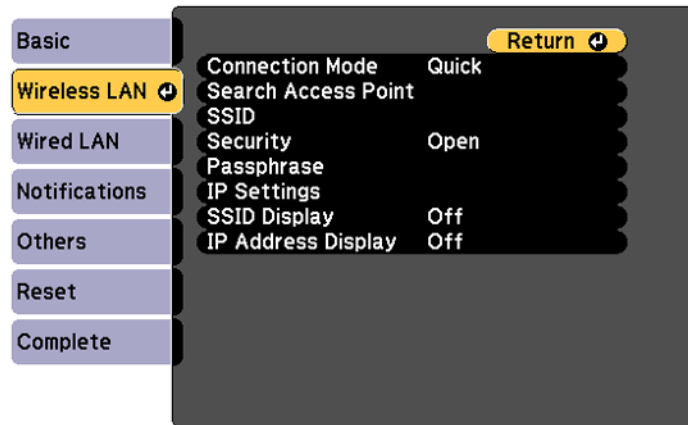

6. Select **Connection Mode** and press **Enter**.
7. Select **Quick** and press **Enter**, then press **Enter** again.

8. When you finish selecting settings, select **Complete** and follow the on-screen instructions to save your settings and exit the menus.
9. Press the **Home** button on the projector or the remote control.



10. Select the QR code icon  and press **Enter**.  
Your projector displays a QR code on the projection surface.
  11. Open Epson iProjection on your smartphone or tablet.
  12. Use the QR code reader feature to read the QR code and connect your device to the projector.
- Your smartphone or tablet is now connected to your projector. Visit [epson.com/iprojection](http://epson.com/iprojection) (U.S.) or [epson.ca/iprojection](http://epson.ca/iprojection) (Canada) for information on controlling your projector with the Epson iProjection app.

**Parent topic:** [Wireless Network Projection](#)

## Setting Up Projector Network E-Mail Alerts

You can set up the projector to send you an e-mail alert over the network if there is a problem with the projector.

1. Press the **Menu** button.



2. Select the **Network** menu and press **Enter**.
3. Select **Network Configuration** and press **Enter**.
4. Select the **Notifications** menu and press **Enter**.

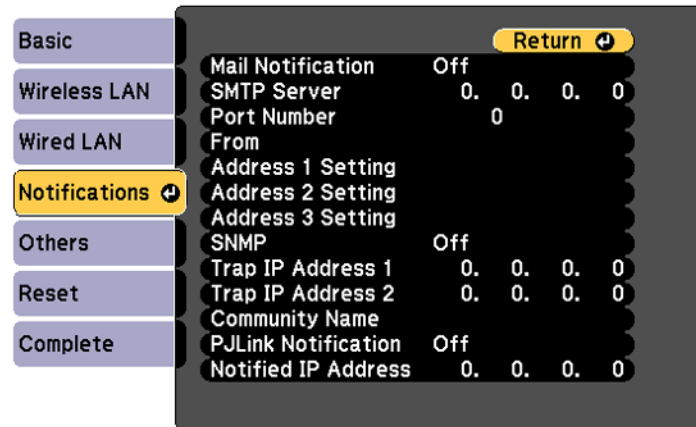

5. Turn on **Mail Notification**.
6. Enter the IP address for the **SMTP Server** setting.

**Note:** To enter the IP address using the numeric keys on the remote control, press and hold the **Num** button. Do not use these addresses: 127.x.x.x or 224.0.0.0 through 255.255.255.255 (where x is a number from 0 to 255).

7. Select a number for the SMTP server **Port Number** setting, from 1 to 65535 (default is 25).
8. Enter the sender's email address for the **From** option.
9. Choose an **Address** field, enter the e-mail address, and select the alerts you want to receive there. Repeat for up to three addresses. Your e-mail address can be up to 32 alphanumeric characters long.
10. If you are using the PJLink protocol for projector control, turn on **PJLink Notification** and enter the IP address where you want to receive PJLink notifications for the **Notified IP Address** setting.
11. When you finish selecting settings, select **Complete** and follow the on-screen instructions to save your settings and exit the menus.

**Note:** If a critical problem causes a projector to shut down, you may not receive an e-mail alert.

[Network Projector E-mail Alert Messages](#)

**Parent topic:** [Using the Projector on a Network](#)

## Network Projector E-mail Alert Messages

When a problem occurs with a networked projector, and you selected to receive e-mail alerts, you receive an e-mail containing the following information:

- The email address entered as the **From** setting
- **Epson Projector** on the subject line
- The name of the projector experiencing a problem
- The IP address of the affected projector
- Detailed information about the problem

**Note:** If a critical problem causes a projector to shut down, you may not receive an e-mail alert.

**Parent topic:** [Setting Up Projector Network E-Mail Alerts](#)

## Setting Up Monitoring Using SNMP

Network administrators can install SNMP (Simple Network Management Protocol) software on network computers so they can monitor projectors. If your network uses this software, you can set up the projector for SNMP monitoring.

1. Press the **Menu** button.
2. Select the **Network** menu and press **Enter**.
3. Select **Network Configuration** and press **Enter**.

4. Select the **Notifications** menu and press **Enter**.

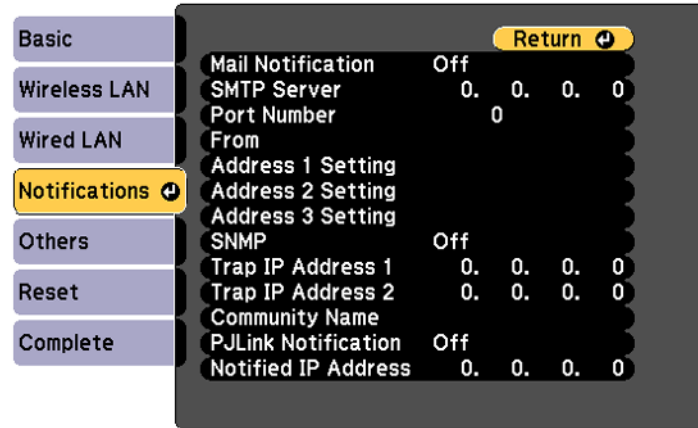

5. Turn on the **SNMP** setting.
6. Enter up to two IP addresses to receive SNMP notifications, using 0 to 255 for each address field.

**Note:** To enter the IP address using the numeric keys on the remote control, press and hold the **Num** button. Do not use these addresses: 127.x.x.x or 224.0.0.0 through 255.255.255.255 (where x is a number from 0 to 255).

7. Select the **Others** menu and press **Enter**.

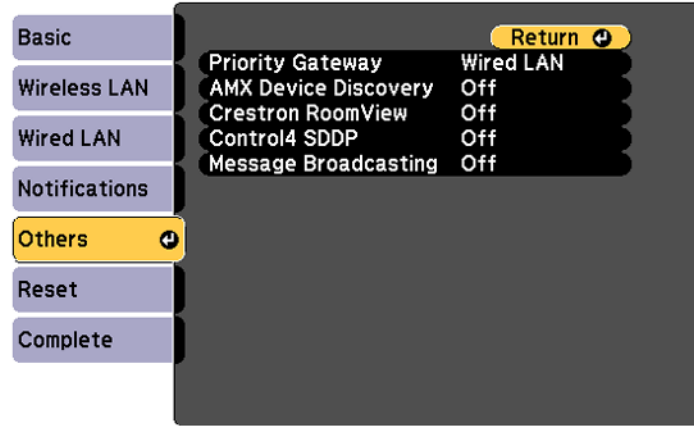

8. If available, select the **Priority Gateway** setting for your network.
9. If your network environment uses an AMX controller, turn on the **AMX Device Discovery** setting to allow the projector to be detected.
10. If your network environment uses a Crestron RoomView controller, turn on the **Crestron RoomView** setting to allow the projector to be detected.
11. If you are using the projector with a Control 4 Simple Device Discovery Protocol (SDDP) automation system, turn on the **Control4 SDDP** setting.
12. If you want this projector to receive broadcast messages over the network, turn on the **Message Broadcasting** setting. Administrators can broadcast messages over the network using the Message Broadcasting plug-in for EasyMP Monitor (Windows only).
13. When you finish selecting settings, select **Complete** and follow the on-screen instructions to save your settings and exit the menus.

Parent topic: [Using the Projector on a Network](#)

## Controlling a Networked Projector Using a Web Browser

Once you have connected your projector to your network, you can select projector settings and control projection using a compatible web browser. This lets you access the projector remotely.

**Note:** The web setup and control features support Microsoft Internet Explorer 9.0 or later, and Safari on networks that do not use a proxy server for connection. You cannot select all of the projector menu settings or control all projector functions using a web browser.

**Note:** If you set Standby Mode to **Communication On**, you can use a web browser to select settings and control projection even if the projector is in standby mode.

1. Make sure the projector is turned on.
2. Start your web browser on a computer or device connected to the network.
3. Type the projector's IP address into the browser's address box and press the computer's **Enter** key.
4. Select the  icon.

**Note:** You may need to log in before you see the Web Control screen. If you see a log in window, enter your user name and password. (The default user name is **EPSONWEB** and the default password is **admin**.)

You see the Web Control screen.

5. To select projector menu settings, select the name of the menu and follow the on-screen instructions.
6. To control projection remotely, select the **Web Remote** option.

You see a screen like this:

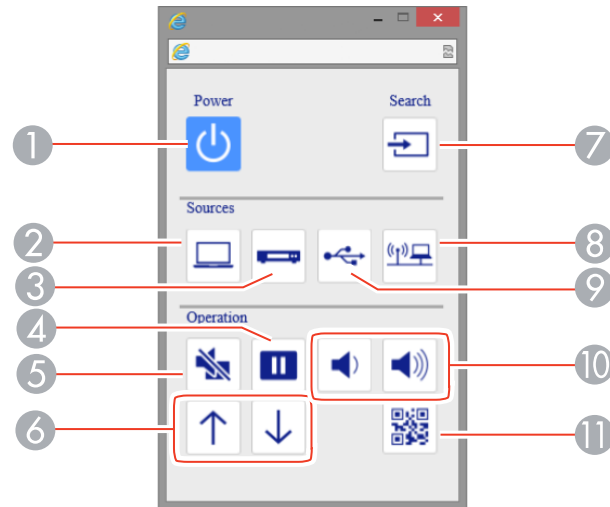

- 1 Power button control
- 2 Selects the **Computer** port source
- 3 Selects **Video** and **HDMI** port sources
- 4 **Freeze** button control
- 5 **A/V Mute** button control
- 6 **Page Up** and **Page Down** button controls
- 7 Searches for sources
- 8 Selects the network source
- 9 Selects the USB Display or USB device source
- 10 **Volume** button controls
- 11 Displays a QR code for connecting with iOS or Android devices using the Epson iProjection app

7. Select the icon corresponding to the projector function you want to control.

**Parent topic:** [Using the Projector on a Network](#)

## Related references

[Projector Setup Settings - Extended Menu](#)

## Crestron RoomView Support

If you are using the Crestron RoomView network monitoring and control system, you can set up your projector for use on the system. Crestron RoomView lets you control and monitor your projector using a web browser.

**Note:** You cannot use the Epson Web Control feature or the Message Broadcasting plug-in for EasyMP Monitor when you use Crestron RoomView.

For additional information on Crestron RoomView, contact Crestron.

[Setting Up Crestron RoomView Support](#)

[Controlling a Networked Projector Using Crestron RoomView](#)

**Parent topic:** [Using the Projector on a Network](#)

## Setting Up Crestron RoomView Support

To set up your projector for monitoring and control using a Crestron RoomView system, make sure your computer and projector are connected to the network. If you are connecting wirelessly, set up the projector using the Advanced network connection mode.

**Note:** If you want to use the Crestron RoomView system when the projector is turned off, you need to adjust the **Standby Mode** setting in the ECO menu.

1. Press the **Menu** button.
2. Select the **Network** menu and press **Enter**.
3. Select **Network Configuration** and press **Enter**.

4. Select the **Others** menu and press **Enter**.

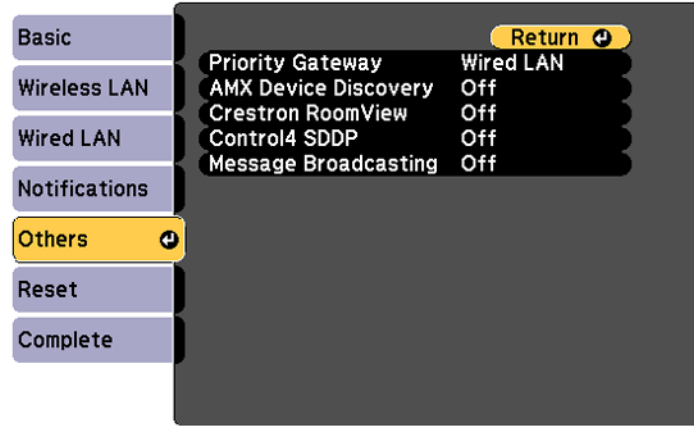

5. Set the **Crestron RoomView** setting to **On** to allow the projector to be detected.

**Note:** Enabling Crestron RoomView disables the Epson Message Broadcasting feature in the EasyMP Monitor software.

6. When you finish selecting settings, select **Complete** and follow the on-screen instructions to save your settings and exit the menus.
7. Turn off the projector, then turn it on again to enable the setting.

**Parent topic:** [Crestron RoomView Support](#)

#### **Related references**

[Projector Setup Settings - Extended Menu](#)

## **Controlling a Networked Projector Using Crestron RoomView**

Once you have set up your projector to use Crestron RoomView, you can control and monitor projection using a compatible web browser.

1. Start your web browser on a computer connected to the network.
2. Type the projector's IP address into the browser's address box and press the computer's **Enter** key.



You see this screen:

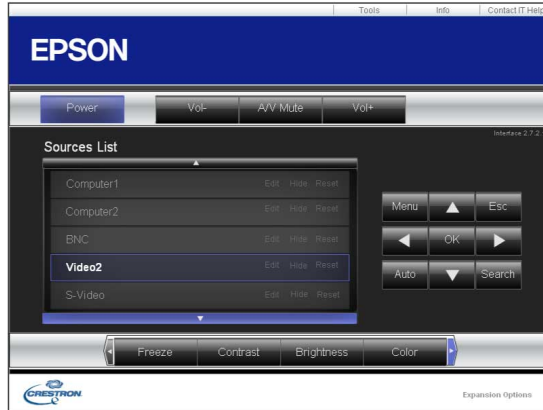

3. Select the input source that you want to control in the Sources List box. You can scroll through available sources using the up and down arrows in the box.
4. To control projection remotely, click the on-screen buttons that correspond to the projector's remote control buttons. You can scroll through button options at the bottom of the screen.

**Note:** These on-screen buttons do not directly correspond to the projector's remote control buttons:

- **OK** acts as the **Enter** button
- **Menu** displays the projector's menu

5. To view information about the projector, click the **Info** tab.
6. To change projector, Crestron, and password settings, click the **Tools** tab, select settings on the displayed screen, and click **Send**.
7. When you finish selecting settings, click **Exit** to exit the program.

**Parent topic:** [Crestron RoomView Support](#)

---

# Using Basic Projector Features

Follow the instructions in these sections to use your projector's basic features.

[Turning On the Projector](#)

[Turning Off the Projector](#)

[Selecting the Language for the Projector Menus](#)

[Image Shape](#)

[Resizing the Image with the Wide and Tele Buttons](#)

[Adjusting the Image Position](#)

[Focusing the Image](#)

[Remote Control Operation](#)

[Selecting an Image Source](#)

[Projection Modes](#)

[Image Aspect Ratio](#)

[Color Mode](#)

[Controlling the Volume with the Volume Buttons](#)

[Projecting a PC Free Presentation](#)

## Turning On the Projector

Turn on the computer or video equipment you want to use before you turn on the projector so it can display the image source.

1. Connect the power cord to the projector's power inlet.

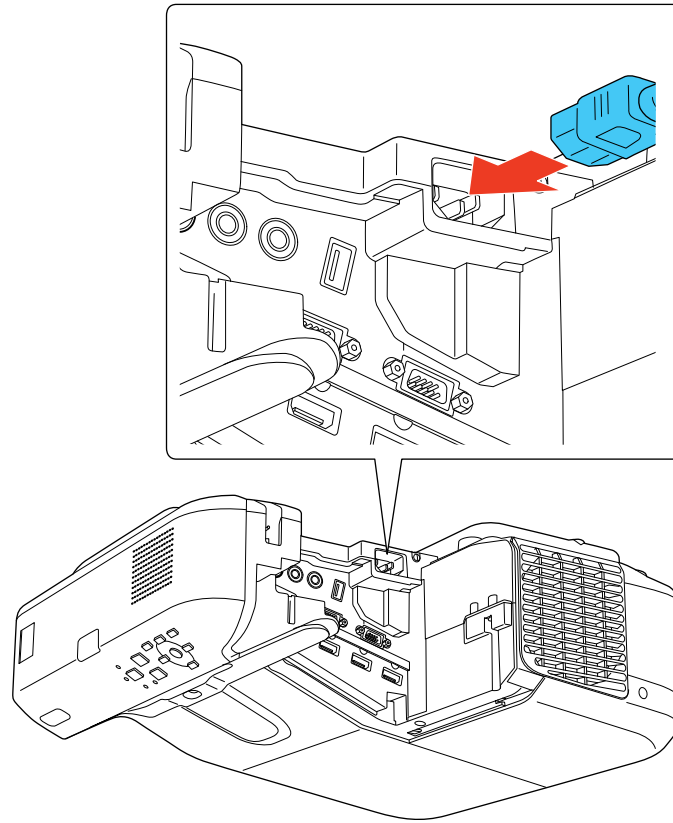

2. Plug the power cord into an electrical outlet.

**Note:** With **Direct Power On** turned on, the projector turns on as soon as you plug it in.

The projector's power light turns blue. This indicates that the projector is receiving power.

3. Press the power button on the projector or the remote control to turn on the projector.

The projector beeps and the Status light flashes blue as the projector warms up. Once the projector is warmed up, the Status light stops flashing and turns blue.

**Warning:** Never look into the projector lens when the lamp is on. This can damage your eyes and is especially dangerous for children.

If you do not see a projected image right away, try the following:

- Turn on the connected computer or video device.
- Insert a DVD or other video media and press the play button, if necessary.
- Press the **Source Search** button on the projector or remote control to detect the video source.
- If the Home screen is displayed, select the source you want to project.

**Parent topic:** [Using Basic Projector Features](#)

**Related references**

[Projector Setup Settings - Extended Menu](#)

## Turning Off the Projector

Before turning off the projector, shut down any computer connected to it so you can see the computer display during shutdown.

**Note:** Turn off this product when not in use to prolong the life of the projector. Lamp life will vary depending upon mode selected, environmental conditions, and usage. Brightness decreases over time.

**Note:** When using the A/V Mute feature, the projector lamp is still on. To turn off the lamp, turn off the projector.

1. Press the power button on the projector or the remote control.

The projector displays a shutdown confirmation screen.



2. Press the power button again. (To leave it on, press any other button.)  
The projector beeps twice, the lamp turns off, and the Status light turns off.

**Note:** With Epson's Instant Off technology, there is no cool-down period so you can pack up the projector for transport right away (if necessary).

3. To transport or store the projector, make sure the Status light is off, then unplug the power cord.

**Caution:** To avoid damaging the projector or lamp, never unplug the power cord when the Status light is on or flashing.

**Parent topic:** [Using Basic Projector Features](#)

**Related references**

[Projector Setup Settings - Extended Menu](#)

## Selecting the Language for the Projector Menus

If you want to view the projector's menus and messages in another language, you can change the Language setting.

1. Turn on the projector.
2. Press the **Menu** button.
3. Select the **Extended** menu and press **Enter**.

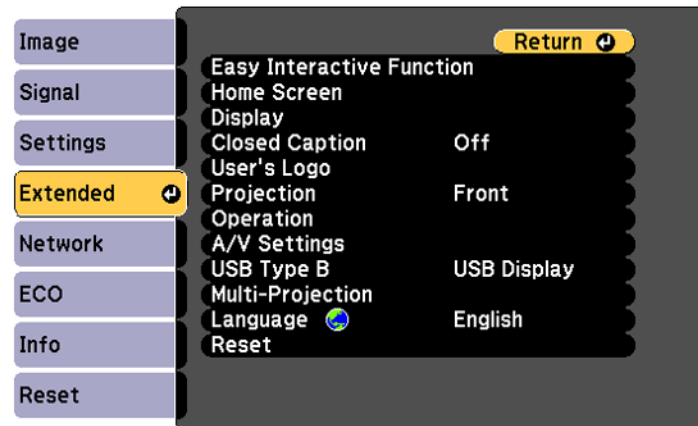

4. Select the **Language** setting and press **Enter**.
5. Select the language you want to use and press **Enter**.
6. Press **Menu** or **Esc** to exit the menus.

**Parent topic:** [Using Basic Projector Features](#)

**Related references**

[Projector Setup Settings - Extended Menu](#)

## Image Shape

You can project an evenly rectangular image by placing the projector directly in front of the center of the screen and keeping it level. If you place the projector at an angle to the screen, or tilted up or down, or off to the side, you may need to correct the image shape for the best display quality.

**Note:** For interactive use, the image must be evenly rectangular, without distortion.

[Correcting Image Shape with the Keystone Buttons](#)

[Correcting Image Shape with Quick Corner](#)

[Correcting Image Shape with Arc Correction](#)

**Parent topic:** [Using Basic Projector Features](#)

## Correcting Image Shape with the Keystone Buttons

You can use the projector's keystone correction buttons to correct the shape of an image that is unevenly rectangular on the sides.

**Note:** You can use the keystone buttons to correct the image up to  $\pm 3^\circ$  horizontally or vertically.

**Note:** Using the keystone correction buttons may affect interactive pen and finger touch calibration.

1. Turn on the projector and display an image.

**Note:** You can display a pattern to aid in adjusting the projected image using the Settings menu.

2. Press one of these keystone buttons on the control panel to display the Keystone adjustment screen.

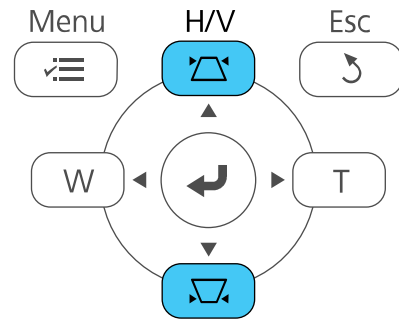

3. Press a keystone button on the projector's control panel to adjust the image shape.

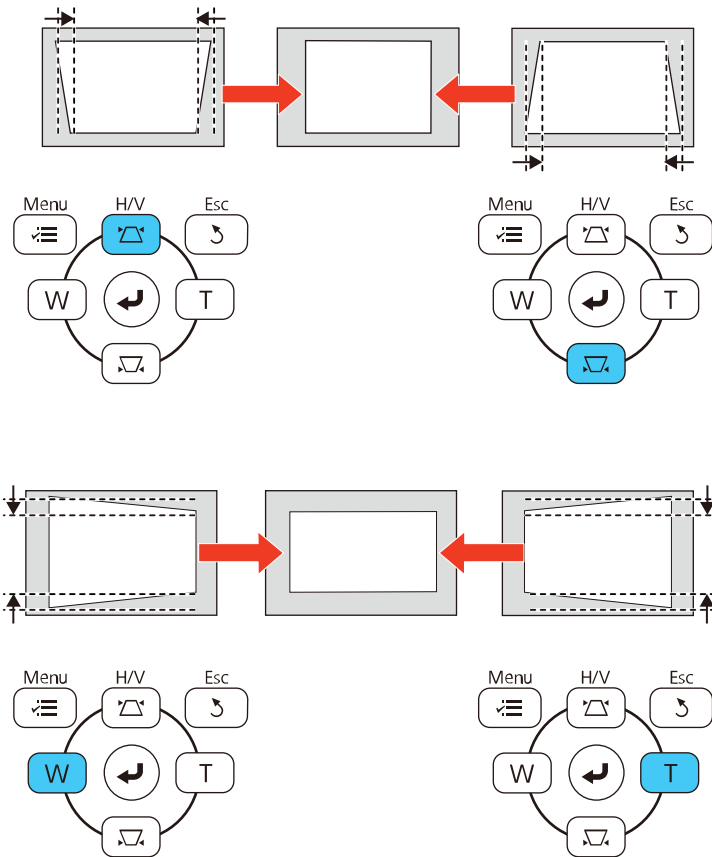

**Note:** The horizontal keystone adjustment buttons are labeled **W** and **T**.

After correction, your image is slightly smaller.

**Note:** If the projector is installed out of reach, you can also correct the image shape with the remote control using the **H/V-Keystone** settings in the projector menus.

**Parent topic:** [Image Shape](#)



### Related references

[Projector Feature Settings - Settings Menu](#)

## Correcting Image Shape with Quick Corner

You can use the projector's Quick Corner setting to correct the shape and size of an image that is unevenly rectangular on all sides.

**Note:** Adjusting the Quick Corner setting may affect interactive pen and finger touch calibration.

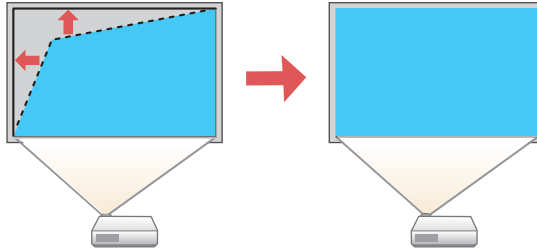

1. Turn on the projector and display an image.

**Note:** You can display a pattern to aid in adjusting the projected image using the Settings menu.

2. Press the **Menu** button.

3. Select the **Settings** menu and press **Enter**.

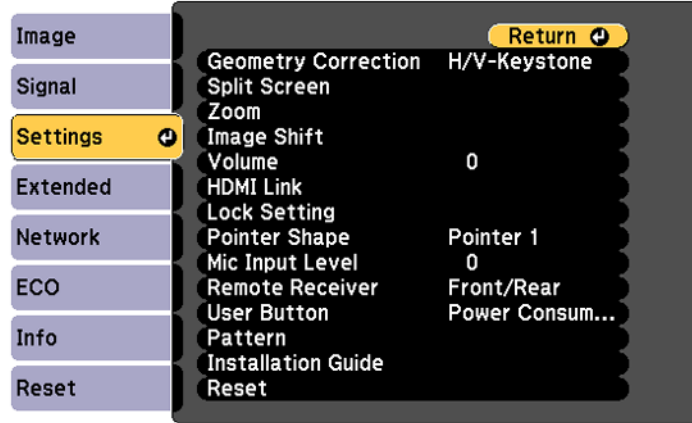

4. Select the **Geometry Correction** setting and press **Enter**.
5. Select the **Quick Corner** setting and press **Enter**. Then press **Enter** again.

You see the Quick Corner adjustment screen:

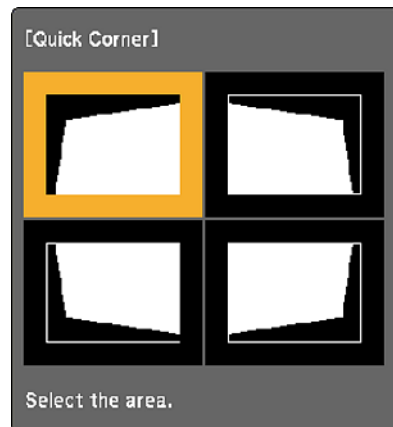

**Note:** To reset your adjustments, press and hold the **Esc** button for at least 2 seconds to display a reset screen. Then select **Yes**.

6. Use the arrow buttons on the projector or the remote control to select the corner of the image you want to adjust. Then press **Enter**.
7. Press the arrow buttons to adjust the image shape as necessary. Press **Enter** to return to the area selection screen.
8. When you are finished, press **Esc**.

**Parent topic:** [Image Shape](#)

**Related references**

[Projector Feature Settings - Settings Menu](#)

## Correcting Image Shape with Arc Correction

You can use the projector's Arc Correction setting to adjust the curve or arc of the sides of your image.

**Note:** Adjusting the Arc Correction setting may affect interactive pen and finger touch calibration.

1. Turn on the projector and display an image.

**Note:** You can display a pattern to aid in adjusting the projected image using the Settings menu.

2. Press the **Menu** button.
3. Select the **Settings** menu and press **Enter**.

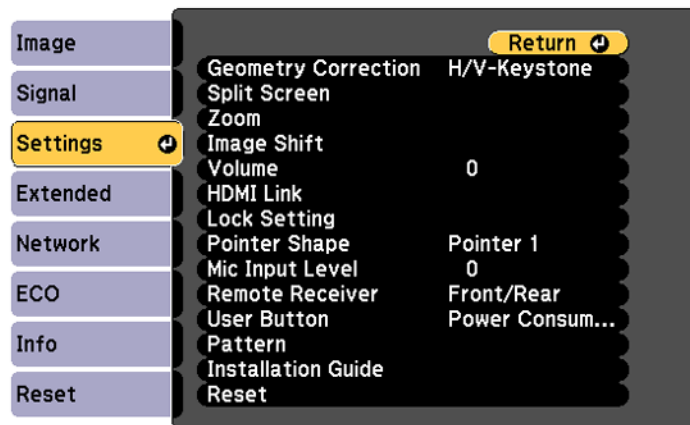

4. Select the **Geometry Correction** setting and press **Enter**.
5. Select the **Arc Correction** setting and press **Enter**. Then press **Enter** again.  
You see the Arc Correction adjustment screen.

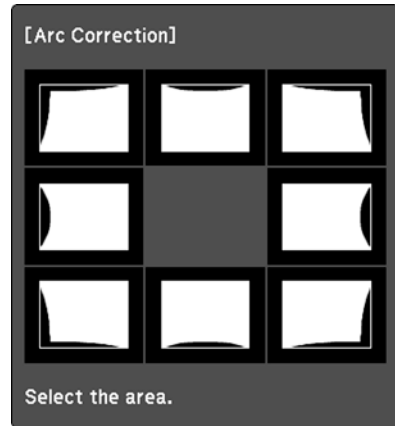

6. Use the arrow buttons on the projector or the remote control to select the corner or side of the image you want to adjust. Then press **Enter**.
7. Press the arrow buttons to adjust the image shape as necessary.
8. When you are finished, press **Esc**.

**Parent topic:** [Image Shape](#)

**Related references**

[Projector Feature Settings - Settings Menu](#)

## Resizing the Image with the Wide and Tele Buttons

1. Turn on the projector and display an image.
2. To enlarge the image size, press the **W** (Wide) button on the projector's control panel.

- To reduce the image size, press the **T** (Tele) button.

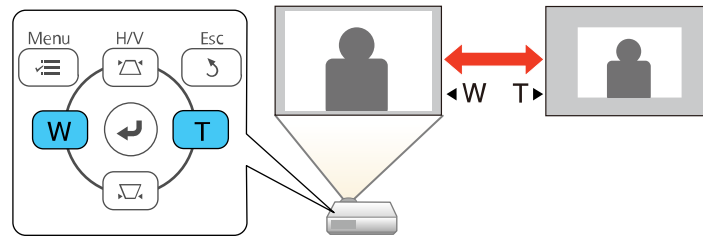

After you adjust the image size, the Image Shift screen is displayed automatically for adjusting the image position.

**Note:** If the projector is installed out of reach, you can also adjust the image size with the remote control using the **Zoom** setting in the projector menus.

**Parent topic:** [Using Basic Projector Features](#)

**Related references**

[Projector Feature Settings - Settings Menu](#)

**Related tasks**

[Adjusting the Image Position](#)

## Adjusting the Image Position

You can use the Image Shift feature to adjust the image position without moving the projector.

**Note:** This feature is not available if the **Zoom** option is set to the widest setting.

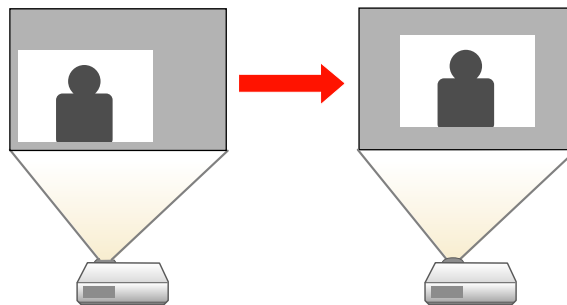

1. Turn on the projector and display an image.
2. Adjust the image size using the **W** (Wide) and **T** (Tele) buttons.  
After you adjust the image size, the Image Shift screen is displayed automatically.

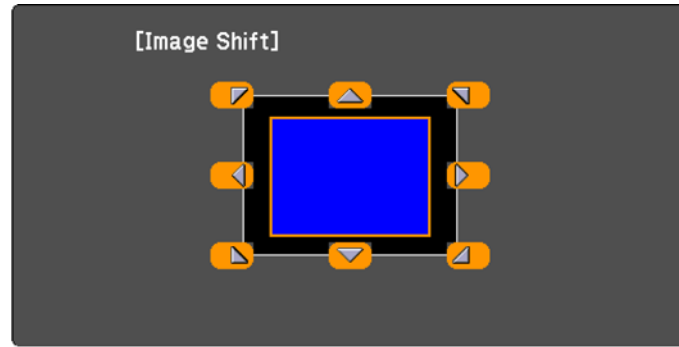

3. Use the arrow buttons on the projector or remote control to adjust the image position.

**Note:** You can also use the Settings menu to adjust the **Image Shift** setting.

**Parent topic:** [Using Basic Projector Features](#)

**Related references**

[Projector Feature Settings - Settings Menu](#)

## Focusing the Image

1. Turn on the projector and display an image.

**Note:** You can display a pattern to aid in adjusting the projected image using the Settings menu.

2. Slide the air filter cover latch and open the air filter cover.

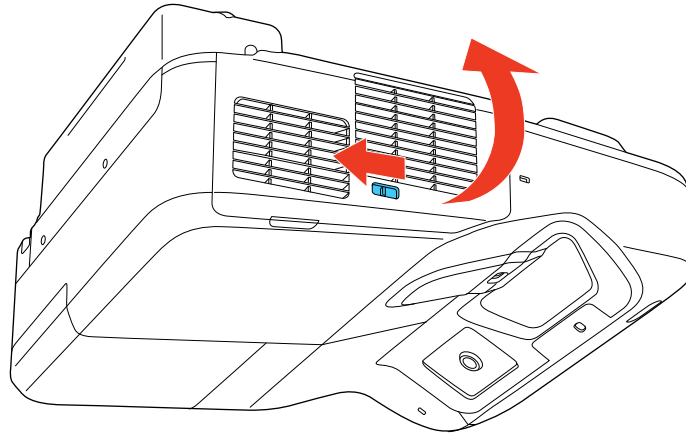

3. Raise or lower the focus lever to sharpen the image.

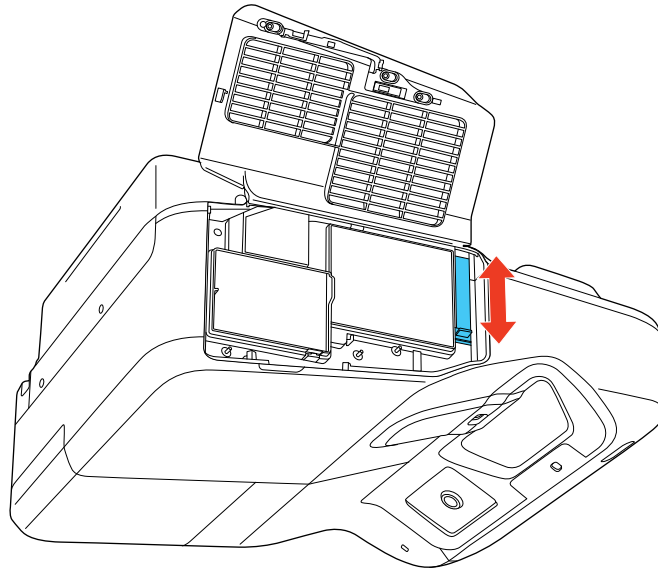

**Parent topic:** [Using Basic Projector Features](#)

## Related references

[Projector Feature Settings - Settings Menu](#)

# Remote Control Operation

The remote control lets you control the projector from almost anywhere in the room, up to 19.7 feet (6 m) away. You can point it at the screen or board, or the front or back of the projector.

Make sure that you aim the remote control at the projector's receivers within the angles listed here.

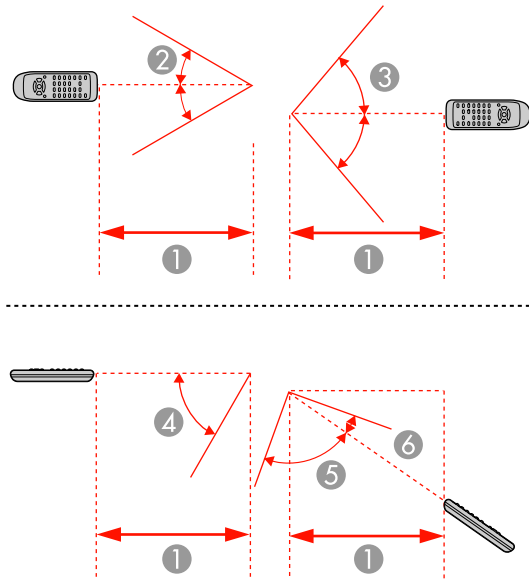

- 1 19.7 feet (6 m)
- 2  $\pm 30^\circ$
- 3  $\pm 55^\circ$
- 4  $60^\circ$
- 5  $75^\circ$
- 6  $15^\circ$



**Note:** Avoid using the remote control in conditions with bright fluorescent lights or in direct sunlight, or the projector may not respond to commands. If you will not use the remote control for a long time, remove the batteries.

[Using the Remote Control as a Wireless Mouse](#)

[Using the Remote Control as a Pointer](#)

**Parent topic:** [Using Basic Projector Features](#)

## Using the Remote Control as a Wireless Mouse

You can use the projector's remote control as a wireless mouse so you can control projection at a distance from the computer. The computer must be running Windows Vista or later, OS X 10.7 or later, or macOS 10.12.x

**Note:** This feature cannot be used at the same time as the interactive pens. If you want to use the remote control as a wireless mouse, you need to change the **USB Type B** setting in the projector's Extended menu.



1. Connect the projector to a computer using the projector's **USB-B**, **Computer**, or **HDMI** port to display video.

**Note:** You cannot use the wireless mouse feature with an MHL connection.

2. If you connected your computer to a port other than the projector's **USB-B** port, also connect a USB cable to the projector's **USB-B** port and to a USB port on your computer (for wireless mouse support).
3. Start your presentation.

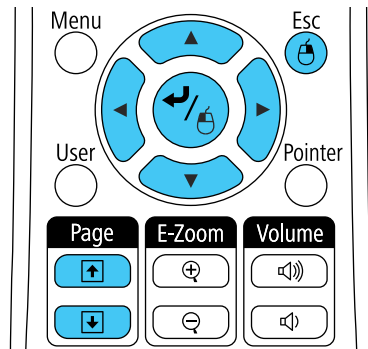
4. Use the following buttons on the remote control to control your presentation:
- To move through slides or pages, press the up or down **Page** buttons.



- To move the cursor on the screen, use the arrow buttons.
- To left-click, press the  button once (press it twice to double-click).
- To right-click, press the **Esc** button.
- To drag-and-drop, hold the  button as you move the cursor with the arrow buttons, then release  at the destination.

**Parent topic:** [Remote Control Operation](#)

#### **Related tasks**

[Connecting to a Computer for USB Mouse Control](#)

## **Using the Remote Control as a Pointer**

You can use the projector's remote control as a pointer to help you call out important information on the screen. The default pointer shape is an arrow, but you can select an alternative shape using the Settings menu.

1. Press the **Pointer** button on the remote control.

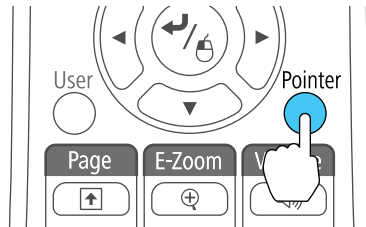

2. Use the arrow buttons on the remote control to move the pointer on the screen.

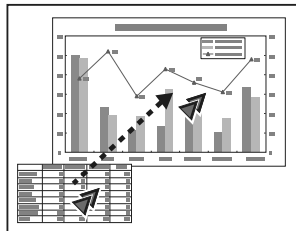

3. Press **Esc** to clear the pointer from the screen.

**Parent topic:** [Remote Control Operation](#)

**Related references**

[Projector Feature Settings - Settings Menu](#)

## Selecting an Image Source

If you connected multiple image sources to the projector, such as a computer and DVD player, you may want to switch from one image source to the other.

**Note:** If the **Auto Source Search** setting in the Extended menu is enabled, the projector automatically switches to another detected image source if the signal to the current image source is lost.

1. Make sure the connected image source you want to use is turned on.
2. For video image sources, insert a DVD or other video media and press its play button, if necessary.

3. Do one of the following:

- Press the **Source Search** button on the projector or remote control until you see the image from the source you want.

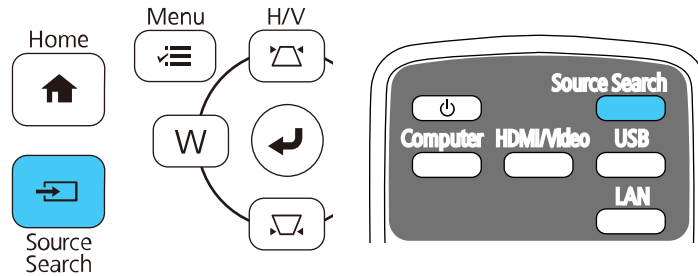

- Press the button for the source you want on the remote control. If there is more than one port for that source, press the button again to cycle through the sources.
- Press the **Home** button on the remote control and select your image source.



Parent topic: [Using Basic Projector Features](#)

## Projection Modes

Depending on how you positioned the projector, you may need to change the projection mode so your images project correctly.

- **Front** lets you project from a table in front of the screen.
- **Front/Upside Down** (default setting) flips the image over top-to-bottom to project upside-down from a wall or ceiling mount. This mode should also be used when you mount the projector vertically on a table to create an interactive work surface.
- **Rear** flips the image horizontally to project from behind a translucent screen.
- **Rear/Upside Down** flips the image over top-to-bottom and horizontally to project from the wall or ceiling and behind a translucent screen.

**Note:** The two Rear modes cannot be used with the interactive pens.

You can change the projection mode using the remote control or by changing the **Projection** setting in the **Extended** menu.

[Changing the Projection Mode Using the Remote Control](#)

[Changing the Projection Mode Using the Menus](#)

**Parent topic:** [Using Basic Projector Features](#)

**Related references**

[Projector Setup Settings - Extended Menu](#)

## Changing the Projection Mode Using the Remote Control

You can change the projection mode to flip the image over top-to-bottom.

1. Turn on the projector and display an image.
2. Hold down the **A/V Mute** button on the remote control for five seconds.

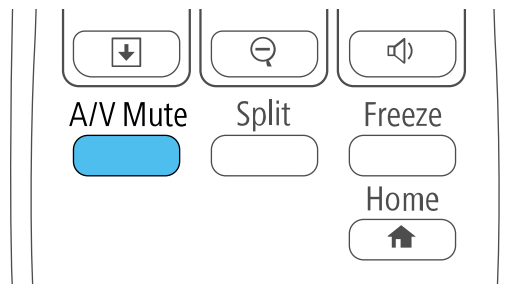

The image disappears briefly and reappears flipped top-to-bottom.

3. To change projection back to the original mode, hold down the **A/V Mute** button for five seconds again.

Parent topic: [Projection Modes](#)

## Changing the Projection Mode Using the Menus

You can change the projection mode to flip the image over top-to-bottom and/or left-to-right using the projector menus.

1. Turn on the projector and display an image.
2. Press the **Menu** button.
3. Select the **Extended** menu and press **Enter**.

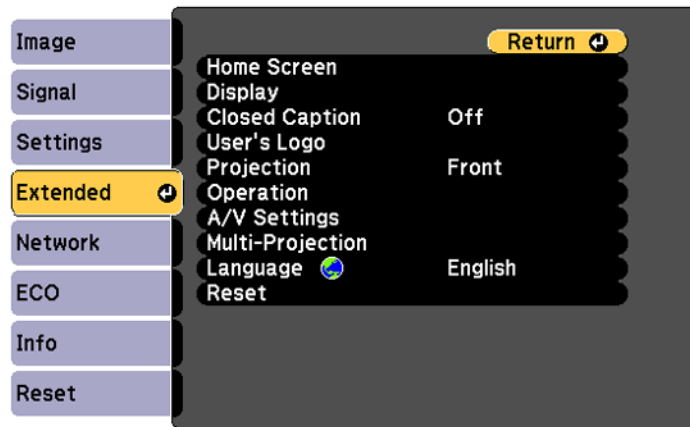

4. Select the **Projection** setting and press **Enter**.
5. Select a projection mode and press **Enter**.
6. Press **Menu** or **Esc** to exit the menus.

Parent topic: [Projection Modes](#)

### Related references

[Projector Setup Settings - Extended Menu](#)

## Image Aspect Ratio

The projector can display images in different width-to-height ratios called aspect ratios. Normally the input signal from your video source determines the image's aspect ratio. However, for certain images you can change the aspect ratio to fit your screen by pressing a button on the remote control.

If you always want to use a particular aspect ratio for a certain video input source, you can select it using the projector's menus.

[Changing the Image Aspect Ratio](#)

[Available Image Aspect Ratios](#)

**Parent topic:** [Using Basic Projector Features](#)

## Changing the Image Aspect Ratio

You can change the aspect ratio of the displayed image to resize it.

1. Turn on the projector and switch to the image source you want to use.
2. Press the **Aspect** button on the remote control.

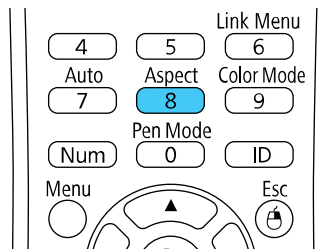

The shape and size of the displayed image changes, and the name of the aspect ratio appears briefly on the screen.

3. To cycle through the available aspect ratios for your input signal, press the **Aspect** button repeatedly.

**Parent topic:** [Image Aspect Ratio](#)

## Available Image Aspect Ratios

You can select the following image aspect ratios, depending on the input signal from your image source.

**Note:** Black bands and cropped images may project in certain aspect ratios, depending on the aspect ratio and resolution of your input signal.

Aspect ratio setting	Description
<b>Auto</b>	Automatically sets the aspect ratio according to the input signal and the <b>Resolution</b> setting.
<b>Normal</b>	Displays images using the full projection area and maintains the aspect ratio of the image.
<b>16:9</b>	Converts the aspect ratio of the image to 16:9.
<b>Full</b>	Displays images using the full width of the projection area, but does not maintain the aspect ratio.
<b>Zoom</b>	Displays images using the full width of the projection area and maintains the aspect ratio of the image.
<b>Native</b>	Displays images as is (aspect ratio and resolution are maintained).

**Note:** The **Auto** aspect ratio setting is available only for HDMI image sources.

**Parent topic:** [Image Aspect Ratio](#)

## Color Mode

The projector offers different Color Modes to provide optimum brightness, contrast, and color for a variety of viewing environments and image types. You can select a mode designed to match your image and environment, or experiment with the available modes.

If you always want to use a particular color mode for a certain video input source, you can select it using the projector menus.

[Changing the Color Mode](#)

[Available Color Modes](#)

[Turning On Auto Iris](#)

**Parent topic:** [Using Basic Projector Features](#)

## Changing the Color Mode

You can change the projector's Color Mode using the remote control to optimize the image for your viewing environment.



1. Turn on the projector and switch to the image source you want to use.
2. If you are projecting from a DVD player or other video source, insert a disc or other video media and press the play button, if necessary.
3. Press the **Color Mode** button on the remote control to change the Color Mode.

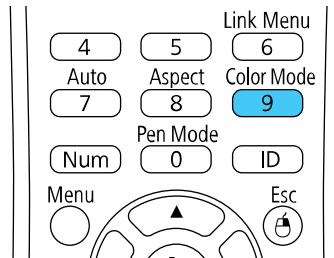

The image appearance changes and the name of the Color Mode appears briefly on the screen.

4. To cycle through all the available Color Modes for your input signal, press the **Color Mode** button repeatedly.

Parent topic: [Color Mode](#)

## Available Color Modes

You can set the projector to use these Color Modes, depending on the input source you are using:

Color Mode	Description
<b>Presentation</b>	Best for color presentations in a bright room
<b>Dynamic</b>	Best for video games in a bright room
<b>Cinema</b>	Best for movies projected in a dark room
<b>sRGB</b>	Best for standard sRGB computer displays
<b>Blackboard</b>	Best for presentations onto a green chalkboard (adjusts the colors accordingly)

Parent topic: [Color Mode](#)

### Related references

[Image Quality Settings - Image Menu](#)

## Turning On Auto Iris

In certain color modes, you can turn on the Auto Iris setting to automatically optimize the image based on the brightness of the content you project.

1. Turn on the projector and switch to the image source you want to use.
2. Press the **Menu** button.
3. Select the **Image** menu and press **Enter**.

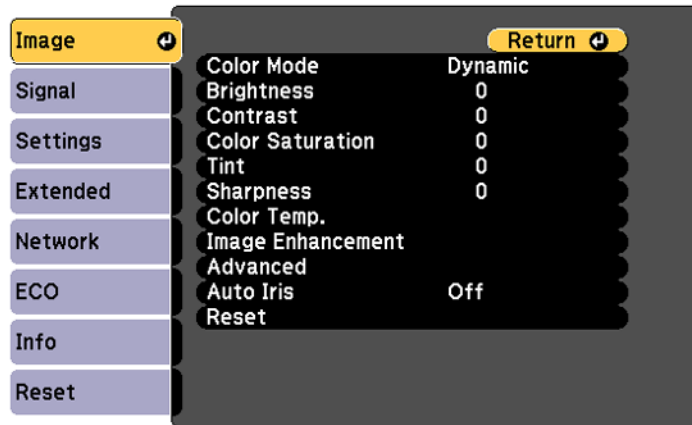

4. Select the **Auto Iris** setting and choose one of the following:
  - **High Speed** to adjust brightness as soon as the scene changes.
  - **Normal** for standard brightness adjustment.

**Note:** You can set **Auto Iris** for each Color Mode that supports the feature. You cannot change the **Auto Iris** setting when you are using a **Closed Caption** setting.

5. Press **Menu** or **Esc** to exit the menus.

Parent topic: [Color Mode](#)

## Controlling the Volume with the Volume Buttons

You can use the **Volume** buttons on the remote control to adjust the volume as you project a presentation with audio. The volume buttons control the projector's internal speaker system or any external speakers you connected to the projector.

You must adjust the volume separately for each connected input source.

1. Turn on the projector and start a presentation that includes audio.
2. To lower or raise the volume, press the **Volume** buttons on the remote control.

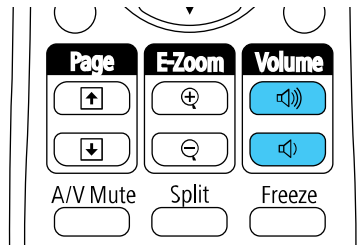

A volume gauge appears on the screen.

3. To set the volume to a specific level for an input source, use the projector menus.

**Parent topic:** [Using Basic Projector Features](#)

### Related references

[Projector Feature Settings - Settings Menu](#)

## Projecting a PC Free Presentation

You can use your projector's PC Free feature whenever you connect a USB device that contains compatible files. This lets you quickly and easily display the contents of the files and control their display using the projector's remote control.

[Supported PC Free File Types](#)

[Starting a PC Free Slide Show](#)

[Starting a PC Free Movie Presentation](#)

[PC Free Display Options](#)

**Parent topic:** [Using Basic Projector Features](#)

## Related tasks

[Connecting a USB Device or Camera to the Projector](#)

## Supported PC Free File Types

You can project these types of files using the projector's PC Free feature.

**Note:** For best results, place your files on media that is formatted in FAT16/32. If you have trouble projecting from media formatted for non-Windows file systems, try formatting the media for Windows instead. You may not be able to use the security features on certain USB storage devices with PC Free features. When connecting a USB-compatible hard drive, connect the AC adapter supplied with the drive.

File type and extension	Details
Image (.jpg)	Make sure the file is not: <ul style="list-style-type: none"><li>• CMYK format</li><li>• Progressive format</li><li>• Highly compressed</li><li>• Above 8192 × 8192 resolution</li></ul>
Image (.bmp)	Make sure the file resolution is not above 1280 × 800
Image (.gif )	Make sure the file is not: <ul style="list-style-type: none"><li>• Above 1280 × 800 resolution</li><li>• Animated</li></ul>
Image (.png)	Make sure the file resolution is not above 1280 × 800
Movie (.avi)	Make sure the file is not: <ul style="list-style-type: none"><li>• Saved with an audio codec other than PCM or ADPCM</li><li>• Above 1280 × 720 resolution</li><li>• Larger than 2GB</li></ul>

Parent topic: [Projecting a PC Free Presentation](#)

## Starting a PC Free Slide Show

After connecting a USB device or digital camera to the projector, you can switch to the USB input source and start your slide show.

**Note:** You can change the PC Free operation options or add special effects by highlighting **Option** at the bottom of the screen and pressing **Enter**.

**Note:** You can also use the interactive pen or your finger (BrightLink 695Wi) to operate the slide show.

1. Press the **USB** button on the projector remote control.

The PC Free screen appears.



2. Do the following as necessary to locate your files:

- If you need to display files inside a subfolder on your device, press the arrow buttons to highlight the folder and press the **Enter** button.
- To move back up a folder level on your device, highlight **Back to Top** and press **Enter**.

- To view additional files in a folder, highlight **Next page** or **Previous page** and press **Enter**. (You can also press the **Page** up or down buttons on the remote control.)

3. Do one of the following:

- To display an individual image, press the arrow buttons to highlight the image and press **Enter**. (Press the **Esc** button to return to the file list screen.)
- To display a slide show of all the images in a folder, press the arrow buttons to highlight the **Slideshow** option at the bottom of the screen and press **Enter**.

**Note:** If any file names are longer than 8 characters or include unsupported symbols, the file names may be shortened or changed only in the screen display.

4. While projecting, use the following commands to control the display as necessary:

- To rotate a displayed image, press the up or down arrow button. You can also rotate the image by flicking it with the interactive pen or your finger.
- To move to the next or previous image, press the left or right arrow button. You can also move between images by flicking the image with the interactive pen or your finger.

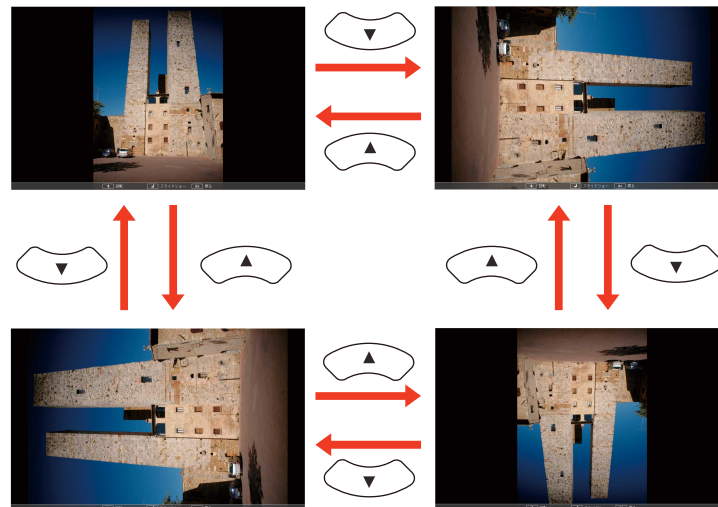

5. To stop the display, follow the on-screen instructions or press the **Esc** button.

**Parent topic:** [Projecting a PC Free Presentation](#)

## Starting a PC Free Movie Presentation

After connecting a USB device or digital camera to the projector, you can switch to the USB input source and start your movie.

**Note:** You can change the PC Free operation options by highlighting **Option** at the bottom of the screen and pressing **Enter**.

1. Press the **USB** button on the projector remote control.

The PC Free screen appears.



2. Do the following as necessary to locate your files:
  - If you need to display files inside a subfolder on your device, press the arrow buttons to highlight the folder and press the **Enter** button.
  - To move back up a folder level on your device, highlight **Back to Top** and press **Enter**.
  - To view additional files in a folder, highlight **Next page** or **Previous page** and press **Enter**.

- To play back a movie, press the arrow buttons to highlight the file and press **Enter**.

**Note:** If any file names are longer than 8 characters or include unsupported symbols, the file names may be shortened or changed only in the screen display. If you want to play back all the movies in a folder in sequence, select the **Slideshow** option at the bottom of the screen.

- To stop movie playback, press the **Esc** button, highlight **Exit**, and press **Enter**.

Parent topic: [Projecting a PC Free Presentation](#)

## PC Free Display Options

You can select these display options when using the projector's PC Free feature.

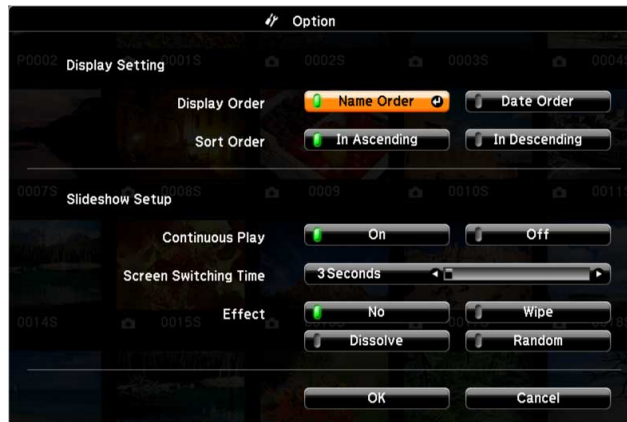

Setting	Options	Description
<b>Display Order</b>	<b>Name Order</b>	Displays files in name order
	<b>Date Order</b>	Displays files in date order
<b>Sort Order</b>	<b>In Ascending</b>	Sorts files in first-to-last order
	<b>In Descending</b>	Sorts files in last-to-first order
<b>Continuous Play</b>	<b>On</b>	Displays a slide show continuously
	<b>Off</b>	Displays a slide show one time through



<b>Setting</b>	<b>Options</b>	<b>Description</b>
<b>Screen Switching Time</b>	<b>No</b>	Does not display the next file automatically
	1 Second to 60 Seconds	Displays files for the selected time and switches to the next file automatically; high resolution images may switch at a slightly slower rate
<b>Effect</b>	<b>Wipe</b>	Transitions between images with a wipe effect
	<b>Dissolve</b>	Transitions between images with a dissolve effect
	<b>Random</b>	Transitions between images using a random variety of effects

**Parent topic:** [Projecting a PC Free Presentation](#)

---

# Adjusting Projector Features

Follow the instructions in these sections to use your projector's feature adjustments.

[Projecting Two Images Simultaneously](#)

[Using Multiple Projectors](#)

[Shutting Off the Picture and Sound Temporarily](#)

[Stopping Video Action Temporarily](#)

[Zooming Into and Out of Images](#)

[Projector Security Features](#)

[Creating a User Pattern to Display](#)

[Copying Menu Settings Between Projectors](#)

## Projecting Two Images Simultaneously

You can use the split screen feature to simultaneously project two images from different image sources next to each other. You can control the split screen feature using the remote control, the projector menus, or the interactive function.

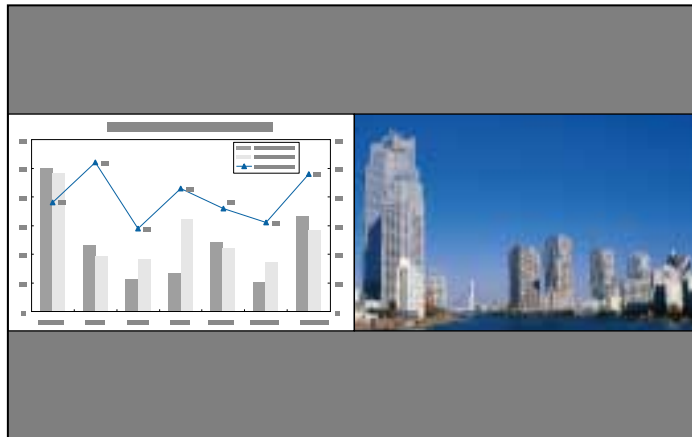

**Note:** While you use the split screen feature, other projector features may not be available and some settings may be automatically applied to both images. The following operations cannot be performed during split screen projection:

- Menu settings

- E-Zoom
- Switching aspect mode
- Operations made by the **User** button on the remote control
- Auto Iris

**Note:** You cannot project from the same input source onto both sides (left and right) of the screen. You also cannot use split screen with certain input source combinations.

1. Press the **Split** button on the remote control.

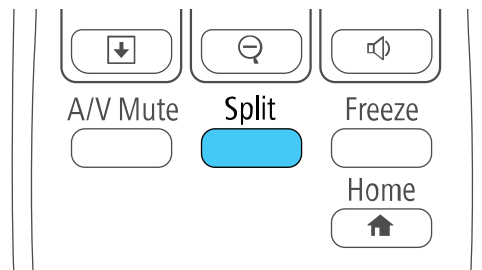

The currently selected input source moves to the left side of the screen.

2. Press the **Menu** button.

You see this screen:

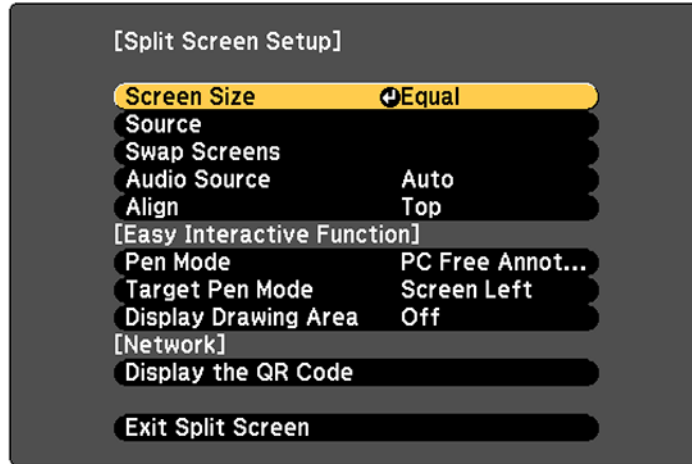

3. To select an input source for the other image, select the **Source** setting, press **Enter**, select the input source, select **Execute**, and press **Enter**. (You can also change image sources, if necessary.)
4. To switch the images, select the **Swap Screens** setting and press **Enter**.
5. To change the image sizes, select the **Screen Size** setting, press **Enter**, select a sizing option, press **Enter**, and press **Menu** to exit.

**Note:** Depending on the video input signals, the images may not appear at the same size even if you choose the **Equal** setting.

6. To choose the audio you want to hear, select the **Audio Source** setting, press **Enter**, select an audio option, press **Enter**, and press **Menu** to exit.

**Note:** Select **Auto** to hear audio from the largest screen or the left screen.

7. To exit the split screen feature, press the **Split** or **Esc** button.

[Input Sources for Split Screen Projection](#)

**Parent topic:** [Adjusting Projector Features](#)

**Related tasks**

[Splitting the Screen](#)

## Input Sources for Split Screen Projection

You can choose from the input source combinations listed here for split screen projection.

Left Screen	Right Screen								
	HDMI1/ MHL	HDMI2	HDMI3	Computer1	Computer2	Video	USB Display	USB	LAN
HDMI1/MHL	—	✓	✓	✓	✓	✓	✓	✓	✓
HDMI2	✓	—	✓	✓	✓	✓	✓	✓	✓
HDMI3	✓	✓	—	✓	✓	✓	✓	✓	✓
Computer1	✓	✓	✓	—	—	—	✓	✓	✓
Computer2	✓	✓	✓	—	—	—	✓	✓	✓
Video	✓	✓	✓	—	—	—	✓	✓	✓
USB Display	✓	✓	✓	✓	✓	✓	—	—	—
USB	✓	✓	✓	✓	✓	✓	—	—	—
LAN	✓	✓	✓	✓	✓	✓	—	—	—

Parent topic: [Projecting Two Images Simultaneously](#)

## Using Multiple Projectors

You can combine the projected images from two or more projectors to create one large image. Follow the instructions in these sections to setup and project from multiple projectors.

[Projector Identification System for Multiple Projector Control](#)

[Setting the Projector ID](#)

[Setting the Remote Control ID](#)

[Adjusting Color Uniformity](#)

[Adjusting the Lamp's Brightness](#)

[Matching the Image Colors](#)

[Adjusting RBGCMY](#)

Parent topic: [Adjusting Projector Features](#)

## Projector Identification System for Multiple Projector Control

You can operate multiple projectors using one remote control for more elaborate presentations. To do this, you assign an identification number to each projector and to the remote control. Then you can operate all the projectors at once or individually.

**Note:** In some cases the brightness and color tone from different projectors may not match completely even after color correction. If the brightness and color tone differences become more noticeable over time, repeat the adjustments.

**Parent topic:** [Using Multiple Projectors](#)

### Setting the Projector ID

If you want to control multiple projectors from a remote control, give each projector a unique ID.

1. Press the **Menu** button.
2. Select the **Extended** menu and press **Enter**.
3. Select the **Multi-Projection** setting and press **Enter**.
4. Select **Projector ID** and press **Enter**.

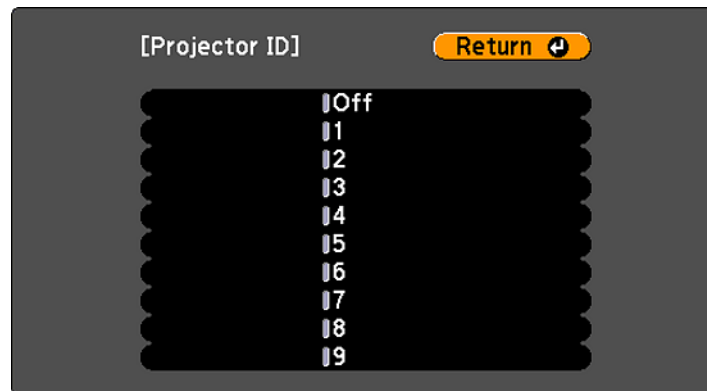

5. Press the arrow buttons on the remote control to select the identification number you want to use for the projector. Then press **Enter**.

Repeat these steps for all the other projectors you want to operate from one remote control.

**Note:** If you don't know the projector's ID, aim the remote control at the projector and press the **ID** button to temporarily display the projector's ID on the screen.

**Parent topic:** [Using Multiple Projectors](#)

**Related references**

[Projector Setup Settings - Extended Menu](#)

## Setting the Remote Control ID

The remote control's ID is set to zero by default so it can operate any compatible projector. If you want to set the remote control to operate only a particular projector, you need to set the remote control's ID to match the projector's ID.

1. Turn on the projector you want the remote control to operate with exclusively.
2. Make sure you know the projector's ID number as set in the Extended menu **Projector ID** setting.

**Note:** If you have forgotten the projector's ID, aim the remote control at the projector and press the **ID** button to temporarily display the projector's ID on the screen.

3. Aim the remote control at that projector.
4. Hold down the **ID** button on the remote control while you press the numeric button that matches the projector's ID. Then release the buttons.

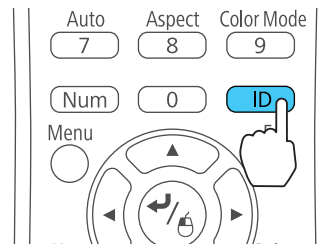

5. Press the **ID** button on the remote control to check if the ID-setting process worked.

You see a message displayed by the projector.

- If the remote control is listed as **On**, the remote control ID is set to operate only the listed projector.
- If the remote control is listed as **Off**, the remote control ID is not set properly. Repeat the steps above to set the ID to match the projector you want to control.

**Note:**

- You must set the remote control ID to match the projector ID each time you turn on the projector you have set it to control.
- When you select 0 on the remote control, you can operate all projectors regardless of the **Projector ID** setting.
- If you turn off the **Projector ID** setting, the remote control will operate the projector regardless of the ID selected on the remote.

Parent topic: [Using Multiple Projectors](#)

**Related references**

[Projector Setup Settings - Extended Menu](#)

## Adjusting Color Uniformity

If the color tone is uneven on each screen, adjust the color tone balance in the Extended menu of each projector.

**Note:**

- The color tone may not be uniform even after performing color uniformity.
  - You cannot adjust color uniformity when the **Color Mode** setting is set to **Dynamic**.
  - Color Uniformity is disabled in the built-in whiteboard mode.
1. Press the **Menu** button on the remote or control panel, select the **Extended** menu, and press **Enter**.

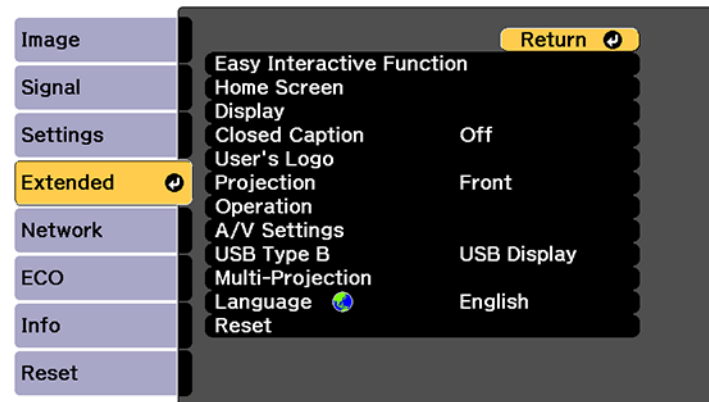



2. Select the **Multi-Projection** setting and press **Enter**.
3. Select the **Color Uniformity** menu and press **Enter**.

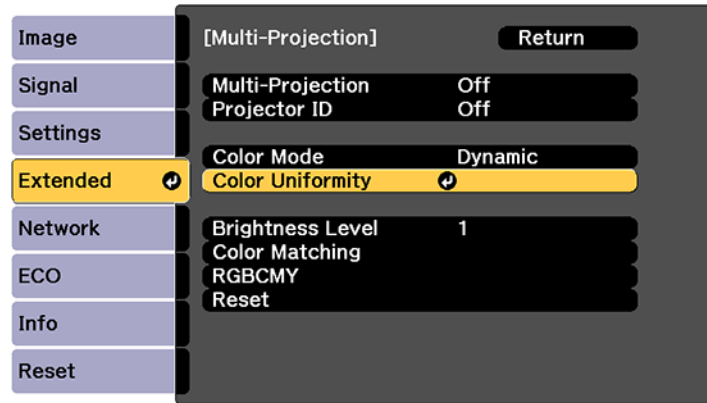

4. Select the **Color Uniformity** setting and press **Enter**.
5. Set the **Color Uniformity** setting to **On** and press **Enter**, then press **Esc**.
6. Select **Adjustment Level** and press **Enter**.
7. Select an adjustment level and press **Esc**.
8. Select **Start Adjustments** and press **Enter**.
9. Select the area you want to adjust and press **Enter**.



Adjust each individual area first, and then select **All** and adjust the entire screen.

10. Select **Red**, **Green**, or **Blue** and use the left arrow button to weaken the color tone and the right arrow button to strengthen the color tone.

**Note:** The adjustment screen changes each time you press **Enter**.

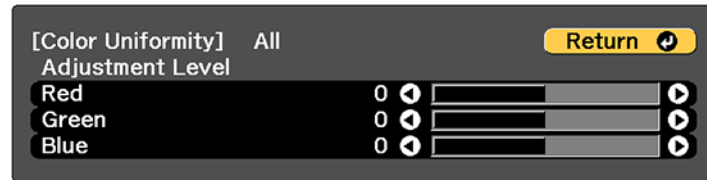

11. Press **Esc** to return to the area selection screen.
12. Repeat steps 9 through 11 for each area.
13. Press **Esc** to return to the previous screen.

**Parent topic:** [Using Multiple Projectors](#)

**Related references**

[Projector Setup Settings - Extended Menu](#)

## Adjusting the Lamp's Brightness

When projecting with multiple projectors, you must adjust the brightness setting so that all projectors are as bright as the darkest lamp. (Even after adjusting the brightness levels, the brightness of each lamp may not match exactly.)

**Note:** You cannot adjust the **Brightness Level** setting when using the built-in whiteboard mode.

1. Turn on all the projectors and display the same image.
2. Select **Normal** for the **Power Consumption** setting.
3. Press the **Menu** button.

4. Select the **Extended** menu and press **Enter**.

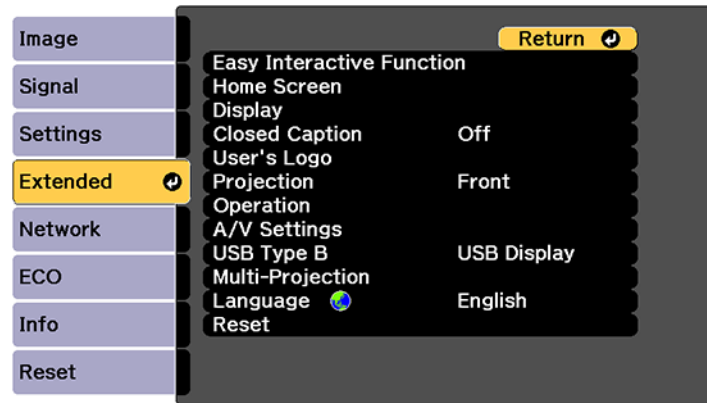

5. Select the **Multi-Projection** setting and press **Enter**.

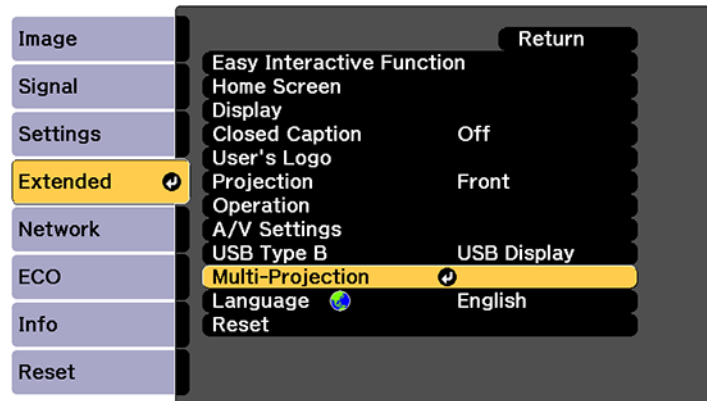

6. Select the **Brightness Level** setting and press **Enter**.

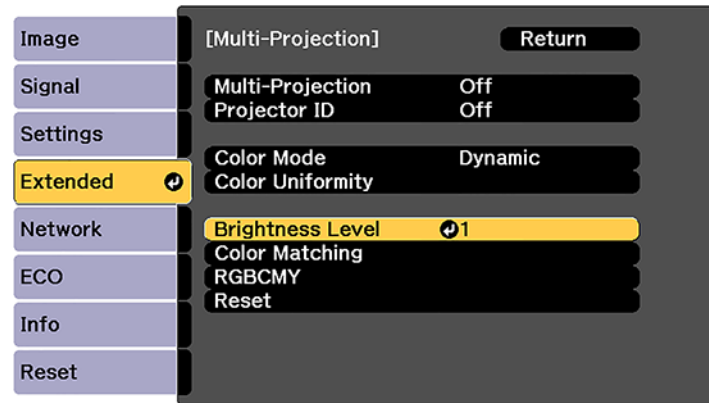

7. Select a brightness level and press **Enter**.

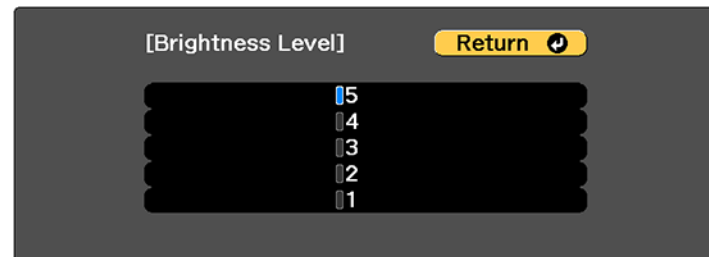

8. Press **Esc** to return to the previous screen.

**Parent topic:** [Using Multiple Projectors](#)

**Related references**

[Projector Setup Settings - Extended Menu](#)

## Matching the Image Colors

You can match the display quality of multiple projectors that will project next to one another.

**Note:** This function is disabled in the built-in whiteboard mode.

1. Press the **Menu** button.
2. Select the **Extended** menu and press **Enter**.

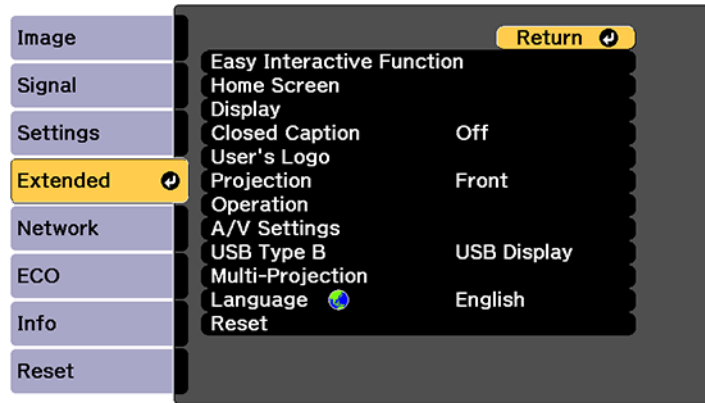

3. Select the **Multi-Projection** setting and press **Enter**.

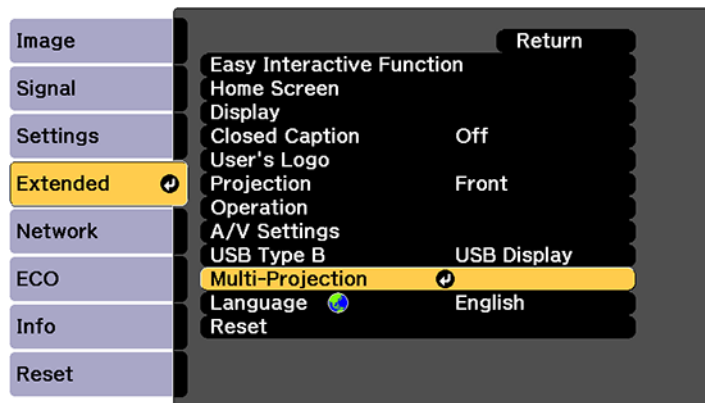

4. Select the **Color Matching** setting and press **Enter**.
5. Select the **Adjustment Level** setting and press **Enter**.

You see this screen:



6. Press the left or right arrow buttons to select a value for the **Adjustment Level** setting.

**Note:** There are six adjustment levels ranging from white to black and you can adjust each level individually.

7. Press the left or right arrow buttons to adjust the color tone for the **Red**, **Green**, and **Blue** settings.
8. Press the left or right arrow buttons to adjust the **Brightness** setting.
9. Repeat the previous three steps as necessary to adjust each adjustment level.

**Parent topic:** [Using Multiple Projectors](#)

**Related references**

[Projector Setup Settings - Extended Menu](#)

## Adjusting RGBCMY

You can adjust the **Hue**, **Saturation**, and **Brightness** settings for R (red), G (green), B (blue), C (cyan), M (magenta), and Y (yellow) color components.

Turn on all the projectors and select the RGBCMY setting in each projector's Extended menu so that the color tone on the combined screen becomes entirely even.

1. Press the **Menu** button.

2. Select the **Extended** menu and press **Enter**.

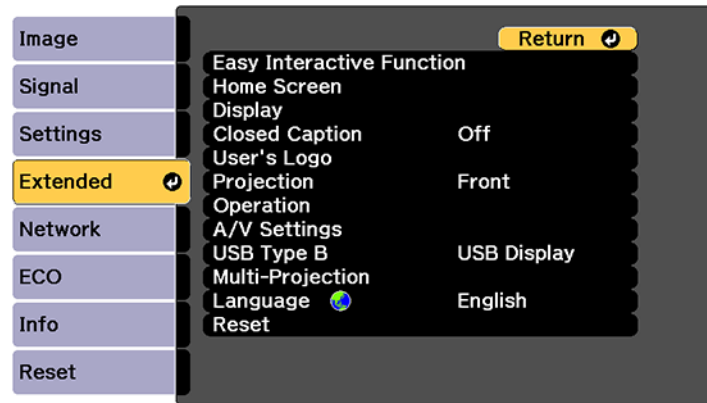

3. Select the **Multi-Projection** setting and press **Enter**.

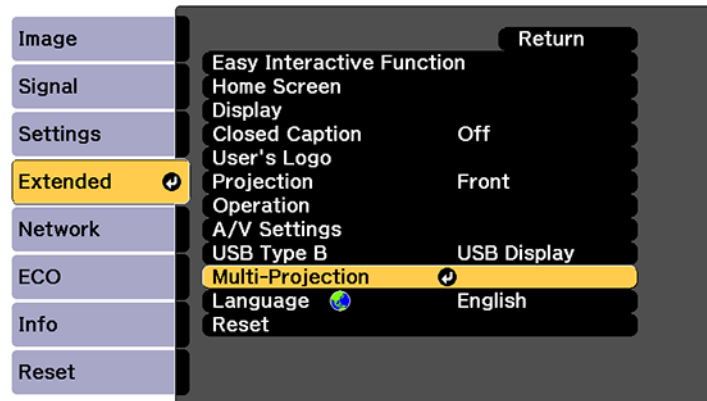

4. Select the **RGBCMY** setting and press **Enter**.

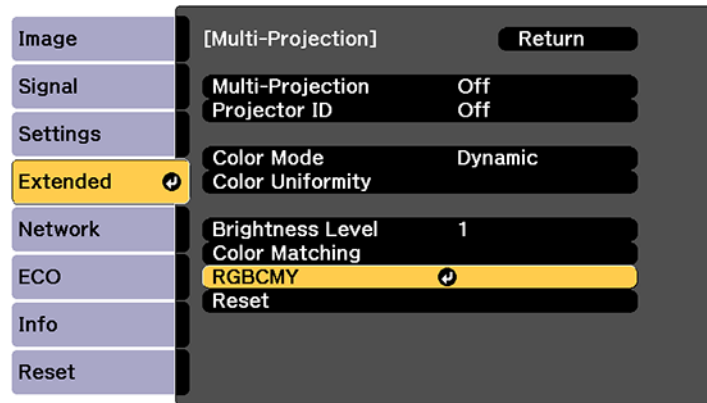

5. Select the color to adjust and press **Enter**.
  - To adjust the overall hue of the color, adjust the **Hue** setting.
  - To adjust the overall vividness of the color, adjust the **Saturation** setting.
  - To adjust the overall brightness of the color, adjust the **Brightness** setting.

You see this screen:

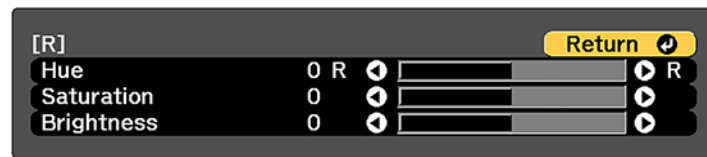

6. Press the left or right arrow buttons to adjust the color tone for the **Hue**, **Saturation**, and **Brightness** settings.
7. Repeat the previous three steps as necessary to adjust each adjustment level.
8. Press **Menu** or **Esc** to exit the menus.

**Parent topic:** [Using Multiple Projectors](#)

#### **Related references**

[Projector Setup Settings - Extended Menu](#)



## Shutting Off the Picture and Sound Temporarily

You can temporarily turn off the projected picture and sound if you want to redirect your audience's attention during a presentation. Any sound or video action continues to run, however, so you cannot resume projection at the point that you stopped it.

If you want to display an image such as a company logo or picture when the presentation is stopped, you can set up this feature using the projector's menus.

1. Press the **A/V Mute** button on the remote control to temporarily stop projection and mute any sound.

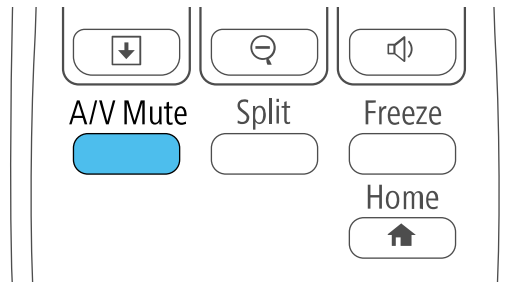

2. To turn the picture and sound back on, press **A/V Mute** again.

**Parent topic:** [Adjusting Projector Features](#)

## Stopping Video Action Temporarily

You can temporarily stop the action in a video or computer presentation and keep the current image on the screen. Any sound or video action continues to run, however, so you cannot resume projection at the point that you stopped it.

**Note:** You can also stop video action using the interactive pens.

1. Press the **Freeze** button on the remote control to stop the video action.

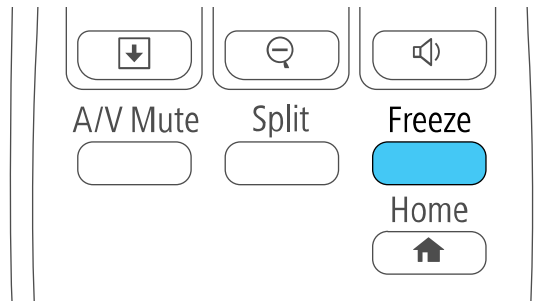

2. To restart the video action in progress, press **Freeze** again.

Parent topic: [Adjusting Projector Features](#)

## Zooming Into and Out of Images

You can draw attention to parts of a presentation by zooming into a portion of the image and enlarging it on the screen.

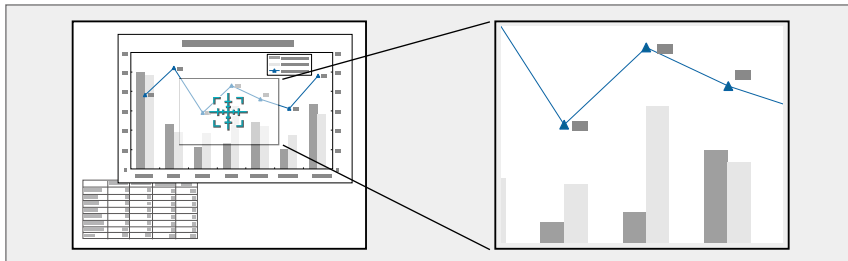

**Note:** You can also zoom into your image using the interactive pens.

1. Press the **E-Zoom +** button on the remote control.

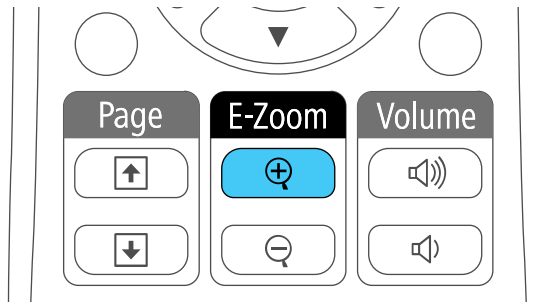

You see a crosshair on the screen indicating the center of the zoom area.

2. Use the following buttons on the remote control to adjust the zoomed image:
  - Use the arrow buttons to position the crosshair in the image area you want to zoom into.
  - Press the **E-Zoom +** button repeatedly to zoom into the image area, enlarging it as necessary. Press and hold the **E-Zoom +** button to zoom in more quickly.
  - To pan around the zoomed image area, use the arrow buttons.
  - To zoom out of the image, press the **E-Zoom –** button as necessary.
  - To return to the original image size, press **Esc**.

**Parent topic:** [Adjusting Projector Features](#)

## Projector Security Features

You can secure your projector to deter theft or prevent unintended use by setting up the following security features:

- Password security to prevent the projector from being turned on, and prevent changes to the startup screen and other settings.
- Button lock security to block operation of the projector using the buttons on the control panel.
- Security cabling to physically cable the projector in place.

[Password Security Types](#)

[Locking the Projector's Buttons](#)

[Installing a Security Cable](#)

**Parent topic:** [Adjusting Projector Features](#)

## Password Security Types

You can set up these types of password security using one shared password:

- **Power On Protection** password prevents anyone from using the projector without first entering a password.
- **User's Logo Protection** password prevents anyone from changing the custom screen the projector can display when it turns on or when you use the A/V Mute feature. The presence of the custom screen discourages theft by identifying the projector's owner.
- **Network Protection** password prevents anyone from changing the network settings in the projector menus.

[Setting a Password](#)

[Selecting Password Security Types](#)

[Entering a Password to Use the Projector](#)

[Saving a User's Logo Image to Display](#)

**Parent topic:** [Projector Security Features](#)

### Setting a Password

To use password security, you must set a password.

1. Hold down the **Freeze** button on the remote control for about five seconds or until you see this menu.

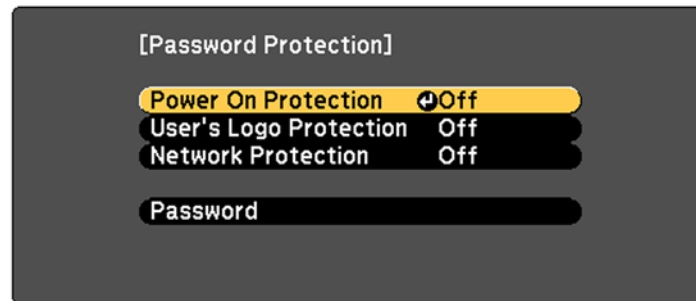

2. Press the down arrow to select **Password** and press **Enter**.  
You see the prompt "Change the password?".
3. Select **Yes** and press **Enter**.

4. Press and hold down the **Num** button on the remote control and use the numeric buttons to set a four-digit password.

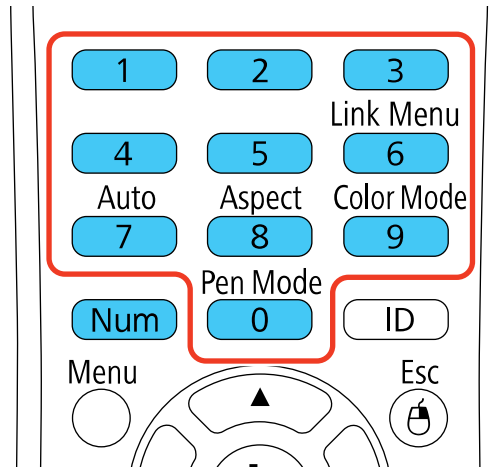

The password displays as \*\*\*\* as you enter it. Then you see the confirmation prompt.

5. Enter the password again.  
You see the message "Password accepted."
6. Press **Esc** to return to the menu.
7. Make a note of the password and keep it in a safe place in case you forget it.

**Parent topic:** [Password Security Types](#)

## Selecting Password Security Types

After setting a password, you see this menu, allowing you to select the password security types you want to use.

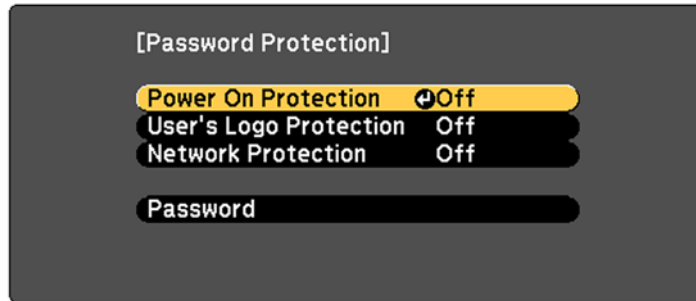

If you do not see this menu, hold down the **Freeze** button on the remote control for about seconds or until the menu appears.

1. To prevent unauthorized use of the projector, select **Power On Protection**, press **Enter**, select **On**, press **Enter** again, and press **Esc**.
2. To prevent changes to the User's Logo screen or related display settings, select **User's Logo Protection**, press **Enter**, select **On**, press **Enter** again, and press **Esc**.
3. To prevent changes to network settings, select **Network Protection**, press **Enter**, select **On**, press **Enter** again, and press **Esc**.

You can attach the Password Protect sticker to the projector as an additional theft deterrent.

**Note:** Be sure to keep the remote control in a safe place; if you lose it, you will not be able to enter the password required to use the projector.

**Parent topic:** [Password Security Types](#)

### Related references

[Projector Feature Settings - Settings Menu](#)

[Projector Network Settings - Network Menu](#)

### Related tasks

[Turning On the Projector](#)

[Saving a User's Logo Image to Display](#)

## Entering a Password to Use the Projector

If a password is set up and a **Power On Protection** password is enabled, you see a prompt to enter a password whenever you turn on the projector.

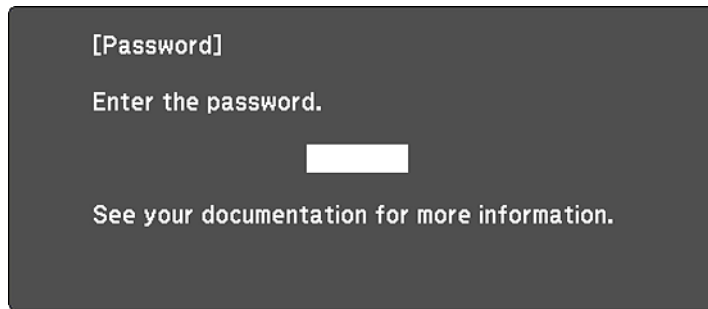

[0-9] :Enter

You must enter the correct password to use the projector.

1. Press and hold down the **Num** button on the remote control while you enter the password using the numeric buttons.

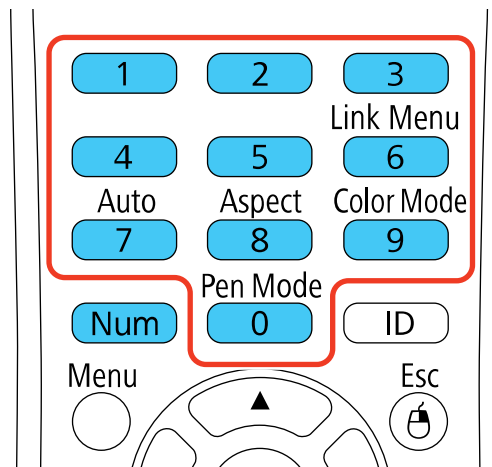

The password screen closes.

2. If the password is incorrect, the following may happen:
  - You see a "wrong password" message and a prompt to try again. Enter the correct password to proceed.
  - If you enter an incorrect password three times in succession, you see a message telling you that the projector is locked. The projector will remain in standby mode for 5 minutes. Unplug the projector, plug in the power cord, and turn on the projector. You see a prompt to enter the password.
  - If you continue to enter an incorrect password many times in succession, the projector displays a request code and a message to contact Epson Support. Do not attempt to enter the password again. When you contact Epson Support, provide the displayed request code and proof of ownership for assistance in unlocking the projector.

**Parent topic:** [Password Security Types](#)

#### **Related tasks**

[Selecting Password Security Types](#)

### **Saving a User's Logo Image to Display**

You can transfer an image to the projector and then display it whenever the projector turns on. You can also display the image when the projector is not receiving an input signal or when you temporarily stop projection (using the A/V Mute feature). This transferred image is called the User's Logo screen.

The image you select as the User's Logo can be a photo, graphic, or company logo, which is useful in identifying the projector's owner to help deter theft. You can prevent changes to the User's Logo by setting up password protection for it.

1. Display the image you want to project as the User's Logo.



2. Press the **Menu** button, select the **Extended** menu, and press **Enter**.

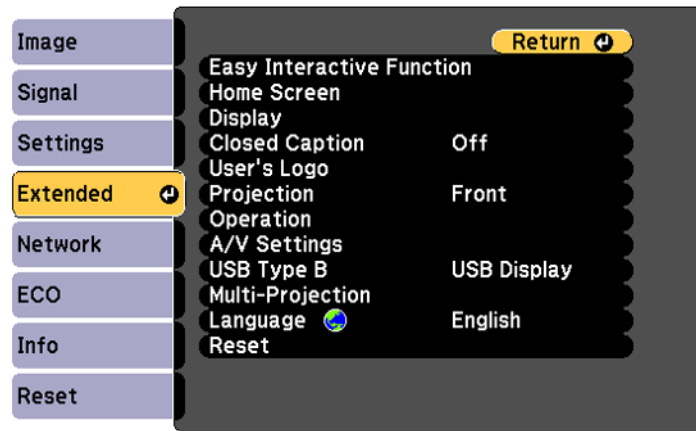

3. Select the **User's Logo** setting and press **Enter**.  
You see a prompt asking if you want to use the displayed image as a user's logo.
4. Select **Yes** and press **Enter**.  
You see a selection box overlaying your image.
5. Use the arrow buttons on the remote control to surround the image area you want to use as the User's Logo and press **Enter**.  
You see a prompt asking if you want to select this image area.
6. Select **Yes** and press **Enter**. (If you want to change the selected area, select **No**, press **Enter**, and repeat the last step.)

You see the User's Logo zoom factor menu.

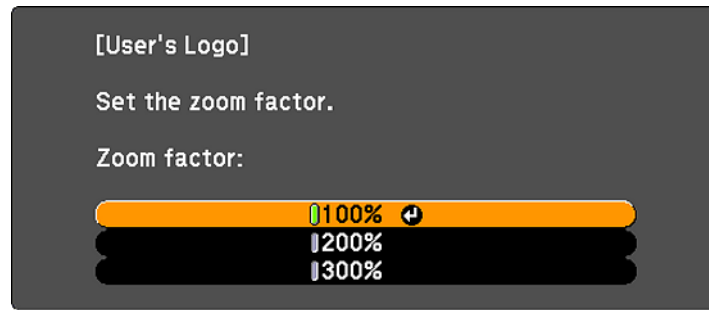

7. Select a zoom percentage and press **Enter**.  
You see a prompt asking if you want to save the image as the User's Logo.
8. Select **Yes** and press **Enter**.  
You see a completion message.
9. Press **Esc** to exit the message screen.
10. Select the **Extended** menu and press **Enter**.
11. Select **Display** and press **Enter**.
12. Select when you want to display the User's Logo screen:
  - To display it whenever there is no input signal, select **Display Background** and set it to **Logo**.
  - To display it whenever you turn the projector on, select **Startup Screen** and set it to **On**.
  - To display it whenever you press the **A/V Mute** button, select **A/V Mute** and set it to **Logo**.

To prevent anyone from changing the User's Logo settings without first entering a password, set a password and enable User's Logo security.

**Parent topic:** [Password Security Types](#)

#### **Related tasks**

[Setting a Password](#)

## **Locking the Projector's Buttons**

You can lock the buttons on the projector's control panel to prevent anyone from using the projector. You can lock all the buttons or all the buttons except the power button.

1. Press the **Menu** button.
2. Select the **Settings** menu and press **Enter**.

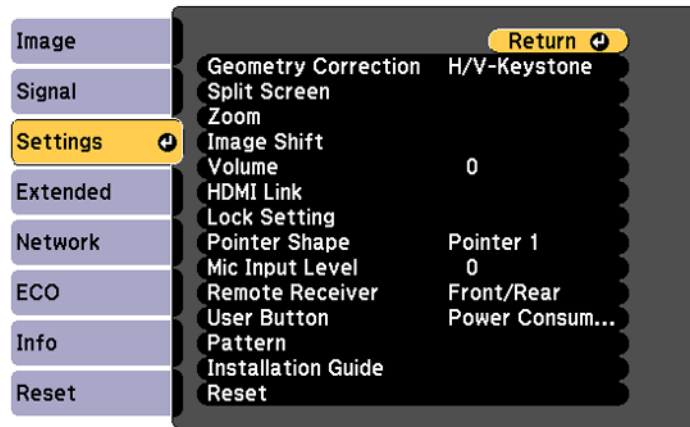

3. Select **Lock Setting** and press **Enter**.
4. Select the **Control Panel Lock** setting and press **Enter**.
5. Select one of these lock types and press **Enter**:
  - To lock all of the projector's buttons, select **Full Lock**.
  - To lock all buttons except the power button, select **Partial Lock**.You see a confirmation prompt.
6. Select **Yes** and press **Enter**.

[Unlocking the Projector's Buttons](#)

**Parent topic:** [Projector Security Features](#)

### Unlocking the Projector's Buttons

If the projector's buttons have been locked, hold the **Enter** button on the projector's control panel for seven seconds to unlock them.

**Parent topic:** [Locking the Projector's Buttons](#)

### Installing a Security Cable

You can install two types of security cables on the projector to deter theft.

- Use the security slot on the projector to attach a Kensington lock. See your local computer or electronics dealer for purchase information.
- Use the security cable attachment point on the projector to attach a wire cable and secure it to a room fixture or heavy furniture.

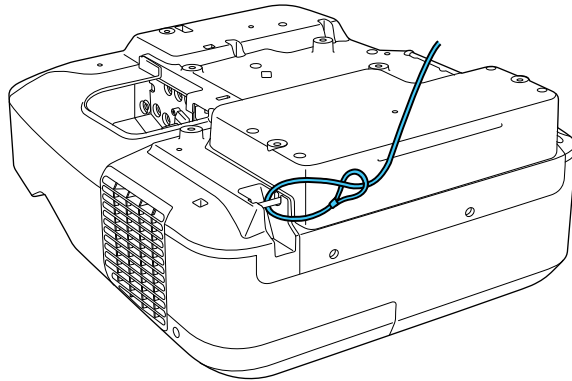

**Note:** Do not pass drop-prevention cables through the security cable attachment point when mounting the projector on a wall or ceiling.

**Parent topic:** [Projector Security Features](#)

## Creating a User Pattern to Display

You can transfer an image to the projector and then display it as a pattern to aid in presentations when you use the Pattern Display feature. This transferred image is called the User Pattern.

**Note:** Once you save a user pattern, you cannot restore the default pattern.

1. Display the image you want to project as the User Pattern from a connected computer or video source.

2. Press the **Menu** button, select the **Settings** menu, and press **Enter**.

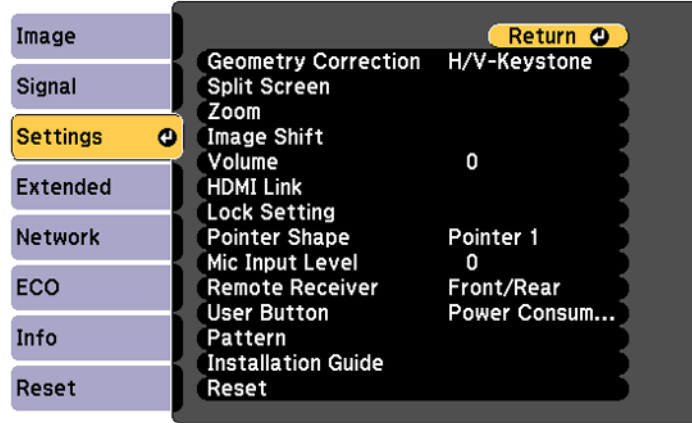

3. Select the **Pattern** setting and press **Enter**.
4. Select the **User Pattern** setting and press **Enter**.  
You see a prompt asking if you want to use the displayed image as a User Pattern.
5. Select **Yes** and press **Enter**.

**Note:** It takes a few moments for the projector to save the image; do not use the projector, its remote control, or any connected equipment until it is finished.

You see a completion message.

6. Press **Esc** to exit the message screen.

**Parent topic:** [Adjusting Projector Features](#)

## Copying Menu Settings Between Projectors

After you select menu settings for your projector, you can transfer them to another projector of the same model.

**Note:** Copy the projector's settings before you adjust the projected image using the projector's Geometry Correction settings. Any saved User's Logo setting on the projector will transfer to the other projector.

**Caution:** If the copy process fails due to a power failure, communication error, or for any other reason, Epson will not be responsible for any repair costs incurred.

The following settings will not transfer between projectors:

- Info menu items
- Network menu settings other than those in the Notifications and Others menus

**Note:** In addition to the methods covered this section, you can also copy and transfer settings to multiple projectors over a network using the EasyMP Network Updater software. See the *EasyMP Network Updater Operation Guide* for instructions. You can download the latest software and documentation from the Epson web site.

[Saving Settings to a USB Flash Drive](#)

[Transferring Settings From a USB Flash Drive](#)

[Saving Settings to a Computer](#)

[Transferring Settings From a Computer](#)

**Parent topic:** [Adjusting Projector Features](#)

## **Saving Settings to a USB Flash Drive**

You can save the projector settings you want to transfer to a USB flash drive.

**Note:** Use an empty flash drive. If the drive contains other files, the transfer may not complete correctly.

**Note:** The flash drive must use the FAT format and cannot have any security features.

1. Turn off the projector and unplug the power cord from the projector's power inlet.

2. Insert the flash drive into the **USB-A** port.

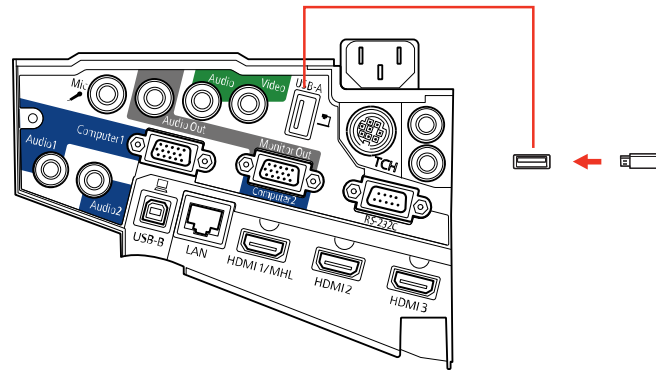

**Note:** Connect the flash drive directly to the projector. Do not use a hub or your settings may not be saved correctly.

3. Press and hold the **Esc** button on the control panel or remote control as you connect the power cord to the projector's power inlet.
4. When the power, Status, Lamp, and Temp lights turn on, release the **Esc** button.

The lights flash to indicate that settings are transferring to the flash drive. When the lights stop flashing, the power light turns blue and the projector enters standby mode.

**Caution:** Do not unplug the power cord or remove the flash drive while the lights are flashing. This could damage the projector.

5. Once the projector enters standby mode, remove the flash drive.

**Parent topic:** [Copying Menu Settings Between Projectors](#)

## Transferring Settings From a USB Flash Drive

After saving projector settings to a USB flash drive, you can transfer them to another projector of the same model.

**Note:** Make sure the USB flash drive contains only a single settings transfer from another projector of the same model. The settings are contained in a file called **pjconfdata.bin**. If the drive contains other files, the transfer may not complete correctly.

Do not adjust image settings on a projector until after you transfer settings to it. Otherwise, you may have to repeat your adjustments.

1. Turn off the projector and unplug the power cord from the projector's power inlet.
2. Insert the flash drive into the **USB-A** port.

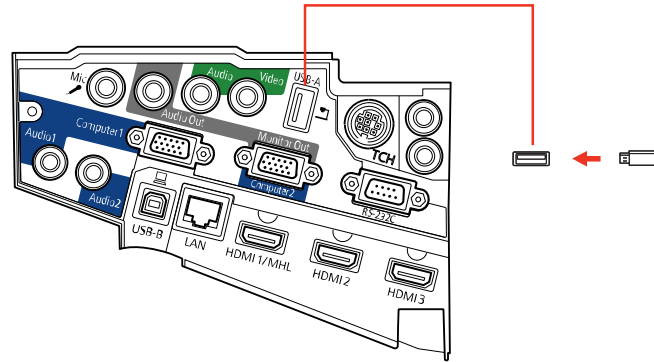

**Note:** Connect the flash drive directly to the projector. Do not use a hub or your settings may not be saved correctly.

3. Press and hold the **Menu** button on the control panel or remote control as you connect the power cord to the projector's power inlet.
4. When the power and Status lights turn blue and the Lamp and Temp lights turn orange, release the **Menu** button.

The lights flash to indicate that settings are transferring to the projector. When the lights stop flashing, the power light turns blue and the projector enters standby mode.

**Caution:** Do not unplug the power cord or remove the flash drive while the lights are flashing. This could damage the projector.

5. Once the projector enters standby mode, remove the flash drive.

**Parent topic:** [Copying Menu Settings Between Projectors](#)

## Saving Settings to a Computer

You can save the projector settings you want to transfer to a computer.



Your computer must be running one of the following operating systems:

- Windows Vista
- Windows 7
- Windows 8.x
- Windows 10
- OS X 10.7.x
- OS X 10.8.x
- OS X 10.9.x
- OS X 10.10.x
- OS X 10.11.x
- macOS 10.12.x

1. Turn off the projector and unplug the power cord from the projector's power inlet.
2. Connect a USB cable to your projector's **USB-B** port.

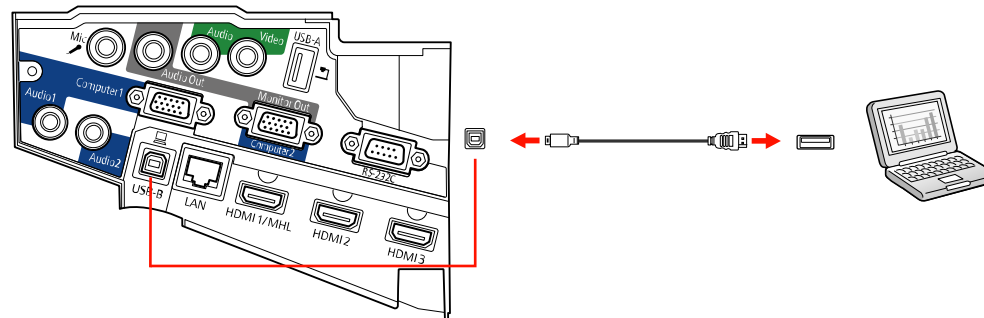

3. Connect the other end to any available USB port on your computer.
4. Press and hold the **Esc** button on the control panel or remote control as you connect the power cord to the projector's power inlet.
5. When the power, Status, Lamp, and Temp lights turn on, release the **Esc** button.  
The projector shows up as a removable disk on your computer.
6. Open the removable disk and copy the **pjconfdata.bin** file to your computer.

7. Once the file has copied, do one of the following:
  - **Windows:** Open the **My Computer**, **Computer**, or **Windows Explorer** utility. Right-click the name of your projector (listed as a removable disk) and select **Eject**.
  - **Mac:** Drag the removable disk icon for your projector from the desktop into the trash.The projector enters standby mode.

**Parent topic:** [Copying Menu Settings Between Projectors](#)

## Transferring Settings From a Computer

After saving projector settings to a computer, you can transfer them to another projector of the same model.

Your computer must be running one of the following operating systems:

- Windows Vista
- Windows 7
- Windows 8.x
- Windows 10
- OS X 10.7.x
- OS X 10.8.x
- OS X 10.9.x
- OS X 10.10.x
- OS X 10.11.x

Do not adjust image settings on a projector until after you transfer settings to it. Otherwise, you may have to repeat your adjustments.

1. Turn off the projector and unplug the power cord from the projector's power inlet.
2. Connect a USB cable to your projector's **USB-B** port.
3. Connect the other end to any available USB port on your computer.
4. Press and hold the **Menu** button on the control panel or remote control as you connect the power cord to the projector's power inlet.
5. When the power, Status, Lamp, and Temp lights turn on, release the **Menu** button.  
The projector shows up as a removable disk on your computer.

6. Copy the **pjconfdata.bin** file from your computer to the removable disk.

**Note:** Do not copy any other files to the removable disk.

7. Once the file has copied, do one of the following:

- **Windows:** Open the **My Computer**, **Computer**, or **Windows Explorer** utility. Right-click the name of your projector (listed as a removable disk) and select **Eject**.
- **Mac:** Drag the removable disk icon for your projector from the desktop into the trash.

The power, Status, Lamp, and Temp lights start flashing to indicate that the projector's settings are being updated. When the lights stop flashing, the power light turns blue and the projector enters standby mode.

**Caution:** Do not unplug the power cord while the lights are flashing. This could damage the projector.

**Parent topic:** [Copying Menu Settings Between Projectors](#)

---

# Using the Interactive Features

Follow the instructions in these sections to use your projector's interactive features.

[Interactive Modes](#)

[Using the Interactive Pens](#)

[Using Finger Touch Interactivity](#)

[Using BrightLink with a Computer](#)

[Windows Pen Input and Ink Tools](#)

[Using BrightLink Without a Computer](#)

## Interactive Modes

The BrightLink interactive features turn any wall into an interactive whiteboard, either with or without a computer. These interactive modes are available:

- In built-in whiteboard mode, you can use one or both interactive pens or your finger (BrightLink 695Wi) to write on the projected "whiteboard". You can split the screen and interact with the whiteboard and another source. You can insert images from a USB drive and save or print your whiteboard without connecting a computer.
- In built-in annotation mode (PC Free Annotation), you can annotate over content projected from a computer, tablet, document camera, or other source. You can capture your annotated pages, and save or print them. You can even split the screen and annotate on two images at the same time, using one or both pens.
- In PC Interactive mode, you can use the interactive pen or your finger (BrightLink 695Wi) as a mouse to navigate, select, and scroll through content from your computer. You can split the screen and interact with two projected images at the same time.

**Note:** You can also use the Easy Interactive Tools software to provide additional interactive features, such as saving your annotations and printing them. See the online *Easy Interactive Tools Operation Guide* for detailed instructions.

[Using the Projected Screen as a Whiteboard \(Built-in Whiteboard Mode\)](#)

[Drawing on a Projected Image \(Built-in Annotation Mode\)](#)

[Controlling Computer Features from a Projected Screen \(PC Interactive Mode\)](#)

**Parent topic:** [Using the Interactive Features](#)

## Related concepts

[Using BrightLink with a Computer](#)

[Using BrightLink Without a Computer](#)

## Using the Projected Screen as a Whiteboard (Built-in Whiteboard Mode)

You can use the interactive pens or your finger (BrightLink 695Wi) to write or draw on the projection surface just as you would on a chalkboard or dry erase board. You can use one pen, both pens at the same time, or a combination of pens and finger touch (BrightLink 695Wi).

1. Hover near or tap the board or projected image with the interactive pen or your finger (BrightLink 695Wi). Tap the whiteboard icon on the toolbar.

You see the whiteboard screen, with the main toolbar on the side and the projection control toolbar on the bottom of the screen:

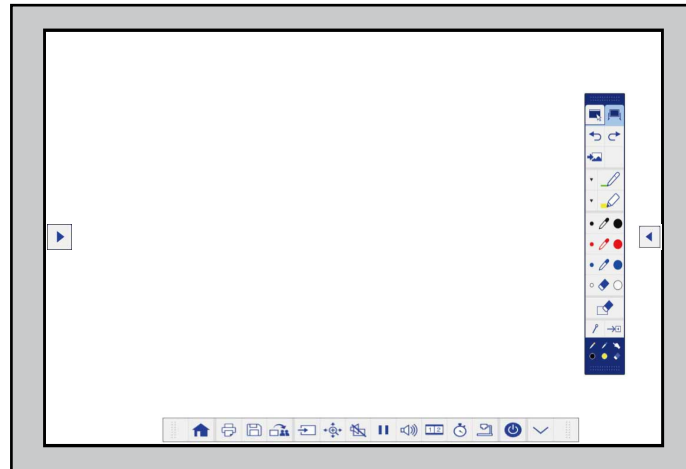

2. To move the main toolbar to the other side of the screen, tap the  arrow on the opposite side of the screen.

**Note:** You can use the pen or your finger (BrightLink 695Wi) to move the arrow icon up or down to reposition the toolbar.

3. To close the main toolbar, select the  icon at the bottom of the toolbar.

**Note:** If you want to hide the toolbar automatically after drawing, select the  icon at the bottom of the toolbar.

4. To show or hide the projection control toolbar, select the  arrow.

**Note:** You can also show or hide the projection control toolbar from the projector's Display menu.

**Parent topic:** [Interactive Modes](#)

## Drawing on a Projected Image (Built-in Annotation Mode)

You can project from a computer, tablet, video device, or other source and add notes to your projected content using the interactive pens or your finger (BrightLink 695Wi). You can use one pen, both pens at the same time, or a combination of pens and finger touch (BrightLink 695Wi).

1. Project an image from a connected device.
2. Hover near or tap the board or projected image with the interactive pen or your finger (BrightLink 695Wi). Tap the  built-in annotation mode icon on the toolbar.

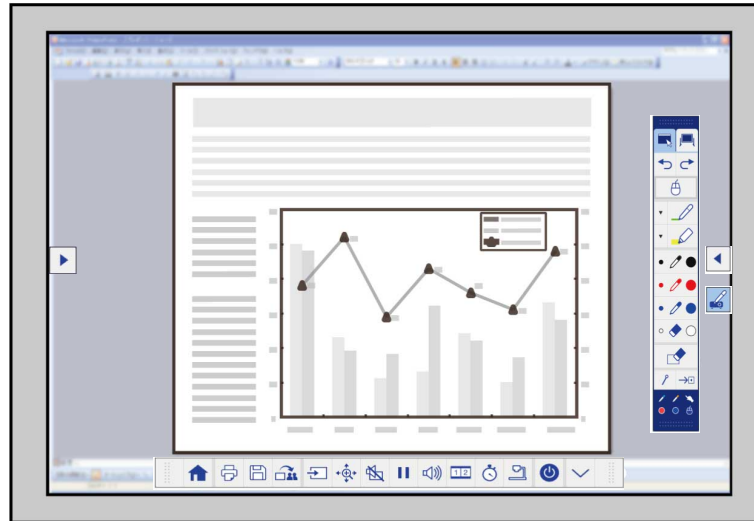

You see the main toolbar on the side and the projection control toolbar on the bottom of the projected image.



3. To move the main toolbar to the other side of the screen, tap the  arrow on the opposite side of the screen.

**Note:** You can use the pen or your finger (BrightLink 695Wi) to move the arrow icon up or down to reposition the toolbar.

4. To switch to one of the other interactive modes, do one of the following:

- To switch to built-in whiteboard mode, select .
- To switch to PC Interactive mode, select , then select .

**Note:** You can also press the **Pen Mode** button on the remote control to switch between modes.

- To close the main toolbar, select the  icon at the bottom of the toolbar.

**Note:** If you want to hide the toolbar automatically after drawing, select the  icon at the bottom of the toolbar.

- To show or hide the projection control toolbar, select the  arrow.

**Parent topic:** [Interactive Modes](#)

## Controlling Computer Features from a Projected Screen (PC Interactive Mode)

You can navigate, select, and interact with your computer programs from the projected screen using the interactive pens or your finger (BrightLink 695Wi) just as you would a mouse.

**Note:** Mac users need to install the Easy Interactive Driver before using PC Interactive mode. Go to [epson.com/support](http://epson.com/support) (U.S.) or [epson.ca/support](http://epson.ca/support) (Canada) and select your projector.

- Connect the projector to your computer using a USB cable.
- Turn on your projector and project your computer screen.
- Press the **Menu** button on the remote control, select the **Extended** menu, and press the **Enter** button.

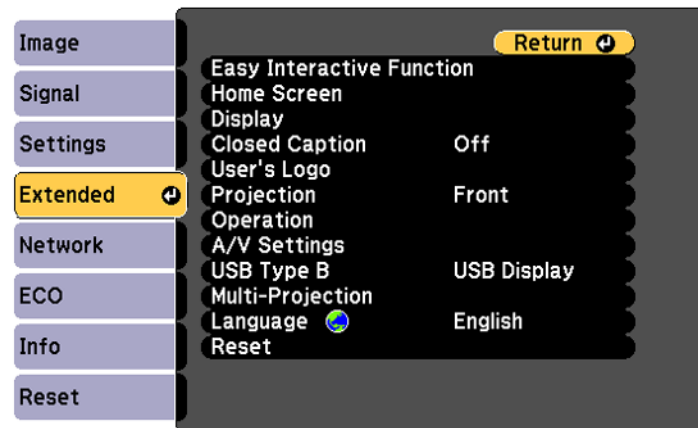



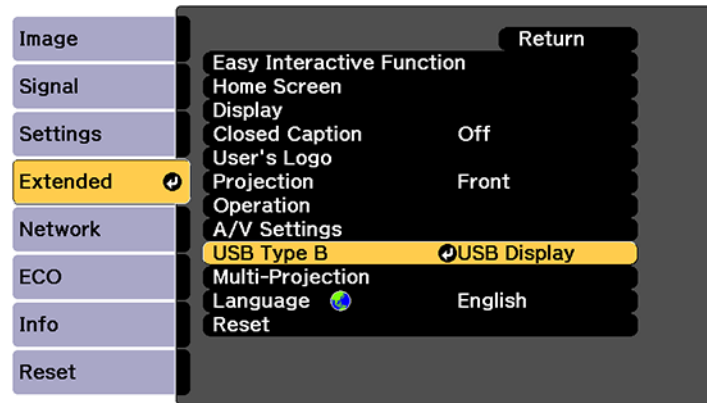

4. Select the **USB Type B** setting and press the **Enter** button.



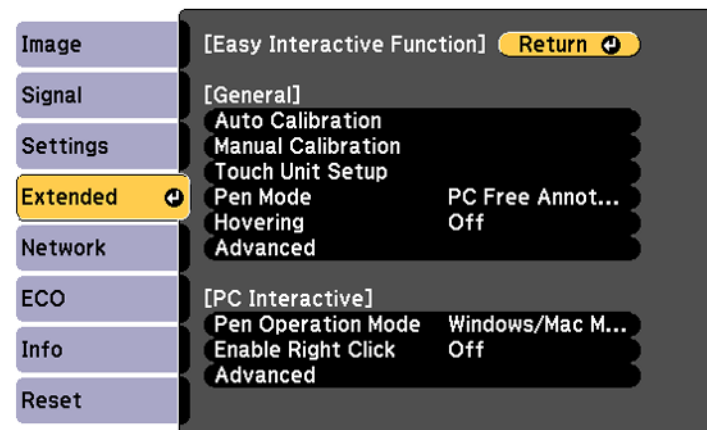

5. Select one of the following:
- **Easy Interactive Function** to use PC Interactive mode.
  - **USB Display/Easy Interactive Function** to use PC Interactive mode and USB Display.
  - **Wireless Mouse/USB Display** to use the mouse and USB Display.
6. Press the **Esc** button to exit the USB Type B menu.
7. Select the **Easy Interactive Function** setting and press the **Enter** button.



8. Select one of the following as the **Pen Operation Mode** depending on the operating system your computer is using:
  - **Windows/Mac Mode:** Windows or Mac
  - **Ubuntu Mode:** Ubuntu
9. Press the **Enter** button and press the **Menu** button to exit the Extended menu.
10. Hover near or tap on the board or the projected image with the interactive pen or your finger (BrightLink 695Wi).

The  icon is displayed on the projected screen.

11. Select the  icon, then select the  icon.

You can now operate the computer using the interactive pens or your finger (BrightLink 695Wi).

[PC Interactive Mode System Requirements](#)

**Parent topic:** [Interactive Modes](#)

**PC Interactive Mode System Requirements**

Your computer system must meet the system requirements here to use PC Interactive mode and Easy Interactive Tools.

**Note:** Easy Interactive Driver must be installed and running to use Easy Interactive Tools on a Mac.

Requirement	Windows	Mac
Operating system	Windows Vista SP2 Ultimate, Enterprise, Business, Home Premium, and Home Basic (32-bit)	OS X 10.7.x, 10.8.x, 10.9.x, 10.10.x, 10.11.x; macOS 10.12.x (QuickTime 7.7 or later required)
	Windows 8.x, Pro, Enterprise, Windows 7 SP1 Ultimate, Enterprise, Professional, Home Premium (32- and 64-bit)	
	Windows 10 Home and Pro (32- and 64bit)	
CPU	Core2 Duo 1.2 GHz or faster (Core i3 or faster recommended)	Core2 Duo 1.2 GHz or faster (Core i5 or faster recommended)
Memory	1GB or more (2GB or more recommended)	

Requirement	Windows	Mac
Hard disk space	100MB or more	
Display	Resolution between 1024 × 768 and 1920 × 1200, 16-bit color or greater	

**Parent topic:** [Controlling Computer Features from a Projected Screen \(PC Interactive Mode\)](#)

**Related concepts**

[Easy Interactive Tools](#)

## Using the Interactive Pens

Follow the instructions in these sections to use the interactive pens.

[Using the Pens](#)

[Pen Calibration](#)

**Parent topic:** [Using the Interactive Features](#)

## Using the Pens

Your projector came with a blue pen and an orange pen, identified by the color on the end of the pen. You can use either pen, or both pens at the same time (one of each color), with Easy Interactive Tools.

Make sure the pen batteries are installed.

**Note:** The pen turns off automatically after 15 seconds of inactivity. Hold the pen to turn the pen back on.

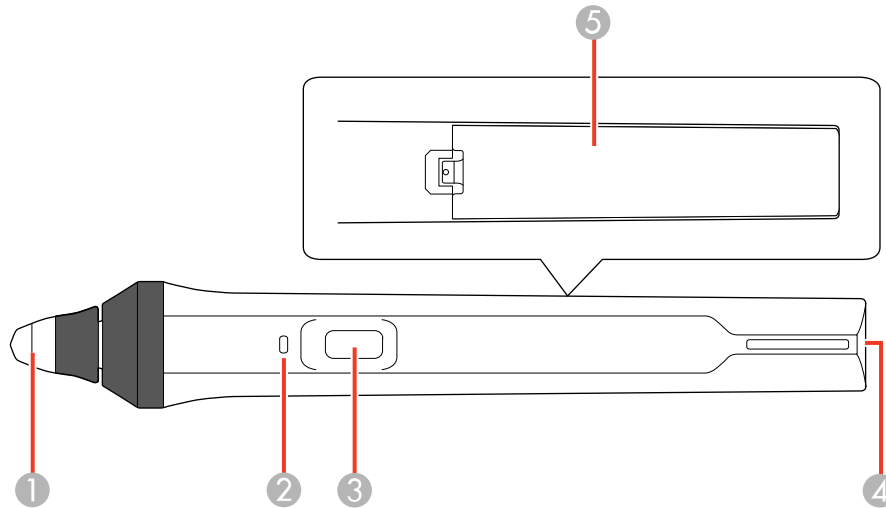

- 1 Pen tip
- 2 Battery light
- 3 Function button
- 4 Attachment for optional strap or cord
- 5 Battery cover

- To turn on the pen, move the pen.

**Note:** If you press the function button, the battery light flashes briefly, then turns off. If the battery is low, the battery light flashes continuously.

- For best performance, hold the pen perpendicular to the board, as shown below. Do not cover the black section near the tip of the pen.

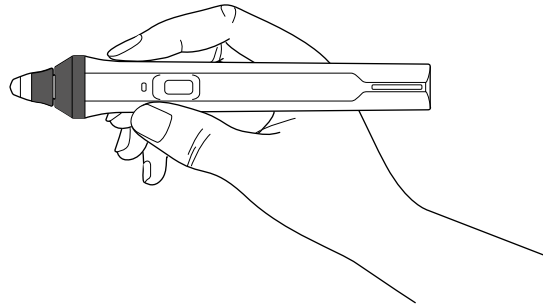

- To write or draw on the projection surface in built-in annotation mode or built-in whiteboard mode, do the following:

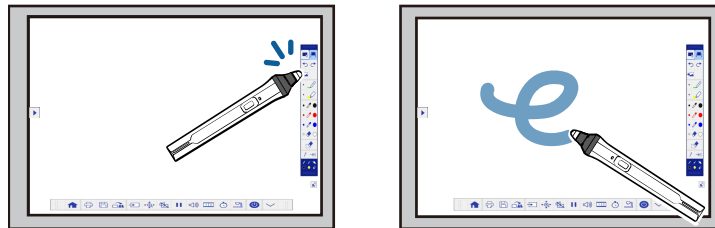

- To select a projected item, such as an icon, tap the projection surface with the pen tip.
- To draw on the projected screen, tap the projection surface with the pen and drag it as necessary.
- To move the pointer, hover over the surface without touching it.
- To switch the pen from drawing tool to eraser, press the button on the side.

**Note:** You can change the function of the button by changing the **Pen Button Function** setting in the Extended menu.

- To use the pen as a mouse in PC Interactive mode, do the following:



- To left-click, tap the board with the pen tip.
- To double-click, tap twice.
- To right-click, press the button on the side.
- To click and drag, tap and drag with the pen.
- To move the cursor, hover over the board without touching it.

**Note:** You can turn off the hovering feature using the **Hovering** setting in the projector's Easy Interactive Function menu.

**Note:** To make a long press of the pen act as a right-click, set the **Pen Operation Mode** setting to **Ubuntu Mode** and turn on the **Enable Right Click** setting.

**Parent topic:** [Using the Interactive Pens](#)

#### **Related references**

[Projector Setup Settings - Extended Menu](#)

#### **Related tasks**

[Installing Batteries in the Pens](#)

## **Pen Calibration**

Calibration coordinates the position of the pen with the location of your cursor. You only need to calibrate the first time you use your projector's interactive features. Calibration results remain until you calibrate again.

Be sure to calibrate the pen before performing finger touch calibration (BrightLink 695Wi).

If you notice positioning discrepancies after doing any of the following, calibrate again:

- Performing Geometry Correction
- Adjusting the image size
- Using the Image Shift feature
- Moving the projector

**Note:** Move any pen you are not using away from the projection screen while calibrating.

[Calibrating Automatically](#)

[Calibrating Manually](#)

**Parent topic:** [Using the Interactive Pens](#)

### Calibrating Automatically

You do not need the pens or a computer for Auto Calibration.

**Note:** You can start Auto Calibration by pressing the **User** button on the remote control or by pressing the **Menu** button on the remote control as described here.

1. Press the **Menu** button, select the **Extended** menu, and press **Enter**.

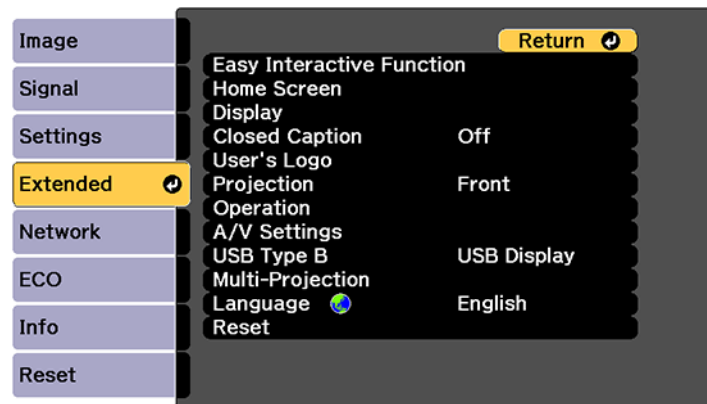

2. Select the **Easy Interactive Function** setting and press **Enter**.

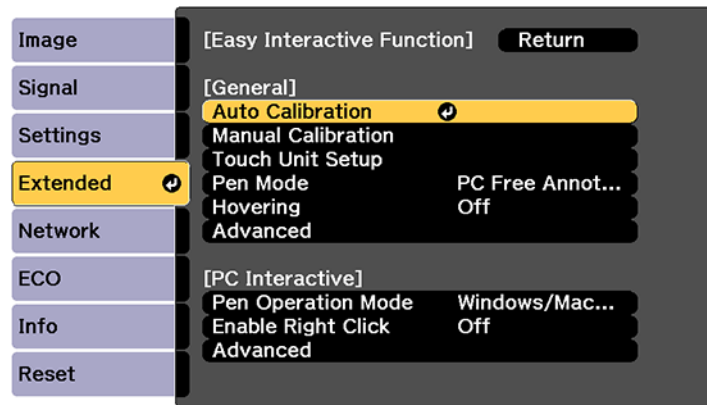

3. Select **Auto Calibration** and press **Enter**.

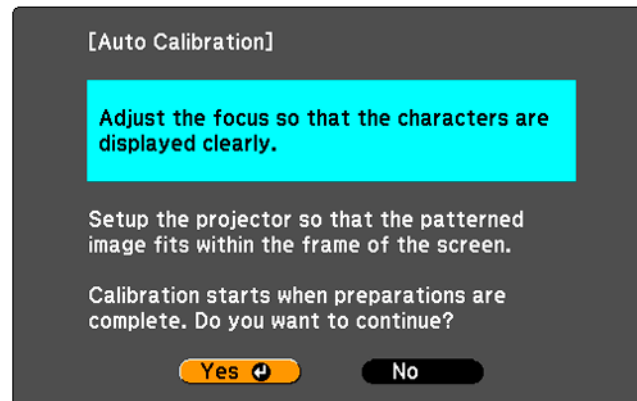

4. Adjust the image focus, if necessary.

5. Press **Enter** to select **Yes**.

A pattern appears then disappears, and the system is calibrated. If you see a message that calibration failed, you need to calibrate manually.

The cursor location and pen position should match after calibration. If not, you may need to calibrate manually.



Parent topic: [Pen Calibration](#)

### Related tasks

[Calibrating Manually](#)

[Focusing the Image](#)

## Calibrating Manually

If the cursor location and pen position do not match after auto calibration, you can calibrate manually.

1. Press the **Menu** button, select the **Extended** menu, and press **Enter**.

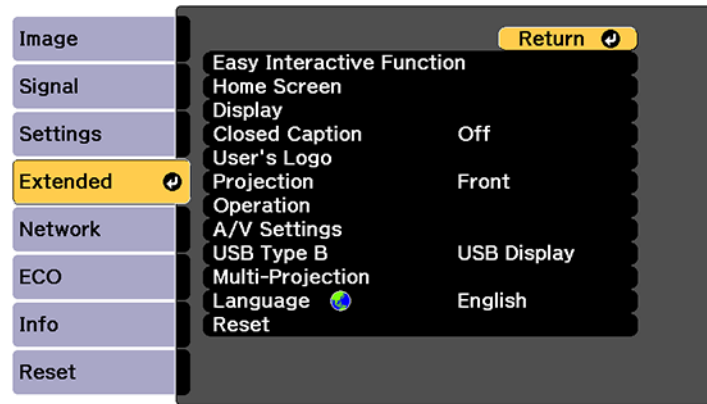

2. Select the **Easy Interactive Function** setting and press **Enter**.

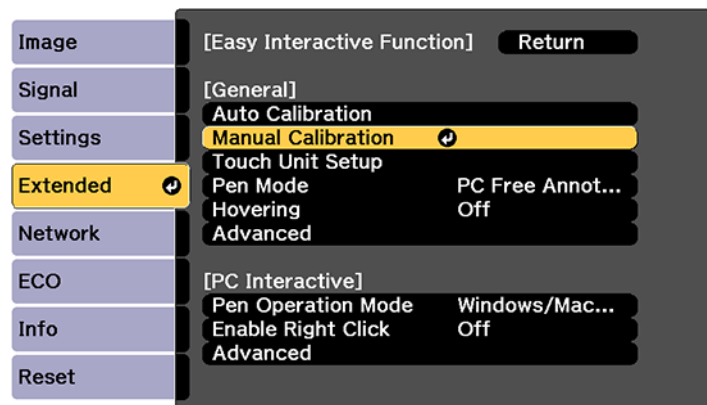

3. Select **Manual Calibration** and press **Enter**.

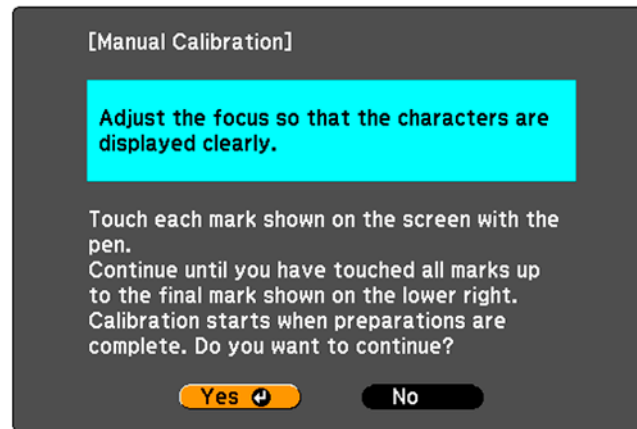

4. Adjust the image focus, if necessary.
5. Press **Enter** to select **Yes**.  
A flashing green circle appears in the upper left corner of your projected image.
6. Touch the center of the circle with the tip of the pen.  
The circle disappears, and you see another circle below the first one.

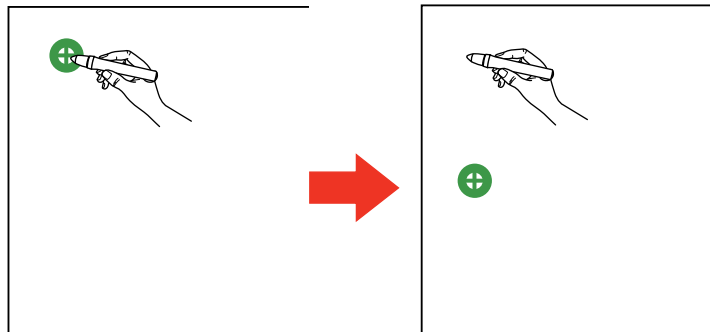

**Note:** For the most accurate calibration, make sure you touch the center of the circle.

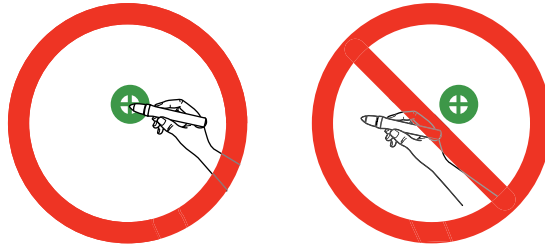

**Note:** Make sure you are not blocking the signal between the pen and the interactive receiver (next to the projection window on the projector).

7. Touch the center of the next circle, then repeat. When you get to the bottom of the column, the next circle appears at the top of a new column.

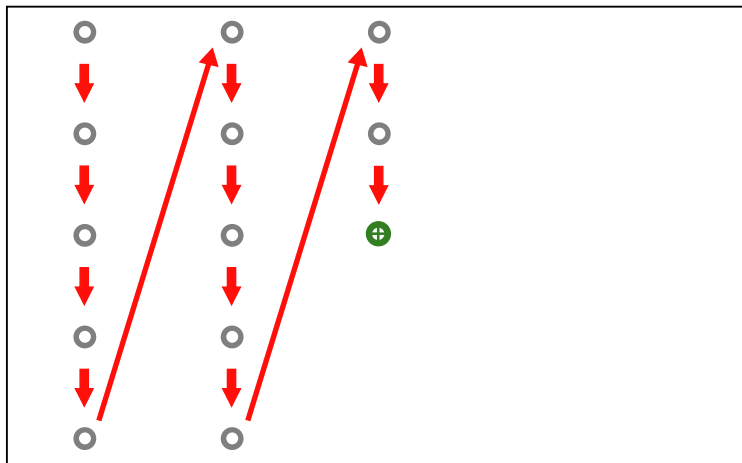

**Note:** If you make a mistake, press the **Esc** button on the remote control to go back to the previous circle. To restart the calibration process, press and hold the **Esc** button for 2 seconds.

8. Continue until all of the circles disappear.

**Parent topic:** [Pen Calibration](#)

### Related tasks

[Focusing the Image](#)

[Calibrating Automatically](#)

## Using Finger Touch Interactivity

You can use your finger to perform the same functions as the interactive pens when you install the Touch Unit (BrightLink 695Wi).

**Note:** See the *Touch Unit and Control Pad Installation Guide* for detailed instructions on installing the Touch Unit and calibrating for finger touch interactivity (BrightLink 695Wi).

[Touch Unit Safety Instructions](#)

[Calibrating for Finger Touch Interactivity](#)

[Using Finger Touch Operations](#)

**Parent topic:** [Using the Interactive Features](#)

## Touch Unit Safety Instructions

The Touch Unit enables finger touch interactivity with your projector (BrightLink 695Wi). Do not connect it to any other projectors or devices.

A built-in, high-power laser is emitted from the laser diffusion ports on the back of the Touch Unit.

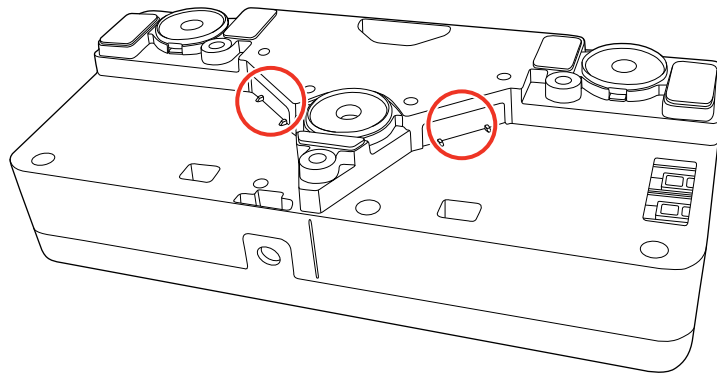

Follow these precautions when using the Touch Unit and finger touch interactivity:

- Children using finger touch interactivity should always be accompanied by an adult.
- Never disassemble or modify the Touch Unit. Never open any cases on the projector or Touch Unit. Electrical voltages inside the projector can cause severe injury.
- Do not look into the laser diffusion ports on the back of the Touch Unit. The laser can damage your eyes. Extra care should be taken when children are present.
- Do not allow the laser light from the Touch Unit to pass through or be reflected by any optical devices, such as a magnifying glass or mirror. This could cause personal injury or fire.
- Do not view the laser light from the Touch Unit using an optical device such as an eye loupe, magnifying glass, or microscope, especially within 2.75 inches (70 mm) of the laser diffusion ports. This could damage your eyes.
- Unplug the projector from the electrical outlet and refer all repairs to qualified service personnel if any problems occur with the Touch Unit. Continued use of the Touch Unit may result in fire or accidents, and can also damage your eyes.

The Touch Unit is a Class 1 laser product that complies with IEC/EN60825-1:2007. The labels indicating the Class 1 laser product and warnings are located in the following areas on the Touch Unit:

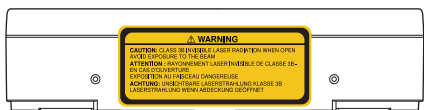
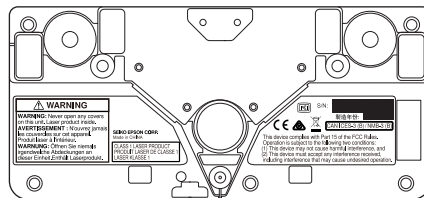
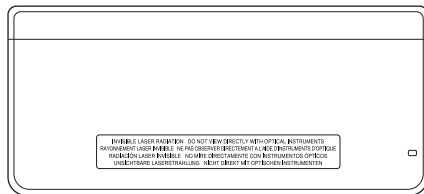

Parent topic: [Using Finger Touch Interactivity](#)

## Calibrating for Finger Touch Interactivity

Finger touch calibration coordinates the positioning of your finger with the location of the cursor (BrightLink 695Wi).

**Note:** Make sure you have calibrated the pens before calibrating for finger touch interactivity.

1. Press the **Menu** button, select the **Extended** menu, and press **Enter**.

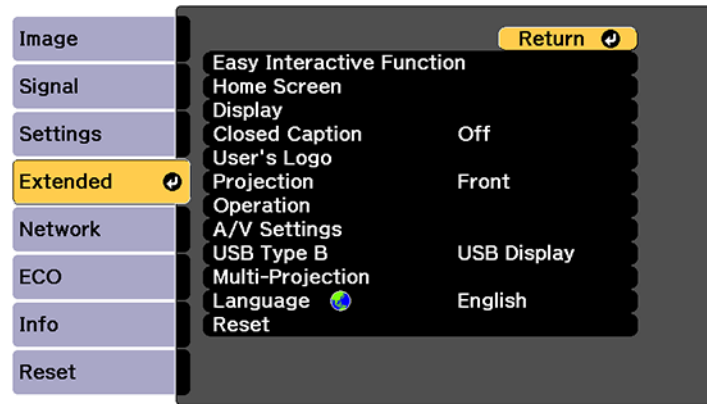

2. Select the **Easy Interactive Function** setting and press **Enter**.

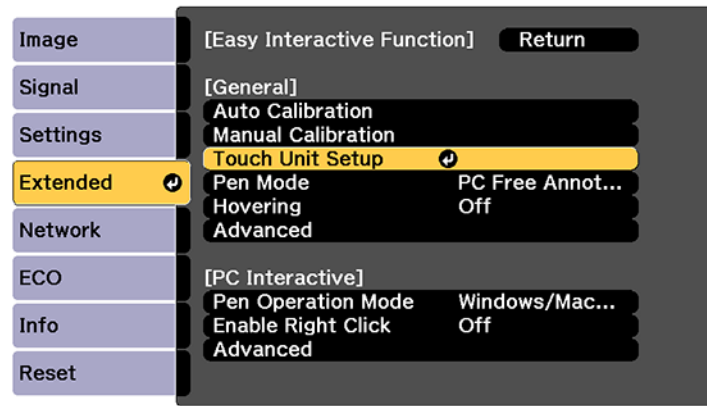

3. Select **Touch Unit Setup** and press **Enter**.

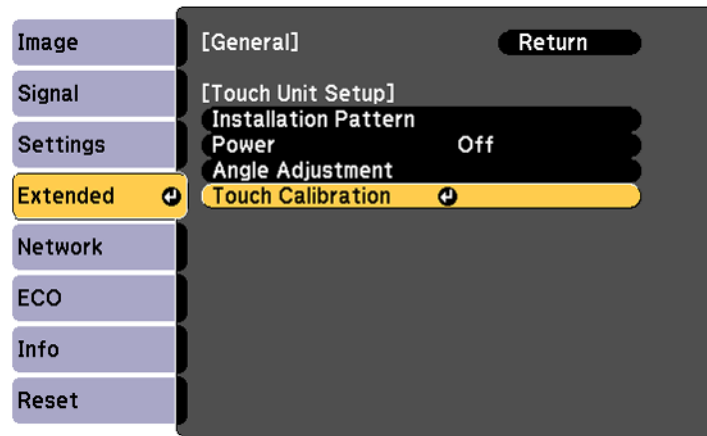

4. Select **Touch Calibration** and press **Enter**.

The following screen appears:

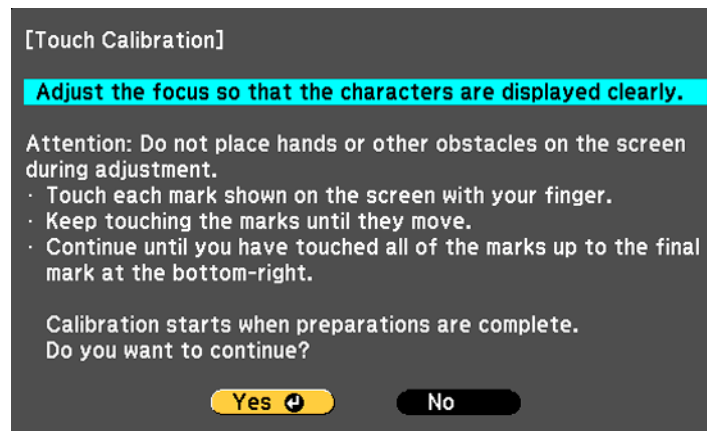

5. Adjust the image focus, if necessary.
6. Press **Enter** to select **Yes**.  
A flashing green circle appears in the upper left corner of your projected image.

7. Touch and hold the center of the circle with your finger until the circle disappears and another circle appears, then release it.

The circle disappears, and you see another circle below the first one.

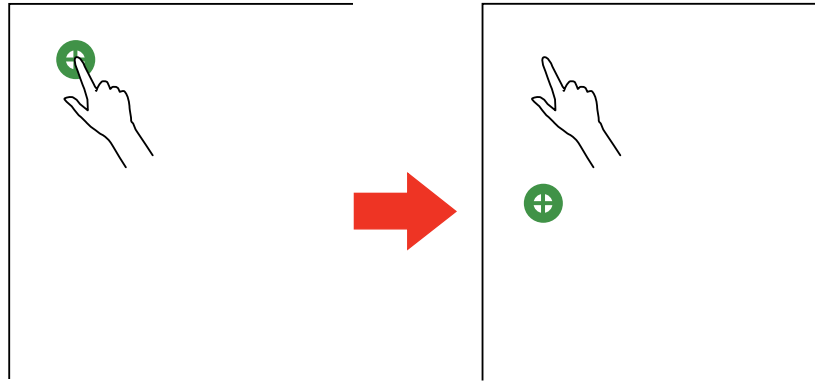

**Note:** For the most accurate calibration, make sure you touch the center of the circle with the tip of your finger.

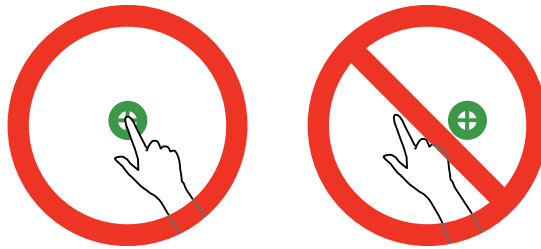

**Note:** Make sure you are not blocking the signal between your finger and the interactive receiver (next to the projection window on the projector).

8. Touch the center of the next circle with your finger and continue until all of the circles disappear.



When you get to the bottom of a column, the next circle appears at the top of a new column.

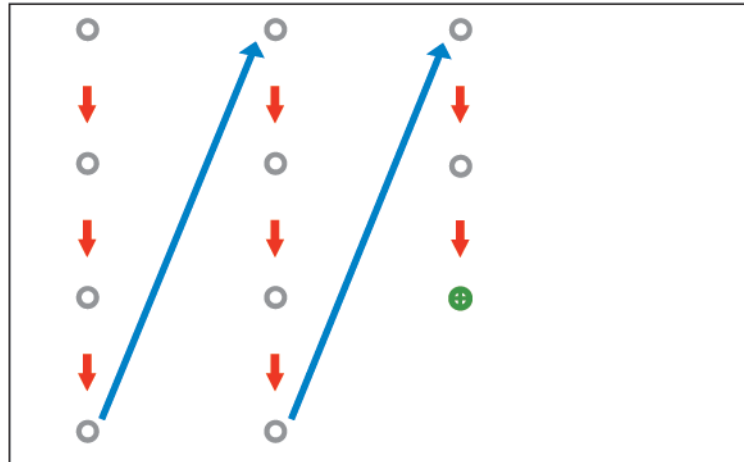

**Note:** If you make a mistake, press the **Esc** button on the remote control to go back to the previous circle. To restart the calibration process, press and hold the **Esc** button for 2 seconds.

9. If the cursor location and your finger position do not match, repeat these steps to calibrate again.

**Parent topic:** [Using Finger Touch Interactivity](#)

**Related tasks**

[Focusing the Image](#)

[Calibrating Automatically](#)

[Calibrating Manually](#)

## Using Finger Touch Operations

You can use your finger to interact with the projected screen, just as you would use an interactive pen (BrightLink 695Wi). You can use either a pen or your finger, or use both at the same time.

When performing touch operations with your finger, you can use two fingers in built-in annotation and whiteboard modes.

1. Install the Touch Unit as described in the *Touch Unit and Control Pad Installation Guide*.
2. Calibrate the pens.

3. Adjust the angle of the Touch Unit as described in the *Touch Unit and Control Pad Installation Guide*.
4. Calibrate for finger touch interactivity.
5. Turn on your projector. This automatically turns on the Touch Unit also.  
The blue light on the Touch Unit remains lit.

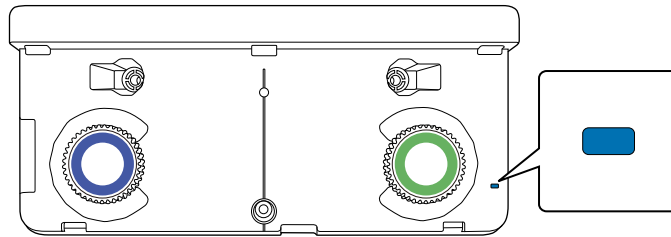

6. To write or draw on the projection surface in built-in annotation mode or built-in whiteboard mode, do the following:

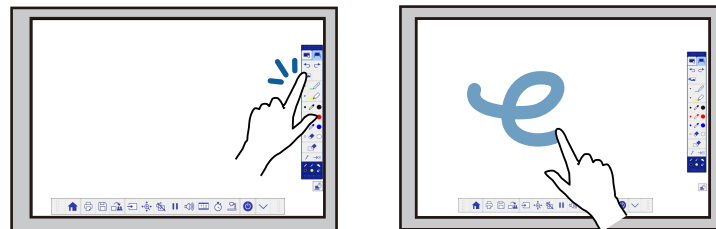

- To select a projected item, such as an icon, tap the projection surface with your finger.
  - To draw on the projected screen, tap the projection surface with your finger and drag it as necessary.
7. To use your finger as a mouse in PC Interactive mode, do the following:
    - To left-click, tap the board with your finger.
    - To double-click, tap twice with your finger.
    - To right-click, press the board with your finger for about 3 seconds.
    - To click and drag, press on and drag an item with your finger.

- To scroll, drag your finger on the screen.



8. If your operating system supports these functions, you can also do the following:
- To zoom in or out, touch an item using two fingers and either move your fingers away from each other (zoom in) or toward each other (zoom out).
  - To rotate an image, touch the image with your fingers and rotate your hand.
  - To drag up or down on a page, or move backward or forward in a browser window, use swiping gestures or flicks.

**Note:** Finger touch operations may not work correctly with long or artificial nails, or fingers wearing bandages. If your fingers are too close together or crossed, or your sleeve or free hand touches the screen, finger touch may not be recognized. Some operating systems may not support gestures.

**Parent topic:** [Using Finger Touch Interactivity](#)

**Related references**

[Touch Unit Safety Instructions](#)

**Related tasks**

[Calibrating for Finger Touch Interactivity](#)

[Calibrating Automatically](#)

[Calibrating Manually](#)

## Using BrightLink with a Computer

You can connect a computer to the projector and install the software from the Easy Interactive Function CD. You can then do the following:

- Use the pens or your finger (BrightLink 695Wi) as a mouse to control your computer

- Use the Easy Interactive Tools software to annotate with both pens or a combination of pen and finger touch (BrightLink 695Wi) at the same time

**Note:** See the online *Easy Interactive Tools Operation Guide* for detailed information.

- Save and print your annotations
- Use the Tablet PC input panel in Windows 10, 8.x, Windows 7, or Windows Vista
- Use Ink Tools for annotation in Microsoft Office (2003 or later) applications

[Adjusting the Pen Operation Area](#)

[Easy Interactive Tools](#)

**Parent topic:** [Using the Interactive Features](#)

## Adjusting the Pen Operation Area

If you connect a different computer or adjust the computer's resolution, the pen operation area is adjusted automatically to match your mouse pointer position. If you notice that the pen position is incorrect when using PC Interactive mode, you can adjust the pen area manually.

1. Project your computer's desktop.
2. Press the **Menu** button, select the **Extended** menu, and press **Enter**.

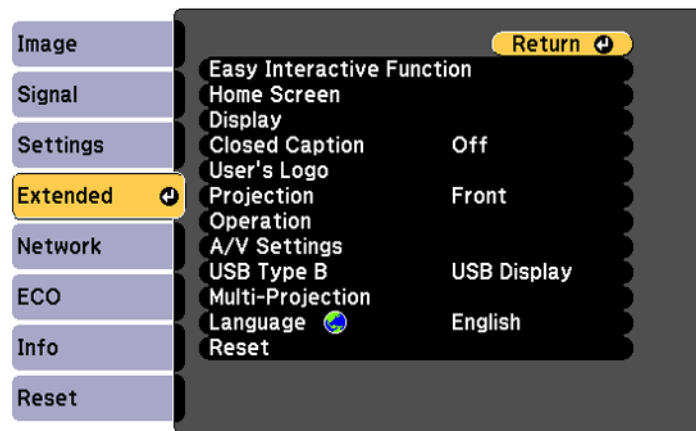

3. Select the **Easy Interactive Function** setting and press **Enter**.

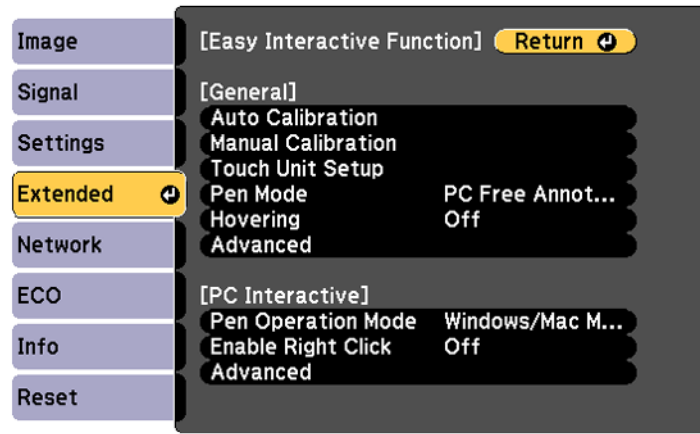

4. Select **Advanced** in the PC Interactive section and press **Enter**.

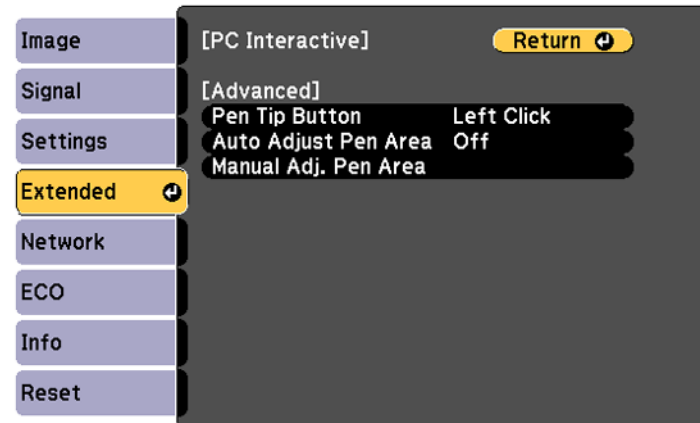

5. Select **Manual Adj. Pen Area** and press **Enter**.

You see this screen:

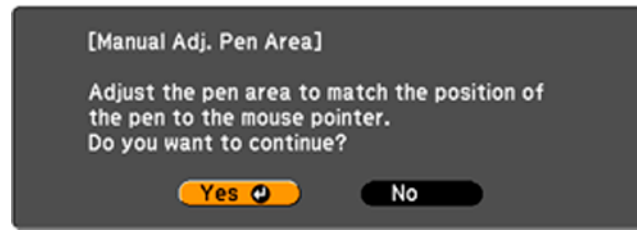

6. Press **Enter** to select **Yes**.  
The mouse pointer moves toward the top left corner.
7. When the mouse pointer stops at the top left corner of the image, touch the tip of the pointer with the interactive pen.  
The mouse pointer moves toward the bottom right corner.
8. When the mouse pointer stops at the bottom right corner of the image, touch the tip of the pointer with the interactive pen.

**Parent topic:** [Using BrightLink with a Computer](#)

## Easy Interactive Tools

Your projector came with a CD containing the Easy Interactive Tools software for use with a computer. Easy Interactive Tools lets you use your interactive pen or finger (BrightLink 695Wi) as a mouse to navigate, select, scroll, draw, save, and interact with projected content from your computer.

These two modes are available:

- Annotation (PC interactive) mode displays the toolbar on the projected image and lets you use the pen or finger (BrightLink 695Wi) as a mouse to open applications, access links, and operate scroll bars, for example (using one pen at a time). You can also annotate whatever is displayed from your computer (using both pens at the same time).
- Whiteboard mode lets you project on one of 3 solid colors or 6 background patterns, and use the toolbar to write or draw on the background. You can also import images from your computer or a document camera. In full screen whiteboard mode, two people can use the pens at the same time. Finger touch is also available in whiteboard mode. (BrightLink 695Wi)

**Note:** For detailed instructions on using the Easy Interactive Tools software, see the online *Easy Interactive Tools Operation Guide* or the online help.

Parent topic: [Using BrightLink with a Computer](#)

## Windows Pen Input and Ink Tools

If you are using Windows 10, 8.x, Windows 7, or Windows Vista, you can use the pen input and Ink tools to add input and annotations to your work. You can also use these features over a network when you set the interactive features to be available on your network. See the *EasyMP Multi PC Projection Operation Guide* for instructions on setting up your computer for network projection.

[Enabling Windows Pen Input and Ink Tools](#)

[Using Windows Pen Input and Ink Tools](#)

Parent topic: [Using the Interactive Features](#)

## Enabling Windows Pen Input and Ink Tools

To use the pen input and Ink tools in Windows 10, 8.x, Windows 7, or Windows Vista, you need to adjust the pen operation mode in your projector's menus.

1. Press the **Menu** button, select the **Extended** menu, and press **Enter**.

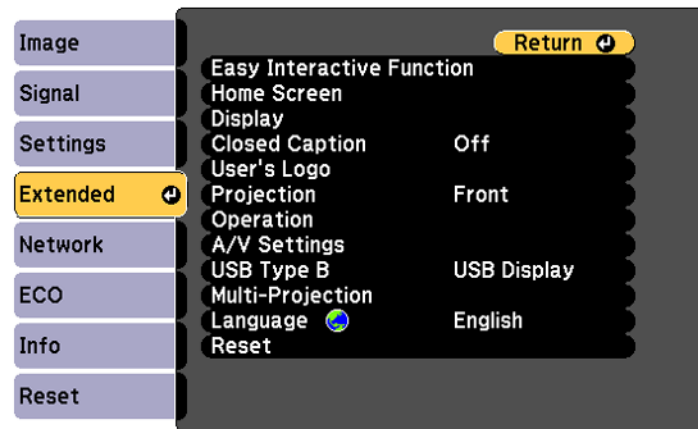

2. Select the **Easy Interactive Function** setting and press **Enter**.

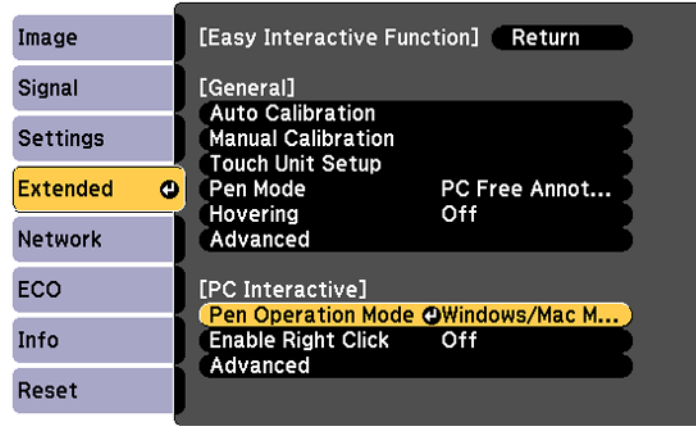

3. Select **Pen Operation Mode** and press **Enter**.
4. Select **Windows/Mac Mode** and press **Enter**.

Parent topic: [Windows Pen Input and Ink Tools](#)

## Using Windows Pen Input and Ink Tools

If you are using Windows 10, Windows 8.x, Windows 7, or Windows Vista, you can add handwritten input to your work and convert it to text.

If you have Microsoft Office 2003 or later, you can also use the Ink function to add handwritten notes to a Word document, Excel spreadsheet, or PowerPoint presentation.

**Note:** Option names for the annotation functions may vary depending on your version of Microsoft Office.

- To open the Touch Keyboard in Windows 10, right-click or tap-and-hold on the Taskbar, and select **Show touch keyboard button**. Select the keyboard icon on the screen.
- To open the Touch Keyboard in Windows 8.x, right-click or tap-and-hold on the Taskbar, and select **Toolbars > Touch Keyboard**. Select the keyboard icon on the screen and select the pen icon.



- To open the Tablet PC input panel in Windows 7 or Windows Vista, select  > **All Programs > Accessories > Tablet PC > Tablet PC Input Panel.**

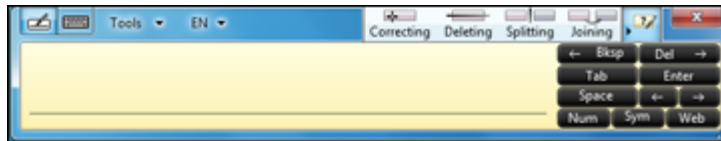

You can write in the box using the interactive pen or your finger (BrightLink 695Wi), and select from a variety of options to edit and convert the text.

- To add Ink annotations in Microsoft Office applications, select the **Review** menu, and select **Start Inking.**

**Note:** In Microsoft Word or Excel, select the **Insert** tab and select **Start Inking.**

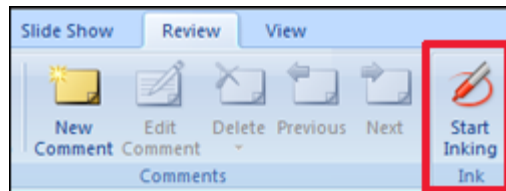

- To annotate your PowerPoint slides in Slideshow mode, press the button on the side of the interactive pen or press the projection surface with your finger (BrightLink 695Wi) for about 3 seconds, and select **Pointer Options > Pen** from the pop-up menu.

**Note:** This also works in Windows XP Tablet PC Edition.

For more information about these features, see Windows Help.

**Parent topic:** [Windows Pen Input and Ink Tools](#)

## Using BrightLink Without a Computer

You can use the pens or your finger (BrightLink 695Wi) to write or draw on the projection surface simultaneously without connecting a computer (PC Free annotation). This lets you annotate images from a document camera, iPad, DVD player, or other source.

These two modes are available:

- Built-in annotation mode displays the built-in toolbar on whatever image is being projected from a document camera, iPad, or other source.
- Built-in whiteboard mode lets you project a white or black screen or one of 4 background patterns, and use the toolbar to write or draw as you would on a chalkboard or dry erase board.

[Using the Built-in Annotation Mode](#)

[Built-in Tools for Use Without a Computer](#)

[Using the Built-in Whiteboard Mode](#)

[Changing Pen Width and Color Using the Built-in Toolbar](#)

[Projector Control Toolbar](#)

[Selecting a Networked Device Source](#)

[Splitting the Screen](#)

[Interactive Features when Projecting with Two Projectors](#)

**Parent topic:** [Using the Interactive Features](#)

## Using the Built-in Annotation Mode

You can use either pen with the built-in toolbar, both pens at the same time, your finger (BrightLink 695Wi), or a combination of both pen and finger (BrightLink 695Wi).

1. Select the source for the image you want to annotate. If you simply want to use a blank screen, select another unused source.
2. To activate the toolbar, tap the projection surface with the pen or your finger (BrightLink 695Wi).

You see  arrow icons on the left and right side of the projected image.

**Note:** The toolbar arrows disappear if they are not used. To make them reappear, tap the projection surface with the pen or your finger (BrightLink 695Wi).

3. To display the toolbar, select one of the  arrows.

**Note:** You can use the pen or your finger (BrightLink 695Wi) to move the arrows up or down.

4. To close the toolbar, select the  icon at the bottom of the toolbar.

**Note:** If you want to hide the toolbar automatically after drawing, select the  icon at the bottom of the toolbar.







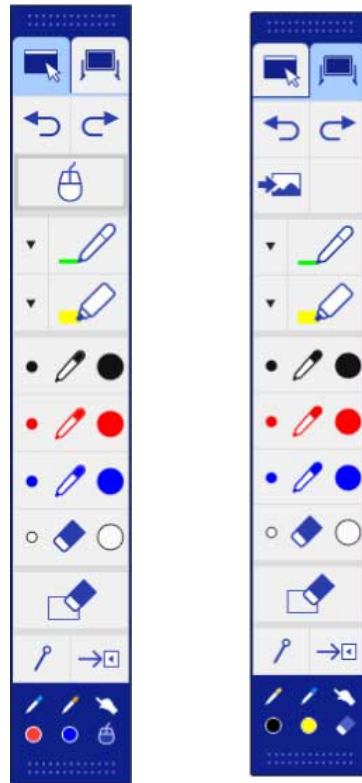

**Parent topic:** [Using BrightLink Without a Computer](#)





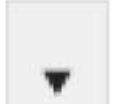

## Built-in Tools for Use Without a Computer

The built-in toolbar is embedded in the projector and allows you to draw and write on the projected screen.

In the following illustration, the annotation mode tools are shown on the left, and the whiteboard mode tools on the right:



	Switch to built-in annotation mode
	Switch to built-in whiteboard mode
	Undo the last annotation
	Redo the last undo
	Switch to the computer interactive mode
	Select a white or black background or one of 4 patterns (whiteboard mode only)
	Change custom pen or highlighter color and width
	Write or draw free-form lines with custom pen
	Write or draw free-form lines with transparent highlighter pen

	Black pen (fine point on left, thick on right)
	Red pen (fine point on left, thick on right)
	Blue pen (fine point on left, thick on right)
	Eraser (thin width on left, thick on right)
	Clear all annotations
	Hide the toolbar after each annotation
	Close the toolbar

Parent topic: [Using BrightLink Without a Computer](#)

## Using the Built-in Whiteboard Mode



In built-in whiteboard mode, you can project a solid or patterned background, and then write or draw on it as you would on a chalkboard or dry erase board.

1. Select the  Whiteboard tool on the built-in toolbar.  
You see a white background.

2. If you want to change the background, do the following:

- Select the  Background tool.
- Select a black background or one of 4 different patterns.
- Select the right arrow icon to close the selection window.

3. Do one of the following to write or draw on the background.

- To erase, select the  Eraser tool.
- To clear the whole screen, select the  Clear all tool.



**Parent topic:** [Using BrightLink Without a Computer](#)

## Changing Pen Width and Color Using the Built-in Toolbar

When you use the  custom pen or highlighter tools, you can select different colors and line widths.

**Note:** You can also select the Black, Red, or Blue pen on the toolbar, and select the small circle on the left of the pen for a thin line, or the large circle on the right for a thick line.

**Note:** When multiple users draw on the projected screen using multiple pens, you can select different colors and line widths for each pen. When using finger touch operations (BrightLink 695Wi), all users share the same color and line width.









1. Select the  arrow next to the  custom Pen or  Highlighter pen on the toolbar.
2. Select the color and line width you want.
3. Select the right arrow icon to close the selection window.













**Parent topic:** [Using BrightLink Without a Computer](#)

## Projector Control Toolbar

The projector control toolbar lets you control the projector with your pen or finger (BrightLink 695Wi) from the projected screen just as you would using the remote control.



	Display the Home screen.
	Print the projected image
	Save the projected image to a connected USB storage device
	Share the projected image using EasyMP Multi PC Projection or Epson iProjection
	Change the image source using a displayed list. (To close the image source list, select the arrow icon at the bottom of the list.)
	Zoom into and out of the image
	Turn off the picture and sound
	Pause video action
	Increase or decrease the volume

	Project two images from different image sources
	Set the timer
	<p>Display the document camera control toolbar. (Not all settings may be available depending on your document camera model.)</p> <ul style="list-style-type: none"> <li>•  : Automatically focus the document camera image; make sure you enable this setting before you zoom into or out of the document camera image</li> <li>•  : Pause video action</li> <li>•  : Zoom into or out of the image</li> <li>•  : Rotate the image 180 degrees</li> <li>•  : Capture the image</li> <li>•  : Start or stop video recording</li> <li>•  : Play recorded video</li> <li>•  : Close the document camera control toolbar</li> </ul>
	Turns off the projector.
	Close the projector control toolbar

Parent topic: [Using BrightLink Without a Computer](#)



## Related tasks

[Turning On the Projector](#)

[Controlling the Volume with the Volume Buttons](#)

[Starting a PC Free Movie Presentation](#)

[Resizing the Image with the Wide and Tele Buttons](#)

[Selecting an Image Source](#)

## Selecting a Networked Device Source

You can project an image from up to 50 devices connected to the projector via a network. You can select the image source from computers running EasyMP Multi PC Projection or Epson iProjection, and smartphones or tablets running Epson iProjection.

1. Select the  Source Select icon on the projector control toolbar.

You see an image source list:

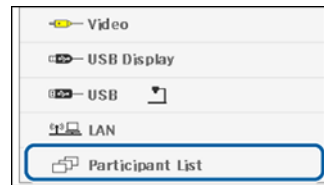

2. Select **Participant List**.

You see a list of available devices. The icon next to a user name indicates the currently selected source.

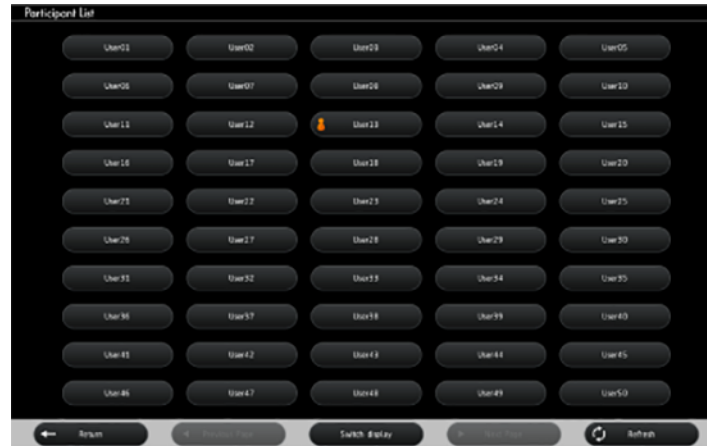

3. Select the user name for the device from which you want to project.

**Note:** Select **Refresh** to update the user list.

4. Select **Return**.

You see the screen image from the selected device.

While the user selection screen is displayed, you cannot do the following:

- Select a different image source
- Use other interactive features
- Control the projector from the bottom toolbar
- Connect to multiple projectors
- Hear sound from the projector
- Project an image using EasyMP Multi PC Projection or Epson iProjection

**Parent topic:** [Using BrightLink Without a Computer](#)

## Splitting the Screen

You can split the screen and project from two sources at the same time. You can annotate and interact with both sources.

1. Select the  Split tool on the bottom toolbar.

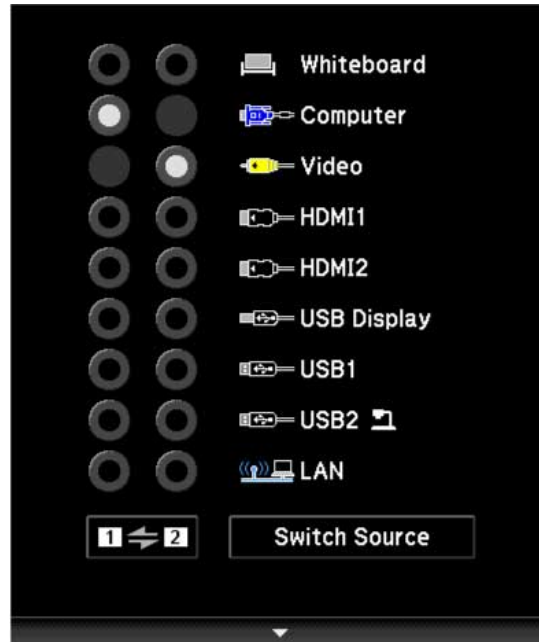

You see a screen like this:



2. Select the two sources you want to display. (Not all combinations of sources are valid.)

**Note:** If you want to write on a blank screen, select any unused source. Unused sources display the color selected in the **Display Background** setting. The **Logo** option will display a blue background.

3. Press the **Switch Source** button to display the two sources.

4. Do any of the following as necessary:
  - To change to a different source at any time, press the **Menu** button on the remote control and select **Source**, or press the  Split icon on the bottom toolbar.
  - To use PC interactive mode on the right screen, press the **Menu** button on the remote control, select **Target Pen Mode**, and select **Screen Right**. Set the **Pen Mode** setting to **PC Interactive**.  
  
**Note:** If you select **Video**, **USB1**, or **USB2** as a source, you cannot use PC interactive mode.
  - To reverse the left and right images, press the **Menu** button on the remote control and select **Swap Screens**.
  - To make one image larger, press the **Menu** button on the remote control, select **Screen Size**, and select **Larger Left** or **Larger Right**.
5. To return to displaying one image, press the **Esc** button on the remote control, or press the  Split Screen icon on the bottom toolbar.

The following operations cannot be performed during split screen projection:

- Menu settings
- E-Zoom
- Switching aspect mode
- Operations made by the **User** button on the remote control
- Auto Iris
- Light Optimizer
- Image Processing
- Freeze (if one screen is displaying the whiteboard)

[Selecting Interactive Split Screen Settings](#)

**Parent topic:** [Using BrightLink Without a Computer](#)

#### **Related references**



[Input Sources for Split Screen Projection](#)

#### **Related tasks**

[Projecting Two Images Simultaneously](#)

## Selecting Interactive Split Screen Settings

You can select split screen projection settings using the projector control toolbar.

1. Select the  Split tool on the bottom toolbar.
2. Select the  tab.

You see a screen like this:

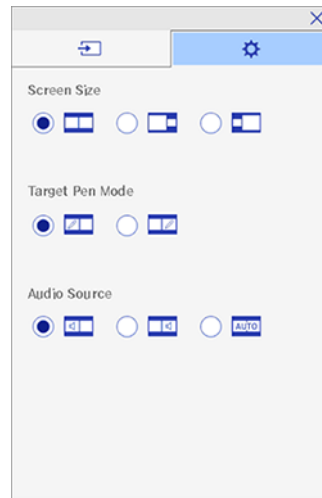

3. Do any of the following as necessary:
  - To make one image larger than the other, select a **Screen Size** setting.
  - To use the interactive pen as a mouse with a computer source, select a **Target Pen Mode** setting.
  - To select the audio from either screen, select an **Audio Source** setting. Select **Auto** to hear audio from the left screen or larger screen.
4. Select the  icon to exit the settings screen.

**Parent topic:** [Splitting the Screen](#)

## Interactive Features when Projecting with Two Projectors

You can use your projector's interactive features while projecting with two projectors installed side by side. To get started, install the software from the Easy Interactive Function CD.

See the installation guide that came with your projector mount for detailed instructions on installing multiple projectors and making the necessary settings for the interactive features.

**Note:** You may not be able to write and draw across the border of the images.

[Using Interactive Features Temporarily on One Projector](#)

**Parent topic:** [Using BrightLink Without a Computer](#)

### Using Interactive Features Temporarily on One Projector

When you use the interactive features on an image projected by two side-by-side projectors, you can temporarily limit the interactive features to one of the projectors. This setting is only available on the Home screen.

1. Press the **Home** button on the remote control or projector or the  icon on the bottom toolbar.

You see a screen like this:



2. Press the  icon.

You see a screen like this:

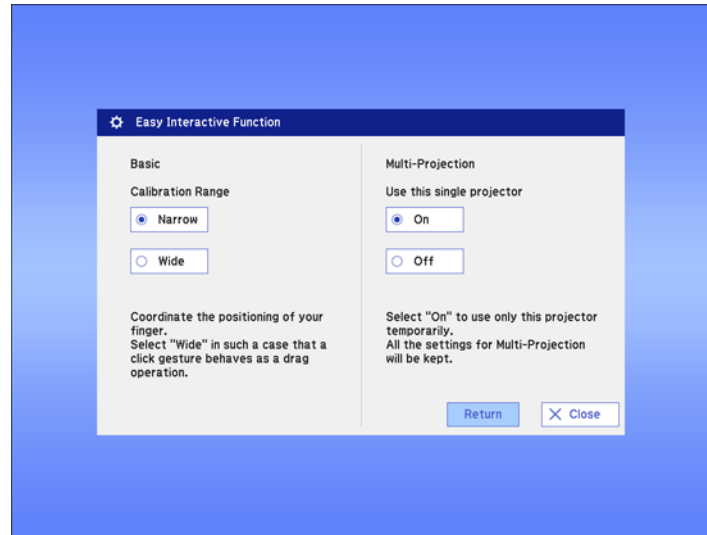

3. Set the **Use this single projector** to **On**.

You can now use the interactive features on the current projector only. When the projector turns off, the **Use this single projector** setting returns to **Off**,

**Parent topic:** [Interactive Features when Projecting with Two Projectors](#)

---

# Adjusting the Menu Settings

Follow the instructions in these sections to access the projector menu system and change projector settings.

[Using the Projector's Menus](#)

[Image Quality Settings - Image Menu](#)

[Input Signal Settings - Signal Menu](#)

[Projector Feature Settings - Settings Menu](#)

[Projector Setup Settings - Extended Menu](#)

[Projector Network Settings - Network Menu](#)

[Projector Setup Settings - ECO Menu](#)

[Projector Information Display - Info Menu](#)

[Projector Reset Options - Reset Menu](#)

## Using the Projector's Menus

You can use the projector's menus to adjust the settings that control how your projector works. The projector displays the menus on the screen.

1. Press the **Menu** button on the control panel or remote control.

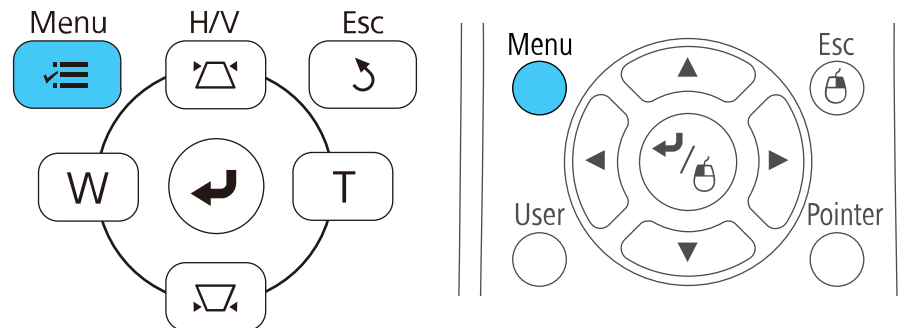



You see the menu screen displaying the Image menu settings.

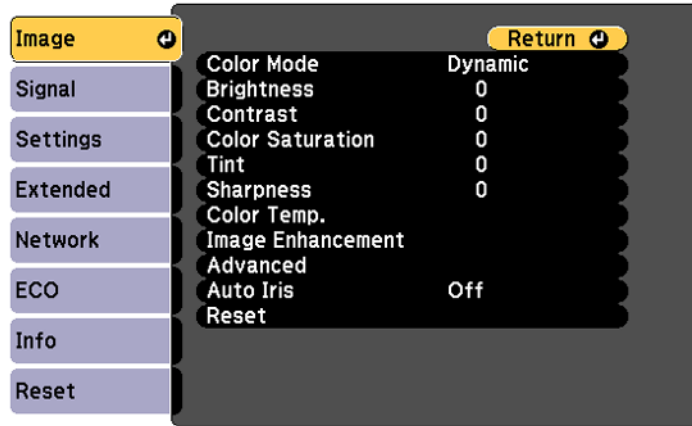

2. Press the up or down arrow button to move through the menus listed on the left. The settings for each menu are displayed on the right.

**Note:** The available settings depend on the current input source.

3. To change settings in the displayed menu, press **Enter**.
4. Press the up or down arrow button to move through the settings.
5. Change the settings using the buttons listed on the bottom of the menu screens.
6. To return all the menu settings to their default values, select **Reset**.
7. When you finish changing settings on a menu, press **Esc**.
8. Press **Menu** or **Esc** to exit the menus.

**Parent topic:** [Adjusting the Menu Settings](#)

## Image Quality Settings - Image Menu

Settings on the Image menu let you adjust the quality of your image for the input source you are currently using. The available settings depend on the currently selected input source.

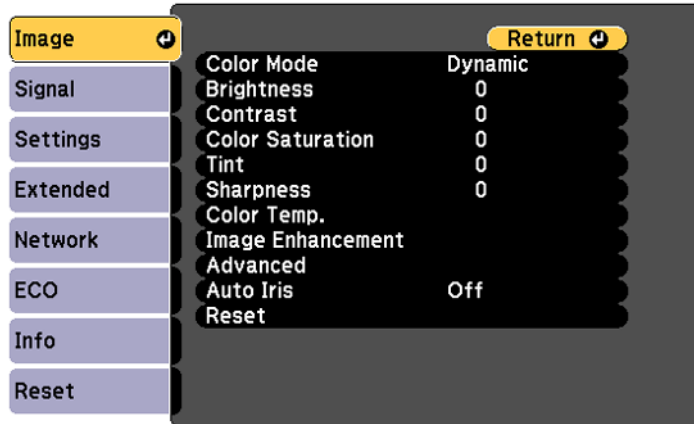

To change settings for an input source, make sure the source is connected and select that source.

Setting	Options	Description
<b>Color Mode</b>	See the list of available Color Modes	Adjusts the vividness of image colors for various image types and environments
<b>Brightness</b>	Varying levels available	Lightens or darkens the overall image
<b>Contrast</b>	Varying levels available	Adjusts the difference between light and dark areas of the image
<b>Color Saturation</b>	Varying levels available	Adjusts the intensity of the image colors
<b>Tint</b>	Varying levels available	Adjusts the balance of green to magenta tones in the image
<b>Sharpness</b>	Varying levels available	Adjusts the sharpness or softness of image details

Setting	Options	Description
<b>Color Temp.</b> (color temperature)	<b>Color Temp.</b> <b>Customized</b>	<b>Color Temp.:</b> Sets the overall color tone. Lower values tint the image red, and higher values tint the image blue.  <b>Customized:</b> Adjusts the intensity of individual hues in the image
<b>Image Enhancement</b>	<b>Noise Reduction</b>	Reduces flickering in analog images
<b>Advanced</b>	<b>Gamma</b> <b>RGBCMY</b> <b>Deinterlacing</b>	<b>Gamma:</b> adjusts the coloring by selecting one of the gamma correction values, referring to the projected image, or a gamma graph.  <b>RGBCMY:</b> adjusts the hue, saturation, and brightness for each color  <b>Deinterlacing:</b> sets whether to convert interlaced-to-progressive signals for certain video image types <ul style="list-style-type: none"> <li>• <b>Off:</b> for fast-moving video images</li> <li>• <b>Video:</b> for most video images</li> <li>• <b>Film/Auto:</b> for movies, computer graphics, and animation</li> </ul>
<b>Auto Iris</b>	<b>Off</b> <b>Normal</b> <b>High Speed</b>	Adjusts the projected luminance based on the image brightness when certain Color Modes are selected

**Note:** The **Brightness** setting does not affect lamp brightness. To change the lamp brightness mode, use the **Power Consumption** setting.

Parent topic: [Adjusting the Menu Settings](#)

**Related references**

[Available Image Aspect Ratios](#)

[Available Color Modes](#)

## Input Signal Settings - Signal Menu

Normally the projector detects and optimizes the input signal settings automatically. If you need to customize the settings, you can use the Signal menu. The available settings depend on the currently selected input source.

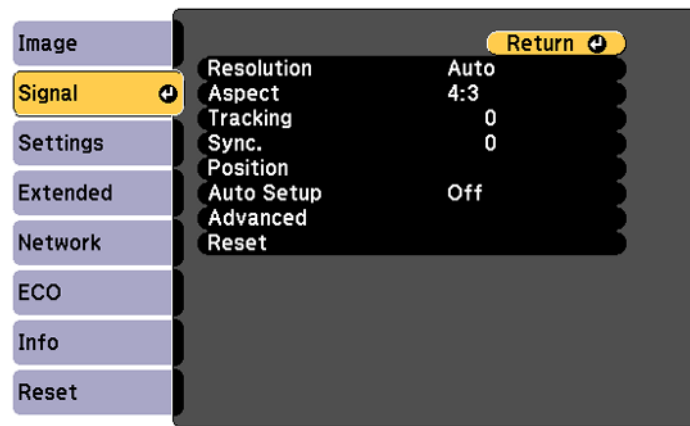

**Note:** You can restore the default settings of the **Position**, **Tracking**, and **Sync** settings by pressing the **Auto** button on the remote control.

To change settings for an input source, make sure the source is connected and select that source.

Setting	Options	Description
Resolution	Auto Wide Normal	Sets the input signal resolution if not detected automatically using the <b>Auto</b> option

<b>Setting</b>	<b>Options</b>	<b>Description</b>
<b>Aspect</b>	See the list of available aspect ratios	Sets the aspect ratio (width-to-height ratio) for the selected input source
<b>Overscan</b>	<b>Auto</b> <b>Off</b> <b>4%</b> <b>8%</b>	Changes the projected image ratio to make the edges visible by a selectable percentage or automatically
<b>Tracking</b>	Varying levels available	Adjusts signal to eliminate vertical stripes in computer images
<b>Sync.</b>	Varying levels available	Adjusts signal to eliminate fuzziness or flickering in computer images
<b>Position</b>	Up, down, left, right	Adjusts the image location on the screen
<b>Auto Setup</b>	<b>On</b> <b>Off</b>	Automatically optimizes computer image quality

Setting	Options	Description
Advanced	<b>HDMI Video Range</b> <b>Input Signal</b> <b>Video Signal</b>	<p><b>HDMI Video Range:</b> Sets the video range to match the setting of the device connected to the HDMI input port</p> <ul style="list-style-type: none"> <li>• <b>Auto:</b> detects the video range automatically</li> <li>• <b>Normal:</b> normally for images from a device other than a computer; can also be selected if the black areas of the image are too bright</li> <li>• <b>Expanded:</b> normally for images from a computer; can also be selected if the image is too dark</li> </ul> <p><b>Input Signal:</b> Specifies the signal type from input sources connected to computer ports</p> <ul style="list-style-type: none"> <li>• <b>Auto:</b> detects signals automatically</li> <li>• <b>RGB:</b> corrects color for computer/RGB video inputs</li> <li>• <b>Component:</b> corrects color for component video inputs</li> </ul> <p><b>Video Signal:</b> Specifies the signal type from the input sources connected to the video ports; select <b>Auto</b> to automatically detect the signal</p>

Parent topic: [Adjusting the Menu Settings](#)

## Projector Feature Settings - Settings Menu

Options on the Settings menu let you customize various projector features.

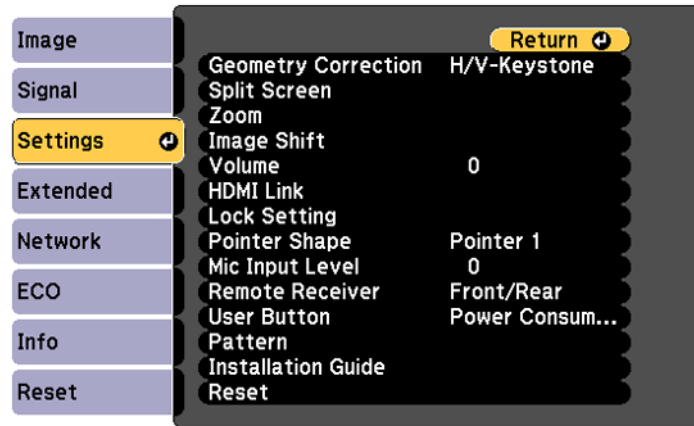

Setting	Options	Description
<b>Geometry Correction</b>	<b>H/V Keystone</b> <b>Quick Corner</b> <b>Arc Correction</b>	Adjusts image shape to rectangular (horizontally and vertically)  <b>H/V Keystone:</b> lets you manually correct horizontal and vertical sides  <b>Quick Corner:</b> select to correct image shape and alignment using an on-screen display  <b>Arc Correction:</b> select to adjust the curve or arc of the horizontal and vertical sides

Setting	Options	Description
<b>Split Screen</b>	—	Divides the viewing area horizontally and displays two images side-by-side; while in Split Screen mode, press <b>Menu</b> to display the Split Screen options or <b>Esc</b> to cancel split screen display
<b>Zoom</b>	Varying levels available	Adjusts the size of the projected image
<b>Image Shift</b>	Varying positions available	Adjusts the position of the projected image
<b>Volume</b>	Varying levels available	Adjusts the volume of projector's speaker system or external speakers
<b>HDMI Link</b>	<b>Device Connections</b> <b>HDMI Link</b> <b>Power On Link</b> <b>Power Off Link</b> <b>Link Buffer</b>	Adjusts the HDMI Link options that allow the projector remote to control HDMI-connected devices that support the CEC standard <b>Device Connections:</b> lists the devices connected to the HDMI1 and HDMI2 ports <b>HDMI Link:</b> enables or disables the HDMI Link function <b>Power On Link:</b> controls what happens when you turn on the projector or a linked device <b>Power Off Link:</b> controls whether linked devices are turned off when the projector is turned off <b>Link Buffer:</b> improves the performance of operations when the HDMI Link is not functioning correctly



Setting	Options	Description
<b>Lock Setting</b>	<b>Control Panel Lock</b>	Controls projector button locking to secure the projector  <b>Full Lock:</b> locks all buttons <b>Partial Lock:</b> locks all buttons except the power button <b>Off:</b> no buttons locked
<b>Pointer Shape</b>	Three shapes available	Changes the shape of the remote control pointer feature
<b>Mic Input Level</b>	Varying levels available	Adjusts the volume of the projector's speaker system when you use a connected microphone
<b>Remote Receiver</b>	<b>Front/Rear</b> <b>Front</b> <b>Rear</b> <b>Off</b>	Limits reception of remote control signals by the selected receiver; <b>Off</b> turns off all receivers
<b>User Button</b>	<b>Power Consumption</b> <b>Info</b> <b>Deinterlacing</b> <b>Closed Caption</b> <b>Resolution</b> <b>Mic Input Level</b> <b>Pattern Display</b> <b>Auto Calibration</b> <b>Display the QR Code</b> <b>Installation Guide</b>	Assigns a menu option to the <b>User</b> button on the remote control for one-touch access

Setting	Options	Description
<b>Pattern</b>	<b>Pattern Display</b> <b>Pattern Type</b> <b>User Pattern</b> <b>Test Pattern</b>	Selects various pattern display options <b>Pattern Display:</b> lets you display the selected pattern type on the screen to aid in presentation <b>Pattern Type:</b> selects the type of grid or line pattern to display <b>User Pattern:</b> captures a projected screen and saves it as a pattern for display <b>Test Pattern:</b> displays a test pattern to assist in focusing and zooming the image and correcting image shape
<b>Installation Guide</b>	—	Displays a test pattern for installing and positioning the projector.

Parent topic: [Adjusting the Menu Settings](#)

## Projector Setup Settings - Extended Menu

Settings on the Extended menu let you customize various projector setup features that control its operation.

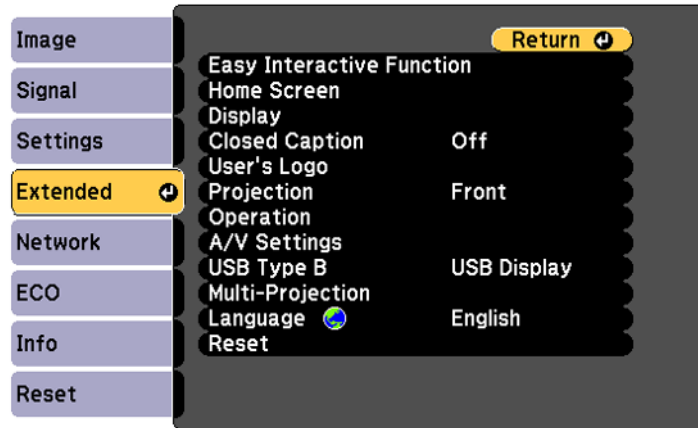

### Easy Interactive Function Settings

Setting	Options	Description
<b>General</b> Easy Interactive Function settings		
<b>Auto Calibration</b>	—	Start calibration for the interactive pens
<b>Manual Calibration</b>		

Setting	Options	Description
<b>Touch Unit Setup</b> (BrightLink 695Wi)	<b>Installation Pattern</b> <b>Power</b> <b>Angle Adjustment</b> <b>Touch Calibration</b>	Select settings for the Touch Unit <b>Installation Pattern:</b> displays reference points to help you determine the installation position of the Touch Unit <b>Power:</b> turns on the Touch Unit power <b>Angle Adjustment:</b> performs angle adjustment for laser diffusion <b>Touch Calibration:</b> performs calibration for finger touch operations
<b>Pen Mode</b>	<b>PC Free Annotation</b> <b>PC Interactive</b>	Selects the mode for the interactive pens <b>PC Free Annotation:</b> draws on the projected screen without software or PC required <b>PC Interactive:</b> operates a mouse or interactive device from the projected screen using the interactive pen or your finger (BrightLink 695Wi)
<b>Hovering</b>	<b>On</b> <b>Off</b>	Turns the pen hovering feature on and off; when set to <b>On</b> , the pointer follows the pen tip as you hover it over the screen and move it around

Setting	Options	Description
<b>Advanced</b>	<b>Distance of Projectors</b> <b>Sync of Projectors</b> <b>Multi-Projection</b> <b>Wired Sync Mode</b> <b>Preset Pen Thickness</b> <b>Eraser Size</b> <b>Color Palette</b> <b>Pen Button Function</b> <b>Default Touch Action</b> <b>Confirm Clear Screen</b>	Selects various settings for interactive features  <b>Distance of Projectors, Sync of Projectors, Multi-Projection, and Wired Sync Mode:</b> let you adjust features for using multiple projectors of the same model in the same room  <b>Preset Pen Thickness:</b> lets you select the default pen thickness when using the drawing tools  <b>Eraser Size:</b> lets you select the default eraser size when selecting the eraser tool  <b>Color Palette:</b> lets you choose a different palette if certain colors are difficult to see  <b>Pen Button Function:</b> selects the function of the button on the interactive pen in annotation mode  <b>Default Touch Action:</b> selects the default action when performing touch operations in annotation mode (BrightLink 695Wi)  <b>Confirm Clear Screen:</b> lets you display a confirmation screen before clearing all of the content
<b>PC Interactive</b> Easy Interactive Function settings		
<b>Pen Operation Mode</b> (BrightLink 695Wi)	<b>Windows/Mac Mode</b> <b>Ubuntu mode</b>	Sets the correct operating system for the interactive pen features

Setting	Options	Description
<b>Enable Right Click</b>	<b>On</b> <b>Off</b>	Lets you use a long pen press or finger press (BrightLink 695Wi) as a right-click operation when using mouse mode
<b>Advanced</b>	<b>Pen Tip Button</b> <b>Auto Adjust Pen Area</b> <b>Manual Adj. Pen Area</b>	Select pen operation and adjustment options  <b>Pen Tip Button:</b> assign either <b>Right Click</b> or <b>Left Click</b> to the pen tip button  Select either <b>Auto Adjust Pen Area</b> or <b>Manual Adj. Pen Area</b> as the pen area adjustment option

#### Other Extended Settings

Setting	Options	Description
<b>Home Screen</b>	<b>Home Screen Auto Disp.</b> <b>Custom Function 1</b> <b>Custom Function 2</b>	Adjust settings on the Home Screen  <b>Home Screen Auto Disp.:</b> controls whether the Home screen displays automatically when the projector is turned on  <b>Custom Function 1/Custom Function 2:</b> let you customize the options displayed on the Home screen and save your settings as a preset

Setting	Options	Description
<b>Display</b>	<b>Messages</b> <b>Display Background</b> <b>Startup Screen</b> <b>A/V Mute</b> <b>Color Uniformity</b> <b>Toolbars</b> <b>Pen Mode Icon</b> <b>Projector Control</b>	Selects various display options <b>Messages:</b> controls whether messages are displayed on the screen <b>Display Background:</b> selects the screen color or logo to display when no signal is received <b>Startup Screen:</b> controls whether a special screen appears when the projector starts up <b>A/V Mute:</b> selects the screen color or logo to display when A/V Mute is turned on <b>Color Uniformity:</b> adjusts the color tone balance <b>Toolbars:</b> controls whether the drawing toolbar is always displayed when in annotation mode <b>Pen Mode Icon:</b> controls the display and position of the pen icon in interactive computer mode <b>Projector Control:</b> controls where the projector control toolbar is displayed on the screen
<b>Closed Caption</b>	<b>Off</b> <b>CC1</b> <b>CC2</b>	Controls use of closed captions and selects the closed caption type (closed captions are only visible for NTSC signals connected through the <b>S-Video</b> or <b>Video</b> ports)

Setting	Options	Description
<b>User's Logo</b>	—	Creates a screen that the projector displays to identify itself and enhance security
<b>Projection</b>	<b>Front</b> <b>Front/UpSide Down</b> <b>Rear</b> <b>Rear UpSide Down</b>	Selects the way the projector faces the screen so the image is oriented correctly



Setting	Options	Description
<b>Operation</b>	<b>Direct Power On</b> <b>High Altitude Mode</b> <b>Auto Source Search</b> <b>Auto Power On</b> <b>Monitor Out Port</b> <b>Connect ELPCB02</b> <b>Date &amp; Time</b>	Selects various operation options <p><b>Direct Power On:</b> lets you turn on the projector without pressing the power button</p> <p><b>High Altitude Mode:</b> regulates the projector's operating temperature at altitudes above 4921 feet (1500 m)</p> <p><b>Auto Source Search:</b> automatically detects the image signal that is input when the projector is turned on</p> <p><b>Auto Power On:</b> automatically turns the projector on when it detects an input signal from the selected port</p> <p><b>Monitor Out Port:</b> specifies the function of the Monitor Out/Computer2 port</p> <p><b>Connect ELPCB02:</b> allows you to switch between the <b>HDMI2</b> and <b>HDMI3</b> sources when you press the <b>HDMI2</b> button on the optional PowerLite Pilot 2 control box</p> <p><b>Date &amp; Time:</b> adjusts the projector's date and time settings</p> <ul style="list-style-type: none"> <li>• <b>Daylight Savings Time:</b> enables daylight savings time</li> <li>• <b>Internet Time:</b> updates the time automatically via an online time server</li> </ul>

Setting	Options	Description
<b>A/V Settings</b>	<b>A/V Output</b> <b>Audio Output</b> <b>HDMI1 Audio Output</b> <b>HDMI2 Audio Output</b> <b>HDMI3 Audio Output</b>	<p>Selects the following when the projector is in standby mode (turned off):</p> <p><b>A/V Output:</b> the <b>Always On</b> setting indicates that the projector output audio and video signals even while it is standby mode; only available when <b>Standby Mode</b> is set to <b>Communication On</b></p> <p><b>Audio Output:</b> selects the audio input port when projecting images from the <b>Computer1</b>, <b>Computer2</b>, <b>Video</b>, and <b>USB-A</b> ports</p> <p><b>HDMI1 Audio Output, HDMI2 Audio Output, and HDMI3 Audio Output:</b> selects which Audio port provides audio when viewing images from the <b>HDMI1</b>, <b>HDMI2</b>, and <b>HDMI3</b> ports</p>

Setting	Options	Description
<b>USB Type B</b>	<b>Easy Interactive Function</b> <b>USB Display/Easy Interactive Function</b> <b>Wireless Mouse/USB Display</b>	<p>Selects what happens when you connect your computer to the projector's <b>USB-B</b> port</p> <p><b>Easy Interactive Function:</b> lets you use the interactive pens or your finger (BrightLink 695Wi) with your computer</p> <p><b>USB Display/Easy Interactive Function:</b> lets you display your computer's image through the USB port and use the interactive pens or your finger (BrightLink 695Wi) with your computer</p> <p><b>Wireless Mouse/USB Display:</b> lets you use the wireless mouse feature and display your computer's image through the USB port (interactivity not available)</p>

Setting	Options	Description
<b>Multi-Projection</b>	<b>Multi-Projection</b> <b>Projector ID</b> <b>Color Mode</b> <b>Color Uniformity</b> <b>Brightness Level</b> <b>Color Matching</b> <b>RGBCMY</b> <b>Reset</b>	Selects the following when you use multiple projectors: <b>Multi-Projection:</b> matches the display settings of multiple projectors <b>Projector ID:</b> assigns an ID for the projector when you use multiple projectors <b>Color Mode:</b> adjusts the vividness of image colors for various image types and environments <b>Color Uniformity:</b> adjusts the color tone balance <b>Brightness Level:</b> lightens or darkens the overall image <b>Color Matching:</b> corrects the difference in tint and brightness for each projected image <b>RGBCMY:</b> adjusts the hue, saturation, and brightness for each color <b>Reset:</b> resets all of the Multi-Projection settings to their default values
<b>Language</b>	Various languages available	Selects the language for projector menu and message displays (not changed by <b>Reset</b> option)

Parent topic: [Adjusting the Menu Settings](#)

**Related tasks**

[Calibrating Automatically](#)

[Calibrating Manually](#)

## Projector Network Settings - Network Menu

Settings on the Network menu let you view network information and set up the projector for monitoring and control over a network.

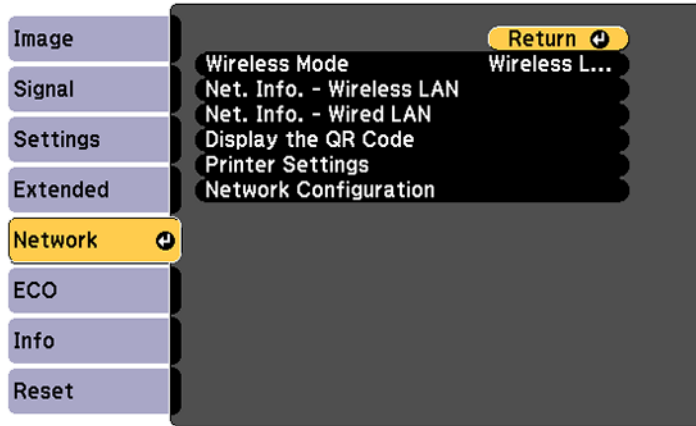

Setting	Options	Description
Wireless Mode	Wireless LAN ON Off	Enable or disable wireless communication

Setting	Options	Description
<b>Net. Info - Wireless LAN</b>	<b>Connection mode</b> <b>Wireless LAN Sys.</b> <b>Antenna level</b> <b>Projector Name</b> <b>SSID</b> <b>DHCP</b> <b>IP Address</b> <b>Subnet Mask</b> <b>Gateway Address</b> <b>MAC Address</b> <b>Region Code</b>	Displays wireless network status and details
<b>Net. Info - Wired LAN</b>	<b>Projector Name</b> <b>DHCP</b> <b>IP Address</b> <b>Subnet Mask</b> <b>Gateway Address</b> <b>MAC Address</b>	Displays wired network status and details
<b>Display the QR Code</b>	—	Displays the QR code for quick connection to a mobile device
<b>Printer Settings</b>	<b>IP Address</b> <b>Quality</b> <b>Paper Size</b>	Configures the settings for printing images with the interactive function
<b>Network Configuration</b>	Accesses additional network menus	Configures your network settings

Parent topic: [Adjusting the Menu Settings](#)

Related concepts

[Wired Network Projection](#)

## Projector Setup Settings - ECO Menu

Settings on the ECO menu let you customize projector functions to save power. When you select a power-saving setting, a leaf icon appears next to the menu item.

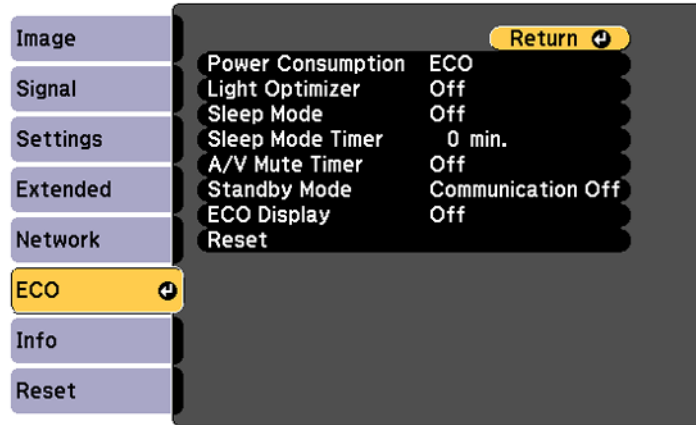

Setting	Options	Description
Power Consumption	<b>Auto</b> <b>Normal</b> <b>ECO</b> <b>ECO2</b>	Selects the brightness mode of the projector lamp  <b>Auto:</b> allows the projector to sense the optimum lamp brightness and adjust the lamp brightness accordingly  <b>Normal:</b> sets maximum lamp brightness  <b>ECO:</b> reduces lamp brightness and fan noise, and saves power and lamp life  <b>ECO2:</b> reduces fan noise less than <b>ECO</b>

Setting	Options	Description
Light Optimizer	On Off	When <b>Power Consumption</b> is set to <b>Normal</b> , the lamp brightness is adjusted based on the projected image; you can set this option for each color mode
Sleep Mode	On Off	Automatically places the projector in standby mode after an interval of inactivity
Sleep Mode Timer	1 to 30 minutes	Sets the interval for Sleep Mode
A/V Mute Timer	On Off	Automatically turns off the projector after 30 minutes if <b>A/V Mute</b> is enabled
Standby Mode	Communication On Communication Off	Enable this setting to allow the following operations to occur when the projector is in standby mode: <ul style="list-style-type: none"> <li>• Monitor and control the projector over a network</li> <li>• Output audio and video to an external device (A/V Output must be set to <b>Always On</b>)</li> </ul>
ECO Display	On Off	Displays a leaf icon in the bottom left corner of the projected screen to indicate the power-saving status when the lamp brightness changes

Parent topic: [Adjusting the Menu Settings](#)



## Projector Information Display - Info Menu

You can display information about the projector and input sources by viewing the Info menu. However, you cannot change any settings in the menu.

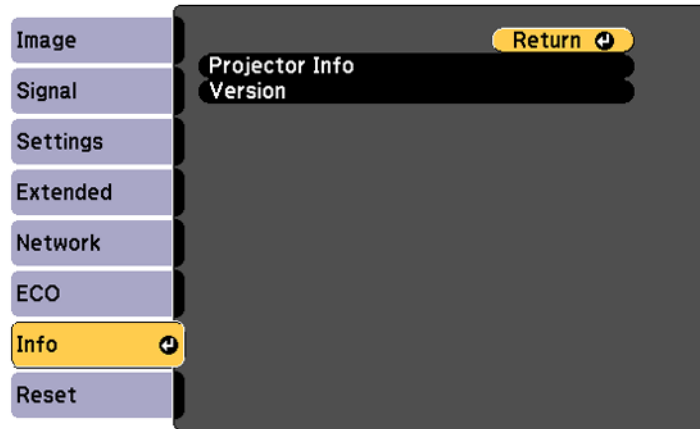

Select **Version** to display the projector's firmware version. Select **Projector Info** to display the settings described below.

**Note:** Available settings depend on the current input source. The lamp usage timer does not register any hours until you have used the lamp for at least 10 hours.

Information item	Description
<b>Lamp Hours</b>	Displays the number of hours ( <b>H</b> ) the lamp has been used in <b>Normal</b> and <b>ECO</b> Power Consumption modes; if the information is displayed in yellow, obtain a genuine Epson replacement lamp soon
<b>Source</b>	Displays the name of the port to which the current input source is connected
<b>Input Signal</b>	Displays the input signal setting of the current input source
<b>Resolution</b>	Displays the resolution of the current input source
<b>Video Signal</b>	Displays the video signal format of the current input source

Information item	Description
<b>Refresh Rate</b>	Displays the refresh rate of the current input source
<b>Sync Info</b>	Displays information that may be needed by a service technician
<b>Status</b>	Displays information about projector problems that may be needed by a service technician
<b>Serial Number</b>	Displays the projector's serial number
<b>Event ID</b>	Displays the Event ID number corresponding to a specific projector problem; see the list of Event ID codes

[Event ID Code List](#)

**Parent topic:** [Adjusting the Menu Settings](#)

**Related references**

[Optional Equipment and Replacement Parts](#)

[Projector Lamp Specifications](#)

## Event ID Code List

If the **Event ID** option on the Info menu displays a code number, check this list of Event ID codes for the solution to the projector problem associated with the code.

Event ID code	Cause and solution
0432	The network software did not start. Turn the projector off and then on again.
0435	
0434	Unstable network communication. Check the network communication status, wait a few moments, and try connecting to the network again.
0481	
0482	
0485	
0433	Cannot display the transferred images. Restart the network software.
0483	The network software quit unexpectedly. Check the network communication status, then turn the projector off and then on again.
04FE	
0484	Communication with computer was disconnected. Restart the network software.

Event ID code	Cause and solution
0479	A projector system error has occurred. Turn the projector off and then on again.
04FF	
0891	Cannot find the SSID (network name). Make sure your computer and projector are connected to your access point's current SSID.
0892	The WPA/WPA2 authentication type does not match. Make sure the wireless network security settings are correct.
0893	The TKIP/AES encryption type does not match. Make sure the wireless network security settings are correct.
0894	Communication with unauthorized access point was disconnected. Contact your network administrator.
0898	Failed to acquire DHCP address. Make sure the DHCP server is operating correctly. If you are not using DHCP, turn off the <b>DHCP</b> setting in the Network menus.
0899	A communication error has occurred. Try restarting the network software and restarting your projector. If that does not solve the problem, contact Epson for help.

Parent topic: [Projector Information Display - Info Menu](#)

## Projector Reset Options - Reset Menu

You can reset most of the projector settings to their default values using the **Reset All Config** option on the Reset menu.

You can also reset the projector's lamp usage timer to zero when you replace the lamp using the **Reset Lamp Hours** option.

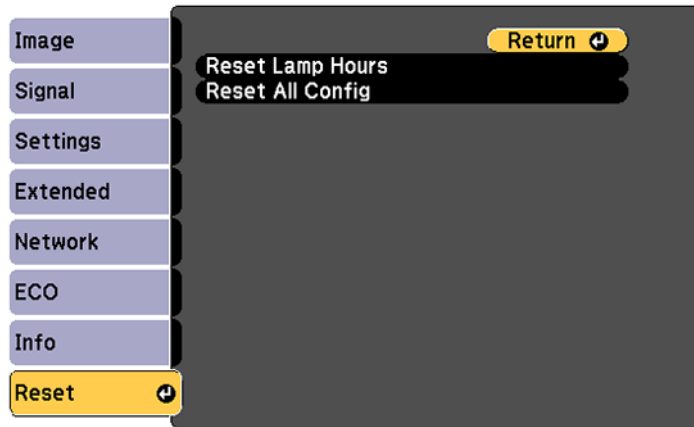

You cannot reset the following settings using the **Reset All Config** option:

- Input Signal
- User's Logo
- Language
- Network menu items
- Lamp Hours
- Password
- Zoom
- Image Shift
- Date & Time
- Color Uniformity
- Color Matching

**Parent topic:** [Adjusting the Menu Settings](#)

---

# Maintaining and Transporting the Projector

Follow the instructions in these sections to maintain your projector and transport it from place to place.

[Projector Maintenance](#)

[Transporting the Projector](#)

## Projector Maintenance

Your projector needs little maintenance to keep working at its best.

You may need to clean the projection window and obstacle sensor periodically, and clean the air filter and air vents to prevent the projector from overheating due to blocked ventilation.

The only parts you should replace are the lamp, air filter, pen batteries and tips, and remote control batteries. If any other part needs replacing, contact Epson or an authorized Epson servicer.

**Warning:** Before cleaning any part of the projector, turn it off and unplug the power cord. Never open any cover on the projector, except as specifically explained in this manual. Dangerous electrical voltages in the projector can injure you severely.

**Warning:** Do not try to service this product yourself, except as specifically explained in this manual. Refer all other servicing to qualified servicers.

[Cleaning the Projection Window](#)

[Cleaning the Obstacle Sensor](#)

[Cleaning the Projector Case](#)

[Air Filter and Vent Maintenance](#)

[Projector Lamp Maintenance](#)

[Replacing the Remote Control Batteries](#)

[Replacing the Soft Pen Tips](#)

[Replacing the Hard Pen Tips](#)

**Parent topic:** [Maintaining and Transporting the Projector](#)

## Cleaning the Projection Window

Clean the projection window periodically, or whenever you notice dust or smudges on the surface.

- To remove dust or smudges, gently wipe the projection window with lens-cleaning paper.

- To remove stubborn smudges, moisten a soft, lint-free cloth with lens cleaner and gently wipe the projection window.

**Warning:** Do not use a lens cleaner that contains flammable gas. The high heat generated by the projector lamp may cause a fire.

**Caution:** Do not use canned air, or the gases may leave a flammable residue.

Parent topic: [Projector Maintenance](#)

## Cleaning the Obstacle Sensor

Clean the projector's obstacle sensor glass (circled in red) periodically, or if you see a message telling you to remove any obstacles that are interfering with the projection area.

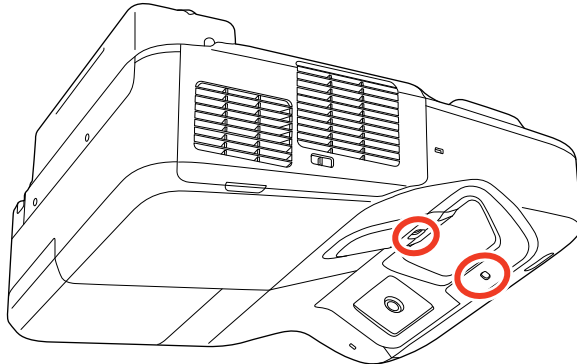

- To remove dust or smudges, gently wipe the obstacle sensor glass with lens-cleaning paper.
- To remove stubborn smudges, moisten a soft, lint-free cloth with lens cleaner and gently wipe the obstacle sensor glass.

**Warning:** Do not use a lens cleaner that contains flammable gas. The high heat generated by the projector lamp may cause a fire.

**Caution:** Do not use canned air, or the gases may leave a flammable residue.

Parent topic: [Projector Maintenance](#)

## Cleaning the Projector Case

Before cleaning the projector case, turn off the projector and unplug the power cord.

- To remove dust or dirt, use a soft, dry, lint-free cloth.
- To remove stubborn dirt, use a soft cloth moistened with water and mild soap. Do not spray liquid directly on the projector.

**Caution:** Do not use wax, alcohol, benzine, paint thinner, or other chemicals to clean the projector case. These can damage the case. Do not use canned air, or the gases may leave a residue.

**Parent topic:** [Projector Maintenance](#)

## Air Filter and Vent Maintenance

Regular filter maintenance is important to maintaining your projector. Your Epson projector is designed with an easily accessible, user-replaceable filter to protect your projector and make regular maintenance simple. Filter maintenance intervals will depend on the environment.

If regular maintenance is not performed, your Epson projector will notify you when the temperature inside the projector has reached a high level. Do not wait until this warning appears to maintain your projector filter as prolonged exposure to high temperatures may reduce the life of your projector or lamp.

Damage due to the failure to properly maintain the projector or its filter may not be covered by the projector or lamp Limited Warranties.

[Cleaning the Air Filter and Vents](#)

[Replacing the Air Filter](#)

**Parent topic:** [Projector Maintenance](#)

### Cleaning the Air Filter and Vents

Clean the projector's air filter or vents if they get dusty, or if you see a message telling you to clean them.

**Caution:** Do not use water or any detergent to clean the air filter. Do not use canned air, or the gases may leave a flammable residue.

1. Turn off the projector and unplug the power cord.

2. Slide the air filter cover latch and open the air filter cover.

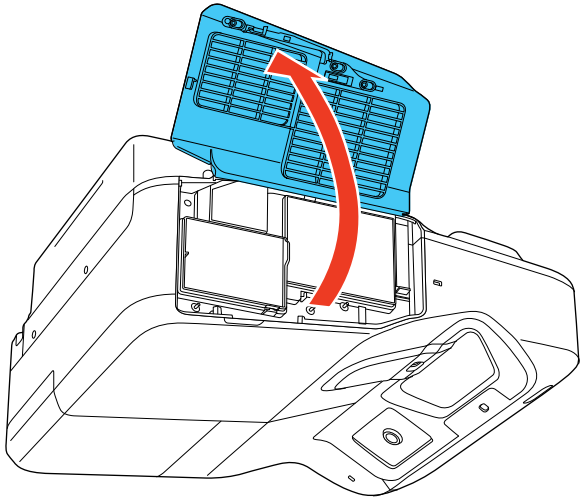
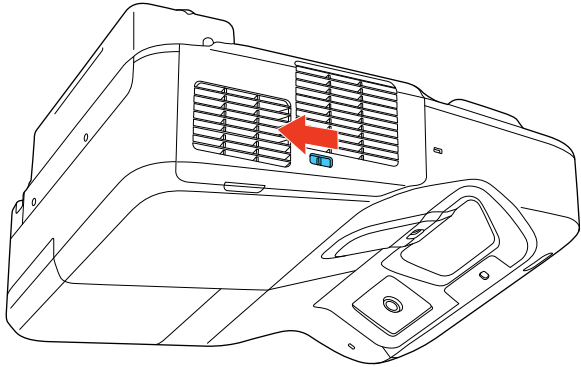



3. Pull the air filter out of the projector.

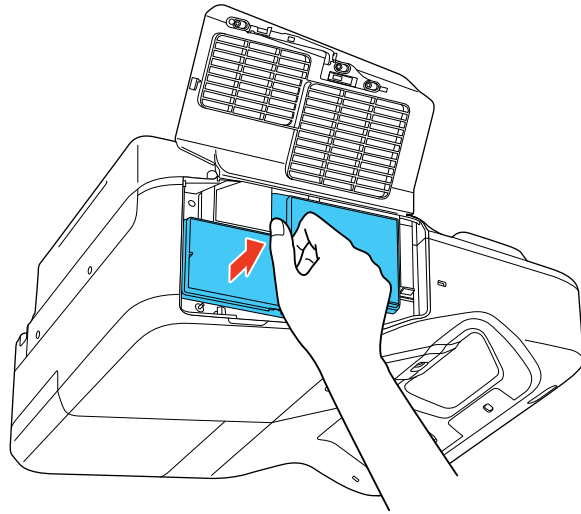

4. Vacuum the front of the air filter (the side with the tabs) to remove any remaining dust.

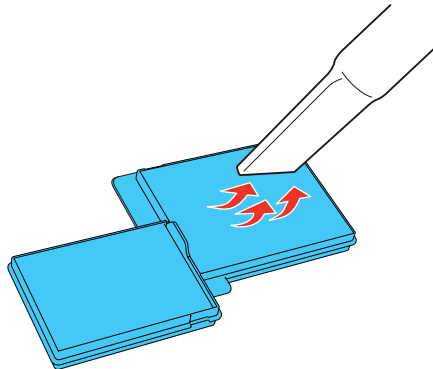

**Note:** If dust is difficult to remove or the air filter is damaged, replace the air filter.

5. Place the air filter back in the projector as shown.

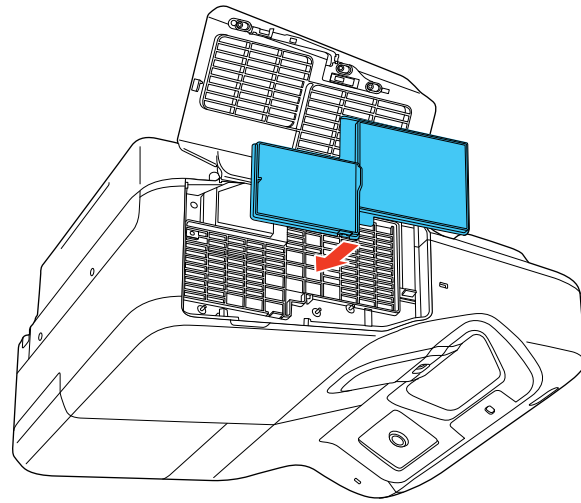

6. Close the air filter cover and slide the latch.

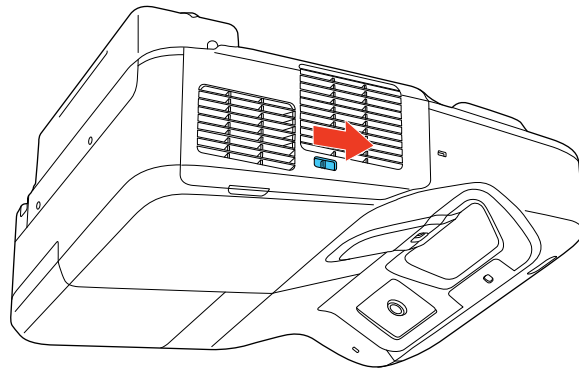
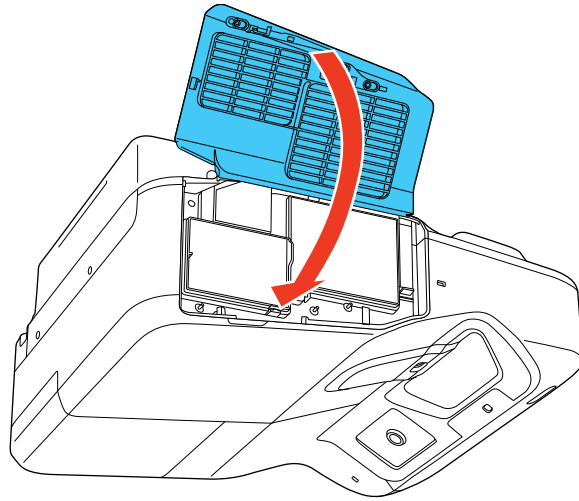

**Parent topic:** [Air Filter and Vent Maintenance](#)

### **Replacing the Air Filter**

You need to replace the air filter in the following situations:

- After cleaning the air filter, you see a message telling you to clean or replace it
- The air filter is torn or damaged

You can replace the air filter while the projector is mounted on the wall or ceiling.

1. Turn off the projector and unplug the power cord.
2. Slide the air filter cover latch and open the air filter cover.

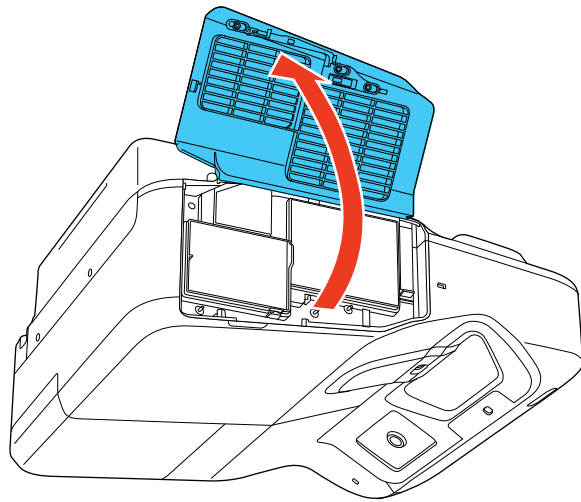
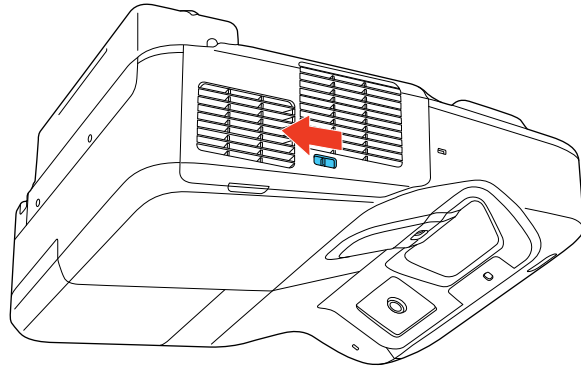

3. Pull the air filter out of the projector.

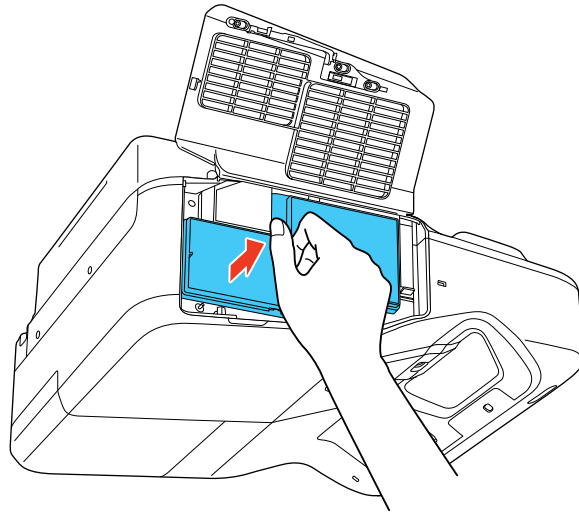

**Note:** Air filters contain polypropylene. Dispose of used air filters according to local regulations.

4. Place the new air filter in the projector as shown.

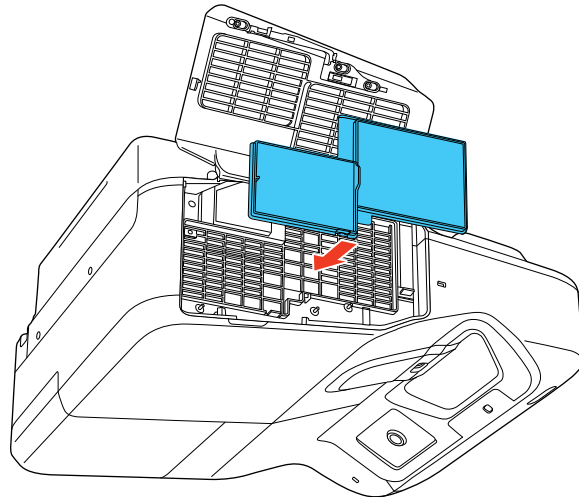

5. Close the air filter cover and slide the latch.

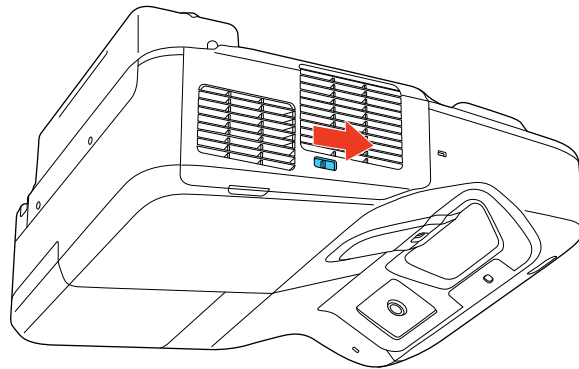
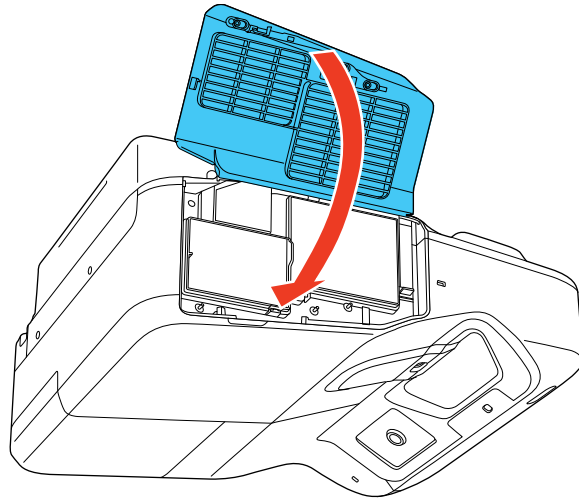

Parent topic: [Air Filter and Vent Maintenance](#)

## Projector Lamp Maintenance

The projector keeps track of the number of hours the lamp is used and displays this information in the projector's menu system.

Replace the lamp as soon as possible when the following occurs:

- The projected image gets darker or starts to deteriorate
- A message appears when you turn on the projector telling you to replace the lamp
- The projector's Lamp light is flashing orange and its power light is flashing blue

[Replacing the Lamp](#)

[Resetting the Lamp Timer](#)

**Parent topic:** [Projector Maintenance](#)

#### **Related references**

[Optional Equipment and Replacement Parts](#)

[Projector Lamp Specifications](#)

[Projector Information Display - Info Menu](#)

### **Replacing the Lamp**

Before you replace the lamp, let the projector cool down for at least one hour so the lamp will not be hot.

**Warning:** Let the lamp fully cool before replacing it to avoid injury.

You can replace the lamp while the projector is mounted on the wall or ceiling.

1. Turn off the projector and unplug the power cord.
2. Allow the projector lamp to cool down for at least one hour.

**Warning:** If the lamp is broken, glass fragments may be loose inside the lamp chamber. Be careful removing any broken glass to avoid injury. If the projector is mounted on the wall or ceiling, stand to the side in case the lamp is broken.

3. Use the screwdriver included with the replacement lamp to loosen the screw securing the lamp cover.

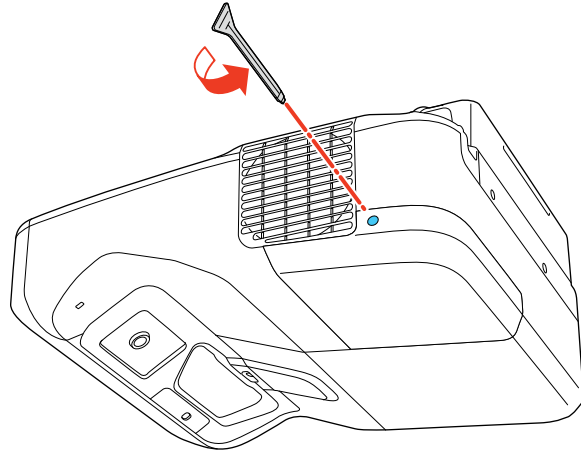

4. Slide off the lamp cover.

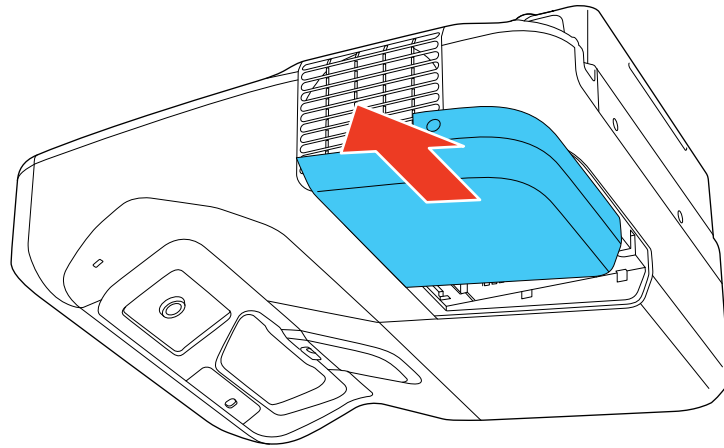



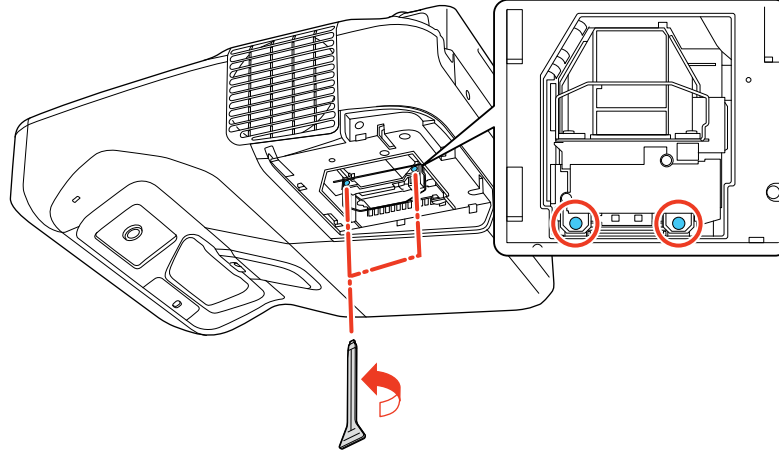

5. Loosen the screws securing the lamp to the projector. The screws do not come all the way out.

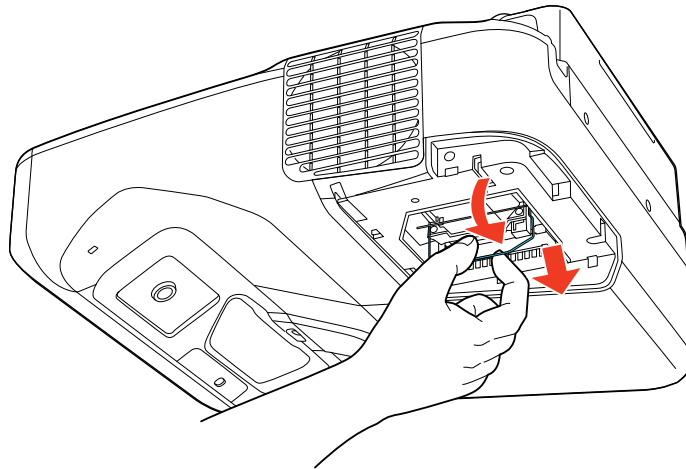

6. Lift up the lamp handle and gently pull the lamp out of the projector.



**Note:**  The lamp(s) in this product contain mercury. Please consult your state and local regulations regarding disposal or recycling. Do not put in the trash.

7. Gently insert the new lamp into the projector along the guide rail. If it does not fit easily, make sure it is facing the right way. Press the handle down.

**Caution:** Do not touch any glass on the lamp assembly to avoid premature lamp failure.

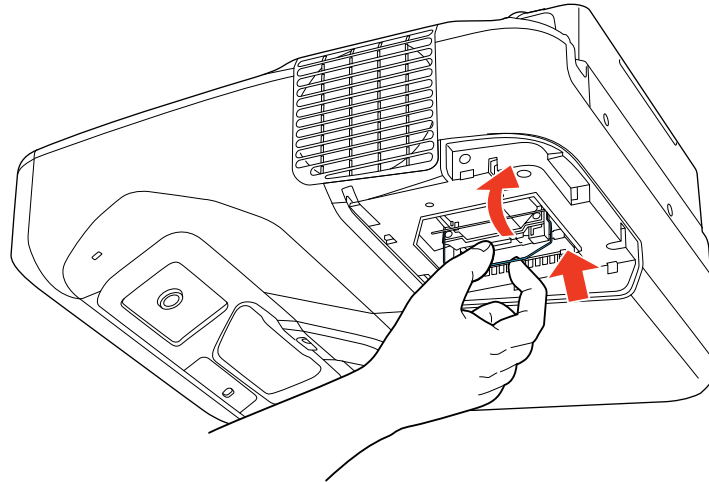

8. Tighten the screws to secure the lamp.

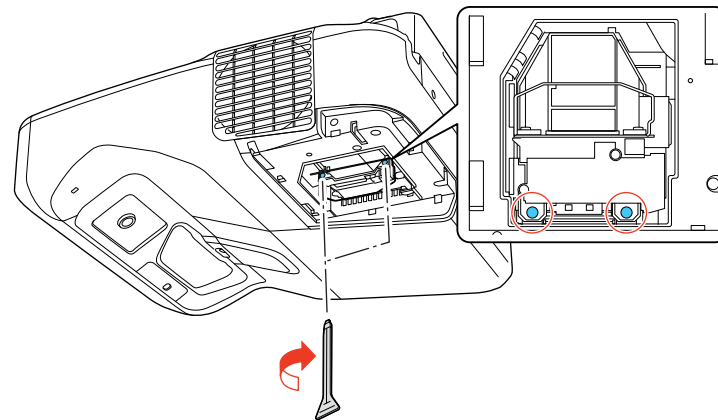

9. Replace the lamp cover and tighten the screw to secure it.

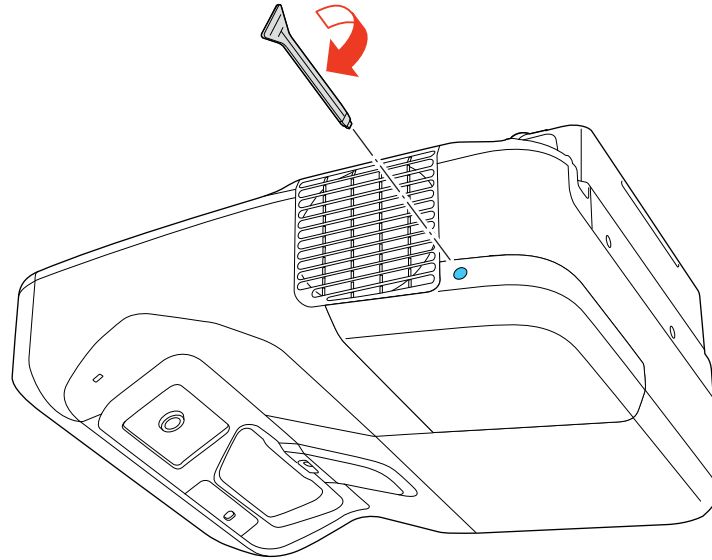

**Note:** Be sure the lamp cover is securely installed or the lamp will not come on.

Reset the lamp timer to zero to keep track of the new lamp's usage.

**Parent topic:** [Projector Lamp Maintenance](#)

**Related tasks**

[Resetting the Lamp Timer](#)

**Resetting the Lamp Timer**

You must reset the lamp timer after replacing the projector's lamp to clear the lamp replacement message and to keep track of lamp usage correctly.

**Note:** Do not reset the lamp timer if you have not replaced the lamp to avoid inaccurate lamp usage information.

1. Turn on the projector.
2. Press the **Menu** button.

3. Select the **Reset** menu and press **Enter**.

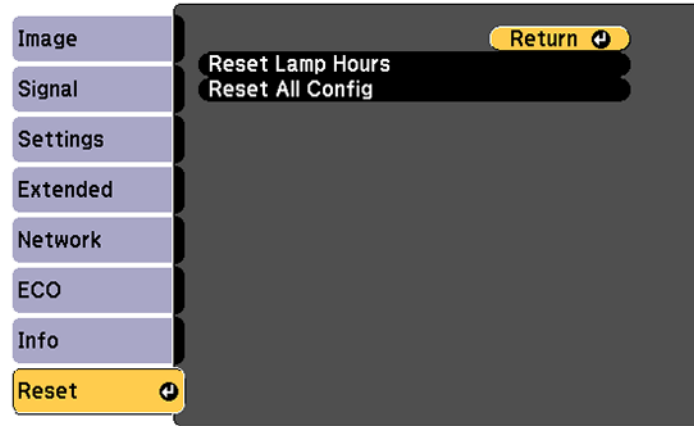

4. Select **Reset Lamp Hours** and press **Enter**.  
You see a prompt asking if you want to reset the lamp hours.
5. Select **Yes** and press **Enter**.
6. Press **Menu** or **Esc** to exit the menus.

**Parent topic:** [Projector Lamp Maintenance](#)

#### **Related tasks**

[Replacing the Lamp](#)

## **Replacing the Remote Control Batteries**

The remote control uses two AA manganese or alkaline batteries. Replace the batteries as soon as they run out.

**Caution:** Use only the type of batteries specified in this manual. Do not install batteries of different types, or mix new and old batteries.

1. Remove the battery cover as shown.

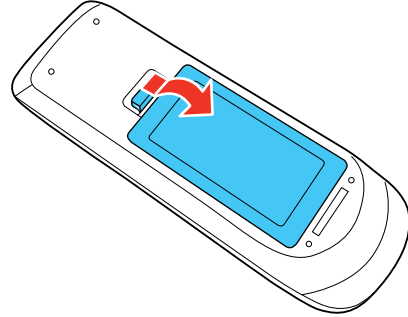

2. Remove the old batteries.

**Warning:** If the battery fluid has leaked, wipe it away with a soft cloth and avoid getting the fluid on your hands. If it gets on your hands, wash them immediately to avoid injury.

3. Insert the batteries with the + and – ends facing as shown.

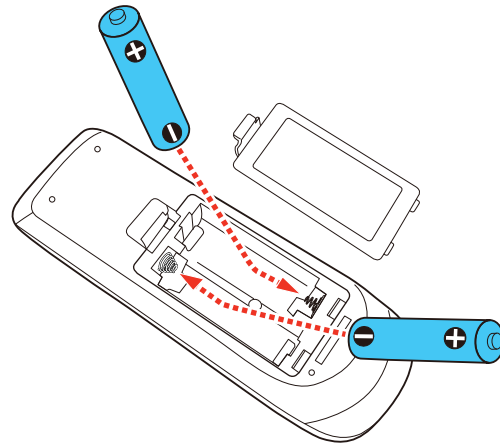

4. Replace the battery cover and press it down until it clicks into place.

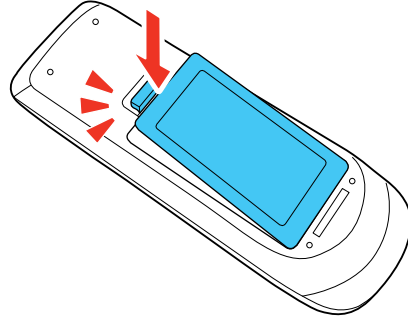

**Warning:** Dispose of used batteries according to local regulations. Do not expose batteries to heat or flame. Keep batteries out of the reach of children; they are choking hazards and are very dangerous if swallowed.

Parent topic: [Projector Maintenance](#)

## Replacing the Soft Pen Tips

If the pen tips become damaged or no longer work correctly, you can replace them.

1. Twist off the tip of the pen to remove it.

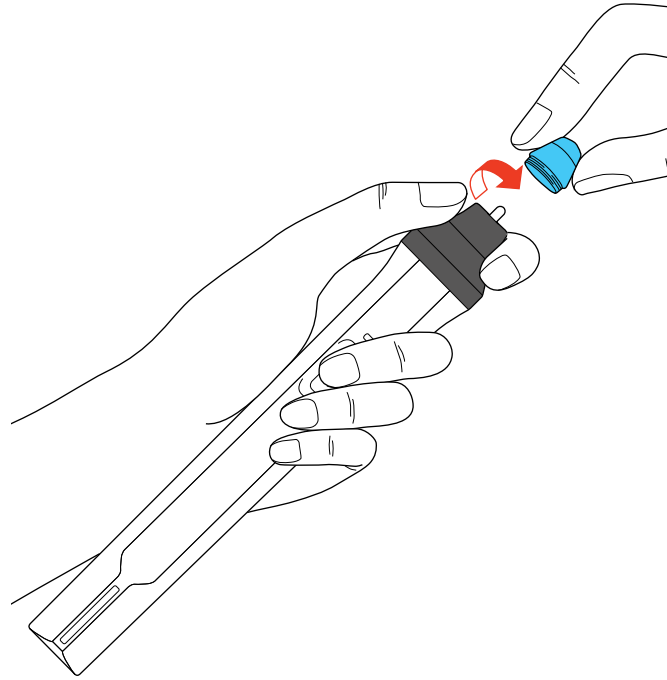

2. Remove the soft tip.

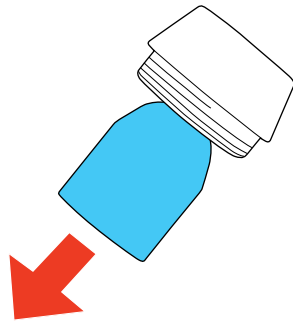

3. Insert the new tip.

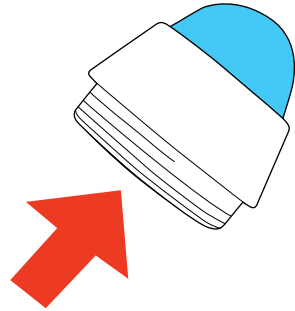

4. Twist on the pen tip.

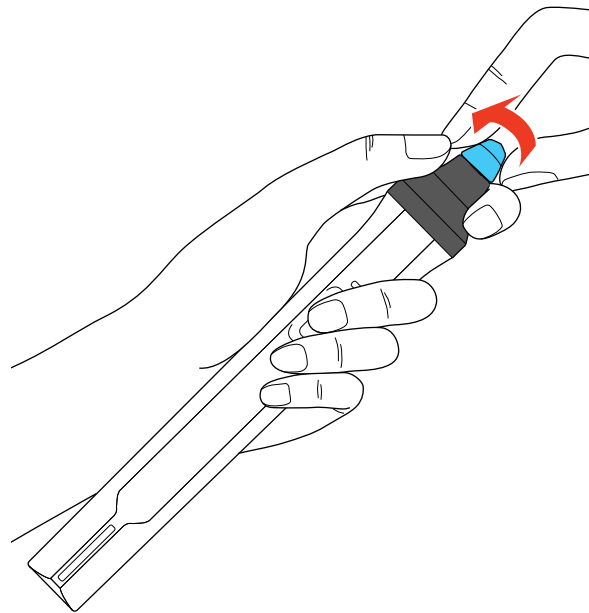

Parent topic: [Projector Maintenance](#)



## Replacing the Hard Pen Tips

If the pen tips become damaged or no longer work correctly, you can replace them.

1. Twist off the tip of the pen to remove it.

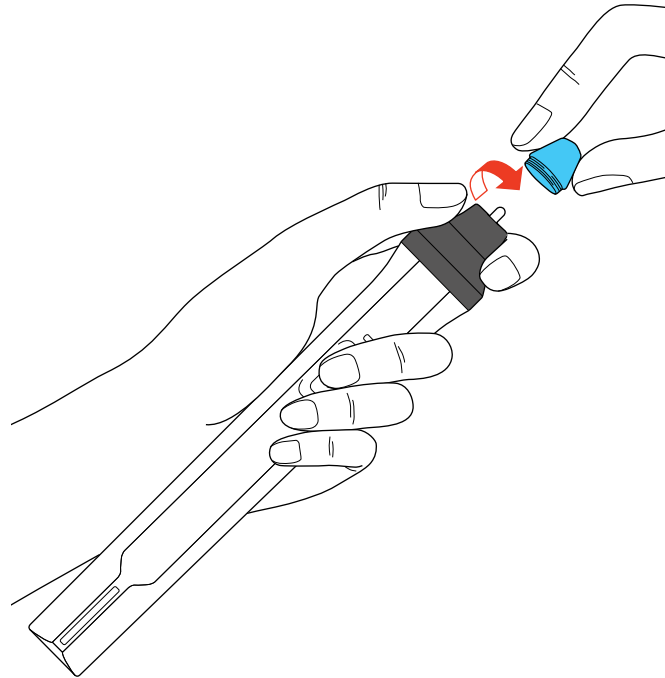

2. Twist on the new tip.

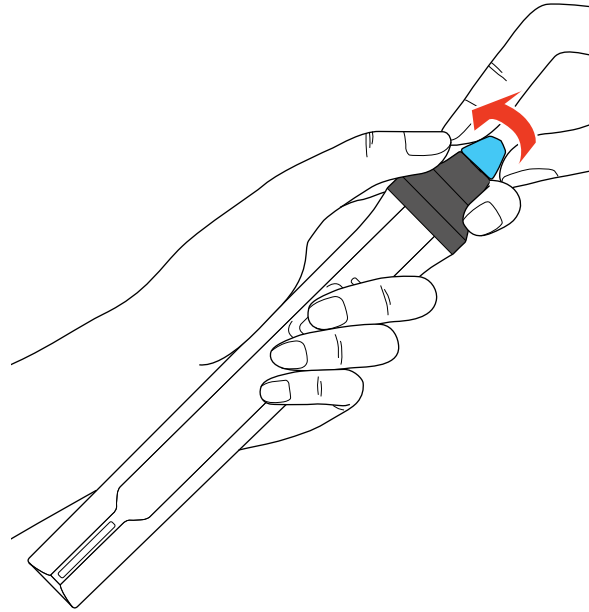

**Parent topic:** [Projector Maintenance](#)

## Transporting the Projector

The projector contains precision parts, some of which are glass. Follow these guidelines to transport, ship, or store the projector safely:

- Remove any equipment connected to the projector.
- When transporting the projector a long distance or as checked luggage, pack it in a firm box with cushioning around it and mark the box "Fragile."
- When shipping the projector for repairs, place it in its original packing materials, if possible, or use equivalent materials with cushioning around the projector. Mark the box "Fragile."

**Note:** Epson shall not be liable for any damages incurred during transportation.

**Parent topic:** [Maintaining and Transporting the Projector](#)

---

# Solving Problems

Check the solutions in these sections if you have any problems using the projector.

[Projection Problem Tips](#)

[Projector Light Status](#)

[Using the Projector Help Displays](#)

[Solving Image or Sound Problems](#)

[Solving Projector or Remote Control Operation Problems](#)

[Solving Interactive Problems](#)

[Solving Network Problems](#)

[Where to Get Help](#)

## Projection Problem Tips

If the projector is not working properly, try turning it off and unplugging it. Then plug it back in and turn it on.

If this does not solve the problem, check the following:

- The lights on the projector may indicate what the problem is.
- The Help option on the Home screen can display information about common problems, if the projector is operating.
- The solutions in this manual can help you solve many problems.

If none of these solutions help, you can contact Epson for technical support.

**Parent topic:** [Solving Problems](#)

## Projector Light Status

The lights on the projector indicate the projector status and let you know when a problem occurs. Check the status and color of the lights and look for a solution in the table here.

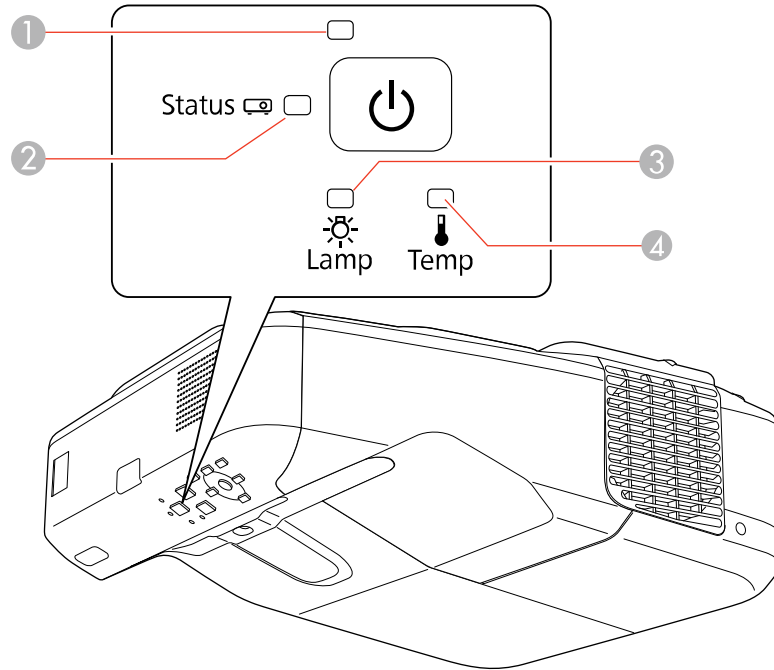

- 1 Power light
- 2 Status light
- 3 Lamp light
- 4 Temp (temperature) light

Power light	Status light	Lamp light	Temp light	Status and solution
Blue	Blue	Off	Off	Normal operation.
Blue	Flashing blue	Off	Off	Warming up. Wait for an image to appear.

Power light	Status light	Lamp light	Temp light	Status and solution
Blue	Off	Off	Off	Standby or sleep mode.
Blue	Flashing blue	Off	Off	Shutting down. (When the Status light stops flashing, you can unplug the projector.)
Blue	Varies	Off	Flashing orange	Projector is too hot. <ul style="list-style-type: none"> <li>• Make sure that the vents and air filter are not clogged with dust or obstructed by nearby objects.</li> <li>• Clean or replace the air filter.</li> <li>• Make sure the environmental temperature is not too hot.</li> </ul>
Off	Flashing blue	Off	Orange	Projector has overheated and turned off. Leave it turned off to cool down. After about five minutes, do the following: <ul style="list-style-type: none"> <li>• Make sure that the vents and air filter are not clogged with dust or obstructed by nearby objects.</li> <li>• Clean or replace the air filter.</li> <li>• If operating the projector at high altitude, turn on <b>High Altitude Mode</b>.</li> <li>• If the problem persists, unplug the projector and contact Epson for help.</li> </ul>

Power light	Status light	Lamp light	Temp light	Status and solution
Off	Flashing blue	Orange	Off	Lamp has a problem. <ul style="list-style-type: none"> <li>• Check to see if the lamp is burned out, broken, or installed incorrectly. Reseat or replace the lamp as necessary.</li> <li>• Clean or replace the air filter.</li> <li>• If operating the projector at high altitude, turn on <b>High Altitude Mode</b>.</li> <li>• If the problem persists, unplug the projector and contact Epson for help.</li> </ul>
Flashing blue	Varies	Flashing orange	Varies	Replace the lamp soon to avoid damage. Do not continue using the projector.
Off	Flashing blue	Off	Flashing orange	A fan or sensor has a problem. Turn the projector off, unplug it, and contact Epson for help.
Off	Flashing blue	Flashing orange	Flashing orange	Auto Iris error. Turn the projector off, unplug it, and contact Epson for help.
Off	Flashing blue	Orange	Orange	Power error. Turn the projector off, unplug it, and contact Epson for help.
Off	Flashing blue	Flashing orange	Off	Internal projector error. Turn the projector off, unplug it, and contact Epson for help.

**Note:** If the lights display a pattern not listed in the table above, turn the projector off, unplug it, and contact Epson for help.

**Parent topic:** [Solving Problems](#)

**Related references**

[Projector Feature Settings - Settings Menu](#)

[Projector Setup Settings - Extended Menu](#)

[Where to Get Help](#)

**Related tasks**

[Cleaning the Air Filter and Vents](#)

[Replacing the Air Filter](#)

[Replacing the Lamp](#)

## Using the Projector Help Displays

You can display information to help you solve common problems using the projector's Help system.

1. Turn on the projector.
2. Press the **Home** button on the projector or the remote control.
3. Press the arrow buttons to select **Help**.
4. Press **Enter**.  
You see the Help menu.
5. Press the up and down arrow buttons to highlight the problem you want to solve.
6. Press **Enter** to view the solutions.
7. When you are finished, do one of the following:
  - To select another problem to solve, press **Esc**.
  - To exit the help system, press **Home**.

**Parent topic:** [Solving Problems](#)

## Solving Image or Sound Problems

Check the solutions in these sections if you have any problems with projected images or sound.

[Solutions When No Image Appears](#)

[Solutions When Image is Incorrect Using the USB Display Function](#)

[Solutions When "No Signal" Message Appears](#)

[Solutions When "Not Supported" Message Appears](#)

[Solutions When Only a Partial Image Appears](#)

[Solutions When the Image is Not Rectangular](#)

[Solutions When the Image Contains Noise or Static](#)

[Solutions When the Image is Fuzzy or Blurry](#)

[Solutions When the Image Brightness or Colors are Incorrect](#)

[Solutions to Sound Problems](#)  
[Solutions to Microphone Problems](#)  
**Parent topic:** [Solving Problems](#)

## Solutions When No Image Appears

If no image appears, try the following solutions:

- Press the **A/V Mute** button on the remote control to see if the image was temporarily turned off.
- Make sure all necessary cables are securely connected and the power is on for the projector and connected video sources.
- If you connected your video source to the **Monitor Out/Computer2** port, make sure you set the **Monitor Out Port** setting to **Computer2**.
- Press the projector's power button to wake it from standby or sleep mode. Also see if your connected computer is in sleep mode or displaying a blank screen saver.
- Press the **Menu** button. If the projector menu is able to display, there may be a problem with the connected video source, cable connection, or port.
- Check the settings on the Signal menu to make sure they are correct for the current video source.
- Adjust the **Brightness** setting or select the **Normal** Power Consumption setting.
- Check the **Display** setting to make sure **Messages** is set to **On**.
- If the projector does not respond when you press the control panel buttons, the buttons may be locked. Unlock the buttons.
- If the projector does not respond when you press buttons on the remote control, make sure the remote receivers are turned on.
- For images projected with Windows Media Center, reduce the screen size from full screen mode.
- For images projected from applications using Windows DirectX, turn off DirectX functions.
- If the other solutions do not solve the problem, reset all of the projector settings using the options on the **Reset** menu.
- The projector may not be able to project copyrighted videos that you play back on a computer. For more details, see the manual supplied with the computer.

**Parent topic:** [Solving Image or Sound Problems](#)

### Related references

[Projector Setup Settings - Extended Menu](#)  
[Projector Feature Settings - Settings Menu](#)



[Input Signal Settings - Signal Menu](#)  
[Image Quality Settings - Image Menu](#)

**Related tasks**

[Unlocking the Projector's Buttons](#)

## **Solutions When Image is Incorrect Using the USB Display Function**

If no image appears or if the image appears incorrectly using the USB Display function, try the following solutions:

- Press the **USB** button on the remote control.
- Make sure the USB Display software has installed correctly. Install it manually if necessary.
- Make sure the **USB Type B** setting in the Extended menu is set to one of the **USB Display** options.
- On a Mac, select the **USB Display** icon in the Dock or from the **Applications** folder.
- For images projected with Windows Media Center, reduce the screen size from full screen mode.
- For images projected from applications using Windows DirectX, turn off DirectX functions.
- If the mouse cursor flickers, select **Make the movement of the mouse pointer smooth** in the Epson USB Display Settings program on your computer.
- Turn off the **Transfer layered window** setting in the Epson USB Display Settings program on your computer.
- Make sure you are using the most recent version of the USB Display software. You can download the latest version from the Epson web site. Go to [epson.com/support](http://epson.com/support) (U.S.) or [epson.ca/support](http://epson.ca/support) (Canada) and select your projector.

**Parent topic:** [Solving Image or Sound Problems](#)

## **Solutions When "No Signal" Message Appears**

If the "No Signal" message appears, try the following solutions:

- Press the **Source Search** button and wait a few seconds for an image to appear.
- Press the **Home** button on the remote control to select from a list of available sources (shown in black text).
- Turn on the connected computer or video source, and press its play button to begin your presentation, if necessary.
- Check the connection from the projector to your video sources.
- If you are projecting from a laptop computer, make sure it is set up to display on an external monitor.

- If necessary, turn the projector and the connected computer or video source off and then on again.
- If the other solutions do not solve the problem, reset all of the projector settings using the options on the **Reset** menu.

[Displaying From a PC Laptop](#)

[Displaying From a Mac Laptop](#)

**Parent topic:** [Solving Image or Sound Problems](#)

### Displaying From a PC Laptop

If you see the "No Signal" message when you display from a PC laptop, you need to set up the laptop to display on an external monitor.

1. Hold down the laptop's **Fn** key and press the key labeled with a monitor icon or **CRT/LCD**. (See your laptop manual for details.) Wait a few seconds for an image to appear.
2. To display on both the laptop's monitor and the projector, try pressing the same keys again.
3. If the same image is not displayed by the laptop and projector, check the Windows **Display** utility to make sure the external monitor port is enabled and extended desktop mode is disabled. (See your computer or Windows manual for instructions.)
4. If necessary, check your video card settings and set the multiple display option to **Mirror** or **Duplicate**.

**Parent topic:** [Solutions When "No Signal" Message Appears](#)

### Displaying From a Mac Laptop

If you see the "No Signal" message when you display from a Mac laptop, you need to set up the laptop for mirrored display. (See your laptop manual for details.)

1. Open the **System Preferences** utility and select **Displays**.
2. Click the **Arrangement** tab.
3. Select the **Mirror Displays** checkbox.

**Parent topic:** [Solutions When "No Signal" Message Appears](#)

### Solutions When "Not Supported" Message Appears

If the "Not Supported" message appears, try the following solutions:

- Make sure the correct input signal is selected on the Signal menu.
- Make sure the computer's display resolution does not exceed the projector's resolution and frequency limit. If necessary, select a different display resolution for your computer. (See your computer manual for details.)

- As a test, try setting the computer's display resolution to the lowest possible setting, and then gradually increase it as necessary.

**Parent topic:** [Solving Image or Sound Problems](#)

**Related references**

[Input Signal Settings - Signal Menu](#)

[Supported Video Display Formats](#)

## Solutions When Only a Partial Image Appears

If only a partial computer image appears, try the following solutions:

- Press the **Auto** button on the remote control to optimize the image signal.
- Try adjusting the image position using the **Position** menu setting.
- Press the **Aspect** button on the remote control to select a different image aspect ratio.
- If you zoomed into or out of the image using the **E-Zoom** buttons, press the **Esc** button until the projector returns to a full display.
- Check your computer display settings to disable dual display and set the resolution within the projector's limits. (See your computer manual for details.)
- Check the resolution assigned to your presentation files to see if they are created for a different resolution than you are projecting in. (See your software help for details.)
- Make sure you selected the correct **Projection** setting.
- Try adjusting the image position using the **Image Shift** setting.

**Parent topic:** [Solving Image or Sound Problems](#)

**Related references**

[Input Signal Settings - Signal Menu](#)

[Supported Video Display Formats](#)

## Solutions When the Image is Not Rectangular

If the projected image is not evenly rectangular, try the following solutions:

- If the projector is not mounted on the wall or ceiling, place it directly in front of the center of the screen, facing it squarely, if possible.
- Use the **Image Shift** setting to adjust the image position, rather than moving the projector.
- Adjust the image shape using the **Geometry Correction** menu settings.

**Note:** Adjusting **Quick Corner** and **H/V-Keystone** settings may affect focus and pen calibration.

**Parent topic:** [Solving Image or Sound Problems](#)

**Related references**

[Projector Feature Settings - Settings Menu](#)

**Related tasks**

[Correcting Image Shape with the Keystone Buttons](#)

[Correcting Image Shape with Quick Corner](#)

[Correcting Image Shape with Arc Correction](#)

[Adjusting the Image Position](#)

## Solutions When the Image Contains Noise or Static

If the projected image seems to contain electronic interference (noise) or static, try the following solutions:

- Check the cables connecting your computer or video source to the projector. They should be:
  - Separated from the power cord to prevent interference
  - Securely connected at both ends
  - Not connected to an extension cable
  - No longer than 10 feet (3 m) for VGA/computer cables or 24 feet (7.3 m) for HDMI cables
- Check the settings on the projector's Signal menu to make sure they match the video source. If available for your video source, adjust the **Deinterlacing** and **Noise Reduction** settings.
- Select **Auto** as the Resolution setting in the Signal menu.
- Select a computer video resolution and refresh rate that are compatible with the projector.
- If you are projecting from a computer, press the **Auto** button on the remote control to automatically adjust the tracking and sync. If the problem remains, display a uniformly patterned image on the screen and manually adjust the **Tracking** and **Sync** settings.
- If you adjusted the image shape using the projector controls, try decreasing the **Sharpness** setting to improve image quality.
- If you are using the USB Display function, turn off the **Transfer layered window** setting in the Epson USB Display Settings program on your computer.

**Parent topic:** [Solving Image or Sound Problems](#)

### Related references

[Input Signal Settings - Signal Menu](#)  
[Supported Video Display Formats](#)

### Related tasks

[Displaying From a PC Laptop](#)  
[Displaying From a Mac Laptop](#)

## Solutions When the Image is Fuzzy or Blurry

If the projected image is fuzzy or blurry, try the following solutions:

- Adjust the image focus.
- Clean the projection window.

**Note:** To avoid condensation on the lens after bringing the projector in from a cold environment, let the projector warm up to room temperature before using it.

- Position the projector close enough to the screen, and directly in front of it.
- Position the projector so the keystone adjustment angle is not so wide that it distorts the image.
- Adjust the **Sharpness** setting to improve image quality.
- If you are projecting from a computer, press the **Auto** button on the remote control to automatically adjust the tracking and sync. If any bands or overall blurriness remain, display a uniformly patterned image on the screen and manually adjust the **Tracking** and **Sync** settings.
- If you are projecting from a computer, use a lower resolution.
- Turn off any keystone correction and disable the **Quick Corner** and **Arc Correction** settings.

**Parent topic:** [Solving Image or Sound Problems](#)

## Solutions When the Image Brightness or Colors are Incorrect

If the projected image is too dark or light, or the colors are incorrect, try the following solutions:

- Press the **Color Mode** button on the remote control to try different color modes for the image and environment.
- Check your video source settings.
- Adjust the available settings on the Image menu for the current input source, such as **Brightness**, **Contrast**, **Tint**, **Color Temp.**, and/or **Color Saturation**.

- Make sure you selected the correct **Input Signal** or **Video Signal** setting on the Signal menu, if available for your image source.
- Make sure all the cables are securely connected to the projector and your video device. If you connected long cables, try connecting shorter cables.
- If you are using the **ECO** or **ECO2** Power Consumption setting, try selecting **Normal** in the projector's menus.
- Position the projector close enough to the screen.
- If the image has been progressively darkening, you may need to replace the projector lamp soon.

**Parent topic:** [Solving Image or Sound Problems](#)

**Related concepts**

[Projector Lamp Maintenance](#)

**Related references**

[Input Signal Settings - Signal Menu](#)

[Projector Feature Settings - Settings Menu](#)

[Image Quality Settings - Image Menu](#)

## Solutions to Sound Problems

If there is no sound when you expect it or the volume is too low or high, try the following solutions:

- Adjust the projector's volume settings.
- Press the **A/V Mute** button on the remote control to resume video and audio if they were temporarily stopped.
- Press the **Source Search** button to switch to the correct input source, if necessary.
- Check your computer or video source to make sure the volume is turned up and the audio output is set for the correct source.
- Check the audio cable connections between the projector and your video source.
- If you do not hear sound from an HDMI source, set the connected device to PCM output.
- Make sure any connected audio cables are labeled "No Resistance".
- If you are using the USB Display function, turn on the **Output audio from the projector** setting in the Epson USB Display Settings program on your computer.
- If you are using a Mac and you do not hear sound from an HDMI source, make sure your Mac supports audio through the HDMI port. If not, you need to connect an audio cable.

- If you want to use a connected audio source when the projector is off, set the **Standby Mode** option to **Communication On** and the **A/V Output** option to **Always On**.
- Make sure the **Audio Output** option is set to the correct audio port for your video device.
- If you turn the projector on immediately after turning it off, the cooling fans may run at high speed momentarily and cause an unexpected noise. This is normal.

**Parent topic:** [Solving Image or Sound Problems](#)

## Solutions to Microphone Problems

If there is no sound when you use a microphone connected to the projector, try the following solutions:

- Make sure the microphone is securely connected to the projector.
- Make sure you are using a dynamic microphone, not a condenser microphone.
- Adjust the **Mic Input Level** setting as necessary in the projector's menus.
- If you want to use the microphone when the projector is off, set the **Standby Mode** option to **Communication On**.

**Parent topic:** [Solving Image or Sound Problems](#)

### Related references

[Projector Setup Settings - Extended Menu](#)

[Projector Feature Settings - Settings Menu](#)

### Related tasks

[Connecting a Microphone](#)

## Solving Projector or Remote Control Operation Problems

Check the solutions in these sections if you have problems operating the projector or remote control.

[Solutions to Projector Power or Shut-Off Problems](#)

[Solutions to Problems with the Remote Control](#)

[Solutions to Password Problems](#)

**Parent topic:** [Solving Problems](#)

## Solutions to Projector Power or Shut-Off Problems

If the projector does not come on when you press the power button or it shuts off unexpectedly, try the following solutions:

- Make sure the power cord is securely connected to the projector and to a working electrical outlet.

- The projector's buttons may be locked for security. Unlock the buttons or use the remote control to turn on the projector.
- If the projector's lamp shuts off unexpectedly, it may have entered standby mode after a period of inactivity. Press the power button to wake the projector and adjust the **Sleep Mode Timer** setting to change the sleep interval.
- If the projector's lamp shuts off and the power and Temp lights are red, the projector has overheated and shut off. Check the solutions for this light status.
- If the power button on the remote control does not turn on the projector, check its batteries and make sure the **Remote Receiver** setting is turned on in the projector's menu, if available.
- The power cord may be defective. Disconnect the cord and contact Epson.

**Parent topic:** [Solving Projector or Remote Control Operation Problems](#)

**Related references**

[Projector Light Status](#)

[Projector Feature Settings - Settings Menu](#)

**Related tasks**

[Unlocking the Projector's Buttons](#)

## Solutions to Problems with the Remote Control

If the projector does not respond to remote control commands, try the following solutions:

- Check that the remote control batteries are installed correctly and have power. If necessary, replace the batteries.
- Make sure you are operating the remote control within the reception angle and range of the projector.
- Make sure the projector is not warming up or shutting down.
- Check to see if a button on the remote control is stuck down, causing it to enter sleep mode. Release the button to wake the remote control up.
- Strong fluorescent lighting, direct sunlight, or infrared device signals may be interfering with the projector's remote receivers. Dim the lights or move the projector away from the sun or interfering equipment.
- If available, turn off one of the remote receivers in the projector's menu system, or check if all the remote receivers were turned off.
- If you assigned an ID number to the remote control to operate multiple projectors, you may need to check or change the ID setting (feature not available with all projectors).
- If you lose the remote control, you can purchase another from an authorized Epson reseller.



**Parent topic:** [Solving Projector or Remote Control Operation Problems](#)

**Related references**

[Projector Feature Settings - Settings Menu](#)

[Optional Equipment and Replacement Parts](#)

[Remote Control Operation](#)

## Solutions to Password Problems

If you cannot enter or remember a password, try the following solutions:

- You may have turned on password protection without first setting a password. Try entering **0000** using the remote control.
- If you have entered an incorrect password too many times and see a message displaying a request code, write down the code and contact Epson. Do not attempt to enter the password again. Provide the request code and proof of ownership for assistance in unlocking the projector.
- If you set a Web Control password and forgot the user ID or password, try entering the following:
  - User ID: **EPSONWEB**
  - Default password: **admin**
- If you set a Remote password (in Epson Web Control) and forgot the user ID or password, try entering the following:
  - User ID: **EPSONREMOTE**
  - Default password: **guest**
- If you lose the remote control, you cannot enter a password. Order a new one from Epson.

**Parent topic:** [Solving Projector or Remote Control Operation Problems](#)

## Solving Interactive Problems

Check the solutions in these sections if you have problems using the interactive system.

[Solutions When "Error Occurred in the Easy Interactive Function" Message Appears](#)

[Solutions When the Interactive Pens Do Not Work](#)

[Solutions When the Interactive Pen Position Is Not Accurate](#)

[Solutions When Manual Calibration Does Not Work](#)

[Solutions When the Interactive Pens Are Slow or Difficult to Use](#)

[Solutions When the Interactive Pens Cause Interference or Unwanted Effects](#)

[Solutions When Finger Touch Interactivity Does Not Work](#)

Parent topic: [Solving Problems](#)

## Solutions When "Error Occurred in the Easy Interactive Function" Message Appears

If the "Error occurred in the Easy Interactive Function" message appears, contact Epson for help.

Parent topic: [Solving Interactive Problems](#)

Related references

[Where to Get Help](#)

## Solutions When the Interactive Pens Do Not Work

If the interactive pens do not work, try the following solutions:

- The pens turn off automatically when not in use. Pick up the pen to turn it back on.
- Make sure you are not covering the black section near the tip of the pen.
- Make sure the pen tip is securely attached to the pen.
- If the pen tip is worn out, dirty, or damaged, you may need to replace it.
- Try replacing the soft pen tip with the hard pen tip.
- Make sure nothing is blocking the signal between the pen and the interactive pen receiver on the projector.
- Try holding the pen at a different angle so that your hand is not blocking the signal.
- Make sure the cable cover is in place to keep cables from blocking the signal.
- Make sure the pen battery has enough power. Press the button on the side of the pen to check remaining battery power. Try replacing the battery.
- If you are projecting from a computer, make sure the USB cable is connected to the computer and projector.
- Dim the room lights and turn off any fluorescent lights. Make sure the projection surface and pen receiver are not in direct sunlight or other sources of bright lighting.
- Remove any decorative lights from around the projector or projection surface.
- Make sure the interactive pen receiver on the projector is clean and free from dust.
- Make sure there is no interference from infrared remote controls, mice, or infrared microphones.
- Make sure the **USB Type B** option on the Extended menu is set to **Easy Interactive Function** or **USB Display/Easy Interactive Function**.
- Make sure you have calibrated the system. Try recalibrating.

- Make sure the **Pen Mode** and **Pen Operation Mode** settings are set correctly in the **Easy Interactive Function** options on the Extended menu.
- If you are using multiple projectors in the same room, change the **Distance of Projectors** setting in **Easy Interactive Function** on the Extended menu.

Parent topic: [Solving Interactive Problems](#)

## Solutions When the Interactive Pen Position Is Not Accurate

If the pen position is not the same as the mouse pointer, try the following solutions:

- Make sure you have calibrated the system. Try manual calibration.
- Make sure the cable cover is in place to keep cables from blocking the signal.
- Try adjusting the pen operation area.
- Turn off any keystone correction and disable the **Quick Corner** and **Arc Correction** settings.
- If you use the **E-Zoom +** button on the remote control to enlarge the image, the pen position is not accurate. When you return the image to the original size, the position should be correct.
- In PC Interactive mode (in the **Extended > Advanced** menu), turn off **Auto Adjust Pen Area** and select **Manual Adj. Pen Area**.
- Try changing the computer's resolution to 1280 × 800.
- Select **Reset All Config** from the Reset menu to restore the projector settings to their default values.

Parent topic: [Solving Interactive Problems](#)

## Solutions When Manual Calibration Does Not Work

If you are having trouble calibrating manually, try the following solutions:

- If the circle does not move to the next position, or it moves automatically, dim or turn off any bright lights near the projection surface.
- Make sure the projector is not too close to the projection surface.
- Select **Reset All Config** from the Reset menu to restore the projector settings to their default values.

Parent topic: [Solving Interactive Problems](#)

## Solutions When the Interactive Pens Are Slow or Difficult to Use

If the pens are difficult to use or respond too slowly, try the following solutions:

- For easier operation, hold the pen perpendicular to the projection surface.

- For the best performance, connect your computer to the projector using a VGA or HDMI cable for display and the USB cable for interactivity.
- If you are using USB Display in Windows, you may need to disable Windows Aero in the Epson USB Display Settings program on your computer.
- If you are having difficulty double-clicking on a Mac, go to the **System Preferences** menu, select **Mouse, Trackpad, or Mouse & Trackpad**, and reduce the **Double-click speed**.

Parent topic: [Solving Interactive Problems](#)

## Solutions When the Interactive Pens Cause Interference or Unwanted Effects

If the pens are causing interference or unwanted effects, try the following solutions:

- When you use two pens at the same time, make sure to use them at least 4 inches (10.16 cm) apart.
- Do not rest the pens on the image area of an interactive table to avoid interference with your computer's mouse.
- Make sure that nothing is blocking the direct line to the infrared site on the projector.
- Turn off hovering.

Parent topic: [Solving Interactive Problems](#)

## Solutions When Finger Touch Interactivity Does Not Work

If finger touch interactivity does not work (BrightLink 695Wi), try the following solutions:

- Make sure the Touch Unit is installed correctly and the power cable is properly connected. See your projector's *Touch Unit and Control Pad Installation Guide* for details.
- If the light on the Touch Unit is not on, check the **Touch Unit Setup** settings in the **Easy Interactive Function** option on the Extended menu and make sure the **Power** setting is set to **On**.
- Adjust the angle on the Touch Unit. See your projector's *Touch Unit and Control Pad Installation Guide* for details.
- Make sure there are no obstacles (such as cables or pen trays) between the Touch Unit's laser diffusion ports and the projection surface.
- Remove any decorative lights from around the projector or projection surface.
- If you are having difficulty double-clicking on a Mac, go to the **System Preferences** menu, select **Mouse, Trackpad, or Mouse & Trackpad**, and reduce the **Double-click speed**.
- Make sure there is no interference from infrared remote controls, mice, or infrared microphones.
- Make sure you have performed pen calibration and finger touch calibration. Try recalibrating.

- If touch operation does not work correctly even after calibration, press the  icon on the Home screen and check the **Calibration Range** setting. Select **Wide** if you drag items when touching the screen, or **Narrow** if mouse operations do not work smoothly.

Parent topic: [Solving Interactive Problems](#)

## Solving Network Problems

Check the solutions in these sections if you have problems using the projector on a network.

[Solutions When Network Alert E-Mails are Not Received](#)

[Solutions When You Cannot Access the Projector Through the Web](#)

Parent topic: [Solving Problems](#)

### Solutions When Network Alert E-Mails are Not Received

If you do not receive an e-mail alerting you to problems with a projector over the network, try the following solutions:

- Make sure the projector is turned on and connected to the network correctly. (If an error shut down the projector, it cannot send an e-mail.)
- Make sure you set up the projector e-mail alert settings correctly on the projector's network Mail menu or in the network software.
- Set the **Standby Mode** setting to **Communication On** so the network software can monitor the projector in standby mode.

Parent topic: [Solving Network Problems](#)

#### Related concepts

[Wired Network Projection](#)

[Wireless Network Projection](#)

#### Related references

[Projector Setup Settings - Extended Menu](#)

[Projector Network Settings - Network Menu](#)

### Solutions When You Cannot Access the Projector Through the Web

If you are unable to access the projector through a web browser, make sure you are using the correct ID and password, which are case sensitive.

**Note:** You cannot change the user ID.

- To display the Web Control screen, enter **EPSONWEB** as the user ID, and enter the password set in the projector's Network menu as the password. The default password is **admin**.
- To display the Web Remote screen, enter **EPSONREMOTE** as the user ID and enter the password set in the projector's Network menu as the password. The default password is **guest**.
- Make sure you have access to the network the projector is on.

**Note:** The user ID and password are case sensitive.

**Parent topic:** [Solving Network Problems](#)

## Where to Get Help

If you need to contact Epson for technical support services, use the following support options.

### Internet Support

Visit Epson's support website at [epson.com/support](http://epson.com/support) (U.S.), [epson.ca/support](http://epson.ca/support) (Canada), or [epson.com.jm/support](http://epson.com.jm/support) (Caribbean) and select your product for solutions to common problems with your projector. You can download utilities and documentation, get FAQs and troubleshooting advice, or e-mail Epson with your questions.

### Speak to a Support Representative

To use the Epson PrivateLine Support service, call (800) 637-7661. This service is available for the duration of your warranty period. You may also speak with a projector support specialist by dialing (562) 276-4394 (U.S.) or (905) 709-3839 (Canada).

Support hours are 6 AM to 8 PM, Pacific Time, Monday through Friday and 7 AM to 4 PM, Pacific Time, Saturday.

Days and hours of support are subject to change without notice. Toll or long distance charges may apply.

Before you call, have the following information ready:

- Product name
- Product serial number (located on the bottom or rear of the projector, or in the menu system)
- Proof of purchase (such as a store receipt) and date of purchase
- Computer or video configuration

- Description of the problem

### **Purchase Supplies and Accessories**

You can purchase screens, other optional accessories, and replacement parts from an Epson authorized reseller. To find the nearest reseller, call 800-GO-EPSON (800-463-7766) in the U.S. or 800-807-7766 in Canada. Or you can purchase online at [epsonstore.com](http://epsonstore.com) (U.S. sales) or [epsonstore.ca](http://epsonstore.ca) (Canadian sales).

To purchase a replacement remote control, call (562) 276-4394 (U.S.) or (905) 709-3839 (for dealer referral in Canada).

**Parent topic:** [Solving Problems](#)

---

# Technical Specifications

These sections list the technical specifications of your projector.

[General Projector Specifications](#)

[Projector Lamp Specifications](#)

[Remote Control Specifications](#)

[Projector Dimension Specifications](#)

[Projector Electrical Specifications](#)

[Projector Environmental Specifications](#)

[Projector Safety and Approvals Specifications](#)

[Supported Video Display Formats](#)

[USB Display System Requirements](#)

## General Projector Specifications

<b>Type of display</b>	Poly-silicon TFT active matrix
<b>Resolution</b>	1280 × 800 pixels (WXGA)
<b>Lens</b>	F=1.60 Focal length: 3.7 mm
<b>Color reproduction</b>	Full color, up to 1 billion
<b>Brightness</b>	Normal Power Consumption mode: White light output 3500 lumens (ISO 21118 standard) Color light output 3500 lumens ECO Power Consumption mode: White light output 2900 lumens (ISO 21118 standard)
	<b>Note:</b> Color brightness (color light output) and white brightness (white light output) will vary depending on usage conditions. Color light output measured in accordance with IDMS 15.4; white light output measured in accordance with ISO 21118.
<b>Contrast ratio</b>	14000 to 1 with Auto Iris on and Normal Power Consumption mode



<b>Image size</b> (in native aspect ratio)	60 inches (1.52 m) to 99 inches (2.51 m)
<b>Projection distance</b> (in native aspect ratio)	13.9 inches (35.4 cm) to 23.7 inches (60.1 cm)
<b>Projection methods</b>	Front, rear, ceiling-mounted
<b>Optical aspect ratio</b> (width-to-height)	16:10
<b>Focus adjustment</b>	Manual
<b>Zoom adjustment</b>	Digital
<b>Zoom ratio</b> (Tele-to-Wide)	1:1.35
<b>Internal sound system</b>	16 W monaural
<b>Noise level</b>	35 dB (Normal Power Consumption mode) 30 dB (ECO Power Consumption mode) 29 dB (ECO2 Power Consumption mode)
<b>Keystone correction angle</b>	Vertical: $\pm 3^\circ$ Horizontal: $\pm 3^\circ$
<b>USB Type B port compatibility</b>	One USB 2.0 compliant for USB display, external mouse, firmware update, or interactivity
<b>USB Type A port compatibility</b>	One USB 1.1 and 2.0 compliant port for USB device input, wireless LAN unit, or Epson document camera display

Parent topic: [Technical Specifications](#)

## Projector Lamp Specifications

<b>Type</b>	UHE (Ultra High Efficiency)
<b>Power consumption</b>	250 W

<b>Lamp life</b>	Normal Power Consumption mode: up to about 5000 hours ECO Power Consumption mode: up to about 10000 hours ECO2 Power Consumption mode: up to about 9000 hours
------------------	---

**Note:** Turn off this product when not in use to prolong the life of the projector. Lamp life will vary depending upon mode selected, environmental conditions, and usage. Brightness decreases over time.

Parent topic: [Technical Specifications](#)

## Remote Control Specifications

<b>Reception range</b>	19.7 feet (6 m)
<b>Batteries</b>	Two alkaline or manganese AA

Parent topic: [Technical Specifications](#)

## Projector Dimension Specifications

<b>Height</b> (excluding feet)	5.9 inches (149 mm)
<b>Width</b>	14.4 inches (367 mm)
<b>Depth</b>	15.7 inches (400 mm)
<b>Weight</b>	12.8 lb (5.8 kg)

Parent topic: [Technical Specifications](#)

## Projector Electrical Specifications

<b>Rated frequency</b>	50/60 Hz
<b>Power supply</b>	100 to 240 VAC $\pm$ 10% 3.8 to 1.7 A

**Power consumption**

(100 to 120 V)

**Operating:**

Normal Power Consumption mode: 373 W

ECO Power Consumption mode: 324 W

ECO2 Power Consumption mode: 324 W

**Standby:**

0.23 W (Energy Saving), 2.2 W (Networked Standby)

**Power consumption**

(220 to 240 V)

**Operating:**

Normal Power Consumption mode: 354 W

ECO Power Consumption mode: 309 W

ECO2 Power Consumption mode: 309 W

**Standby:**

0.37 W (Energy Saving), 2.3 W (Networked Standby)

Parent topic: [Technical Specifications](#)

## Projector Environmental Specifications

**Temperature****Single projector:**

Operating up to 7500 feet (2286 m): 41 to 104 °F (5 to 40 °C)

Operating up to 9854 feet (3000 m): 41 to 95 °F (5 to 35 °C)

Storage: 14 to 140 °F (–10 to 60 °C)

**Multiple projectors:**

Operating up to 7500 feet (2286 m): 41 to 95 °F (5 to 35 °C)

Operating up to 9854 feet (3000 m): 41 to 86 °F (5 to 30 °C)

Storage: 14 to 140 °F (–10 to 60 °C)

**Humidity** (relative, non-condensing)

Operating: 20 to 80%

Storage: 10 to 90%

**Operating altitude**

Up to 4921 feet (1500 m)

Up to 9843 feet (3000 m) with High Altitude Mode enabled

Parent topic: [Technical Specifications](#)

## Projector Safety and Approvals Specifications

<b>United States</b>	FCC Part 15 Class B UL60950-1
<b>Canada</b>	ICES-003 Class B CSA C22.2 No. 60950-1

Parent topic: [Technical Specifications](#)

## Supported Video Display Formats

For best results, your computer's monitor port or video card resolution should be set to display in the projector's native resolution. However, your projector includes Epson's SizeWise chip that supports other computer display resolutions, so your image will be resized to fit automatically.

Your computer's monitor port or video card refresh rate (vertical frequency) must be compatible with the projector. (See your computer or video card manual for details.)

The table here lists the compatible refresh rate and resolution for each compatible video display format.

Display format	Refresh rate (in Hz)	Resolution (in pixels)
<b>Computer signals (analog RGB)</b>		
VGA	60/72/75/85	640 × 480
SVGA	60/72/75/85	800 × 600
XGA	60/70/75/85	1024 × 768
WXGA	60	1280 × 768
	60	1366 × 768
	60/75/85	1280 × 800
WXGA+	60/75/85	1440 × 900
WXGA++	60	1600 × 900

Display format	Refresh rate (in Hz)	Resolution (in pixels)
SXGA	70/75/85	1152 × 864
	60/75/85	1280 × 1024
	60/75/85	1280 × 960
SXGA+	60/75	1400 × 1050
WSXGA+	60	1680 × 1050
UXGA	60	1600 × 1200
<b>Composite video</b>		
TV (NTSC)	60	720 × 480
TV (SECAM)	50	720 × 576
TV (PAL)	50/60	720 × 576
<b>Component video</b>		
SDTV (480i)	60	720 × 480
SDTV (576i)	50	720 × 576
SDTV (480p)	60	720 × 480
SDTV (576p)	50	720 × 576
HDTV (720p)	50/60	1280 × 720
HDTV (1080i)	50/60	1920 × 1080
<b>HDMI input signals</b>		
VGA	60	640 × 480
SVGA	60	800 × 600
XGA	60	1024 × 768
WXGA	60	1280 × 800
	60	1366 × 768
WXGA+	60	1440 × 900
WXGA++	60	1600 × 900
WSXGA+*	60	1680 × 1050

Display format	Refresh rate (in Hz)	Resolution (in pixels)
SXGA	60	1280 × 960
	60	1280 × 1024
SXGA+	60	1400 × 1050
UXGA	60	1600 × 1200
SDTV (480i/480p)	60	720 × 480
SDTV (576i/576p)	50	720 × 576
HDTV (720p)	50/60	1280 × 720
HDTV (1080i)	50/60	1920 × 1080
HDTV (1080p)	24/30/50/60	1920 × 1080
<b>MHL input signals</b>		
VGA	60	640 × 480
SDTV (480i/480p)	60	720 × 480
SDTV (576i/576p)	50	720 × 576
HDTV (720p)	50/60	1280 × 720
HDTV (1080i)	50/60	1920 × 1080
HDTV (1080p)	24/30	1920 × 1080

\* **Wide** resolution only

Parent topic: [Technical Specifications](#)

## USB Display System Requirements

Your computer system must meet the system requirements here to use the projector's USB Display software.

<b>Requirement</b>	<b>Windows</b>	<b>Mac</b>
Operating system	Windows Vista Ultimate, Enterprise, Business, Home Premium, and Home Basic (32-bit)	Mac OS X 10.5.x (32-bit), and 10.6.x, 10.7.x , 10.8.x, 10.9.x, 10.10.x, and 10.11.x (32- and 64-bit); macOS 10.12.x (32- and 64-bit)
	Windows 7 Ultimate, Enterprise, Professional, and Home Premium (32- and 64-bit); Home Basic and Starter (32-bit)	
	Windows 8.x, Pro, and Enterprise (32- and 64-bit)	
	Windows 10 Home, Pro, and Enterprise (32- and 64-bit)	
USB version	USB 2.0	
CPU	Intel Core2 Duo or faster (Intel Core i3 or faster recommended)	Intel Core2 Duo or faster (Intel Core i5 or faster recommended)
Memory	2GB or more (4GB or more recommended)	
Hard disk space	20MB or more	
Display	Resolution between 640 × 480 and 1920 × 1200, 16-bit color or greater	

**Parent topic:** [Technical Specifications](#)

---

## Notices

Check these sections for important notices about your projector.

[Recycling](#)

[Important Safety Information](#)

[Important Safety Instructions](#)

[List of Safety Symbols \(corresponding to IEC60950-1 A2\)](#)

[FCC Compliance Statement](#)

[Open Source Software License](#)

[Binding Arbitration and Class Waiver](#)

[Trademarks](#)

[Copyright Notice](#)

## Recycling

Epson offers a recycling program for end of life products. Please go to [this site](#) for information on how to return your products for proper disposal.

**Parent topic:** [Notices](#)

## Important Safety Information

**Caution:** Never look into the projector lens when the lamp is turned on; the bright light can damage your eyes. Never let children look into the lens when it is on. Never open any cover on the projector, except the lamp and filter covers. Dangerous electrical voltages inside the projector can severely injure you. Except as specifically explained in this *User's Guide*, do not attempt to service this product yourself. Refer all servicing to qualified service personnel.

**Warning:** The projector and its accessories come packaged in plastic bags. Keep plastic bags away from small children to avoid any risk of suffocation.

**Caution:** When you replace the lamp, never touch the new lamp with your bare hands; the invisible residue left by the oil on your hands may shorten the lamp life. Use a cloth or glove to handle the new lamp.

**Parent topic:** [Notices](#)



## Important Safety Instructions

Follow these safety instructions when setting up and using the projector:

- Do not look into the lens when the projector is on. The bright light can damage your eyes. Avoid standing in front of the projector so the bright light does not shine into your eyes.
- Do not place your hand or any object near the projection window. The high temperature of this area could cause burns, fire, or other damage.
- Do not place the projector on an unstable cart, stand, or table.
- Do not operate the projector on its side, or while tilted to one side. Do not tilt the projector more than 3° forward or back.
- If the projector is mounted on a ceiling or wall, it should be installed by qualified technicians using mounting hardware designed for use with this projector.
- When installing or adjusting a ceiling or wall mount, do not use adhesives to prevent the screws from loosening and do not use oils or lubricants. This may cause the projector case to crack and the projector to fall from its ceiling mount. This could cause serious injury to anyone under the mount and could damage the projector.
- Do not use the projector near water, sources of heat, high-voltage electrical wires, or sources of magnetic fields.
- Use the type of power source indicated on the projector. Use of a different power source may result in fire or electric shock. If you are not sure of the power available, consult your dealer or power company.
- Place the projector near a wall outlet where the plug can be easily unplugged.
- Take the following precautions when handling the plug: Do not hold the plug with wet hands. Do not insert the plug into a dusty outlet. Insert the plug firmly into the outlet. Do not pull the power cord when disconnecting the plug; always be sure to hold the plug when disconnecting it. Do not overload wall outlets, extension cords, or power strips. Failure to comply with these precautions could result in fire or electric shock.
- Do not place the projector where the cord can be walked on. This may result in fraying or damage to the plug.
- Unplug the projector from the wall outlet and allow to cool before cleaning. Use a dry cloth (or, for stubborn dirt or stains, a moist cloth that has been wrung dry) for cleaning. Do not use liquid or aerosol cleaners, any sprays containing flammable gas, or solvents such as alcohol, paint thinner, or benzene.
- Do not block the slots and openings in the projector case. They provide ventilation and prevent the projector from overheating. Do not operate the projector on a sofa, rug, or other soft surface, or set it on top of loose papers. Do not cover the projector with a blanket, curtain, or tablecloth. If you are

setting up the projector near a wall, leave at least 7.9 inches (20 cm) of space between the wall and the projector.

- Do not operate the projector in a closed-in cabinet unless proper ventilation is provided.
- Never allow objects of any kind to enter any openings in the projector. Do not leave objects, especially flammable objects, near the projector. Never spill liquid of any kind into the projector.
- If you are using two or more projectors side-by-side, leave at least 2 feet (60 cm) of space between the projectors to allow for proper ventilation.
- You may need to clean the air filter and vent. A clogged air filter or vent can block ventilation needed to cool the projector. Do not use canned air, or the gases may leave a residue.
- Do not store the projector outdoors for an extended length of time.
- Except as specifically explained in this manual, do not attempt to service this product yourself. Refer all servicing to qualified personnel. Opening or removing covers may expose you to dangerous voltages and other hazards.
- Never open any covers on the projector except as specifically explained in this manual. Never attempt to disassemble or modify the projector. Refer all repairs to qualified service personnel.
- Unplug the projector from the wall outlet and refer servicing to qualified service personnel under the following conditions: if it does not operate normally when you follow the operating instructions, or exhibits a distinct change in performance; if smoke, strange odors, or strange noises come from the projector; if the power cord or plug is damaged or frayed; if liquid or foreign objects get inside the projector, or if it has been exposed to rain or water; if it has been dropped or the housing has been damaged.
- Do not touch the plug during an electrical storm. Otherwise, you may receive an electric shock.
- Unplug the projector when it will not be used for extended periods.
- Do not use the projector where it may be exposed to rain, water, or excessive humidity.
- Do not use or store the projector where it may be exposed to smoke, steam, corrosive gases, excessive dust, vibration, or shock.
- Do not use the projector where flammable or explosive gases may be present.
- Do not use or store the projector or remote control in a hot location, such as near a heater, in direct sunlight, or in a closed vehicle.
- If you use the projector in a country other than where you purchased it, use the correct power cord for that country.
- Do not stand on the projector or place heavy objects on it.
- Do not use the projector outside of the required temperature range below:

41 to 104 °F (5 to 40 °C) at an altitude of 7500 feet (2286 m) or less, or 41 to 95 °F (5 to 35 °C) at a higher altitude

When using multiple projectors at the same time:

Doing so may cause an unstable display and could lead to projector damage. Do not use or store the projector where it may be exposed to sudden changes in temperature.

- Do not store the projector outside of the required temperature range of 14 to 140 °F (–10 to 60 °C) or in direct sunlight for long periods of time. Doing so may cause damage to the case.
- Do not place anything that can become warped or damaged by heat near the exhaust vents. Do not bring your hands or face close to the vents while projection is in progress. Do not bring your face close to the projector while it is in use.
- Before you move the projector, make sure its power is turned off, the plug is disconnected from the outlet, and all cables are disconnected.
- Never try to remove the lamp immediately after use because it will be extremely hot. Before removing the lamp, turn off the power and wait at least an hour to allow the lamp to cool completely.
- Do not disassemble the lamp or subject it to impacts.
- Do not place the source of an open flame, such as a lit candle, on or near the projector.
- Do not modify the power cord. Do not place heavy objects on top of the power cord or bend, twist, or pull it excessively. Keep the power cord away from hot electrical appliances.
- If the lamp breaks, ventilate the room to prevent gases contained in the lamp from being inhaled or coming in contact with your eyes or mouth. If you do inhale gases or gases come in contact with your eyes or mouth, seek medical advice immediately.
- If the projector is mounted overhead and the lamp breaks, be careful to prevent pieces of glass from falling into your eyes or mouth when you open the lamp cover. If pieces of glass do get into your eyes or mouth, seek medical advice immediately.
- Always lower the volume before turning off the projector. Turning on the projector with the volume too high can damage your ears.
- Do not store the interactive pens or the batteries in a hot location, such as near a heater, in direct sunlight, or in a closed vehicle.
- Remove the batteries from the interactive pens if you will not be using the pens for a long time.

**Note:**  The lamp(s) in this product contain mercury. Please consult your state and local regulations regarding disposal or recycling. Do not put in the trash.

**WARNING:** The cords included with this product contain chemicals, including lead, known to the State of California to cause birth defects or other reproductive harm. **Wash hands after handling.** (This notice is provided in accordance with Proposition 65 in Cal. Health & Safety Code § 25249.5 and following.)

[Restriction of Use](#)

Parent topic: [Notices](#)

## Restriction of Use



When this product is used for applications requiring high reliability/safety such as transportation devices related to aviation, rail, marine, automotive; disaster prevention devices; various safety devices; or functional/precision devices, you should use this product only after giving consideration to including fail-safes and redundancies into your design to maintain safety and total system reliability.







Because this product was not intended for use in applications requiring extremely high reliability/safety such as aerospace equipment, main communication equipment, nuclear power control equipment, or medical equipment related to direct medical care, please make your own judgment on this product's suitability after a full evaluation.







Parent topic: [Important Safety Instructions](#)





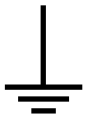



## List of Safety Symbols (corresponding to IEC60950-1 A2)

The following table lists the meaning of the safety symbols labeled on the equipment.

No.	Symbol	Approved Standards	Description
1		IEC60417 No.5007	"ON" (power) To indicate connection to the mains.
2		IEC60417 No.5008	"OFF" (power) To indicate disconnection from the mains.
3		IEC60417 No.5009	Stand-by To identify the switch or switch position by means of which part of the equipment is switched on in order to bring it into the stand-by condition.

No.	Symbol	Approved Standards	Description
4		ISO7000 No.0434B, IEC3864-B3.1	Caution To identify general caution when using the product.
5		IEC60417 No.5041	Caution, hot surface To indicate that the marked item can be hot and should not be touched without taking care.
6		IEC60417 No.6042 ISO3864-B3.6	Caution, risk of electric shock To identify equipment that has risk of electric shock.
7		IEC60417 No.5957	For indoor use only To identify electrical equipment designed primarily for indoor use.
8		IEC60417 No.5926	Polarity of DC power connector To identify the positive and negative connections (the polarity) on a piece of equipment to which a DC power supply may be connected.
9		—	Polarity of DC power connector To identify the positive and negative connections (the polarity) on a piece of equipment to which a DC. power supply may be connected.
10		IEC60417 No.5001B	Battery, general On battery powered equipment. To identify a device for instance a cover for the battery compartment, or the connector terminals.

No.	Symbol	Approved Standards	Description
11		IEC60417 No.5002	Positioning of cell To identify the battery holder itself and to identify the positioning of the cell(s) inside the battery holder.
12		—	Positioning of cell To identify the battery holder itself and to identify the positioning of the cell(s) inside the battery holder.
13		IEC60417 No.5019	Protective earth To identify any terminal which is intended for connection to an external conductor for protection against electric shock in case of a fault, or the terminal of a protective earth electrode.
14		IEC60417 No.5017	Earth To identify an earth (ground) terminal in cases where neither the symbol No.13 is explicitly required.
15		IEC60417 No.5032	Alternating current To indicate on the rating plate that the equipment is suitable for alternating current only; to identify relevant terminals.
16		IEC60417 No.5031	Direct current To indicate on the rating plate that the equipment is suitable for direct current only; to identify relevant terminals.
17		IEC60417 No.5172	Class II equipment To identify equipment meeting the safety requirements specified for Class II equipment according to IEC 61140.

No.	Symbol	Approved Standards	Description
18		ISO 3864	General prohibition To identify actions or operations that are prohibited.
19		ISO 3864	Contact prohibition To indicate injury that could occur due to touching a specific part of the equipment.
20		—	Never look into the optical lens while the projector is on.
21		—	To indicate that the marked item don't place anything on projector.
22		ISO3864 IEC60825-1	Caution, laser radiation To indicate the equipment has a laser radiation part.
23		ISO 3864	Disassembly prohibition To indicate a risk of injury, such as electric shock, if the equipment is disassembled.
24		IEC60417 No. 5266	Standby, partial standby To indicate that part of the equipment is in the ready status.
25		ISO3864 IEC60417 No. 5057	Caution, movable parts To indicate that you must keep away from movable parts according to protection standards.

Parent topic: [Notices](#)

## FCC Compliance Statement

### For United States Users

This equipment has been tested and found to comply with the limits for a Class B digital device, pursuant to Part 15 of the FCC Rules. These limits are designed to provide reasonable protection against harmful interference in a residential installation. This equipment generates, uses, and can radiate radio frequency energy and, if not installed and used in accordance with the instructions, may cause harmful interference to radio communications. However, there is no guarantee that interference will not occur in a particular installation. If this equipment does cause interference to radio and television reception, which can be determined by turning the equipment off and on, the user is encouraged to try to correct the interference by one or more of the following measures:

- Reorient or relocate the receiving antenna.
- Increase the separation between the equipment and receiver.
- Connect the equipment into an outlet on a circuit different from that to which the receiver is connected.
- Consult the dealer or an experienced radio/TV technician for help.

### WARNING

The connection of a non-shielded equipment interface cable to this equipment will invalidate the FCC Certification or Declaration of this device and may cause interference levels which exceed the limits established by the FCC for this equipment. It is the responsibility of the user to obtain and use a shielded equipment interface cable with this device. If this equipment has more than one interface connector, do not leave cables connected to unused interfaces. Changes or modifications not expressly approved by the manufacturer could void the user's authority to operate the equipment.

### For Canadian Users

CAN ICES-3(B)/NMB-3(B)

Parent topic: [Notices](#)

## Open Source Software License

### GNU GPL

This projector product includes the open source software programs which apply the GNU General Public License Version 2 or later version ("GPL Programs").

We provide the source code of the GPL Programs until five (5) years after the discontinuation of same model of this projector product.



If you desire to receive the source code of the GPL Programs, contact Epson.

These GPL Programs are WITHOUT ANY WARRANTY; without even the implied warranty of MERCHANTABILITY AND FITNESS FOR A PARTICULAR PURPOSE. See the GNU General Public License for more details.

The list of GPL Programs is as follows and the names of author are described in the source code of the GPL Programs

The list of GPL Programs

- busybox-1.21.0
- iptables-1.4.20
- linux-3.4.49
- patches
- udhcp 0.9.8
- wireless\_tools 29
- dbus-1.6.18
- EPSON original drivers
- Stonestreet One Drivers

The GNU General Public License Version 2 is as follows. You also can see the GNU General Public License Version 2 at <http://www.gnu.org/licenses/>.

## **GNU GENERAL PUBLIC LICENSE**

Version 2, June 1991

Copyright (C) 1989, 1991 Free Software Foundation, Inc., 51 Franklin Street, Fifth Floor, Boston, MA 02110-1301 USA Everyone is permitted to copy and distribute verbatim copies of this license document, but changing it is not allowed.

### **Preamble**

The licenses for most software are designed to take away your freedom to share and change it. By contrast, the GNU General Public License is intended to guarantee your freedom to share and change free software—to make sure the software is free for all its users. This General Public License applies to most of the Free Software Foundation's software and to any other program whose authors commit to using it. (Some other Free Software Foundation software is covered by the GNU Lesser General Public License instead.) You can apply it to your programs, too.

When we speak of free software, we are referring to freedom, not price. Our General Public Licenses are designed to make sure that you have the freedom to distribute copies of free software (and charge for this service if you wish), that you receive source code or can get it if you want it, that you can change the software or use pieces of it in new free programs; and that you know you can do these things.

To protect your rights, we need to make restrictions that forbid anyone to deny you these rights or to ask you to surrender the rights. These restrictions translate to certain responsibilities for you if you distribute copies of the software, or if you modify it.

For example, if you distribute copies of such a program, whether gratis or for a fee, you must give the recipients all the rights that you have. You must make sure that they, too, receive or can get the source code. And you must show them these terms so they know their rights.

We protect your rights with two steps: (1) copyright the software, and (2) offer you this license which gives you legal permission to copy, distribute and/or modify the software.

Also, for each author's protection and ours, we want to make certain that everyone understands that there is no warranty for this free software. If the software is modified by someone else and passed on, we want its recipients to know that what they have is not the original, so that any problems introduced by others will not reflect on the original authors' reputations.

Finally, any free program is threatened constantly by software patents. We wish to avoid the danger that redistributors of a free program will individually obtain patent licenses, in effect making the program proprietary. To prevent this, we have made it clear that any patent must be licensed for everyone's free use or not licensed at all.

The precise terms and conditions for copying, distribution and modification follow.

## **GNU GENERAL PUBLIC LICENSE TERMS AND CONDITIONS FOR COPYING, DISTRIBUTION AND MODIFICATION**

0. This License applies to any program or other work which contains a notice placed by the copyright holder saying it may be distributed under the terms of this General Public License. The "Program", below, refers to any such program or work, and a "work based on the Program" means either the Program or any derivative work under copyright law: that is to say, a work containing the Program or a portion of it, either verbatim or with modifications and/or translated into another language. (Hereinafter, translation is included without limitation in the term "modification".) Each licensee is addressed as "you".

Activities other than copying, distribution and modification are not covered by this License; they are outside its scope. The act of running the Program is not restricted, and the output from the Program is covered only if its contents constitute a work based on the Program (independent of having been made by running the Program). Whether that is true depends on what the Program does.

1. You may copy and distribute verbatim copies of the Program's source code as you receive it, in any medium, provided that you conspicuously and appropriately publish on each copy an appropriate copyright notice and disclaimer of warranty; keep intact all the notices that refer to this License and to the

absence of any warranty; and give any other recipients of the Program a copy of this License along with the Program.

You may charge a fee for the physical act of transferring a copy, and you may at your option offer warranty protection in exchange for a fee.

2. You may modify your copy or copies of the Program or any portion of it, thus forming a work based on the Program, and copy and distribute such modifications or work under the terms of Section 1 above, provided that you also meet all of these conditions:

a) You must cause the modified files to carry prominent notices stating that you changed the files and the date of any change.

b) You must cause any work that you distribute or publish, that in whole or in part contains or is derived from the Program or any part thereof, to be licensed as a whole at no charge to all third parties under the terms of this License.

c) If the modified program normally reads commands interactively when run, you must cause it, when started running for such interactive use in the most ordinary way, to print or display an announcement including an appropriate copyright notice and a notice that there is no warranty (or else, saying that you provide a warranty) and that users may redistribute the program under these conditions, and telling the user how to view a copy of this License. (Exception: if the Program itself is interactive but does not normally print such an announcement, your work based on the Program is not required to print an announcement.)

These requirements apply to the modified work as a whole. If identifiable sections of that work are not derived from the Program, and can be reasonably considered independent and separate works in themselves, then this License, and its terms, do not apply to those sections when you distribute them as separate works. But when you distribute the same sections as part of a whole which is a work based on the Program, the distribution of the whole must be on the terms of this License, whose permissions for other licensees extend to the entire whole, and thus to each and every part regardless of who wrote it.

Thus, it is not the intent of this section to claim rights or contest your rights to work written entirely by you; rather, the intent is to exercise the right to control the distribution of derivative or collective works based on the Program.

In addition, mere aggregation of another work not based on the Program with the Program (or with a work based on the Program) on a volume of a storage or distribution medium does not bring the other work under the scope of this License.

3. You may copy and distribute the Program (or a work based on it, under Section 2) in object code or executable form under the terms of Sections 1 and 2 above provided that you also do one of the following:

- a) Accompany it with the complete corresponding machine-readable source code, which must be distributed under the terms of Sections 1 and 2 above on a medium customarily used for software interchange; or,
- b) Accompany it with a written offer, valid for at least three years, to give any third party, for a charge no more than your cost of physically performing source distribution, a complete machine-readable copy of the corresponding source code, to be distributed under the terms of Sections 1 and 2 above on a medium customarily used for software interchange; or,
- c) Accompany it with the information you received as to the offer to distribute corresponding source code. (This alternative is allowed only for noncommercial distribution and only if you received the program in object code or executable form with such an offer, in accord with Subsection b above.)

The source code for a work means the preferred form of the work for making modifications to it. For an executable work, complete source code means all the source code for all modules it contains, plus any associated interface definition files, plus the scripts used to control compilation and installation of the executable. However, as a special exception, the source code distributed need not include anything that is normally distributed (in either source or binary form) with the major components (compiler, kernel, and so on) of the operating system on which the executable runs, unless that component itself accompanies the executable.

If distribution of executable or object code is made by offering access to copy from a designated place, then offering equivalent access to copy the source code from the same place counts as distribution of the source code, even though third parties are not compelled to copy the source along with the object code.

4. You may not copy, modify, sublicense, or distribute the Program except as expressly provided under this License. Any attempt otherwise to copy, modify, sublicense or distribute the Program is void, and will automatically terminate your rights under this License. However, parties who have received copies, or rights, from you under this License will not have their licenses terminated so long as such parties remain in full compliance.

5. You are not required to accept this License, since you have not signed it. However, nothing else grants you permission to modify or distribute the Program or its derivative works. These actions are prohibited by law if you do not accept this License. Therefore, by modifying or distributing the Program (or any work based on the Program), you indicate your acceptance of this License to do so, and all its terms and conditions for copying, distributing or modifying the Program or works based on it.

6. Each time you redistribute the Program (or any work based on the Program), the recipient automatically receives a license from the original licensor to copy, distribute or modify the Program subject to these terms and conditions. You may not impose any further restrictions on the recipients' exercise of the rights granted herein. You are not responsible for enforcing compliance by third parties to this License.

7. If, as a consequence of a court judgment or allegation of patent infringement or for any other reason (not limited to patent issues), conditions are imposed on you (whether by court order, agreement or otherwise) that contradict the conditions of this License, they do not excuse you from the conditions of this License. If you cannot distribute so as to satisfy simultaneously your obligations under this License and any other pertinent obligations, then as a consequence you may not distribute the Program at all. For example, if a patent license would not permit royalty-free redistribution of the Program by all those who receive copies directly or indirectly through you, then the only way you could satisfy both it and this License would be to refrain entirely from distribution of the Program.

If any portion of this section is held invalid or unenforceable under any particular circumstance, the balance of the section is intended to apply and the section as a whole is intended to apply in other circumstances.

It is not the purpose of this section to induce you to infringe any patents or other property right claims or to contest validity of any such claims; this section has the sole purpose of protecting the integrity of the free software distribution system, which is implemented by public license practices. Many people have made generous contributions to the wide range of software distributed through that system in reliance on consistent application of that system; it is up to the author/donor to decide if he or she is willing to distribute software through any other system and a licensee cannot impose that choice.

This section is intended to make thoroughly clear what is believed to be a consequence of the rest of this License.

8. If the distribution and/or use of the Program is restricted in certain countries either by patents or by copyrighted interfaces, the original copyright holder who places the Program under this License may add an explicit geographical distribution limitation excluding those countries, so that distribution is permitted only in or among countries not thus excluded. In such case, this License incorporates the limitation as if written in the body of this License.

9. The Free Software Foundation may publish revised and/or new versions of the General Public License from time to time. Such new versions will be similar in spirit to the present version, but may differ in detail to address new problems or concerns.

Each version is given a distinguishing version number. If the Program specifies a version number of this License which applies to it and "any later version", you have the option of following the terms and conditions either of that version or of any later version published by the Free Software Foundation. If the Program does not specify a version number of this License, you may choose any version ever published by the Free Software Foundation.

10. If you wish to incorporate parts of the Program into other free programs whose distribution conditions are different, write to the author to ask for permission. For software which is copyrighted by the Free Software Foundation, write to the Free Software Foundation; we sometimes make exceptions for this. Our decision will be guided by the two goals of preserving the free status of all derivatives of our free software and of promoting the sharing and reuse of software generally.

## **NO WARRANTY**

11. BECAUSE THE PROGRAM IS LICENSED FREE OF CHARGE, THERE IS NO WARRANTY FOR THE PROGRAM, TO THE EXTENT PERMITTED BY APPLICABLE LAW. EXCEPT WHEN OTHERWISE STATED IN WRITING THE COPYRIGHT HOLDERS AND/OR OTHER PARTIES PROVIDE THE PROGRAM "AS IS" WITHOUT WARRANTY OF ANY KIND, EITHER EXPRESSED OR IMPLIED, INCLUDING, BUT NOT LIMITED TO, THE IMPLIED WARRANTIES OF MERCHANTABILITY AND FITNESS FOR A PARTICULAR PURPOSE. THE ENTIRE RISK AS TO THE QUALITY AND PERFORMANCE OF THE PROGRAM IS WITH YOU. SHOULD THE PROGRAM PROVE DEFECTIVE, YOU ASSUME THE COST OF ALL NECESSARY SERVICING, REPAIR OR CORRECTION.

12. IN NO EVENT UNLESS REQUIRED BY APPLICABLE LAW OR AGREED TO IN WRITING WILL ANY COPYRIGHT HOLDER, OR ANY OTHER PARTY WHO MAY MODIFY AND/OR REDISTRIBUTE THE PROGRAM AS PERMITTED ABOVE, BE LIABLE TO YOU FOR DAMAGES, INCLUDING ANY GENERAL, SPECIAL, INCIDENTAL OR CONSEQUENTIAL DAMAGES ARISING OUT OF THE USE OR INABILITY TO USE THE PROGRAM (INCLUDING BUT NOT LIMITED TO LOSS OF DATA OR DATA BEING RENDERED INACCURATE OR LOSSES SUSTAINED BY YOU OR THIRD PARTIES OR A FAILURE OF THE PROGRAM TO OPERATE WITH ANY OTHER PROGRAMS), EVEN IF SUCH HOLDER OR OTHER PARTY HAS BEEN ADVISED OF THE POSSIBILITY OF SUCH DAMAGES.

END OF TERMS AND CONDITIONS

### **How to Apply These Terms to Your New Programs**

If you develop a new program, and you want it to be of the greatest possible use to the public, the best way to achieve this is to make it free software which everyone can redistribute and change under these terms.

To do so, attach the following notices to the program. It is safest to attach them to the start of each source file to most effectively convey the exclusion of warranty; and each file should have at least the "copyright" line and a pointer to where the full notice is found.

<one line to give the program's name and a brief idea of what it does.>

Copyright (C) <year> <name of author>

This program is free software; you can redistribute it and/or modify it under the terms of the GNU General Public License as published by the Free Software Foundation; either version 2 of the License, or (at your option) any later version.

This program is distributed in the hope that it will be useful, but WITHOUT ANY WARRANTY; without even the implied warranty of MERCHANTABILITY or FITNESS FOR A PARTICULAR PURPOSE. See the GNU General Public License for more details.

You should have received a copy of the GNU General Public License along with this program; if not, write to the Free Software Foundation, Inc., 51 Franklin Street, Fifth Floor, Boston, MA 02110-1301 USA.

Also add information on how to contact you by electronic and paper mail.

If the program is interactive, make it output a short notice like this when it starts in an interactive mode:

Gnomovision version 69, Copyright (C) year name of author Gnomovision comes with ABSOLUTELY NO WARRANTY; for details type `show w'. This is free software, and you are welcome to redistribute it under certain conditions; type `show c' for details.

The hypothetical commands `show w' and `show c' should show the appropriate parts of the General Public License. Of course, the commands you use may be called something other than `show w' and `show c'; they could even be mouse-clicks or menu items--whatever suits your program.

You should also get your employer (if you work as a programmer) or your school, if any, to sign a "copyright disclaimer" for the program, if necessary. Here is a sample; alter the names:

Yoyodyne, Inc., hereby disclaims all copyright interest in the program `Gnomovision' (which makes passes at compilers) written by James Hacker.

<signature of Ty Coon>, 1 April 1989

Ty Coon, President of Vice

This General Public License does not permit incorporating your program into proprietary programs. If your program is a subroutine library, you may consider it more useful to permit linking proprietary applications with the library. If this is what you want to do, use the GNU Lesser General Public License instead of this License.

## **GNU LGPL**

This projector product includes the open source software programs which apply the GNU Lesser General Public License Version 2 or later version ("LGPL Programs").

We provide the source code of the LGPL Programs until five (5) years after the discontinuation of same model of this projector product.

If you desire to receive the source code of the LGPL Programs, please contact Epson.

These LGPL Programs are WITHOUT ANY WARRANTY; without even the implied warranty of MERCHANTABILITY AND FITNESS FOR A PARTICULAR PURPOSE. See the GNU General Public License for more details.

The list of LGPL Programs is as follows and the names of author are described in the source code of the LGPL Programs.

## LGPL Programs

- SDL-1.2.15
- SDL-Image
- alsa-lib-1.0.27.2
- libdbus-c++-0.9.0
- grencode-3.4.2
- libnl-3.2.24
- glibc-2.17

The GNU Lesser General Public License Version 2 is as follows. You also can see the GNU Lesser General Public License Version 2 at <http://www.gnu.org/licenses/>.

### **GNU LESSER GENERAL PUBLIC LICENSE**

Version 2.1, February 1999

Copyright (C) 1991, 1999 Free Software Foundation, Inc. 51 Franklin Street, Fifth Floor, Boston, MA 02110-1301 USA Everyone is permitted to copy and distribute verbatim copies of this license document, but changing it is not allowed.

[This is the first released version of the Lesser GPL. It also counts as the successor of the GNU Library Public License, version 2, hence the version number 2.1.]

#### **Preamble**

The licenses for most software are designed to take away your freedom to share and change it. By contrast, the GNU General Public Licenses are intended to guarantee your freedom to share and change free software—to make sure the software is free for all its users.

This license, the Lesser General Public License, applies to some specially designated software packages—typically libraries—of the Free Software Foundation and other authors who decide to use it. You can use it too, but we suggest you first think carefully about whether this license or the ordinary General Public License is the better strategy to use in any particular case, based on the explanations below.

When we speak of free software, we are referring to freedom of use, not price. Our General Public Licenses are designed to make sure that you have the freedom to distribute copies of free software (and charge for this service if you wish); that you receive source code or can get it if you want it; that you can change the software and use pieces of it in new free programs; and that you are informed that you can do these things.



To protect your rights, we need to make restrictions that forbid distributors to deny you these rights or to ask you to surrender these rights. These restrictions translate to certain responsibilities for you if you distribute copies of the library or if you modify it.

For example, if you distribute copies of the library, whether gratis or for a fee, you must give the recipients all the rights that we gave you. You must make sure that they, too, receive or can get the source code. If you link other code with the library, you must provide complete object files to the recipients, so that they can relink them with the library after making changes to the library and recompiling it. And you must show them these terms so they know their rights.

We protect your rights with a two-step method: (1) we copyright the library, and (2) we offer you this license, which gives you legal permission to copy, distribute and/or modify the library.

To protect each distributor, we want to make it very clear that there is no warranty for the free library. Also, if the library is modified by someone else and passed on, the recipients should know that what they have is not the original version, so that the original author's reputation will not be affected by problems that might be introduced by others.

Finally, software patents pose a constant threat to the existence of any free program. We wish to make sure that a company cannot effectively restrict the users of a free program by obtaining a restrictive license from a patent holder. Therefore, we insist that any patent license obtained for a version of the library must be consistent with the full freedom of use specified in this license.

Most GNU software, including some libraries, is covered by the ordinary GNU General Public License. This license, the GNU Lesser General Public License, applies to certain designated libraries, and is quite different from the ordinary General Public License. We use this license for certain libraries in order to permit linking those libraries into non-free programs.

When a program is linked with a library, whether statically or using a shared library, the combination of the two is legally speaking a combined work, a derivative of the original library. The ordinary General Public License therefore permits such linking only if the entire combination fits its criteria of freedom. The Lesser General Public License permits more lax criteria for linking other code with the library.

We call this license the "Lesser" General Public License because it does Less to protect the user's freedom than the ordinary General Public License. It also provides other free software developers Less of an advantage over competing non-free programs. These disadvantages are the reason we use the ordinary General Public License for many libraries. However, the Lesser license provides advantages in certain special circumstances.

For example, on rare occasions, there may be a special need to encourage the widest possible use of a certain library, so that it becomes a de-facto standard. To achieve this, non-free programs must be allowed to use the library. A more frequent case is that a free library does the same job as widely used non-free libraries. In this case, there is little to gain by limiting the free library to free software only, so we use the Lesser General Public License.

In other cases, permission to use a particular library in non-free programs enables a greater number of people to use a large body of free software. For example, permission to use the GNU C Library in non-free programs enables many more people to use the whole GNU operating system, as well as its variant, the GNU/Linux operating system.

Although the Lesser General Public License is Less protective of the users' freedom, it does ensure that the user of a program that is linked with the Library has the freedom and the wherewithal to run that program using a modified version of the Library.

The precise terms and conditions for copying, distribution and modification follow. Pay close attention to the difference between a "work based on the library" and a "work that uses the library". The former contains code derived from the library, whereas the latter must be combined with the library in order to run.

## **GNU LESSER GENERAL PUBLIC LICENSE TERMS AND CONDITIONS FOR COPYING, DISTRIBUTION AND MODIFICATION**

0. This License Agreement applies to any software library or other program which contains a notice placed by the copyright holder or other authorized party saying it may be distributed under the terms of this Lesser General Public License (also called "this License"). Each licensee is addressed as "you".

A "library" means a collection of software functions and/or data prepared so as to be conveniently linked with application programs (which use some of those functions and data) to form executables.

The "Library", below, refers to any such software library or work which has been distributed under these terms. A "work based on the Library" means either the Library or any derivative work under copyright law: that is to say, a work containing the Library or a portion of it, either verbatim or with modifications and/or translated straightforwardly into another language. (Hereinafter, translation is included without limitation in the term "modification".)

"Source code" for a work means the preferred form of the work for making modifications to it. For a library, complete source code means all the source code for all modules it contains, plus any associated interface definition files, plus the scripts used to control compilation and installation of the library.

Activities other than copying, distribution and modification are not covered by this License; they are outside its scope. The act of running a program using the Library is not restricted, and output from such a program is covered only if its contents constitute a work based on the Library (independent of the use of the Library in a tool for writing it). Whether that is true depends on what the Library does and what the program that uses the Library does.

1. You may copy and distribute verbatim copies of the Library's complete source code as you receive it, in any medium, provided that you conspicuously and appropriately publish on each copy an appropriate copyright notice and disclaimer of warranty; keep intact all the notices that refer to this License and to the absence of any warranty; and distribute a copy of this License along with the Library.

You may charge a fee for the physical act of transferring a copy, and you may at your option offer warranty protection in exchange for a fee.

2. You may modify your copy or copies of the Library or any portion of it, thus forming a work based on the Library, and copy and distribute such modifications or work under the terms of Section 1 above, provided that you also meet all of these conditions:

- a) The modified work must itself be a software library.
- b) You must cause the files modified to carry prominent notices stating that you changed the files and the date of any change.
- c) You must cause the whole of the work to be licensed at no charge to all third parties under the terms of this License.
- d) If a facility in the modified Library refers to a function or a table of data to be supplied by an application program that uses the facility, other than as an argument passed when the facility is invoked, then you must make a good faith effort to ensure that, in the event an application does not supply such function or table, the facility still operates, and performs whatever part of its purpose remains meaningful.

(For example, a function in a library to compute square roots has a purpose that is entirely well-defined independent of the application. Therefore, Subsection 2d requires that any application-supplied function or table used by this function must be optional: if the application does not supply it, the square root function must still compute square roots.)

These requirements apply to the modified work as a whole. If identifiable sections of that work are not derived from the Library, and can be reasonably considered independent and separate works in themselves, then this License, and its terms, do not apply to those sections when you distribute them as separate works. But when you distribute the same sections as part of a whole which is a work based on the Library, the distribution of the whole must be on the terms of this License, whose permissions for other licensees extend to the entire whole, and thus to each and every part regardless of who wrote it.

Thus, it is not the intent of this section to claim rights or contest your rights to work written entirely by you; rather, the intent is to exercise the right to control the distribution of derivative or collective works based on the Library.

In addition, mere aggregation of another work not based on the Library with the Library (or with a work based on the Library) on a volume of a storage or distribution medium does not bring the other work under the scope of this License.

3. You may opt to apply the terms of the ordinary GNU General Public License instead of this License to a given copy of the Library. To do this, you must alter all the notices that refer to this License, so that they refer to the ordinary GNU General Public License, version 2, instead of to this License. (If a newer version than version 2 of the ordinary GNU General Public License has appeared, then you can specify that version instead if you wish.) Do not make any other change in these notices.

Once this change is made in a given copy, it is irreversible for that copy, so the ordinary GNU General Public License applies to all subsequent copies and derivative works made from that copy.

This option is useful when you wish to copy part of the code of the Library into a program that is not a library.

4. You may copy and distribute the Library (or a portion or derivative of it, under Section 2) in object code or executable form under the terms of Sections 1 and 2 above provided that you accompany it with the complete corresponding machine-readable source code, which must be distributed under the terms of Sections 1 and 2 above on a medium customarily used for software interchange.

If distribution of object code is made by offering access to copy from a designated place, then offering equivalent access to copy the source code from the same place satisfies the requirement to distribute the source code, even though third parties are not compelled to copy the source along with the object code.

5. A program that contains no derivative of any portion of the Library, but is designed to work with the Library by being compiled or linked with it, is called a "work that uses the Library". Such a work, in isolation, is not a derivative work of the Library, and therefore falls outside the scope of this License.

However, linking a "work that uses the Library" with the Library creates an executable that is a derivative of the Library (because it contains portions of the Library), rather than a "work that uses the library". The executable is therefore covered by this License. Section 6 states terms for distribution of such executables.

When a "work that uses the Library" uses material from a header file that is part of the Library, the object code for the work may be a derivative work of the Library even though the source code is not. Whether this is true is especially significant if the work can be linked without the Library, or if the work is itself a library. The threshold for this to be true is not precisely defined by law.

If such an object file uses only numerical parameters, data structure layouts and accessors, and small macros and small inline functions (ten lines or less in length), then the use of the object file is unrestricted, regardless of whether it is legally a derivative work. (Executables containing this object code plus portions of the Library will still fall under Section 6.)

Otherwise, if the work is a derivative of the Library, you may distribute the object code for the work under the terms of Section 6. Any executables containing that work also fall under Section 6, whether or not they are linked directly with the Library itself.

6. As an exception to the Sections above, you may also combine or link a "work that uses the Library" with the Library to produce a work containing portions of the Library, and distribute that work under terms of your choice, provided that the terms permit modification of the work for the customer's own use and reverse engineering for debugging such modifications.

You must give prominent notice with each copy of the work that the Library is used in it and that the Library and its use are covered by this License. You must supply a copy of this License. If the work

during execution displays copyright notices, you must include the copyright notice for the Library among them, as well as a reference directing the user to the copy of this License. Also, you must do one of these things:

- a) Accompany the work with the complete corresponding machine-readable source code for the Library including whatever changes were used in the work (which must be distributed under Sections 1 and 2 above); and, if the work is an executable linked with the Library, with the complete machine-readable "work that uses the Library", as object code and/or source code, so that the user can modify the Library and then relink to produce a modified executable containing the modified Library. (It is understood that the user who changes the contents of definitions files in the Library will not necessarily be able to recompile the application to use the modified definitions.)
- b) Use a suitable shared library mechanism for linking with the Library. A suitable mechanism is one that (1) uses at run time a copy of the library already present on the user's computer system, rather than copying library functions into the executable, and (2) will operate properly with a modified version of the library, if the user installs one, as long as the modified version is interface-compatible with the version that the work was made with.
- c) Accompany the work with a written offer, valid for at least three years, to give the same user the materials specified in Subsection 6a, above, for a charge no more than the cost of performing this distribution.
- d) If distribution of the work is made by offering access to copy from a designated place, offer equivalent access to copy the above specified materials from the same place.
- e) Verify that the user has already received a copy of these materials or that you have already sent this user a copy.

For an executable, the required form of the "work that uses the Library" must include any data and utility programs needed for reproducing the executable from it. However, as a special exception, the materials to be distributed need not include anything that is normally distributed (in either source or binary form) with the major components (compiler, kernel, and so on) of the operating system on which the executable runs, unless that component itself accompanies the executable.

It may happen that this requirement contradicts the license restrictions of other proprietary libraries that do not normally accompany the operating system. Such a contradiction means you cannot use both them and the Library together in an executable that you distribute.

7. You may place library facilities that are a work based on the Library side-by-side in a single library together with other library facilities not covered by this License, and distribute such a combined library, provided that the separate distribution of the work based on the Library and of the other library facilities is otherwise permitted, and provided that you do these two things:

- a) Accompany the combined library with a copy of the same work based on the Library, uncombined with any other library facilities. This must be distributed under the terms of the Sections above.

b) Give prominent notice with the combined library of the fact that part of it is a work based on the Library, and explaining where to find the accompanying uncombined form of the same work.

8. You may not copy, modify, sublicense, link with, or distribute the Library except as expressly provided under this License. Any attempt otherwise to copy, modify, sublicense, link with, or distribute the Library is void, and will automatically terminate your rights under this License. However, parties who have received copies, or rights, from you under this License will not have their licenses terminated so long as such parties remain in full compliance.

9. You are not required to accept this License, since you have not signed it. However, nothing else grants you permission to modify or distribute the Library or its derivative works. These actions are prohibited by law if you do not accept this License. Therefore, by modifying or distributing the Library (or any work based on the Library), you indicate your acceptance of this License to do so, and all its terms and conditions for copying, distributing or modifying the Library or works based on it.

10. Each time you redistribute the Library (or any work based on the Library), the recipient automatically receives a license from the original licensor to copy, distribute, link with or modify the Library subject to these terms and conditions. You may not impose any further restrictions on the recipients' exercise of the rights granted herein. You are not responsible for enforcing compliance by third parties with this License.

11. If, as a consequence of a court judgment or allegation of patent infringement or for any other reason (not limited to patent issues), conditions are imposed on you (whether by court order, agreement or otherwise) that contradict the conditions of this License, they do not excuse you from the conditions of this License. If you cannot distribute so as to satisfy simultaneously your obligations under this License and any other pertinent obligations, then as a consequence you may not distribute the Library at all. For example, if a patent license would not permit royalty-free redistribution of the Library by all those who receive copies directly or indirectly through you, then the only way you could satisfy both it and this License would be to refrain entirely from distribution of the Library.

If any portion of this section is held invalid or unenforceable under any particular circumstance, the balance of the section is intended to apply, and the section as a whole is intended to apply in other circumstances.

It is not the purpose of this section to induce you to infringe any patents or other property right claims or to contest validity of any such claims; this section has the sole purpose of protecting the integrity of the free software distribution system which is implemented by public license practices. Many people have made generous contributions to the wide range of software distributed through that system in reliance on consistent application of that system; it is up to the author/donor to decide if he or she is willing to distribute software through any other system and a licensee cannot impose that choice.

This section is intended to make thoroughly clear what is believed to be a consequence of the rest of this License.

12. If the distribution and/or use of the Library is restricted in certain countries either by patents or by copyrighted interfaces, the original copyright holder who places the Library under this License may add an explicit geographical distribution limitation excluding those countries, so that distribution is permitted only in or among countries not thus excluded. In such case, this License incorporates the limitation as if written in the body of this License.

13. The Free Software Foundation may publish revised and/or new versions of the Lesser General Public License from time to time. Such new versions will be similar in spirit to the present version, but may differ in detail to address new problems or concerns.

Each version is given a distinguishing version number. If the Library specifies a version number of this License which applies to it and "any later version", you have the option of following the terms and conditions either of that version or of any later version published by the Free Software Foundation. If the Library does not specify a license version number, you may choose any version ever published by the Free Software Foundation.

14. If you wish to incorporate parts of the Library into other free programs whose distribution conditions are incompatible with these, write to the author to ask for permission. For software which is copyrighted by the Free Software Foundation, write to the Free Software Foundation; we sometimes make exceptions for this. Our decision will be guided by the two goals of preserving the free status of all derivatives of our free software and of promoting the sharing and reuse of software generally.

#### **NO WARRANTY**

15. BECAUSE THE LIBRARY IS LICENSED FREE OF CHARGE, THERE IS NO WARRANTY FOR THE LIBRARY, TO THE EXTENT PERMITTED BY APPLICABLE LAW. EXCEPT WHEN OTHERWISE STATED IN WRITING THE COPYRIGHT HOLDERS AND/OR OTHER PARTIES PROVIDE THE LIBRARY "AS IS" WITHOUT WARRANTY OF ANY KIND, EITHER EXPRESSED OR IMPLIED, INCLUDING, BUT NOT LIMITED TO, THE IMPLIED WARRANTIES OF MERCHANTABILITY AND FITNESS FOR A PARTICULAR PURPOSE. THE ENTIRE RISK AS TO THE QUALITY AND PERFORMANCE OF THE LIBRARY IS WITH YOU. SHOULD THE LIBRARY PROVE DEFECTIVE, YOU ASSUME THE COST OF ALL NECESSARY SERVICING, REPAIR OR CORRECTION.

16. IN NO EVENT UNLESS REQUIRED BY APPLICABLE LAW OR AGREED TO IN WRITING WILL ANY COPYRIGHT HOLDER, OR ANY OTHER PARTY WHO MAY MODIFY AND/OR REDISTRIBUTE THE LIBRARY AS PERMITTED ABOVE, BE LIABLE TO YOU FOR DAMAGES, INCLUDING ANY GENERAL, SPECIAL, INCIDENTAL OR CONSEQUENTIAL DAMAGES ARISING OUT OF THE USE OR INABILITY TO USE THE LIBRARY (INCLUDING BUT NOT LIMITED TO LOSS OF DATA OR DATA BEING RENDERED INACCURATE OR LOSSES SUSTAINED BY YOU OR THIRD PARTIES OR A FAILURE OF THE LIBRARY TO OPERATE WITH ANY OTHER SOFTWARE), EVEN IF SUCH HOLDER OR OTHER PARTY HAS BEEN ADVISED OF THE POSSIBILITY OF SUCH DAMAGES.

END OF TERMS AND CONDITIONS

## How to Apply These Terms to Your New Libraries

If you develop a new library, and you want it to be of the greatest possible use to the public, we recommend making it free software that everyone can redistribute and change. You can do so by permitting redistribution under these terms (or, alternatively, under the terms of the ordinary General Public License).

To apply these terms, attach the following notices to the library. It is safest to attach them to the start of each source file to most effectively convey the exclusion of warranty; and each file should have at least the "copyright" line and a pointer to where the full notice is found.

<one line to give the library's name and a brief idea of what it does.>

Copyright (C) <year> <name of author>

This library is free software; you can redistribute it and/or modify it under the terms of the GNU Lesser General Public License as published by the Free Software Foundation; either version 2.1 of the License, or (at your option) any later version.

This library is distributed in the hope that it will be useful, but WITHOUT ANY WARRANTY; without even the implied warranty of MERCHANTABILITY or FITNESS FOR A PARTICULAR PURPOSE. See the GNU Lesser General Public License for more details.

You should have received a copy of the GNU Lesser General Public License along with this library; if not, write to the Free Software Foundation, Inc., 51 Franklin Street, Fifth Floor, Boston, MA 02110-1301 USA

Also add information on how to contact you by electronic and paper mail.

You should also get your employer (if you work as a programmer) or your school, if any, to sign a "copyright disclaimer" for the library, if necessary. Here is a sample; alter the names:

Yoyodyne, Inc., hereby disclaims all copyright interest in the library `Frob' (a library for tweaking knobs) written by James Random Hacker.

<signature of Ty Coon>, 1 April 1990

Ty Coon, President of Vice

That's all there is to it!

## libjpeg

This projector product includes the open source software program "libjpeg" which applies the terms and conditions provided by owner of the copyright to the "libjpeg".

The "libjpeg" are WITHOUT ANY WARRANTY; without even the implied warranty of MERCHANTABILITY AND FITNESS FOR A PARTICULAR PURPOSE.



## List of libjpeg programs

- libjpeg-6b

License terms of conditions of each program which are provided by owner of the copyright to the "libjpeg" are as follows.

Copyright (C) 1994-1997, Thomas G. Lane. This file is part of the Independent JPEG Group's software. For conditions of distribution and use, see the accompanying README file.

This distribution contains the sixth public release of the Independent JPEG Group's free JPEG software. You are welcome to redistribute this software and to use it for any purpose, subject to the conditions under LEGAL ISSUES, below.

### LEGAL ISSUES

=====

In plain English:

1. We don't promise that this software works. (But if you find any bugs, please let us know!)
2. You can use this software for whatever you want. You don't have to pay us.
3. You may not pretend that you wrote this software. If you use it in a program, you must acknowledge somewhere in your documentation that you've used the IJG code.

In legalese:

The authors make NO WARRANTY or representation, either express or implied, with respect to this software, its quality, accuracy, merchantability, or fitness for a particular purpose. This software is provided "AS IS", and you, its user, assume the entire risk as to its quality and accuracy.

This software is copyright (C) 1991-1998, Thomas G. Lane. All Rights Reserved except as specified below.

Permission is hereby granted to use, copy, modify, and distribute this software (or portions thereof) for any purpose, without fee, subject to these conditions:

- (1) If any part of the source code for this software is distributed, then this README file must be included, with this copyright and no-warranty notice unaltered; and any additions, deletions, or changes to the original files must be clearly indicated in accompanying documentation.
- (2) If only executable code is distributed, then the accompanying documentation must state that "this software is based in part on the work of the Independent JPEG Group".
- (3) Permission for use of this software is granted only if the user accepts full responsibility for any undesirable consequences; the authors accept NO LIABILITY for damages of any kind.

These conditions apply to any software derived from or based on the IJG code, not just to the unmodified library. If you use our work, you ought to acknowledge us.

Permission is NOT granted for the use of any IJG author's name or company name in advertising or publicity relating to this software or products derived from it. This software may be referred to only as "the Independent JPEG Group's software".

We specifically permit and encourage the use of this software as the basis of commercial products, provided that all warranty or liability claims are assumed by the product vendor.

ansi2knr.c is included in this distribution by permission of L. Peter Deutsch, sole proprietor of its copyright holder, Aladdin Enterprises of Menlo Park, CA. ansi2knr.c is NOT covered by the above copyright and conditions, but instead by the usual distribution terms of the Free Software Foundation; principally, that you must include source code if you redistribute it. (See the file ansi2knr.c for full details.) However, since ansi2knr.c is not needed as part of any program generated from the IJG code, this does not limit you more than the foregoing paragraphs do.

The Unix configuration script "configure" was produced with GNU Autoconf. It is copyright by the Free Software Foundation but is freely distributable. The same holds for its supporting scripts (config.guess, config.sub, ltconfig, ltmain.sh). Another support script, install-sh, is copyright by M.I.T. but is also freely distributable.

It appears that the arithmetic coding option of the JPEG spec is covered by patents owned by IBM, AT&T, and Mitsubishi. Hence arithmetic coding cannot legally be used without obtaining one or more licenses. For this reason, support for arithmetic coding has been removed from the free JPEG software. (Since arithmetic coding provides only a marginal gain over the unpatented Huffman mode, it is unlikely that very many implementations will support it.) So far as we are aware, there are no patent restrictions on the remaining code.

The IJG distribution formerly included code to read and write GIF files. To avoid entanglement with the Unisys LZW patent, GIF reading support has been removed altogether, and the GIF writer has been simplified to produce "uncompressed GIFs". This technique does not use the LZW algorithm; the resulting GIF files are larger than usual, but are readable by all standard GIF decoders.

We are required to state that "The Graphics Interchange Format(c) is the Copyright property of CompuServe Incorporated. GIF(sm) is a Service Mark property of CompuServe Incorporated."

### **libpng**

This projector product includes the open source software program "libpng" which applies the terms and conditions provided by owner of the copyright to the "libpng".

The "libpng" are WITHOUT ANY WARRANTY; without even the implied warranty of MERCHANTABILITY AND FITNESS FOR A PARTICULAR PURPOSE.

## List of libpng programs

- libpng-1.2.49

License terms of conditions of each program which are provided by owner of the copyright to the "libpng" are as follows.

This copy of the libpng notices is provided for your convenience. In case of any discrepancy between this copy and the notices in the file png.h that is included in the libpng distribution, the latter shall prevail.

COPYRIGHT NOTICE, DISCLAIMER, and LICENSE:

If you modify libpng you may insert additional notices immediately following this sentence.

This code is released under the libpng license.

libpng versions 1.2.6, August 15, 2004, through 1.2.49, March 29, 2012, are Copyright (c) 2004, 2006-2009 Glenn Randers-Pehrson, and are distributed according to the same disclaimer and license as libpng-1.2.5 with the following individual added to the list of Contributing Authors

Cosmin Truta

libpng versions 1.0.7, July 1, 2000, through 1.2.5 - October 3, 2002, are Copyright (c) 2000-2002 Glenn Randers-Pehrson, and are distributed according to the same disclaimer and license as libpng-1.0.6 with the following individuals added to the list of Contributing Authors

Simon-Pierre Cadieux

Eric S. Raymond

Gilles Vollant

and with the following additions to the disclaimer:

There is no warranty against interference with your enjoyment of the library or against infringement. There is no warranty that our efforts or the library will fulfill any of your particular purposes or needs. This library is provided with all faults, and the entire risk of satisfactory quality, performance, accuracy, and effort is with the user.

libpng versions 0.97, January 1998, through 1.0.6, March 20, 2000, are Copyright (c) 1998, 1999 Glenn Randers-Pehrson, and are distributed according to the same disclaimer and license as libpng-0.96, with the following individuals added to the list of Contributing Authors:

Tom Lane

Glenn Randers-Pehrson

Willem van Schaik

libpng versions 0.89, June 1996, through 0.96, May 1997, are Copyright (c) 1996, 1997 Andreas Dilger Distributed according to the same disclaimer and license as libpng-0.88, with the following individuals added to the list of Contributing Authors:

John Bowler

Kevin Bracey

Sam Bushell

Magnus Holmgren

Greg Roelofs

Tom Tanner

libpng versions 0.5, May 1995, through 0.88, January 1996, are Copyright (c) 1995, 1996 Guy Eric Schalnat, Group 42, Inc.

For the purposes of this copyright and license, "Contributing Authors" is defined as the following set of individuals:

Andreas Dilger

Dave Martindale

Guy Eric Schalnat

Paul Schmidt

Tim Wegner

The PNG Reference Library is supplied "AS IS". The Contributing Authors and Group 42, Inc. disclaim all warranties, expressed or implied, including, without limitation, the warranties of merchantability and of fitness for any purpose. The Contributing Authors and Group 42, Inc. assume no liability for direct, indirect, incidental, special, exemplary, or consequential damages, which may result from the use of the PNG Reference Library, even if advised of the possibility of such damage.

Permission is hereby granted to use, copy, modify, and distribute this source code, or portions hereof, for any purpose, without fee, subject to the following restrictions:

1. The origin of this source code must not be misrepresented.
2. Altered versions must be plainly marked as such and must not be misrepresented as being the original source.
3. This Copyright notice may not be removed or altered from any source or altered source distribution.

The Contributing Authors and Group 42, Inc. specifically permit, without fee, and encourage the use of this source code as a component to supporting the PNG file format in commercial products. If you use this source code in a product, acknowledgment is not required but would be appreciated.

A "png\_get\_copyright" function is available, for convenient use in "about" boxes and the like:

```
printf("%s",png_get_copyright(NULL));
```

Also, the PNG logo (in PNG format, of course) is supplied in the files "pngbar.png" and "pngbar.jpg" (88x31) and "pngnow.png" (98x31).

Libpng is OSI Certified Open Source Software. OSI Certified Open Source is a certification mark of the Open Source Initiative.

Glenn Randers-Pehrson

glennrp at users.sourceforge.net

March 29, 2012

### **zlib**

This projector product includes the open source software program "zlib" which applies the terms and conditions provided by owner of the copyright to the "zlib".

The "zlib" are WITHOUT ANY WARRANTY; without even the implied warranty of MERCHANTABILITY AND FITNESS FOR A PARTICULAR PURPOSE.

List of zlib programs

- zlib-1.1.4

License terms of conditions of each program which are provided by owner of the copyright to the "zlib" are as follows.

Copyright notice:

(C) 1995-1998 Jean-loup Gailly and Mark Adler

This software is provided 'as-is', without any express or implied warranty. In no event will the authors be held liable for any damages arising from the use of this software.

Permission is granted to anyone to use this software for any purpose, including commercial applications, and to alter it and redistribute it freely, subject to the following restrictions:

1. The origin of this software must not be misrepresented; you must not claim that you wrote the original software. If you use this software in a product, an acknowledgment in the product documentation would be appreciated but is not required.
2. Altered source versions must be plainly marked as such, and must not be misrepresented as being the original software.
3. This notice may not be removed or altered from any source distribution.

Jean-loup Gailly

jloup@gzip.org

Mark Adler

madler@alumni.caltech.edu

If you use the zlib library in a product, we would appreciate \*not\* receiving lengthy legal documents to sign. The sources are provided for free but without warranty of any kind. The library has been entirely written by Jean-loup Gailly and Mark Adler; it does not include third-party code.

If you redistribute modified sources, we would appreciate that you include in the file ChangeLog history information documenting your changes.

### **aes-src-29-04-09**

This projector product includes the open source software program "aes-src-29-04-09" which applies the terms and conditions provided by owner of the copyright to the "aes-src-29-04-09".

The "aes-src-29-04-09" are WITHOUT ANY WARRANTY; without even the implied warranty of MERCHANTABILITY AND FITNESS FOR A PARTICULAR PURPOSE.

List of aes-src-29-04-09 programs

- aes-src-29-04-09

License terms of conditions of each program which are provided by owner of the copyright to the "aes-src-29-04-09" are as follows.

Copyright (c) 1998-2008, Brian Gladman, Worcester, UK. All rights reserved.

### LICENSE TERMS

The redistribution and use of this software (with or without changes) is allowed without the payment of fees or royalties provided that:

1. source code distributions include the above copyright notice, this list of conditions and the following disclaimer;
2. binary distributions include the above copyright notice, this list of conditions and the following disclaimer in their documentation;.
3. the name of the copyright holder is not used to endorse products built using this software without specific written permission.

### DISCLAIMER

This software is provided 'as is' with no explicit or implied warranties in respect of its properties, including, but not limited to, correctness and/or fitness for purpose.

## **newlib**

This projector product includes the open source software program "newlib" which applies the terms and conditions provided by owner of the copyright to the "newlib".

The "newlib" are WITHOUT ANY WARRANTY; without even the implied warranty of MERCHANTABILITY AND FITNESS FOR A PARTICULAR PURPOSE.

List of newlib programs

- newlib 1.17.0

License terms of conditions of each program which are provided by owner of the copyright to the "newlib" are as follows.

The newlib subdirectory is a collection of software from several sources.

Each file may have its own copyright/license that is embedded in the source file. Unless otherwise noted in the body of the source file(s), the following copyright notices will apply to the contents of the newlib subdirectory:

(1) Red Hat Incorporated

Copyright (c) 1994-2007 Red Hat, Inc. All rights reserved.

This copyrighted material is made available to anyone wishing to use, modify, copy, or redistribute it subject to the terms and conditions of the BSD License. This program is distributed in the hope that it will be useful, but WITHOUT ANY WARRANTY expressed or implied, including the implied warranties of MERCHANTABILITY or FITNESS FOR A PARTICULAR PURPOSE. A copy of this license is available at <http://www.opensource.org/licenses>. Any Red Hat trademarks that are incorporated in the source code or documentation are not subject to the BSD License and may only be used or replicated with the express permission of Red Hat, Inc.

(2) University of California, Berkeley

Copyright (c) 1981-2000 The Regents of the University of California.

All rights reserved.

Redistribution and use in source and binary forms, with or without modification, are permitted provided that the following conditions are met:

\* Redistributions of source code must retain the above copyright notice, this list of conditions and the following disclaimer.

\* Redistributions in binary form must reproduce the above copyright notice, this list of conditions and the following disclaimer in the documentation and/or other materials provided with the distribution.

\* Neither the name of the University nor the names of its contributors may be used to endorse or promote products derived from this software without specific prior written permission.

THIS SOFTWARE IS PROVIDED BY THE COPYRIGHT HOLDERS AND CONTRIBUTORS "AS IS" AND ANY EXPRESS OR IMPLIED WARRANTIES, INCLUDING, BUT NOT LIMITED TO, THE IMPLIED WARRANTIES OF MERCHANTABILITY AND FITNESS FOR A PARTICULAR PURPOSE ARE DISCLAIMED. IN NO EVENT SHALL THE COPYRIGHT OWNER OR CONTRIBUTORS BE LIABLE FOR ANY DIRECT, INDIRECT, INCIDENTAL, SPECIAL, EXEMPLARY, OR CONSEQUENTIAL DAMAGES (INCLUDING, BUT NOT LIMITED TO, PROCUREMENT OF SUBSTITUTE GOODS OR SERVICES; LOSS OF USE, DATA, OR PROFITS; OR BUSINESS INTERRUPTION) HOWEVER CAUSED AND ON ANY THEORY OF LIABILITY, WHETHER IN CONTRACT, STRICT LIABILITY, OR TORT (INCLUDING NEGLIGENCE OR OTHERWISE) ARISING IN ANY WAY OUT OF THE USE OF THIS SOFTWARE, EVEN IF ADVISED OF THE POSSIBILITY OF SUCH DAMAGE.

(3) David M. Gay (AT&T 1991, Lucent 1998)

The author of this software is David M. Gay.

Copyright (c) 1991 by AT&T.

Permission to use, copy, modify, and distribute this software for any purpose without fee is hereby granted, provided that this entire notice is included in all copies of any software which is or includes a copy or modification of this software and in all copies of the supporting documentation for such software.

THIS SOFTWARE IS BEING PROVIDED "AS IS", WITHOUT ANY EXPRESS OR IMPLIED WARRANTY. IN PARTICULAR, NEITHER THE AUTHOR NOR AT&T MAKES ANY REPRESENTATION OR WARRANTY OF ANY KIND CONCERNING THE MERCHANTABILITY OF THIS SOFTWARE OR ITS FITNESS FOR ANY PARTICULAR PURPOSE.

-----

The author of this software is David M. Gay.

Copyright (C) 1998-2001 by Lucent Technologies

All Rights Reserved

Permission to use, copy, modify, and distribute this software and its documentation for any purpose and without fee is hereby granted, provided that the above copyright notice appear in all copies and that both that the copyright notice and this permission notice and warranty disclaimer appear in supporting documentation, and that the name of Lucent or any of its entities not be used in advertising or publicity pertaining to distribution of the software without specific, written prior permission.

LUCENT DISCLAIMS ALL WARRANTIES WITH REGARD TO THIS SOFTWARE, INCLUDING ALL IMPLIED WARRANTIES OF MERCHANTABILITY AND FITNESS. IN NO EVENT SHALL LUCENT OR ANY OF ITS ENTITIES BE LIABLE FOR ANY SPECIAL, INDIRECT OR CONSEQUENTIAL DAMAGES OR ANY DAMAGES WHATSOEVER RESULTING FROM LOSS OF USE, DATA OR PROFITS, WHETHER IN AN ACTION OF CONTRACT, NEGLIGENCE OR OTHER TORTIOUS ACTION, ARISING OUT OF OR IN CONNECTION WITH THE USE OR PERFORMANCE OF THIS SOFTWARE.



(4) Advanced Micro Devices

Copyright 1989, 1990 Advanced Micro Devices, Inc.

This software is the property of Advanced Micro Devices, Inc (AMD) which specifically grants the user the right to modify, use and distribute this software provided this notice is not removed or altered. All other rights are reserved by AMD.

AMD MAKES NO WARRANTY OF ANY KIND, EXPRESS OR IMPLIED, WITH REGARD TO THIS SOFTWARE. IN NO EVENT SHALL AMD BE LIABLE FOR INCIDENTAL OR CONSEQUENTIAL DAMAGES IN CONNECTION WITH OR ARISING FROM THE FURNISHING, PERFORMANCE, OR USE OF THIS SOFTWARE.

So that all may benefit from your experience, please report any problems or suggestions about this software to the 29K Technical Support Center at 800-29-29-AMD (800-292-9263) in the USA, or 0800-89-1131 in the UK, or 0031-11-1129 in Japan, toll free. The direct dial number is 512-462-4118.

Advanced Micro Devices, Inc.

29K Support Products

Mail Stop 573

5900 E. Ben White Blvd.

Austin, TX 78741

800-292-9263

(5) C.W. Sandmann

Copyright (C) 1993 C.W. Sandmann

This file may be freely distributed as long as the author's name remains.

(6) Eric Backus

(C) Copyright 1992 Eric Backus

This software may be used freely so long as this copyright notice is left intact. There is no warrantee on this software.

(7) Sun Microsystems

Copyright (C) 1993 by Sun Microsystems, Inc. All rights reserved.

Developed at SunPro, a Sun Microsystems, Inc. business. Permission to use, copy, modify, and distribute this software is freely granted, provided that this notice is preserved.

(8) Hewlett Packard

(c) Copyright 1986 HEWLETT-PACKARD COMPANY

To anyone who acknowledges that this file is provided "AS IS" without any express or implied warranty: permission to use, copy, modify, and distribute this file for any purpose is hereby granted without fee, provided that the above copyright notice and this notice appears in all copies, and that the name of Hewlett-Packard Company not be used in advertising or publicity pertaining to distribution of the software without specific, written prior permission. Hewlett-Packard Company makes no representations about the suitability of this software for any purpose.

(9) Hans-Peter Nilsson

Copyright (C) 2001 Hans-Peter Nilsson

Permission to use, copy, modify, and distribute this software is freely granted, provided that the above copyright notice, this notice and the following disclaimer are preserved with no changes.

THIS SOFTWARE IS PROVIDED "AS IS" AND WITHOUT ANY EXPRESS OR IMPLIED WARRANTIES, INCLUDING, WITHOUT LIMITATION, THE IMPLIED WARRANTIES OF MERCHANTABILITY AND FITNESS FOR A PARTICULAR PURPOSE.

(11) Christopher G. Demetriou

Copyright (c) 2001 Christopher G. Demetriou

All rights reserved.

Redistribution and use in source and binary forms, with or without modification, are permitted provided that the following conditions are met:

1. Redistributions of source code must retain the above copyright notice, this list of conditions and the following disclaimer.
2. Redistributions in binary form must reproduce the above copyright notice, this list of conditions and the following disclaimer in the documentation and/or other materials provided with the distribution.
3. The name of the author may not be used to endorse or promote products derived from this software without specific prior written permission.

THIS SOFTWARE IS PROVIDED BY THE AUTHOR "AS IS" AND ANY EXPRESS OR IMPLIED WARRANTIES, INCLUDING, BUT NOT LIMITED TO, THE IMPLIED WARRANTIES OF MERCHANTABILITY AND FITNESS FOR A PARTICULAR PURPOSE ARE DISCLAIMED. IN NO EVENT SHALL THE AUTHOR BE LIABLE FOR ANY DIRECT, INDIRECT, INCIDENTAL, SPECIAL, EXEMPLARY, OR CONSEQUENTIAL DAMAGES (INCLUDING, BUT NOT LIMITED TO, PROCUREMENT OF SUBSTITUTE GOODS OR SERVICES; LOSS OF USE, DATA, OR PROFITS; OR BUSINESS INTERRUPTION) HOWEVER CAUSED AND ON ANY THEORY OF LIABILITY, WHETHER IN CONTRACT, STRICT LIABILITY, OR TORT (INCLUDING NEGLIGENCE OR OTHERWISE) ARISING IN ANY WAY OUT OF THE USE OF THIS SOFTWARE, EVEN IF ADVISED OF THE POSSIBILITY OF SUCH DAMAGE.

(12) SuperH, Inc.

Copyright 2002 SuperH, Inc. All rights reserved

This software is the property of SuperH, Inc (SuperH) which specifically grants the user the right to modify, use and distribute this software provided this notice is not removed or altered. All other rights are reserved by SuperH.

SUPERH MAKES NO WARRANTY OF ANY KIND, EXPRESS OR IMPLIED, WITH REGARD TO THIS SOFTWARE. IN NO EVENT SHALL SUPERH BE LIABLE FOR INDIRECT, SPECIAL, INCIDENTAL OR CONSEQUENTIAL DAMAGES IN CONNECTION WITH OR ARISING FROM THE FURNISHING, PERFORMANCE, OR USE OF THIS SOFTWARE.

So that all may benefit from your experience, please report any problems or suggestions about this software to the SuperH Support Center via e-mail at [softwaresupport@superh.com](mailto:softwaresupport@superh.com).

SuperH, Inc.

405 River Oaks Parkway

San Jose

CA 95134

USA

(13) Royal Institute of Technology

Copyright (c) 1999 Kungliga Tekniska Högskolan (Royal Institute of Technology, Stockholm, Sweden).

All rights reserved.

Redistribution and use in source and binary forms, with or without modification, are permitted provided that the following conditions are met:

1. Redistributions of source code must retain the above copyright notice, this list of conditions and the following disclaimer.
2. Redistributions in binary form must reproduce the above copyright notice, this list of conditions and the following disclaimer in the documentation and/or other materials provided with the distribution.
3. Neither the name of KTH nor the names of its contributors may be used to endorse or promote products derived from this software without specific prior written permission.

THIS SOFTWARE IS PROVIDED BY KTH AND ITS CONTRIBUTORS "AS IS" AND ANY EXPRESS OR IMPLIED WARRANTIES, INCLUDING, BUT NOT LIMITED TO, THE IMPLIED WARRANTIES OF MERCHANTABILITY AND FITNESS FOR A PARTICULAR PURPOSE ARE DISCLAIMED. IN NO EVENT SHALL KTH OR ITS CONTRIBUTORS BE LIABLE FOR ANY DIRECT, INDIRECT, INCIDENTAL, SPECIAL, EXEMPLARY, OR CONSEQUENTIAL DAMAGES (INCLUDING, BUT NOT LIMITED TO, PROCUREMENT OF SUBSTITUTE GOODS OR SERVICES; LOSS OF USE, DATA, OR PROFITS; OR BUSINESS INTERRUPTION) HOWEVER CAUSED AND ON ANY THEORY OF

LIABILITY, WHETHER IN CONTRACT, STRICT LIABILITY, OR TORT (INCLUDING NEGLIGENCE OR OTHERWISE) ARISING IN ANY WAY OUT OF THE USE OF THIS SOFTWARE, EVEN IF ADVISED OF THE POSSIBILITY OF SUCH DAMAGE.

(14) Alexey Zelkin

Copyright (c) 2000, 2001 Alexey Zelkin <phantom@FreeBSD.org>

All rights reserved.

Redistribution and use in source and binary forms, with or without modification, are permitted provided that the following conditions are met:

1. Redistributions of source code must retain the above copyright notice, this list of conditions and the following disclaimer.
2. Redistributions in binary form must reproduce the above copyright notice, this list of conditions and the following disclaimer in the documentation and/or other materials provided with the distribution.

THIS SOFTWARE IS PROVIDED BY THE AUTHOR AND CONTRIBUTORS "AS IS" AND ANY EXPRESS OR IMPLIED WARRANTIES, INCLUDING, BUT NOT LIMITED TO, THE IMPLIED WARRANTIES OF MERCHANTABILITY AND FITNESS FOR A PARTICULAR PURPOSE ARE DISCLAIMED. IN NO EVENT SHALL THE AUTHOR OR CONTRIBUTORS BE LIABLE FOR ANY DIRECT, INDIRECT, INCIDENTAL, SPECIAL, EXEMPLARY, OR CONSEQUENTIAL DAMAGES (INCLUDING, BUT NOT LIMITED TO, PROCUREMENT OF SUBSTITUTE GOODS OR SERVICES; LOSS OF USE, DATA, OR PROFITS; OR BUSINESS INTERRUPTION) HOWEVER CAUSED AND ON ANY THEORY OF LIABILITY, WHETHER IN CONTRACT, STRICT LIABILITY, OR TORT (INCLUDING NEGLIGENCE OR OTHERWISE) ARISING IN ANY WAY OUT OF THE USE OF THIS SOFTWARE, EVEN IF ADVISED OF THE POSSIBILITY OF SUCH DAMAGE.

(15) Andrey A. Chernov

Copyright (C) 1997 by Andrey A. Chernov, Moscow, Russia.

All rights reserved.

Redistribution and use in source and binary forms, with or without modification, are permitted provided that the following conditions are met:

1. Redistributions of source code must retain the above copyright notice, this list of conditions and the following disclaimer.
2. Redistributions in binary form must reproduce the above copyright notice, this list of conditions and the following disclaimer in the documentation and/or other materials provided with the distribution.

THIS SOFTWARE IS PROVIDED BY THE AUTHOR "AS IS" AND ANY EXPRESS OR IMPLIED WARRANTIES, INCLUDING, BUT NOT LIMITED TO, THE IMPLIED WARRANTIES OF MERCHANTABILITY AND FITNESS FOR A PARTICULAR PURPOSE ARE DISCLAIMED. IN NO

EVENT SHALL THE REGENTS OR CONTRIBUTORS BE LIABLE FOR ANY DIRECT, INDIRECT, INCIDENTAL, SPECIAL, EXEMPLARY, OR CONSEQUENTIAL DAMAGES (INCLUDING, BUT NOT LIMITED TO, PROCUREMENT OF SUBSTITUTE GOODS OR SERVICES; LOSS OF USE, DATA, OR PROFITS; OR BUSINESS INTERRUPTION) HOWEVER CAUSED AND ON ANY THEORY OF LIABILITY, WHETHER IN CONTRACT, STRICT LIABILITY, OR TORT (INCLUDING NEGLIGENCE OR OTHERWISE) ARISING IN ANY WAY OUT OF THE USE OF THIS SOFTWARE, EVEN IF ADVISED OF THE POSSIBILITY OF SUCH DAMAGE.

(16) FreeBSD

Copyright (c) 1997-2002 FreeBSD Project.

All rights reserved.

Redistribution and use in source and binary forms, with or without modification, are permitted provided that the following conditions are met:

1. Redistributions of source code must retain the above copyright notice, this list of conditions and the following disclaimer.
2. Redistributions in binary form must reproduce the above copyright notice, this list of conditions and the following disclaimer in the documentation and/or other materials provided with the distribution.

THIS SOFTWARE IS PROVIDED BY THE AUTHOR AND CONTRIBUTORS "AS IS" AND ANY EXPRESS OR IMPLIED WARRANTIES, INCLUDING, BUT NOT LIMITED TO, THE IMPLIED WARRANTIES OF MERCHANTABILITY AND FITNESS FOR A PARTICULAR PURPOSE ARE DISCLAIMED. IN NO EVENT SHALL THE AUTHOR OR CONTRIBUTORS BE LIABLE FOR ANY DIRECT, INDIRECT, INCIDENTAL, SPECIAL, EXEMPLARY, OR CONSEQUENTIAL DAMAGES (INCLUDING, BUT NOT LIMITED TO, PROCUREMENT OF SUBSTITUTE GOODS OR SERVICES; LOSS OF USE, DATA, OR PROFITS; OR BUSINESS INTERRUPTION) HOWEVER CAUSED AND ON ANY THEORY OF LIABILITY, WHETHER IN CONTRACT, STRICT LIABILITY, OR TORT (INCLUDING NEGLIGENCE OR OTHERWISE) ARISING IN ANY WAY OUT OF THE USE OF THIS SOFTWARE, EVEN IF ADVISED OF THE POSSIBILITY OF SUCH DAMAGE.

(17) S. L. Moshier

Author: S. L. Moshier.

Copyright (c) 1984,2000 S.L. Moshier

Permission to use, copy, modify, and distribute this software for any purpose without fee is hereby granted, provided that this entire notice is included in all copies of any software which is or includes a copy or modification of this software and in all copies of the supporting documentation for such software.

THIS SOFTWARE IS BEING PROVIDED "AS IS", WITHOUT ANY EXPRESS OR IMPLIED WARRANTY. IN PARTICULAR, THE AUTHOR MAKES NO REPRESENTATION OR WARRANTY OF

ANY KIND CONCERNING THE MERCHANTABILITY OF THIS SOFTWARE OR ITS FITNESS FOR ANY PARTICULAR PURPOSE.

(18) Citrus Project

Copyright (c)1999 Citrus Project,

All rights reserved.

Redistribution and use in source and binary forms, with or without modification, are permitted provided that the following conditions are met:

1. Redistributions of source code must retain the above copyright notice, this list of conditions and the following disclaimer.
2. Redistributions in binary form must reproduce the above copyright notice, this list of conditions and the following disclaimer in the documentation and/or other materials provided with the distribution.

THIS SOFTWARE IS PROVIDED BY THE AUTHOR AND CONTRIBUTORS "AS IS" AND ANY EXPRESS OR IMPLIED WARRANTIES, INCLUDING, BUT NOT LIMITED TO, THE IMPLIED WARRANTIES OF MERCHANTABILITY AND FITNESS FOR A PARTICULAR PURPOSE ARE DISCLAIMED. IN NO EVENT SHALL THE AUTHOR OR CONTRIBUTORS BE LIABLE FOR ANY DIRECT, INDIRECT, INCIDENTAL, SPECIAL, EXEMPLARY, OR CONSEQUENTIAL DAMAGES (INCLUDING, BUT NOT LIMITED TO, PROCUREMENT OF SUBSTITUTE GOODS OR SERVICES; LOSS OF USE, DATA, OR PROFITS; OR BUSINESS INTERRUPTION) HOWEVER CAUSED AND ON ANY THEORY OF LIABILITY, WHETHER IN CONTRACT, STRICT LIABILITY, OR TORT (INCLUDING NEGLIGENCE OR OTHERWISE) ARISING IN ANY WAY OUT OF THE USE OF THIS SOFTWARE, EVEN IF ADVISED OF THE POSSIBILITY OF SUCH DAMAGE.

(19) Todd C. Miller

Copyright (c) 1998 Todd C. Miller <Todd.Miller@courtesan.com>

All rights reserved.

Redistribution and use in source and binary forms, with or without modification, are permitted provided that the following conditions are met:

1. Redistributions of source code must retain the above copyright notice, this list of conditions and the following disclaimer.
2. Redistributions in binary form must reproduce the above copyright notice, this list of conditions and the following disclaimer in the documentation and/or other materials provided with the distribution.
3. The name of the author may not be used to endorse or promote products derived from this software without specific prior written permission.

THIS SOFTWARE IS PROVIDED "AS IS" AND ANY EXPRESS OR IMPLIED WARRANTIES, INCLUDING, BUT NOT LIMITED TO, THE IMPLIED WARRANTIES OF MERCHANTABILITY AND

FITNESS FOR A PARTICULAR PURPOSE ARE DISCLAIMED. IN NO EVENT SHALL THE AUTHOR BE LIABLE FOR ANY DIRECT, INDIRECT, INCIDENTAL, SPECIAL, EXEMPLARY, OR CONSEQUENTIAL DAMAGES (INCLUDING, BUT NOT LIMITED TO, PROCUREMENT OF SUBSTITUTE GOODS OR SERVICES; LOSS OF USE, DATA, OR PROFITS; OR BUSINESS INTERRUPTION) HOWEVER CAUSED AND ON ANY THEORY OF LIABILITY, WHETHER IN CONTRACT, STRICT LIABILITY, OR TORT (INCLUDING NEGLIGENCE OR OTHERWISE) ARISING IN ANY WAY OUT OF THE USE OF THIS SOFTWARE, EVEN IF ADVISED OF THE POSSIBILITY OF SUCH DAMAGE.

(20) DJ Delorie (i386)

Copyright (C) 1991 DJ Delorie

All rights reserved.

Redistribution and use in source and binary forms is permitted provided that the above copyright notice and following paragraph are duplicated in all such forms.

This file is distributed WITHOUT ANY WARRANTY; without even the implied warranty of MERCHANTABILITY or FITNESS FOR A PARTICULAR PURPOSE.

(23) Intel (i960)

Copyright (c) 1993 Intel Corporation

Intel hereby grants you permission to copy, modify, and distribute this software and its documentation. Intel grants this permission provided that the above copyright notice appears in all copies and that both the copyright notice and this permission notice appear in supporting documentation. In addition, Intel grants this permission provided that you prominently mark as "not part of the original" any modifications made to this software or documentation, and that the name of Intel Corporation not be used in advertising or publicity pertaining to distribution of the software or the documentation without specific, written prior permission.

Intel Corporation provides this AS IS, WITHOUT ANY WARRANTY, EXPRESS OR IMPLIED, INCLUDING, WITHOUT LIMITATION, ANY WARRANTY OF MERCHANTABILITY OR FITNESS FOR A PARTICULAR PURPOSE. Intel makes no guarantee or representations regarding the use of, or the results of the use of, the software and documentation in terms of correctness, accuracy, reliability, currentness, or otherwise; and you rely on the software, documentation and results solely at your own risk.

IN NO EVENT SHALL INTEL BE LIABLE FOR ANY LOSS OF USE, LOSS OF BUSINESS, LOSS OF PROFITS, INDIRECT, INCIDENTAL, SPECIAL OR CONSEQUENTIAL DAMAGES OF ANY KIND. IN NO EVENT SHALL INTEL'S TOTAL LIABILITY EXCEED THE SUM PAID TO INTEL FOR THE PRODUCT LICENSED HEREUNDER.

(26) Mike Barcroft

Copyright (c) 2001 Mike Barcroft <mike@FreeBSD.org>

All rights reserved.

Redistribution and use in source and binary forms, with or without modification, are permitted provided that the following conditions are met:

1. Redistributions of source code must retain the above copyright notice, this list of conditions and the following disclaimer.
2. Redistributions in binary form must reproduce the above copyright notice, this list of conditions and the following disclaimer in the documentation and/or other materials provided with the distribution.

THIS SOFTWARE IS PROVIDED BY THE AUTHOR AND CONTRIBUTORS "AS IS" AND ANY EXPRESS OR IMPLIED WARRANTIES, INCLUDING, BUT NOT LIMITED TO, THE IMPLIED WARRANTIES OF MERCHANTABILITY AND FITNESS FOR A PARTICULAR PURPOSE ARE DISCLAIMED. IN NO EVENT SHALL THE AUTHOR OR CONTRIBUTORS BE LIABLE FOR ANY DIRECT, INDIRECT, INCIDENTAL, SPECIAL, EXEMPLARY, OR CONSEQUENTIAL DAMAGES (INCLUDING, BUT NOT LIMITED TO, PROCUREMENT OF SUBSTITUTE GOODS OR SERVICES; LOSS OF USE, DATA, OR PROFITS; OR BUSINESS INTERRUPTION) HOWEVER CAUSED AND ON ANY THEORY OF LIABILITY, WHETHER IN CONTRACT, STRICT LIABILITY, OR TORT (INCLUDING NEGLIGENCE OR OTHERWISE) ARISING IN ANY WAY OUT OF THE USE OF THIS SOFTWARE, EVEN IF ADVISED OF THE POSSIBILITY OF SUCH DAMAGE.

(27) Konstantin Chuguev (--enable-newlib-iconv)

Copyright (c) 1999, 2000

Konstantin Chuguev. All rights reserved.

Redistribution and use in source and binary forms, with or without modification, are permitted provided that the following conditions are met:

1. Redistributions of source code must retain the above copyright notice, this list of conditions and the following disclaimer.
2. Redistributions in binary form must reproduce the above copyright notice, this list of conditions and the following disclaimer in the documentation and/or other materials provided with the distribution.

THIS SOFTWARE IS PROVIDED BY THE AUTHOR AND CONTRIBUTORS "AS IS" AND ANY EXPRESS OR IMPLIED WARRANTIES, INCLUDING, BUT NOT LIMITED TO, THE IMPLIED WARRANTIES OF MERCHANTABILITY AND FITNESS FOR A PARTICULAR PURPOSE ARE DISCLAIMED. IN NO EVENT SHALL THE AUTHOR OR CONTRIBUTORS BE LIABLE FOR ANY DIRECT, INDIRECT, INCIDENTAL, SPECIAL, EXEMPLARY, OR CONSEQUENTIAL DAMAGES (INCLUDING, BUT NOT LIMITED TO, PROCUREMENT OF SUBSTITUTE GOODS OR SERVICES; LOSS OF USE, DATA, OR PROFITS; OR BUSINESS INTERRUPTION) HOWEVER CAUSED AND ON ANY THEORY OF LIABILITY, WHETHER IN CONTRACT, STRICT LIABILITY, OR TORT (INCLUDING



NEGLIGENCE OR OTHERWISE) ARISING IN ANY WAY OUT OF THE USE OF THIS SOFTWARE, EVEN IF ADVISED OF THE POSSIBILITY OF SUCH DAMAGE.

iconv (Charset Conversion Library) v2.0

(28) Artem Bityuckiy (--enable-newlib-iconv)

Copyright (c) 2003, Artem B. Bityuckiy, SoftMine Corporation. Rights transferred to Franklin Electronic Publishers.

Redistribution and use in source and binary forms, with or without modification, are permitted provided that the following conditions are met:

1. Redistributions of source code must retain the above copyright notice, this list of conditions and the following disclaimer.
2. Redistributions in binary form must reproduce the above copyright notice, this list of conditions and the following disclaimer in the documentation and/or other materials provided with the distribution.

THIS SOFTWARE IS PROVIDED BY THE AUTHOR AND CONTRIBUTORS "AS IS" AND ANY EXPRESS OR IMPLIED WARRANTIES, INCLUDING, BUT NOT LIMITED TO, THE IMPLIED WARRANTIES OF MERCHANTABILITY AND FITNESS FOR A PARTICULAR PURPOSE ARE DISCLAIMED. IN NO EVENT SHALL THE AUTHOR OR CONTRIBUTORS BE LIABLE FOR ANY DIRECT, INDIRECT, INCIDENTAL, SPECIAL, EXEMPLARY, OR CONSEQUENTIAL DAMAGES (INCLUDING, BUT NOT LIMITED TO, PROCUREMENT OF SUBSTITUTE GOODS OR SERVICES; LOSS OF USE, DATA, OR PROFITS; OR BUSINESS INTERRUPTION) HOWEVER CAUSED AND ON ANY THEORY OF LIABILITY, WHETHER IN CONTRACT, STRICT LIABILITY, OR TORT (INCLUDING NEGLIGENCE OR OTHERWISE) ARISING IN ANY WAY OUT OF THE USE OF THIS SOFTWARE, EVEN IF ADVISED OF THE POSSIBILITY OF SUCH DAMAGE.

(30) - Alex Tatmanjants (targets using libc/posix)

Copyright (c) 1995 Alex Tatmanjants <alex@elvisti.kiev.ua>

at Electronni Visti IA, Kiev, Ukraine.

All rights reserved.

Redistribution and use in source and binary forms, with or without modification, are permitted provided that the following conditions are met:

1. Redistributions of source code must retain the above copyright notice, this list of conditions and the following disclaimer.
2. Redistributions in binary form must reproduce the above copyright notice, this list of conditions and the following disclaimer in the documentation and/or other materials provided with the distribution.

THIS SOFTWARE IS PROVIDED BY THE AUTHOR "AS IS" AND ANY EXPRESS OR IMPLIED WARRANTIES, INCLUDING, BUT NOT LIMITED TO, THE IMPLIED WARRANTIES OF

MERCHANTABILITY AND FITNESS FOR A PARTICULAR PURPOSE ARE DISCLAIMED. IN NO EVENT SHALL THE AUTHOR BE LIABLE FOR ANY DIRECT, INDIRECT, INCIDENTAL, SPECIAL, EXEMPLARY, OR CONSEQUENTIAL DAMAGES (INCLUDING, BUT NOT LIMITED TO, PROCUREMENT OF SUBSTITUTE GOODS OR SERVICES; LOSS OF USE, DATA, OR PROFITS; OR BUSINESS INTERRUPTION) HOWEVER CAUSED AND ON ANY THEORY OF LIABILITY, WHETHER IN CONTRACT, STRICT LIABILITY, OR TORT (INCLUDING NEGLIGENCE OR OTHERWISE) ARISING IN ANY WAY OUT OF THE USE OF THIS SOFTWARE, EVEN IF ADVISED OF THE POSSIBILITY OF SUCH DAMAGE.

(31) - M. Warner Losh (targets using libc/posix)

Copyright (c) 1998, M. Warner Losh <imp@freebsd.org>

All rights reserved.

Redistribution and use in source and binary forms, with or without modification, are permitted provided that the following conditions are met:

1. Redistributions of source code must retain the above copyright notice, this list of conditions and the following disclaimer.
2. Redistributions in binary form must reproduce the above copyright notice, this list of conditions and the following disclaimer in the documentation and/or other materials provided with the distribution.

THIS SOFTWARE IS PROVIDED BY THE AUTHOR AND CONTRIBUTORS "AS IS" AND ANY EXPRESS OR IMPLIED WARRANTIES, INCLUDING, BUT NOT LIMITED TO, THE IMPLIED WARRANTIES OF MERCHANTABILITY AND FITNESS FOR A PARTICULAR PURPOSE ARE DISCLAIMED. IN NO EVENT SHALL THE AUTHOR OR CONTRIBUTORS BE LIABLE FOR ANY DIRECT, INDIRECT, INCIDENTAL, SPECIAL, EXEMPLARY, OR CONSEQUENTIAL DAMAGES (INCLUDING, BUT NOT LIMITED TO, PROCUREMENT OF SUBSTITUTE GOODS OR SERVICES; LOSS OF USE, DATA, OR PROFITS; OR BUSINESS INTERRUPTION) HOWEVER CAUSED AND ON ANY THEORY OF LIABILITY, WHETHER IN CONTRACT, STRICT LIABILITY, OR TORT (INCLUDING NEGLIGENCE OR OTHERWISE) ARISING IN ANY WAY OUT OF THE USE OF THIS SOFTWARE, EVEN IF ADVISED OF THE POSSIBILITY OF SUCH DAMAGE.

(32) - Andrey A. Chernov (targets using libc/posix)

Copyright (C) 1996 by Andrey A. Chernov, Moscow, Russia.

All rights reserved.

Redistribution and use in source and binary forms, with or without modification, are permitted provided that the following conditions are met:

1. Redistributions of source code must retain the above copyright notice, this list of conditions and the following disclaimer.

2. Redistributions in binary form must reproduce the above copyright notice, this list of conditions and the following disclaimer in the documentation and/or other materials provided with the distribution.

THIS SOFTWARE IS PROVIDED BY THE AUTHOR "AS IS" AND ANY EXPRESS OR IMPLIED WARRANTIES, INCLUDING, BUT NOT LIMITED TO, THE IMPLIED WARRANTIES OF MERCHANTABILITY AND FITNESS FOR A PARTICULAR PURPOSE ARE DISCLAIMED. IN NO EVENT SHALL THE REGENTS OR CONTRIBUTORS BE LIABLE FOR ANY DIRECT, INDIRECT, INCIDENTAL, SPECIAL, EXEMPLARY, OR CONSEQUENTIAL DAMAGES (INCLUDING, BUT NOT LIMITED TO, PROCUREMENT OF SUBSTITUTE GOODS OR SERVICES; LOSS OF USE, DATA, OR PROFITS; OR BUSINESS INTERRUPTION) HOWEVER CAUSED AND ON ANY THEORY OF LIABILITY, WHETHER IN CONTRACT, STRICT LIABILITY, OR TORT (INCLUDING NEGLIGENCE OR OTHERWISE) ARISING IN ANY WAY OUT OF THE USE OF THIS SOFTWARE, EVEN IF ADVISED OF THE POSSIBILITY OF SUCH DAMAGE.

(33) - Daniel Eischen (targets using libc/posix)

Copyright (c) 2001 Daniel Eischen <deischen@FreeBSD.org>.

All rights reserved.

Redistribution and use in source and binary forms, with or without modification, are permitted provided that the following conditions are met:

1. Redistributions of source code must retain the above copyright notice, this list of conditions and the following disclaimer.

2. Redistributions in binary form must reproduce the above copyright notice, this list of conditions and the following disclaimer in the documentation and/or other materials provided with the distribution.

THIS SOFTWARE IS PROVIDED BY THE AUTHOR AND CONTRIBUTORS "AS IS" AND ANY EXPRESS OR IMPLIED WARRANTIES, INCLUDING, BUT NOT LIMITED TO, THE IMPLIED WARRANTIES OF MERCHANTABILITY AND FITNESS FOR A PARTICULAR PURPOSE ARE DISCLAIMED. IN NO EVENT SHALL THE REGENTS OR CONTRIBUTORS BE LIABLE FOR ANY DIRECT, INDIRECT, INCIDENTAL, SPECIAL, EXEMPLARY, OR CONSEQUENTIAL DAMAGES (INCLUDING, BUT NOT LIMITED TO, PROCUREMENT OF SUBSTITUTE GOODS OR SERVICES; LOSS OF USE, DATA, OR PROFITS; OR BUSINESS INTERRUPTION) HOWEVER CAUSED AND ON ANY THEORY OF LIABILITY, WHETHER IN CONTRACT, STRICT LIABILITY, OR TORT (INCLUDING NEGLIGENCE OR OTHERWISE) ARISING IN ANY WAY OUT OF THE USE OF THIS SOFTWARE, EVEN IF ADVISED OF THE POSSIBILITY OF SUCH DAMAGE.

(35) - ARM Ltd (arm and thumb variant targets only)

Copyright (c) 2009 ARM Ltd

All rights reserved.

Redistribution and use in source and binary forms, with or without modification, are permitted provided that the following conditions are met:

1. Redistributions of source code must retain the above copyright notice, this list of conditions and the following disclaimer.
2. Redistributions in binary form must reproduce the above copyright notice, this list of conditions and the following disclaimer in the documentation and/or other materials provided with the distribution.
3. The name of the company may not be used to endorse or promote products derived from this software without specific prior written permission.

THIS SOFTWARE IS PROVIDED BY ARM LTD "AS IS" AND ANY EXPRESS OR IMPLIED WARRANTIES, INCLUDING, BUT NOT LIMITED TO, THE IMPLIED WARRANTIES OF MERCHANTABILITY AND FITNESS FOR A PARTICULAR PURPOSE ARE DISCLAIMED. IN NO EVENT SHALL ARM LTD BE LIABLE FOR ANY DIRECT, INDIRECT, INCIDENTAL, SPECIAL, EXEMPLARY, OR CONSEQUENTIAL DAMAGES (INCLUDING, BUT NOT LIMITED TO, PROCUREMENT OF SUBSTITUTE GOODS OR SERVICES; LOSS OF USE, DATA, OR PROFITS; OR BUSINESS INTERRUPTION) HOWEVER CAUSED AND ON ANY THEORY OF LIABILITY, WHETHER IN CONTRACT, STRICT LIABILITY, OR TORT (INCLUDING NEGLIGENCE OR OTHERWISE) ARISING IN ANY WAY OUT OF THE USE OF THIS SOFTWARE, EVEN IF ADVISED OF THE POSSIBILITY OF SUCH DAMAGE.

(36) - CodeSourcery, Inc.

Copyright (c) 2009 CodeSourcery, Inc.

All rights reserved.

Redistribution and use in source and binary forms, with or without modification, are permitted provided that the following conditions are met:

- \* Redistributions of source code must retain the above copyright notice, this list of conditions and the following disclaimer.
- \* Redistributions in binary form must reproduce the above copyright notice, this list of conditions and the following disclaimer in the documentation and/or other materials provided with the distribution.
- \* Neither the name of CodeSourcery nor the names of its contributors may be used to endorse or promote products derived from this software without specific prior written permission.

THIS SOFTWARE IS PROVIDED BY CODESOURCERY, INC. "AS IS" AND ANY EXPRESS OR IMPLIED WARRANTIES, INCLUDING, BUT NOT LIMITED TO, THE IMPLIED WARRANTIES OF MERCHANTABILITY AND FITNESS FOR A PARTICULAR PURPOSE ARE DISCLAIMED. IN NO EVENT SHALL CODESOURCERY BE LIABLE FOR ANY DIRECT, INDIRECT, INCIDENTAL, SPECIAL, EXEMPLARY, OR CONSEQUENTIAL DAMAGES (INCLUDING, BUT NOT LIMITED TO, PROCUREMENT OF SUBSTITUTE GOODS OR SERVICES; LOSS OF USE, DATA, OR PROFITS;

OR BUSINESS INTERRUPTION) HOWEVER CAUSED AND ON ANY THEORY OF LIABILITY, WHETHER IN CONTRACT, STRICT LIABILITY, OR TORT (INCLUDING NEGLIGENCE OR OTHERWISE) ARISING IN ANY WAY OUT OF THE USE OF THIS SOFTWARE, EVEN IF ADVISED OF THE POSSIBILITY OF SUCH DAMAGE.

(37) MIPS Technologies, Inc

/\*

\* Copyright (c) 2009 MIPS Technologies, Inc.

\* All rights reserved.

\* Redistribution and use in source and binary forms, with or without modification, are permitted provided that the following conditions are met:

\* \* Redistributions of source code must retain the above copyright notice, this list of conditions and the following disclaimer.

\* \* Redistributions in binary form must reproduce the above copyright notice, this list of conditions and the following disclaimer in the documentation and/or other materials provided with the distribution.

\* \* Neither the name of MIPS Technologies Inc. nor the names of its contributors may be used to endorse or promote products derived from this software without specific prior written permission.

\* THIS SOFTWARE IS PROVIDED BY THE COPYRIGHT HOLDERS AND CONTRIBUTORS "AS IS" AND ANY EXPRESS OR IMPLIED WARRANTIES, INCLUDING, BUT NOT LIMITED TO, THE IMPLIED WARRANTIES OF MERCHANTABILITY AND FITNESS FOR A PARTICULAR PURPOSE ARE DISCLAIMED. IN NO EVENT SHALL THE COPYRIGHT OWNER OR CONTRIBUTORS BE LIABLE FOR ANY DIRECT, INDIRECT, INCIDENTAL, SPECIAL, EXEMPLARY, OR CONSEQUENTIAL DAMAGES (INCLUDING, BUT NOT LIMITED TO, PROCUREMENT OF SUBSTITUTE GOODS OR SERVICES; LOSS OF USE, DATA, OR PROFITS; OR BUSINESS INTERRUPTION) HOWEVER CAUSED AND ON ANY THEORY OF LIABILITY, WHETHER IN CONTRACT, STRICT LIABILITY, OR TORT (INCLUDING NEGLIGENCE OR OTHERWISE) ARISING IN ANY WAY OUT OF THE USE OF THIS SOFTWARE, EVEN IF ADVISED OF THE POSSIBILITY OF SUCH DAMAGE.

\*/

### **MIT License**

This projector product includes the open source software program which applies the terms and conditions provided by owner of the copyright to the "MIT License".

The "MIT License" are WITHOUT ANY WARRANTY; without even the implied warranty of MERCHANTABILITY AND FITNESS FOR A PARTICULAR PURPOSE.

List of MIT License programs

- jquery-1.7.2.min.js
- jquery-ui-1.8.20
- jquery.ui.touch-punch.js
- jquery.upload-1.0.2.min.js
- jquery-1.11.3.min.js
- jquery-ui-1.11.4

License terms of conditions of each program which are provided by owner of the copyright to the "MIT License" are as follows.

Copyright (c) 2012 jQuery Foundation and other contributors,

<http://jquery.com/>

Copyright (c) Nicolas Gallagher and Jonathan Neal

Permission is hereby granted, free of charge, to any person obtaining a copy of this software and associated documentation files (the "Software"), to deal in the Software without restriction, including without limitation the rights to use, copy, modify, merge, publish, distribute, sublicense, and/or sell copies of the Software, and to permit persons to whom the Software is furnished to do so, subject to the following conditions:

The above copyright notice and this permission notice shall be included in all copies or substantial portions of the Software.

THE SOFTWARE IS PROVIDED "AS IS", WITHOUT WARRANTY OF ANY KIND, EXPRESS OR IMPLIED, INCLUDING BUT NOT LIMITED TO THE WARRANTIES OF MERCHANTABILITY, FITNESS FOR A PARTICULAR PURPOSE AND NONINFRINGEMENT. IN NO EVENT SHALL THE AUTHORS OR COPYRIGHT HOLDERS BE LIABLE FOR ANY CLAIM, DAMAGES OR OTHER LIABILITY, WHETHER IN AN ACTION OF CONTRACT, TORT OR OTHERWISE, ARISING FROM, OUT OF OR IN CONNECTION WITH THE SOFTWARE OR THE USE OR OTHER DEALINGS IN THE SOFTWARE.

### **TOPPERS/JSP**

This projector product includes the open source software program "TOPPERS/JSP" which applies the terms and conditions provided by owner of the copyright to the "TOPPERS/JSP".

The "TOPPERS/JSP" are WITHOUT ANY WARRANTY; without even the implied warranty of MERCHANTABILITY AND FITNESS FOR A PARTICULAR PURPOSE.

List of TOPPERS/JSP programs

- jsp-1.4.3

License terms of conditions of each program which are provided by owner of the copyright to the "TOPPERS/JSP" are as follows.

TOPPERS/JSP Kernel

Toyohashi Open Platform for Embedded Real-Time Systems/Just Standard Profile Kernel

Copyright (C) 2000-2003 by Embedded and Real-Time Systems Laboratory Toyohashi Univ. of Technology, JAPAN

Copyright (C) 2004 by Embedded and Real-Time Systems Laboratory Graduate School of Information Science, Nagoya Univ., JAPAN.

The above copyright holder, limited to cases in which one satisfies conditions (1) ~ (4) below, or the conditions described in Version 2 of the GNU Public License officially announced by the Free Software Foundation, consents to the use, reproduction, alteration, and redistribution (hereafter called utilization) of this software (this software includes alterations, likewise below) without compensation.

(1) When this software is utilized in the form of source code, the above copyright declaration, these conditions of utilization, and the following stipulation of no guarantee shall be included in unchanged form inside the source code.

(2) When this software is redistributed in a form in which it can be used in the development of other software, library form, etc., the above copyright display, these terms of utilization, and the following stipulation of no guarantee shall be inserted in documentation accompanying redistribution (user's manual, etc.).

(3) When this software is redistributed in a form in which it cannot be used in the development of other software, embedded in devices, etc., one of the following conditions shall be satisfied.

(a) The above copyright display, these terms of utilization, and the following stipulation of no guarantee shall be inserted in documentation accompanying redistribution (user's manual, etc.).

(b) The TOPPERS Project shall be notified owing to a method in which the form of distribution is decided otherwise.

(4) The above copyright holder and the TOPPERS Project shall be exempt from responsibility for whatever damages occur either directly or indirectly through the utilization of this software.

This software is something that is provided with no guarantee. The above copyright holder and the TOPPERS Project make no guarantee whatsoever in regard to this software, including the possibility of its application. In addition, the above copyright holder and the TOPPERS Project shall also not bear responsibility for whatever damages occur either directly or indirectly through the utilization of this software.

Note: The TOPPERS License has been revised several times; what is shown above is the latest version that is to be applied to software made public hereafter.

## TINET

This projector product includes the open source software program "TINET" which applies the terms and conditions provided by owner of the copyright to the "TINET".

The "TINET" are WITHOUT ANY WARRANTY; without even the implied warranty of MERCHANTABILITY AND FITNESS FOR A PARTICULAR PURPOSE.

List of TINET programs

- tinet-1.4.4

License terms of conditions of each program which are provided by owner of the copyright to the "TINET" are as follows.

(1) FreeBSD

Copyright (c) 1980, 1986, 1993

The Regents of the University of California. All rights reserved.

Redistribution and use in source and binary forms, with or without modification, are permitted provided that the following conditions are met:

1. Redistributions of source code must retain the above copyright notice, this list of conditions and the following disclaimer.
2. Redistributions in binary form must reproduce the above copyright notice, this list of conditions and the following disclaimer in the documentation and/or other materials provided with the distribution.
3. All advertising materials mentioning features or use of this software must display the following acknowledgement:

This product includes software developed by the University of California, Berkeley and its contributors.

4. Neither the name of the University nor the names of its contributors may be used to endorse or promote products derived from this software without specific prior written permission.

THIS SOFTWARE IS PROVIDED BY THE REGENTS AND CONTRIBUTORS "AS IS" AND ANY EXPRESS OR IMPLIED WARRANTIES, INCLUDING, BUT NOT LIMITED TO, THE IMPLIED WARRANTIES OF MERCHANTABILITY AND FITNESS FOR A PARTICULAR PURPOSE ARE DISCLAIMED. IN NO EVENT SHALL THE REGENTS OR CONTRIBUTORS BE LIABLE FOR ANY DIRECT, INDIRECT, INCIDENTAL, SPECIAL, EXEMPLARY, OR CONSEQUENTIAL DAMAGES (INCLUDING, BUT NOT LIMITED TO, PROCUREMENT OF SUBSTITUTE GOODS OR SERVICES; LOSS OF USE, DATA, OR PROFITS; OR BUSINESS INTERRUPTION) HOWEVER CAUSED AND ON ANY THEORY OF LIABILITY, WHETHER IN CONTRACT, STRICT LIABILITY, OR TORT (INCLUDING NEGLIGENCE OR OTHERWISE) ARISING IN ANY WAY OUT OF THE USE OF THIS SOFTWARE, EVEN IF ADVISED OF THE POSSIBILITY OF SUCH DAMAGE.



## (6) TINET and TOPPERS

TINET (TCP/IP Protocol Stack)

Copyright (C) 2001-2006 by Dep. of Computer Science and Engineering Tomakomai National College of Technology, JAPAN

The above copyright holder, limited to cases in which one satisfies conditions (1) ~ (4) below, or the conditions described in Version 2 of the GNU Public License officially announced by the Free Software Foundation, consents to the use, reproduction, alteration, and redistribution (hereafter called utilization) of this software (this software includes alterations, likewise below) without compensation.

(1) When this software is utilized in the form of source code, the above copyright declaration, these conditions of utilization, and the following stipulation of no guarantee shall be included in unchanged form inside the source code.

(2) When this software is redistributed in a form in which it can be used in the development of other software, library form, etc., the above copyright display, these terms of utilization, and the following stipulation of no guarantee shall be inserted in documentation accompanying redistribution (user's manual, etc.).

(3) When this software is redistributed in a form in which it cannot be used in the development of other software, embedded in devices, etc., following conditions shall be satisfied.

(a) The above copyright display, these terms of utilization, and the following stipulation of no guarantee shall be inserted in documentation accompanying redistribution (user's manual, etc.).

(4) The above copyright holder and the TOPPERS Project shall be exempt from responsibility for whatever damages occur either directly or indirectly through the utilization of this software.

This software is something that is provided with no guarantee. The above copyright holder and the TOPPERS Project make no guarantee whatsoever in regard to this software, including the possibility of its application. In addition, the above copyright holder and the TOPPERS Project shall also not bear responsibility for whatever damages occur either directly or indirectly through the utilization of this software.

### **WPA Supplicant**

This projector product includes the open source software program which applies the terms and conditions provided by owner of the copyright to the "WPA Supplicant".

The "WPA Supplicant" are WITHOUT ANY WARRANTY; without even the implied warranty of MERCHANTABILITY AND FITNESS FOR A PARTICULAR PURPOSE.

List of WPA Supplicant programs

- wpa\_supplicant-2.3

License terms of conditions of each program which are provided by owner of the copyright to the "WPA Supplicant" are as follows.

Copyright (c) 2003-2014, Jouni Malinen <j@w1.fi> and contributors

All Rights Reserved.

This program is licensed under the BSD license (the one with advertisement clause removed).

If you are submitting changes to the project, please see CONTRIBUTIONS file for more instructions.

License

-----

This software may be distributed, used, and modified under the terms of BSD license:

Redistribution and use in source and binary forms, with or without modification, are permitted provided that the following conditions are met:

1. Redistributions of source code must retain the above copyright notice, this list of conditions and the following disclaimer.
2. Redistributions in binary form must reproduce the above copyright notice, this list of conditions and the following disclaimer in the documentation and/or other materials provided with the distribution.
3. Neither the name(s) of the above-listed copyright holder(s) nor the names of its contributors may be used to endorse or promote products derived from this software without specific prior written permission.

THIS SOFTWARE IS PROVIDED BY THE COPYRIGHT HOLDERS AND CONTRIBUTORS "AS IS" AND ANY EXPRESS OR IMPLIED WARRANTIES, INCLUDING, BUT NOT LIMITED TO, THE IMPLIED WARRANTIES OF MERCHANTABILITY AND FITNESS FOR A PARTICULAR PURPOSE ARE DISCLAIMED. IN NO EVENT SHALL THE COPYRIGHT OWNER OR CONTRIBUTORS BE LIABLE FOR ANY DIRECT, INDIRECT, INCIDENTAL, SPECIAL, EXEMPLARY, OR CONSEQUENTIAL DAMAGES (INCLUDING, BUT NOT LIMITED TO, PROCUREMENT OF SUBSTITUTE GOODS OR SERVICES; LOSS OF USE, DATA, OR PROFITS; OR BUSINESS INTERRUPTION) HOWEVER CAUSED AND ON ANY THEORY OF LIABILITY, WHETHER IN CONTRACT, STRICT LIABILITY, OR TORT (INCLUDING NEGLIGENCE OR OTHERWISE) ARISING IN ANY WAY OUT OF THE USE OF THIS SOFTWARE, EVEN IF ADVISED OF THE POSSIBILITY OF SUCH DAMAGE.

### **lighttpd**

This projector product includes the open source software program "lighttpd" which applies the terms and conditions provided by owner of the copyright to the "lighttpd".

The "lighttpd" are WITHOUT ANY WARRANTY; without even the implied warranty of MERCHANTABILITY AND FITNESS FOR A PARTICULAR PURPOSE.

List of lighttpd programs

- lighttpd-1.4.35

License terms of conditions of each program which are provided by owner of the copyright to the "lighttpd" are as follows.

Copyright (c) 2004, Jan Kneschke, incremental

All rights reserved.

Redistribution and use in source and binary forms, with or without modification, are permitted provided that the following conditions are met:

- Redistributions of source code must retain the above copyright notice, this list of conditions and the following disclaimer.
- Redistributions in binary form must reproduce the above copyright notice, this list of conditions and the following disclaimer in the documentation and/or other materials provided with the distribution.
- Neither the name of the 'incremental' nor the names of its contributors may be used to endorse or promote products derived from this software without specific prior written permission.

THIS SOFTWARE IS PROVIDED BY THE COPYRIGHT HOLDERS AND CONTRIBUTORS "AS IS" AND ANY EXPRESS OR IMPLIED WARRANTIES, INCLUDING, BUT NOT LIMITED TO, THE IMPLIED WARRANTIES OF MERCHANTABILITY AND FITNESS FOR A PARTICULAR PURPOSE ARE DISCLAIMED. IN NO EVENT SHALL THE COPYRIGHT OWNER OR CONTRIBUTORS BE LIABLE FOR ANY DIRECT, INDIRECT, INCIDENTAL, SPECIAL, EXEMPLARY, OR CONSEQUENTIAL DAMAGES (INCLUDING, BUT NOT LIMITED TO, PROCUREMENT OF SUBSTITUTE GOODS OR SERVICES; LOSS OF USE, DATA, OR PROFITS; OR BUSINESS INTERRUPTION) HOWEVER CAUSED AND ON ANY THEORY OF LIABILITY, WHETHER IN CONTRACT, STRICT LIABILITY, OR TORT (INCLUDING NEGLIGENCE OR OTHERWISE) ARISING IN ANY WAY OUT OF THE USE OF THIS SOFTWARE, EVEN IF ADVISED OF THE POSSIBILITY OF SUCH DAMAGE

## **PCRE**

This projector product includes the open source software program "PCRE" which applies the terms and conditions provided by owner of the copyright to the "PCRE".

The "PCRE" are WITHOUT ANY WARRANTY; without even the implied warranty of MERCHANTABILITY AND FITNESS FOR A PARTICULAR PURPOSE.

List of PCRE programs

- pcre-8.32

License terms of conditions of each program which are provided by owner of the copyright to the "PCRE" are as follows.

## **PCRE LICENCE**

-----

PCRE is a library of functions to support regular expressions whose syntax and semantics are as close as possible to those of the Perl 5 language.

Release 8 of PCRE is distributed under the terms of the "BSD" licence, as specified below. The documentation for PCRE, supplied in the "doc" directory, is distributed under the same terms as the software itself.

The basic library functions are written in C and are freestanding. Also included in the distribution is a set of C++ wrapper functions, and a just-in-time compiler that can be used to optimize pattern matching. These are both optional features that can be omitted when the library is built.

## **THE BASIC LIBRARY FUNCTIONS**

-----

Written by: Philip Hazel

Email local part: ph10

Email domain: cam.ac.uk

University of Cambridge Computing Service, Cambridge, England.

Copyright (c) 1997-2012 University of Cambridge

All rights reserved.

## **PCRE JUST-IN-TIME COMPILATION SUPPORT**

-----

Written by: Zoltan Herczeg

Email local part: hzmester

Email domain: freemail.hu

Copyright(c) 2010-2012 Zoltan Herczeg

All rights reserved.

## **STACK-LESS JUST-IN-TIME COMPILER**

-----

Written by: Zoltan Herczeg

Email local part: hzmester

Email domain: freemail.hu  
Copyright(c) 2009-2012 Zoltan Herczeg  
All rights reserved.

### **THE C++ WRAPPER FUNCTIONS**

-----

Contributed by: Google Inc.  
Copyright (c) 2007-2012, Google Inc.  
All rights reserved.

### **THE "BSD" LICENCE**

-----

Redistribution and use in source and binary forms, with or without modification, are permitted provided that the following conditions are met:

- \* Redistributions of source code must retain the above copyright notice, this list of conditions and the following disclaimer.
- \* Redistributions in binary form must reproduce the above copyright notice, this list of conditions and the following disclaimer in the documentation and/or other materials provided with the distribution.
- \* Neither the name of the University of Cambridge nor the name of Google Inc. nor the names of their contributors may be used to endorse or promote products derived from this software without specific prior written permission.

THIS SOFTWARE IS PROVIDED BY THE COPYRIGHT HOLDERS AND CONTRIBUTORS "AS IS" AND ANY EXPRESS OR IMPLIED WARRANTIES, INCLUDING, BUT NOT LIMITED TO, THE IMPLIED WARRANTIES OF MERCHANTABILITY AND FITNESS FOR A PARTICULAR PURPOSE ARE DISCLAIMED. IN NO EVENT SHALL THE COPYRIGHT OWNER OR CONTRIBUTORS BE LIABLE FOR ANY DIRECT, INDIRECT, INCIDENTAL, SPECIAL, EXEMPLARY, OR CONSEQUENTIAL DAMAGES (INCLUDING, BUT NOT LIMITED TO, PROCUREMENT OF SUBSTITUTE GOODS OR SERVICES; LOSS OF USE, DATA, OR PROFITS; OR BUSINESS INTERRUPTION) HOWEVER CAUSED AND ON ANY THEORY OF LIABILITY, WHETHER IN CONTRACT, STRICT LIABILITY, OR TORT (INCLUDING NEGLIGENCE OR OTHERWISE) ARISING IN ANY WAY OUT OF THE USE OF THIS SOFTWARE, EVEN IF ADVISED OF THE POSSIBILITY OF SUCH DAMAGE.

End

## **FastCGI**

This projector product includes the open source software program "FastCGI" which applies the terms and conditions provided by owner of the copyright to the "FastCGI"

The "FastCGI" are WITHOUT ANY WARRANTY; without even the implied warranty of MERCHANTABILITY AND FITNESS FOR A PARTICULAR PURPOSE.

List of FastCGI programs

- fcgi-2.4.0

License terms of conditions of each program which are provided by owner of the copyright to the "FastCGI" are as follows.

This FastCGI application library source and object code (the "Software") and its documentation (the "Documentation") are copyrighted by Open Market, Inc ("Open Market"). The following terms apply to all files associated with the Software and Documentation unless explicitly disclaimed in individual files.

Open Market permits you to use, copy, modify, distribute, and license this Software and the Documentation for any purpose, provided that existing copyright notices are retained in all copies and that this notice is included verbatim in any distributions. No written agreement, license, or royalty fee is required for any of the authorized uses. Modifications to this Software and Documentation may be copyrighted by their authors and need not follow the licensing terms described here. If modifications to this Software and Documentation have new licensing terms, the new terms must be clearly indicated on the first page of each file where they apply.

OPEN MARKET MAKES NO EXPRESS OR IMPLIED WARRANTY WITH RESPECT TO THE SOFTWARE OR THE DOCUMENTATION, INCLUDING WITHOUT LIMITATION ANY WARRANTY OF MERCHANTABILITY OR FITNESS FOR A PARTICULAR PURPOSE. IN NO EVENT SHALL OPEN MARKET BE LIABLE TO YOU OR ANY THIRD PARTY FOR ANY DAMAGES ARISING FROM OR RELATING TO THIS SOFTWARE OR THE DOCUMENTATION, INCLUDING, WITHOUT LIMITATION, ANY INDIRECT, SPECIAL OR CONSEQUENTIAL DAMAGES OR SIMILAR DAMAGES, INCLUDING LOST PROFITS OR LOST DATA, EVEN IF OPEN MARKET HAS BEEN ADVISED OF THE POSSIBILITY OF SUCH DAMAGES. THE SOFTWARE AND DOCUMENTATION ARE PROVIDED "AS IS". OPEN MARKET HAS NO LIABILITY IN CONTRACT, TORT, NEGLIGENCE OR OTHERWISE ARISING OUT OF THIS SOFTWARE OR THE DOCUMENTATION.

**Parent topic:** [Notices](#)

# Binding Arbitration and Class Waiver

## 1. DISPUTES, BINDING INDIVIDUAL ARBITRATION, AND WAIVER OF CLASS ACTIONS AND CLASS ARBITRATIONS

1.1 **Disputes.** The terms of this Section 1 shall apply to all Disputes between you and Epson. The term "Dispute" is meant to have the broadest meaning permissible under law and includes any dispute, claim, controversy or action between you and Epson arising out of or relating to this Agreement, Epson branded products (hardware and including any related software), or other transaction involving you and Epson, whether in contract, warranty, misrepresentation, fraud, tort, intentional tort, statute, regulation, ordinance, or any other legal or equitable basis. "DISPUTE" DOES NOT INCLUDE IP CLAIMS, or more specifically, a claim or cause of action for (a) trademark infringement or dilution, (b) patent infringement, (c) copyright infringement or misuse, or (d) trade secret misappropriation (an "IP Claim"). You and Epson also agree, notwithstanding Section 1.6, that a court, not an arbitrator, may decide if a claim or cause of action is for an IP Claim.

1.2 **Binding Arbitration.** You and Epson agree that all Disputes shall be resolved by binding arbitration according to this Agreement. **ARBITRATION MEANS THAT YOU WAIVE YOUR RIGHT TO A JUDGE OR JURY IN A COURT PROCEEDING AND YOUR GROUNDS FOR APPEAL ARE LIMITED.**

Pursuant to this Agreement, binding arbitration shall be administered by JAMS, a nationally recognized arbitration authority, pursuant to its code of procedures then in effect for consumer related disputes, but excluding any rules that permit joinder or class actions in arbitration (for more detail on procedure, see Section 1.6 below). You and Epson understand and agree that (a) the Federal Arbitration Act (9 U.S.C. §1, et seq.) governs the interpretation and enforcement of this Section 1, (b) this Agreement memorializes a transaction in interstate commerce, and (c) this Section 1 shall survive termination of this Agreement.

1.3 **Pre-Arbitration Steps and Notice.** Before submitting a claim for arbitration, you and Epson agree to try, for sixty (60) days, to resolve any Dispute informally. If Epson and you do not reach an agreement to resolve the Dispute within the sixty (60) days, you or Epson may commence an arbitration. Notice to Epson must be addressed to: Epson America, Inc., ATTN: Legal Department, 3840 Kilroy Airport Way, Long Beach, CA 90806 (the "Epson Address"). The Dispute Notice to you will be sent to the most recent address Epson has in its records for you. For this reason, it is important to notify us if your address changes by emailing us at [EAILEgal@ea.epson.com](mailto:EAILEgal@ea.epson.com) or writing us at the Epson Address above. Notice of the Dispute shall include the sender's name, address and contact information, the facts giving rise to the Dispute, and the relief requested (the "Dispute Notice"). Following receipt of the Dispute Notice, Epson and you agree to act in good faith to resolve the Dispute before commencing arbitration.

1.4 **Small Claims Court.** Notwithstanding the foregoing, you may bring an individual action in the small claims court of your state or municipality if the action is within that court's jurisdiction and is pending only in that court.

**1.5 WAIVER OF CLASS ACTIONS AND CLASS ARBITRATIONS. YOU AND EPSON AGREE THAT EACH PARTY MAY BRING DISPUTES AGAINST THE OTHER PARTY ONLY IN AN INDIVIDUAL CAPACITY, AND NOT AS A PLAINTIFF OR CLASS MEMBER IN ANY CLASS OR REPRESENTATIVE PROCEEDING, INCLUDING WITHOUT LIMITATION FEDERAL OR STATE CLASS ACTIONS, OR CLASS ARBITRATIONS. CLASS ACTION LAWSUITS, CLASS-WIDE ARBITRATIONS, PRIVATE ATTORNEY-GENERAL ACTIONS, AND ANY OTHER PROCEEDING WHERE SOMEONE ACTS IN A REPRESENTATIVE CAPACITY ARE NOT ALLOWED. ACCORDINGLY, UNDER THE ARBITRATION PROCEDURES OUTLINED IN THIS SECTION, AN ARBITRATOR SHALL NOT COMBINE OR CONSOLIDATE MORE THAN ONE PARTY'S CLAIMS WITHOUT THE WRITTEN CONSENT OF ALL AFFECTED PARTIES TO AN ARBITRATION PROCEEDING.**

**1.6 Arbitration Procedure.** If you or Epson commences arbitration, the arbitration shall be governed by the rules of JAMS that are in effect when the arbitration is filed, excluding any rules that permit arbitration on a class or representative basis (the "JAMS Rules"), available at <http://www.jamsadr.com> or by calling 1-800-352-5267, and under the rules set forth in this Agreement. All Disputes shall be resolved by a single neutral arbitrator, and both parties shall have a reasonable opportunity to participate in the selection of the arbitrator. The arbitrator is bound by the terms of this Agreement. The arbitrator, and not any federal, state or local court or agency, shall have exclusive authority to resolve all disputes arising out of or relating to the interpretation, applicability, enforceability or formation of this Agreement, including any claim that all or any part of this Agreement is void or voidable. Notwithstanding this broad delegation of authority to the arbitrator, a court may determine the limited question of whether a claim or cause of action is for an IP Claim, which is excluded from the definition of "Disputes" in Section 1.1 above. The arbitrator shall be empowered to grant whatever relief would be available in a court under law or in equity. The arbitrator may award you the same damages as a court could, and may award declaratory or injunctive relief only in favor of the individual party seeking relief and only to the extent necessary to provide relief warranted by that party's individual claim. In some instances, the costs of arbitration can exceed the costs of litigation and the right to discovery may be more limited in arbitration than in court. The arbitrator's award is binding and may be entered as a judgment in any court of competent jurisdiction.

You may choose to engage in arbitration hearings by telephone. Arbitration hearings not conducted by telephone shall take place in a location reasonably accessible from your primary residence, or in Orange County, California, at your option.

a) Initiation of Arbitration Proceeding. If either you or Epson decides to arbitrate a Dispute, both parties agree to the following procedure:

(i) Write a Demand for Arbitration. The demand must include a description of the Dispute and the amount of damages sought to be recovered. You can find a copy of a Demand for Arbitration at <http://www.jamsadr.com> ("Demand for Arbitration").

(ii) Send three copies of the Demand for Arbitration, plus the appropriate filing fee, to: JAMS, 500 North State College Blvd., Suite 600 Orange, CA 92868, U.S.A.



(iii) Send one copy of the Demand for Arbitration to the other party (same address as the Dispute Notice), or as otherwise agreed by the parties.

b) Hearing Format. During the arbitration, the amount of any settlement offer made shall not be disclosed to the arbitrator until after the arbitrator determines the amount, if any, to which you or Epson is entitled. The discovery or exchange of non-privileged information relevant to the Dispute may be allowed during the arbitration.

c) Arbitration Fees. Epson shall pay, or (if applicable) reimburse you for, all JAMS filings and arbitrator fees for any arbitration commenced (by you or Epson) pursuant to provisions of this Agreement.

d) Award in Your Favor. For Disputes in which you or Epson seeks \$75,000 or less in damages exclusive of attorney's fees and costs, if the arbitrator's decision results in an award to you in an amount greater than Epson's last written offer, if any, to settle the Dispute, Epson will: (i) pay you \$1,000 or the amount of the award, whichever is greater; (ii) pay you twice the amount of your reasonable attorney's fees, if any; and (iii) reimburse you for any expenses (including expert witness fees and costs) that your attorney reasonably accrues for investigating, preparing, and pursuing the Dispute in arbitration. Except as agreed upon by you and Epson in writing, the arbitrator shall determine the amount of fees, costs, and expenses to be paid by Epson pursuant to this Section 1.6d).

e) Attorney's Fees. Epson will not seek its attorney's fees and expenses for any arbitration commenced involving a Dispute under this Agreement. Your right to attorney's fees and expenses under Section 1.6d) above does not limit your rights to attorney's fees and expenses under applicable law; notwithstanding the foregoing, the arbitrator may not award duplicative awards of attorney's fees and expenses.

**1.7 Opt-out. You may elect to opt-out (exclude yourself) from the final, binding, individual arbitration procedure and waiver of class and representative proceedings specified in this Agreement by sending a written letter to the Epson Address within thirty (30) days of your assent to this Agreement (including without limitation the purchase, download, installation of the Software or other applicable use of Epson Hardware, products and services) that specifies (i) your name, (ii) your mailing address, and (iii) your request to be excluded from the final, binding individual arbitration procedure and waiver of class and representative proceedings specified in this Section 1. In the event that you opt-out consistent with the procedure set forth above, all other terms shall continue to apply, including the requirement to provide notice prior to litigation.**

**1.8 Amendments to Section 1.** Notwithstanding any provision in this Agreement to the contrary, you and Epson agree that if Epson makes any future amendments to the dispute resolution procedure and class action waiver provisions (other than a change to Epson's address) in this Agreement, Epson will obtain your affirmative assent to the applicable amendment. If you do not affirmatively assent to the applicable amendment, you are agreeing that you will arbitrate any Dispute between the parties in accordance with the language of this Section 1 (or resolve disputes as provided for in Section 1.7, if you timely elected to opt-out when you first assented to this Agreement).

**1.9 Severability.** If any provision in this Section 1 is found to be unenforceable, that provision shall be severed with the remainder of this Agreement remaining in full force and effect. **The foregoing shall not apply to the prohibition against class or representative actions as provided in Section 1.5. This means that if Section 1.5 is found to be unenforceable, the entire Section 1 (but only Section 1) shall be null and void.**

Parent topic: [Notices](#)

## Trademarks

EPSON®, EasyMP®, Instant Off®, PowerLite®, and Quick Corner® are registered trademarks, and EPSON Exceed Your Vision is a registered logomark of Seiko Epson Corporation.

PrivateLine® is a registered trademark and Epson Store<sup>SM</sup> and Extra Care<sup>SM</sup> are service marks of Epson America, Inc.

Mac and OS X are trademarks of Apple Inc., registered in the U.S. and other countries. macOS is a trademark of Apple Inc.

HDMI and High-Definition Multimedia Interface are the trademarks or registered trademarks of HDMI Licensing LLC.  HIGH DEFINITION MULTIMEDIA INTERFACE

General Notice: Other product names used herein are for identification purposes only and may be trademarks of their respective owners. Epson disclaims any and all rights in those marks.



Parent topic: [Notices](#)

## Copyright Notice

All rights reserved. No part of this publication may be reproduced, stored in a retrieval system, or transmitted in any form or by any means, electronic, mechanical, photocopying, recording, or otherwise, without the prior written permission of Seiko Epson Corporation. The information contained herein is designed only for use with this Epson product. Epson is not responsible for any use of this information as applied to other products.

Neither Seiko Epson Corporation nor its affiliates shall be liable to the purchaser of this product or third parties for damages, losses, costs, or expenses incurred by purchaser or third parties as a result of: accident, misuse, or abuse of this product or unauthorized modifications, repairs, or alterations to this

product, or (excluding the U.S.) failure to strictly comply with Seiko Epson Corporation's operating and maintenance instructions.

Seiko Epson Corporation shall not be liable for any damages or problems arising from the use of any options or any consumable products other than those designated as Original Epson Products or Epson Approved Products by Seiko Epson Corporation.

This information is subject to change without notice.

[A Note Concerning Responsible Use of Copyrighted Materials](#)  
[Copyright Attribution](#)

**Parent topic:** [Notices](#)

## **A Note Concerning Responsible Use of Copyrighted Materials**

Epson encourages each user to be responsible and respectful of the copyright laws when using any Epson product. While some countries' laws permit limited copying or reuse of copyrighted material in certain circumstances, those circumstances may not be as broad as some people assume. Contact your legal advisor for any questions regarding copyright law.

**Parent topic:** [Copyright Notice](#)

## **Copyright Attribution**

© 2016 Epson America, Inc.

11/16

CPD-50663

**Parent topic:** [Copyright Notice](#)