

> VP2776

Display User Guide

IMPORTANT: Please read this User Guide to obtain important information on installing and using your product in a safe manner, as well as registering your product for future service. Warranty information contained in this User Guide will describe your limited coverage from ViewSonic® Corporation, which is also found on our web site at <http://www.viewsonic.com> in English, or in specific languages using the Regional selection box in the upper right corner of our website.

Model No. VS18610
P/N: VP2776

Thank you for choosing ViewSonic®

As a world-leading provider of visual solutions, ViewSonic® is dedicated to exceeding the world's expectations for technological evolution, innovation, and simplicity. At ViewSonic®, we believe that our products have the potential to make a positive impact in the world, and we are confident that the ViewSonic® product you have chosen will serve you well.

Once again, thank you for choosing ViewSonic®!

> Safety Precautions

Please read the following **Safety Precautions** before you start using the device.

- Keep this user guide in a safe place for later reference.
- Read all warnings and follow all instructions.
- Sit at least 18" (45 cm) away from the device.
- Allow at least 4" (10 cm) clearance around the device to ensure proper ventilation.
- Place the device in a well-ventilated area. Do not place anything on the device that prevents heat dissipation.
- Do not use the device near water. To reduce the risk of fire or electric shock, do not expose the device to moisture.
- Avoid exposing the device to direct sunlight or other sources of sustained heat.
- Do not install near any heat sources such as radiators, heat registers, stoves, or other devices (including amplifiers) that may increase the temperature of the device to dangerous levels.
- Use a soft, dry cloth to clean the external housing. For more information, refer to the "Maintenance" section of this manual.
- Avoid touching the screen, as oil may collect on the screen if you touch it.
- Do not touch the screen surface with sharp or hard objects, as it may cause damage to the screen.
- Do not place the device on cloth or other materials that may be placed between the product and supporting furniture.
- When moving the device, be careful not to drop or bump the device on anything.
- Do not place the device on an uneven or unstable surface. The device may fall over resulting in an injury or a malfunction.
- Do not place any heavy objects on the device or connection cables.
- Always use cabinets, stands, or installation methods recommended by the manufacturer of the device set.
- Always use furniture that can safely support the device.
- Always ensure the device is not overhanging the edge of the supporting furniture.
- Do not place the device on tall furniture, such as cupboards or bookcases, without anchoring both the furniture and the device to a suitable support.
- Always educate children about the dangers of climbing on furniture to reach the device or related equipment.

- Do not place the monitor where children are likely to be present.
- Do not place items that might tempt children to climb, such as toys and remote controls, on the top of the device or furniture on which the product is placed.
- If smoke, an abnormal noise, or a strange odor is present, immediately turn the device off and call your dealer or ViewSonic®. It is dangerous to continue using the device.
- Do not attempt to circumvent the safety provisions of the polarized or grounding-type plug. A polarized plug has two blades with one wider than the other. A grounding-type plug has two blades and a third grounding prong. The wide blade and the third prong are provided for your safety. If the plug does not fit into your outlet, obtain an adapter and do not attempt to force the plug into the outlet.
- When connecting to a power outlet, Do not remove the grounding prong. Please ensure grounding prongs are never removed.
- Always route and manage cords and cables connected to your device so they cannot be tripped over, pulled, or grabbed.
- Protect the power cord from being treaded upon or pinched, particularly at the plug, and at the point where it emerges from the equipment. Ensure that the power outlet is located near the equipment so that it is easily accessible.
- Disconnect the power plug from the power outlet if the device is not being used for a long period of time.
- Please confirm the distribution system installed in the building. The system should provide a circuit breaker rated at 120/240V, 20A.
- Only use attachments/accessories, such as carts, stands, tripods, brackets or tables, specified by the manufacturer.
- When a cart is used, use with caution when moving the cart/equipment combination to avoid injury from tipping over.
- Refer all servicing to qualified service personnel. Service will be required when the unit has been damaged in any way, such as:
 - » if the power-supply cord or plug is damaged.
 - » if liquid is spilled onto or objects fall into the unit.
 - » if the unit is exposed to rain or moisture.
 - » if the unit does not operate normally or has been dropped.
- When using ear-/headphones, adjust the volume to appropriate levels, or hearing damage may result.



- Fastening the display to a wall or fixed object using cordage or other restraining devices can help support the weight of the display in order to prevent the display from falling over.

Hole pattern (W x H)	Interface Pad (W x H x D)	Pad Hole	Screw Specification & Quantity
100 x 100 mm	115 x 115 x 2.6 mm	Ø 5 mm	M4 x 10 mm 4 pieces

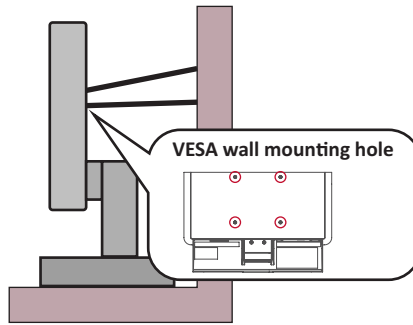

NOTE:

- Restraining device/cordage should be able to withstand 100N force.
- Make sure the cordage is straightened, and any slack is removed. The back of the device shall face the wall to ensure the device cannot tilt under external force.
- Make sure the display does not tilt under external force at any height and rotation angle of the device.
- If the existing display is going to be retained and relocated, the same considerations as above should be applied.

> Contents

Safety Precautions	3
Introduction	8
Package Contents	8
Product Overview	9
Initial Setup	10
Installing the Stand	10
Wall Mounting.....	12
Using the Security Slot.....	14
Making Connections	15
Connecting to Power	15
Connecting External Devices	16
HDMI Connection	16
DisplayPort Connection.....	17
USB Connection.....	18
Audio Connection.....	19
Using the Monitor	20
Adjusting the Viewing Angle.....	20
Height Adjustment	20
Tilt Angle Adjustment.....	21
Screen Orientation Adjustment (Monitor Pivot).....	21
Swivel Angle Adjustment.....	23
Turning the Device On/Off	24
Using the Joy Key.....	25
Startup Menu	25
Hot Keys	28
Configuring the Settings	30
General Operations	30
On-Screen Display (OSD) Menu Tree	32
Menu Options	41

Advanced Features and Settings	48
HDR (High-Dynamic-Range)	48
KVM	49
Auto Pivot	51
Colorbration+	52
Dual Color	53
Multi-Picture.....	54
PBP (Picture-by-Picture)	55
PIP (Picture-in-Picture)	56
Backstage Lighting	57
Firmware Update.....	58
Appendix.....	59
Specifications.....	59
Glossary	61
Troubleshooting	66
Maintenance.....	68
General Precautions.....	68
Cleaning the Screen.....	68
Cleaning the Case	68
Regulatory and Service Information	69
Compliance Information.....	69
FCC Compliance Statement.....	69
Industry Canada Statement.....	69
CE Conformity for European Countries	69
Declaration of RoHS2 Compliance.....	70
Indian Restriction of Hazardous Substances	71
Product Disposal at End of Product Life	71
Copyright Information	72
Customer Service	73
Limited Warranty	74
Mexico Limited Warranty.....	77

> Introduction

Package Contents

- Monitor
- Power cord
- Video cable
- Quick start guide

NOTE: The power cord and video cables included in your package may vary depending on your country. Please contact your local reseller for more information.

Product Overview

Front View

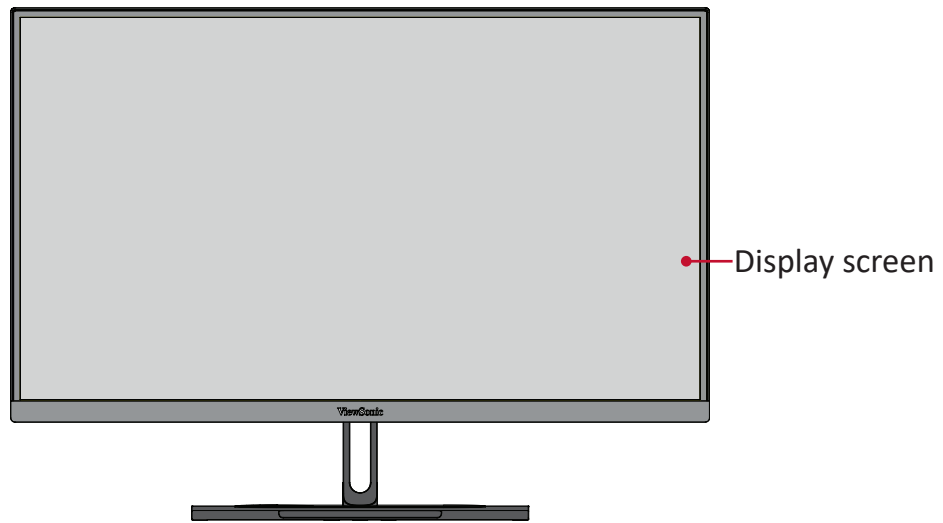

Rear View

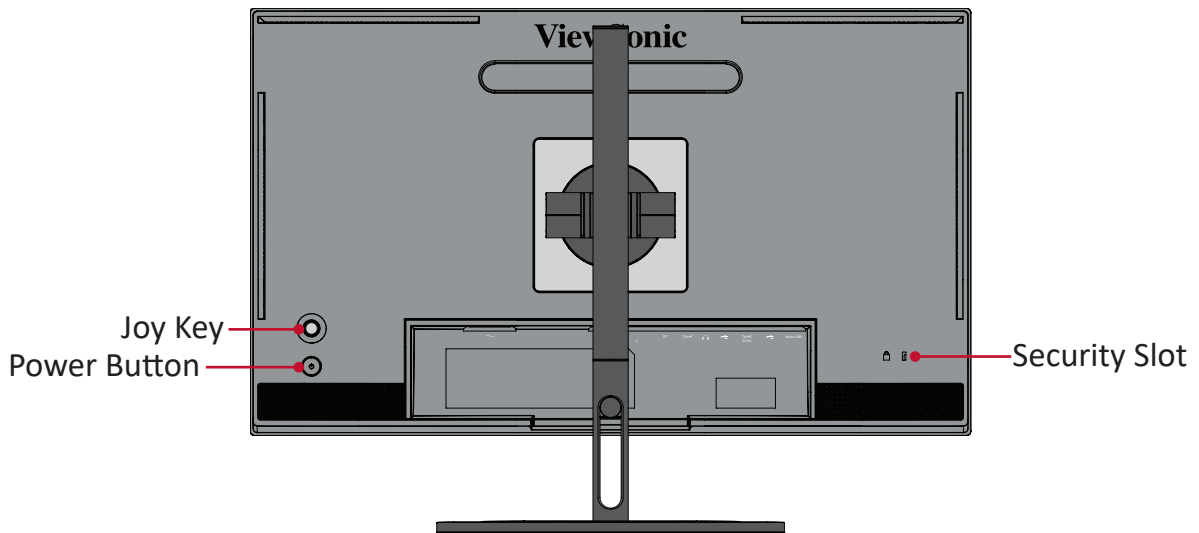

I/O Ports

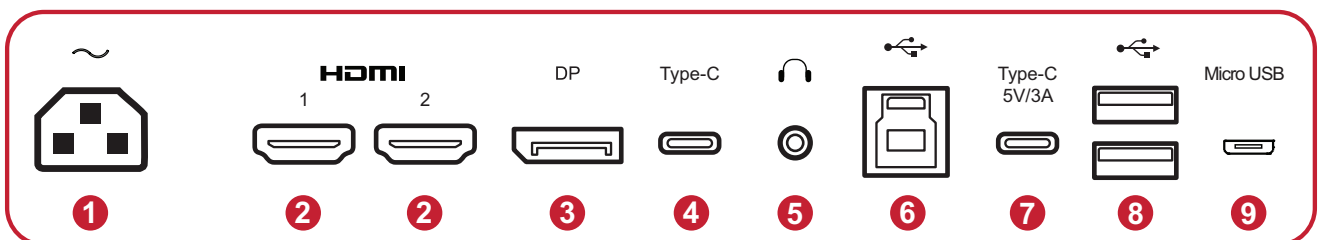

1. AC IN
2. HDMI
3. DisplayPort
4. USB Type-C
5. Audio Out
6. USB Upstream
7. USB Type-C 5V/3A
8. USB Downstream
9. Micro USB

NOTE: For more information about the **Joy Key** and its functions, refer to “Hot Keys”.

> Initial Setup

This section provides detailed instructions for setting up your monitor.

Installing the Stand

1. Place the monitor on a flat, stable surface with the screen facing down.
2. Align and slide the upper hooks of the monitor stand into the stand mounting slots.

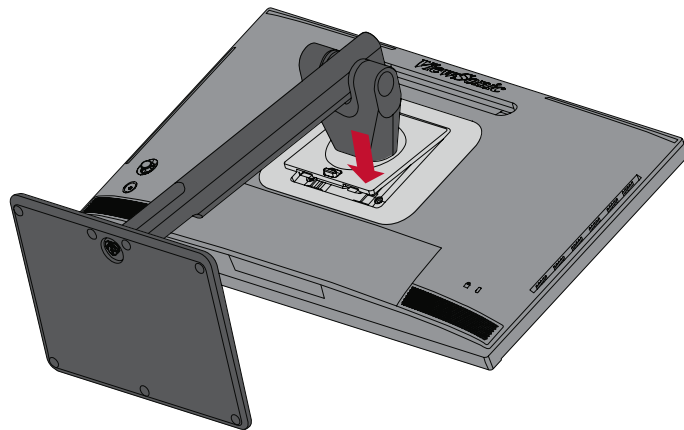
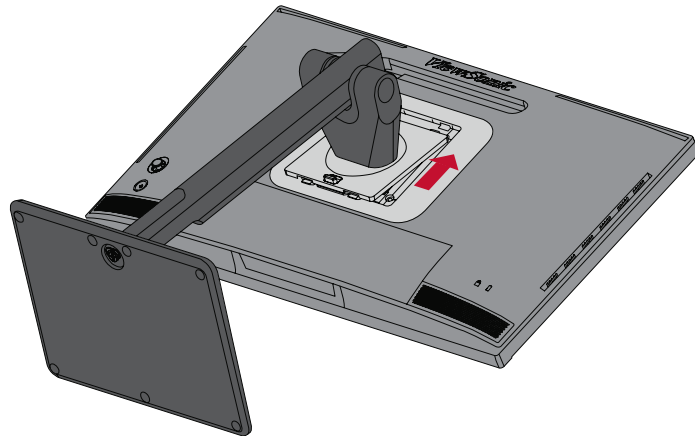

3. Lift the device into its upright position on a flat, stable surface.

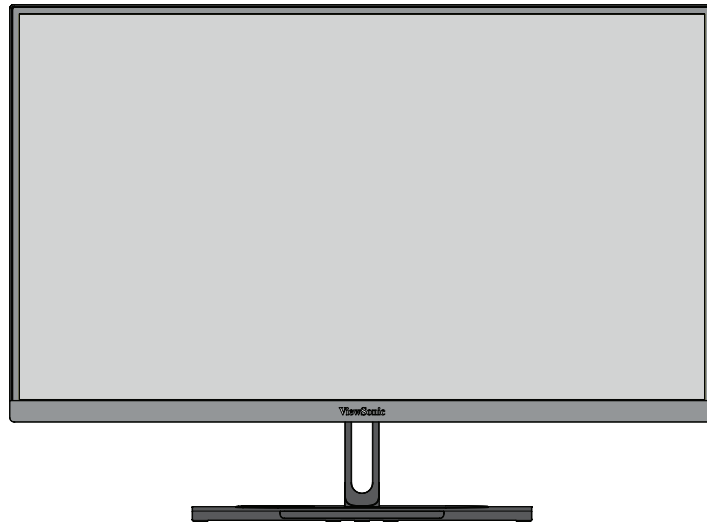

NOTE: Always place the device on a flat, stable surface. Failure to do so may cause the device to fall and damage the device and/or result in personal injury.

Wall Mounting

Refer to the table below for the standard dimensions for wall mount kits.

NOTE: For use only with a UL certified wall mount kit/bracket. To obtain a wall-mounting kit or height adjustment base, contact ViewSonic® or your local dealer.

Maximum Loading	Hole pattern (W x H)	Interface Pad (W x H x D)	Pad Hole	Screw Specification & Quantity
14 kg	100 x 100 mm	115 x 115 x 2.6 mm	Ø 5 mm	M4 x 10 mm 4 pieces

NOTE: Wall mount kits are sold separately.

1. Turn off the device and disconnect all cables.
2. Place the device on a flat, stable surface with the screen facing down.
3. Push and hold the quick release tab and carefully lift the stand.

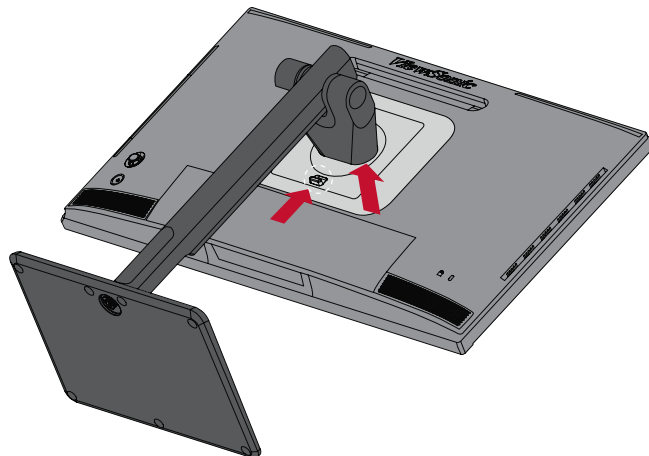

4. Pull down slightly to disengage the hooks and remove the stand.

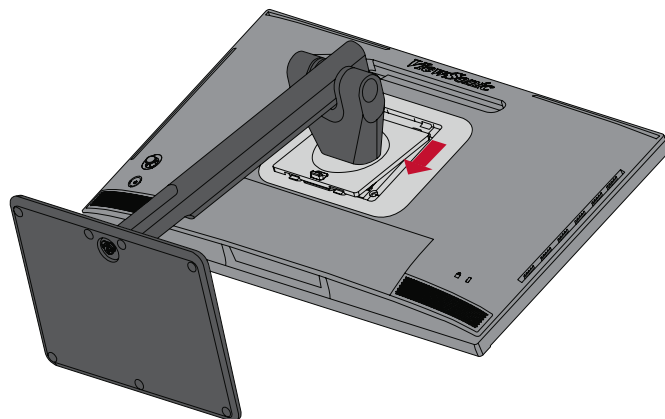

5. Attach the mounting bracket to the VESA mounting holes at the rear of the monitor. Then secure it with four (4) screws (M4 x 10 mm).

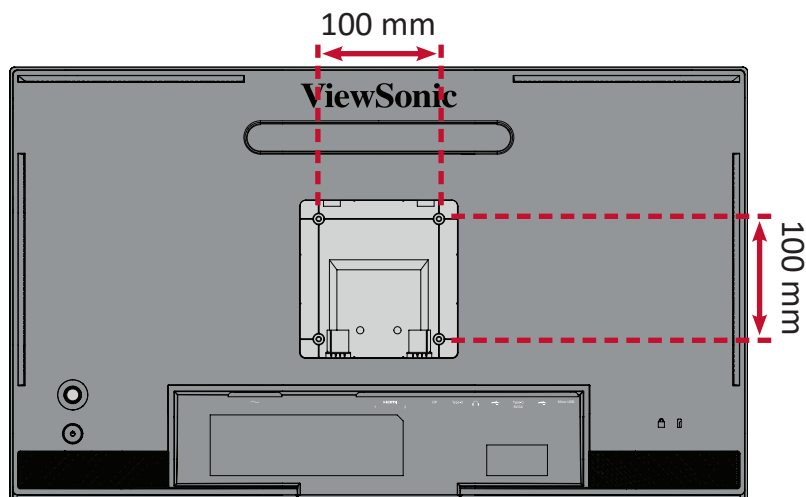

6. Follow the instructions that come with the wall mounting kit to mount the monitor onto the wall.

Using the Security Slot

To help prevent the device from being stolen, use a security slot locking device to secure the device to a fixed object.

Additionally, fastening the monitor to a wall or fixed object using a security cable can help support the weight of the monitor in order to prevent the monitor from falling over.

Below is an example of setting up a security slot locking device on a table.

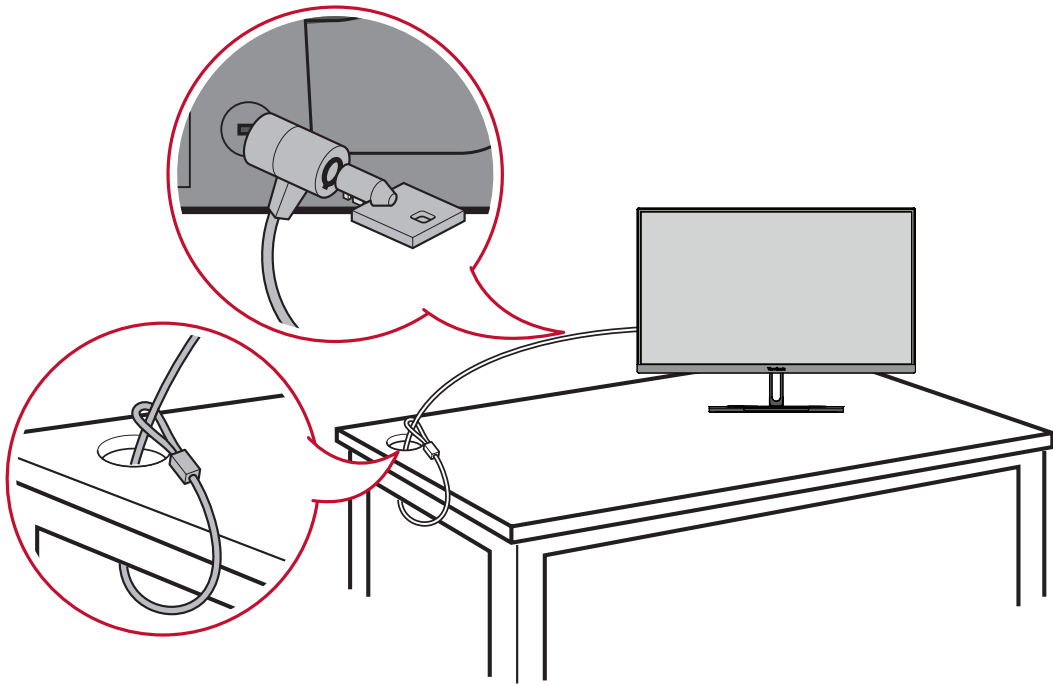

> Making Connections

This section guides you on how to connect the monitor with other equipment.

Connecting to Power

1. Connect the power cord to the AC IN jack at the rear of the device.
2. Connect the power cord plug to a power outlet.

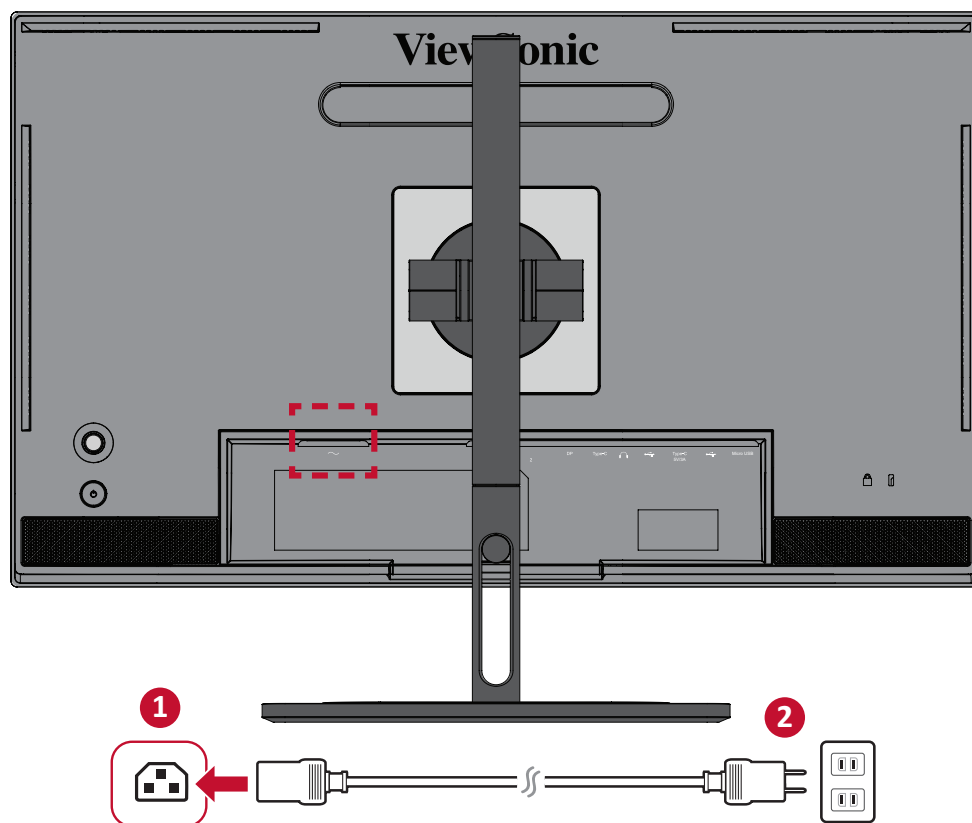

Connecting External Devices

HDMI Connection

Connect one end of an HDMI cable to the HDMI port of your monitor. Then connect the other end of the cable to the HDMI port of your computer.

NOTE: The monitor is equipped with two HDMI 2.0 ports.

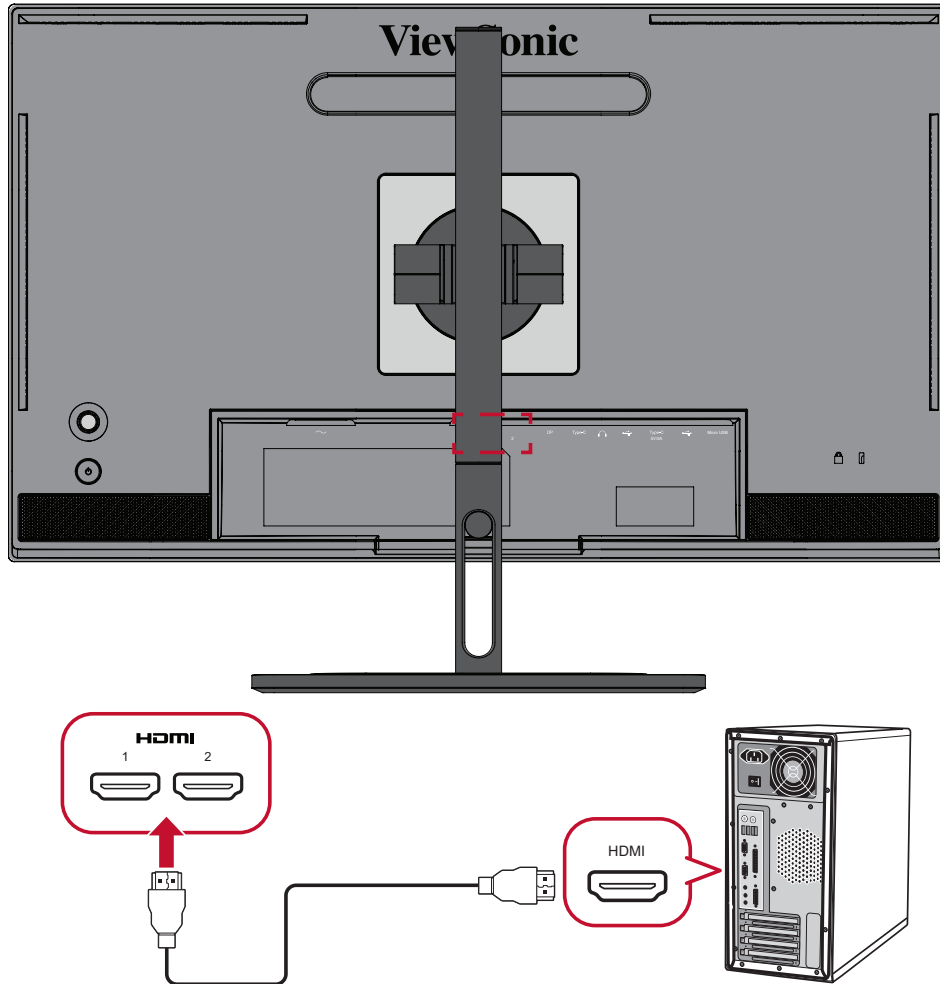

DisplayPort Connection

Connect one end of a DisplayPort cable to the DisplayPort port. Then connect the other end of the cable to the DisplayPort or mini DP port of your computer.

NOTE: To connect the monitor to the Thunderbolt port (v. 1&2) on your Mac, connect the mini DP end of the “mini DP to DisplayPort cable” to the Thunderbolt output of your Mac. Then connect the other end of the cable to the DisplayPort port of the monitor.

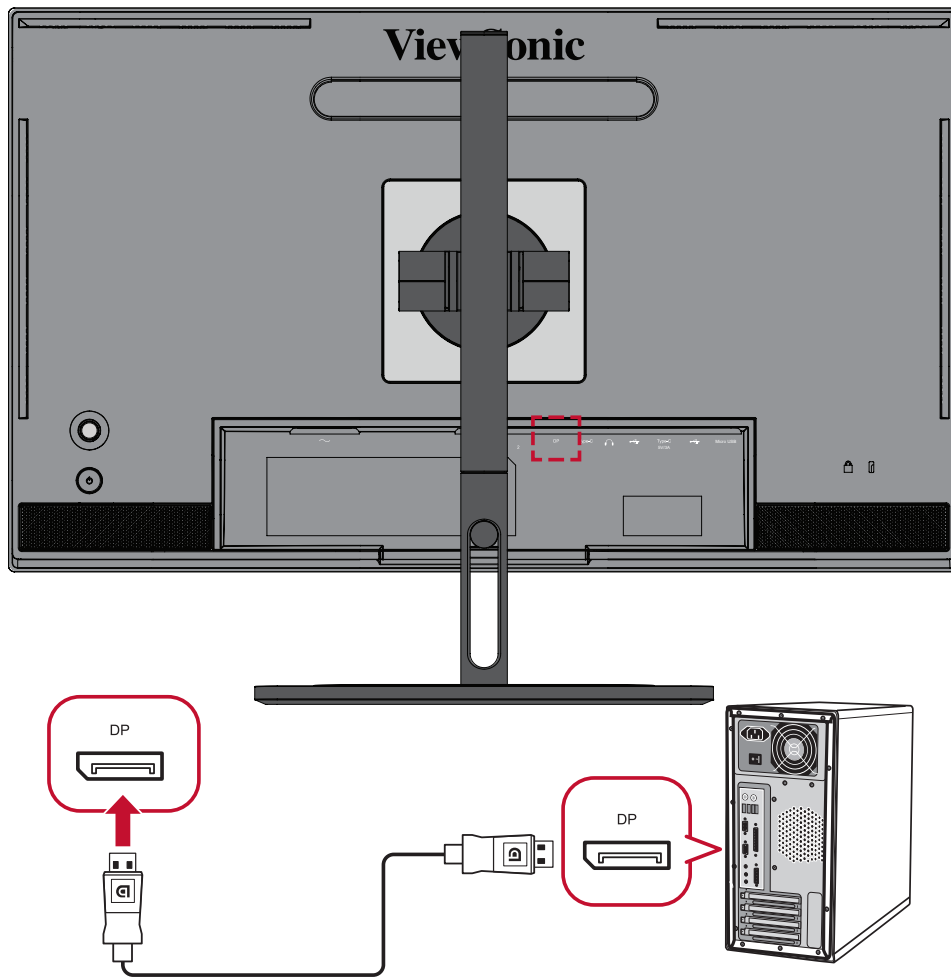

USB Connection

Connect one end of a USB cable to a USB port of the monitor. Then connect the other end of the cable to a USB port of your computer.

NOTE: The monitor supports four (4) types of USB ports. When making the connection(s), observe the following guidelines:

- Two (2) USB Type A ports: Connection for your Type A peripheral device(s) (i.e. storage device, keyboard, mouse).
 - » **NOTE:** To use some peripherals, please ensure your computer is also connected to the monitor's USB Type B port.
- One (1) USB Type B port: Connect the USB Type B male cable (square with 2 cut corners) to this port, and then connect the other end of the cable to the USB downstream port of your computer.
- Two (2) USB Type C ports: Make sure your Type-C output device and cable support video signal transmission.
 - » **NOTE:** Only the **Type-C** port supports video transmission; the **Type-C 5V/3A** port only supports power delivery and data transmission.
- One (1) Micro USB port:

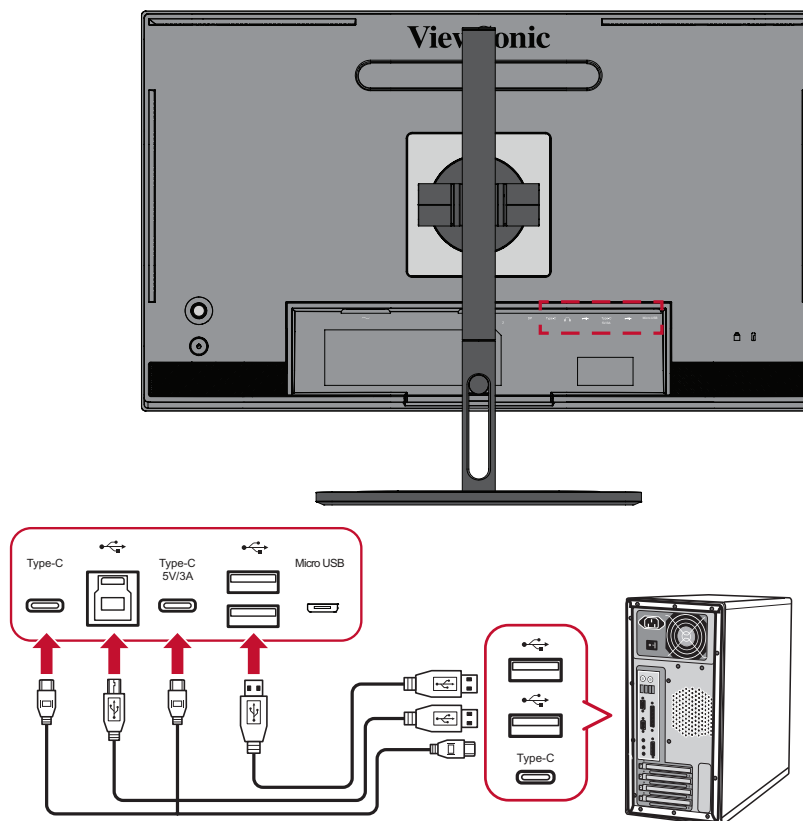

NOTE: It is not necessary to connect to all three types of USB ports at the same time. The user's personal usage scenario will determine which, if any, USB ports are used.

Audio Connection

Plug the audio jack of the ear-/headphones into the Audio Out port of the monitor. Additionally, you can connect the monitor to a sound bar using an audio cable.

NOTE: The monitor is also equipped with dual speakers.

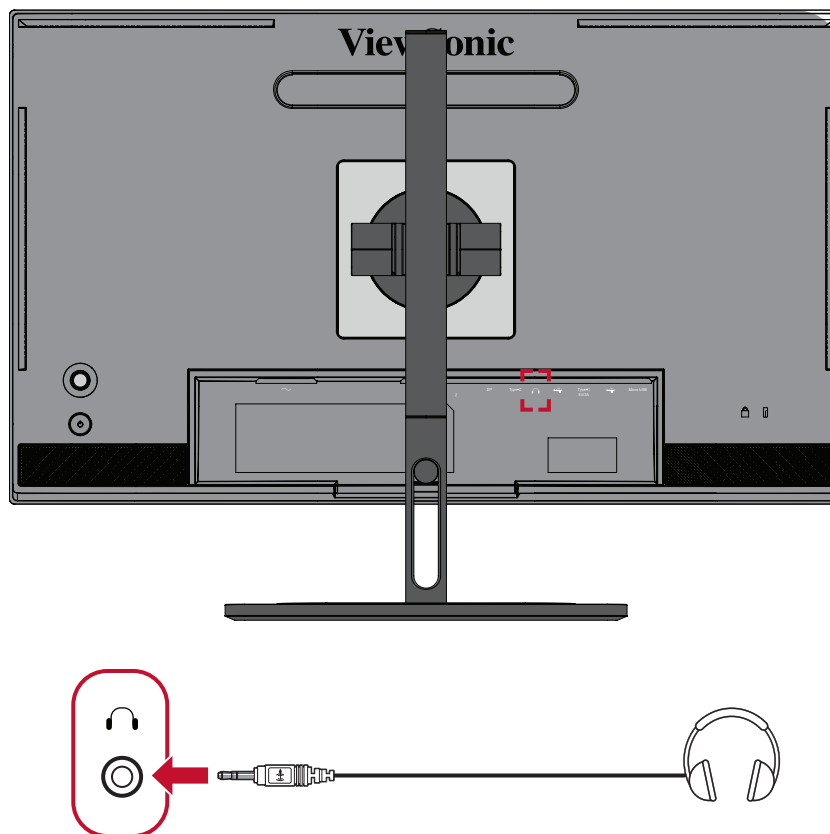

> Using the Monitor

Adjusting the Viewing Angle

For optimal viewing, you can adjust the viewing angle using any of the following methods:

Height Adjustment

Lower or raise the monitor to the desired height (0 to 130 mm).

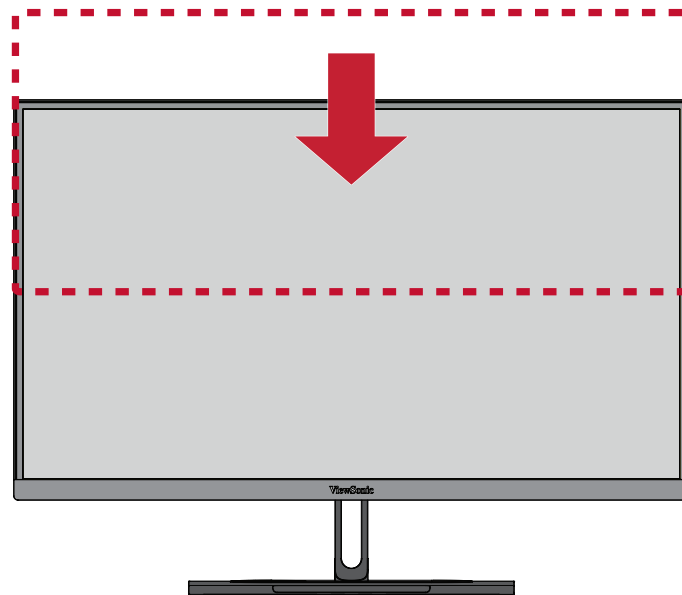

NOTE: When adjusting, press down firmly along the adjustment track holding the monitor with both hands on the side.

Tilt Angle Adjustment

Tilt the monitor forwards or backwards to the desired viewing angle (-5° to 21°).

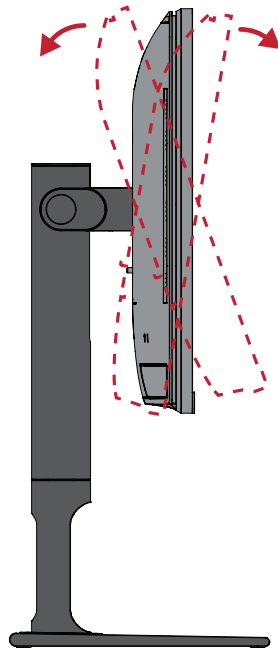

NOTE: When adjusting, support the stand firmly with one hand while tilting the monitor forwards or backwards with the other hand.

Screen Orientation Adjustment (Monitor Pivot)

1. Adjust the monitor height to the highest position. Then tilt the monitor backwards to the full tilt position.

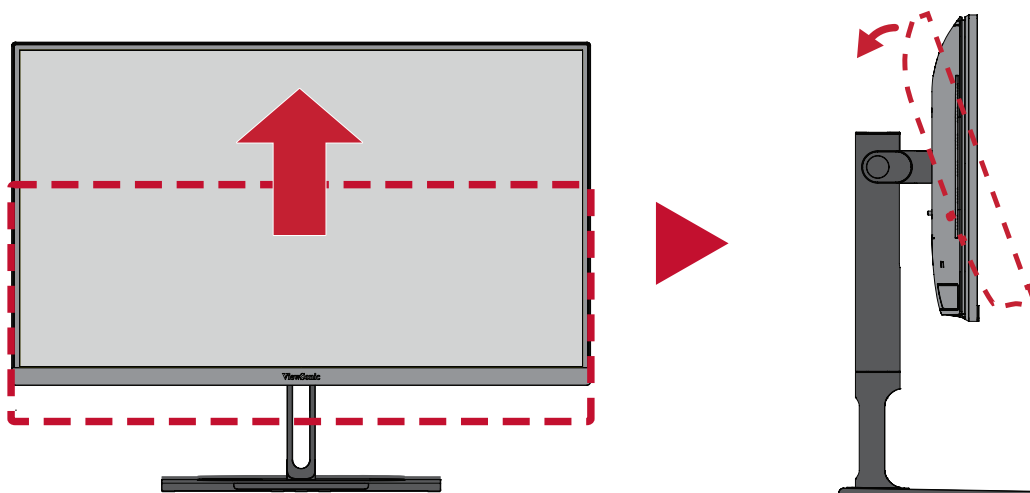

2. Rotate the monitor 90° clockwise or counter clockwise from landscape to portrait orientation.

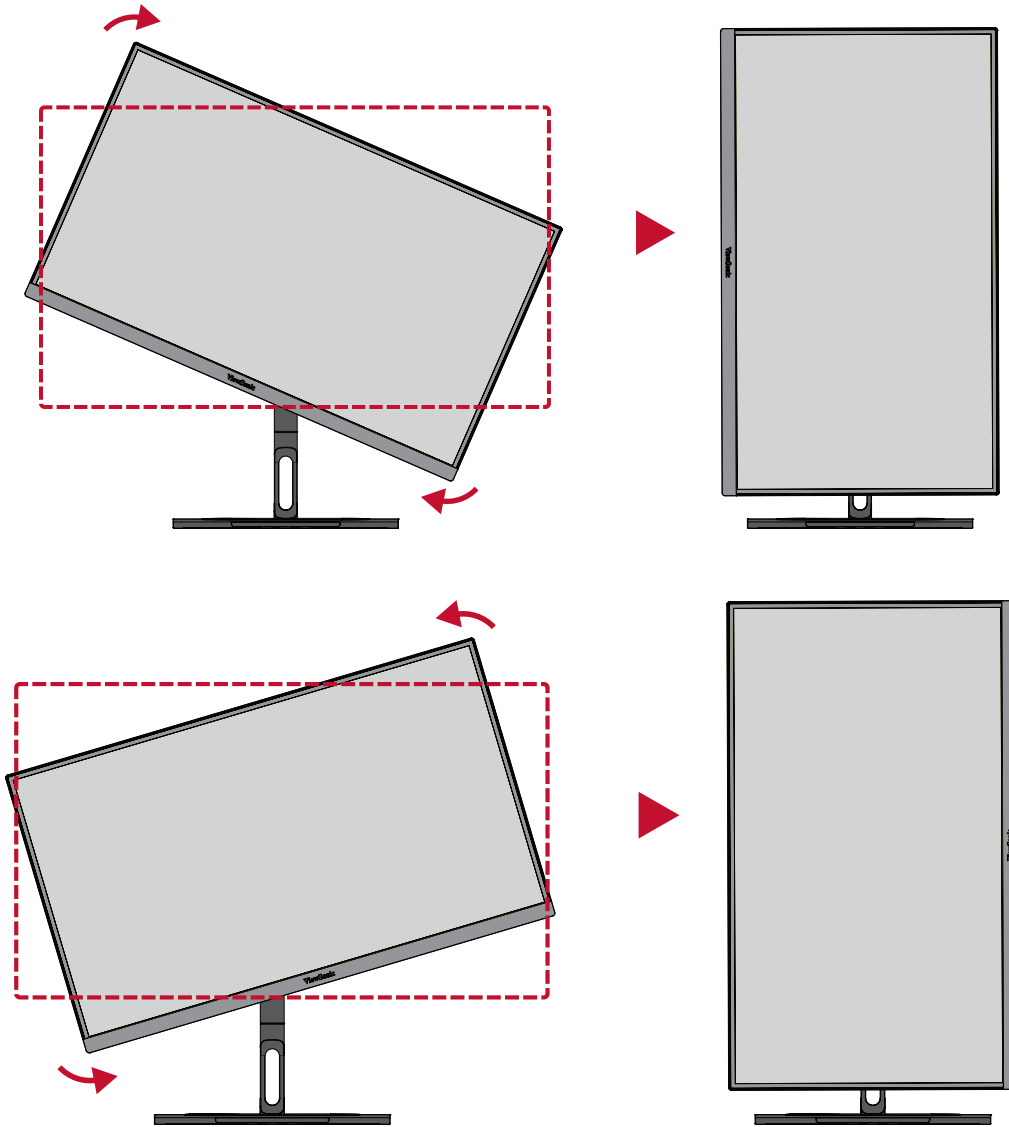

NOTE:

- When adjusting, make sure to hold both sides of your monitor firmly with both hands.
- If using the Auto Pivot function, the system can detect the screen orientation automatically.

Swivel Angle Adjustment

Swivel the monitor to the left or right for the desired viewing angle (60°).

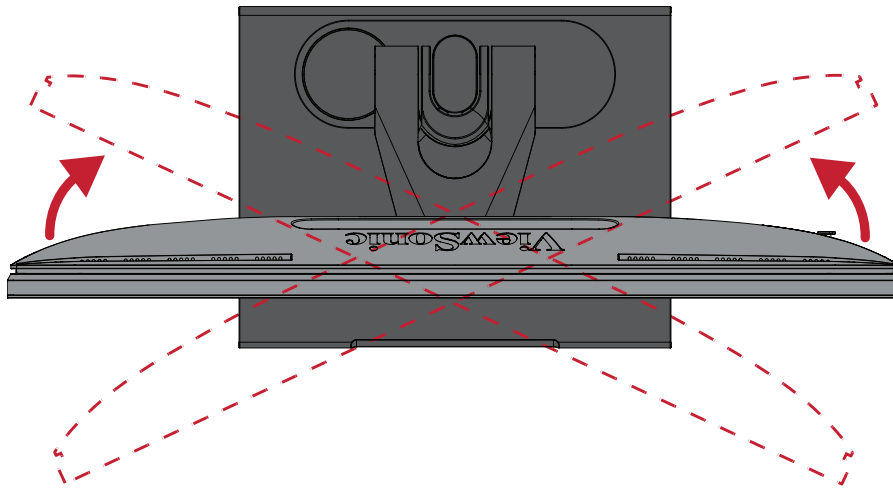

Turning the Device On/Off

1. Plug the power cord into a power outlet.
2. Press the **Power** button to turn on the monitor.
3. To turn the monitor off, press the **Power** button again.

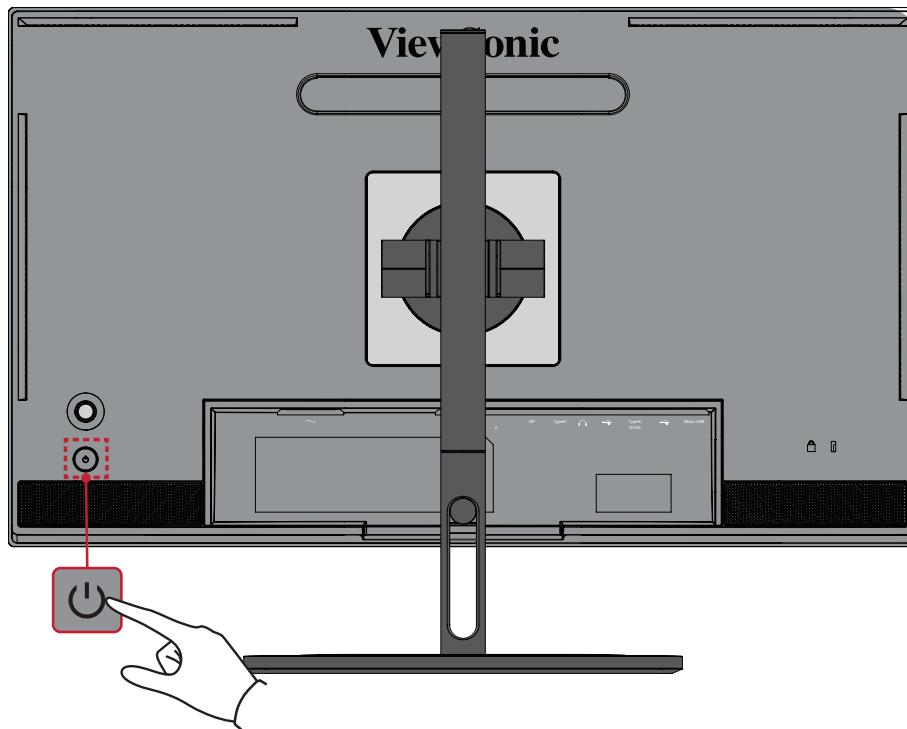

NOTE: The monitor will still consume some power as long as the power cord is connected to the power outlet. If the monitor is not being used for a long period of time, please disconnect the power plug from the power outlet.

Using the Joy Key

Use the Joy Key to access the Startup Menu, activate Hot Keys, navigate the On-Screen Display (OSD) Menu, and change the settings.

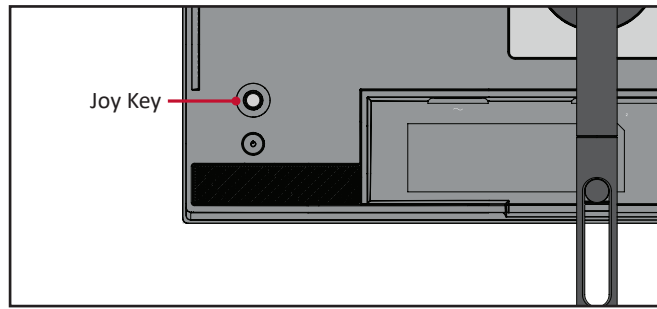

Startup Menu

Move the joy key ◀ to activate the Startup Menu.

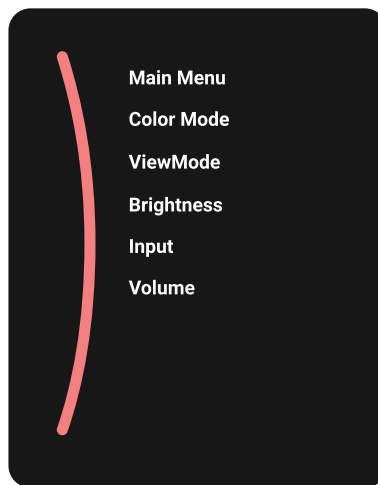

NOTE: Follow the key guide that appears on the screen to select the option or make adjustments.

Main Menu

Enter the On-Screen Display (OSD) Menu.

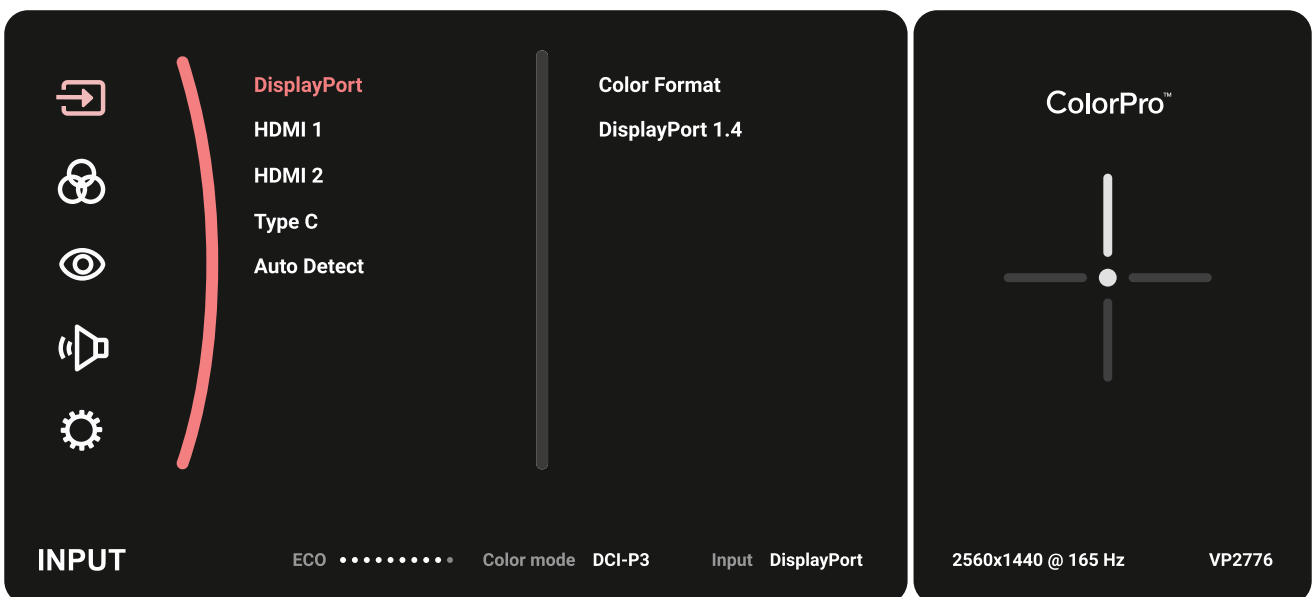

Color Mode

Select one of the preset standard color settings.

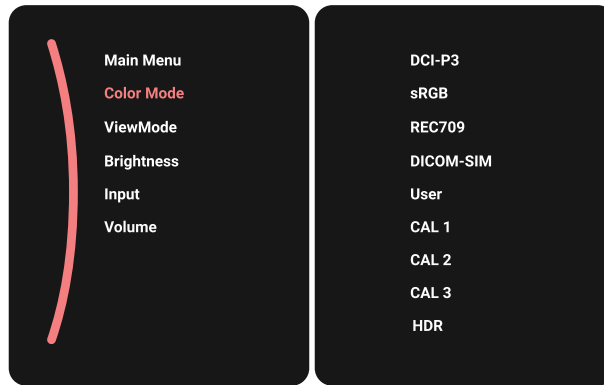

ViewMode

Select one of the preset display settings.

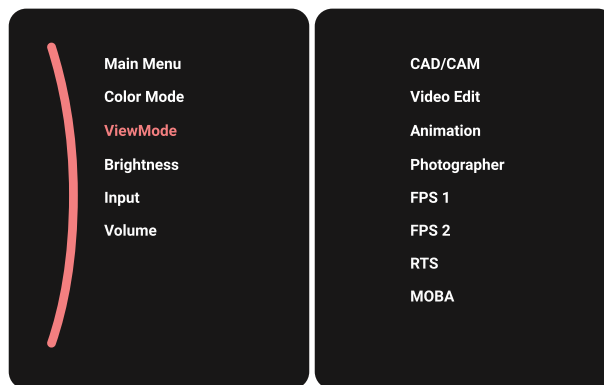

Brightness

Adjust the brightness level.

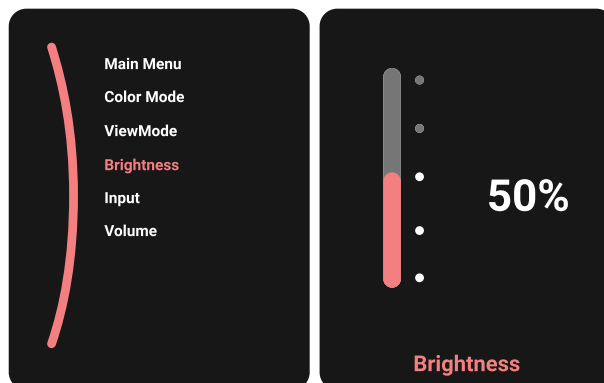

Input

Select the input source.

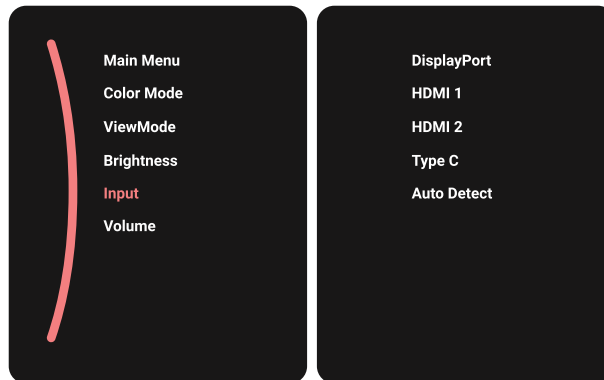

Volume

Adjust the volume settings.

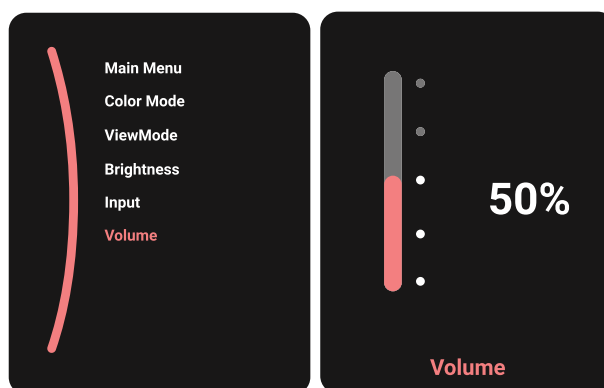

NOTE: Move the joy key ◀ to return to the previous menu.

Hot Keys

When the On-Screen Display (OSD) Menu is off, you can quickly access special functions by using the Joy Key.

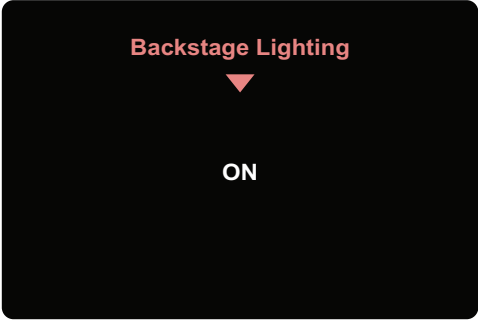
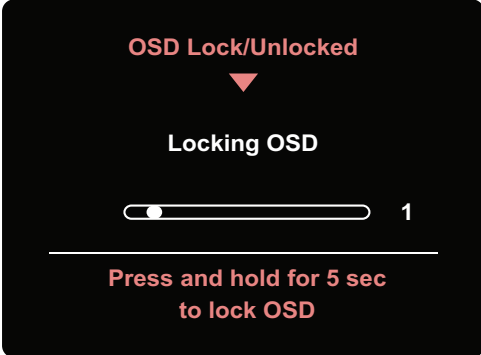
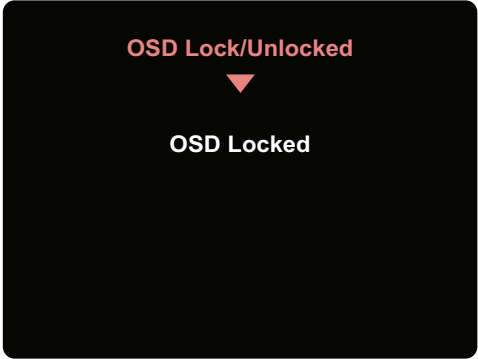
Key	Description
●	<p>Press and hold the key for 5 seconds to activate/deactivate LED lighting.</p>  <p>The image shows a black OSD menu with the text "Backstage Lighting" at the top, a downward-pointing triangle, and the word "ON" in the center.</p>
▼	<p>Press and hold the key to lock/unlock the OSD Menu. When the menu appears on the screen, continue holding both keys for 10 seconds to lock/unlock the OSD Menu.</p>  <p>The image shows a black OSD menu with the text "OSD Lock/Unlocked" at the top, a downward-pointing triangle, "Locking OSD" in the center, a progress bar with a white slider and the number "1" to its right, and the text "Press and hold for 5 sec to lock OSD" at the bottom.</p> <p>If the OSD Menu is locked, the below message will appear on the screen:</p>  <p>The image shows a black OSD menu with the text "OSD Lock/Unlocked" at the top, a downward-pointing triangle, and the text "OSD Locked" in the center.</p>

Key	Description
▲	<p>Press and hold the key to lock/unlock the Power button.</p> <p>When the menu appears on the screen, continue holding both keys for 10 seconds to lock/unlock the Power button.</p> <div data-bbox="655 342 1141 692" data-label="Image"> </div> <p>If the Power button is locked, the below message will appear on the screen:</p> <div data-bbox="655 826 1141 1176" data-label="Image"> </div>
◀	<p>Press and hold the key for 10 seconds to display/hide the boot up screen when the device is turned on.</p> <div data-bbox="667 1299 1133 1635" data-label="Image"> </div>
▶	<p>Press and hold the key for 10 seconds to activate/deactivate Ultra Fast.</p> <div data-bbox="667 1756 1133 2092" data-label="Image"> </div>

Configuring the Settings

General Operations

1. Move the joy key ◀ to display the Startup Menu. Then navigate to **Main Menu** and press the ● key to display the OSD Menu.



2. Move the joy key ▲ or ▼ to select the main menu. Then press the ● key to enter the selected menu.

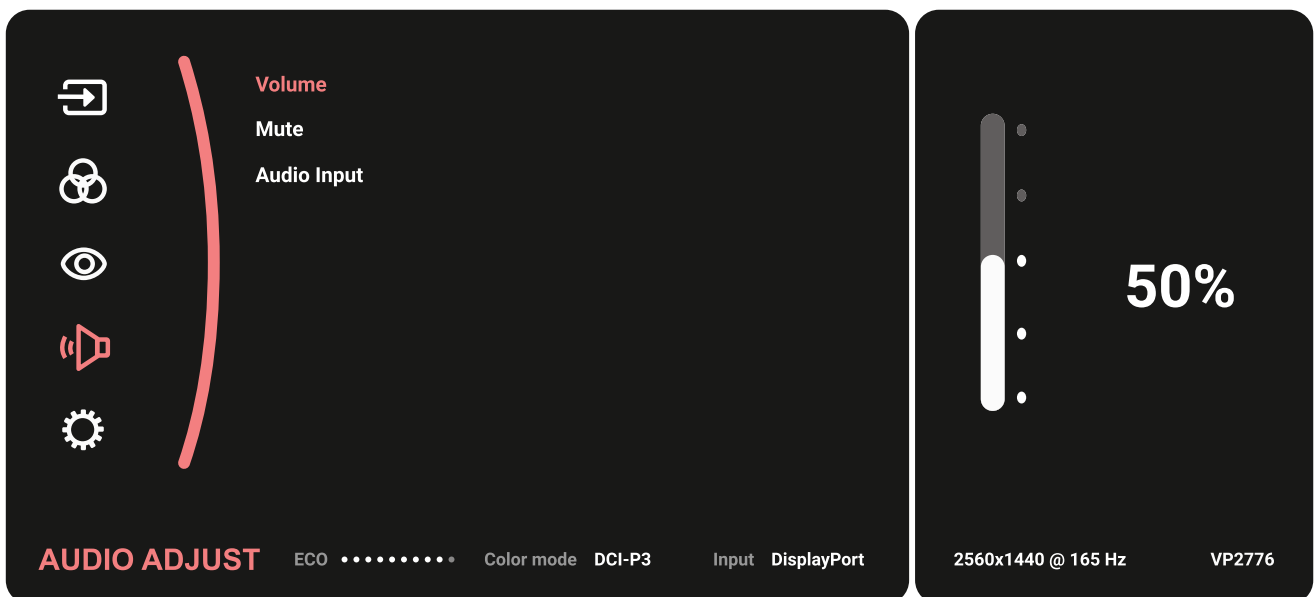

3. Move the joy key ▲ or ▼ to select the desired menu option. Then press the ● key to enter the sub-menu.



4. Move the joy key ▲ or ▼ to adjust/select the setting. Then press the ● key to confirm.



5. Move the joy key ◀ to return to the previous menu.

On-Screen Display (OSD) Menu Tree

Main Menu	Sub-menu	Menu Option	
Input Select	DisplayPort	Color Format	Auto
			RGB (Full Range)
			RGB (Limited Range)
			YUV (Full Range)
			YUV (Limited Range)
		DisplayPort 1.4	On
			Off
	HDMI 1	Color Format	Auto
			RGB (Full Range)
			RGB (Limited Range)
			YUV (Full Range)
			YUV (Limited Range)
		HDMI 2.0	On
			Off
	HDMI 2	Color Format	Auto
			RGB (Full Range)
			RGB (Limited Range)
			YUV (Full Range)
			YUV (Limited Range)
		HDMI 2.0	On
			Off
	Type C	Color Format	Auto
			RGB (Full Range)
			RGB (Limited Range)
			YUV (Full Range)
			YUV (Limited Range)
		USB 3.2	On
			Off
DisplayPort 1.4		On	
		Off	
Auto Detect		On	
	Off		

Main Menu	Sub-menu	Menu Option	
Color Mode	DCI-P3	Brightness	(-/+, 0~100)
		Color Temperature	9300K
			7500K
			6500K
			6300K
			5000K
		Gamma	1
			1.4
			1.8
			2.2
			2.4
			2.6
		Sharpness	(-/+, 0~100)
		Aspect Ratio	1:1
			4:3
	Full Screen		
	Uniformity	On	
		Off	
	Recall		
	sRGB	Brightness	(-/+, 0~100)
		Color Temperature	9300K
			7500K
			6500K
			6300K
			5000K
		Gamma	1
			1.4
			1.8
			2.2
			2.4
2.6			
Sharpness		(-/+, 0~100)	
Aspect Ratio		1:1	
		4:3	
	Full Screen		
Uniformity	On		
	Off		
Recall			

Main Menu	Sub-menu	Menu Option	
Color Mode	REC709	Brightness	(-/+ , 0~100)
		Color Temperature	9300K
			7500K
			6500K
			6300K
			5000K
		Gamma	1
			1.4
			1.8
			2.2
			2.4
			2.6
		Sharpness	(-/+ , 0~100)
		Aspect Ratio	1:1
	4:3		
	Full Screen		
	Uniformity	On	
		Off	
	Recall		
	DICOM-SIM	Sharpness	(-/+ , 0~100)
Aspect Ratio		1:1	
		4:3	
		Full Screen	
Recall			

Main Menu	Sub-menu	Menu Option		
Color Mode	User	Contrast	(-/+ , 0~100)	
		Brightness	(-/+ , 0~100)	
		Color Temperature	9300K	
			7500K	
			6500K	
			6300K	
			5000K	
		Gamma	1	
			1.4	
			1.8	
			2.2	
			2.4	
			2.6	
		Advanced DCR	(-/+ , 0/25/50/75/100)	
		Gain	Red	(-/+ , 0~100)
			Green	(-/+ , 0~100)
			Blue	(-/+ , 0~100)
		Offset	Red	(-/+ , 0~100)
			Green	(-/+ , 0~100)
			Blue	(-/+ , 0~100)
		Hue	Red	(-/+ , 0~100)
			Green	(-/+ , 0~100)
			Blue	(-/+ , 0~100)
			Cyan	(-/+ , 0~100)
			Magenta	(-/+ , 0~100)
			Yellow	(-/+ , 0~100)
		Sharpness	(-/+ , 0~100)	
		Aspect Ratio	1:1	
			4:3	
			Full Screen	
Blue Light Filter	(-/+ , 0~5)			
Uniformity	On			
	Off			
Recall				

Main Menu	Sub-menu	Menu Option	
Color Mode	CAL1/CAL2/ CAL3	Brightness	(-/+ , 0~100)
		Color Calibration Notice	Result
			Remind Schedule Hour
			Counter Hour
			Recall
		Sharpness	(-/+ , 0~100)
		Aspect Ratio	1:1
			4:3
			Full Screen
		Uniformity	On
	Off		
		Recall	
	HDR	Standard	
		HDR_M	
		HDR_H	
		Smooth	
Off			

Main Menu	Sub-menu	Menu Option	
ViewMode	CAD/CAM	Ultra Clear	(-/+ , 0~4)
		Advanced-Sharpness	(-/+ , 0~100)
		Advanced-Gamma	(-/+ , 1.8~2.6)
	Video Edit	Ultra Clear	(-/+ , 0~4)
		Advanced-Sharpness	(-/+ , 0~100)
		Advanced-Gamma	(-/+ , 1.8~2.6)
	Animation	Ultra Clear	(-/+ , 0~4)
		Advanced-Sharpness	(-/+ , 0~100)
		Black Stabilization	(-/+ , 0~10)
	Photographer	Ultra Clear	(-/+ , 0~4)
		Advanced-Sharpness	(-/+ , 0~100)
		Advanced-Gamma	(-/+ , 1.8~2.6)
	FPS 1		
	FPS 2		
	RTS		
	MOBA		
Audio Adjust	Volume	(-/+ , 0~100)	
	Mute	On	
		Off	
	Audio Input	DisplayPort	
		HDMI 1	
		HDMI 2	
		Type C	

Main Menu	Sub-menu	Menu Option	
Setup Menu	Language Select	English	
		Français	
		Deutsch	
		Español	
		Italiano	
		Suomi	
		Русский	
		Türkçe	
		日本語	
		한국어	
		繁體中文	
		简体中文	
	Adaptive Sync	On	
		Off	
	Resolution Notice	On	
		Off	
	PureXP™	On	
		Off	
	Information		
	OSD Timeout	(-/+ , 5/15/30/60)	
	OSD Background	On	
		Off	
	OSD Pivot	Auto	
		0°	
		+90°	
		-90°	
		180°	
	Power Indicator	On	
		Off	
	Auto Power Off	On	
		Off	
	Sleep	30 minutes	
45 minutes			
60 minutes			
120 minutes			
Off			

Main Menu	Sub-menu	Menu Option		
Setup Menu	Multi-Picture	Off		
		PBP Left-Right	Left Source Select	DisplayPort
				HDMI 1
				HDMI 2
			Type C	
			Right Source Select	DisplayPort
				HDMI 1
		HDMI 2		
		Swap	Type C	
		PIP	PIP Source Select	DisplayPort
				HDMI 1
				HDMI 2
			Type C	
			PIP Position	PIP H. Position
				PIP V. Position
		PIP Size	(-/+ , 0~100)	
		Swap		
		Dual Color	DCI-P3	
			sRGB	
			REC709	
			DICOM-SIM	
			User	
			CAL 1	
			CAL 2	
			CAL 3	
			CAD/CAM	
			Video Edit	
			Animation	
			Photographer	
			FPS 1	
FPS 2				
RTS				
MOBA				

Main Menu	Sub-menu	Menu Option		
Setup Menu	ECO Mode	Standard		
		Optimize		
		Conserve		
		Energy Saving		On
				Off
	Overscan	On		
		Off		
	Response Time	Standard		
		Advanced		
		Ultra Fast		
	USB Charging	On		
		Off		
	Backstage Lighting	Level 1		
		Level 2		
		Level 3		
		Off		
	Burn-in Eraser	On		
		Off		
	DDC/CI	On		
		Off		
Rename				
All Recall				

Menu Options

Input

1. Move the joy key ◀ to display the Startup Menu. Then navigate to **Main Menu** and press the ● key to display the OSD Menu.
2. Move the joy key ▲ or ▼ to select **Input**. Then press the ● key to enter the **Input** menu.

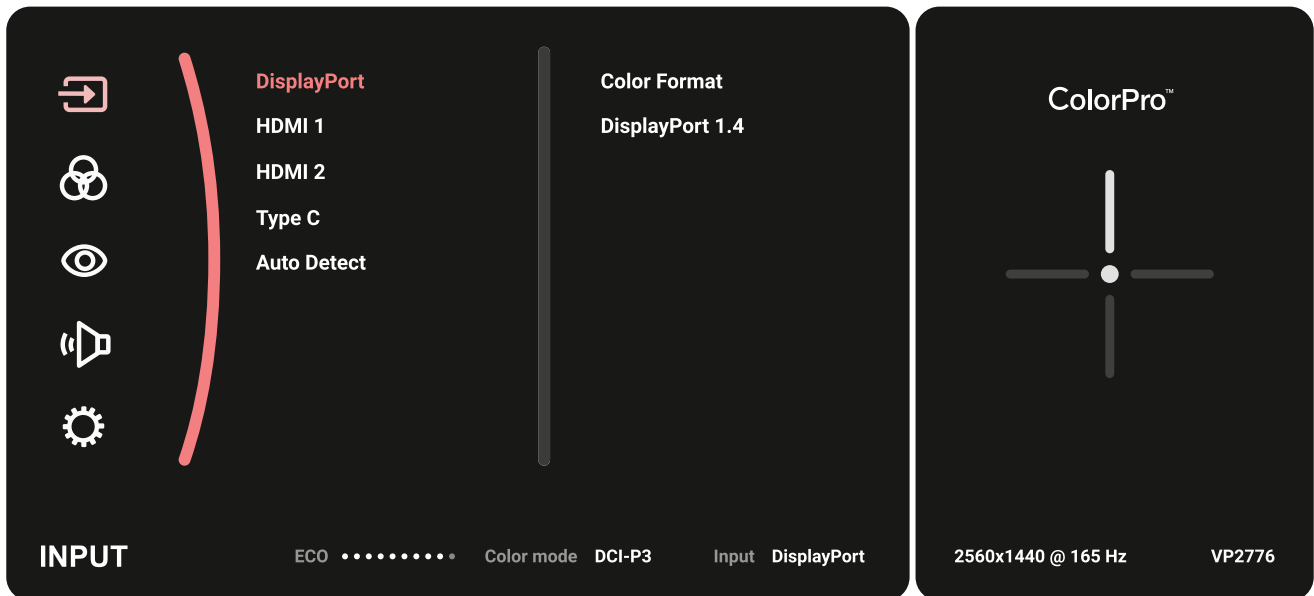

3. Move the joy key ▲ or ▼ to select the desired input source. Then press the ● key to confirm the selection.

Color Mode

1. Move the joy key ◀ to display the Startup Menu. Then navigate to **Main Menu** and press the ● key to display the OSD Menu.
2. Move the joy key ▲ or ▼ to select **Color Mode**. Then press the ● key to enter the **Color Mode** menu.

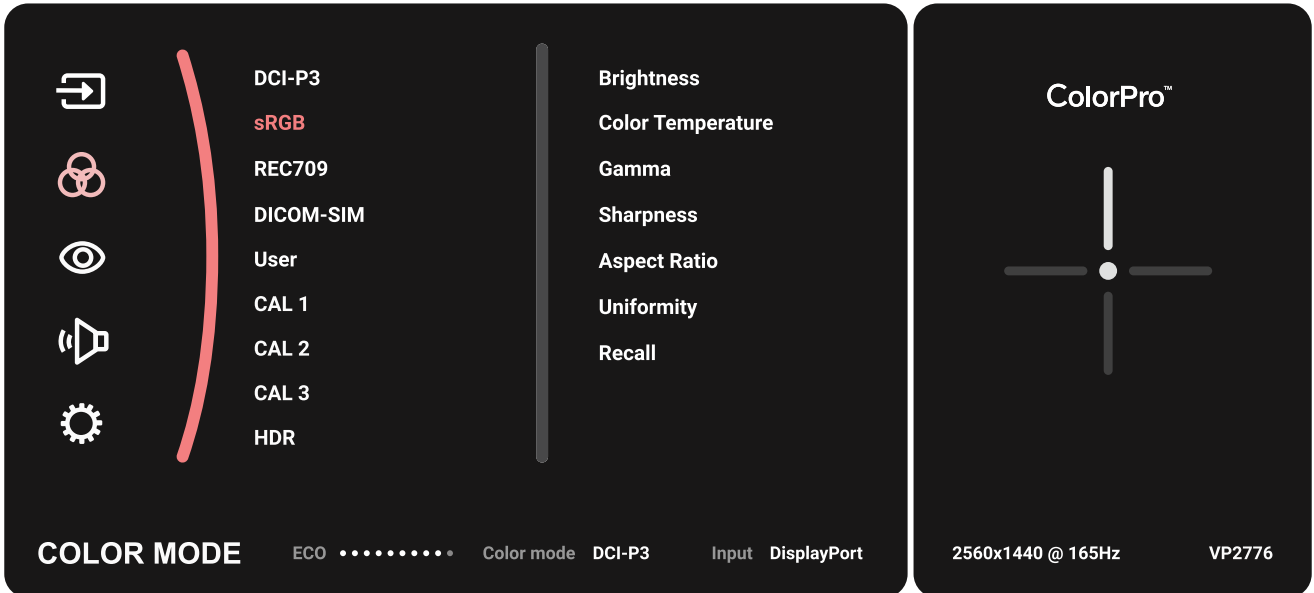

3. Move the joy key ▲ or ▼ to select the desired option. Then press the ● key to enter its sub-menu.
4. Move the joy key ▲ or ▼ to adjust/select the setting, and press the ● key to confirm the selection (if applicable).

Menu Option	Description
DCI-P3	Precise color gamut and gamma of DCI-P3 standard.
sRGB	Precise color gamut and gamma of sRGB standard.
REC709	Precise color gamut and gamma of ITU-R Rec. 709 standard.
DICOM-SIM	Gamma curves are set to a DICOM simulation.
User	Custom, user-defined settings.
CAL1/CAL2/CAL3	Display with the 1st/2nd/3rd user calibration mode.
HDR	Reduce the overall contrast of a given scene so that detail in the highlights and shadows can be seen.

ViewMode

1. Move the joy key ◀ to display the Startup Menu. Then navigate to **Main Menu** and press the ● key to display the OSD Menu.
2. Move the joy key ▲ or ▼ to select **ViewMode**. Then press the ● key to enter the **ViewMode** menu.

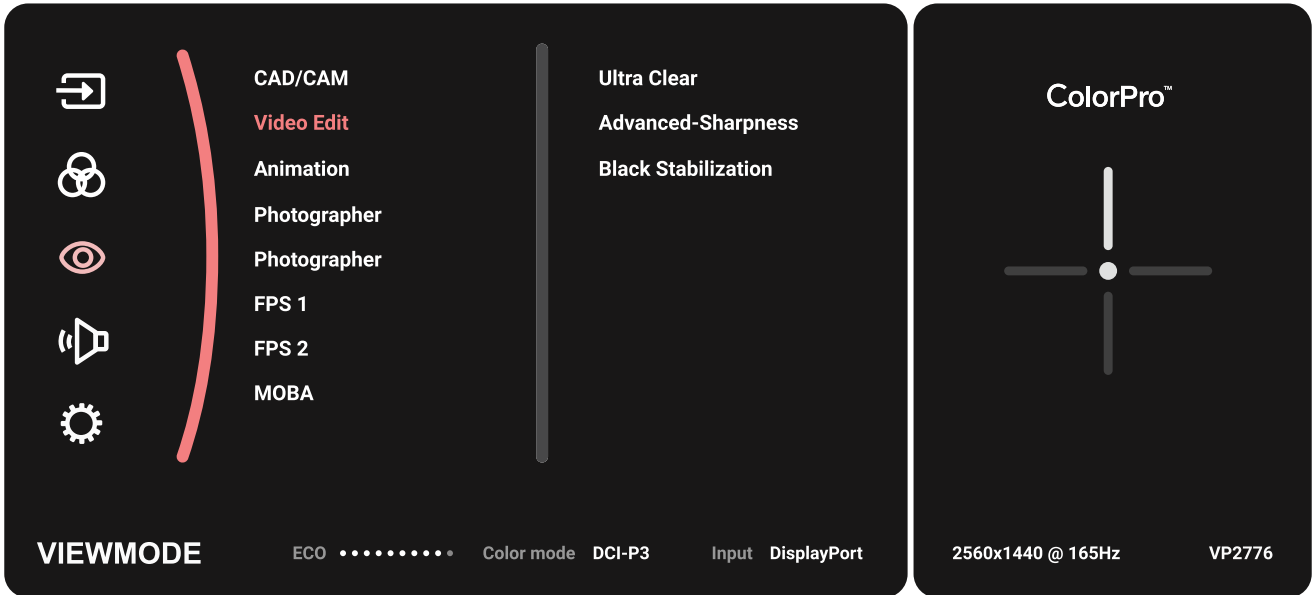

3. Move the joy key ▲ or ▼ to select the desired option. Then press the ● key to enter its sub-menu.

Menu Option	Description
CAD/CAM	Select this option for viewing graphic design files.
Video Edit	Select this option for video editing.
Animation	Select this option for animation.
Photographer	Select this option for viewing photo files.
FPS 1	Ideal for First-Person Shooter games.
FPS 2	Ideal for First-Person Shooter games.
RTS	Ideal for Real-Time Strategy games.
MOBA	Select this option for Multiplayer Online Battle Arena games.

Audio Adjust

1. Move the joy key ◀ to display the Startup Menu. Then navigate to **Main Menu** and press the ● key to display the OSD Menu.
2. Move the joy key ▲ or ▼ to select **Audio Adjust**. Then press the ● key to enter the **Audio Adjust** menu.



3. Move the joy key ▲ or ▼ to select the desired option. Then press the ● key to enter its sub-menu.
4. Move the joy key ▲ or ▼ to adjust/select the setting, and press the ● key to confirm the selection (if applicable).

Menu Option	Description
Volume	Adjust the volume level.
Mute	Enable this option to temporarily turn off the sound.
Audio Input	Select the audio input source.

Setup Menu

1. Move the joy key ◀ to display the Startup Menu. Then navigate to **Main Menu** and press the ● key to display the OSD Menu.
2. Move the joy key ▲ or ▼ to select **Setup Menu**. Then press the ● key to enter the **Setup Menu** menu.

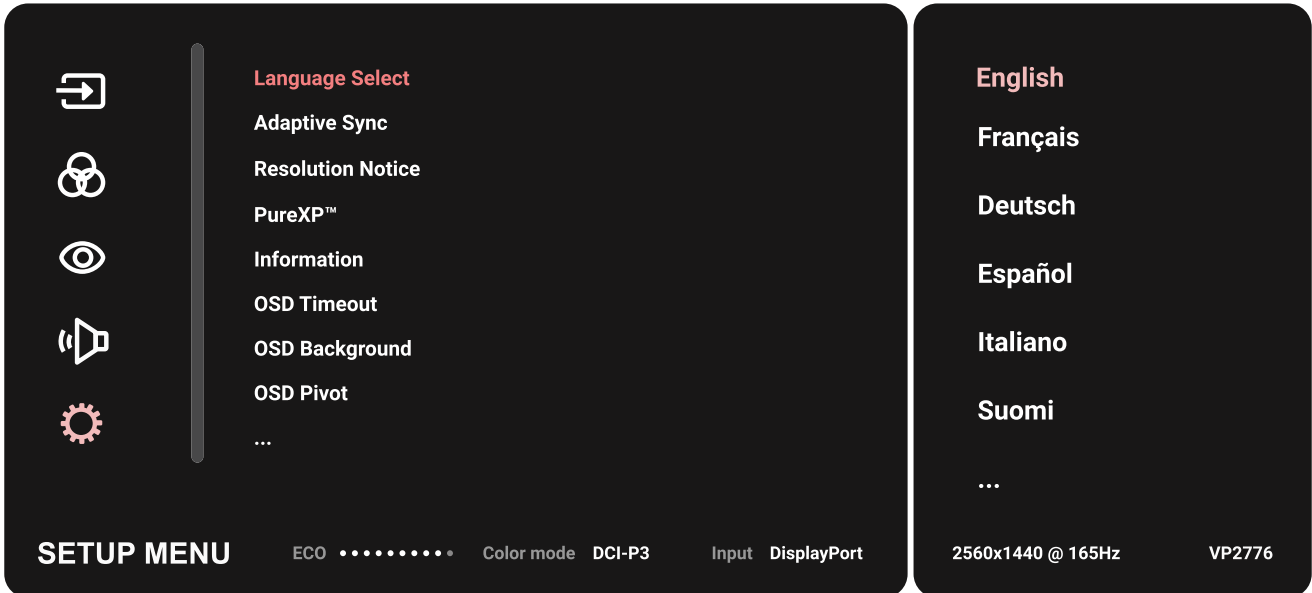

3. Move the joy key ▲ or ▼ to select the desired option. Then press the ● key to enter its sub-menu.
4. Move the joy key ▲ or ▼ to adjust/select the setting, and press the ● key to confirm the selection (if applicable).

NOTE: Some sub-menu options may have another sub-menu. To enter the respective sub-menu, press the ● key. Follow the key guide that appears on the bottom of the screen to select the option or make adjustments.

Menu Option	Description
Language Select	Select an available language for the OSD Menu.
Adaptive Sync	Eliminates stuttering and tearing during gameplay.
Resolution Notice	Enable this option to allow the system to inform users that the current viewing resolution is not the correct native resolution.
PureXP™	Short for “Pure Experience”, this feature can enhance the visual quality of moving objects, making them less vague with a clearer view.
Information	Display the monitor information.
OSD Timeout	Set the length of time the OSD Menu remains on screen.
OSD Background	Show/Hide the OSD background when the OSD Menu appears on the screen.

Menu Option	Description
OSD Pivot	Set the OSD Menu orientation. <ul style="list-style-type: none"> • Auto: With the built-in G sensor, the OSD Menu can automatically pivot when the monitor is positioned vertically. • 0°: Sets the OSD Menu without a pivot. • +90°: Sets the OSD Menu with a +90° pivot. • -90°: Sets the OSD Menu with a -90° pivot. • 180°: Sets the OSD Menu with a 180° pivot.
Power Indicator	Set the Power Indicator On or Off. If the setting is set to On, the power indicator lights blue when the device is turned on.
Auto Power Off	Enable this option to allow the monitor to automatically turn off after a certain amount of time.
Sleep	Set the amount of idle time before the monitor enters <i>Sleep mode</i> .
Multi-Picture	<p><u>Off</u> Disable this function.</p> <p><u>PBP Left-Right</u> Display two windows, a 1x1 split screen, side-by-side on the left and right of the screen. User can specify the input source for each screen.</p> <p><u>PIP</u> Split the screen into two parts, a main window and an inset window. User can specify the input source for each screen.</p> <p><u>Dual Color</u> Display two different color settings in PIP or PBP mode.</p>
ECO Mode	Choose between various modes, based on power consumption.
Overscan	Enable this option to automatically enlarge the original picture horizontally and vertically to an equal aspect ratio that fills the screen.

Menu Option	Description
Response Time	Adjust the response time, creating smooth images without streaking, blurring or ghosting. A low response time is perfect for the most graphic-intense gaming, and provides amazing visual quality while watching sports or action movies.
USB Charging	Enable/disable usb charging.
Backstage Lighting	Adjust the LED lighting.
Burn-in Eraser	Reduce image burn-in.
DDC/CI	Enable this option to allow the monitor control via the graphics card.
Rename	Rename the personalized custom profile.
All Recall	Resets all settings to their default values.

> Advanced Features and Settings

HDR (High-Dynamic-Range)

Reduces the overall contrast of a given scene so that detail in the highlights and shadows can be seen.

NOTE: Ensure the HDR setting is turned on on your device first before enabling the HDR10 on the monitor. For example, the HDR setting on Xbox One S or PS4 Pro needs to be turned on first before enjoying your HDR10 video content.

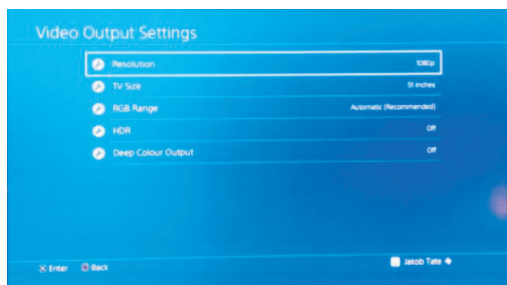

Xbox One S

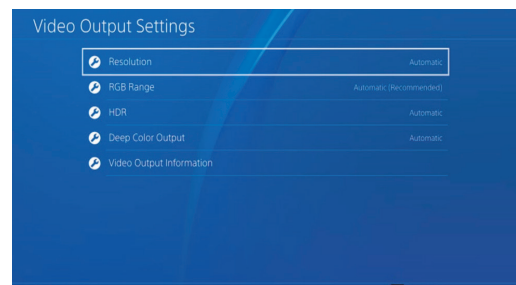

PS4 Pro

To enable the HDR function:

1. Move the joy key ◀ to display the Startup Menu. Then navigate to **Main Menu** and press the ● key to display the OSD Menu.
2. Move the joy key ▲ or ▼ to select **Color Mode**. Then press the ● key to enter the **Color Mode** menu.
3. Move the joy key ▲ or ▼ to select **HDR**. Then press the ● key to enter its sub-menu.
4. Move the joy key ▲ or ▼ to select one of the options . Then press the ● key to confirm.

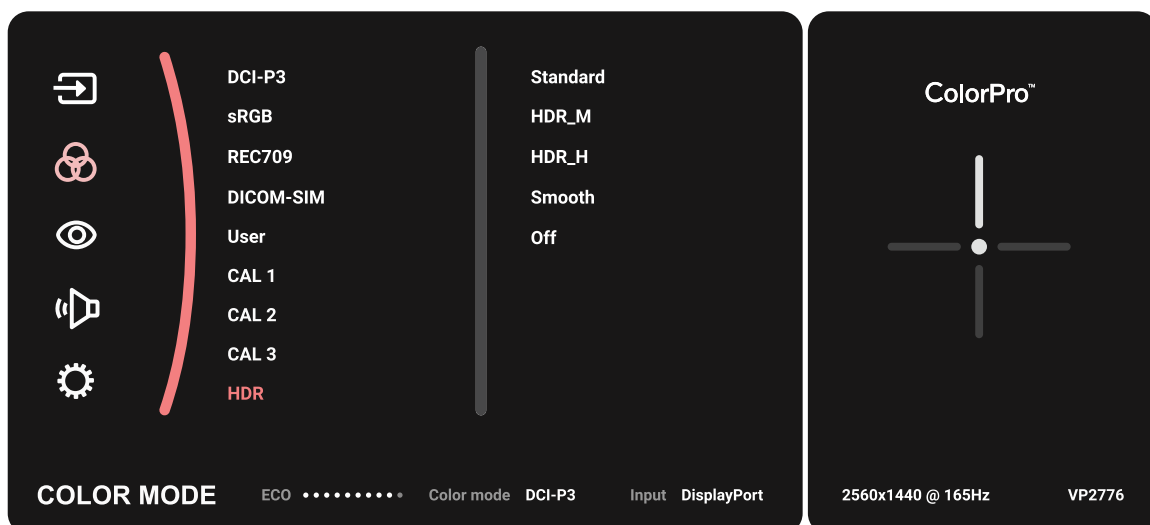

KVM

The KVM function allows the user to control two computers connected to the same monitor from a single keyboard and mouse.

NOTE: Only applicable in PBP (Picture-by-Picture) mode.

To connect the two computers to the monitor:

1. Connect one end of the USB Type C cable to the USB Type C port of the monitor. Then connect the other end of the cable to the USB Type C port of the notebook.
2. Connect one end of a DisplayPort cable to the DisplayPort of the monitor. Then connect the other end of the cable to the DisplayPort or mini DP of the computer.
3. Connect the USB Type B male cable (square with 2 cut corners) to the USB Type B port of the monitor. Then connect the other end of the cable to the USB port of the computer.

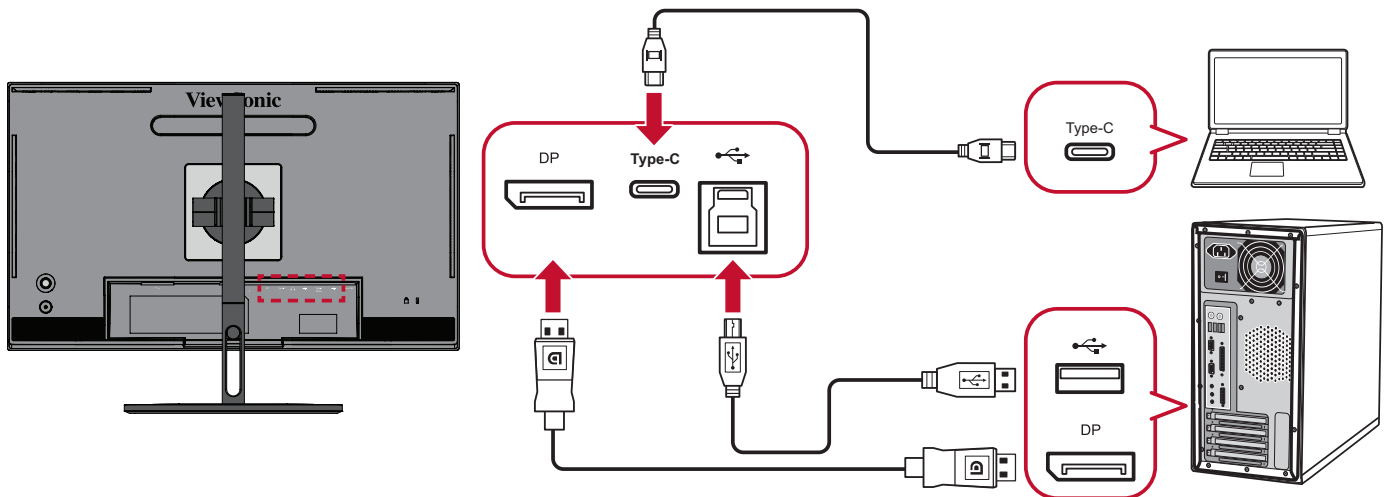

To enable PBP mode:

1. Move the joy key ◀ to display the Startup Menu. Then navigate to **Main Menu** and press the ● key to display the OSD Menu.
2. Move the joy key ▲ or ▼ to select the **Setup Menu** menu. Then press the ● key to enter the menu.
3. Move the joy key ▲ or ▼ to select **Multi-Picture**. Then press the ● key to enter its sub-menu.
4. Move the joy key ▲ or ▼ to select **PBP Left-Right**. Then press the ● key to enable PBP mode.



To activate the KVM function:

1. Press and hold the ► key for two (2) seconds to activate the KVM function.
2. Then you will be able to switch the cursor between the two screens (left/right window).

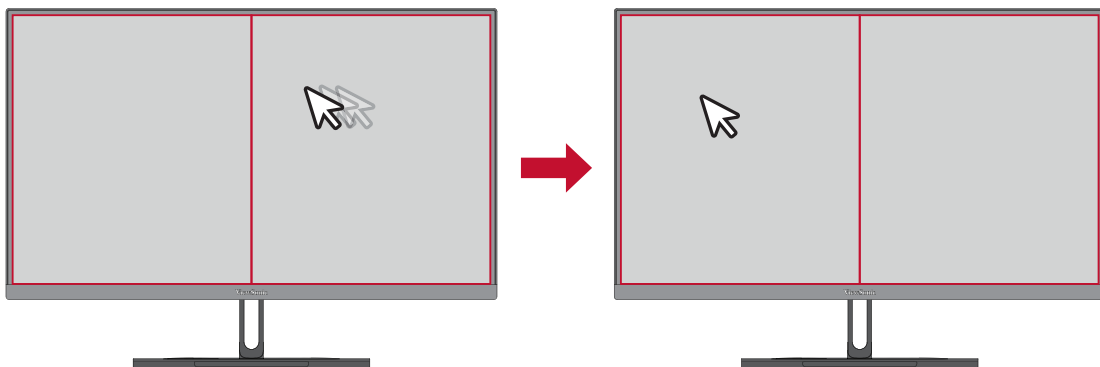

Auto Pivot

With the Auto Pivot function, the monitor can detect the image display and adjust the image's orientation on the screen automatically when pivoting the screen vertically or horizontally.

NOTE: The Auto Pivot function uses DDC/CI to communicate with the monitor. Before applying the Auto Pivot function, please make sure the DDC/CI setting is set to **On**.

To enable the DDC/CI setting:

1. Open the OSD Menu and select the **Setup Menu** menu. Then press the ● key to enter the menu.
2. Move the joy key ▲ or ▼ to select **DDC/CI**. Then press the ● key to enter its sub-menu.
3. Move the joy key ▲ or ▼ to select **On**. Then press the ● key to confirm.

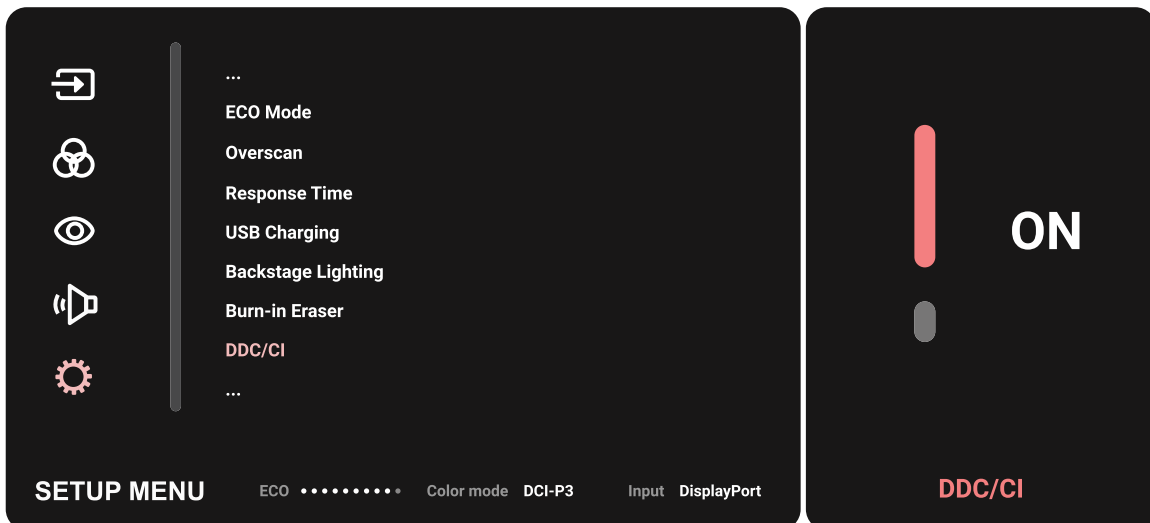

After ensuring **DDC/CI** is **On**, proceed to set **OSD Pivot** to **Auto**:

1. Open the OSD Menu and select the **Setup Menu** menu. Then press the ● key to enter the menu.
2. Move the joy key ▲ or ▼ to select **OSD Pivot**. Then press the ● key to enter its sub-menu.
3. Move the joy key ▲ or ▼ to select **Auto**. Then press the ● key to confirm.

Colorbration+

To ensure long-term color accuracy, some specific models support the hardware color calibration function. The Colorbration+ application installation file can be found at: <http://color.viewsonic.com/support/software/>.

Standard monitor packing does not include the color sensor, which the Colorbration+ application needs for the calibration process.

Compatible color sensors include:

- X-Rite i1 Display Pro
- X-Rite i1 Pro 2
- X-Rite i1 Studio
- Xrite Colormunki Photo
- Xrite Colormunki Design
- Datacolor Spyder 5
- Datacolor SpyderX series

Dual Color

The monitor comes with a dual color engine to display two different color settings in PIP (Picture-in-Picture) or PBP mode. You can set different color presets in both windows (Main Window and Secondary Window).

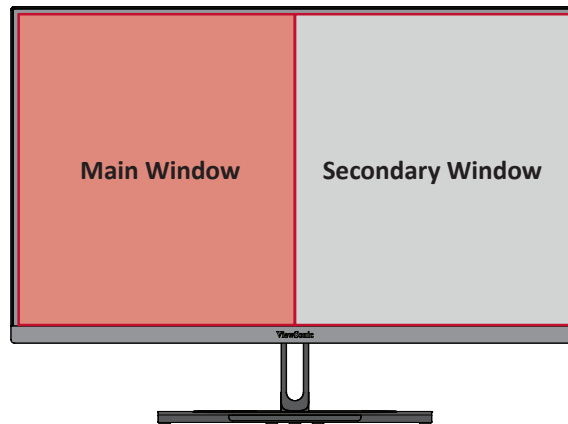

NOTE: To enable PIP or PBP mode, refer to the “Multi-Picture” section.

To configure Dual Color:

1. Move the joy key ◀ to display the Startup Menu. Then navigate to **Main Menu** and press the ● key to display the OSD Menu.
2. Move the joy key ▲ or ▼ to select the **Setup Menu** menu. Then press the ● key to enter the menu.
3. Move the joy key ▲ or ▼ to select **Multi-Picture**. Then press the ● key to enter its sub-menu.
4. Move the joy key ▲ or ▼ to select **Dual Color**. Then press the ● key to enter its sub-menu.
5. Move the joy key ▲ or ▼ to select the desired color setting. Then press the ● key to confirm.

Multi-Picture

Multi-Picture allows users to further customize their work space by allowing up to four split windows from different inputs, displaying high resolution content with different aspect ratios, without distortion from the original input sources.

To enable Multi-Picture mode:

1. Move the joy key ◀ to display the Startup Menu. Then navigate to **Main Menu** and press the ● key to display the OSD Menu.
2. Move the joy key ▲ or ▼ to select **Color Mode**. Then press the ● key to enter the **Color Mode** menu.
3. Move the joy key ▲ or ▼ to select **Multi-Picture**. Then press the ● key to enter its sub-menu.
4. Move the joy key ▲ or ▼ to select **PBP Left-Right** or **PIP**. Then press the ● key to enter the selected mode.

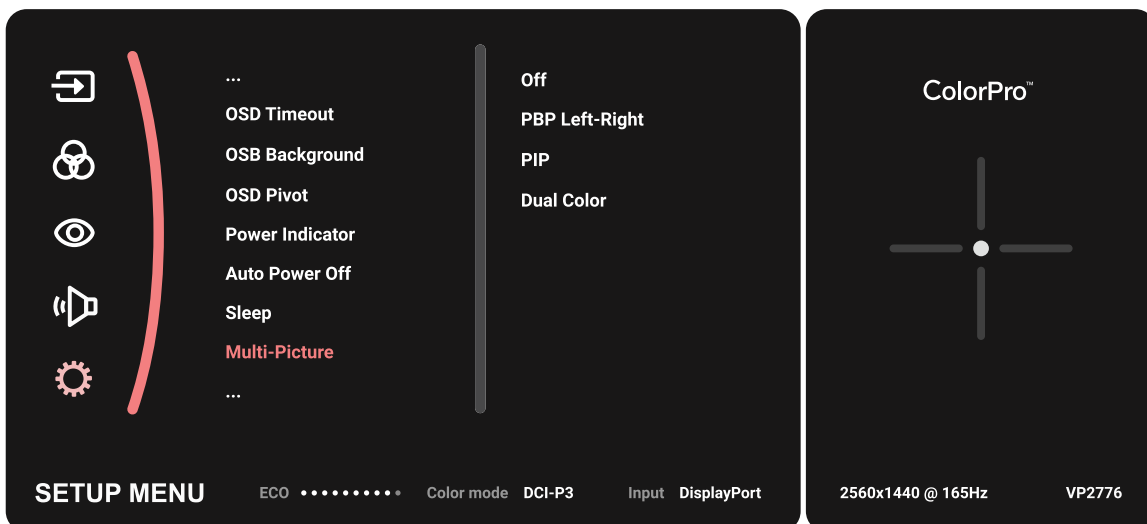

PBP (Picture-by-Picture)

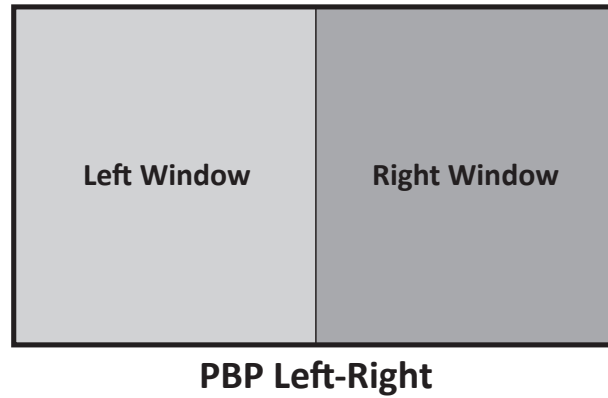

To configure PBP:

1. Move the joy key ◀ to display the Startup Menu. Then navigate to **Main Menu** and press the ● key to display the OSD Menu.
2. Move the joy key ▲ or ▼ to select **Setup Menu**. Then press the ● key to enter the **Setup Menu** menu.
3. Move the joy key ▲ or ▼ to select **Multi-Picture**. Then press the ● key to enter its sub-menu.
4. Move the joy key ▲ or ▼ to select **PBP Left-Right**. Then press the ● key to enter its sub-menu.
5. To change the input source, select the source location (**Left Source Select/Right Source Select**) and press the ● key.
6. Move the joy key ▲ or ▼ to select the desired input source and press the ● key to confirm.
7. To swap the two windows, select **Swap** and press the ● key to confirm.

PIP (Picture-in-Picture)

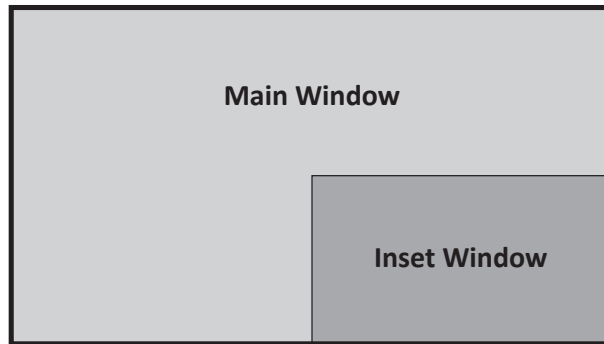

To configure PIP:

1. Move the joy key ◀ to display the Startup Menu. Then navigate to **Main Menu** and press the ● key to display the OSD Menu.
2. Move the joy key ▲ or ▼ to select **Setup Menu**. Then press the ● key to enter the **Setup Menu** menu.
3. Move the joy key ▲ or ▼ to select **Multi-Picture**. Then press the ● key to enter its sub-menu.
4. Move the joy key ▲ or ▼ to select **PIP**. Then press the ● key to enter its sub-menu.
5. To change the input source for the Inset Window, select **PIP Source Select** and press the ● key. Then move the joy key ▲ or ▼ to select the desired input source and press the ● key to confirm.
6. To adjust the Inset Window position, select **PIP Position** and press the ● key.
 - » Press the ● key to select **PIP H.Position** or **PIP V.Position**.
 - » Move the joy key ▲ or ▼ to adjust the setting and press the ● key to confirm.
7. To adjust the Inset Window size, select **PIP Size** and press the ● key. Then move the joy key ▲ or ▼ to adjust the setting.
8. To swap the two windows, select **Swap** and press the ● key to confirm.

Backstage Lighting

With the Backstage Lighting function, the monitor can adjust the LED brightness to the optimal settings.

To configure the Backstage Lighting settings:

1. Open the OSD Menu and select the **Setup Menu** menu. Then touch the ● key to enter the menu.
2. Move the joy key ▲ or ▼ to select **Backstage Lighting**. Then touch the ● key to enter its sub-menu.
3. Move the joy key ▲ or ▼ to select **Level 1**, **Level 2**, or **Level 3** to enable the function. Then touch the ● key to confirm.

Firmware Update

For the best display performance and to resolve any known issues, it is best to keep your monitor updated with the latest firmware version. With the supplied USB cable and the vDisplayManager application, you can easily update your monitor's firmware.

To update the firmware:

1. Download and install the vDisplayManager application: <https://color.viewsonic.com/support/software/>.
2. Connect the USB Type B male cable (square with 2 cut corners) to the USB Type B port of your monitor. Then connect the other end of the cable to the USB port of the computer.

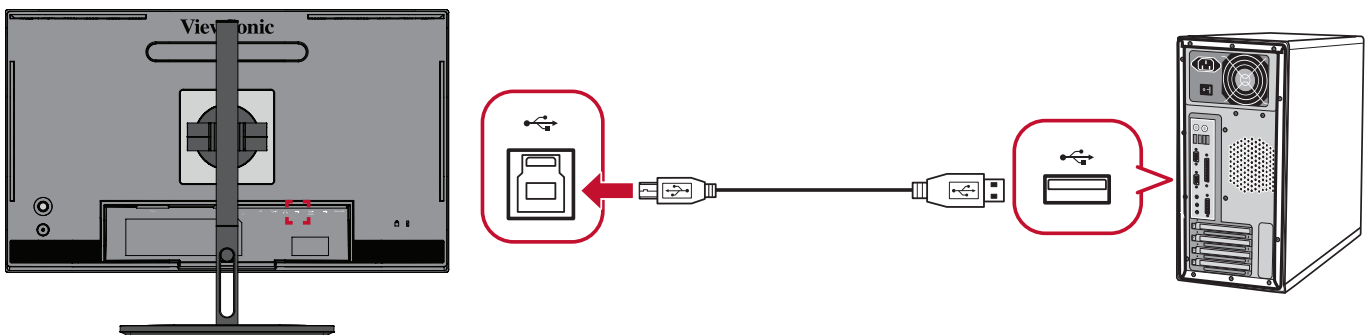

3. Launch vDisplayManager. Select the **Advanced** tab in the side menu.
4. Click **Update** to check for any updates to your monitor's firmware.
5. Wait until the update process is complete (if applicable).

NOTE: Any interruptions during the firmware update process may permanently damage your monitor. Do not disconnect the USB cable or turn off your PC and monitor.

> Appendix

Specifications

Item	Category	Specifications
LCD	Type	IPS type, TFT Active Matrix 2560 x 1440 LCD, 0.2331 mm x 0.2331 mm pixel pitch
	Display Size	68.47 cm, 27" (27" viewable)
	Color Filter	RGB vertical stripe
	Glass Surface	Anti-Glare type, Hard Coating (3H)
Input Signal	Video Sync	<u>TMDS digital (100 Ω)</u> HDMI: f _h :15-204 kHz, f _v :24-120 Hz DisplayPort: f _h :15-204 kHz, f _v :24-120 Hz
Compatibility	PC	up to 2560 x 1440
	Macintosh	up to 2560 x 1440
	Recommended	2560 x 1440 @ 165Hz
Resolution ¹	Supported	<ul style="list-style-type: none"> • 2560 x 1440 @ 60, 165Hz • 2048 x 1152 @ 60Hz • 1920 x 1440 @ 60Hz • 1920 x 1200 @ 60Hz • 1920 x 1080 @ 50, 60Hz • 1680 x 1050 @ 60Hz • 1600 x 1200 @ 60Hz • 1600 x 900 @ 60Hz • 1440 x 900 @ 60, 75Hz • 1400 x 1050 @ 60, 75Hz • 1366 x 768 @ 60Hz • 1360 x 768 @ 60Hz • 1280 x 1024 @ 50, 60, 75Hz • 1280 x 960 @ 50, 60, 75Hz • 1280 x 800 @ 60Hz • 1280 x 768 @ 50, 60Hz • 1280 x 720 @ 50, 60Hz • 1152 x 900 @ 67Hz • 1152 x 864 @ 75Hz • 1024 x 768 @ 50, 60, 70, 72, 75Hz • 848 x 480 @ 60Hz • 800 x 600 @ 56, 60, 72Hz • 720 x 576 @ 50Hz • 720 x 480 @ 60Hz • 720 x 400 @ 70Hz • 640 x 480 @ 50, 60, 67, 72Hz • 640 x 400 @ 60, 70Hz • 640 x 350 @ 70Hz
Power Adapter ²	Input Voltage	AC 100-240V, 50/60Hz (auto switch)

Item	Category	Specifications
Display Area	Full Scan (H x V)	596.74 x 335.66 mm (23.49" x 13.21")
Operating conditions	Temperature	0° C to 40° C (32° F to 104° F)
	Humidity	20% to 90% (non-condensing)
	Altitude	10,000 feet (3.048 km)
Storage conditions	Temperature	-20° C to 60° C (-4° F to 140° F)
	Humidity	5% to 90% (non-condensing)
	Altitude	40,000 feet (12.1 km)
Dimensions	Physical (W x H x D)	613.70 x 569.36~449.36 x 234 mm (24.16" x 22.42~17.69" x 9.21")
Wall Mount	Dimensions	100 x 100 mm
Weight	Physical	9.55 kg (21.05 lbs)
Power saving modes	On ³	32W (Typical)
	Off	< 0.3W (Max)

¹ Do not set the graphics card in your computer to exceed these timing modes; doing so may result in permanent damage to the display.

² Please use the power adapter from ViewSonic® or an authorized source only.

³ The test condition follows EEI standards.

Glossary

This section describes the standard glossary of terms used in all LCD display models. All terms are listed in alphabetical order.

NOTE: Some terms may not be applicable to your monitor.

A

Advanced DCR

Advanced DCR technology automatically detects the image signal and intelligently controls the backlight brightness and color to improve on the ability to make the black blacker in a dark scene, and make the white whiter in a bright environment.

Adaptive Sync

Adaptive Sync technology puts an end to choppy gameplay and broken frames with fluid, artifact-free performance at virtually any frame rate.

Audio Adjust

Adjusts the volume, mutes the sound, or toggles between inputs if you have more than one source.

Auto Detect

If the current input source has no signal, the monitor will automatically switch to the next input option. This function, on some models, is disabled by default.

B

Black Stabilization

ViewSonic's Black Stabilization provides heightened visibility and detail by brightening dark scenes.

Blue Light Filter

Adjusts the filter that blocks high-energy blue light for a more comfortable viewing experience.

Boot Up Screen

Turning off the boot screen will disable the on-screen message from displaying when turning on the monitor.

Brightness

Adjusts background black levels of the screen image.

C Color Adjust

Provides several color adjustment modes to help adjust the color settings to fit the user's needs.

Color Range

The monitor can detect the input signal color range automatically. You can manually change the color range options to fit the correct color range if the colors are not displayed correctly.

Options	Description
Auto	The monitor automatically recognizes the color format and black and white levels.
Full Range	The color range of the black and white levels are full.
Limited Range	The color range of the black and white levels are limited.

Color Space

Allows users to choose which color space they would like to use for monitor color output (RGB, YUV).

Color Temperature

Allows users to select specific color temperature settings to further customize their viewing experience.

Panel Default	Panel Original Status
sRGB	Standard color space used for the Windows system.
Bluish	Set the color temperature to 9300K.
Cool	Set the color temperature to 7500K.
Native	Default color temperature. Recommended for general use.
Warm	Set the color temperature to 5000K.

Contrast

Adjusts the difference between the image background (black level) and the foreground (white level).

G Gamma

Allows users to manually adjust the brightness level of the monitor's grayscale levels. There are six selections: 1.8, 2.0, 2.2, 2.4, 2.6, and 2.8.

H Hue

Adjusts the tint of each color (red, green, blue, cyan, magenta, and yellow).

I Information

Displays the timing mode (video signal input) coming from the graphics card in the computer, the LCD model number, the serial number, and the ViewSonic® website URL. See your graphics card's user guide for instructions on changing the resolution and refresh rate (vertical frequency).

NOTE: VESA 1024 x 768 @ 60Hz, for example, means that the resolution is 1024 x 768 and the refresh rate is 60Hz.

Input Select

Toggles between the various input options that are available for the monitor.

M Manual Image Adjust

Displays the "Manual Image Adjust" menu. You can manually set a variety of image quality adjustments.

Memory Recall

Returns the adjustments back to factory settings if the display is operating in a factory preset timing mode listed in the "Specifications" of this manual.

NOTE:

- (Exception) This control does not affect changes made in the "Language Select" or "Power Lock" setting.
- Memory Recall is the default as-shipped display configuration and settings. Memory Recall is the setting in which the product qualifies for ENERGY STAR®. Any changes to default as-shipped display configuration and settings would change the energy consumption, and may increase energy consumption beyond the limits required for ENERGY STAR® qualification, as applicable. ENERGY STAR® is a set of power-saving guidelines issued by the U.S. Environmental Protection Agency (EPA). ENERGY STAR® is a joint program of the U.S. Environmental Protection Agency and the U.S. Department of Energy helping us all save money and protect the environment through energy efficient products and practices.



O

Offset

Adjusts black levels for red, green, and blue. The gain and offset functions allow users to control the white balance for the upmost control when manipulating contrast and dark scenes.

OSD Pivot

Sets the monitor OSD Menu display direction.

Overscan

Refers to a cropped image on your monitor's screen. A setting on your monitor zooms in on movie content, so that you cannot see the outermost edges of the film.

P

Power Indicator

The light that displays whether the monitor is on or off. This setting also controls the lighting on the stand. Users can turn off the lighting effect under "Power Indicator". Additionally, the power indicator displays an average color directly interpreting the input color signal received on screen.

Q

Quick Access

Quickly initiate some functions and modes through the Quick Access key and menu. Users can also define which functions or modes they prefer in the Quick Access Menu via the **Setup Menu** in OSD. The function/mode will be enabled as soon as the light-bar moves on the item, and will disable after removing the light-bar.

R

Recall

Resets the ViewMode monitor settings.

Resolution Notice

The notice tells users that the current viewing resolution is not the correct native resolution. This notice will appear in the display settings window when setting up the display resolution.

S Setup Menu

Adjusts On-Screen Display (OSD) Menu settings. Many of these settings can activate on-screen display notifications so users do not have to reopen the menu.

Sharpness

Adjusts the picture quality of the monitor.

V ViewMode

ViewSonic's unique ViewMode feature offers "Game", "Movie", "Web", "Text", "MAC", and "Mono" presets. These presets are specifically designed to deliver an optimized viewing experience for different screen applications.

ViewScale

Gamers have the ability to adjust the display size of the image on the monitor, allowing for a "best fit" scenario.

Troubleshooting

This section describes some common problems that you may experience when using the monitor.

Problem or Issue	Possible Solutions
No power	<ul style="list-style-type: none">• Make sure you have turned on the monitor by pressing the Power button.• Make sure the power cord is properly and securely connected to the monitor and power outlet.• Plug another electrical device into the power outlet to verify that the outlet is supplying power.
Power is On, but no image appears on screen	<ul style="list-style-type: none">• Make sure the video cable connecting the monitor to the computer is properly and securely connected.• Adjust the brightness and contrast settings.• Make sure the correct input source is selected.
Wrong or abnormal colors	<ul style="list-style-type: none">• If any colors (red, green, or blue) are missing, check the video cable to make sure it is properly and securely connected. Loose or broken pins in the cable connector could cause an improper connection.• Connect the monitor to another computer.
Screen image is too light or dark	<ul style="list-style-type: none">• Adjust brightness and contrast settings via the OSD Menu.• Reset the monitor to factory settings.
Screen image cuts in and out	<ul style="list-style-type: none">• Make sure the correct input source is selected.• Check for bent or broken pins in the video cable connector.• Make sure the video cable connecting the monitor to the computer is properly and securely connected.
Screen image is blurred	<ul style="list-style-type: none">• Adjust the resolution to the correct Aspect Ratio.• Reset the monitor to factory settings.

Problem or Issue	Possible Solutions
The screen isn't centered correctly	<ul style="list-style-type: none"> • Adjust the horizontal and vertical controls via the OSD Menu. • Check the Aspect Ratio. • Reset the monitor to factory settings.
The screen appears yellow	<ul style="list-style-type: none"> • Make sure the "Blue Light Filter" is Off.
The OSD Menu does not appear on the screen/the OSD controls are inaccessible	<ul style="list-style-type: none"> • Check whether the OSD Menu is locked. • Turn off the monitor, unplug the power cord, plug it back in, and then turn on the monitor. • Reset the monitor to factory settings.
Control panel keys do not work	<ul style="list-style-type: none"> • Press only one key at a time. • Restart the computer.
Some menus aren't selectable in the OSD	<ul style="list-style-type: none"> • Adjust the ViewMode or the input source. • Reset the monitor to factory settings.
No audio output	<ul style="list-style-type: none"> • If using ear-/headphones, ensure the mini stereo jack is connected. • Make sure the volume is not muted, nor set to 0. • Check the Audio Input setting.
The monitor will not adjust	<ul style="list-style-type: none"> • Make sure there are no obstructions near or on the monitor, and that there is adequate spacing. • For more information, see "Adjusting the Viewing Angle".
USB devices connected to the monitor do not work	<ul style="list-style-type: none"> • Make sure the USB cable is connected properly. • Try changing to another USB port (if applicable). • Some USB devices require a higher electric current; connect the device directly to the computer.
The external device is connected, but no image appears on the screen	<ul style="list-style-type: none"> • Make sure the Power is On • Adjust brightness and contrast via the OSD Menu. • Check the connecting cable and make sure it is properly and securely connected. Loose or broken pins in the cable connector could cause an improper connection.

Maintenance

General Precautions

- Make sure the monitor is turned off and the power cable is unplugged from the power outlet.
- Never spray or pour any liquid directly onto the screen or case.
- Handle the monitor with care, as a darker-colored monitor, if scuffed, may show marks more clearly than a lighter-colored monitor.

Cleaning the Screen

- Wipe the screen with a clean, soft, lint-free cloth. This removes dust and other particles.
- If the screen is still not clean, apply a small amount of non-ammonia, non-alcohol based glass cleaner onto a clean, soft, lint-free cloth; then wipe the screen.

Cleaning the Case

- Use a soft, dry cloth.
- If the case is still not clean, apply a small amount of non-ammonia, non-alcohol based, mild non-abrasive detergent onto a clean, soft, lint-free cloth, then wipe the surface.

Disclaimer

- ViewSonic® does not recommend the use of any ammonia or alcohol-based cleaners on the display screen or case. Some chemical cleaners have been reported to damage the screen and/or case of the monitor.
- ViewSonic® will not be liable for damage resulting from use of any ammonia or alcohol-based cleaners.

> Regulatory and Service Information

Compliance Information

This section addresses all connected requirements and statements regarding regulations. Confirmed corresponding applications shall refer to nameplate labels and relevant markings on the unit.

FCC Compliance Statement

This device complies with part 15 of FCC Rules. Operation is subject to the following two conditions: (1) this device may not cause harmful interference, and (2) this device must accept any interference received, including interference that may cause undesired operation. This equipment has been tested and found to comply with the limits for a Class B digital device, pursuant to part 15 of the FCC Rules.

These limits are designed to provide reasonable protection against harmful interference in a residential installation. This equipment generates, uses, and can radiate radio frequency energy, and if not installed and used in accordance with the instructions, may cause harmful interference to radio communications. However, there is no guarantee that interference will not occur in a particular installation. If this equipment does cause harmful interference to radio or television reception, which can be determined by turning the equipment off and on, the user is encouraged to try to correct the interference by one or more of the following measures:

- Reorient or relocate the receiving antenna.
- Increase the separation between the equipment and receiver.
- Connect the equipment into an outlet on a circuit different from that to which the receiver is connected.
- Consult the dealer or an experienced radio/TV technician for help.

Warning: You are cautioned that changes or modifications not expressly approved by the party responsible for compliance could void your authority to operate the equipment.

Industry Canada Statement

CAN ICES-003 (B) / NMB-003(B)

CE Conformity for European Countries

 The device complies with the EMC Directive 2014/30/EU and Low Voltage Directive 2014/35/EU.

The following information is only for EU-member states:

The mark shown to the right is in compliance with the Waste Electrical and Electronic Equipment Directive 2012/19/EU (WEEE). The mark indicates the requirement NOT to dispose of the equipment as unsorted municipal waste, but use the return and collection systems according to local law.



Declaration of RoHS2 Compliance

This product has been designed and manufactured in compliance with Directive 2011/65/EU of the European Parliament and the Council on restriction of the use of certain hazardous substances in electrical and electronic equipment (RoHS2 Directive) and is deemed to comply with the maximum concentration values issued by the European Technical Adaptation Committee (TAC) as shown below:

Substance	Proposed Maximum Concentration	Actual Concentration
Lead (Pb)	0.1%	< 0.1%
Mercury (Hg)	0.1%	< 0.1%
Cadmium (Cd)	0.01%	< 0.01%
Hexavalent Chromium (Cr6 ⁺)	0.1%	< 0.1%
Polybrominated biphenyls (PBB)	0.1%	< 0.1%
Polybrominated diphenyl ethers (PBDE)	0.1%	< 0.1%
Bis (2-ethylhexyl) phthalate (DEHP)	0.1%	< 0.1%
Butyl benzyl phthalate (BBP)	0.1%	< 0.1%
Dibutyl phthalate (DBP)	0.1%	< 0.1%
Diisobutyl phthalate (DIBP)	0.1%	< 0.1%

Certain components of products as stated above are exempted under the Annex III of the RoHS2 Directives as noted below. Examples of exempted components are:

- Lead as an alloying element in aluminum containing up to 0.4% lead by weight.
- Copper alloy containing up to 4% lead by weight.
- Lead in high melting temperature type solders (i.e. lead-based alloys containing 85% by weight or more lead).
- Electrical and electronic components containing lead in a glass or ceramic other than dielectric ceramic in capacitors, e.g. piezoelectronic devices, or in a glass or ceramic matrix compound.

Indian Restriction of Hazardous Substances

Restriction on Hazardous Substances statement (India). This product complies with the “India E-waste Rule 2011” and prohibits use of lead, mercury, hexavalent chromium, polybrominated biphenyls or polybrominated diphenyl ethers in concentrations exceeding 0.1 weight % and 0.01 weight % for cadmium, except for the exemptions set in Schedule 2 of the Rule.

Product Disposal at End of Product Life

ViewSonic® respects the environment and is committed to working and living green. Thank you for being part of Smarter, Greener Computing. Please visit the ViewSonic® website to learn more.

USA & Canada:

<https://www.viewsonic.com/us/company/green/go-green-with-viewsonic/#recycle-program>

Europe:

<https://www.viewsoniceurope.com/eu/support/call-desk/>

Taiwan:

<https://recycle.epa.gov.tw/>

Copyright Information

Copyright© ViewSonic® Corporation, 2022. All rights reserved.

Macintosh and Power Macintosh are registered trademarks of Apple Inc.

Microsoft, Windows, and the Windows logo are registered trademarks of Microsoft Corporation in the United States and other countries.

ViewSonic®, the three birds logo, OnView, ViewMatch, and ViewMeter are registered trademarks of ViewSonic® Corporation.

VESA is a registered trademark of the Video Electronics Standards Association. DPMS, DisplayPort, and DDC are trademarks of VESA.

ENERGY STAR® is a registered trademark of the U.S. Environmental Protection Agency (EPA).

As an ENERGY STAR® partner, ViewSonic® Corporation has determined that this product meets the ENERGY STAR® guidelines for energy efficiency.

Disclaimer: ViewSonic® Corporation shall not be liable for technical or editorial errors or omissions contained herein; nor for incidental or consequential damages resulting from furnishing this material, or the performance or use of this product.

In the interest of continuing product improvement, ViewSonic® Corporation reserves the right to change product specifications without notice. Information in this document may change without notice.

No part of this document may be copied, reproduced, or transmitted by any means, for any purpose without prior written permission from ViewSonic® Corporation.

Customer Service

For technical support or product service, see the table below or contact your reseller.

NOTE: You will need the product's serial number.

Country/ Region	Website	Country/ Region	Website
Asia Pacific & Africa			
Australia	www.viewsonic.com/au/	Bangladesh	www.viewsonic.com/bd/
中国 (China)	www.viewsonic.com.cn	香港 (繁體中文)	www.viewsonic.com/hk/
Hong Kong (English)	www.viewsonic.com/hk-en/	India	www.viewsonic.com/in/
Indonesia	www.viewsonic.com/id/	Israel	www.viewsonic.com/il/
日本 (Japan)	www.viewsonic.com/jp/	Korea	www.viewsonic.com/kr/
Malaysia	www.viewsonic.com/my/	Middle East	www.viewsonic.com/me/
Myanmar	www.viewsonic.com/mm/	Nepal	www.viewsonic.com/np/
New Zealand	www.viewsonic.com/nz/	Pakistan	www.viewsonic.com/pk/
Philippines	www.viewsonic.com/ph/	Singapore	www.viewsonic.com/sg/
臺灣 (Taiwan)	www.viewsonic.com/tw/	ประเทศไทย	www.viewsonic.com/th/
Việt Nam	www.viewsonic.com/vn/	South Africa & Mauritius	www.viewsonic.com/za/
Americas			
United States	www.viewsonic.com/us	Canada	www.viewsonic.com/us
Latin America	www.viewsonic.com/la		
Europe			
Europe	www.viewsonic.com/eu/	France	www.viewsonic.com/fr/
Deutschland	www.viewsonic.com/de/	Қазақстан	www.viewsonic.com/kz/
Россия	www.viewsonic.com/ru/	España	www.viewsonic.com/es/
Türkiye	www.viewsonic.com/tr/	Україна	www.viewsonic.com/ua/
United Kingdom	www.viewsonic.com/uk/		

Limited Warranty

ViewSonic® Display

What the warranty covers:

ViewSonic® warrants its products to be free from defects in material and workmanship during the warranty period. If a product proves to be defective in material or workmanship during the warranty period, ViewSonic® will, at its sole option, and as your sole remedy, repair or replace the product with a similar product. Replacement Product or parts may include remanufactured or refurbished parts or components. The repair or replacement unit or parts or components will be covered by the balance of the time remaining on the customer's original limited warranty and the warranty period will not be extended. ViewSonic® provides no warranty for any third-party software whether included with the product or installed by the customer, installation of any unauthorized hardware parts or components (e.g. Projector Lamps). (Please refer to: "What the warranty excludes and does not cover" section).

How long the warranty is effective:

ViewSonic® displays are warranted for between 1 and 3 years, depending on your country of purchase, for all parts including the light source and for all labor from the date of the first consumer purchase.

Who the warranty protects:

This warranty is valid only for the first consumer purchaser.

What the warranty excludes and does not cover:

- Any product on which the serial number has been defaced, modified, or removed.
- Damage, deterioration, or malfunction resulting from:
 - » Accident, misuse, neglect, fire, water, lightning, or other acts of nature, unauthorized product modification, or failure to follow instructions supplied with the product.
 - » Repair or attempted repair by anyone not authorized by ViewSonic®.
 - » Damage to or loss of any programs, data, or removable storage media.
 - » Normal wear and tear.
 - » Removal or installation of the product.
- Software or data loss occurring during repair or replacement.
- Any damage of the product due to shipment.

- Causes external to the product, such as electric power fluctuations or failure.
- Use of supplies or parts not meeting ViewSonic’s specifications.
- Failure of owner to perform periodic product maintenance as stated in the User Guide.
- Any other cause which does not relate to a product defect.
- Damage caused by static (non-moving) images displayed for lengthy periods of time (also referred to as image burn-in).
- Software - Any third-party software included with the product or installed by the customer.
- Hardware/Accessories/Parts/Components – Installation of any unauthorized hardware, accessories, consumable parts or components (e.g. Projector Lamps).
- Damage to, or abuse of, the coating on the surface of the display through inappropriate cleaning as described in the product User Guide.
- Removal, installation, and set-up service charges, including wall-mounting of the product.

How to get service:

- For information about receiving service under warranty, contact ViewSonic® Customer Support (Please refer to the “Customer Service” page). You will need to provide your product’s serial number.
- To obtain warranty service, you will be required to provide: (a) the original dated sales slip, (b) your name, (c) your address, (d) a description of the problem, and (e) the serial number of the product.
- Take or ship the product, freight prepaid, in the original container to an authorized ViewSonic® service center or ViewSonic®.
- For additional information or the name of the nearest ViewSonic® service center, contact ViewSonic®.

Limitation of implied warranties:

There are no warranties, express or implied, which extend beyond the description contained herein including the implied warranty of merchantability and fitness for a particular purpose.

Exclusion of damages:

ViewSonic's liability is limited to the cost of repair or replacement of the product. ViewSonic® shall not be liable for:

- Damage to other property caused by any defects in the product, damages based upon inconvenience, loss of use of the product, loss of time, loss of profits, loss of business opportunity, loss of goodwill, interference with business relationships, or other commercial loss, even if advised of the possibility of such damages.
- Any other damages, whether incidental, consequential or otherwise.
- Any claim against the customer by any other party.
- Repair or attempted repair by anyone not authorized by ViewSonic®.

Effect of state law:

This warranty gives you specific legal rights, and you may also have other rights which vary from state to state. Some states do not allow limitations on implied warranties and/or do not allow the exclusion of incidental or consequential damages, so the above limitations and exclusions may not apply to you.

Sales outside the U.S.A. and Canada:

For warranty information and service on ViewSonic® products sold outside of the U.S.A. and Canada, contact ViewSonic® or your local ViewSonic® dealer.

The warranty period for this product in mainland China (Hong Kong, Macao, and Taiwan Excluded) is subject to the terms and conditions of the Maintenance Guarantee Card.

For users in Europe and Russia, full details of warranty provided can be found at: <http://www.viewsonic.com/eu/> under "Support/Warranty Information".

Mexico Limited Warranty

ViewSonic® Display

What the warranty covers:

ViewSonic® warrants its products to be free from defects in material and workmanship, under normal use, during the warranty period. If a product proves to be defective in material or workmanship during the warranty period, ViewSonic® will, at its sole option, repair or replace the product with a like product. Replacement product or parts may include remanufactured or refurbished parts or components & accessories.

How long the warranty is effective:

ViewSonic® LCD displays are warranted for between 1 and 3 years, depending on your country of purchase, for all parts including the light source and for all labour from the date of the first consumer purchase.

Who the warranty protects:

This warranty is valid only for the first consumer purchaser.

What the warranty excludes and does not cover:

- Any product on which the serial number has been defaced, modified or removed.
- Damage, deterioration, or malfunction resulting from:
 - » Accident, misuse, neglect, fire, water, lightning, or other acts of nature, unauthorized product modification, unauthorized attempted repair, or failure to follow instructions supplied with the product.
 - » Causes external to the product, such as electrical power fluctuations or failure.
 - » Use of supplies or parts not meeting ViewSonic®'s specifications.
 - » Normal wear and tear.
 - » Any other cause which does not relate to a product defect.
- Any product exhibiting a condition commonly known as “image burn-in” which results when a static image is displayed on the product for an extended period of time.
- Removal, installation, insurance, and set-up service charges.

How to get service:

For information about receiving service under warranty, contact ViewSonic® Customer Support (Please refer to the attached “Customer Service” page). You will need to provide your product’s serial number, so please record the product information in the space provided below on your purchase for your future use. Please retain your receipt of proof of purchase to support your warranty claim.

For Your Records

Product Name: _____ Model Number: _____

Document Number: _____ Serial Number: _____

Purchase Date: _____ Extended Warranty Purchase? _____ (Y/N)

If so, what date does warranty expire? _____

- To obtain warranty service, you will be required to provide (a) the original dated sales slip, (b) your name, (c) your address, (d) a description of the problem, and (e) the serial number of the product.
- Take or ship the product, in the original container packaging, to an authorized ViewSonic® service center.
- Round trip transportation costs for in-warranty products will be paid by ViewSonic®.

Limitation of implied warranties:

There are no warranties, express or implied, which extend beyond the description contained herein including the implied warranty of merchantability and fitness for a particular purpose.

Exclusion of damages:

ViewSonic®’s liability is limited to the cost of repair or replacement of the product.

ViewSonic® shall not be liable for:

- Damage to other property caused by any defects in the product, damages based upon inconvenience, loss of use of the product, loss of time, loss of profits, loss of business opportunity, loss of goodwill, interference with business relationships, or other commercial loss, even if advised of the possibility of such damages.
- Any other damages, whether incidental, consequential or otherwise.
- Any claim against the customer by any other party.
- Repair or attempted repair by anyone not authorized by ViewSonic®.

Contact Information for Sales & Authorized Service (Centro Autorizado de Servicio) within Mexico:	
Name, address, of manufacturer and importers: México, Av. de la Palma #8 Piso 2 Despacho 203, Corporativo Interpalmas, Col. San Fernando Huixquilucan, Estado de México Tel: (55) 3605-1099 http://www.viewsonic.com/la/soporte/index.htm	
NÚMERO GRATIS DE ASISTENCIA TÉCNICA PARA TODO MÉXICO: 001.866.823.2004	
Hermosillo: Distribuciones y Servicios Computacionales SA de CV. Calle Juárez 284 local 2 Col. Bugambilias C.P: 83140 Tel: 01-66-22-14-9005 E-Mail: disc2@hmo.megared.net.mx	Villahermosa: Compumantenimientos Garantizados, S.A. de C.V. AV. GREGORIO MENDEZ #1504 COL, FLORIDA C.P. 86040 Tel: 01 (993) 3 52 00 47 / 3522074 / 3 52 20 09 E-Mail: compumantenimientos@prodigy.net.mx
Puebla, Pue. (Matriz): RENTA Y DATOS, S.A. DE C.V. Domicilio: 29 SUR 721 COL. LA PAZ 72160 PUEBLA, PUE. Tel: 01(52).222.891.55.77 CON 10 LINEAS E-Mail: datos@puebla.megared.net.mx	Veracruz, Ver.: CONEXION Y DESARROLLO, S.A DE C.V. Av. Americas # 419 ENTRE PINZÓN Y ALVARADO Fracc. Reforma C.P. 91919 Tel: 01-22-91-00-31-67 E-Mail: gacosta@qplus.com.mx
Chihuahua: Soluciones Globales en Computación C. Magisterio # 3321 Col. Magisterial Chihuahua, Chih. Tel: 4136954 E-Mail: Cefeo@soluglobales.com	Cuernavaca: Compusupport de Cuernavaca SA de CV Francisco Leyva # 178 Col. Miguel Hidalgo C.P. 62040, Cuernavaca Morelos Tel: 01 777 3180579 / 01 777 3124014 E-Mail: aquevedo@compusupportcva.com
Distrito Federal: QPLUS, S.A. de C.V. Av. Coyoacán 931 Col. Del Valle 03100, México, D.F. Tel: 01(52)55-50-00-27-35 E-Mail : gacosta@qplus.com.mx	Guadalajara, Jal.: SERVICRECE, S.A. de C.V. Av. Niños Héroes # 2281 Col. Arcos Sur, Sector Juárez 44170, Guadalajara, Jalisco Tel: 01(52)33-36-15-15-43 E-Mail: mmiranda@servicrece.com
Guerrero Acapulco: GS Computación (Grupo Sesicomp) Progreso #6-A, Colo Centro 39300 Acapulco, Guerrero Tel: 744-48-32627	Monterrey: Global Product Services Mar Caribe # 1987, Esquina con Golfo Pérsico Fracc. Bernardo Reyes, CP 64280 Monterrey N.L. México Tel: 8129-5103 E-Mail: aydeem@gps1.com.mx
MERIDA: ELECTROSER Av Reforma No. 403Gx39 y 41 Mérida, Yucatán, México CP97000 Tel: (52) 999-925-1916 E-Mail: rrrb@sureste.com	Oaxaca, Oax.: CENTRO DE DISTRIBUCION Y SERVICIO, S.A. de C.V. Murguía # 708 P.A., Col. Centro, 68000, Oaxaca Tel: 01(52)95-15-15-22-22 Fax: 01(52)95-15-13-67-00 E-Mail: gpotai2001@hotmail.com
Tijuana: STD Av Ferrocarril Sonora #3780 L-C Col 20 de Noviembre Tijuana, Mexico	FOR USA SUPPORT: ViewSonic® Corporation 381 Brea Canyon Road, Walnut, CA. 91789 USA Tel: 800-688-6688 E-Mail: http://www.viewsonic.com



ViewSonic®