



Complete Manual for

CeilingMIC

Conference Room Microphones

Document 411-0033-30 Rev C
February 2019

Contents

About this Manual	1
Products Covered	1
Product Compatibility	1
What's in the Box	2
A Quick Look at the CeilingMIC	2
Installation	3
Preparing for a Successful Audio Installation	3
Tools You Will Need	3
Safety Information	3
Don't Void Your Warranty!	4
Cabling Notes	4
Installing the CeilingMIC	5
Preparing the Ceiling Box	5
Preparing the Ceiling	5
Working Above the Ceiling	6
Working Below the Ceiling	6
Basic Connections	7
Operation	8
Specifications	9
Troubleshooting	10
Use, Storage, and Care	10
Compliance Statements and Declarations of Conformity	11
FCC Part 15 Compliance	11
ICES-003 Compliance	11
European Compliance	12
Warranty and Return Policy	13

About this Manual

Information in this manual includes:

- Unpacking and installation
- Operation
- Updating firmware
- Specifications
- Troubleshooting
- Warranty and compliance/conformity information

Products Covered

This manual covers:

CeilingMIC Conference Room Microphone (worldwide) – 999-85100-000 (white); 999-85150-000 (black)

The CeilingMIC System is a component of the following conferencing product bundles:

- EasyTALK USB Audio Bundle – 999-86400-000 (North America); 999-86400-001 (Europe/UK); 999-86400-009 (Australia/New Zealand)
- EasyUSB MicPod I/O with two CeilingMICs – 999-88000-000 (North America); 999-88000-001 (Europe/UK)
- EasyUSB MicPod I/O with four CeilingMICs – 999-88100-000 (North America); 999-88100-001 (Europe/UK)
- ConferenceSHOT AV System with one CeilingMIC, white – 999-99950-100W (North America); 999-99950-101W (Europe/UK); 999-99950-109W (Australia/New Zealand)
- ConferenceSHOT AV System with one CeilingMIC, black – 999-99950-100 (North America); 999-99950-101 (Europe/UK); 999-99950-109 (Australia/New Zealand)
- ConferenceSHOT AV System with two CeilingMICs, white – 999-99950-200W (North America); 999-99950-201W (Europe/UK); 999-99950-209W (Australia/New Zealand)
- ConferenceSHOT AV System with two CeilingMICs, black – 999-99950-200 (North America); 999-99950-201 (Europe/UK); 999-99950-209 (Australia/New Zealand)
- ConferenceSHOT AV Camera (no speaker) with one CeilingMIC, white – 999-99950-800W (North America); 999-99950-801W (Europe/UK); 999-99950-809W (Australia/New Zealand)
- ConferenceSHOT AV Camera (no speaker) with one CeilingMIC, black – 999-99950-800 (North America); 999-99950-801 (Europe/UK); 999-99950-809 (Australia/New Zealand)
- ConferenceSHOT AV Camera (no speaker) with two CeilingMICs, white – 999-99950-700W (North America); 999-99950-701W (Europe/UK); 999-99950-709W (Australia/New Zealand)
- ConferenceSHOT AV Camera (no speaker) with two CeilingMICs, black – 999-99950-700 (North America); 999-99950-701 (Europe/UK); 999-99950-709 (Australia/New Zealand)

Product Compatibility

The CeilingMIC conference room microphone maintains compatibility with Vaddio's products with EasyMIC connectivity:

- EasyUSB MicPOD I/O – Provides an interface to a professional conferencing mixer; connect up to four microphones.
- EasyUSB Mixer/Amp – Enables you to use one microphone or two with with a PC as a USB audio device.
- ConferenceSHOT AV – Native support for the CeilingMIC in a small to medium conference room; connect one microphone or two.
- AV Bridge MATRIX PRO – Native support for the CeilingMIC in a medium-size conference room; connect up to four microphones.

What's in the Box

Make sure you received all the items you expected.

CeilingMIC System (worldwide) – 999-85100-000 (white); 999-85150-000 (black)

- In-ceiling interface box
- Microphone body and strain-relief boot (white or black)
- Tile brace
- Trim plates, qty. 2, with mounting hardware (white or black)
- Drop-down cable (white or black)
- Small zip-tie
- Strain relief clamp
- Split grommet

Contact Vaddio Technical Support if you did not receive all the items listed.

A Quick Look at the CeilingMIC

Interface box

- Provides AEC reference from far end and applies it to each microphone element individually
- New design emphasizes simplicity and ease of connection
- Up to 100 ft. cable distance from the interface box to the connected device

Trim plates

- White or black, to match the microphone body
- Two-piece design can be installed after the rest of the installation is complete

Drop-down cable

- Matches the trim ring and microphone body
- Up to 15 ft. (4.6 m) drop-down cable length supported

Strain relief boot

- Securely grips the drop cable to prevent tension at the connector
- Split design and flexible material for easy installation
- Accommodates standard category cable; installers can build cable to length
- Clean lines for visual appeal

Microphone body

- Three-element design with improved geometry for 360° coverage with better audio pick-up
- Each microphone element features integrated echo cancellation and Digital Signal Processing (DSP), including equalization, filtering and automatic gain control (AGC)
- Easy access to the cable connector in the microphone
- New cloth-wrapped design

Note

Contact Vaddio Technical Support if your installation requires a drop-down cable longer than 15 ft. (4.6 m).



Installation

This section covers:

- Tips for a successful audio installation
- Safety information
- Tools you will need
- Cabling notes
- Installing the CeilingMIC
- Connection diagrams

Preparing for a Successful Audio Installation

Here are a few tips for avoiding common audio problems.

- The effective range for each Vaddio conference room microphone is about 12 ft. (3.7 m) under most circumstances. Be sure the room design includes enough microphones to provide adequate coverage.
- Because of the microphone geometry, sensitivity is somewhat reduced in a small area directly below the CeilingMIC. In a small to medium corporate conference room, it may make sense to suspend the CeilingMIC(s) above the centerline of the conference table.
- To prevent audio feedback, keep microphones at least 4 ft. (1.2 m) from speakers. More separation is better.
- Always place microphones closer to the people talking than to the speakers. This helps maintain quality echo cancellation.
- Do not route CeilingMIC cables across or beside fluorescent light fixtures; electrical interference from the ballasts may degrade the audio signal.
- Mount the CeilingMIC away from air vents; they can pick up the sounds of the HVAC system.
- Do not let cats play with CeilingMIC conference room microphones. (OK, that's not actually a common problem.)

Tools You Will Need

To install the CeilingMIC, you will need:

- Hole saw for the appropriate type of ceiling
- #2 Phillips screwdriver
- Wire cutters
- Tape measure
- Ladder or lift
- Appropriate personal protective equipment

Safety Information

Installing the CeilingMIC requires the use of a ladder or lift.

Warning

Follow standard safety practices when using ladders or lifts. Failure to do so can result in injury or death.



Note

All above-ceiling work must conform to local building codes and should be performed by qualified personnel.

Don't Void Your Warranty!

Caution

This product is for indoor use. Do not install it outdoors or in a humid environment without the appropriate protective enclosure. Do not allow it to come into contact with any liquid.

Do not install or operate this product if it has been dropped, damaged, or exposed to liquids. If any of these things happen, return it to Vaddio for safety and functional testing.

Cabling Notes

Caution

Do not use pass-through RJ-45 connectors. If they are crimped incorrectly, they can damage the connectors on the product, cause intermittent connections, and degrade signal quality. Physical damage to the connectors may void your warranty.

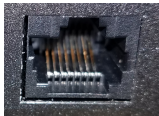

Intact – will make reliable contact with cable connector

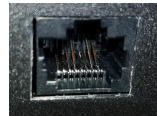

Damaged – Bent contact fingers will NOT make reliable contact with cable connector

Use Cat-5e or better cable. We recommend using high-quality connectors and a high-quality crimping tool. We recommend shielded cabling if the cables will be coiled, run tightly with other cables, or placed close sources of electromagnetic interference such as power lines.

Caution

Check your cables. Connecting a cable to the wrong port or using the wrong pin-out can result in equipment damage and will void the warranty.

Pro Tip

Label all cables at both ends.

Installing the CeilingMIC

Warning

Follow standard safety practices when using ladders or lifts. Failure to do so can result in injury or death. We like you, we don't want you to be injured or killed, and we hope you understand the gravity of the situation.

Preparing the Ceiling Box

1. Remove the cover from the ceiling box.

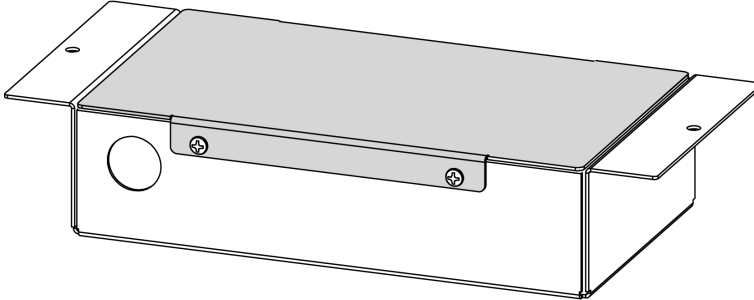

2. Determine the desired length of the drop cable, from the ceiling to the top of the microphone body (not the top of the strain relief boot). Be sure this leaves enough cable inside the ceiling box to avoid placing tension on the connector.

Note

If desired, you can use a Cat-5 cable made to the desired length for the microphone drop-down cable. The cable may be up to 15 ft. (4.6 m); contact Vaddio Technical Support if your installation requires a longer drop cable.

3. Thread the drop cable through the opening in the floor of the box.
4. Snap the strain relief grommet onto the drop cable at the desired cable length, and press it into the opening in the floor of the box.
5. Connect the drop cable to the port labeled IN FROM MIC.
6. If there is excess cable above the grommet, thread a zip tie through the tie loop in the side of the box and secure the cable.

Preparing the Ceiling

If installing in a hard ceiling:

Using the tile brace as a template, make a hole in the ceiling where the microphone will be mounted.

If installing in a suspended tile ceiling:

1. Remove the ceiling tile where the microphone will be mounted, and make a hole in the ceiling tile using the tile brace as a template.
2. Reinstall the ceiling tile and position the tile brace.

Note

Because the CeilingMIC assembly weighs very little, the tile brace does not need to be physically attached to the tile support grid unless this is required by local building codes.



Working Above the Ceiling

1. Route a Cat-5e (or better) cable from the ceiling box to the mixer or other audio device. The cable may be up to 100 ft. (30 m.) long.
2. Thread the cable through the opening in the side of the ceiling box.
3. Install the split grommet in the opening in the side of the ceiling box to keep the cable from chafing.
4. Connect the cable to the port labeled OUT TO MIXER.
5. Reinstall the cover on the ceiling box.
6. Thread the drop cable through the opening in the ceiling and place the ceiling box flat.

Working Below the Ceiling

1. Connect the drop cable to the port in the microphone body.

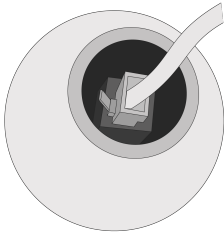

2. Fit the strain relief boot over the drop cable.
3. Fit the strain relief boot into place in the microphone body.
4. Slide both the slotted trim plates over the cable, making sure the countersinks face outward, and turn them so the slots are on opposite sides. Use the 3/4 inch flat head screws to secure the trim plates to the threaded posts on the bottom of the interface box.

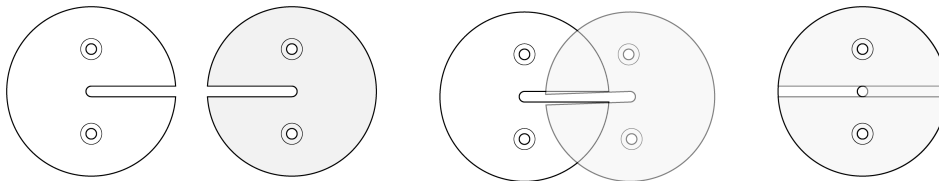

(Illustration shaded for clarity)

Contact Vaddio Technical Support if you have questions or encounter any problems. Phone 800.572.2011 / +1.763.971.4400, email av.vaddio.support@legrand.com.

Basic Connections

This is a simple installation for a small conference room, using the CeilingMIC with a ConferenceSHOT AV system. In this installation, the CeilingMIC connects to a ConferenceSHOT AV camera with speaker. The camera connects to a computer over a USB 3 connection, making audio and video available to soft conferencing applications.

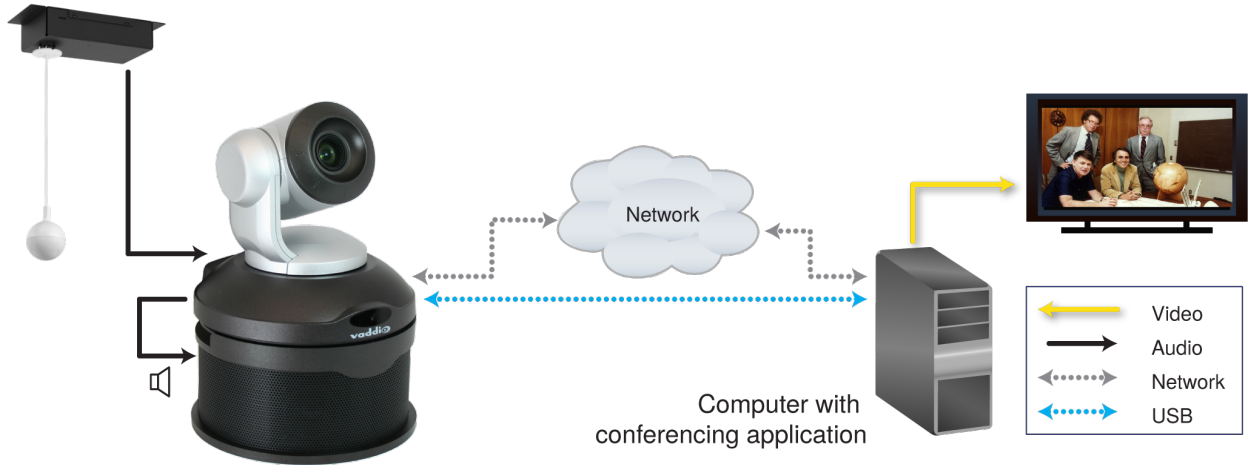

This installation is for a larger room, using an AV Bridge MATRIX PRO to manage the room audio and video. The four CeilingMIC microphones connect directly to EasyMIC ports on the AV Bridge MATRIX PRO. The speaker(s) require an amplifier, as shown by the amplifier symbol in the diagram. This system can include multiple cameras.

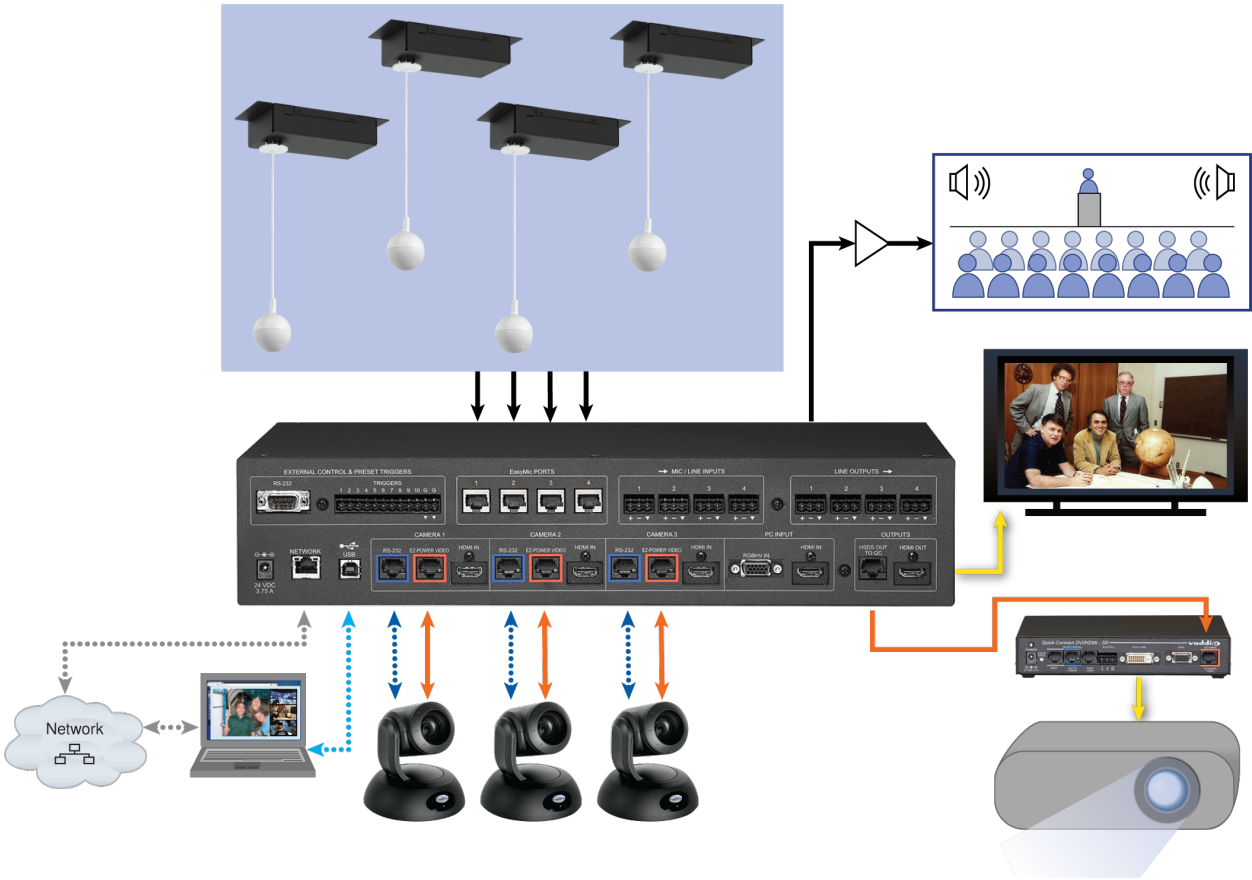

Operation

When a compatible Vaddio device is updated with firmware that supports the CeilingMIC, the device's web interface provides controls for adjusting the microphone's performance.

You can download the latest firmware updates from the product pages on our website, vaddio.com.

Specifications

Performance

Frequency Response	100 Hz to 16 KHz
THD + Noise	< 0.02%
Dynamic Range	> 90 dB

Environmental and Physical

Operating/Storage Temperature	32°F to 104°F (0°C to 40°C)
Operating/Storage Humidity	10% to 80% (non-condensing)
Maximum Cabling Distance	Drop cable: 15 ft (4.6 m) Interface box to host device: 100 ft (30 m)
Interface Box Dimensions	Length including flange: 10.25 in (26 cm) Width: 4.6 in (11.7 cm) Height: 2 in. (5.1 cm)
Microphone body dimensions	2.5 in. (6.3 cm) diameter
Installed Weight	2 lbs (0.9 kg)

Troubleshooting

What is it doing?	Possible causes	Check and correct
Nothing. Connected devices do not recognize the microphone.	The cable from the ceiling box to the AV or conferencing device is not connected, or is bad.	Verify that the cable is connected to the device.
	The drop cable is not fully seated at one end, or is bad.	Check the cable for correct pin-out and continuity.
Participants at the far end report no audio.	The microphone is muted.	If the indicator light on the CeilingMIC is on, it is muted. Unmute it from the device that controls it.
Participants at the far end report that the audio does not sound natural.	The audio has not been adjusted properly for the room.	Adjust the microphone from the device that controls it.

Use, Storage, and Care

Keep this device away from food and liquids.

Do not operate or store the device under any of the following conditions:

- Temperatures above 40°C (104°F) or below 0°C (32°F)
- High humidity, condensing or wet environments
- Inclement weather
- Severe vibration
- Going over Niagara Falls in a barrel
- Dry environments with an excess of static discharge

Do not attempt to take this product apart. There are no user-serviceable components inside.

Compliance Statements and Declarations of Conformity

Compliance testing was performed to the following regulations:

FCC Part 15 (15.107, 15.109), Subpart B	Class A
ICES-003, Issue 54: 2012	Class A
EMC Directive 2004/108/EC	Class A
EN 55032: 2015	Class A
EN 55024: November 2010	Class A
KN22 2008 (CISPR 22: 2006)	Class A
KN24 2008 (CISPR 24: 1997 + A1: 2000 + A2: 2002)	Class A
IEC 60950-1:2005 (2nd Edition); Am 1: 2009 + Am 2: 2013	Safety
EN 60950-1: 2006 + A11: 2009 + A1: 2010 + A12: 2011 + A2: 2013	Safety

FCC Part 15 Compliance

This equipment has been tested and found to comply with the limits for a Class A digital device, pursuant to Part 15, Subpart B, of the FCC Rules. These limits are designed to provide reasonable protection against harmful interference when the equipment is operated in a commercial environment. This equipment generates, uses, and can radiate radio frequency energy and, if not installed and used in accordance with the instruction manual, may cause harmful interference to radio communications. Operation of this equipment in a residential area is likely to cause harmful interference in which case the user will be required to correct the interference at his/her own expense.

Operation is subject to the following two conditions: (1) This device may not cause interference, and (2) This device must accept any interference including interference that may cause undesired operation of the device.



Changes or modifications not expressly approved by Vaddio can affect emission compliance and could void the user's authority to operate this equipment.

ICES-003 Compliance

This digital apparatus does not exceed the Class A limits for radio noise emissions from digital apparatus set out in the Radio Interference Regulations of the Canadian Department of Communications.

Le présent appareil numérique n'émet pas de bruits radioélectriques dépassant les limites applicables aux appareils numériques de la classe A prescrites dans le Règlement sur le brouillage radioélectrique édicté par le ministère des Communications du Canada.



European Compliance

This product has been evaluated for Electromagnetic Compatibility under the EMC Directive for Emissions and Immunity and meets the requirements for a Class A digital device. In a domestic environment this product may cause radio interference in which case the user may be required to take adequate measures.

Standard(s) To Which Conformity Is Declared:



EMC Directive 2004/108/EC

EN 55022: December 2010

EN 55024: November 2010

EN 61000-4-2: 1995 + Amendments A1: 1998 + A2: 2001

EN 61000-4-3: 2006 + A1: 2008

EN 61000-4-4: 2004 + Corrigendum 2006

EN 61000-4-5: 2006

EN 61000-4-6: 2009

EN 61000-4-8: 2010

EN 61000-4-11: 2004

KN22 2008 (CISPR 22: 2006)

KN24 2008 (CISPR 24: 1997 + A1: 2000 + A2: 2002)

EN 61000-4-2

EN 61000-4-3

EN 61000-4-4

EN 61000-4-5

EN 61000-4-6

EN 61000-4-8

EN 61000-4-11

IEC 60950-1: 2005 (2nd Edition); Am 1: 2009 + Am 2: 2013

EN 60950-1: 2006 + A11: 2009 + A1: 2010 + A12: 2011 + A2: 2013

Conducted and Radiated Emissions

Immunity

Electrostatic Discharge

Radiated Immunity

Electrical Fast Transients

Surge Immunity

Conducted Immunity

Power Frequency Magnetic Field

Voltage Dips, Interrupts and Fluctuations

Conducted and Radiated Emissions

IT Immunity Characteristics

Electrostatic Discharge

Radiated Immunity

Electrical Fast Transients

Surge Immunity

Conducted Immunity

Power Frequency Magnetic Field

Voltage Dips, Interrupts and Fluctuations

Safety

Safety

Warranty and Return Policy

Hardware warranty: Two (2) year limited warranty on all parts and labor for Vaddio manufactured products. Vaddio warrants its manufactured products against defects in materials and workmanship for a period of two years from the day of purchase, to the original purchaser, if Vaddio receives notice of such defects during the warranty. Vaddio, at its option, will repair or replace products that prove to be defective. Vaddio manufactures its hardware products from parts and components that are new or equivalent to new in accordance with industry standard practices.

Exclusions: The above warranty shall not apply to defects resulting from improper or inadequate maintenance by the customer, customers applied software or interfacing, unauthorized modifications or misuse, mishandling, operation outside the normal environmental specifications for the product, use of the incorrect power supply, modified power supply or improper site operation and maintenance. OEM and special order products manufactured by other companies are excluded and are covered by the manufacturer's warranty.

Vaddio Customer Service: Vaddio will test, repair, or replace the product or products without charge if the unit is under warranty. If the product is out of warranty, Vaddio will test then repair the product or products. The cost of parts and labor charge will be estimated by a technician and confirmed by the customer prior to repair. All components must be returned for testing as a complete unit. Vaddio will not accept responsibility for shipment after it has left the premises.

Vaddio Technical Support: Vaddio technicians will determine and discuss with the customer the criteria for repair costs and/or replacement. Vaddio Technical Support can be contacted by email at support@vaddio.com or by phone at one of the phone numbers listed on support.vaddio.com.

Return Material Authorization (RMA) number: Before returning a product for repair or replacement request an RMA from Vaddio's technical support. Provide the technician with a return phone number, e-mail address, shipping address, product serial numbers and original purchase order number. Describe the reason for repairs or returns as well as the date of purchase. See the General RMA Terms and Procedures section for more information. RMAs are valid for 30 days and will be issued to Vaddio dealers only. End users must return products through Vaddio dealers. Include the assigned RMA number in all correspondence with Vaddio. Write the assigned RMA number clearly on the shipping label of the box when returning the product. All products returned for credit are subject to a restocking charge without exception. Special order products are not returnable.

Voided warranty: The warranty does not apply if the original serial number has been removed or if the product has been disassembled or damaged through misuse, accident, modifications, use of incorrect power supply, use of a modified power supply or unauthorized repair.

Shipping and handling: Vaddio will not pay for inbound shipping transportation or insurance charges or accept any responsibility for laws and ordinances from inbound transit. Vaddio will pay for outbound shipping, transportation, and insurance charges for all items under warranty but will not assume responsibility for loss and/or damage by the outbound freight carrier. If the return shipment appears damaged, retain the original boxes and packing material for inspection by the carrier. Contact your carrier immediately.

Products not under warranty: Payment arrangements are required before outbound shipment for all out of warranty products.

General RMA Terms and Procedures: RMA's are valid for 30 days and will be issued to Vaddio dealers only.

- End users must return products through Vaddio dealers.
- Before a defective product can be authorized to send in for repair, it must first go through the troubleshooting process with a member of the Vaddio Technical Support team.
- Products authorized for repair must have a valid RMA (Return Material Authorization) number.
 - Vaddio RMA Team will issue the RMA number.
 - An RMA number is to be included in all correspondence with Vaddio.
 - The RMA number must appear clearly on the shipping label (not the box) when the product is returned.
 - A packing slip must be included on the inside of the box with the RMA number listed and reason for RMA return.
- Products received at Vaddio that do not have a valid RMA number clearly marked on the outside of the shipping container may be refused and returned to sender.
- Boxes showing external damage will be refused and sent back to the sender regardless of the clearly marked RMA number and will remain the responsibility of the sender.

RMA Charges (Restocking): All qualified returns must be made in unopened, original packaging with all original materials.

- Initial shipments of equipment that are refused upon attempted delivery, for any reason, are subject to restocking charges.
- The Dealer has up to 60 days from the date of purchase to return Vaddio product for credit for future purchases of Vaddio product only.
- The Dealer has 61 to 90 days from the date of purchase to return Vaddio product with a 15% restocking fee or \$50.00 fee, whichever amount is greater
- The Dealer has up to 30 days from the date of purchase to return OEM and other manufacturer's products with a 15% restocking fee or \$50.00 fee, whichever amount is greater.
- NOTE: Special Order products from other manufacturers (identified in the Vaddio Price Guide as noncancelable, nonreturnable and not refundable) are not eligible for advance replacement from Vaddio.

Advance Replacement Policies: For Vaddio manufactured products, advance replacement will be provided for up to one (1) year after the initial shipment of products.

- NOTE: OEM and other manufacturer's products are excluded from the Vaddio advance replacement policy. Advance replacement will be provided for up to 30 days after initial shipment of OEM products. Thereafter, a return to Vaddio and factory repair is offered during the other manufacturer's warranty period. Vaddio will determine if the returned product is qualified for the OEM warranty.
- NOTE: Special Order products from other manufacturers (identified in the Vaddio Price Guide as noncancelable, nonreturnable and not refundable) are not eligible for advance replacement from Vaddio.

Advance Replacement Procedures: The Vaddio Dealer must submit a non-revocable purchase order for advance replacement equipment at normal dealer pricing. Credit shall be issued upon complete product return (including all accessories) for dealers with Net 30 terms. For credit card accounts, charges will be assessed to the credit card for the replacement and credited back upon complete product return.

- Returns must be made in the original Vaddio packaging with all original materials if at all possible. Vaddio products with missing original materials will be billed to the dealer at dealer price.
- NOTE: OEM products must be returned in the original packaging with all materials and the RMA number written on the shipping label only and not on the OEM box. If the return is incomplete and/or the OEM box is defaced, the product shall be returned to the dealer and the RMA will not be credited.
- Equipment returned with “No Trouble Found” after advanced replacement will be assessed a full 15% or \$50.00 restocking fee (whichever is greater) for each item and may also be assessed for additional charges to compensate for wear, damages and reconditioning.
- All returns must be accompanied by RMA # as stated above.
- All Advanced Replacement products are sent via 2-day service in the continental USA. If the product is requested to be sent via priority or overnight shipping, the Dealer shall pay shipping costs. The dealer can elect to supply their preferred shipping account number.
- International customers are responsible for all freight charges for equipment returned to Vaddio, including international shipping, taxes, and duties, insurance and all other associated logistic charges.

Warranty Repair Terms and Procedures: Vaddio will repair any product free of charge, including parts and labor, within the terms outlined in the warranty agreement for that product.

- Customers must provide proof of the product’s purchase date.
- Product that is within the warranty period will be repaired under the non-warranty terms if:
 - The equipment has been damaged by negligence, accident, act of God, mishandling, used with the incorrect, modified or extended power supply or has not been operated in accordance with the procedures described in the operating and technical instructions.
 - The equipment has been altered or repaired by other than the Manufacturer or an authorized service representative.
 - Adaptations or accessories other than those manufactured or provided by the Manufacturer have been made or attached to the equipment, which in the determination of the Manufacturer, shall have affected the performance, safety or reliability of the equipment; or the equipment’s original serial number has been modified or removed.
- Customer is responsible for shipping charges to send defective product under warranty to Vaddio. Vaddio will pay ground service return shipping charges during the 2nd year of the warranty period.
- Standard return shipping method for products under warranty, but out of the advance replacement warranty period, is ground shipment. Extra charges associated with priority shipping, when requested, will be the responsibility of the customer.

Non-Warranty Repair Terms: Vaddio will repair any non-obsolete product that does not meet the terms of the warranty. Non-warranty repair terms are as follows:

- The customer is responsible for, and agrees to pay, all parts and labor costs associated with the repair. Standard non-warranty repair charges are outlined below.
- Customers must provide payment method and one of the following, prior to receiving an RMA:
 - Hard copy of a PO, for dealers with Net 30 terms and in good standing with Vaddio.
 - Valid credit card number - Credit card will be charged upon shipping repaired product back to customer.
- Request for COD: Customers will be notified of COD charges prior to shipping repaired unit.
- Customer is responsible for all shipping charges both to and from Vaddio, and may use their own carrier.
- Customers will receive a courtesy call notifying them of total repair charges prior to return shipping.

Non-Warranty Repair Charges: Total repair charges (per unit) for a non-warranty repair consist of the following:

- Cost of any replacement parts needed to repair the defect.
- Labor costs billed per hour after minimum charges/time.
- Labor charges include troubleshooting and repair time only.
- Burn-in time and final test time is not included in the labor charges.
- Labor time is rounded to the nearest quarter hour.
- Labor charges are billed at the prevailing rate for the category of equipment repaired, after minimum charges/time. For prevailing labor rates, please contact the Vaddio technical support.
- All shipping and handling costs are the responsibility of the customer for non-warranty repairs.

Minimum Labor Charges: All non-warranty repairs are subject to a minimum evaluation/repair labor charge even if there is no problem found. Please contact Vaddio technical support for the current applicable rate.

Repair Charge Estimates: Estimates on repair charges for a specific problem will not be given before an RMA is issued and the actual product has been evaluated by a Vaddio technician. Repair estimates will be given after the repair department receives and evaluates the unit.

- Customers requesting an estimate on repair charges must do so up front when they call in for an RMA. The RMA team will call or email with the estimate after evaluating the unit and before proceeding with the repair.
- Any product evaluated for a repair estimate is still subject to the minimum labor charges even if the customer decides not to proceed with the repair.
- Vaddio does not guarantee estimates given on repair charges. Actual repair costs may exceed the estimate.
- Customer is responsible for actual repair charges, regardless of estimate.

Repair Policy Notes:

- **Duration of Repair:** Products are repaired on a first come first serve basis. The turn-a-round time of a particular repair is dependent upon circumstances such as product type, the nature of the problem and current repair volumes. Requests for expedited repair service will be considered on a case-by-case basis.
- **Repair Warranty:** Vaddio guarantees all of its repair work, performed on non-warranty items, for 90 days from the day the repaired product is shipped back to the customer. If the original problem described was not resolved or reoccurs within the 90-day period, Vaddio will repair the unit free of labor charges. However additional material charges may apply unless the parts used to affect the repair are again deemed defective.

Vaddio is a brand of Legrand AV Inc. · www.legrandav.com · Phone 800.572.2011 / +1.763.971.4400 · Fax +1.763.971.4464 · Email av.vaddio.support@legrand.com

Visit us at support.vaddio.com for firmware updates, specifications, drawings, manuals, technical support information, and more.

©2019 Legrand AV Inc.

Vaddio is a registered trademark of Legrand AV Inc. All other brand names or marks are used for identification purposes and are trademarks of their respective owners. All patents are protected under existing designations. Other patents pending.

A brand of  legrand®

Commercial AV Brands Chief | Da-Lite | Middle Atlantic | Projecta | Vaddio

vaddio®