



Complete Manual for

ConferenceSHOT 10

Enterprise-Class PTZ Conferencing Camera

Document 411-0002-30 Rev C
October 2019

Contents

Overview	1
What's in this Guide	1
Features	1
Unpacking the Camera	2
A Quick Look at the Camera	3
Front of the Camera	3
Back of the Camera	4
Installation	5
Don't Void Your Warranty!	5
Before You Install the Camera	5
Installing the Wall Mount	6
About Ceiling-Mounted Cameras	6
Camera Behavior Settings	7
RS-232 Serial Communication Settings	8
RS-232 Connector Pin-Out	8
Cabling Notes	8
Connecting the Camera	9
Installing the Camera	10
Powering Up the Camera	11
Status Indicator Light	11
Using the Remote Control	12
Quick Reference	12
IR Remote Details	13
Storing a Preset Using the Remote	13
Clearing a Preset Using the Remote	13
Using the Web Interface	14
Browser Support	14
Getting the Camera's IP Address	14
User Access	16
Administrative Access	16
Compact Menu View	17
System Administration	18
Configuring the Camera for Your Network	18
For Non-DHCP Environments: Configuring the Device with a Static IP Address for Initial Installation	19
Optional For DHCP Environments: Changing from a DHCP Address to a Static IP Address	21
Changing the Camera's Hostname	21
Specifying Time Zone and NTP Server	22
Setting Passwords and Access	23
Adding Room Information to the Screen	24

Saving (Exporting) or Restoring (Importing) a Configuration	24
Installing a Firmware Update	26
Rebooting the Camera	27
Contacting Vaddio Technical Support	28
Viewing Diagnostic Logs	28
Configuring Camera Behavior	29
Setting the Home Position and Other Preset Shots	29
Renaming Presets	31
Adjusting the Color and Image Quality Settings	31
Lighting and Image Quality Quick Reference	32
Color Adjustment Quick Reference	32
Adjusting the Focus	33
Speed Adjustments	33
Setting the Speeds for Manual Movements	34
Setting the Speeds of Movements to Presets	34
Setting the Direction for Camera Movements	35
Configuring Streaming Behavior	36
Enabling or Disabling Streaming	36
Viewing a Stream	37
Configuring USB Streaming	37
Setting up IP Streaming in Easy Mode	38
Setting up IP Streaming in Custom Mode	39
RTSP Streaming Protocol and URL	40
Changing MTU	40
Reading the Camera's Switches	41
Additional Camera Settings	41
Operating the Camera	42
Stopping or Resuming Video	42
Managing the Camera Ready State	43
Moving the Camera	43
Zooming In or Out	43
Moving the Camera to a Preset Position	43
Telnet Serial Command API	44
camera home	45
camera pan	45
camera tilt	46
camera zoom	47
camera focus	48
camera preset	49
camera ccu get	50
camera ccu set	51

camera led	52
camera recalibrate	52
camera standby	53
video mute	53
streaming settings get	54
network settings get	55
network ping	55
system reboot	56
system factory-reset	56
history	57
version	57
help	57
exit	58
RS-232 Control	58
Camera Movement, Zoom, and Focus Commands	58
Movement, Zoom, and Focus Inquiry Commands	60
Color and Light Management Commands	61
Shutter Speed Values (CAM_Shutter)	63
Iris Values (CAM_Iris)	64
Iris Gain and Gain Limit Values (CAM_Gain)	64
Color and Light Management Inquiry Commands	65
Other Commands	65
Other Inquiry Commands	66
Specifications	67
Troubleshooting and Care	68
Power and Control	68
Video and Streaming	68
Other Issues	69
Status Indicator Light	69
Correct a Motor Calibration Error	70
Restoring Default Camera Settings	71
Operation, Storage, and Care	71
Glossary	72
Compliance and Conformity Statements	75
FCC Part 15 Compliance	75
ICES-003 Compliance	75
European Compliance	76
Warranty and Return Policy	77
Photo Credits	81
Index	82

Overview

This guide covers the ConferenceSHOT™ 10 enterprise-class PTZ conferencing camera:

- North America – 999-9990-000 (silver/black), 999-9990-000W (white)
- Europe and UK – 999-9990-001 (silver/black), 999-9990-001W (white)
- Australia and New Zealand – 999-9990-009 (silver/black), 999-9990-009W (white)

What's in this Guide

This guide covers

- Unpacking
- Physical features
- Switch settings
- Installation
- Controlling the camera using the IR remote
- Web interface: System administration and performance/behavior configuration
- Telnet and RS-232 API references
- Specifications
- Troubleshooting
- Warranty and compliance/conformity information

For your convenience, the information you need to install this product is also available in the smaller, stand-alone **Installation Guide for the ConferenceSHOT 10 Enterprise-Class PTZ Conferencing Camera**.



Features

- 2.14 Megapixel effective, native 1080p/60 full HD image sensor
- 10x optical zoom, horizontal field of view of 74° in super-wide mode
- Simultaneous uncompressed USB 3.0 and IP (H.264) streaming outputs at resolutions up to 1080p/60
- Selectable IP stream resolution; USB stream resolution auto-negotiated with conferencing client
- Precise pan and tilt movements at up to 90° per second
- Universal Video Class (UVC) drivers supported in Windows®, macOS®, and Linux operating systems, compatible with most UC conferencing applications
- Integration-ready Telnet and serial RS-232 control
- Full administrative control via web interface; manage the camera remotely while monitoring the stream separately
- Presenter-friendly IR remote control

Unpacking the Camera

Make sure you received all the items you expected. Here are the packing lists for the ConferenceSHOT 10 cameras.

Caution:

Use the power supply shipped with the camera. Using a different power supply may create an unsafe operating condition or damage the camera, and will void the warranty.

Caution

Always support the camera's body when lifting or moving it. Lifting the camera by its head or mounting arm will damage it.



ConferenceSHOT 10 Camera

North America: 999-9990-000 (silver/black), 999-9990-000W (white)

Europe and UK: 999-9990-001 (silver/black), 999-9990-001W (white)

Australia and New Zealand: 999-9990-009 (silver/black), 999-9990-009W (white)

The box should contain one of each item listed here:

- Camera (silver/black or white)
- Vaddio IR Remote Commander
- 12 VDC, 3.0 Amp switching power supply with AC cord set(s)
- Thin Profile Wall Mount with mounting hardware
- RS-232 control adapter
- USB 3.0 Type A to Type B cable, 6 ft. (1.8m)
- Quick-Start Guide



A Quick Look at the Camera

This section covers the physical features of the camera.

Front of the Camera



Camera and zoom lens – The ConferenceSHOT 10 camera features a 10X optical zoom lens (11X in Super-Wide mode).

IR sensor – Receives signals from the IR remote. Make sure there's nothing directly in front of the camera base, and point the remote at the camera.

Status light – The multi-colored LED indicates the camera's current state. This light can be turned off in the administrative web interface.

Note

By default, the camera's status indicator light is active during normal operation; however, it can be configured to remain off when the camera is powered up. The camera may be sending video even if the light is off.

Back of the Camera



- **12 VDC, 3.0 A** – EIAJ-04 jack. Connect only the power supply shipped with the camera or approved replacement 12 VDC, 3A power supply.
- **USB 3.0** – USB Type B connector. Connect to a computer for use with soft conferencing applications. Provides uncompressed USB 3.0 stream.
- **Ethernet** – RJ-45 connector. Connect to the network for IP streaming and camera control via web interface or Telnet.
- **Camera Settings** – DIP switches to set camera behaviors such as IR frequency, image flip (camera is invertible), normal or Super-Wide mode, and baud rate. See [Camera Behavior Settings](#).
- **RS-232** – RJ-45 connector. Connect to a controller to manage the camera using a modified VISCA protocol.

Installation

This section covers:

- Selecting the location for the camera
- Installing the mount
- Connection diagrams
- Connecting and mounting the camera

Don't Void Your Warranty!



Caution

Always support the camera's body when lifting or moving it. Lifting the camera by its head or mounting arm will damage it.

Caution

This product is for indoor use. Do not install it outdoors or in a humid environment without the appropriate protective enclosure. Do not allow it to come into contact with any liquid.

Caution

Use the power supply included with the camera or recommended for use with it. Always check the output voltage listed on the power supply label, as power supplies of different voltages may look nearly identical. Using the wrong power supply will void the warranty, possibly causing unsafe operating conditions and damage to the product.

Caution

Do not install or operate this product if it has been dropped, damaged, or exposed to liquids. If any of these things happen, return it to Vaddio for safety and functional testing.

Before You Install the Camera

Things to keep in mind when deciding where to install the camera:

- Consider camera viewing angles, lighting conditions, line-of-sight obstructions, and in-wall obstructions where the camera is to be mounted.
- Ensure that the camera body can move freely and will normally point away from the ceiling and lights. The camera will not perform well if it is pointed toward a light source such as a light fixture or window.
- If the remote will be used, ensure that nothing blocks the IR lens in the camera's base.

Prepare for a successful installation:

- Be sure you can identify all cables correctly.
- Check Cat-5 cables for continuity.
- Ensure that the Settings switches are set appropriately.
- Talk to the network administrator. If installing the camera in a non-DHCP network (one that does not automatically assign IP addresses), you will need to configure the camera with a static IP address as directed by the network administrator.

Installing the Wall Mount

The camera is shipped with a wall mount. Other mounting options are available as well. Contact us if you don't have the camera mount you need.

You can install the camera wall mount to a 2-gang wall box or directly to the drywall.

- If you mount it to drywall, use the wall anchors provided with the wall mount.
- If you mount it to a wall box, use the cover plate screws supplied with the wall box.

If you install the camera wall mount to drywall, use the wall anchors provided with the mount.

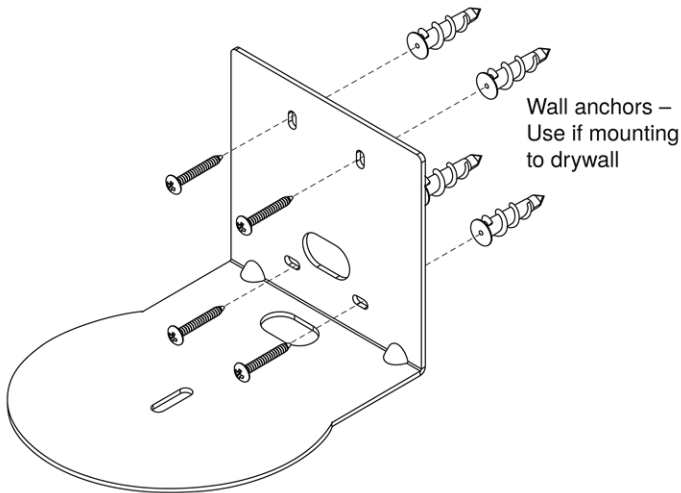

About Ceiling-Mounted Cameras

If you use an inverted mount, set the camera's Image Flip DIP switch ON for inverted operation. This orients the video image correctly and sets the tilt motors to respond appropriately to tilt up and down commands from the remote, web interface, and connected control devices. See [Switch Settings](#) for more information.

Camera Behavior Settings

The camera uses DIP switches to determine certain camera functions.

Note

When the camera is not inverted, DIP switches are in their default positions when they are up.

IR Frequency Selection: If there are multiple cameras in the room, use **switches 1 and 2** to configure each with a different IR frequency to allow the IR Remote Commander to control them independently. Then use the Camera Select buttons at the top of the remote to select the camera you want to control.

- SW1 and SW2 up: IR frequency 1
- SW1 down, SW2 up: IR frequency 2
- SW1 up, SW2 down: IR frequency 3

Inverted operation: If mounting the camera upside-down, set **switch 3** to the DOWN position: IMAGE FLIP ON. This orients the video image correctly and sets the tilt motors to respond appropriately to tilt up and down commands from the remote, web interface, and connected control devices.

Switch 4 is not currently used.

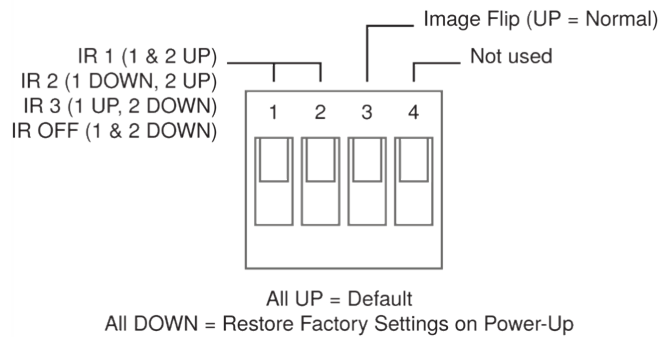

A label on the bottom of the camera provides a quick reference for setting the DIP switches.

RS-232 Serial Communication Settings

The RS-232 serial port (RJ-45, color-coded blue) on the camera's back panel enables third-party control.

Parameter	Value
Communication Speed	9600 bps or 38400 bps, switch-selectable
Number of start bits	1
Number of stop bits	1
Number of data bits	8
Parity	None
Flow control	None

RS-232 Connector Pin-Out

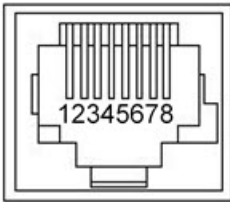

Connector pin-out:

- Pin 1: Not used
- Pin 2: Not used
- Pin 3: Not used
- Pin 4: Not used
- Pin 5: Not used
- Pin 6: GND
- Pin 7: RXD (from TXD of control source)
- Pin 8: TXD (to RXD of control source)

Caution

Check your cables. Connecting a cable to the wrong port or using the wrong pin-out can result in equipment damage and will void the warranty.

Cabling Notes

Caution

When building cables for Vaddio products, do not use pass-through RJ-45 connectors. If they are crimped incorrectly, they can cause intermittent connections and degrade signal quality. Incorrectly crimped pass-through connectors can also damage the connectors on the product, which will void your warranty.



Intact – will make reliable contact with cable connector

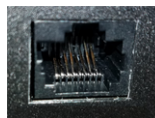

Damaged – Bent contact fingers will NOT make reliable contact with cable connector

Use Cat-5e or better cable. We recommend using high-quality connectors and a high-quality crimping tool. We recommend shielded cabling if the cables will be coiled, run tightly with other cables, or routed near sources of electromagnetic interference such as power lines or fluorescent light fixtures.

Caution

Check your cables. Connecting a cable to the wrong port or using the wrong pin-out can result in equipment damage and will void the warranty.

Pro Tip

Label all cables at both ends.

Connecting the Camera

Here is an example of how the camera might be set up in a medium-size conference room. In this setup, a PC uses a unified communications conferencing application to manage the camera and an EasyUSB Mixer/Amp with attached microphones and speakers.



Note

ConferenceSHOT 10 camera output is USB 3.0; EasyUSB Mixer/Amp is USB 2.0.

Installing the Camera

Caution

Before you start, be sure you can identify all cables correctly. Connecting a cable to the wrong port can result in equipment damage.

Caution

Check your cables. Connecting a cable to the wrong port or using the wrong pin-out can result in equipment damage and will void the warranty.

1. Verify that you have set the switches on the back of the camera to the desired settings.
2. Route the cables through the opening in the mounting shelf and connect them to the camera.

Caution:

Use the power supply shipped with the camera. Using a different power supply will damage the camera and void the warranty, and may create an unsafe operating condition.

3. Place the camera on the mount.

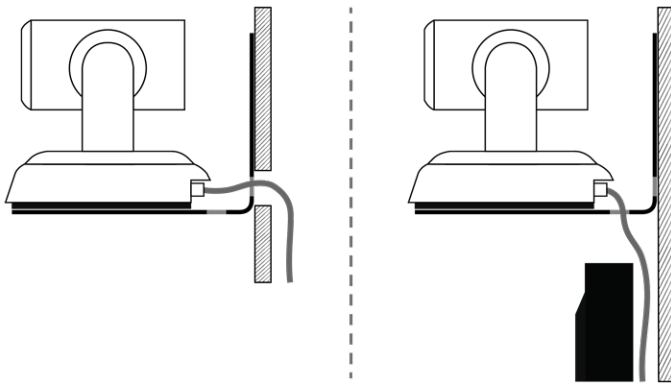

4. Attach the camera to the mount using the mounting screw supplied with the camera.

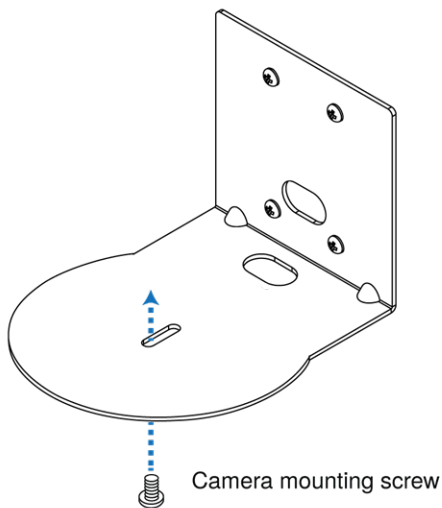

Image for illustration only; not to scale. Camera and mount details may differ.

Note

If the camera is jostled or bumped, it may require a pan-tilt reset.

Powering Up the Camera

Connect camera power. The camera will initialize and move. This will take a few seconds. When an image is available, the camera is ready to accept control information.

Status Indicator Light

The light in the camera's base indicates its current state.

- Blue – Camera is active
- Purple – Standby mode or booting
- Yellow – Firmware update is in progress
- Blinking blue – USB cable is disconnected (UC color scheme)
- Blinking red – Video mute is on (UC color scheme)
- Blinking yellow – Motor out of calibration

Caution

Do not remove power or reset the camera while the indicator is yellow, showing a firmware update in progress. Interrupting a firmware update can make the camera unusable.

Note

By default, the camera's status indicator light is active during normal operation; however, it can be configured to remain off when the camera is powered up. The camera may be sending video even if the light is off.

Using the Remote Control

The remote provides basic camera control.

Quick Reference

What do you need to do?	Button(s)
Power on or standby	Power (green button at top right)
Select the camera to control (if this remote controls more than one)	Camera Select buttons 1 through 3 (second row on the remote)
Discover the camera's IP address	Data Screen button (top left) – press and hold for 3 seconds
Move the camera	Arrow buttons and Home button (dark red)
Move the camera to a preset position	Position Preset buttons 1 through 6 (bottom two rows)
Focus the camera	Auto Focus button (near arrow buttons) Manual Focus buttons Near and Far (below Zoom Speed buttons)
Change zoom	Zoom buttons – T (telephoto – zoom in) and W (wide-angle – zoom out), slow and fast zoom speeds (center)
Adjust for excess light behind the camera's subject	Back Light button (top center)
Correct a motor calibration fault condition (blinking yellow light)	Pan-Tilt Reset button (center right, beside arrow buttons)

IR Remote Details

The remote provides the following functions:

Data Screen – Press and hold for 3 seconds to display the camera’s IP address and MAC address on the near-end display. Press momentarily to dismiss the information.

Power indicator – Shows power on, IR transmission, and battery level.

Power – Switch the selected camera on or off.

Back Light – Use or turn off back light compensation.

Camera Select – In multi-camera installations, selects the camera to be controlled. See [Switch Settings](#) for information on configuring the camera as camera 1, 2, or 3.

Pan/Tilt (arrow button) controls and Home button – Control the camera’s position.

Std. Pan and Rev. Pan – Control how the camera responds to the arrow buttons. Helpful for ceiling-mounted cameras and installations where the camera will point at the person using the remote.

Pan/Tilt Reset – Recalibrate the pan and tilt motors. If the camera gets jostled, you may need to push this button to ensure that the camera moves accurately to its home and preset positions.

Auto Focus – Switch the camera to Auto-Focus mode.

Zoom Speed – Select Slow or Fast movements.

- **T** (slow and fast) – Telephoto (zooms in)
- **W** (slow and fast) – Wide-angle (zooms out)

Manual Focus – Switch the camera to Manual Focus mode.

Near (-) adjustment – Moves the focus nearer when in manual focus mode.

Far (+) adjustment – Moves the focus farther when in manual focus mode.

Position Presets 1 through 6 – Move the camera to a predefined position.

Preset – Save the camera’s current position as one of the numbered presets.

Reset – Clear the saved position presets.

The web interface offers greater control over camera movements to presets, and provides additional presets.

Storing a Preset Using the Remote

Set up the shot using the pan, tilt, and zoom controls. Then hold down the **Preset** button and press one of the numbered preset buttons.

Clearing a Preset Using the Remote

Press and hold the **Reset** button while pressing the preset number you want to clear.



Using the Web Interface

The camera's web interface allows control via a network connection, using a browser. Password-protected pages provide administrative access to tasks such as setting passwords, changing the IP address, viewing diagnostics, and installing firmware updates. The user login (or guest access, if it is enabled) provides access to camera controls similar to those available from the IR remote.

You will need to know the camera's IP address to use the web interface. If the IP network has a DHCP server, the camera will get its IP address, gateway and routing information automatically and you will be able to browse to it. If not, you will need to configure the camera to use a static IP address.

Browser Support

We have tested this product with these web browsers:

- Chrome®
- Firefox®
- Microsoft® Edge and Internet Explorer®
- Safari®

We test using the browser version available from the vendor at that time. Other browsers (including older versions of the ones on this list) are likely to work also.

Getting the Camera's IP Address

You will need to be able to view the camera's video output.

If video is available from the camera:

1. Press the Data Screen button on the remote. The display presents the camera's IP address and MAC address.
2. Press the Data Screen button again to dismiss the information.

If you cannot yet view video from the camera:

1. Connect the camera to the network, and connect the camera's USB cable to your computer. Then power up the camera. If necessary, your computer loads the appropriate USB driver.
2. Open a media player such as VLC Media Player and view the USB stream (If you use VLC Media Player, this is the "Open Capture Device" option under Media.). The camera is available as a video capture device; the device name is ConferenceSHOT 10.

The screen shots below show how you would access the USB stream using VLC Media Player.

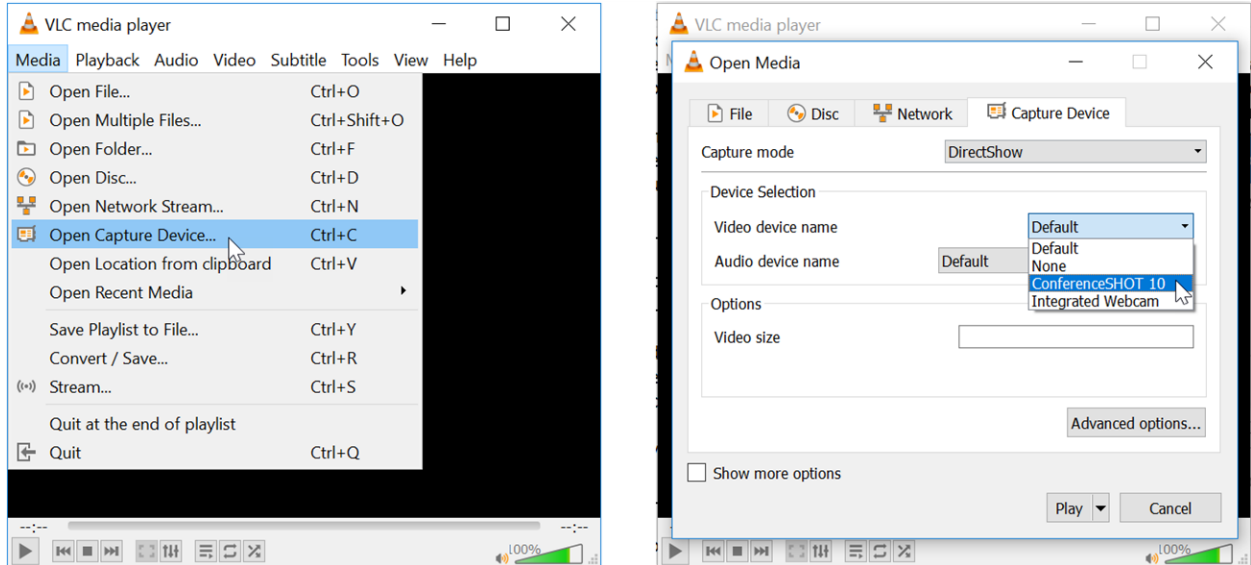

3. Point the remote at the camera and press the Data Screen button. The camera overlays its IP address and MAC address on the video output.
4. Press the button again to dismiss the information display.

If the address is 169.254.1.1:

This is the camera's default IP address. This usually means one of these things:

- The network automatically assigns IP addresses, but the camera is not connected to the network.
- The network does not automatically assign IP addresses, and you need to configure the camera for the network. See [Configuring the Camera with a Static IP Address](#).

Any other IP address means that your camera is available on the network.

If the camera is at another IP address:

Enter the IP address or hostname in your browser's address bar. You may need to enter `http://` or `https://` as a prefix to keep the browser from treating it as a search query.

(Example: `http://10.30.200.125`)

User Access

By default, the web interface opens to the operator's page, but the camera can be configured to require a user login. Check with the system administrator if the camera's web interface requires you to log in.

Only the operator's page is available with user-level access.

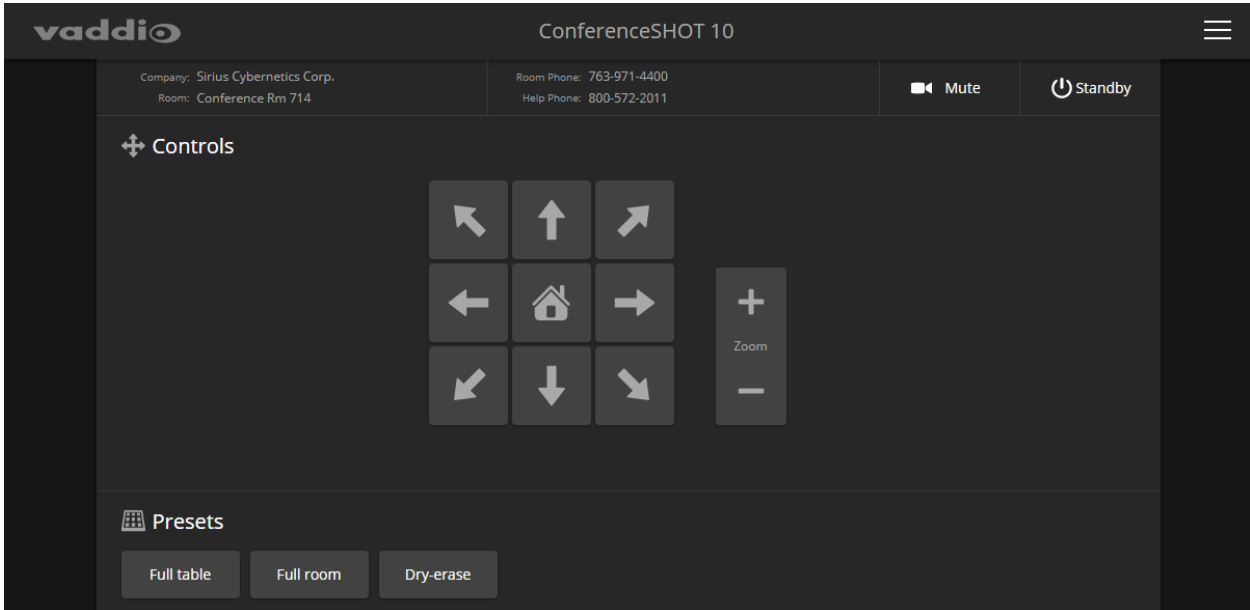

Your camera's web interface may look somewhat different.

Administrative Access

If you are on the Controls screen, you're logged in at the user level, or guest access is enabled and you're not logged in at all. For access to system administration and performance/behavior configuration tasks, open the menu to log in as admin. For cameras using firmware released before late 2019, the default admin password is **password**.

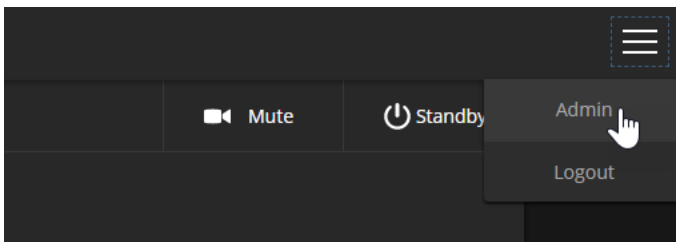

Note

For best security, change the user and admin passwords from the default. Using the default passwords leaves the product vulnerable to tampering. Be sure you have a way to remember the passwords after changing them.

System administration tasks are on these pages:

- Network
- Security
- Room Labels
- System
- Help
- Diagnostics

Performance and behavior configuration tasks are on these pages:

- Camera
- Streaming
- System

Compact Menu View

By default, the navigation buttons in the camera's administrative interface display an icon and a text label. You can also select the compact view of the menu buttons instead of the standard view. The button at the bottom of the menu toggles between the two views.

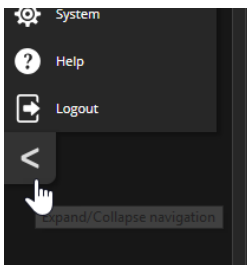

System Administration

This chapter covers settings for managing the camera as an element of your network.

System administration

What do you need?	Go to this page
Passwords and access management	Security
IP address, hostname, and other network settings	Networking
Settings related to date and time	Networking
Information about the camera <ul style="list-style-type: none"> ■ Room location and phone number ■ Help desk phone number 	Room Labels

Maintenance and Troubleshooting

What do you need?	Go to this page
<ul style="list-style-type: none"> ■ Update camera firmware or view the current firmware version ■ Save (export) and restore (import) the camera's configuration ■ Reboot or reset to factory defaults 	System: Firmware
Camera adjustment: Recalibrate pan and tilt motors	System : Firmware
Locate Vaddio Technical Support contact information	Help
View diagnostic logs	Diagnostics

See [Configuring Camera Behavior](#) for information on image adjustments, streaming configuration, and other items related to camera behavior.

Note

Vaddio's cameras have very similar web interfaces. Some of the screen shots in this manual may be from other models of camera.

Configuring the Camera for Your Network

By default, the camera is set to DHCP, and will receive an IP address automatically if your network assigns IP addresses. In this type of environment, the camera is available for use immediately, without any network configuration. However, you may find it helpful to make certain changes; and most organizations have policies concerning hostnames, static address assignments for certain equipment, and other aspects of network configuration.

Work with your network specialist to ensure that the camera is configured to comply with the organization's network policies.

For Non-DHCP Environments: Configuring the Device with a Static IP Address for Initial Installation

NETWORKING PAGE

If the camera is currently at an IP address other than 169.254.1.1, skip this section.

If no DHCP server is available to automatically assign an IP address, the camera will use the default IP address of 169.254.1.1. If this is the case, you may need to follow this procedure. If you also need to install another camera or other device on this network, you *will* need to do this to prevent IP address conflicts.

Caution

Consult your IT department before editing network settings. Errors in network configuration can make the camera inaccessible from the network. Do not change DHCP/Static addressing, IP address, subnet mask, or gateway unless you are very familiar with the characteristics and configuration of the network where you install the camera.

To access the camera's Networking page during installation:

Skip this procedure if the camera has already been in service on this network

1. Connect the camera according to the connection diagram, but *do not connect the camera to the network*.
2. Connect the network port on the camera to the network port on a computer. Depending on the computer, you may need a crossover cable.
3. On the computer, open a browser and access the camera's web interface at <http://169.254.1.1>.
4. Log in as admin. For cameras using firmware released before late 2019, the default password is **password**.

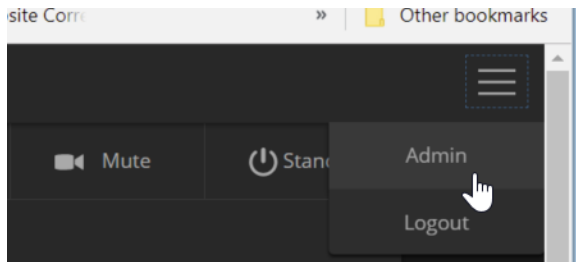

5. Navigate to the Networking page.

Your camera's web interface may look slightly different from these screen shots.

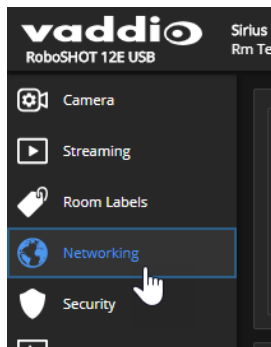

To configure the camera with a static IP address:

1. Work with your IT department to determine the correct IP address, subnet mask, and gateway to assign.
2. On the Networking page, set IP Address to Static.
3. Enter the IP address, subnet mask, and gateway as directed by the IT staffer; then save your work. The camera is now ready to be connected to the network.

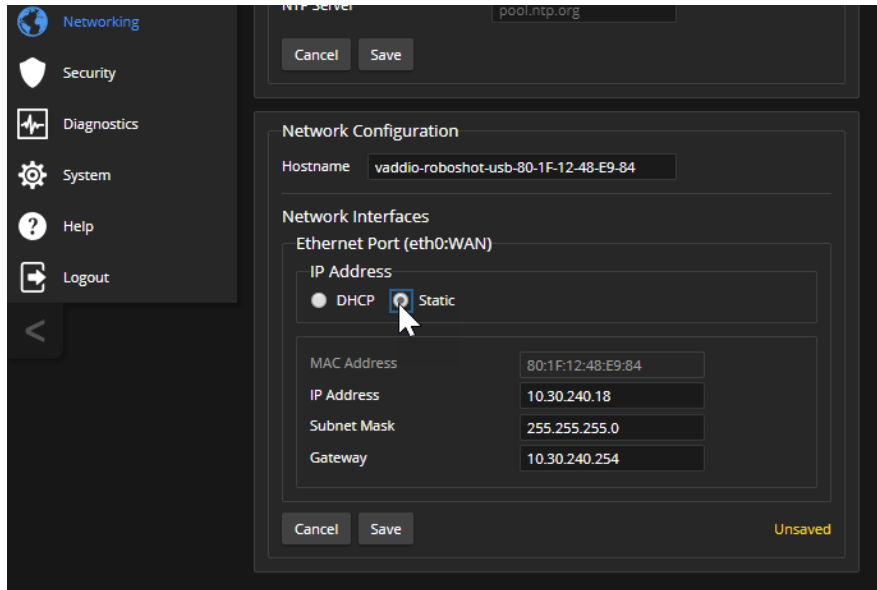

Optional For DHCP Environments: Changing from a DHCP Address to a Static IP Address

NETWORKING PAGE

In a network that assigns IP addresses automatically, the camera's IP address may change from time to time. To keep this from happening, set the IP address to Static. *Do not change the IP address, subnet mask, or gateway unless your IT staff instructs you to do so.*

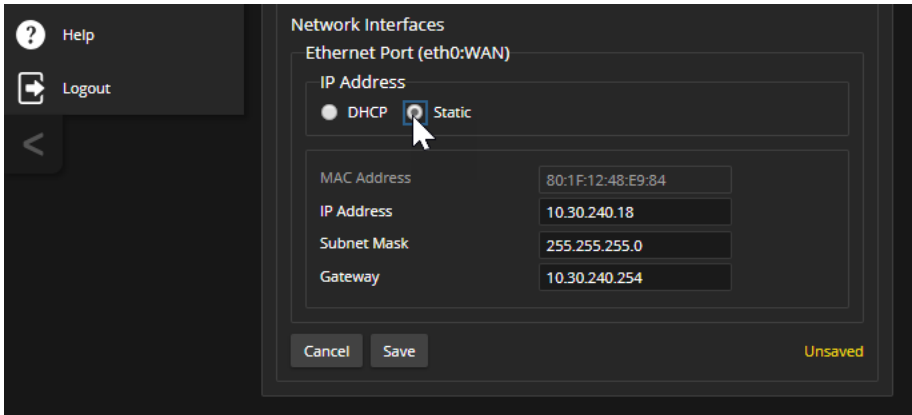

Changing the Camera's Hostname

NETWORKING PAGE

If your network supports hostname resolution, you may find it convenient to change the camera's hostname to something easy to remember. Work with your IT department to ensure that the new hostname conforms to the organization's naming conventions.

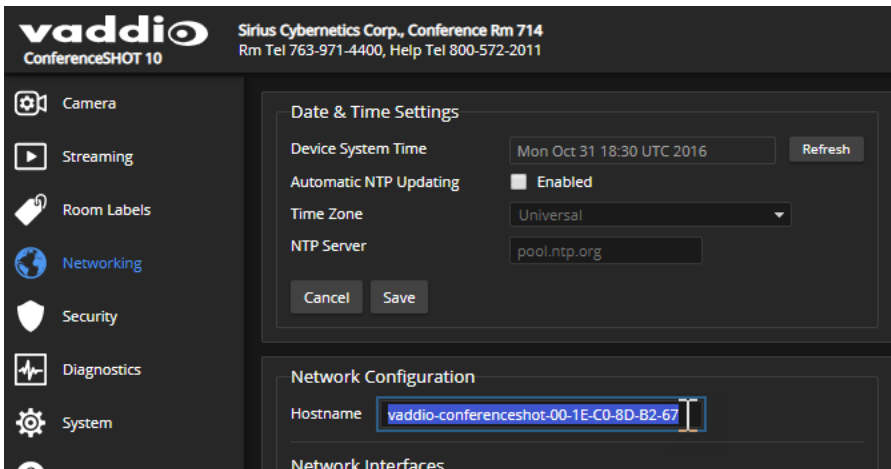

Specifying Time Zone and NTP Server

NETWORKING PAGE

Using automatic NTP updating ensures that the timestamps in the camera's diagnostic log are accurate. Specifying your time zone may make it easier to match logged events with other actions and external events.

1. To make the time zone and NTP server editable, enable Automatic NTP Updating.
2. Select the desired time zone from the list.
3. If desired, specify the NTP server to use. If you are not sure about this, use the default.

You may need to refresh the system time display.

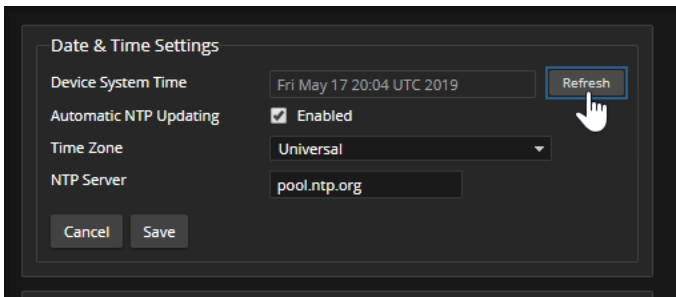
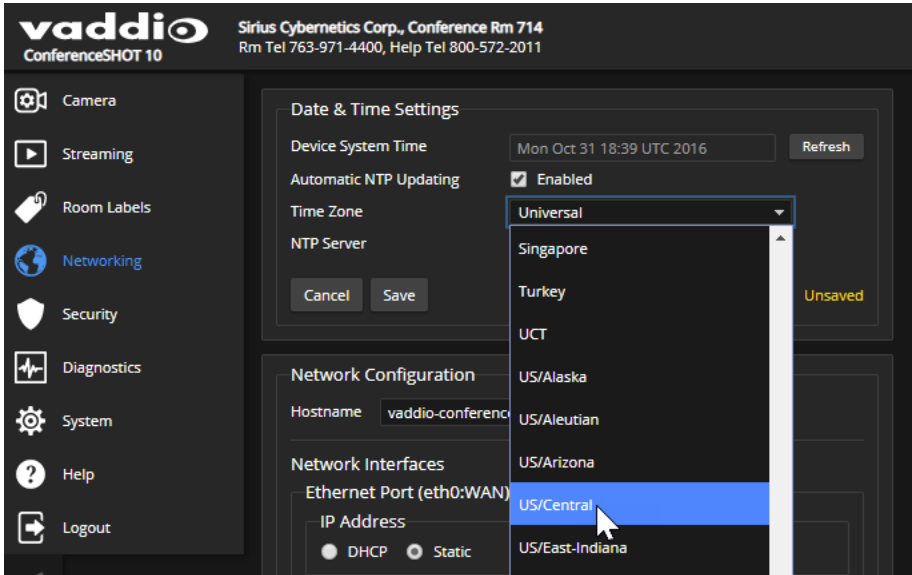

Setting Passwords and Access

SECURITY PAGE

The Account Passwords and Web Server areas of the Security page provide basic security for the web interface:

- **Admin password** – Required for access to the admin pages of the web interface and for Telnet access to the device.
- **User password** – Required for access to the operator's page of the web interface if guest access is disabled.
- **Guest access** – Allows people to browse to the operator's page of the web interface without logging in. If guest access is disabled, no controls are available on the web interface until you log in. This is enabled by default.
- **Idle session expiration** – By default, inactive sessions expire after 30 minutes.

For cameras using firmware released before late 2019, the default admin and user passwords are both **password**.

Note

For best security, change the user and admin passwords from the default. Using the default passwords leaves the product vulnerable to tampering. Be sure you have a way to remember the passwords after changing them.

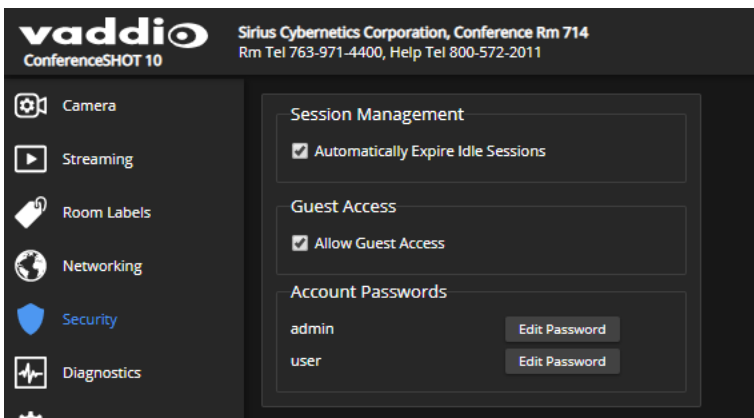

Adding Room Information to the Screen

ROOM LABELS PAGE

The information you enter on this page is displayed on every page of the web interface. In a multi-camera environment, you may also wish to specify what appears on the browser tab.

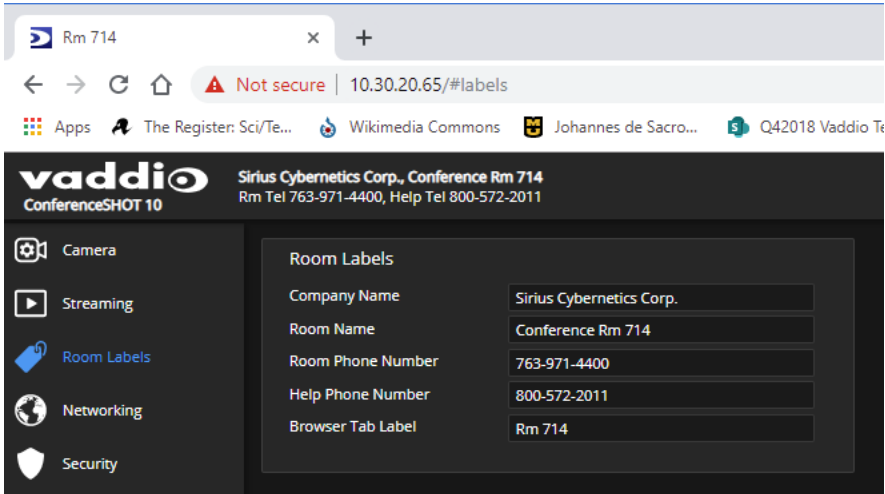

Saving (Exporting) or Restoring (Importing) a Configuration

SYSTEM PAGE, FIRMWARE TAB

You can import a configuration to several cameras if you need to configure them the same way. Cameras must be of the same model, and must have a compatible firmware version installed.

Note

If the camera is using an older firmware version, it may be unable import a configuration that was exported from a camera using a different version of firmware.

In the event that you need to restore a camera's factory default settings, you may want to export the configuration beforehand so that you can restore customized information.

Included	Not Included
Home	Color settings
Presets	Speed settings
NTP and time zone information	Hostname
Room Labels	Passwords and other security settings

Configuration data does not include security information or unique information such as hostname.

To export a configuration:

1. Configure the camera – set the time zone, create the room label, and store the presets you need.
2. Export the configuration (Export Data button). The export downloads to your computer as a .dat file. The filename is the camera's hostname.

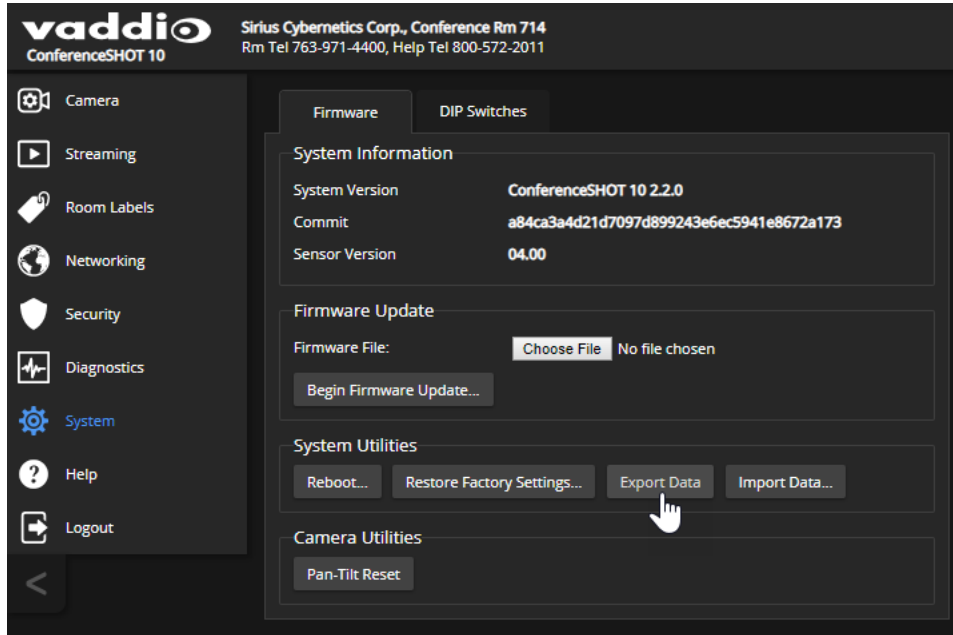

3. When you are ready to restore the configuration, select Import Data. The web interface prompts you to browse to the .dat file that will be imported.

To copy the configuration to a different camera, do this step from the web interface of the camera being configured.

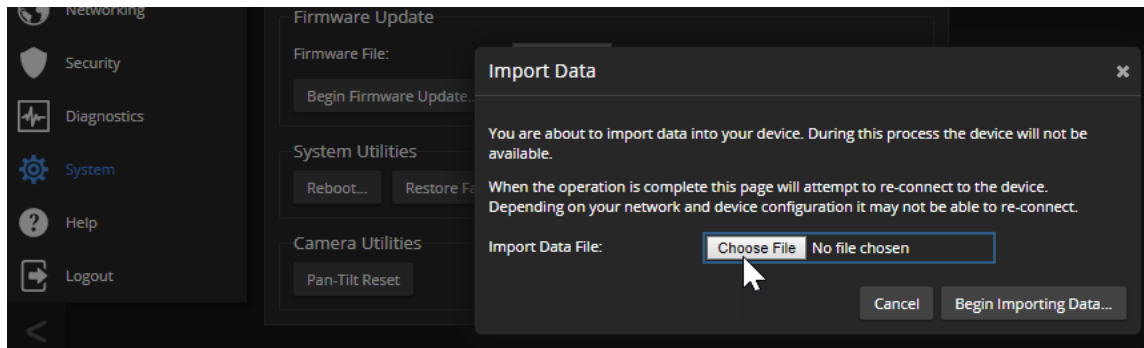

Installing a Firmware Update

SYSTEM PAGE, FIRMWARE TAB

We release firmware updates from time to time. Some of them will be of interest to your organization; others might not be. The release notes provided with each update can help you to decide whether to install the update. The latest firmware and release notes are available on the product's web page at www.legrandav.com.

Caution

The camera must remain connected to power and to the network during the update. Interrupting the update could make the camera unusable.

1. Download the firmware and its release notes.
2. Select Choose File, then browse to the downloaded firmware and select it. The filename ends with .p7m.

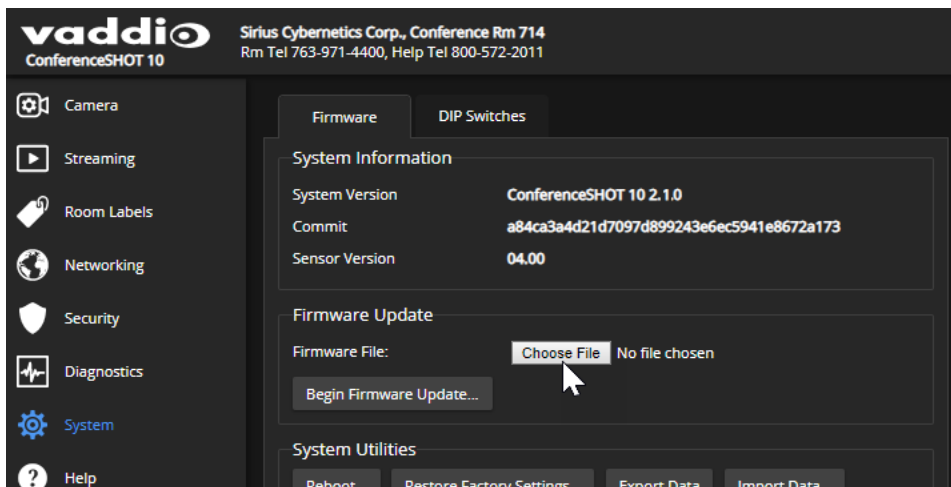

3. Select Begin Firmware Update.

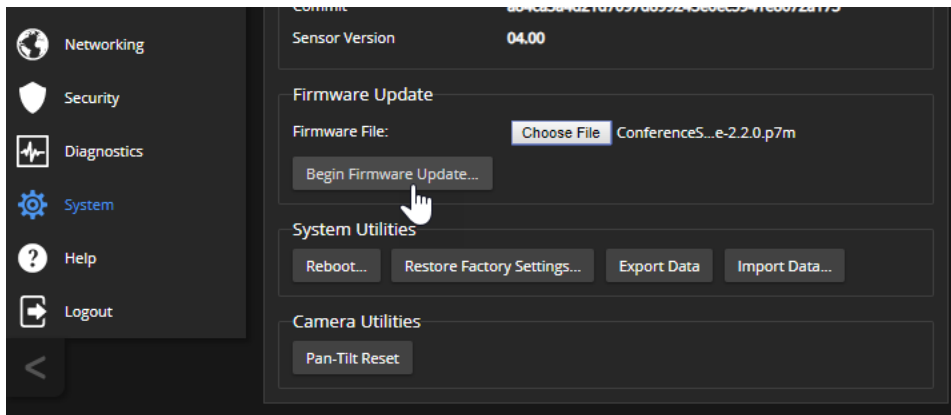

4. Read and understand the information in the Confirm dialog box.
 5. Select Continue. A progress message box opens and the indicator light on the front of the camera turns yellow. If the update process presents warnings or error messages, read them carefully.
- The camera reboots when the update is complete, and the web interface prompts you to log in again. Contact Vaddio Technical Support if you encounter any problems with the update.

Rebooting the Camera

SYSTEM PAGE, FIRMWARE TAB

This can help if the camera stops responding as you expect. In the System Utilities section, select Reboot.

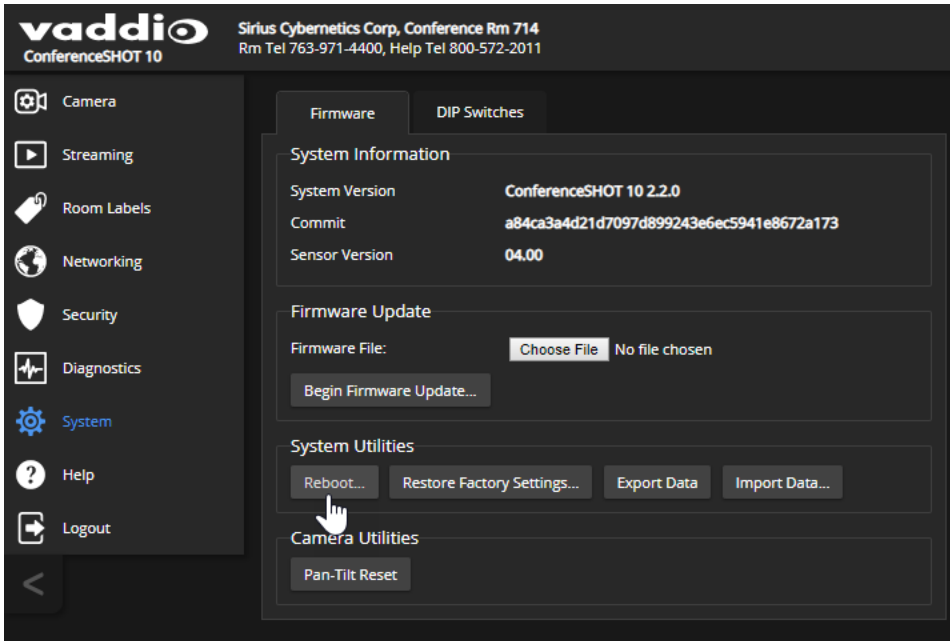

Contacting Vaddio Technical Support

HELP PAGE

If you can't resolve an issue using your troubleshooting skills (or the [Troubleshooting](#) table in this manual), we are here to help.

You'll find information for contacting Vaddio Technical Support on the Help screen.

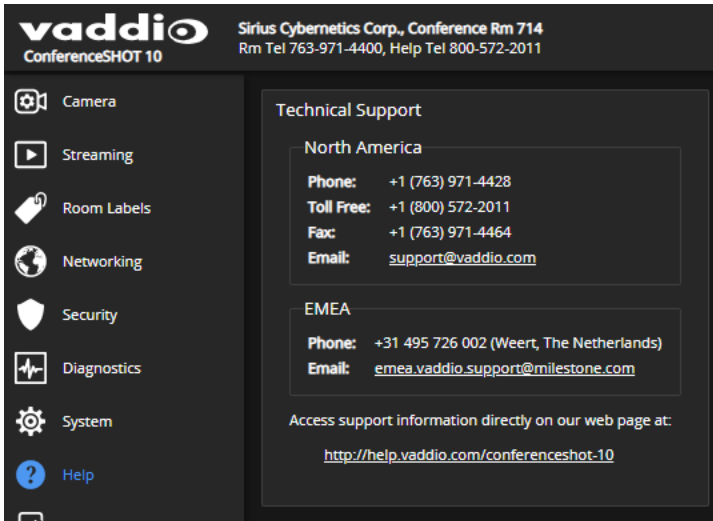

Viewing Diagnostic Logs

DIAGNOSTICS PAGE

If you encounter a problem that you can't solve, your Vaddio technical support representative may ask you to download and email the log file available from the Diagnostics screen.

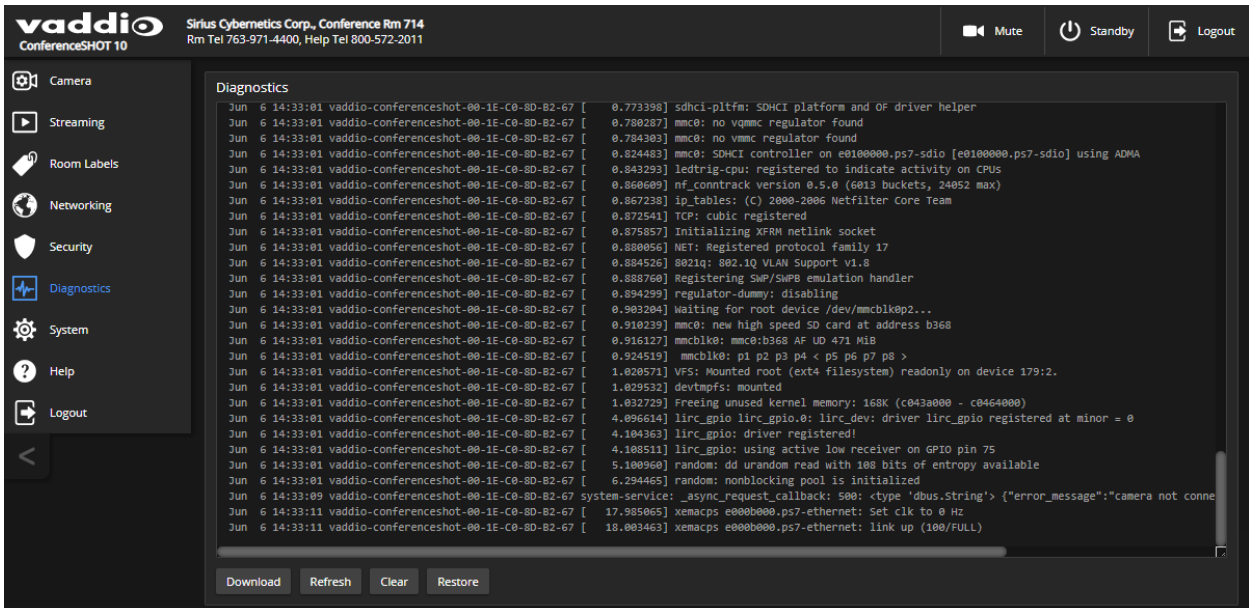

Configuring Camera Behavior

This chapter covers settings for defining how the camera performs in your environment – for example, streaming settings.

What do you need?	Go to this page
Camera operation <ul style="list-style-type: none"> ■ Preset positions ■ Color and lighting settings ■ Focus ■ Speed adjustments 	Camera
USB and IP streaming settings	Streaming
Other camera behaviors <ul style="list-style-type: none"> ■ IR frequency – respond to the IR remote as camera 1, 2, or 3 ■ Normal or super-wide mode ■ Image flip ■ UVC-Compliant or Client Custom USB streaming ■ LED behavior ■ RS-232 baud rate 	System (has multiple tabs)

Setting the Home Position and Other Preset Shots

CAMERA PAGE

Presets are saved shots. Each preset includes pan, tilt, zoom, and (optionally) color settings. When you reboot the camera or bring it out of standby, it returns to the Home preset.

Home and presets 1 through 6 are available with the IR Remote Commander; the others are only available from the web interface.

To store a preset:

1. Set up the shot.
2. In the Presets area, select Store to open the Store Preset dialog.

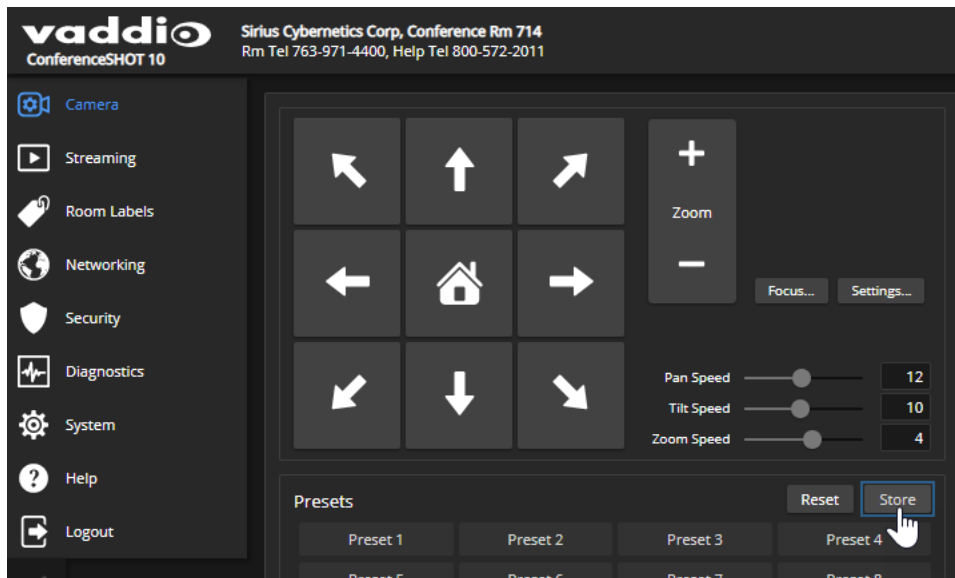

3. Select the preset to store. The preset button changes color.

Note

The Store Preset dialog box does not indicate whether presets have already been defined, but the main display dims the preset buttons if they have no preset information stored.

4. To save the current color settings along with the camera position, check Store with Current Color Settings.
5. Store the preset.

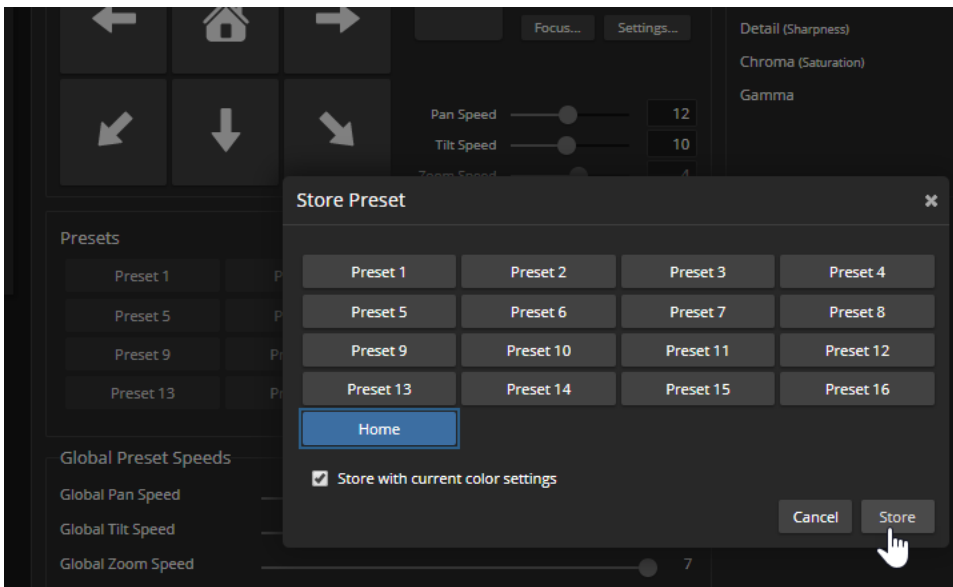

Renaming Presets

CAMERA PAGE

You can rename presets to identify the shots. This also helps you identify and avoid overwriting stored presets when you store a new preset.

Right-click the button for the custom scene or preset, and edit the label.

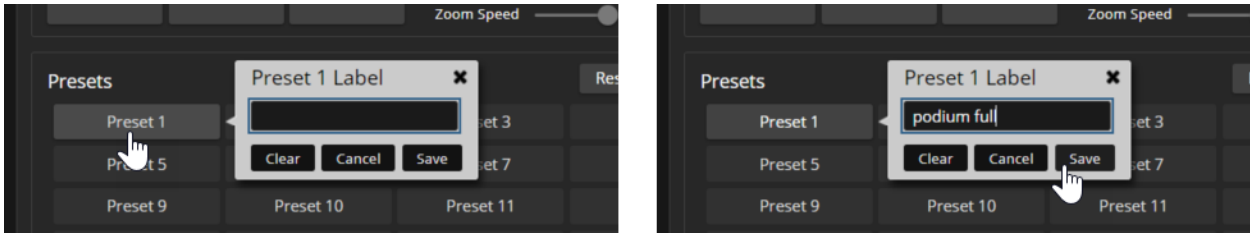

Adjusting the Color and Image Quality Settings

CAMERA PAGE

Fine-tune the color and lighting as needed using the Color Settings controls.

- **Auto Iris** allows the camera to compensate automatically for the light level. Clear this box to adjust iris and gain manually.
- **Backlight Compensation** (available when Auto Iris is selected) reduces contrast to adjust for bright light behind the main subject of the shot. This setting can't be used with Wide Dynamic Range.
- **Wide Dynamic Range** (available when Auto Iris is selected) increases the contrast between the brightest and darkest areas. This setting can't be used with Backlight Compensation.
- **Auto White Balance** adjusts color automatically. Clear this box to adjust red gain and blue gain manually.
- **Red Gain** and **Blue Gain** (available when Auto White Balance is not selected) provide manual color adjustment.
- **Detail** adjusts the image sharpness. If the video looks grainy or “noisy,” try a lower Detail setting.
- **Chroma** adjusts the color intensity.
- **Gamma** adjusts the range (grey density) between bright areas and shadows.

The [Color Adjustment Quick Reference](#) may be helpful.

If you make a change that you don't like, start over by selecting and then deselecting Auto White Balance.

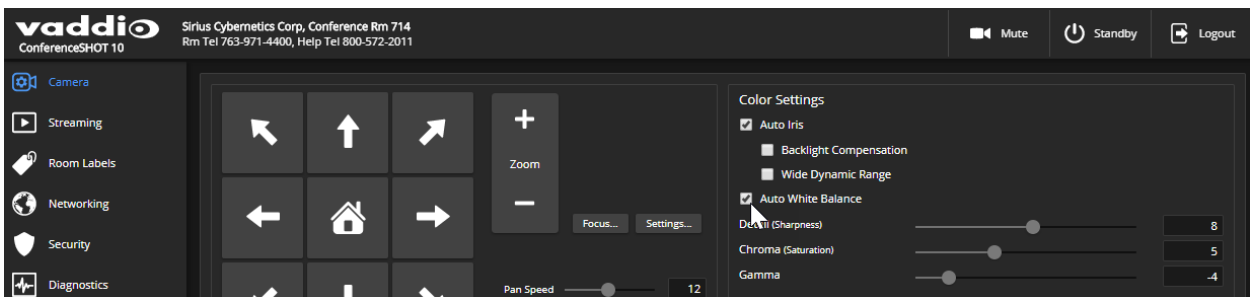





Lighting and Image Quality Quick Reference

Here are some tips for using the color settings for lighting and image quality.

What do you need to correct?	Make this adjustment:
The image is too dark	Increase Iris (lower F-stop value)
	Increase Iris Gain
The image looks washed out or faded	Decrease Iris (higher F-stop value)
	Decrease Iris Gain
	Increase Chroma
	Decrease Gamma
The subject is silhouetted against a bright background	Enable Backlight Compensation
Highlights and shadows look right, but mid-tones are too dark.	Increase Gamma
Shadows are too dark	Enable Wide Dynamic Range (WDR)
	Decrease Gamma
The image looks grainy	Decrease Detail
	Decrease Iris Gain
"Soft focus" effect; the image looks unrealistically smooth	Increase Detail

Color Adjustment Quick Reference

Here are some tips for using the color-related CCU settings.

What do you need to correct?	Make this adjustment:			
Colors look less vivid than they should	Increase Chroma			
Colors look too vivid	Decrease Chroma			
Colors look wrong; white objects do not appear white	Enable Auto White Balance			
	One Push White Balance			
	Disable Auto White Balance and... <ul style="list-style-type: none"> ■ adjust Red Gain (decrease for less red, increase for less green) ■ adjust Blue Gain (decrease for less blue, increase for less yellow) 			
Too much red	Not enough red	Too much blue	Not enough blue	Balanced
				

If you are adjusting for lighting conditions that are likely to recur, you can store presets with color settings.

Adjusting the Focus

CAMERA PAGE

Open the Focus control to select Auto-focus, or set manual focus with the + (near) and – (far) buttons. The + and – buttons only work when Auto Focus is not selected.

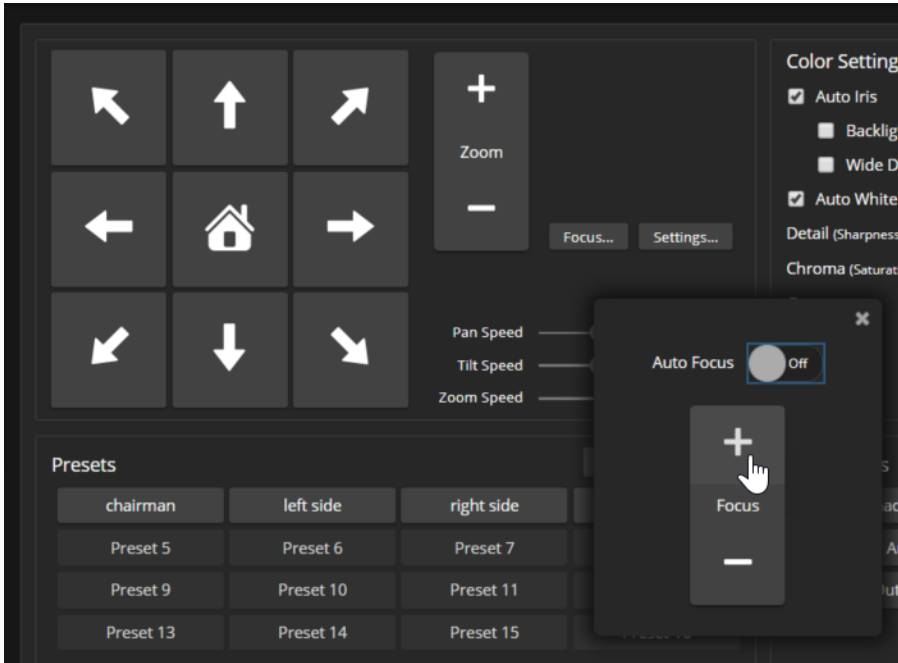

For users who are not logged in as admin, focus control is available via the IR Remote Commander.

Speed Adjustments

CAMERA PAGE

The following speed adjustments are available:

- Manual pan, tilt, and zoom speeds – Used when you control camera movements with the IR Remote Commander or the arrow buttons in the web interface
- Global Preset Speeds – Separate pan, tilt, and zoom speeds used for movements between presets.

Setting the Speeds for Manual Movements

CAMERA PAGE

The Pan Speed, Tilt Speed, and Zoom Speed sliders control how fast the camera moves in response to the direction and zoom controls on the IR remote and in the web interface.

To set speeds for movements using the arrow buttons:

Use the speed sliders to adjust the speed of movements that you control with the buttons for pan, tilt, and zoom. For tight shots, slower is usually better.

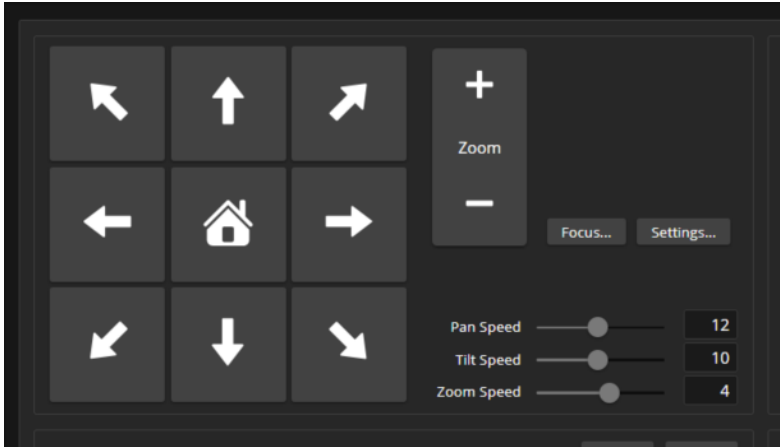

Setting the Speeds of Movements to Presets

CAMERA PAGE

The Pan Speed, Tilt Speed, and Zoom Speed sliders in the Global Preset Speeds control how fast the camera moves to presets.

To set speeds for movements to presets:

In the Global Preset Speeds section, set the speeds for movements to presets.

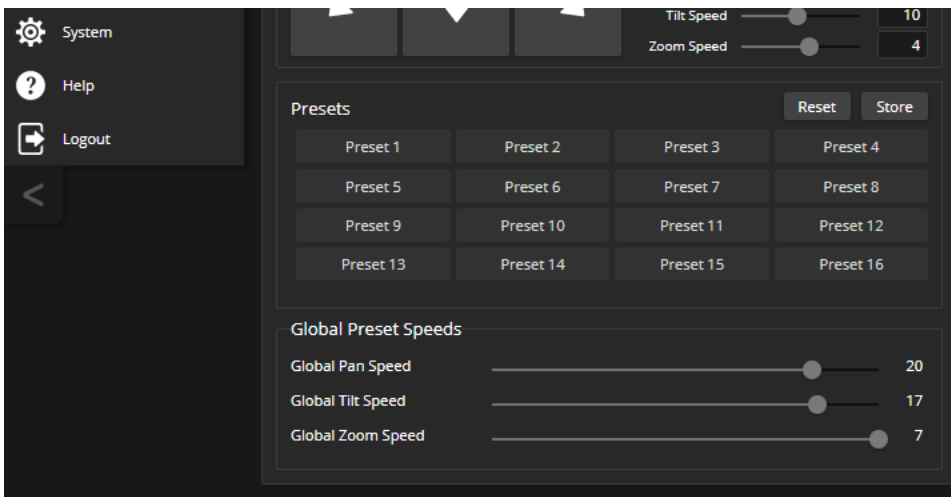

Setting the Direction for Camera Movements

CAMERA PAGE

By default, the arrow buttons on the remote and in the web interface show the direction you would see the camera move if you were looking the same direction as the camera. If a person facing the camera is controlling it with the remote, using the right arrow pans the camera to the person's left.

To make the arrow buttons indicate camera movement from the perspective of a person facing the camera, open the Settings control and invert the pan direction.

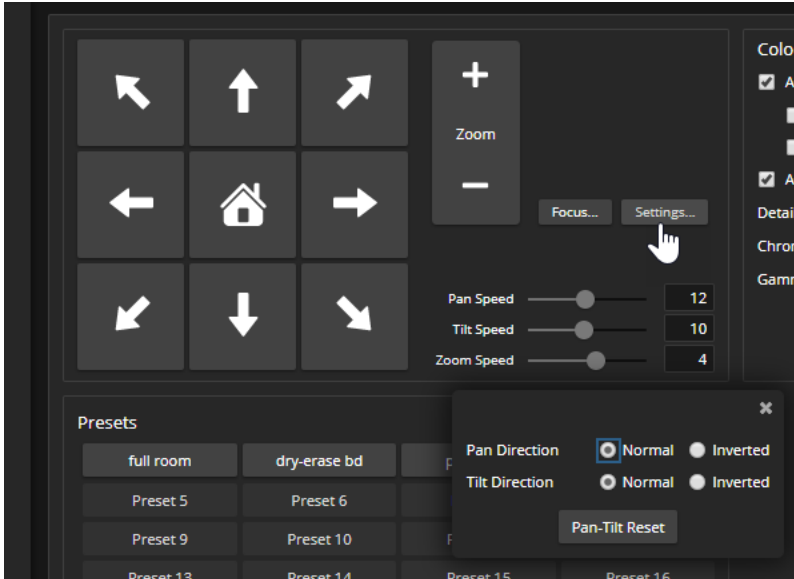

Configuring Streaming Behavior

Conferencing applications use *USB streaming*. The camera's USB stream can be viewed using the computer connected to the camera, either in a conference or using a media player.

Note

Your camera's web interface may differ slightly from the images in these procedures.

Enabling or Disabling Streaming

STREAMING PAGE

IP streaming is enabled by default, and the RTSP stream is available for viewing on your network unless you disable IP streaming. USB streaming is available whenever the camera is connected to a computer.

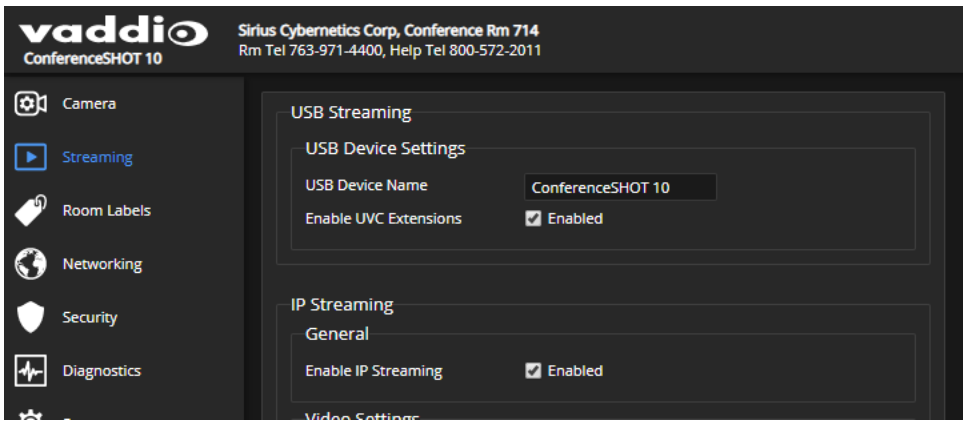

Viewing a Stream

To view the RTSP stream:

1. Open a stream viewer such as VLC Media Player.
2. Select "Network stream" or your viewer's equivalent option.
3. Copy the streaming URL from the camera's Streaming page and paste it into the viewer as the URL for the network stream.

To view the USB stream:

Do one of these things:

- Start or join a conference.
- Open a stream viewer and select the camera as the video capture device.

The image below shows how you would select a ConferenceSHOT 10 camera as the capture device for VLC Media Player.

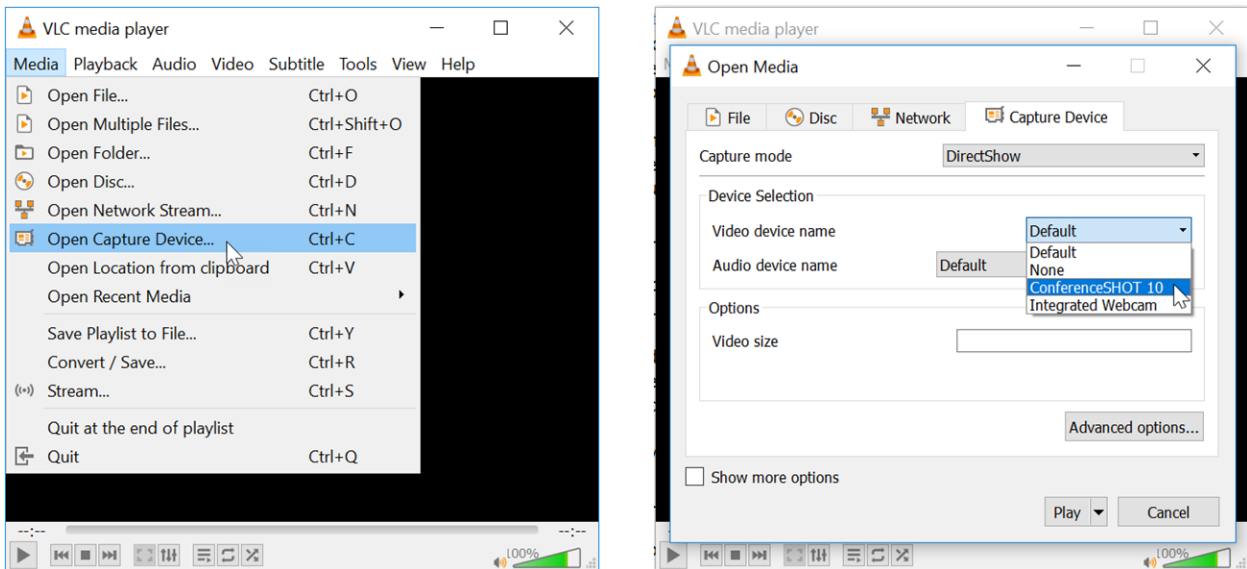

Configuring USB Streaming

STREAMING PAGE

These settings affect how the camera works with soft conferencing applications.

To change the way the camera shows up in your soft client's camera selection list:

Edit the USB Device Name.

To allow conferencing applications to control the audio:

Check the Enabled box for HID Audio Controls.

To allow conferencing applications to control the camera:

Check the box marked Enable UVC Extensions.

Note

USB streaming resolution and frame rate are automatically negotiated between the camera and the conferencing application.

Setting up IP Streaming in Easy Mode

STREAMING PAGE

Note

Consult your network specialist when setting up IP streaming, to be sure that you select settings that are appropriate for the network.

If you are not sure about these settings, start with the defaults.

1. Select Easy Quality Mode.
2. Select the desired IP streaming resolution. This determines the size of the window in which the stream is displayed.

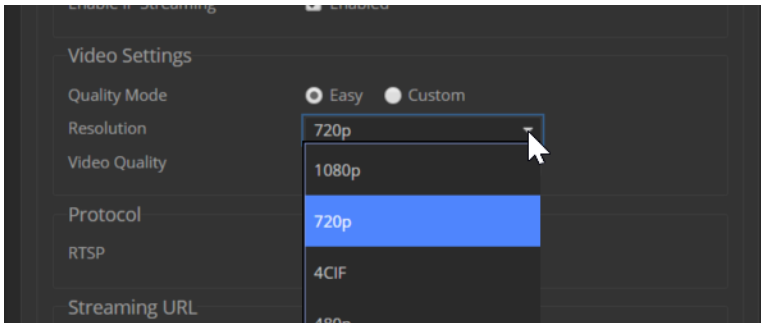

3. Select Video Quality.

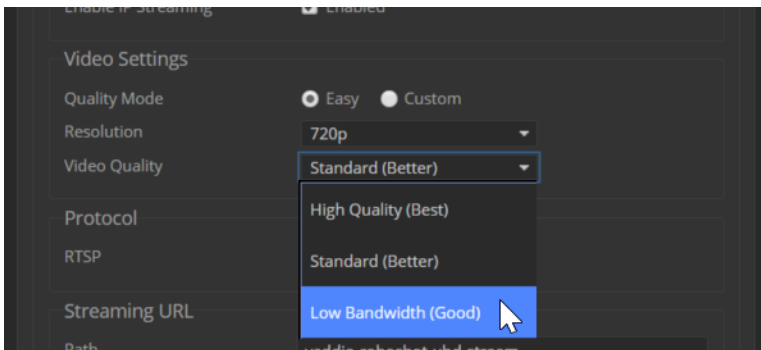

4. Save your changes.

Setting up IP Streaming in Custom Mode

STREAMING PAGE

Note

Consult your network specialist when setting up IP streaming, to be sure that you select settings that are appropriate for the network.

1. Select Custom quality mode.
2. Select the desired resolution.
3. Select the desired frame rate.

Note

Some combinations of resolution and frame rate are not valid, and will generate notifications.

4. Select Constant or Variable Bit Rate.
5. Constant Bit Rate only: Set Max Bandwidth.

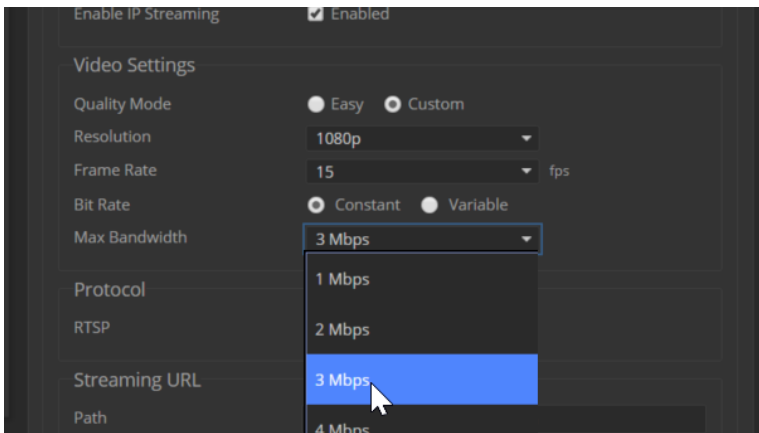

6. Variable bit rate only: Set the Quality (Quantization) slider.

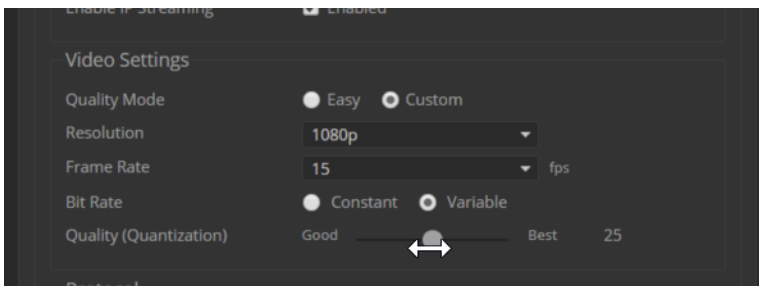

7. Save your changes.

RTSP Streaming Protocol and URL

STREAMING PAGE

RTSP is the default streaming protocol. When IP streaming is enabled, the RTSP stream is automatically available at the streaming URL shown.

Consult your IT department before changing these settings.

RTSP port: Vaddio strongly recommends using the default RTSP port number.

Path: The portion of the streaming URL that appears after the IP address. You may wish to change this to help identify the stream source – for example, `demo-studio-3`.

URL: The location where the stream can be viewed. This will change if you edit the path.

Changing MTU

STREAMING PAGE

The default packet size for streaming is 1400. Do not change this except in consultation with your network administrator.

Reading the Camera's Switches

CAMERA PAGE, CAMERA SETTINGS BUTTON

SYSTEM PAGE, DIP SWITCHES TAB

To see the camera's current switch settings and configure certain camera behaviors, do one of these things:

- Select the Camera Settings button on the Camera page.
- Select the DIP Switches tab of the System page.

Either action shows the current positions of the physical switches (if any) on the back of the camera, along with other basic behavior settings.

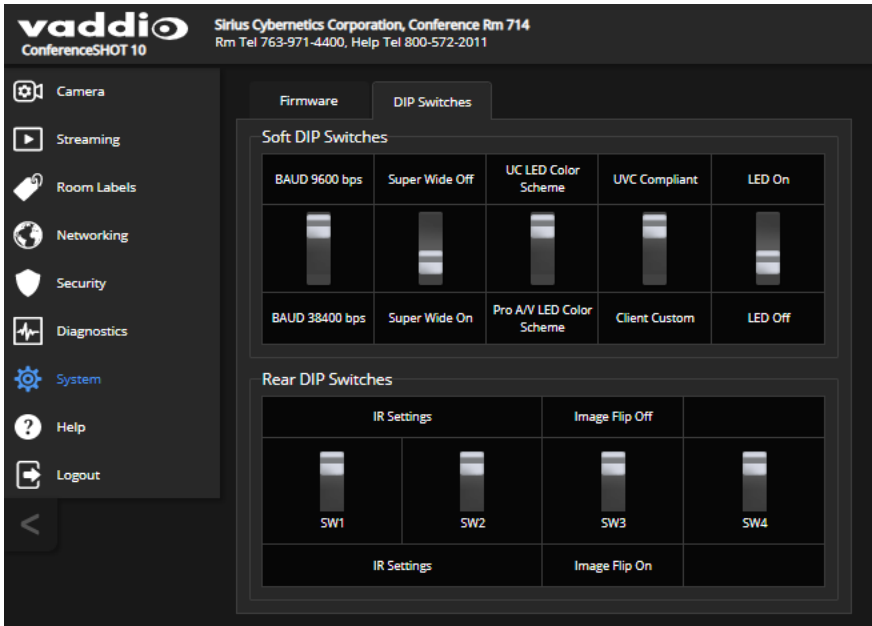

Additional Camera Settings

SYSTEM PAGE, DIP SWITCHES TAB

The DIP Switches tab of the System page provides access to several features via soft DIP switches.

Super Wide mode – Provides a wider horizontal field of view and greater zoom. Some distortion may be present.

Baud Rate (9600 bps or 38400 bps) – RS-232 serial communication rate.

LED color scheme – Status light color codes for UC (unified conferencing) or Pro AV (broadcast); default is UC.

USB stream format (UVC Compliant or Client Custom) – Client Custom enables far-end camera control when used with the Zoom soft client. Use the default UVC Compliant setting with most other conferencing applications.

LED on/off – In most cases, Vaddio recommends leaving the status light on, to let people in the room know whether the camera is currently sending video.

Enable/Disable LED in Standby Mode – Select Disabled to turn off the LED when the camera is in standby mode.

Manual Standby/USB Standby – Select USB standby to set the camera in standby mode when no USB stream is present (not in a conference).

Operating the Camera

CONTROLS PAGE (USER OR GUEST ACCESS)

The Controls page provides most of the same controls as the IR Remote Commander, along with some that are not available from the remote:

- Pan, tilt, zoom, or return to home position
- Stop or resume transmitting live camera video (video mute)
- Put the camera in standby or bring it back to the ready state
- Move to camera presets, if any have been stored

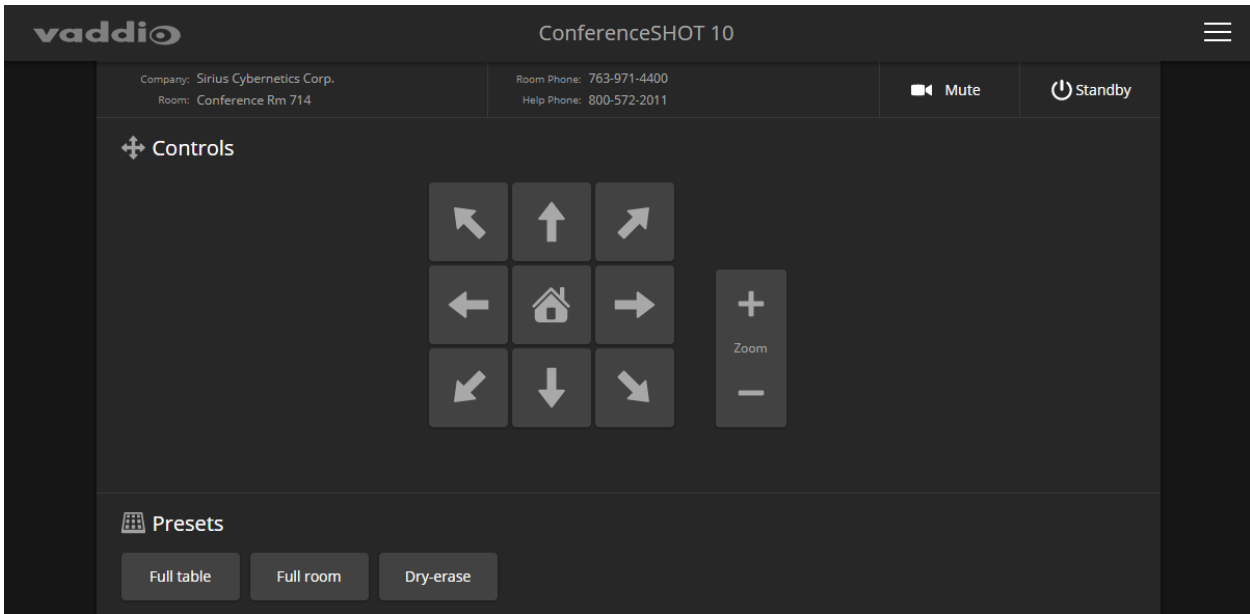

Stopping or Resuming Video

Use the mute button to temporarily stop video from the camera without placing it in standby. Remember that the video mute button does not mute the room's microphones, conference phone, or your computer's microphone. In video mute mode, the camera transmits blue or black video, with a message that the video is muted.

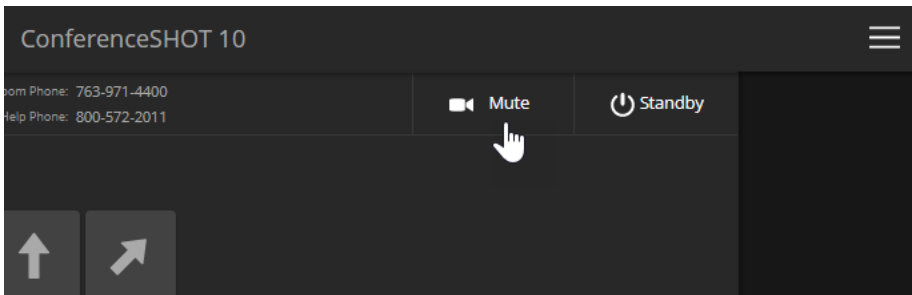

Managing the Camera Ready State

Use the Standby button to switch between low-power (standby) and ready states.

In standby mode, the screen presents the message “Device is in standby.” On entering standby mode, the camera pans 90° from center and 30° downward.

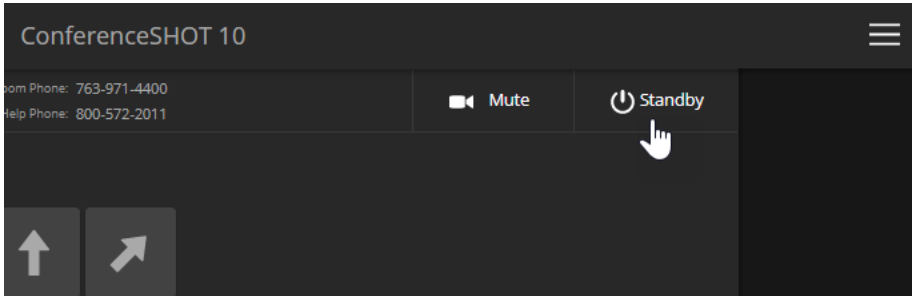

Moving the Camera

Use the arrow buttons for camera pan and tilt. The center button moves the camera to the home position.

Zooming In or Out

Use the Zoom + button to zoom in and the Zoom – button to zoom out.

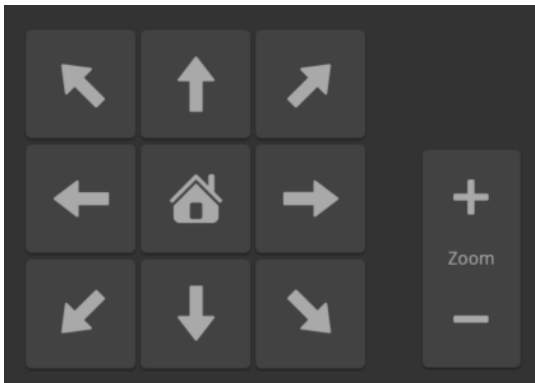

Moving the Camera to a Preset Position

Use the Preset buttons (if available) to move the camera to any of its programmed positions. Presets are only available if they have been set in the administrative interface.

Telnet Serial Command API

The Vaddio Telnet command API allows an external device such as an AMX or Crestron presentation system to control the camera. Network connectivity and a Telnet client are required; Telnet port 23 is used. In addition to the camera control commands, Telnet session management commands are available – help, history, and exit.

Note

When you connect via Telnet, you must log in using the admin account.

Things to know about Telnet:

- The > character is the command prompt.
- Using a question mark as a command parameter will bring up a list of available subcommands or parameters. Example:

```
camera led ?
get      Get the current LED toggle
on       Turn the LED on
off      Turn the LED off
```

- CTRL-5 clears the current serial buffer on the device.

Typographical conventions:

- n { x | y | z } – Choose x, y, or z.
- n <variable> – Substitute the desired value here.
- n < x - y > – Valid range of values is from x through y.
- n [optional] – Parameter is not required.

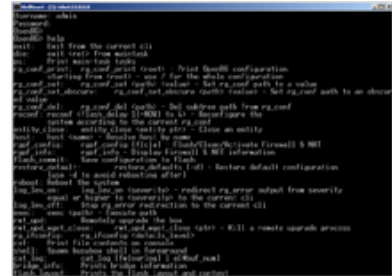

camera home

Moves the camera to its home position.

Synopsis	camera home
Example	<pre>>camera home OK ></pre>

camera pan

Moves the camera horizontally.

Synopsis	camera pan { left [<speed>] right [<speed>] stop get set <position> [<speed>] }	
Options	left	Moves the camera left.
	right	Moves the camera right.
	speed <1 - 24>	Optional: Specifies the pan speed as an integer (1 to 24). Default speed is 12.
	stop	Stops the camera's horizontal movement.
	set <position>	<p>Sets the camera's absolute pan position in degrees, as a floating point value between approximately -155.00 and 155.00.</p> <p>This is the minimum range. Individual cameras may have slightly more travel before they reach their physical limits.</p> <p>The <code>camera pan set</code> command blocks execution of subsequent commands until the camera reaches the specified position.</p>
	get	Returns the camera's absolute pan position in degrees, as a floating point value between approximately -155.00 (left) and 155.00 (right).
Examples	<pre>>camera pan left OK ></pre> <p>Pans the camera left at the default speed.</p> <pre>>camera pan right 20 OK ></pre> <p>Pans the camera right using a speed of 20.</p> <pre>>camera pan stop OK ></pre> <p>Stops the camera's horizontal motion.</p> <pre>>camera pan set -15 OK ></pre> <p>Pans the camera to 15° left of its centerline at the default speed.</p>	

camera tilt

Moves the camera vertically.

Synopsis	<code>camera tilt{ up [<speed>] down [<speed>] stop get set <position> [<speed>] }</code>	
Options	<code>up</code>	Moves the camera up.
	<code>down</code>	Moves the camera down.
	<code>speed <1 - 20></code>	Optional: Specifies the tilt speed as an integer (1 to 20). Default speed is 10.
	<code>stop</code>	Stops the camera's vertical movement.
	<code>set <position></code>	Sets the camera's absolute tilt position in degrees, as a floating point value between approximately -30.00 and 90.00. This is the minimum range; individual cameras may have an additional degree or two of travel before they reach their physical limits. The <code>camera tilt set</code> command blocks execution of subsequent commands until the camera reaches the specified position.
	<code>get</code>	Returns the camera's absolute tilt position in degrees, as a floating point value between approximately -30.00 (down) and 90.00 (up). Note that the range is roughly 30.00 to -90.00 if Image Flip is selected.
Examples	<pre>>camera tilt up OK > Tilts the camera up at the default speed. >camera tilt down 20 OK > Tilts the camera down at a speed of 20. >camera tilt set -5 OK > Tilts the camera 5° down from level at the default speed.</pre>	

camera zoom

Moves the camera in toward the subject or out away from the subject.

Synopsis	camera zoom { in [<speed>] out [<speed>] stop get set <position> }	
Options	in	Zooms the camera in.
	out	Zooms the camera out.
	stop	Stops the camera's zoom movement.
	set <zoom>	Sets the camera's zoom level as a floating point value between 1.00 and 10.00 (12.00 in Super Wide Mode).
	get <zoom>	Returns the camera's zoom setting as a floating point value between 1.00 and 10.00 (12.00 in Super Wide Mode).
Examples	<pre>>camera zoom in OK > Zooms the camera in at the default speed. >camera zoom out 7 OK > Zooms the camera out using a speed of 7. >camera zoom stop OK > Stops the camera's zoom motion.</pre>	

camera focus

Changes the camera focus.

Synopsis	<code>camera focus { near [<speed>] far [<speed> stop mode {get auto manual} }</code>	
Options	<code>near</code>	Brings the focus nearer to the camera. Can only be used when camera is in manual mode.
	<code>far</code>	Moves the focus farther from the camera. Can only be used when camera is in manual mode.
	<code>speed <1 - 8></code>	Optional: integer (1 to 8) specifies the focus speed.
	<code>mode [get auto manual]</code>	Returns the current focus mode, or specifies automatic or manual focus.
	<code>stop</code>	Stops the camera's focus movement.
Examples	 <pre> camera focus near OK > Brings the focus near at the default speed. camera focus far 7 OK > Moves the focus farther from the camera at a speed of 7. camera focus mode get auto_focus: on OK > Returns the current focus mode. </pre>	

camera preset

Moves the camera to the specified preset, or stores the current camera position and optionally CCU information.

Synopsis	<code>camera preset { recall store} [1 - 16] [save-ccu]</code>	
Options	<code>recall [1 - 16]</code>	Moves the camera to the specified preset.
	<code>store [1 - 16]</code>	Stores the current camera position as the specified preset.
	<code>save-ccu</code>	Optional: Saves the current CCU (color and lighting) settings as part of the preset. If not specified, the last color settings are used when recalled.
Examples	<pre>>camera preset recall 3 OK > Moves the camera to preset 3. >camera preset store 1 OK > Saves the camera's current position as preset 1.</pre>	

camera ccu get

Returns CCU (lighting and color) information.

Synopsis	<code>camera ccu get <param></code>	
	<code>auto_white_balance</code>	Returns the current state of the auto white balance setting (on or off).
	<code>red_gain</code>	Returns the red gain value as an integer (0 to 255).
	<code>blue_gain</code>	Returns the blue gain value as an integer (0 to 255).
	<code>backlight_compensation</code>	Returns the current state of the backlight compensation setting (on or off).
	<code>iris</code>	Returns the iris value as an integer (0 to 11).
	<code>auto_iris</code>	Returns the current auto-iris state (on or off).
	<code>gain</code>	Returns the gain value as an integer (0 to 11).
	<code>detail</code>	Returns the detail value as an integer (0 to 15).
	<code>chroma</code>	Returns the chroma value as an integer (0 to 14).
	<code>gamma</code>	Returns gamma as an integer (-64 to 64)
	<code>wide_dynamic_range</code>	Returns the current setting for Wide Dynamic Range (on or off).
	<code>all</code>	Returns all current CCU settings.
Examples	<pre>>camera ccu get iris iris 6 OK ></pre> <p>Returns the current iris value.</p> <pre>>camera ccu get red_gain red_gain 201 OK ></pre> <p>Returns the current red gain value.</p> <pre>>camera ccu get all auto_iris on auto_white_balance on backlight_compensation off blue_gain 193 chroma 2 detail 8 gain 3 iris 11 red_gain 201 wide_dynamic_range off OK ></pre> <p>Returns all current CCU settings.</p>	

camera ccu set

Sets the specified CCU (lighting) information.

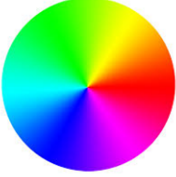
Synopsis	camera ccu set <param> <value>	
Options 	auto_white_balance {on off}	Sets the current state of the auto white balance setting (on or off). Auto white balance overrides red gain and blue gain manual settings.
	red_gain <0 - 255>	Sets the red gain value as an integer (0 to 255). Can only be used when auto white balance is off.
	blue_gain <0 - 255>	Sets the blue gain value as an integer (0 to 255). Can only be used when auto white balance is off.
	backlight_compensation {on off}	Sets the current state of the backlight compensation setting (on or off). Can only be used when wide dynamic range mode is off.
	iris <0 - 11>	Sets the iris value as an integer (0 to 11). Can only be used when auto-iris is off.
	auto_iris {on off}	Sets the auto-iris state (on or off). Auto-iris disables manual iris and gain when it is on.
	gain <0 - 11>	Sets gain value as an integer (0 to 11). Can only be used when auto-iris is off.
	detail <0 - 15>	Sets the detail value as an integer (0 to 15).
	chroma <0 - 14>	Sets the chroma value as an integer (0 to 14).
	gamma <-64 - 64>	Sets the gamma value as an integer (-64 to 64)
	wide_dynamic_range {on off}	Sets Wide Dynamic Range mode on or off. Can only be used when backlight compensation is off.
Examples	<pre>>camera ccu set auto_iris off OK > Turns off auto-iris mode, returning the camera to manual iris control. >camera ccu set red_gain 10 OK > Sets the red gain value to 10.</pre>	

camera led

Set or change the behavior of the indicator light.

Synopsis	camera led { get off on }	
Options	get	Returns the indicator light's current state (on or off).
	off	Disables the indicator light.
	on	Enables the indicator light.
Examples	<pre>>camera led off OK ></pre> <p>Disables the indicator light. When the LED is off, you cannot tell by looking at the camera whether it is sending video.</p> <pre>>camera led get led: on OK ></pre> <p>Returns the current state of the indicator light.</p>	

camera recalibrate

Recalibrates the pan and tilt motors. This is typically done in response to a motor fault indication or error message.

Synopsis	camera recalibrate
Example	<pre>>camera recalibrate OK ></pre>

camera standby

Set or change camera standby status.

Synopsis	camera standby { get off on toggle }	
Options	get	Returns the camera's current standby state.
	off	Brings the camera out of standby (sleep) mode.
	on	Stops video and puts the camera in standby mode.
	toggle	Changes the camera's standby state - if it was not in standby mode, it enters standby; if it was in standby mode, it "wakes up."
Examples	<pre>>camera standby off OK > Brings the camera out of standby mode. >camera standby get standby: on OK > Returns the current standby state.</pre>	

video mute

Gets or sets the camera's video mute status. When video is muted, the camera sends blue or black video with an on-screen message stating that video mute is on. This can be desirable when preparing the room, or when privacy is needed.

Note

In systems with audio, this command does not affect the audio.

Synopsis	video mute { get off on toggle }	
Options	get	Returns the current video mute status.
	off	Unmutes the video. (Normal video resumes.)
	on	Mutes the video. (Blue or black screen with message)
	toggle	Changes the camera's video mute status.
Examples	<pre>>video mute get mute: off OK > Returns video mute status. >video mute on OK > Transmits blue or black video.</pre>	

streaming settings get

Returns current IP and USB streaming settings.

Synopsis	streaming settings get	
Parameters	IP Custom_Frame_Rate	Frame rate (Custom mode).
	IP Custom_Resolution	Resolution (Custom mode).
	IP Enabled	True if IP streaming is enabled, False if it is not.
	IP MTU	The current MTU setting (1400 is default)
	IP Port	Port number used for IP streaming. RTSP default is 554; RTMP default is 1935.
	IP Preset_Quality	Video quality (Easy mode).
	IP Preset_Resolution	Resolution (Easy mode).
	IP Protocol	IP streaming protocol in use (RTSP or RTMP).
	IP URL	URL where the RTSP stream is available.
	IP Video_Mode	Video quality mode (preset or custom).
	USB Active	True if a USB stream is present; false if not.
	USB Device	The USB Device Name currently assigned.
	USB Frame_Rate	Frame rate for the USB stream (negotiated with conferencing client). 0 when no USB stream is present.
	USB Resolution	Resolution of the USB stream (negotiated with conferencing client). 0x0 when no USB stream is present.
	USB Version	2 or 3, as negotiated with the conferencing client. 0 if no USB stream is present.
UVC Extensions_Enabled	Allow or disable far-end control of the camera.	
Example	<pre>>streaming settings get IP Custom_Frame_Rate 30 IP Custom_Resolution 1080p IP Enabled true IP Port 554 IP Preset_Quality High Quality (Best) IP Preset_Resolution 720p IP Protocol RTSP IP URL vaddio-conferenceshot-stream IP Video_Mode preset USB Active true USB Device ConferenceSHOT 10 USB Frame_Rate 30 USB Resolution 360p USB Version 2 UVC Extensions_Enabled false OK ></pre>	

network settings get

Returns the camera's current network settings and MAC address.

Synopsis	network settings get
Example	<pre>network settings get Name eth0:WAN MAC Address 00:1E:C0:F6:CA:7B IP Address 192.168.1.67 Netmask 255.255.255.0 VLAN Disabled Gateway 192.168.1.254 OK ></pre>

network ping

Sends an ICMP ECHO_REQUEST to the specified hostname or IP address.

Synopsis	network ping [count <count>] [size <size>] <string>	
Options	<count>	The number of ECHO_REQUEST packets to send. Default is five packets.
	<size>	The size of each ECHO_REQUEST packet. Default is 56 bytes.
	<string>	The hostname or IP address where the ECHO_REQUEST packets will be sent.
Examples	<pre>>network ping 192.168.1.66 PING 192.168.1.66 (192.168.1.66): 56 data bytes 64 bytes from 192.168.1.66: seq=0 ttl=64 time=0.476 ms 64 bytes from 192.168.1.66: seq=1 ttl=64 time=0.416 ms 64 bytes from 192.168.1.66: seq=2 ttl=64 time=0.410 ms 64 bytes from 192.168.1.66: seq=3 ttl=64 time=0.410 ms 64 bytes from 192.168.1.66: seq=4 ttl=64 time=3.112 ms --- 192.168.1.66 ping statistics --- 5 packets transmitted, 5 packets received, 0% packet loss round-trip min/avg/max = 0.410/0.964/3.112 ms ></pre> <p>Sends five ECHO_REQUEST packets of 56 bytes each to the host at 192.168.1.66.</p>	
	<pre>>network ping count 10 size 100 192.168.1.1</pre> <p>Sends 10 ECHO_REQUEST packets of 100 bytes each to the host at 192.168.1.1. The command returns data in the same form as above.</p>	

system reboot

Reboots the system either immediately or after the specified delay. Note that a reboot is required when resetting the system to factory defaults (system factory-reset).

Synopsis	system reboot [<seconds>]	
Options	<seconds>	The number of seconds to delay the reboot.
Examples	<pre>>system reboot OK > The system is going down for reboot NOW! conferenceshot-10-D8-80-39-62-A7-C5</pre> <p>Reboots the camera immediately.</p> <pre>>system reboot 30</pre> <p>Reboots the camera in 30 seconds. The response is in the same form; the system message appears at the end of the delay.</p>	

system factory-reset

Gets or sets the factory reset status. When the factory reset status is on, the system resets to factory defaults on reboot.

Synopsis	system factory-reset { get on off }	
Options	get	Returns the camera's current factory reset status.
	on	Enables factory reset on reboot and returns the camera's current factory reset status.
	off	Disables factory reset on reboot and returns the camera's current factory reset status.
Examples	 <pre>>system factory-reset get factory-reset (software): off factory-reset (hardware): off OK ></pre> <p>Returns the factory reset status.</p> <p>This evaluates the most recent <code>system factory-reset on</code> or <code>off</code> command, if one has been received, then reads the rear panel DIP switches and returns the status <code>on</code> if they are all in the down position.</p> <pre>>system factory-reset on factory-reset (software): on factory-reset (hardware): off OK ></pre> <p>Enables factory reset upon reboot.</p> <p>Note <i>This command does not initiate a factory reset. The factory reset takes place on the next reboot.</i></p>	

history

Returns the most recently issued commands from the current Telnet session. Since many of the programs read user input a line at a time, the command history is used to keep track of these lines and recall historic information.

Synopsis	history <limit>	
Options	<limit>	Integer value specifying the maximum number of commands to return.
Examples	<p>history Displays the current command buffer.</p> <p>history 5 Sets the history command buffer to remember the last 5 unique entries.</p>	
Additional information	<p>You can navigate the command history using the up and down arrow keys. This command supports the expansion functionality from which previous commands can be recalled from within a single session. History expansion is performed immediately after a complete line is read.</p> <p>Examples of history expansion:</p> <ul style="list-style-type: none"> * !! Substitute the last command line. * !4 Substitute the 4th command line (absolute as per 'history' command) * !-3 Substitute the command line entered 3 lines before (relative) 	



version

Returns the current firmware version.

Synopsis	version
Example	<pre>>version Commit d033ddb2378357a871011eb820706dcaa64ec0e2 Sensor Version 04.00 System Version ConferenceSHOT 10 2.1.0 OK ></pre>

help

Displays an overview of the CLI syntax.

Synopsis	help
Example	 <pre>> help CONTEXT SENSITIVE HELP [?] - Display context sensitive help. This is either a list of possible command completions with summaries, or the full syntax of the current command. A subsequent repeat of this key, when a command has been resolved, will display a detailed reference. AUTO-COMPLETION The following keys both perform auto-completion for the current command line. and prof... ue the... ring... at</pre>

exit

Ends the command session and closes the socket.

Synopsis	exit
Example	exit

RS-232 Control

The Vaddio Control Protocol is similar to the Sony® VISCA command set in order to be compatible with several popular control devices. Not all VISCA commands are supported and there are Vaddio-specific commands in the following command and inquiry lists.

For RS-232 communication settings and connector pin-out, see [RS-232 Serial Communication](#).

Camera Movement, Zoom, and Focus Commands

Command Set	Command	Command Packet	Comments	
CAM_Zoom	Stop	8x 01 04 07 00 FF	Variable speed: p = 0 (low) to 7 (high) Direct: pqrs = zoom position (0h-4000h)	
	Tele (std)	8x 01 04 07 02 FF		
	Wide (std)	8x 01 04 07 03 FF		
	Tele (variable)	8x 01 04 07 2p FF		
	Wide (variable)	8x 01 04 07 3p FF		
	Direct	8x 01 04 47 0p 0q 0r 0s FF		
	Corresponds to <code>camera zoom</code> in Telnet API			
CAM_Focus	Stop	8x 01 04 08 00 FF	Variable speed: p = 0 (low) to 7 (high) Direct and Near Limit: pqrs = focus position (1000h – F000h)	
	Far (std)	8x 01 04 08 02 FF		
	Near (std)	8x 01 04 08 03 FF		
	Far (variable)	8x 01 04 08 2p FF		
	Near (variable)	8x 01 04 08 3p FF		
	Direct	8x 01 04 48 0p 0q 0r 0s FF		
	Auto Focus	8x 01 04 38 02 FF		
	Manual Focus	8x 01 04 38 03 FF		
	Auto/Manual	8x 01 04 08 10 FF		
	One Push Trigger	8x 01 04 18 01 FF		
	Near Limit	8x 01 04 28 0p 0q 0r 0s FF		
	Corresponds to <code>camera focus</code> in Telnet API			

Command Set	Command	Command Packet	Comments
Pan-TiltDrive	Up	8x 01 06 01 vv ww 03 01 FF	vv= Pan speed (01h-18h) ww=Tilt speed (01h-14h)
	Down	8x 01 06 01 vv ww 03 02 FF	
	Left	8x 01 06 01 vv ww 01 03 FF	
	Right	8x 01 06 01 vv ww 02 03 FF	
	UpLeft	8x 01 06 01 vv ww 01 01 FF	
	UpRight	8x 01 06 01 vv ww 02 01 FF	
	DownLeft	8x 01 06 01 vv ww 01 02 FF	
	DownRight	8x 01 06 01 vv ww 02 02 FF	
	Stop	8x 01 06 01 vv ww 03 03 FF	
	Absolute Position	8x 01 06 02 vv ww 0Y 0Y 0Y 0Y 0Z 0Z 0Z 0Z FF	0Y0Y0Y0Y = Pan position (90E2h-6BD8h) 0Z0Z0Z0Z = Tilt position (EB99h-3D59h)
Home	8x 01 06 04 FF	Returns the camera to its default position	
Pan-TiltDrive	Reset	81 01 06 05 FF	Resets/recalibrates the pan and tilt motors
	Corresponds to <code>camera recalibrate</code> in Telnet API		
Pan-Tilt-ZoomDrive	Up	8x 01 06 0A vv ww rr 03 01 03 FF	vv= Pan speed (01h-18h) ww=Tilt speed (01h-14h) rr=Zoom speed (00h - 07h)
	Down	8x 01 06 0A vv ww rr 03 02 03 FF	
	Left	8x 01 06 0A vv ww rr 01 03 03 FF	
	Right	8x 01 06 0A vv ww rr 02 03 03 FF	
	In	8x 01 06 0A vv ww rr 03 03 01 FF	
	Out	8x 01 06 0A vv ww rr 03 03 02 FF	
	Stop	8x 01 06 0A vv ww rr 03 03 03 FF	
	Home	8x 01 06 0C FF	Returns the camera to the default position and zoom
Pan-Tilt-ZoomDrive	Absolute Position	8x 01 06 0B vv ww 0Y 0Y 0Y 0Y 0Z 0Z 0Z 0Z 0R 0R 0R 0R FF	0Y0Y0Y0Y = Pan position (90E2h-6BD8h) 0Z0Z0Z0Z = Tilt position (EB99h-3D59h) 0R0R0R0R = Zoom position (0h-4000h)

Command Set	Command	Command Packet	Comments
CAM_Memory	Reset	8x 01 04 3F 00 0p FF	p= preset number(0h-0Fh)
	Set	8x 01 04 3F 01 0p FF	
	Set with 'scene'	8x 01 04 3F 21 0p FF	
	Recall	8x 01 04 3F 02 0p FF	
	Corresponds to <code>camera preset</code> in Telnet API.		
CAM_PTZ_PresetSpeed		8x 01 7e 01 0b pp qq rr FF	pp: pan speed (01h-18h) qq: tilt speed (01h-14h) rr: zoom speed (0h-07h)

Movement, Zoom, and Focus Inquiry Commands

Inquiry Command	Command	Response Packet	Comments
CAM_ZoomPosInq	8x 09 04 47 FF	y0 50 0p 0q 0r 0s FF	pqrs: Zoom position
CAM_FocusPosInq	8x 09 04 48 FF	y0 50 0p 0q 0r 0s FF	pqrs: Focus position
CAM_FocusModeInq	8x 09 04 38 FF	y0 50 02 FF	Auto focus
		y0 50 03 FF	Manual focus
		Corresponds to <code>camera focus mode get</code> in Telnet API.	
Pan-TiltPosInq	8x 09 06 12 FF	y0 50 0w 0w 0w 0z 0z 0z 0z FF	www= Pan position zzzz=Tilt Position
CAM_MemoryInq	8x 09 04 3F FF	y0 50 pp FF	pp: Preset number recalled last (00h - 0Fh)
CAM_MemoryStatusInq	8x 09 04 3F 0p FF	y0 50 0p 0q 0r 0s FF	p: Preset number (00h - 0Fh) q: mode (00-std, 10-std /w ccu) rs: speed (0x1-0x18) 1 - 24
CAM_MemSaveInq	8x 09 04 23 0X FF	y0 50 0p 0q 0r 0s FF	X: 00h to 0Fh (preset number) pqrs: 0000h to FFFFh (Data)
CAM_PTZ_PresetSpeedInq	8x 09 7E 01 0B FF	y0 50 p q r FF	p:pan speed (01h-18h) q:tilt speed (01h-14h) r:zoom speed (0h-07h)

Color and Light Management Commands

Command Set	Command	Command Packet	Comments
CAM_WB	Auto	8x 01 04 35 00 FF	Normal auto
	Manual	8x 01 04 35 05 FF	Manual control mode
	Corresponds to <code>camera ccu set auto_white_balance</code> in Telnet API.		
CAM_RGain	Reset	8x 01 04 03 00 FF	Manual control of red gain pq = red gain (00h – FFh)
	Up	8x 01 04 03 02 FF	
	Down	8x 01 04 03 03 FF	
	Direct	8x 01 04 43 00 00 0p 0q FF	
	Corresponds to <code>camera ccu set red_gain</code> in Telnet API.		
CAM_BGain	Reset	8x 01 04 04 00 FF	Manual control of blue gain pq = blue gain (00h – FFh)
	Up	8x 01 04 04 02 FF	
	Down	8x 01 04 04 03 FF	
	Direct	8x 01 04 44 00 00 0p 0q FF	
	Corresponds to <code>camera ccu set blue_gain</code> in Telnet API.		
CAM_AE	Auto	8x 01 04 39 00 FF	Auto exposure mode
	Manual	8x 01 04 39 03 FF	Manual control mode
	Corresponds to <code>camera ccu set auto_iris</code> in Telnet API.		
CAM_Shutter	Reset	8x 01 04 0A 00 FF	Shutter setting
	Up	8x 01 04 0A 02 FF	pq = shutter position (00h – 15h)
	Down	8x 01 04 0A 03 FF	See Shutter Speed Values – CAM_Shutter Command
	Direct	8x 01 04 4A 00 00 0p 0q FF	
CAM_Iris	Reset	8x 01 04 0B 00 FF	Iris setting
	Up	8x 01 04 0B 02 FF	pq = iris position (0h, 05h-11h)
	Down	8x 01 04 0B 03 FF	See Iris Values – CAM_Iris Command
	Direct	8x 01 04 4B 00 00 0p 0q FF	
	Corresponds to <code>camera ccu set iris</code> in Telnet API.		
CAM_Gain	Reset	8x 01 04 0C 00 FF	Iris gain setting
	Up	8x 01 04 0C 02 FF	pq = gain position (01h – 0Fh)
	Down	8x 01 04 0C 03 FF	p = gain limit (04h-0Fh)
	Direct	8x 01 04 4C 00 00 0p 0q FF	See Iris Gain and Gain Limit Values – CAM_Gain Command
	+Gain Limit	8x 01 04 2C 0p FF	
	Corresponds to <code>camera ccu set gain</code> in Telnet API.		
CAM_BackLight	On	8x 01 04 33 02 FF	Backlight compensation On/Off
	Off	8x 01 04 33 03 FF	
	Corresponds to <code>camera ccu set backlight_compensation</code> in Telnet API.		

Command Set	Command	Command Packet	Comments
CAM_WD	On	8x 01 04 3D 02 FF	Wide Dynamic Range On
	Off	8x 01 04 3D 03 FF	Wide Dynamic Range Off
	Corresponds to <code>camera ccu set wide_dynamic_range</code> in Telnet API.		
CAM_Aperture	Reset	8x 01 04 02 00 FF	Aperture setting pq = aperture position (0h-0fh)
	Up	8x 01 04 02 01 FF	
	Down	8x 01 04 02 02 FF	
	Direct	8x 01 04 42 00 00 0p 0q FF	
	Corresponds to <code>camera ccu set detail</code> in Telnet API.		
CAM_Chroma	Direct	8x 01 7E 55 00 00 0p 0q FF	pq: 00h – 14h
	Corresponds to <code>camera ccu set chroma</code> in Telnet API.		
CAM_GammaOffset	Direct	8x 01 04 1E 00 00 00 0s 0t 0u FF	s: polarity offset (0 is plus, 1 is minus) tu: offset s=0 (00h to 40h) offset s=1 (00h to 10h)
	Corresponds to <code>camera ccu set gamma</code> in Telnet API.		

Shutter Speed Values (CAM_Shutter)

Value	60/59.94/30/29.97 fps	50/25 fps
0x15	1/10000	1/10000
0x14	1/6000	1/6000
0x13	1/4000	1/3500
0x12	1/3000	1/2500
0x11	1/2000	1/1750
0x10	1/1500	1/1250
0x0F	1/1000	1/1000
0x0E	1/725	1/600
0x0D	1/500	1/425
0x0C	1/350	1/300
0x0B	1/250	1/215
0x0A	1/180	1/150
0x09	1/125	1/120
0x08	1/100	1/100
0x07	1/90	1/75
0x06	1/60	1/50
0x05	1/30	1/25
0x04	1/15	1/12
0x03	1/8	1/6
0x02	1/4	1/3
0x01	1/2	1/2
0x00	1/1	1/1

Iris Values (CAM_Iris)

Value	Iris
0x11	F1.6
0x10	F2
0x0F	F2.4
0x0E	F2.8
0x0D	F3.4
0x0C	F4
0x0B	F4.8
0x0A	F5.6
0x09	F6.8
0x08	F8
0x07	F9.6
0x06	F11
0x05	F14
0x00	CLOSED

Iris Gain and Gain Limit Values (CAM_Gain)

Iris Gain			Iris Gain Limit		
Value	Steps	Gain in dB	Value	Steps	Gain in dB
0x0F	28	77.8	0x0F	28	77.8
0x0E	26	44.4	0x0E	26	44.4
0x0D	24	41.0	0x0D	24	41.0
0x0C	22	37.5	0x0C	22	37.5
0x0B	20	34.1	0x0B	20	34.1
0x0A	18	30.7	0x0A	18	30.7
0x09	16	27.3	0x09	16	27.3
0x08	14	23.9	0x08	14	23.9
0x07	12	20.5	0x07	12	20.5
0x06	10	17.1	0x06	10	17.1
0x05	8	13.7	0x05	8	13.7
0x04	6	10.2	0x04	6	10.2
0x03	4	6.8			
0x02	2	3.4			
0x01	0	0			

Color and Light Management Inquiry Commands

Inquiry Command	Command	Response Packet	Comments
CAM_WBModelInq	8x 09 04 35 FF	y0 50 00 FF	Auto
		y0 50 05 FF	Manual
CAM_RGainInq	8x 09 04 43 FF	y0 50 00 00 0p 0q FF	pq: Red gain
CAM_BGainInq	8x 09 04 44 FF	y0 50 00 00 0p 0q FF	pq: Blue gain
CAM_AEModelInq	8x 09 04 39 FF	y0 50 00 FF	Auto
		y0 50 03 FF	Manual
CAM_ShutterPosInq	8x 09 04 4A FF	y0 50 00 00 0p 0q FF	pq: Shutter position
CAM_IrisPosInq	8x 09 04 4B FF	y0 50 00 00 0p 0q FF	pq: Iris position
CAM_GainPosInq	8x 09 04 4C FF	y0 50 00 00 0p 0q FF	pq: Gain position
CAM_WDModelInq	8x 09 04 3D FF	y0 50 02 FF	On
		y0 50 03 FF	Off
CAM_BackLightModelInq	8x 09 04 33 FF	y0 50 02 FF	On
		y0 50 03 FF	Off
CAM_ApertureInq	8x 09 04 42 FF	y0 50 00 00 0p 0q FF	pq: Aperture gain
CAM_ChromaInq	8x 09 7E 55 FF	y0 50 05 00 00 00 0p FF	p: 0 – Eh
CAM_GammaOffsetInq	8x 09 04 1E FF	y0 50 00 00 00 0s 0t 0u FF	s: Polarity offset (0 is plus, 1 is minus) tu: Offset s=0 (00h to 40h) Offset s=1 (00h to 10h)

Other Commands

Command Set	Command	Command Packet	Comments
CommandCancel		8x 2p FF	p= socket (1 or 2)
CAM_Power	On	8x 01 04 00 02 FF	Power on
	Off	8x 01 04 00 03 FF	Power off
Corresponds to <code>camera standby</code> in Telnet API.			
CAM_Tally	On	8x 01 7E 01 0A 00 02 FF	
	Off	8x 01 7E 01 0A 00 03 FF	
CAM_NR	--	8x 01 04 53 0p FF	p = noise reduction level (0: off, 1 – 5)
CAM_Mute	On	8x 01 04 75 02 FF	Video mute on/off
	Off	8x 01 04 75 03 FF	
	Toggle	8x 01 04 75 10 FF	
Corresponds to <code>video mute</code> in Telnet API.			

Other Inquiry Commands

Inquiry Command	Command	Response Packet	Comments
CAM_PowerInq	8x 09 04 00 FF	y0 50 02 FF	On
		y0 50 03 FF	Off (standby)
	Corresponds to <code>camera standby get</code> in Telnet API		
CAM_TallyInq	8x 09 7E 01 0A FF	y0 50 02 FF	On
		y0 50 03 FF	Off
CAM_NRInq	8x 09 04 53 FF	y0 50 0p FF	Noise reduction p: 00h to 05h
CAM_MuteModelInq	8x 09 04 75 FF	y0 50 02 FF	On
		y0 50 03 FF	Off
	Corresponds to <code>video mute get</code> in Telnet API		
IPAddressInq	8x 09 08 4E 00 00 FF	90 50 49 50 00 00 00 0p 0p 0p 0q 0q 0q 0r 0r 0r 0s 0s 0s FF	pppqqrrrsss = IP address Example: 90 50 49 50 00 00 00 00 01 00 00 03 00 02 04 00 01 09 00 FF = 10.30.240.190
Vaddio_ModelInq	8x 09 08 0e FF	y0 50 05 08 00 00 00 FF	ConferenceSHOT 10

Specifications

Camera and Image

Image device	1/2.8-type Exmor CMOS sensor	Pixels	2.14 million (effective)
IP (H.264) RTSP Video Resolutions	1080p down to 180p 1080p at 30/25/15; others 60/30/25/15	USB 3.0 (UVC) Video Resolutions	1080p down to 180p at 60/30/15
Pan angle and speed	± 165°, up to 90°/sec	Tilt angle and speed	+90° -30°, up to 90°/sec
Lens and horizontal FOV	10x optical zoom, 67.0° wide to 7.6° tele, f=3.8mm to 38mm, F1.8 to F3.4 Super-wide: 11x optical zoom, 74° wide to 7.6° tele, f=3.8mm to 41.8mm, F1.8 to F3.4		
Min. working distance	10mm (wide), 1.0m (tele)	Min. illumination	100+ lux recommended
Aperture/detail	16 steps	Gain	Auto or manual
Backlight compensation	On or off	White balance	Auto, manual, One-Push
Focusing system	Auto or manual	Noise reduction	On or off
Sync system	Internal	S/N ratio	Over 50 dB
Remote management	Web interface, Telnet, RS-232	Power	12 VDC, 3.0 A

Physical and Environmental

Height	6.3 in. (163 mm)	Operating temperature	0°C to +40°C (32°F to 104°F)
Width	6.1 in. (155 mm)	Operating humidity (relative)	20% to 80% non-condensing
Depth	5.5 in. (145 mm)	Storage temperature	-5°C to +60° C (23°F to 140°F)
Weight	3.0 lbs.(1.36 kg)	Storage humidity (relative)	20% to 80% non-condensing

Specifications are subject to change without notice.

Troubleshooting and Care

When the camera doesn't behave as you expect, check the indicator light on the front before you do anything else.

Use this table to determine whether it's time to call Vaddio Technical Support.

Power and Control

What is it doing?	Possible causes	Check and correct
Nothing. The light on the front is off and no video is available.	At least one of the cables is bad.	Check using known good cables.
	The wall outlet is not active. (Check by finding out if it powers something else, such as a laptop or phone charger.)	Use a different outlet.
	The camera or its power supply is bad.	Contact your reseller or Vaddio Technical Support.
The light on the front of the camera is off but the web interface and video are available.	The status light is turned off.	You can turn it on again using the LED On setting on the General tab of the System page, or using the Telnet command <code>camera led on</code> .
The camera is not responding to the remote and the light is yellow.	A firmware update is in progress.	Wait a few minutes, and try again when the light turns blue.
The camera's web UI is available but the camera does not respond to commands via RS-232 connection.	The RS-232 cable is not connected, or is bad.	Connect a known good cable.
	The camera's RS-232 settings don't match the settings on the controlling device.	Check the settings at both ends to be sure they match. The camera's baud rate can be viewed but not changed on the System page in the web UI.

Video and Streaming

What is it doing?	Possible causes	Check and correct
No H.264 video stream.	IP streaming is not enabled.	Enable IP streaming: Streaming page in the web interface.
No USB video stream.	USB streaming is not enabled.	Enable USB streaming: Streaming page in the web interface.
Black and white video.	The IR cut filter is on. Send the Telnet command <code>camera icr get</code> to verify.	Send the Telnet command <code>camera icr icr off</code> to turn off the IR cut filter and return to normal video.
Artifacts such as green "sparkles" in the video from the HDMI output.	Poor HDMI or DVI connection.	Be sure the HDMI/DVI cable is fully seated.
	Bad HDMI/DVI cable.	Replace the cable.

Other Issues

What is it doing?	Possible causes	Check and correct
The camera loses all its settings when power is cycled.	All the DIP switches are in the ON (down) position. (Verify on the DIP Switches tab of the System page.)	Set the DIP switches to their proper positions. Default is all OFF (up). See Switch Settings for more information.
Status light continues to blink blue.	The USB cable is not connected.	Connect the USB cable.
Status light blinks yellow	Pan or tilt motor is out of calibration	Reset the pan and tilt motors. See Correct a Motor Calibration Error (next section).

Status Indicator Light

The light in the camera's base indicates its current state.

- Blue – Camera is active
- Purple – Standby mode or booting
- Yellow – Firmware update is in progress
- Blinking blue – USB cable is disconnected (UC color scheme)
- Blinking red – Video mute is on (UC color scheme)
- Blinking yellow – Motor out of calibration

Caution

Do not remove power or reset the camera while the indicator is yellow, showing a firmware update in progress. Interrupting a firmware update can make the camera unusable.

Note

By default, the camera's status indicator light is active during normal operation; however, it can be configured to remain off when the camera is powered up. The camera may be sending video even if the light is off.

Correct a Motor Calibration Error

If the web interface presents an error message about the motors, or if the camera's status light is blinking yellow, you will need to reset the pan and tilt motors.

1. On the Camera Controls page, select Settings to open the pan and tilt settings box;
OR
On the System page, go to the Firmware tab if you are on a different tab.
2. Select Pan-Tilt Reset. The motors recalibrate. This takes a few seconds.

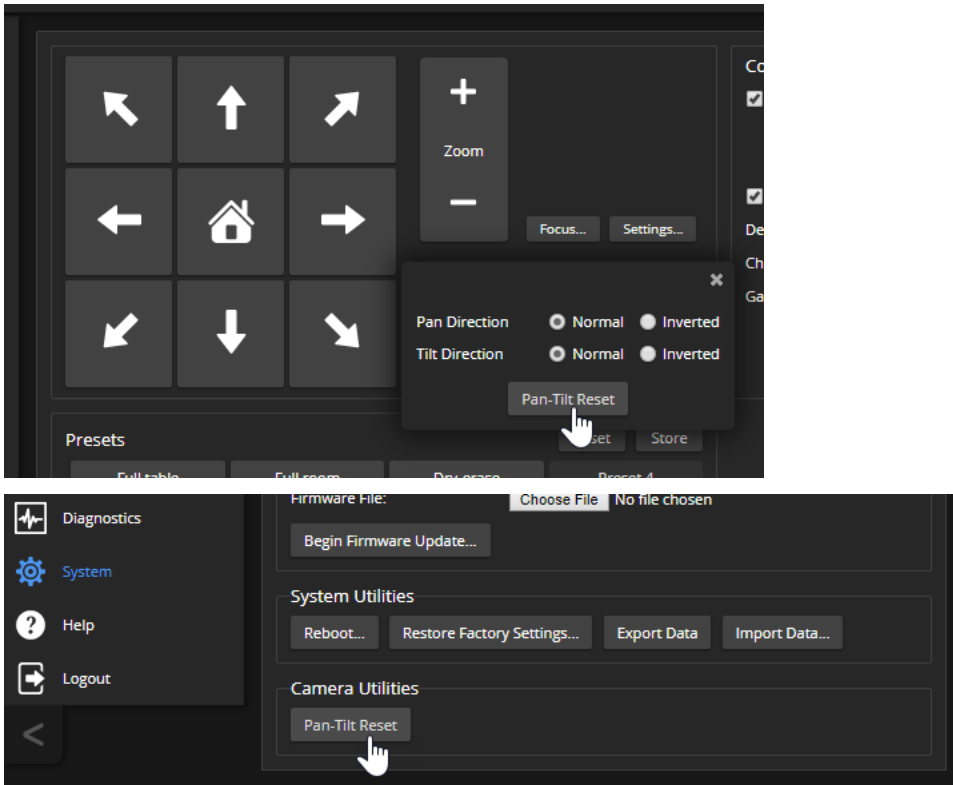

Restoring Default Camera Settings

This returns the camera to its original state. If you export the camera's configuration before restoring factory defaults, you will be able to restore the room label, time zone information, and home information by importing the configuration afterward.

Using the switches on the back of the camera: Set all DIP switches DOWN and cycle the power to reload the default camera settings. Then return all DIP switches to the desired settings.

From the web interface: Log on using the admin account, go to the System page's Firmware tab, and select Restore Factory Settings.

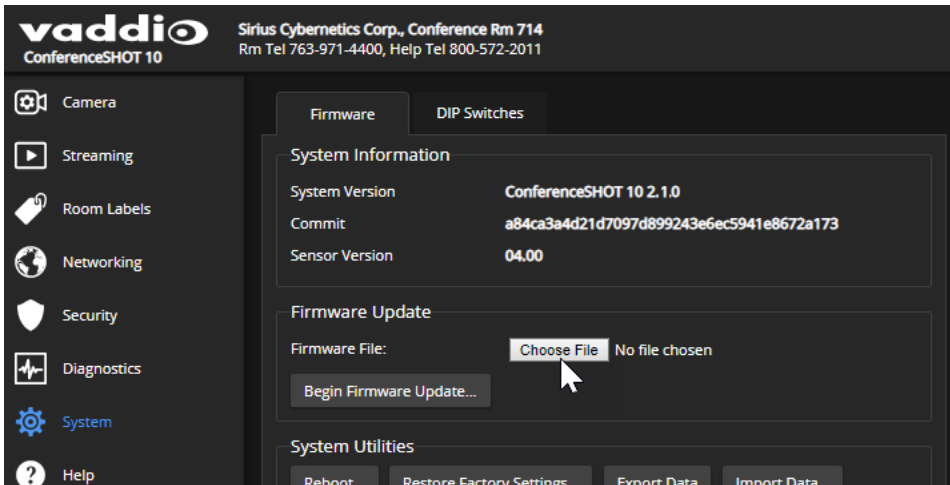

Operation, Storage, and Care

For smears or smudges on the product, wipe with a clean, soft cloth. Use a lens cleaner on the lens. Do not use any abrasive chemicals.

Keep this device away from food and liquids.

Do not operate or store the device under any of the following conditions:

- Temperatures above 40° C (104° F) or below 0° C (32° F)
- High humidity, condensing or wet environments
- Inclement weather
- Severe vibration
- Between converging tectonic plates
- Dry environments with an excess of static discharge

Do not attempt to take this product apart. There are no user-serviceable components inside.

Glossary

auto white balance

A setting that allows the camera to manage color adjustments automatically.

backlight compensation

A setting that reduces contrast to adjust for bright light behind the main subject of the shot.

bandwidth

Data transfer rate (bits per second) for the stream. In some cases, using a high bandwidth can slow down other network traffic. On networks with very low bandwidth, video issues may result. Streaming at a lower resolution or frame rate can reduce bandwidth usage.

chroma

A setting that adjusts color intensity.

detail

A setting that adjusts image sharpness. If detail is set too low, the image may appear unrealistically smooth – like an episode of Moonlighting.

DHCP

Dynamic Host Configuration Protocol. A network management protocol that assigns an IP address to a device automatically when it is connected to the network.

DIP switches

An array of switches designed for installation on a circuit board. (DIP = Dual Inline Package; refers to the physical form.) Our engineers are never going to stop calling them that, so our web interface will keep on saying it.

DIY

Do It Yourself. As in, "You can copy information from this document to create a DIY room guide customized for your conference room." Yes! You can do that! In fact, the "Info for DIY Room Guides" document is specifically designed for you to adapt and customize.

far end

(conferencing) A location in the conference other than the one where you are. Far-end video is what you typically see in a conference – the people at the other end of the call.

Field of View (FOV)

How wide the video image is. Vaddio measures horizontal field of view. Some manufacturers use diagonal field of view, which yields a bigger number for the same actual image area. Tilt your head to one side and diagonal FOV will make sense.

flombodulator

A technically complex item the name of which you can't recall at the moment.

frame rate

The number of output video frames per second. Different outputs (such as the IP stream and the USB stream) may use different frame rates. For streaming, higher frame rates use more bandwidth.

full-duplex

Simultaneous two-way (or multi-way) audio; conference participants at the near end can talk and still hear the participants at the far end(s), as in a face-to-face meeting.

gamma

A setting that adjusts the range (gray density) between bright areas and shadows.

gateway

Network information automatically assigned in a DHCP network. If installing equipment on a non-DHCP network, get this information from the network administrator.

HDMI

A video output format; may also carry audio information.

home (camera)

The settings to which the camera returns after a reboot or on exiting standby mode. Depending on the camera's capabilities, home may include zoom, color and lighting settings, and (for PTZ cameras) pan/tilt position.

IP address

Where a given device is on the IP network, logically. The IP address enables the network to route data to the right device – and that's the reason IP address conflicts are bad.

IP address conflict

Two or more devices attempting to use the same IP address on a network. Results are unpredictable but never good.

LED

Light-Emitting Diode. An indicator light.

near end

(conferencing) Your location in a conference. When you mute the video, your camera stops sending near-end video.

NTP

Network Time Protocol. Ensures that NTP-enabled devices on the network all show the same system time, so timestamps are accurate.

PoE, PoE+, PoE++

Power over Ethernet; a means of powering a device using its network connection. Requires a mid-span power injector. PoE+ and PoE++ deliver more power than PoE.

preset

A stored camera position. Contains pan, tilt, and zoom position; may also include color settings.

RCLB

Really Cool Logo Badge. A visual cue that the device is a genuine Vaddio product. Accept no substitutes!

resolution

1. The image size. For Vaddio cameras, resolution is expressed in terms of digital TV standards, with 1080p being the default in most cases. Resolution and frame rate are set together on Vaddio cameras.
2. The thing that usually flies out the window by January 10th.

RTSP

Real-Time Streaming Protocol. Used for streaming video and audio over your network.

soft conferencing client

A conferencing application (such as Zoom, Google Hangouts, or Skype for Business) that uses a computer rather than requiring a conferencing codec.

streaming protocol

A set of rules that define how video and audio data are sent over the network. See RTMP and RTSP.

subnet mask

Network information automatically assigned in a DHCP network. If installing equipment on a non-DHCP network, get this information from the network administrator.

UCC, UC conferencing

Unified Communications Conferencing; refers to soft-client conferencing (such as Zoom or Skype for Business) using a computer with USB-connected peripherals.

USB 2

An older, lower-speed USB protocol; good for audio but offers lower maximum resolutions for video conferencing. USB 2 products can be connected to USB 2 or USB 3 ports on your computer.

USB 3

A high-speed USB protocol, capable of handling high-quality video and audio as in conferencing applications. USB 3 products should be connected to USB 3 ports; performance may be degraded otherwise.

UVC drivers

(Universal Video Class) Standard USB video drivers used by Vaddio cameras. They're the reason your computer doesn't have to stop and download a driver when you connect your new Vaddio USB camera to it.

UVC extensions

Controls in UVC drivers to allow participants at the far end of a conference to control your camera, if it processes UVC commands. The administrator may choose to disable these.

Compliance and Conformity Statements

Compliance testing was performed to the following regulations:

FCC Part 15 (15.107, 15.109), Subpart B	Class A
ICES-003, Issue 54: 2012	Class A
EMC Directive 2014/30/EU	Class A
EN 55032: 2015	Class A
EN 55024: November 2010	Class A
IEC 60950-1:2005 (2nd Edition); Am 1: 2009 + Am 2: 2013	Safety
EN 60950-1: 2006 + A11: 2009 + A1: 2010 + A12: 2011 + A2: 2013	Safety

FCC Part 15 Compliance

This equipment has been tested and found to comply with the limits for a Class A digital device, pursuant to Part 15, Subpart B, of the FCC Rules. These limits are designed to provide reasonable protection against harmful interference when the equipment is operated in a commercial environment. This equipment generates, uses, and can radiate radio frequency energy and, if not installed and used in accordance with the instruction manual, may cause harmful interference to radio communications. Operation of this equipment in a residential area is likely to cause harmful interference in which case the user will be required to correct the interference at his/her own expense.

Operation is subject to the following two conditions: (1) This device may not cause interference, and (2) This device must accept any interference including interference that may cause undesired operation of the device.

Changes or modifications not expressly approved by Vaddio can affect emission compliance and could void the user's authority to operate this equipment.



ICES-003 Compliance

This digital apparatus does not exceed the Class A limits for radio noise emissions from digital apparatus set out in the Radio Interference Regulations of the Canadian Department of Communications.

Le présent appareil numérique n'émet pas de bruits radioélectriques dépassant les limites applicables aux appareils numériques de la classe A prescrites dans le Règlement sur le brouillage radioélectrique édicté par le ministère des Communications du Canada.



European Compliance

This product has been evaluated for Electromagnetic Compatibility under the EMC Directive for Emissions and Immunity and meets the requirements for a Class A digital device. In a domestic environment this product may cause radio interference in which case the user may be required to take adequate measures.

Standard(s) To Which Conformity Is Declared:



EMC Directive 2014/30/EU

EN 55032: 2015 – Conducted and Radiated Emissions

EN 55024: November 2010 – Immunity

IEC 60950-1: 2005 (2nd Edition); Am 1: 2009 + Am 2: 2013 – Safety

EN 60950-1: 2006 + A11: 2009 + A1: 2010 + A12: 2011 + A2: 2013 – Safety

IEC 62368-1: 2014 (2nd Edition) – Safety

Warranty and Return Policy

Hardware warranty: Two (2) year limited warranty on all parts and labor for Vaddio manufactured products. Vaddio warrants its manufactured products against defects in materials and workmanship for a period of two years from the day of purchase, to the original purchaser, if Vaddio receives notice of such defects during the warranty. Vaddio, at its option, will repair or replace products that prove to be defective. Vaddio manufactures its hardware products from parts and components that are new or equivalent to new in accordance with industry standard practices.

Exclusions: The above warranty shall not apply to defects resulting from improper or inadequate maintenance by the customer, customers applied software or interfacing, unauthorized modifications or misuse, mishandling, operation outside the normal environmental specifications for the product, use of the incorrect power supply, modified power supply or improper site operation and maintenance. OEM and special order products manufactured by other companies are excluded and are covered by the manufacturer's warranty.

Vaddio Customer Service: Vaddio will test, repair, or replace the product or products without charge if the unit is under warranty. If the product is out of warranty, Vaddio will test then repair the product or products. The cost of parts and labor charge will be estimated by a technician and confirmed by the customer prior to repair. All components must be returned for testing as a complete unit. Vaddio will not accept responsibility for shipment after it has left the premises.

Vaddio Technical Support: Vaddio technicians will determine and discuss with the customer the criteria for repair costs and/or replacement. Vaddio Technical Support can be contacted by email at support@vaddio.com or by phone at one of the phone numbers listed on support.vaddio.com.

Return Material Authorization (RMA) number: Before returning a product for repair or replacement request an RMA from Vaddio's technical support. Provide the technician with a return phone number, e-mail address, shipping address, product serial numbers and original purchase order number. Describe the reason for repairs or returns as well as the date of purchase. See the General RMA Terms and Procedures section for more information. RMAs are valid for 30 days and will be issued to Vaddio dealers only. End users must return products through Vaddio dealers. Include the assigned RMA number in all correspondence with Vaddio. Write the assigned RMA number clearly on the shipping label of the box when returning the product. All products returned for credit are subject to a restocking charge without exception. Special order products are not returnable.

Voided warranty: The warranty does not apply if the original serial number has been removed or if the product has been disassembled or damaged through misuse, accident, modifications, use of incorrect power supply, use of a modified power supply or unauthorized repair.

Shipping and handling: Vaddio will not pay for inbound shipping transportation or insurance charges or accept any responsibility for laws and ordinances from inbound transit. Vaddio will pay for outbound shipping, transportation, and insurance charges for all items under warranty but will not assume responsibility for loss and/or damage by the outbound freight carrier. If the return shipment appears damaged, retain the original boxes and packing material for inspection by the carrier. Contact your carrier immediately.

Products not under warranty: Payment arrangements are required before outbound shipment for all out of warranty products.

General RMA Terms and Procedures: RMA's are valid for 30 days and will be issued to Vaddio dealers only.

- End users must return products through Vaddio dealers.
- Before a defective product can be authorized to send in for repair, it must first go through the troubleshooting process with a member of the Vaddio Technical Support team.
- Products authorized for repair must have a valid RMA (Return Material Authorization) number.
 - Vaddio RMA Team will issue the RMA number.
 - An RMA number is to be included in all correspondence with Vaddio.
 - The RMA number must appear clearly on the shipping label (not the box) when the product is returned.
 - A packing slip must be included on the inside of the box with the RMA number listed and reason for RMA return.
- Products received at Vaddio that do not have a valid RMA number clearly marked on the outside of the shipping container may be refused and returned to sender.
- Boxes showing external damage will be refused and sent back to the sender regardless of the clearly marked RMA number and will remain the responsibility of the sender.

RMA Charges (Restocking): All qualified returns must be made in unopened, original packaging with all original materials.

- Initial shipments of equipment that are refused upon attempted delivery, for any reason, are subject to restocking charges.
- The Dealer has up to 60 days from the date of purchase to return Vaddio product for credit for future purchases of Vaddio product only.
- The Dealer has 61 to 90 days from the date of purchase to return Vaddio product with a 15% restocking fee or \$50.00 fee, whichever amount is greater
- The Dealer has up to 30 days from the date of purchase to return OEM and other manufacturer's products with a 15% restocking fee or \$50.00 fee, whichever amount is greater.
- NOTE: Special Order products from other manufacturers (identified in the Vaddio Price Guide as noncancelable, nonreturnable and not refundable) are not eligible for advance replacement from Vaddio.

Advance Replacement Policies: For Vaddio manufactured products, advance replacement will be provided for up to one (1) year after the initial shipment of products.

- NOTE: OEM and other manufacturer's products are excluded from the Vaddio advance replacement policy. Advance replacement will be provided for up to 30 days after initial shipment of OEM products. Thereafter, a return to Vaddio and factory repair is offered during the other manufacturer's warranty period. Vaddio will determine if the returned product is qualified for the OEM warranty.
- NOTE: Special Order products from other manufacturers (identified in the Vaddio Price Guide as noncancelable, nonreturnable and not refundable) are not eligible for advance replacement from Vaddio.

Advance Replacement Procedures: The Vaddio Dealer must submit a non-revocable purchase order for advance replacement equipment at normal dealer pricing. Credit shall be issued upon complete product return (including all accessories) for dealers with Net 30 terms. For credit card accounts, charges will be assessed to the credit card for the replacement and credited back upon complete product return.

- Returns must be made in the original Vaddio packaging with all original materials if at all possible. Vaddio products with missing original materials will be billed to the dealer at dealer price.
- NOTE: OEM products must be returned in the original packaging with all materials and the RMA number written on the shipping label only and not on the OEM box. If the return is incomplete and/or the OEM box is defaced, the product shall be returned to the dealer and the RMA will not be credited.
- Equipment returned with “No Trouble Found” after advanced replacement will be assessed a full 15% or \$50.00 restocking fee (whichever is greater) for each item and may also be assessed for additional charges to compensate for wear, damages and reconditioning.
- All returns must be accompanied by RMA # as stated above.
- All Advanced Replacement products are sent via 2-day service in the continental USA. If the product is requested to be sent via priority or overnight shipping, the Dealer shall pay shipping costs. The dealer can elect to supply their preferred shipping account number.
- International customers are responsible for all freight charges for equipment returned to Vaddio, including international shipping, taxes, and duties, insurance and all other associated logistic charges.

Warranty Repair Terms and Procedures: Vaddio will repair any product free of charge, including parts and labor, within the terms outlined in the warranty agreement for that product.

- Customers must provide proof of the product’s purchase date.
- Product that is within the warranty period will be repaired under the non-warranty terms if:
 - The equipment has been damaged by negligence, accident, act of God, mishandling, used with the incorrect, modified or extended power supply or has not been operated in accordance with the procedures described in the operating and technical instructions.
 - The equipment has been altered or repaired by other than the Manufacturer or an authorized service representative.
 - Adaptations or accessories other than those manufactured or provided by the Manufacturer have been made or attached to the equipment, which in the determination of the Manufacturer, shall have affected the performance, safety or reliability of the equipment; or the equipment’s original serial number has been modified or removed.
- Customer is responsible for shipping charges to send defective product under warranty to Vaddio. Vaddio will pay ground service return shipping charges during the 2nd year of the warranty period.
- Standard return shipping method for products under warranty, but out of the advance replacement warranty period, is ground shipment. Extra charges associated with priority shipping, when requested, will be the responsibility of the customer.

Non-Warranty Repair Terms: Vaddio will repair any non-obsolete product that does not meet the terms of the warranty. Non-warranty repair terms are as follows:

- The customer is responsible for, and agrees to pay, all parts and labor costs associated with the repair. Standard non-warranty repair charges are outlined below.
- Customers must provide payment method and one of the following, prior to receiving an RMA:
 - Hard copy of a PO, for dealers with Net 30 terms and in good standing with Vaddio.
 - Valid credit card number - Credit card will be charged upon shipping repaired product back to customer.
- Request for COD: Customers will be notified of COD charges prior to shipping repaired unit.
- Customer is responsible for all shipping charges both to and from Vaddio, and may use their own carrier.
- Customers will receive a courtesy call notifying them of total repair charges prior to return shipping.

Non-Warranty Repair Charges: Total repair charges (per unit) for a non-warranty repair consist of the following:

- Cost of any replacement parts needed to repair the defect.
- Labor costs billed per hour after minimum charges/time.
- Labor charges include troubleshooting and repair time only.
- Burn-in time and final test time is not included in the labor charges.
- Labor time is rounded to the nearest quarter hour.
- Labor charges are billed at the prevailing rate for the category of equipment repaired, after minimum charges/time. For prevailing labor rates, please contact the Vaddio technical support.
- All shipping and handling costs are the responsibility of the customer for non-warranty repairs.

Minimum Labor Charges: All non-warranty repairs are subject to a minimum evaluation/repair labor charge even if there is no problem found. Please contact Vaddio technical support for the current applicable rate.

Repair Charge Estimates: Estimates on repair charges for a specific problem will not be given before an RMA is issued and the actual product has been evaluated by a Vaddio technician. Repair estimates will be given after the repair department receives and evaluates the unit.

- Customers requesting an estimate on repair charges must do so up front when they call in for an RMA. The RMA team will call or email with the estimate after evaluating the unit and before proceeding with the repair.
- Any product evaluated for a repair estimate is still subject to the minimum labor charges even if the customer decides not to proceed with the repair.
- Vaddio does not guarantee estimates given on repair charges. Actual repair costs may exceed the estimate.
- Customer is responsible for actual repair charges, regardless of estimate.

Repair Policy Notes:

- **Duration of Repair:** Products are repaired on a first come first serve basis. The turn-a-round time of a particular repair is dependent upon circumstances such as product type, the nature of the problem and current repair volumes. Requests for expedited repair service will be considered on a case-by-case basis.
- **Repair Warranty:** Vaddio guarantees all of its repair work, performed on non-warranty items, for 90 days from the day the repaired product is shipped back to the customer. If the original problem described was not resolved or reoccurs within the 90-day period, Vaddio will repair the unit free of labor charges. However additional material charges may apply unless the parts used to affect the repair are again deemed defective.

Photo Credits

This guide may include some or all of these photos.

European Space Agency (ESA) astronaut Samantha Cristoforetti, a Flight Engineer with Expedition 42, photographs the Earth through a window in the Cupola on the International Space Station

By NASA - https://blogs.nasa.gov/ISS_Science_Blog/2015/03/06/women-in-space-part-two-whats-gender-got-to-do-with-it/, Public Domain, <https://commons.wikimedia.org/w/index.php?curid=38834990>

Carl Sagan, Bruce Murray, Louis Friedman (founders) and Harry Ashmore (advisor), on the occasion of signing the papers formally incorporating The Planetary Society

By credit NASA JPL - JPL, Public Domain, <https://commons.wikimedia.org/w/index.php?curid=1180927>

Main Control Room / Mission Control Room of ESA at the European Space Operations Centre (ESOC) in Darmstadt, Germany

By European Space Agency - ESOC flickr, Credit: ESA - Jürgen Mai, CC BY-SA 3.0-igo,

<https://commons.wikimedia.org/w/index.php?curid=36743173>

Expedition 42 on orbit crew portrait, International Space Station, Mar. 7, 2015 – Barry Wilmore (Commander) Top, Upside down, to the right cosmonaut Elena Serova, & ESA European Space Agency Samantha Cristoforetti. Bottom center US astronaut Terry Virts, top left cosmonauts Alexander Samokutyaev and Anton Shkaplerov.

By NASA - <https://www.flickr.com/photos/nasa2explore/16166230844/>, Public Domain,

<https://commons.wikimedia.org/w/index.php?curid=38931301>

European Space Agency astronaut Luca Parmitano, Expedition 36 flight engineer, outside the International Space Station

By NASA - <http://spaceflight.nasa.gov/gallery/images/station/crew-36/html/iss036e016704.html>, Public Domain, <https://commons.wikimedia.org/w/index.php?curid=27263573>

Chris Cassidy, Luca Parmitano, and Karen Nyberg, ISS, 2013. Photo Credit: NASA

Nicolas Altobelli, Rosetta Scientist at ESA's European Space Astronomy Centre, Villanueva de la Cañada, Madrid, Spain

By European Space Agency - Nicolas Altobelli talks to the media, CC BY-SA 3.0-igo,

<https://commons.wikimedia.org/w/index.php?curid=36743144>

Andrea Accomazzo, ESA Rosetta Spacecraft Operations Manager, providing a live update from the Main Control Room at ESA's European Space Operations Centre, Darmstadt, Germany during the Rosetta wake-up day.

By European Space Agency - Live update from the Main Control Room, CC BY-SA 3.0-igo,

<https://commons.wikimedia.org/w/index.php?curid=36743150>

Sleeping goose

By ladypine - Own work, CC BY-SA 3.0, <https://commons.wikimedia.org/w/index.php?curid=1695227>

By Rick Dikeman - Image:Wayne Gretzky 1997.jpg, CC BY-SA 3.0,

<https://commons.wikimedia.org/w/index.php?curid=945698>

Photo AS11-40-5948, Aldrin assembles seismic experiment, by National Aeronautics and Space Administration, courtesy of the NASA History Office and the NASA JSC Media Services Center

Index

A

- admin password 16, 23
 - changing 23
 - default 16
- anatomy of the camera 3-4
- API 58, 60-61, 63-66
 - RS-232 (VISCA) 58, 60-61, 63-66
- auto focus 33, 48
- auto iris 31, 50-51
- auto white balance 31-32, 50-51

B

- backing up a configuration 24
- backlight compensation 31-32, 50-51
- bandwidth 39
- baud rate setting (DIP switch) 41
- bit rate (IP streaming setting) 39
- blue gain 31-32, 50-51
- browser compatibility 14

C

- cable connectors 4, 8
- calibration fault, correcting 52, 70
- camera mount 5-6, 10
 - installing 6
- camera placement 5
- camera select 12-13
- camera specifications 67
- camera standby position 43
- capabilities 1, 67
- CCU settings 32, 49-51
- ceiling-mounted cameras 6
- cheat sheet 12-13, 32
 - color adjustment 32
 - lighting and image quality 32
- chroma setting 31-32, 50-51
- cleaning 71
- color codes for status light 11, 69
- color settings 31-32, 50-51
- command history 57
- command set, RS-232 (VISCA) 58, 60-61, 63-66
- compatibility, browsers 14
- conferencing 36-37
- configuration, saving or restoring 24

- connection diagram 9
- connector pin-out, RS-232 8
- connectors 4
- Constant Bit Rate (IP streaming setting) 39
- controls available to admin 16
- controls available to non-admin user 16
- Controls page (web) 42
- custom home position 29

D

- damage, preventing 2, 5, 8
- default IP address 19
- default settings, restoring 56, 71
- detail setting 31-32, 50-51
- DHCP vs. non-DHCP networks 19
- diagnosing issues 55, 68
- diagnostic logs 28
- Diagnostics page (web) 28
- diagram, connection 9
- DIP switch settings
 - reading from web interface 41
- DIP switches 4, 7, 41
 - location 4
 - settings 7, 41
 - soft 41
- directional controls 12-13, 43

E

- Ethernet port 4

F

- factory defaults, restoring 56, 71
- fault isolation 55, 68
- firmware update 26
- firmware version 57
- focus 12-13, 33, 48

G

- gain 31-32
 - blue 31-32
 - iris 32
 - red 31-32
- gamma setting 31-32
- getting help 28
- guest access 23

H

- Help page (web) 28

home position 29, 43, 45
 custom 29
 hostname 21

I

importing a configuration 24
 inactive sessions (web interface) 23
 indicator light 11, 41, 52, 69
 behavior 41, 52
 color scheme 41
 enabling/disabling 41
 meaning of colors 11, 69
 information, conference room 24
 installation 6, 9-10
 basic connections 9
 camera 10
 camera mount 6
 inverted installation 6
 IP address 12-14, 19, 21
 camera, discovering 14
 default 14, 19, 21
 static, configuring 19, 21
 IP streaming 36, 38-40, 54
 enabling/disabling 36
 settings 38-40, 54
 IR remote 12-13
 iris settings 32, 50-51

L

labels, room 24
 LED control 52
 light, status indicator 11, 41, 52, 69
 behavior 41, 52
 color scheme 41
 enabling/disabling 41
 meaning of colors 11, 69
 lighting settings 50-51
 location of the camera 5, 24
 locations of connectors 4
 log files 28
 login, admin 16
 low-power (standby) state 43, 52-53

M

manual focus 12-13, 33, 48
 Max Bandwidth (IP streaming setting) 39
 media player 36
 motor calibration 52, 70

mount 5-6, 10
 installing 6
 mounting the camera 5, 10
 MTU (IP streaming setting) 40
 muting 42, 53
 video 42, 53

N

navigation buttons, hiding/showing 17
 network configuration 21, 55
 current 55
 network port 4
 Networking page (web) 21
 NTP server 22

O

One Push White Balance 32
 operating environment 5, 71

P

packing list 2
 page 21, 23-24, 28, 36-40, 42
 Controls 42
 Diagnostics 28
 Help 28
 Networking 21
 Room Labels 24
 Security 23
 Streaming 36-40
 pan 12-13, 34-35, 43, 45
 direction 35
 speed 34, 45
 pan/tilt recalibration 52, 70
 part numbers 2
 passwords 16, 23
 admin, default 16
 user, default 16
 Path (IP streaming setting) 40
 performance specifications 67
 physical and environmental specifications 67
 pin-out, RS-232 connector 8
 ping command 55
 point light compensation 32
 power on/power off 12-13, 43, 53
 precautions 2, 5
 for operating the system 5
 presets 12-13, 29, 31, 43, 49
 clearing 13
 moving to 43, 49

- renaming 31
- setting 13, 29, 49
- Pro A/V status light color scheme 41
- product capabilities 1, 67
- product returns and repairs 77

Q

- Quality/Quantization (IP streaming setting) 39
- quick reference 12-13, 32
 - remote control 12
 - Vaddio IR Remote Commander 13

R

- ready state 43, 53
- rebooting 27, 56
- recalibration, pan and tilt 52, 70
- red gain 31-32, 50-51
- remote control 12-13
- requirements 5
 - installation 5
 - mounting 5
- reset 52, 70. See also rebooting; restoring
 - default settings
 - pan and tilt motors 52, 70
- Resolution (IP streaming setting) 38-39
- restoring a configuration 24
- restoring default settings 56, 71
- RJ-45 connectors 8
- room information 24
- Room Labels page (web) 24
- RS-232 commands 58, 60-61, 63-66
 - setting values 63-64
- RS-232 communication settings 8
- RS-232 connector pin-out 8
- RS-232 serial connection 8
- RTMP streaming 36
- RTSP streaming 36, 40

S

- saving a configuration 24
- Security page (web) 23
- settings, default, restoring 56, 71
- shelf-mounted cameras 10
- shelf, camera mount 6
- site requirements 5
- soft DIP switches 41
- software update 26
- solving problems 68
- specifications 67

- speed 12-13, 33-34, 45-48
 - focus 48
 - Global Preset (defined) 33
 - Global Preset Non-Tri-Sync, setting 34
 - manual (defined) 33
 - manual, setting 34
 - pan 34, 45
 - tilt 34, 46
 - zoom 12-13, 34, 47
- standby (low-power) state 43, 52-53
- static IP address 19, 21
 - configuring 19, 21
- status light 11, 41, 52, 69
 - behavior 41, 52
 - color scheme 41
 - enabling/disabling 41
 - meanings of colors 11, 69
- storage environment 71
- storing a configuration 24
- stream viewer 36
- streaming 36-40, 54
 - configuring 37
 - enabling/disabling 36
 - IP 36, 38-39
 - settings 37, 39-40, 54
 - USB 36-37
- Streaming page (web) 36-40
- streaming URL 40
- super-wide mode setting (DIP switch) 41
- supported web browsers 14
- switch location 4
- switch settings 6-7, 41
 - camera ID (DIP switch) 7
 - image flip (DIP switch) 6-7
 - in web interface 41
- syntax help, Telnet commands 57

T

- technical specifications 67
- technical support 28
- Telnet commands 44-58
 - syntax help 44, 57
 - typographical conventions 44
- Telnet session 44, 57-58
 - ending 58
 - history 57
- temperature, operating and storage 71
- third-party control 8, 44

tilt 12-13, 34, 43, 46
 speed 34
time zone 22
troubleshooting 55, 68

U

UC conferencing status light color scheme 41
update 26
URL, RTSP streaming 40
USB port 4
USB stream format (DIP switch) 41
USB streaming 36-37, 54
 configuring 37
 enabling/disabling 36
 settings 54
user password 16, 23
 changing 23
 default 16

V

Vaddio IR Remote Commander 12-13
Variable Bit Rate (IP streaming setting) 39
version, firmware 57
video mute 42, 53
Video Quality (IP streaming setting) 38
video resolution (IP streaming setting) 38
virtual DIP switches 41
VISCA commands 58, 60-61, 63-66
visual parts identification 3-4

W

wall mount 6
 installing 6
warranty 5, 77
web browsers supported 14
web interface 14, 17, 19, 21, 23-24, 28, 36-40,
 42
 accessing 14
 accessing via direct connection 19
 Controls page 42
 Diagnostics page 28
 Help page 28
 navigation button labels 17
 Networking page 21
 Room Labels page 24
 Security page 23
 Streaming page 36-40
wide dynamic range setting 32

Z

zoom 12-13, 34, 43, 47
 speed 12-13, 34, 47

Vaddio is a brand of Legrand AV Inc. · www.legrandav.com · Phone 800.572.2011 / +1.763.971.4400 · Fax +1.763.971.4464 · Email av.vaddio.support@legrand.com

Visit us at support.vaddio.com for firmware updates, specifications, drawings, manuals, technical support information, and more.

©2019 Legrand AV Inc.

Vaddio is a registered trademark of Legrand AV Inc. All other brand names or marks are used for identification purposes and are trademarks of their respective owners. All patents are protected under existing designations. Other patents pending.

A brand of  legrand®

Commercial AV Brands Chief | Da-Lite | Middle Atlantic | Projecta | Vaddio

vaddio®