



Complete Manual for

RoboSHOT CAT-5 Professional PTZ Camera Systems

Including

RoboSHOT QCCU, RoboSHOT QUSB, RoboSHOT QMini,
RoboSHOT QDVI, RoboSHOT QSR, and RoboSHOT AVBMP

Contents

Overview	1
What's in this Guide	2
Camera Features	2
Quick-Connect Features	3
Quick-Connect Universal CCU (QCCU)	3
Quick-Connect USB (QUSB)	3
Quick-Connect USB Mini (QMini)	4
Quick-Connect DVI/HDMI-SR (QDVI)	4
Quick-Connect SR (QSR)	4
Unpacking the Camera System	5
A Quick Look at the Camera	15
Front of the Camera	15
Back of the Camera – RoboSHOT 12 and RoboSHOT 30	16
Back of the Camera – RoboSHOT 12E CAT-5 and RoboSHOT 30E CAT-5	17
A (Quick) Look at the Quick-Connect Devices	18
Quick-Connect Universal CCU Interface	19
Quick-Connect USB Interface	21
Quick-Connect USB Mini Interface	22
Quick-Connect DVI/HDMI-SR Interface	23
Quick-Connect SR Interface	24
Installing the Camera and Quick-Connect Device	25
Don't Void Your Warranty!	25
Before You Start	26
Installing the Wall Mount	26
About Ceiling-Mounted Cameras	26
Video Resolution Setting	27
Camera Behavior Settings – RoboSHOT 12 and RoboSHOT 30	28
Switch Settings for the Universal CCU	29
Switch Settings for the Quick-Connect USB	29
RS-232 Serial Communication Settings	30
RS-232 Connector Pin-Out	30
Cabling Notes	31
Connecting the Camera	31
Basic Connections: RoboSHOT QCCU System	32
Basic Connections: RoboSHOT QUSB System	33
Basic Connections: RoboSHOT QMini System	34
Basic Connections: RoboSHOT QDVI System	35
Basic Connections: RoboSHOT QSR System	36
Basic Connections: RoboSHOT AVBMP	36
Installing the Camera	37

Installing the Quick-Connect Device	38
Powering Up the Camera	38
Status Light	38
Using the IR Remote	39
IR Remote Cheat Sheet	39
IR Remote Details	40
Storing a Preset Using the Remote	40
Clearing a Preset Using the Remote	40
Web Interface	41
Getting the Camera's IP Address	41
Accessing the Web Interface	41
Browser Support	41
User Access	42
Administrative Access	43
Compact Menu View	43
Working with the Quick-Connect Device's Web Interface	44
Getting the Quick-Connect Device's IP Address	44
Quick-Connect USB Mini: Video Mode vs. Control Mode	44
Accessing the Web Interface for the Quick-Connect USB or Quick-Connect USB Mini	45
Web Interface Cheat Sheet	46
System Administration	48
For Non-DHCP Environments: Configuring the Device with a Static IP Address for Initial Installation	49
Configuring the Quick-Connect USB Device with a Static IP Address	51
Changing the Camera's Hostname	53
Changing the Quick-Connect Device's Hostname	53
Optional For DHCP Environments: Changing from a DHCP Address to a Static IP Address	54
Specifying Time Zone and NTP Server	55
Managing Access and Passwords	56
Disabling Telnet Access	56
Enabling or Requiring HTTPS	57
Changing the Admin Password on the Quick-Connect Device	58
Adding Room Information to the Camera's Web Interface	59
Adding Room Information to the Quick-Connect Device's Web Interface	59
Saving (Exporting) or Restoring (Importing) a Camera Configuration	60
Installing a Camera Firmware Update	61
Installing a Quick-Connect USB or Quick-Connect USB Mini Firmware Update	62
Installing a Firmware Update on the Universal CCU	63
Rebooting the Camera	64
Rebooting the Quick-Connect Device	64
Contacting Vaddio Technical Support	65

Accessing the Diagnostic Logs	65
Configuring Camera Behavior	66
Setting the Custom Home Position and Other Preset Shots	66
Renaming Presets and Custom CCU Scenes	67
Initial Lighting and Color Settings	68
Lighting Adjustments	69
Fine-Tuning Image Quality and Color	69
Lighting and Image Quality Cheat Sheet	70
Color Adjustment Cheat Sheet	71
Saving Color and Lighting Settings	71
Adjusting the Focus	72
Speed Adjustments	72
About Tri-Synchronous Motion	72
Setting the Speed for Manual Movements	73
Setting the Speed of Movements to Presets	73
Adjusting Tri-Synchronous Motion Speed	74
Setting the Direction for Camera Movements	75
Reading the Camera's Switches	76
Basic Camera Settings for RoboSHOT 12E CAT-5 and RoboSHOT 30E CAT-5	77
Software-Controlled Video Output Resolution Setting	78
Additional Camera Behavior Settings	78
Configuring Streaming (Quick-Connect USB or Quick-Connect USB Mini)	80
Managing Lighting and Color Adjustments with the Universal CCU	82
A Quick Look at the Menu Controls	82
Adjusting Color	84
Setting the Default Lighting Adjustments	84
Adjusting Light Level and Detail	84
Working with Custom Scenes	85
Adjusting for Cable Length	85
Adjusting the Front Panel Display	86
Operating the Camera from the Web Interface	87
Switching the Camera Off or On (Standby)	87
Stop or Resume Sending Video (Mute)	87
Moving the Camera	88
Zooming In or Out	88
Moving the Camera to a Preset Position	88
Adjusting the Color and Lighting	88
Telnet Command Reference	89
camera home	90
camera pan	90
camera tilt	91

camera zoom	92
camera focus	93
camera preset	94
camera ccu get	95
camera ccu set	96
camera ccu scene	97
camera led	97
camera standby	98
network settings get	98
network ping	99
system reboot	99
system factory-reset	100
version	100
history	101
help	101
exit	101
RS-232 Serial Command Reference	102
Camera Movement, Zoom, and Focus Commands	102
Movement, Zoom, and Focus Inquiry Commands	104
Color and Light Management Commands	105
Shutter Speed Values (CAM_Shutter)	107
Iris Values (CAM_Iris)	108
Iris Gain and Gain Limit Values (CAM_Gain)	108
Color and Light Management Inquiry Commands	109
CCU Scene Commands for the Universal CCU	109
Other Commands	110
Other Inquiry Commands	110
Specifications	111
Cameras	111
Quick-Connect Devices	112
Troubleshooting and Care	114
Check the Status Light First	114
Check the Cables Next	114
Power/Responsiveness Issues	115
Video Issues	116
Camera Control and Other Issues	117
Status Light	117
Restoring Factory Settings from the Web Interface	118
Restoring Factory Default Settings Via Hardware	118
Operation, Storage, and Care	119
Compliance and Conformity Statements	120

FCC Part 15 Compliance	120
ICES-003 Compliance	120
European Compliance	121
Compliance and Conformity Statements for Quick-Connect Devices	122
FCC Part 15 Compliance	122
ICES-003 Compliance	122
European Compliance	123
Warranty and Return Policy	124
Photo Credits	128
Index	129

Overview

This guide covers the RoboSHOT® CAT-5 cameras. These cameras must be used with a Quick-Connect device or with an AV Bridge MATRIX PRO.



RoboSHOT QCCU systems:

- RoboSHOT 12 QCCU, North America – 999-9907-000 (silver/black)
- RoboSHOT 12 QCCU, Europe/UK – 999-9907-001 (silver/black)
- RoboSHOT 12E QCCU, North America – 999-99070-000 (black), 999-99070-000 (white)
- RoboSHOT 12E QCCU, Europe/UK – 999-99070-001 (black), 999-99070-001 (white)
- RoboSHOT 30 QCCU, North America – 999-9917-000 (black), 999-9917-000W (white)
- RoboSHOT 30 QCCU, Europe/UK – 999-9917-001 (black), 999-9917-001W (white)
- RoboSHOT 30 QCCU, Australia/New Zealand – 999-99170-009 (black), 999-99170-009W (white)
- RoboSHOT 30E QCCU, North America – 999-99170-000 (black), 999-99170-000W (white)
- RoboSHOT 30E QCCU, Europe/UK – 999-99170-001 (black), 999-99170-001W (white)
- RoboSHOT 30E QCCU, Australia/New Zealand – 999-99170-009 (black), 999-99170-009W (white)

RoboSHOT QUSB systems:

- RoboSHOT 12 QUSB, North America – 999-9909-000 (silver/black)
- RoboSHOT 12 QUSB, Europe/UK – 999-9909-001 (silver/black)
- RoboSHOT 12 QUSB, Australia/New Zealand – 999-9909-009 (silver/black)
- RoboSHOT 12E QUSB, North America – 999-99090-000 (black), 999-99090-000W (white)
- RoboSHOT 12E QUSB, Europe/UK – 999-99090-001 (black), 999-99090-001W (white)
- RoboSHOT 12E QUSB, Australia/New Zealand – 999-99090-009 (black), 999-99090-009W (white)
- RoboSHOT 30 QUSB, North America – 999-9919-000 (black); 999-9919-000W (white)
- RoboSHOT 30 QUSB, Europe/UK – 999-9919-001 (black); 999-9919-001W (white)
- RoboSHOT 30 QUSB, Australia/New Zealand – 999-9919-009 (black); 999-9919-009W (white)
- RoboSHOT 30E QUSB, North America – 999-99190-000 (black); 999-99190-000W (white)
- RoboSHOT 30E QUSB, Europe/UK – 999-99190-001 (black); 999-99190-001W (white)
- RoboSHOT 30E QUSB, Australia/New Zealand – 999-99190-009 (black); 999-99190-009W (white)

RoboSHOT QMini systems:

- RoboSHOT 12 QMini, North America – 999-9901-000 (silver/black)
- RoboSHOT 12 QMini, Europe/UK – 999-9901-001 (silver/black)
- RoboSHOT 12 QMini, Australia/New Zealand – 999-9901-009 (silver/black)
- RoboSHOT 12E QMini, North America – 999-99010-000 (black), 999-99010-000W (white)
- RoboSHOT 12E QMini, Europe/UK – 999-99010-001 (black), 999-99010-001W (white)
- RoboSHOT 12E QMini, Australia/New Zealand – 999-99010-009 (black), 999-99010-009W (white)
- RoboSHOT 30 QMini, North America – 999-9911-000 (black); 999-9911-000W (white)
- RoboSHOT 30 QMini, Europe/UK – 999-9911-001 (black); 999-9911-001W (white)
- RoboSHOT 30E QMini, North America – 999-99110-000 (black); 999-99110-000W (white)
- RoboSHOT 30E QMini, Europe/UK – 999-99110-001 (black); 999-99110-001W (white)

RoboSHOT QDVI systems:

- RoboSHOT 12 QDVI, North America – 999-9906-000 (silver/black)
- RoboSHOT 12 QDVI, Europe/UK – 999-9906-001 (silver/black)
- RoboSHOT 12E QDVI, North America – 999-99060-000 (black), 999-99060-000W (white)
- RoboSHOT 12E QDVI, Europe/UK – 999-99060-000 (black), 999-99060-000W (white)
- RoboSHOT 30 QDVI, North America – 999-9916-000 (black), 999-9916-000W (white)
- RoboSHOT 30 QDVI, Europe/UK – 999-9916-001 (black), 999-9916-001W (white)
- RoboSHOT 30E QDVI, North America – 999-99160-000 (black), 999-99160-000W (white)
- RoboSHOT 30E QDVI, Europe/UK – 999-99160-001 (black), 999-99160-001W (white)

RoboSHOT QSR systems:

- RoboSHOT 12 QSR, North America – 999-9905-000 (silver/black)
- RoboSHOT 12 QSR, Europe/UK – 999-9905-001 (silver/black)
- RoboSHOT 30 QSR, North America – 999-9915-000 (black), 999-9915-000W (white)
- RoboSHOT 30 QSR, Europe/UK – 999-9915-001 (black), 999-9915-001W (white)

RoboSHOT AVBMP:

- RoboSHOT 12 AVBMP, worldwide – 999-9900-500 (silver/black)
- RoboSHOT 12E AVBMP, worldwide – 999-99000-500 (black), 999-99000-500W (white)
- RoboSHOT 30 AVBMP, worldwide – 999-9910-500 (black), 999-9910-500W (white)
- RoboSHOT 30E AVBMP, worldwide – 999-99100-500 (black), 999-99100-500W (white)

What's in this Guide

This guide covers:

- Unpacking
- Physical features
- Switch settings
- Installation
- Controlling the camera using the IR remote
- Web interface: system administration and performance/behavior configuration
- Telnet and RS-232 API references
- Specifications
- Troubleshooting
- Warranty and compliance/conformity information

For your convenience, the information you need to install this product is also available in the smaller, stand-alone **Installation Guide for RoboSHOT CAT-5 Professional PTZ Camera Systems**, which covers unpacking, physical features, switch settings, installation, and initial power-up.

Download manuals, dimensional drawings, and other information from www.vaddio.com/support.

Camera Features

- Powered by your choice of Quick-Connect device or by an AV Bridge MATRIX PRO for maximum flexibility in installation and output connectivity
- Full HD (native 1080p/60) resolution
- RoboSHOT 12 and RoboSHOT 30: Exmor® 1/2.8 type image sensor
- RoboSHOT 12E CAT-5 and RoboSHOT 30E CAT-5: Exmor R™ back-lit 1/2.5 type, high-speed, low-noise image sensor
- RoboSHOT 12 and RoboSHOT 12E CAT-5: 12x optical zoom – perfect for small to medium rooms
- RoboSHOT 30 and RoboSHOT 30E CAT-5: 30x optical zoom – for medium to large venues such as houses of worship, lecture theaters, IMAG systems
- Tri-Synchronous Motion™ simultaneous 3-axis pan/tilt/zoom movement between presets
- Smooth, silent direct-drive motors – ultra-accurate positioning, from 120° per second down to 0.35° per second
- Web interface for remote administration and operation, integration-ready Telnet or serial RS-232 control, presenter-friendly IR remote control

Quick-Connect Features

Quick-Connect devices provide power and connectivity for the RoboSHOT 12 and RoboSHOT 30 cameras. Tailored to specific environments and situations, they give the RoboSHOT cameras unparalleled flexibility.

Quick-Connect Universal CCU (QCCU)

Best for environments where lighting and color management are priorities, and for installations requiring long cabling distances.

- Full camera control unit functionality – manage lighting and color; store and recall up to 3 CCU scenes
- Supports resolutions up to 1080p/60 from the camera
- Simultaneous HD-SDI, HDMI and HD analog component (YPbPr) outputs
- Up to 500 ft. (152 m) cabling distance
- Tally light shows when the camera is on-air
- Back-lit 8-line menu display
- 1RU form factor; ships with rack mounting brackets



Quick-Connect USB (QUSB)

Versatile USB 2.0 device for environments using soft conferencing applications. Extends HDMI up to 100 ft. (30 m).

- Choice of USB 2.0 MJPEG or IP (H.264) streaming
- Simultaneous HDMI and HD analog component (YPbPr) outputs
- Supports resolutions up to 1080p/60 from the camera
- Up to 100 ft. (30 m) cabling distance
- Standard UVC drivers
- Web interface for network and streaming configuration
- Half-rack form factor; mounting brackets available (not included)



Quick-Connect USB Mini (QMini)

Cost-effective USB 2.0 connectivity for soft conferencing applications, designed for environments where only one camera is needed.

- USB streaming/capture only
- Standard UVC drivers
- Up to 100 ft (30 m) cabling distance
- Compact form factor



Quick-Connect DVI/HDMI-SR (QDVI)

Connectivity solution for use with legacy equipment.

- Supports resolutions up to 1080p/60 from the camera
- DVI-D/HDMI and analog component (YPbPr) outputs
- Up to 100 ft. (30 m) cabling distance
- Push-button color space selection - sRGB for DVI-D or YCbCr for HDMI
- IR output for codecs
- Supports daisy-chaining
- Half-rack form factor; mounting brackets available (not included)



Quick-Connect SR (QSR)

Basic connectivity for use with legacy equipment.

- Supports resolutions up to 1080p/60 from the camera
- Analog component YPbPr output
- Up to 100 ft. (30 m) cabling distance
- IR output for codecs



Unpacking the Camera System

Make sure you received all the items you expected. Here are the packing lists for the RoboSHOT camera systems.

Download manuals, dimensional drawings, and other information from www.vaddio.com/support.



Caution

Always support the camera's base when picking it up. Lifting the camera by its head or mounting arm will damage it.



RoboSHOT 12E AVBMP, worldwide – 999-99000-500 (black), 999-99000-500W (white)

- RoboSHOT 12E CAT-5 camera, black or white
- Thin Profile Wall Mount with mounting hardware, black or white, depending on camera color
- Vaddio IR Remote Commander
- Quick-start guide



RoboSHOT 12 AVBMP, worldwide – 999-9900-500

(silver/black)

- RoboSHOT 12 camera
- Thin Profile Wall Mount with mounting hardware, black
- Vaddio IR Remote Commander
- Quick-start guide



RoboSHOT 30E AVBMP, worldwide – 999-99100-500 (black), 999-99100-500W (white)

- RoboSHOT 30E CAT-5 camera, black or white
- Thin Profile Wall Mount with mounting hardware, black or white, depending on camera color
- Vaddio IR Remote Commander
- Quick-start guide



RoboSHOT 30 AVBMP, worldwide – 999-9910-500 (black), 999-9910-500W (white)

- RoboSHOT 30 camera, black or white
- Thin Profile Wall Mount with mounting hardware, black or white, depending on camera color
- Vaddio IR Remote Commander
- Quick-Start Guide



RoboSHOT 12E QCCU System, North America – 999-99070-000 (black), 999-99070-000W (white)
RoboSHOT 12E QCCU System, Europe/UK – 999-99070-001 (black), 999-99070-001W (white)
RoboSHOT 12E QCCU System, Australia/New Zealand – 999-99070-009 (black), 999-99070-009W (white)

- RoboSHOT 12E CAT-5 camera, black or white
- Thin Profile Wall Mount with mounting hardware, black or white, depending on camera color
- Vaddio IR Remote Commander
- Quick-Connect Universal CCU Cat-5 Interface (QCCU)
- 36V power supply with AC cord set(s)
- Rack mounting brackets, qty. 2 (not shown)
- Quick-start guides

Note

If you need an EZCamera RS-232 Control Adapter for use with this camera, please contact Vaddio Technical Support to obtain one.



RoboSHOT 12 QCCU System, North America – 999-9907-000 (silver/black)
RoboSHOT 12 QCCU System, Europe and UK – 999-9907-001 (silver/black)
RoboSHOT 12 QCCU System, Australia and New Zealand – 999-9907-009 (silver/black)

- RoboSHOT 12 camera
- Thin Profile Wall Mount with mounting hardware, black
- Vaddio IR Remote Commander
- Quick-Connect Universal CCU Cat-5 Interface (QCCU)
- 36V power supply with AC cord set(s)
- EZCamera RS-232 Control Adapter (998-1001-232)
- Rack mounting brackets, qty. 2 (not shown)
- Quick-start guides



RoboSHOT 30E QCCU System, North America – 999-99170-000 (black), 999-99170-000W (white)
RoboSHOT 30E QCCU System, Europe/UK – 999-99170-001 (black), 999-99170-001W (white)
RoboSHOT 30E QCCU System, Australia/New Zealand – 999-99170-009 (black), 999-99170-009W (white)

- RoboSHOT 30E CAT-5 Camera
- Thin Profile Wall Mount with mounting hardware, black or white, depending on camera color
- Vaddio IR Remote Commander
- Quick-Connect Universal CCU Cat-5 Interface (QCCU)
- 36V power supply with AC cord set(s)
- Rack mounting brackets, qty. 2 (not shown)
- Quick-start guides

Note

If you need an EZCamera RS-232 Control Adapter for use with this camera, please contact Vaddio Technical Support to obtain one.



RoboSHOT 30 QCCU System, North America – 999-9917-000 (black), 999-9917-000W (white)
RoboSHOT 30 QCCU System, Europe/UK – 999-9917-001 (black), 999-9917-001W (white)
RoboSHOT 30 QCCU System, Australia/New Zealand – 999-9917-009 (black), 999-9917-009W (white)

- RoboSHOT 30 Camera
- Thin Profile Wall Mount with mounting hardware, black or white, depending on camera color
- Vaddio IR Remote Commander
- Quick-Connect Universal CCU Cat-5 Interface (QCCU)
- 36V power supply with AC cord set(s)
- EZCamera RS-232 Control Adapter (998-1001-232)
- Rack mounting brackets, qty. 2 (not shown)
- Quick-start guides



RoboSHOT 12E QUSB System, North America – 999-99090-000 (black), 999-99090-000W (white)
RoboSHOT 12E QUSB System, Europe/UK – 999-99090-001 (black), 999-99090-001W (white)
RoboSHOT 12E QUSB System, Australia/New Zealand – 999-99090-009 (black), 99-99090-009W (white)

- RoboSHOT 12E CAT-5 camera, black or white
- Thin Profile Wall Mount with mounting hardware, black or white, depending on camera color
- Vaddio IR Remote Commander
- Quick-Connect USB interface (QUSB)
- 24V power supply with AC cord set(s)
- 6 ft. (1.8 m) USB 2.0 cable, type A to B
- Rubber feet for QUSB unit, qty. 4 (not shown)
- Quick-start guides

Note

If you need an EZCamera RS-232 Control Adapter for use with this camera, please contact Vaddio Technical Support to obtain one.



RoboSHOT 12 QUSB System, North America – 999-9909-000 (silver/black)
RoboSHOT 12 QUSB System, Europe/UK – 999-9909-001 (silver/black)
RoboSHOT 12 QUSB System, Australia/New Zealand – 999-9909-009 (silver/black)

- RoboSHOT 12 camera
- Thin Profile Wall Mount with mounting hardware, black
- Vaddio IR Remote Commander
- Quick-Connect USB interface (QUSB)
- 24V power supply with AC cord set(s)
- 6 ft. (1.8 m) USB 2.0 cable, type A to B
- EZCamera RS-232 Control Adapter (998-1001-232)
- Rubber feet for QUSB unit, qty. 4 (not shown)
- Quick-start guides



RoboSHOT 30E QUSB System, North America – 999-99190-000 (black), 999-99190-000W (white)
RoboSHOT 30E QUSB System, Europe/UK – 999-99190-001 (black), 999-99190-001W (white)
RoboSHOT 30E QUSB System, Australia/New Zealand – 999-99190-009 (black), 999-99190-009W (white)

- RoboSHOT 30 camera
- Thin Profile Wall Mount with mounting hardware, black or white, depending on camera color
- Vaddio IR Remote Commander
- Quick-Connect USB Interface (QUSB)
- 24V power supply with AC cord set(s)
- 6 ft. (1.8 m) USB 2.0 cable, type A to B
- Rubber feet for QUSB unit, qty. 4 (not shown)
- Quick-start guides

Note

If you need an EZCamera RS-232 Control Adapter for use with this camera, please contact Vaddio Technical Support to obtain one.



RoboSHOT 30 QUSB System, North America – 999-9919-000 (black), 999-9919-000W (white)
RoboSHOT 30 QUSB System, Europe/UK – 999-9919-001 (black), 999-9919-001W (white)
RoboSHOT 30 QUSB System, Australia/New Zealand – 999-9919-009 (black), 999-9919-009W (white)

- RoboSHOT 30 camera
- Thin Profile Wall Mount with mounting hardware, black or white, depending on camera color
- Vaddio IR Remote Commander
- Quick-Connect USB Interface (QUSB)
- 24V power supply with AC cord set(s)
- 6 ft. (1.8 m) USB 2.0 cable, type A to B
- EZCamera RS-232 Control Adapter (998-1001-232)
- Rubber feet for QUSB unit, qty. 4 (not shown)
- Quick-start guides



RoboSHOT 12E QMini, North America – 999-99010-000 (black), 999-99010-000W (white)
RoboSHOT 12E QMini, Europe/UK – 999-99010-001 (black), 999-99010-001W (white)
RoboSHOT 12E QMini, Australia/New Zealand – 999-99010-009 (black), 999-99010-009W (white)

- RoboSHOT 12E CAT-5 camera
- Thin Profile Wall Mount with mounting hardware, black or white, depending on camera color
- Vaddio IR Remote Commander
- Quick-Connect USB Mini interface (QMini)
- 24V power supply with AC cord set(s)
- 6 ft. (1.8 m) USB 2.0 cable, type A to B
- Quick-start guides

Note

If you need an EZCamera RS-232 Control Adapter for use with this camera, please contact Vaddio Technical Support to obtain one.



RoboSHOT 12 QMini System, North America – 999-9901-000 (silver/black)
RoboSHOT 12 QMini System, Europe/UK – 999-9901-001 (silver/black)
RoboSHOT 12 QMini System, Australia/New Zealand – 999-9901-009 (silver/black)

- RoboSHOT 12 camera
- Thin Profile Wall Mount with mounting hardware, black
- Vaddio IR Remote Commander
- Quick-Connect USB Mini interface (QMini)
- 24V power supply with AC cord set(s)
- 6 ft. (1.8 m) USB 2.0 cable, type A to B
- EZCamera RS-232 Control Adapter (998-1001-232)
- Quick-start guides



RoboSHOT 30E QMini System, North America – 999-99110-000 (black), 999-99110-000W (white)
RoboSHOT 30E QMini System, Europe/UK – 999-99110-001 (black), 999-99110-001W (white)
RoboSHOT 30E QMini System, Australia/New Zealand – 999-99110-009 (black), 999-99110-009W (white)

- RoboSHOT 30 camera
- Thin Profile Wall Mount with mounting hardware, black or white, depending on camera color
- Vaddio IR Remote Commander
- Quick-Connect USB Mini interface (QMini)
- 24V power supply with AC cord set(s)
- 6 ft. (1.8 m) USB 2.0 cable, type A to B
- Quick-start guides

Note

If you need an EZCamera RS-232 Control Adapter for use with this camera, please contact Vaddio Technical Support to obtain one.



RoboSHOT 30 QMini System, North America – 999-9911-000 (black), 999-9911-000W (white)
RoboSHOT 30 QMini System, Europe/UK – 999-9911-001 (black), 999-9911-001W (white)
RoboSHOT 30 QMini System, Australia/New Zealand – 999-9911-009 (black), 999-9911-009W (white)

- RoboSHOT 30 camera
- Thin Profile Wall Mount with mounting hardware, black or white, depending on camera color
- Vaddio IR Remote Commander
- Quick-Connect USB Mini interface (QMini)
- 24V power supply with AC cord set(s)
- 6 ft. (1.8 m) USB 2.0 cable, type A to B
- EZCamera RS-232 Control Adapter (998-1001-232)
- Quick-start guides



RoboSHOT 12E QDVI System, North America – 999-99060-000 (black), 999-99060-000W (white)

RoboSHOT 12E QDVI System, Europe/UK – 999-99060-000 (black), 999-99060-000W (white)

- RoboSHOT 12E CAT-5 camera, black or white
- Thin Profile Wall Mount with mounting hardware, black or white, depending on camera color
- Vaddio IR Remote Commander
- Quick-Connect DVI/HDMI SR interface (QDVI)
- 24V power supply with AC cord set(s)
- Phoenix-style connector, 3-position
- Rubber feet for QDVI unit, qty. 4 (not shown)
- Quick-start guides

Note

If you need an EZCamera RS-232 Control Adapter for use with this camera, please contact Vaddio Technical Support to obtain one.



RoboSHOT 12 QDVI System, North America – 999-9906-000 (silver/black)

RoboSHOT 12 QDVI System, Europe/UK – 999-9906-001 (silver/black)

- RoboSHOT 12 camera
- Thin Profile Wall Mount with mounting hardware, black
- Vaddio IR Remote Commander
- Quick-Connect DVI/HDMI SR interface (QDVI)
- 24V power supply with AC cord set(s)
- EZCamera RS-232 Control Adapter (998-1001-232)
- Phoenix-style connector, 3-position
- Rubber feet for QDVI unit, qty. 4 (not shown)
- Quick-start guides



RoboSHOT 30E QDVI System, North America – 999-9916-000 (black), 999-9916-000W (white)
RoboSHOT 30E QDVI System, Europe/UK – 999-9916-001 (black), 999-9916-001W (white)

- RoboSHOT 30E CAT-5 camera
- Thin Profile Wall Mount with mounting hardware, black or white, depending on camera color
- Vaddio IR Remote Commander
- Quick-Connect DVI/HDMI SR interface (QDVI)
- 24V power supply with AC cord set(s)
- Phoenix-style connector, 3-position
- Rubber feet for QDVI unit, qty. 4 (not shown)
- Quick-start guides

Note

If you need an EZCamera RS-232 Control Adapter for use with this camera, please contact Vaddio Technical Support to obtain one.



RoboSHOT 30 QDVI System, North America – 999-9916-000 (black), 999-9916-000W (white)
RoboSHOT 30 QDVI System, Europe/UK – 999-9916-001 (black), 999-9916-001W (white)

- RoboSHOT 30 camera
- Thin Profile Wall Mount with mounting hardware, black or white, depending on camera color
- Vaddio IR Remote Commander
- Quick-Connect DVI/HDMI SR interface (QDVI)
- 24V power supply with AC cord set(s)
- EZCamera RS-232 Control Adapter (998-1001-232)
- Phoenix-style connector, 3-position
- Rubber feet for QDVI unit, qty. 4 (not shown)
- Quick-start guides



RoboSHOT 12 QSR System, North America – 999-9905-000 (silver/black)

RoboSHOT 12 QSR System, Europe and UK – 999-9905-001 (silver/black)

- RoboSHOT 12 camera
- Thin Profile Wall Mount with mounting hardware, black
- Vaddio IR Remote Commander
- Quick-Connect SR interface (QSR)
- 24V power supply with AC cord set(s)
- EZCamera RS-232 Control Adapter (998-1001-232)
- Phoenix-style connector, 3-position
- Rubber feet for QSR unit, qty. 4 (not shown)
- Quick-start guides



RoboSHOT 30 QSR System, North America – 999-9915-000 (black), 999-9915-000W (white)

RoboSHOT 30 QSR System, Europe/UK – 999-9915-001 (black), 999-9915-001W (white)

- RoboSHOT 30 camera
- Thin Profile Wall Mount with mounting hardware, black or white, depending on camera color
- Vaddio IR Remote Commander
- Quick-Connect SR interface (QSR)
- 24V power supply with AC cord set(s)
- EZCamera RS-232 Control Adapter (998-1001-232)
- Phoenix-style connector, 3-position
- Rubber feet for QSR unit, qty. 4 (not shown)
- Quick-start guides



A Quick Look at the Camera

The cameras in the RoboSHOT line are similar in appearance.

- RoboSHOT 12 is silver, with a black base and stepped lens bezel
- RoboSHOT 30 is available in black or white, and has a fluted lens bezel
- RoboSHOT 12E CAT-5 and RoboSHOT 30E CAT-5 are available in black or white, and have smooth lens bezels

The image below shows a RoboSHOT 30 camera.

Front of the Camera



Camera and Zoom Lens

- **RoboSHOT 12:** 12x optical zoom in Super-Wide mode, 10x optical zoom in normal mode. Recommended for small to medium sized conference rooms.
- **RoboSHOT 12E CAT-5:** 12x optical zoom; recommended for small to medium sized conference rooms.
- **RoboSHOT 30 and RoboSHOT 30E CAT-5:** 30x optical zoom; best suited to larger rooms.

IR Sensors: Sensors in the front of the camera base receive signals from the remote. Make sure there's nothing directly in front of the camera base, and point the remote at the camera.

Status indicator: The multicolored LED indicates the camera's current state.

Really Cool Logo Badge (RCLB): Attractive and shiny, with a sophisticated brushed-metal finish.

Back of the Camera – RoboSHOT 12 and RoboSHOT 30

Rear panel connections are identical for the older RoboSHOT 12 and RoboSHOT 30 cameras.



- **Network Control:** RJ-45 connector. Connect to the network for control via the web interface or Telnet session.
- **HD Video Select:** Rotary switch to select the video output resolution. See [Video Resolution Setting](#).
- **Camera Settings:** DIP switches to set camera behaviors such as IR remote frequency, baud rate and image flip. See [Camera Behavior Settings – RoboSHOT 12 and 30](#) for more information.
- **RS-232:** RJ-45 connector. Connect to the RS-232 port (if any) on the Quick-Connect device to allow an external device to manage the camera using a modified VISCA protocol. See [RS-232 Serial Communication Settings](#) for RS-232 settings.
- **EZPower Video:** RJ-45 connector. Supplies power to the camera and delivers HD video back to the Quick-Connect interface using high speed differential signaling over Cat-5e cable. Connect to the EZPower Video port on the Quick-Connect device. (Color-coded orange or yellow, depending on the device.)
- **36 VDC FOR CCU ONLY:** RJ-45 connector. Power from the Quick-Connect Universal CCU, in RoboSHOT QCCU systems only. *Do not use this port* except when connecting to a Quick-Connect Universal CCU.

Note

A label on the bottom of the camera lists the rotary and DIP switch settings.

Back of the Camera – RoboSHOT 12E CAT-5 and RoboSHOT 30E CAT-5

Rear panel connections are identical for the RoboSHOT 12E CAT-5 and RoboSHOT 30E CAT-5 cameras.



- **Network Control:** RJ-45 connector. Connect to the network for control via the web interface or Telnet session.
- **HD Video Select:** Rotary switch to select the video output resolution. See [Video Resolution Setting](#).
- **RS-232:** RJ-45 connector. Connect to the RS-232 port (if any) on the Quick-Connect device to allow an external device to manage the camera using a modified VISCA protocol. See [RS-232 Serial Communication Settings](#) for RS-232 settings.
- **EZPower Video:** RJ-45 connector. supplies power to the camera and delivers HD video back to the Quick-Connect interface using high speed differential signaling over Cat-5e cable. Connect to the EZPower Video port on the Quick-Connect device. (Color-coded orange or yellow, depending on the device.)
- **36 VDC FOR CCU ONLY:** RJ-45 connector. Power from the Quick-ConnectUniversal CCU. *Do not use this port except when connecting to a Quick-ConnectUniversal CCU.*

Note

A label on the bottom of the camera lists the rotary switch settings.

A (Quick) Look at the Quick-Connect Devices

RoboSHOT 12, RoboSHOT 12E CAT-5, RoboSHOT 30, and RoboSHOT 30E CAT-5 cameras are not designed for stand-alone operation. These configurations are available:

- **QCCU system** – A camera with a Quick-Connect Universal CCU, a broadcast-quality CCU (camera control unit) for managing color and lighting adjustments. This system is typically used with a joystick camera controller.
- **QUSB system** – A camera with a Quick-Connect USB, a versatile solution with multiple connectivity options and choice of USB or IP streaming. This system is typically used in rooms that need conferencing capability, and may be used with a joystick camera controller.
- **QMini system** – A camera with a Quick-Connect USB Mini, a basic USB connectivity solution with a small, unobtrusive form factor. This system is typically used for soft conferencing applications.
- **QDVI system** – A camera with a Quick-Connect DVI/HDMI-SR, a connectivity solution for legacy equipment; provides DVI and analog component video outputs. Use with a DVI-to-HDMI adapter for HDMI output. Like the RoboSHOT QSR system, this system is typically used with older equipment; however, it provides more connectivity options. This system may be used with a joystick camera controller.
- **QSR system** – A RoboSHOT 12 or RoboSHOT 30 camera with a Quick-Connect SR, a short-range connectivity device for legacy equipment; provides analog component video output. This system is typically used with older displays, and may be used with a joystick camera controller. The Quick-Connect SR device has been discontinued and is not available for RoboSHOT 12E CAT-5 and RoboSHOT 30E CAT-5 cameras, though it will work with them.

The RoboSHOT 12, RoboSHOT 12E CAT-5, RoboSHOT 30, and RoboSHOT 30E CAT-5 cameras are also sold as **RoboSHOT AVBMP** cameras. These do not use Quick-Connect devices, but connect directly to a Vaddio AV Bridge MATRIX PRO, which provides connectivity for up to three cameras.

Quick-Connect Universal CCU Interface

This interface combines a versatile connectivity solution with a broadcast-quality camera control unit (CCU). It is the best choice for environments where lighting and color management are priorities and installations requiring long cabling distances.

Note

The Universal CCU supports resolutions with frame rates of 60, 59.94 and 50 frames per second, but not lower.



Front panel features:

- **5-line display** – Shows the current value for the parameter you are changing. The display shows up to 8 parameters at a time, so you can see how the controls and settings interact.
- **Tally light** – In a multi-camera/CCU installation, this indicator shows when this CCU and camera are the live program. When this light illuminates, the CCU also sends a tally command to the camera to light its tally indicator.
- **Menu selector knob** – Dial the desired setting or value for the selected function.

The buttons:

- **Scene A, Scene B and Scene C** – Store and use three different sets of color and lighting adjustments (CCU scenes). F
- **W Bal OPWB (One Push White Balance)** – Calibrate the color balance (Auto White Balance must be off). After the calibration is complete, you may want to activate Auto White Balance.
- **W Bal Auto (Auto White Balance)** – Manage color levels automatically. Use the OPWB button to calibrate the white balance before activating Auto White Balance.
- **Red Gain and Blue Gain controls** – Adjust the color balance. These controls are only active when Auto White Balance is off.
- **Chroma** – Controls the color intensity of the image.
- **Bright** – Luminance control for the image.
- **Gamma** – Adjusts the mid-tones to change the grey density of the image.
- **Detail** – Sharpens or softens the objects in the image.
- **Iris Auto and Iris Manual** – Automatic and manual control, respectively, of the amount of light entering the camera.
- **Gain** – Boosts the signal level when the iris is open all the way and there is not enough light available.
- **Select and Cancel buttons** – Save the change you make with the menu selector knob, or cancel it to retain the existing setting or value. These buttons are also used for menu navigation.

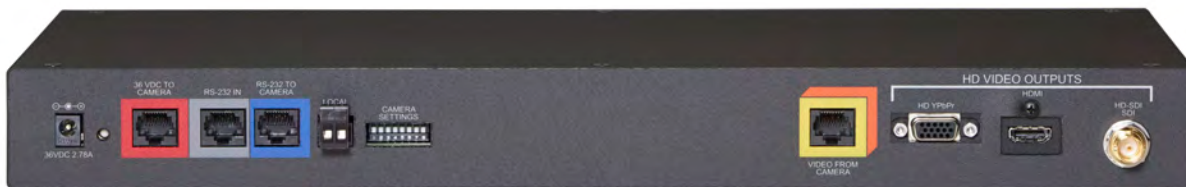

Back panel features:

- **Power input** – Connect only the 36 VDC, 2.78 Amp power supply provided with the Universal CCU.
- **Recessed white button** – Press to execute a factory reset; press and hold to enter boot loader mode.
- **36 VDC to Camera (red)** – Power to the RoboSHOT camera. Connect to the camera's port marked **36 VDC for CCU Only** (color coded red). See [Back of the Camera](#).

Caution

Connect this port ONLY to the camera port marked 36 VDC for CCU Only and color-coded red. Connecting this port to any other port on the camera will result in equipment damage, and will void the warranty.

- **RS-232 In (grey)** – Control from an external device. If the camera and CCU will be controlled using a ProductionVIEW console or other camera control system, connect it to this port. Daisy-chain topology is not supported.
- **RS-232 to Camera (blue)** – Camera control. Connect to the camera's RS-232 port.
- **Local** – Install the 2-pin 5.0 mm Euro-style connector to use the tally function. In a multi-camera CCU installation, this lights the blue indicator on the front panel when this camera and Universal CCU combination is the live program. A tally command is also sent to the RoboSHOT camera via RS-232, illuminating its front indicator.
- **8-position DIP switch** – The DIP switch lets you configure the way the camera and Universal CCU behave. The default position for all switches is DOWN. (Note that the default position for the DIP switch on the camera is all UP.)
 - Switch 1: UP to load Scene A on power-up or reboot.
 - Switch 5: UP to access adjustments for the display on the front panel.
- **Video from Camera (yellow and orange)** – Receives the camera's differential video signals from the camera's EZ-POWER VIDEO connection.
- **HD Video Outputs** – The Universal CCU provides simultaneous video output in three formats, at the same resolution as the video input:
 - **HD YPbPr** – Resolution/frame rate up to 1080p/60
 - **HDMI** – Resolution/frame rate up to 1080p/60
 - **HD-SDI** – 3Gb/s Single Link 1080p/60 HD-SDI

Quick-Connect USB Interface

This is a versatile USB 2.0 device for environments using soft conferencing applications. With simultaneous HDMI and HD analog component (YPbPr) video outputs and your choice of either USB or IP streaming, plus a web interface for ease of configuration, the Quick-Connect USB is an ideal connectivity solution for many environments.



Front panel features:

- **Back-lit LCD display** – During normal operation, the display shows the MAC address and IP address for the Quick-Connect. When the Quick-Connect is booting, the display shows an initialization message.
- **Power System Reset button** – Illuminates when the Quick-Connect is connected to power. Press and hold the button to reboot the Quick-Connect.
- **USB indicator** – Illuminates when there is a USB connection to a computer. Blinks to show USB activity.
- **Network indicator** – Illuminates when there is a network connection. Blinks to shown network activity.



Back panel features:

- **24 VDC 2.0 A power connector** – Connect only the power supply shipped with the Quick-Connect.
- **5-position DIP switch** – Setting for HDMI color space; firmware update configuration; factory reset.
- **RS-232 In** – Camera control input from a Vaddio joystick controller or other controller.
- **EZ-Power Video** – Power to the camera and video from the camera.
- **RS-232 Out to Camera** – Control signals to the camera; may originate from the connected camera controller or the web interface.
- **YPbPr** – Analog component video output from the camera.
- **HDMI** – HDMI video output from the camera.
- **Network** – Connect to the network for IP streaming and camera control via web interface or Telnet, and for access to the Quick-Connect's web interface.
- **USB** – Connect to a USB 2.0 port on the computer running the soft conferencing or video capture application.

Quick-Connect USB Mini Interface

This interface provides basic USB 2.0 connectivity for environments using soft conferencing applications. Available input/camera resolutions are 720p/60, 720p/59.94, and 720p/50.

The Quick-Connect USB Mini is typically mounted with the connector panel facing up.



Front panel features:

- **USB** – Connect to a USB 2.0 port on the computer running the soft conferencing or video capture application.
- **Power** – Illuminates when power is connected.

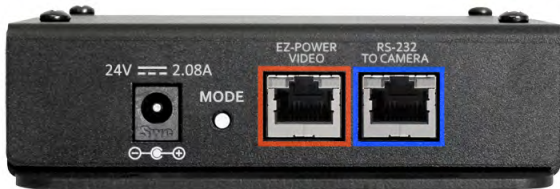

Back panel features:

- **24 VDC 2.08 A power connector** – Connect only the power supply shipped with the Quick-Connect.
- **Mode** – Press to switch between USB streaming mode and web control mode. Press and hold to reset the Quick-Connect to its factory defaults.
- **EZ-Power Video** – Power to the camera and video from the camera.
- **RS-232 to Camera** – Control signals to the camera.

Quick-Connect DVI/HDMI-SR Interface

This interface provides connectivity to older equipment.



Back panel features:

- **Power** – Illuminates when power is connected.
- **24 VDC 2.0 A power connector** – Connect only the power supply shipped with the Quick-Connect.
- **Color Space** – Toggles between HDMI YCbCr and sRGB (RGBHV) color space to accommodate either HDMI or DVI-D monitors.
- **RS-232 Control Input** – Camera control input from a Vaddio joystick controller or other controller.
- **RS-232 Control Out to Camera** – Control signals to the camera.
- **Daisy Chain** – Daisy Chain Control Emulation (DCCE) output to the next Quick-Connect DVI/HDMI-SR interface.
- **IR Output** – Forwards IR signals from the camera to third party equipment such as videoconferencing codecs. Use the MOD signal if the IR is from a remote or other IR emitter; use the NON-MOD signal for wired connections.
- **DVI-D/HDMI** – HDMI 1.3 and DVI v 1.0 compliant. With a DVI to HDMI adapter, extends HDMI to an output device up to 100 ft. (30 m) away.
- **YPbPr** – Analog component video output from the camera. Resolutions up to 1080p/60.
- **EZ-Power Video** – Power to the camera and video from the camera. Maximum cable distance 100 ft. (30 m).

Quick-Connect SR Interface

This interface provides basic connectivity to older equipment. The Quick-Connect SR interface has been discontinued and is not available for the RoboSHOT 12E CAT-5 and RoboSHOT 30E CAT-5 cameras, though it will work with them.



Back panel features:

- **24 VDC 2.0 A power connector** – Connect only the power supply shipped with the Quick-Connect.
- **EZ-Camera Power & HD Video** – Power to the camera and video from the camera. On some units, this port is color-coded orange.
- **HD Video Output YPbPr** – Analog component video output from the camera. SD video resolutions (Y/C and CVBS formats) are not supported by the Quick-Connect SR Interface; however, analog component SD (high fps format - 480p/59.94 and 576p/50) video is supported.
- **IR Output** – Forwards IR signals from the camera to third party equipment such as videoconferencing codecs. Use the MOD signal if the IR is from a remote or other IR emitter; use the NON-MOD signal for wired connections.
- **RS-232 Input and RS-232 Out to Camera** – Route RS-232 control through the Quick-Connect device for ease of cabling. Connect RS-232 Input to an optional camera controller, and connect RS-232 Out to Camera to (you guessed it) the camera.

Installing the Camera and Quick-Connect Device

This section covers:

- Selecting the location for the camera and Quick-Connect device
- Installing the camera mount
- Mounting the Quick-Connect device
- Information on cables and RS-232 communication
- Settings for the physical switches on the camera and the Quick-Connect devices
- Connection diagrams
- Mounting the camera

And a required safety note here:

Note

PoE type networks connected to this equipment are for intra-building use only and should not be connected to lines that run outside of the building in which this product is located.

Don't Void Your Warranty!



Caution

Always support the camera's base when picking it up. Lifting the camera by its head or mounting arm will damage it.

Caution

This product is for indoor use. Use an appropriate protective enclosure if installing it outdoors or in a humid environment.

Do not install or operate this product if it has been dropped, damaged, or exposed to liquids. If any of these things happen, return it to Vaddio for safety and functional testing.

Caution

If using a DC power supply with this product, use the power supply included with it or recommended for use with it. Always check the output voltage listed on the power supply label, as power supplies for different products may look nearly identical. Using the wrong power supply will void the warranty, possibly causing unsafe operating conditions and damage to the product.

Before You Start

Things to keep in mind when deciding where to install the camera:

- Consider camera viewing angles, lighting conditions, line-of-sight obstructions, and in-wall obstructions.
- If the IR Remote Commander will be used, ensure that nothing blocks the IR lens in the camera's base.
- Ensure that the camera body can move freely and point away from the ceiling and lights.

Prepare for a successful installation:

- Be sure you can identify all cables correctly.
- Check Cat-5 cables for continuity.
- Ensure that the video resolution rotary switch and the DIP switches (if any) are set appropriately.
- *Talk to the network administrator.* If installing the camera in a non-DHCP network (one that does not automatically assign IP addresses), you may need to configure the camera with a static IP address as directed by the network administrator before connecting it to the network. Work with the network administrator to determine how to configure the equipment.

Installing the Wall Mount

The camera is shipped with a Thin Profile Wall Mount. Other mounting options are available as well. Contact us if you don't have the camera mount you need.

You can install the camera wall mount to a 2-gang wall box or directly to the drywall.

- If you mount it to drywall, use the wall anchors provided with the wall mount.
- If you mount it to a wall box, use the cover plate screws supplied with the wall box.

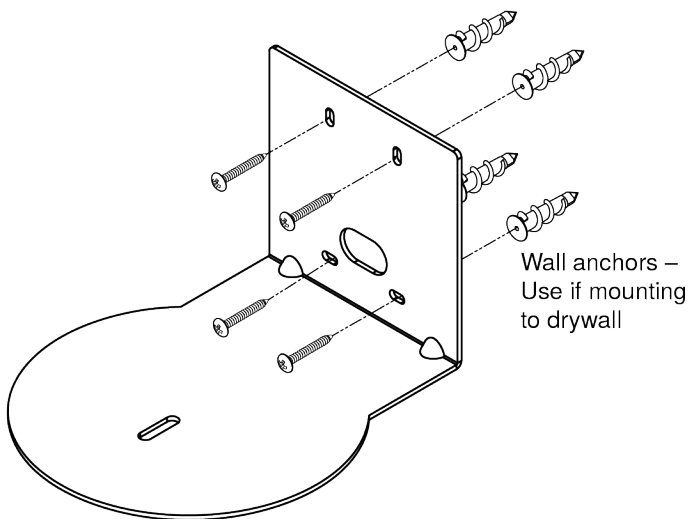

About Ceiling-Mounted Cameras

If you use an inverted mount, set the camera's Image Flip DIP switch ON for inverted operation. This orients the video image correctly and sets the tilt motors to respond appropriately to tilt up and down commands from the remote, web interface, and connected control devices. For RoboSHOT Elite series cameras, this switch is available to the administrator on the System page of the web interface.

Video Resolution Setting

Non-architectural RoboSHOT cameras use a rotary switch to set output resolution.

Set the desired video output resolution with the rotary switch before installing the camera. Note that the video resolutions are mapped differently on the rotary switch for the newer Elite-series cameras.

RoboSHOT 12E CAT-5 and RoboSHOT 30E CAT-5 only: If the camera has been updated to version 3.1.0 firmware or later, Position 0 selects software control. Set video output resolution in the web interface. The default resolution is 720p/59.94. This capability is not available in earlier firmware versions or on the older RoboSHOT 12 and RoboSHOT 30 cameras.

See [Software-Controlled Video Output Resolution Setting](#).

RoboSHOT 12 and RoboSHOT 30 cameras

Rear Rotary Switch				
	0	720p/59.94	8	1080p/50
	1	1080i/59.94	9	720p/30
	2	1080p/59.94	A	1080p/30
	3	720p/60	B	720p/25
	4	1080i/60	C	1080p/25
	5	1080p/60	D	
	6	720p/50	E	
	7	1080i/50	F	

RoboSHOT 12E CAT-5 and RoboSHOT 30E CAT-5 cameras

Rear Rotary Switch				
	0	Software Control	8	1080p/29.97
	1	1080p/60	9	1080p/25
	2	1080p/59.94	A	720p/60
	3	1080p/50	B	720p/59.94
	4	1080i/60	C	720p/50
	5	1080i/59.94	D	
	6	1080i/50	E	Factory Reset
	7	1080p/30	F	

Note

The Quick-Connect Universal CCU supports frame rates of 50 fps and above. Switch selections 9 through C are valid for the camera but not supported on the QCCU.

Note

The Quick-Connect USB Mini supports only 720p/60, 720p/59.94, and 720p/50. Other resolution settings are valid for the camera but not supported on the QMini.

Camera Behavior Settings – RoboSHOT 12 and RoboSHOT 30

Older RoboSHOT cameras use DIP switches to set camera behaviors; the RoboSHOT Elite series cameras set all camera behaviors in the web interface.

A label on the bottom of the camera provides a quick reference for setting the switches.

Set the switches appropriately before mounting the camera.

After the camera is installed, you can read the switches from the camera's web interface.

Note

When the camera is not inverted, DIP switches are in their default positions when they are up.

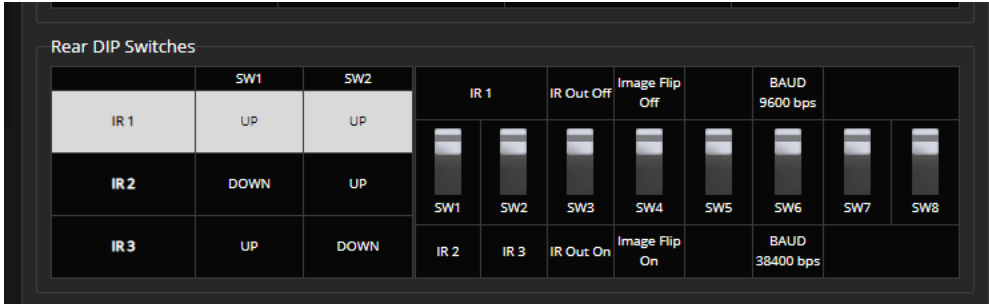

(RoboSHOT 30 shown; Switch 5 is Super Wide Mode if the camera is a RoboSHOT 12.)

IR1, IR2, IR3 (Frequency Selection): If there are multiple cameras in the room, use **switches 1 and 2** to configure each with a different IR frequency to allow the IR Remote Commander to control them independently. Then use the Camera Select buttons at the top of the remote to select the camera you want to control.

- SW1 and SW2 up: IR frequency 1
- SW1 down, SW2 up: IR frequency 2
- SW1 up, SW2 down: IR frequency 3

IR Out: Leave **switch 3** UP if the IR remote will be used. If the system will be controlled from another device, set the switch DOWN. This turns off the IR sensors in the front of the camera, so that all control is via the RS-232 connection.

Image Flip: If mounting the camera upside-down, set **switch 4** DOWN: IMAGE FLIP ON. This orients the video image correctly and sets the tilt motors to respond appropriately to tilt up and down commands from the remote, web interface, and connected control devices.

Super Wide Mode (RoboSHOT 12 only): To use Super-wide mode, set **switch 5** DOWN. This gives 12X zoom with a 73° horizontal field of view. Normal mode provides 10X zoom with a 67.2° horizontal field of view (HFOV).

Baud Rate: Set **switch 6** to the baud rate of the device connected to the RS-232 port. The default is 9600 bps. The 38400 baud setting is optional if the connected control device supports it.

For RoboSHOT 30, **Switch 5** is not used. **Switches 7 and 8** are not currently used on either RoboSHOT 12 or RoboSHOT 30.

Switch Settings for the Universal CCU

The default position for DIP switches on the Universal CCU is down. On RoboSHOT cameras, the default position is up. Please double-check switch positions on both units if the camera does not perform as expected.

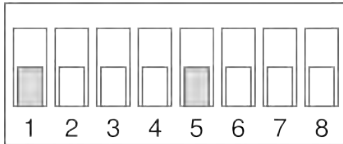

Switch 1:

- UP to load CCU Scene A on power-up (Custom Scene 1 must be defined on the camera)
- DOWN to use the color and lighting settings associated with the camera's Home preset

Switch 5:

- UP to include the front panel display controls on the menu
- DOWN to hide the display controls (all other menu items remain available)

The other switches are not used.

Switch Settings for the Quick-Connect USB

The default position for DIP switches on the Quick-Connect USB is up, as it is on RoboSHOT cameras.

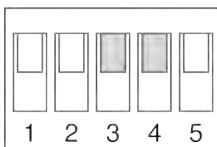

Switch 3:

- UP for HDMI (YCbCr) color space
- DOWN for DVI (sRGB) color space

Switch 4:

- UP for normal operation
- DOWN to enable firmware update

The other switches are not used.

RS-232 Serial Communication Settings

The RS-232 serial port (color-coded blue) provides a means of controlling the camera from a third-party device. Be sure the camera is set to the same baud rate as the external control device.

Specification	Value
Communication Speed	9600 or 38400 baud, selectable
Number of start bits	1
Number of stop bits	1
Number of data bits	8
Parity	None
Flow control	None

The camera's default baud rate is 9600. The 38400 baud setting is optional if the connected device supports it.

RS-232 Connector Pin-Out

- Pin 1: Not used
- Pin 2: Not used
- Pin 3: Not used
- Pin 4: IR Output (Diff Signal to Quick-Connect SR)
- Pin 5: IR Ground (Diff Signal to Quick-Connect SR)
- Pin 6: GND (GND of IR Short Range - Pin 3)
- Pin 7: RXD (from TXD of control source)
- Pin 8: TXD (to RXD of control source)

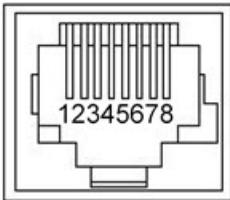

Caution

Check your cables. Connecting a cable to the wrong port or using the wrong pin-out can result in equipment damage and will void the warranty.

Cabling Notes

Caution

When making cables, do not use pass-through RJ-45 connectors. If they are crimped incorrectly, they can damage the connectors on the product, cause intermittent connections, and degrade signal quality. Physical damage to the connectors may void your warranty.



Intact – will make reliable contact with cable connector



Damaged – Bent contact fingers will NOT make reliable contact with cable connector

Use Cat-5e or better cable. We recommend using high-quality connectors and a high-quality crimping tool. We recommend shielded cabling if the cables will be coiled, run tightly with other cables, or placed close sources of electromagnetic interference such as power lines.

Caution

Check your cables. Connecting a cable to the wrong port or using the wrong pin-out can result in equipment damage and will void the warranty.



Pro Tip

To prevent tragic mishaps, label both ends of every cable.

Connecting the Camera

This section provides connection diagrams for each RoboSHOT system:

- RoboSHOT QCCU (includes systems with RoboSHOT Elite cameras)
- RoboSHOT QUSB (includes systems with RoboSHOT Elite cameras)
- RoboSHOT QMini (includes systems with RoboSHOT Elite cameras)
- RoboSHOT QDVI (includes systems with RoboSHOT Elite cameras)
- RoboSHOT QSR (RoboSHOT 12 and RoboSHOT 30 only)
- RoboSHOT AVBMP (includes RoboSHOT Elite cameras)

Note

Talk to the network administrator before you connect the equipment.

If you install this equipment on a non-DHCP network (one that uses only static IP addresses), you may need to configure the camera with a static IP address before you connect it to the network. Work with the network administrator to determine how to configure the equipment.

Determine what you need to do to prevent IP address conflicts:

- Installing cameras with Quick-Connect USB devices on a non-DHCP network: *configure each camera and each Quick-Connect USB device* with static IP addresses before connecting them to the network.
- Installing cameras with other Quick-Connect devices on a non-DHCP network: *configure each camera* with a static IP address before connecting it to the network.
- Installing cameras with an AV Bridge MATRIX PRO on a non-DHCP network: *configure each camera* with a static IP address before connecting it to the network. The AV Bridge MATRIX PRO will also need a static IP address.

If you need to do any of these things, work with the network administrator to determine the appropriate network configuration.

See [Configuring the Camera with a Static IP Address](#) for step-by-step instructions to configure a static IP address.

Basic Connections: RoboSHOT QCCU System

RoboSHOT QCCU systems ship with the camera and a Quick-Connect Universal CCU (QCCU). The QCCU powers the camera and provides fine control over color and lighting (CCU) adjustments. This system is designed for a live production environment and is typically installed with a camera controller and multi-view preview monitor.

Caution

Connect the power cable from the QCCU to the camera's power port marked **36 VDC For QCCU Only**. **DO NOT** connect it to the camera's EZ-Power Video port. Connecting the power cable from the QCCU to the wrong port on the camera will damage the camera and void your warranty.

Pro Tip

Use the color coding on the camera and the QCCU – blue goes to blue, yellow/orange goes to yellow/orange, red goes to red.

This diagram shows a RoboSHOT 12 camera. The RoboSHOT 30, RoboSHOT 12E CAT-5, and RoboSHOT 30E CAT-5 connect in the same way.



Basic Connections: RoboSHOT QUSB System

RoboSHOT QUSB systems ship with a USB 2.0 cable to connect the Quick-Connect USB to a computer running a soft conferencing application. The Quick-Connect USB provides connections for a camera controller or other control device, and HDMI and YPbPr (analog component video) outputs to display video from the camera (near-end video).

This diagram shows a RoboSHOT 12 camera. The RoboSHOT 30, RoboSHOT 12E CAT-5, and RoboSHOT 30E CAT-5 connect in the same way.

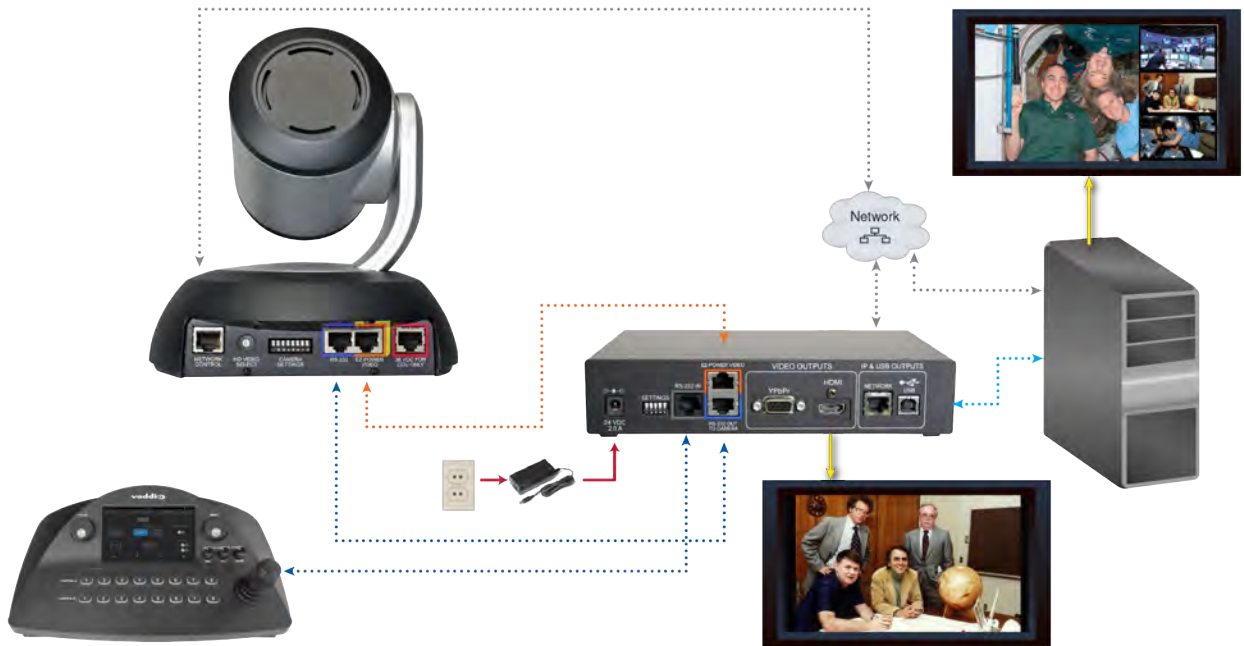

Basic Connections: RoboSHOT QMini System

RoboSHOT QMini systems ship with a USB 2.0 cable to connect the Quick-Connect USB Mini to a computer running a soft conferencing application. The Quick-Connect USB Mini provides power and connectivity to the camera, and brings the camera's video to the computer via USB connection.

This diagram shows a RoboSHOT 12 camera. The RoboSHOT 30, RoboSHOT 12E CAT-5, and RoboSHOT 30E CAT-5 connect in the same way.

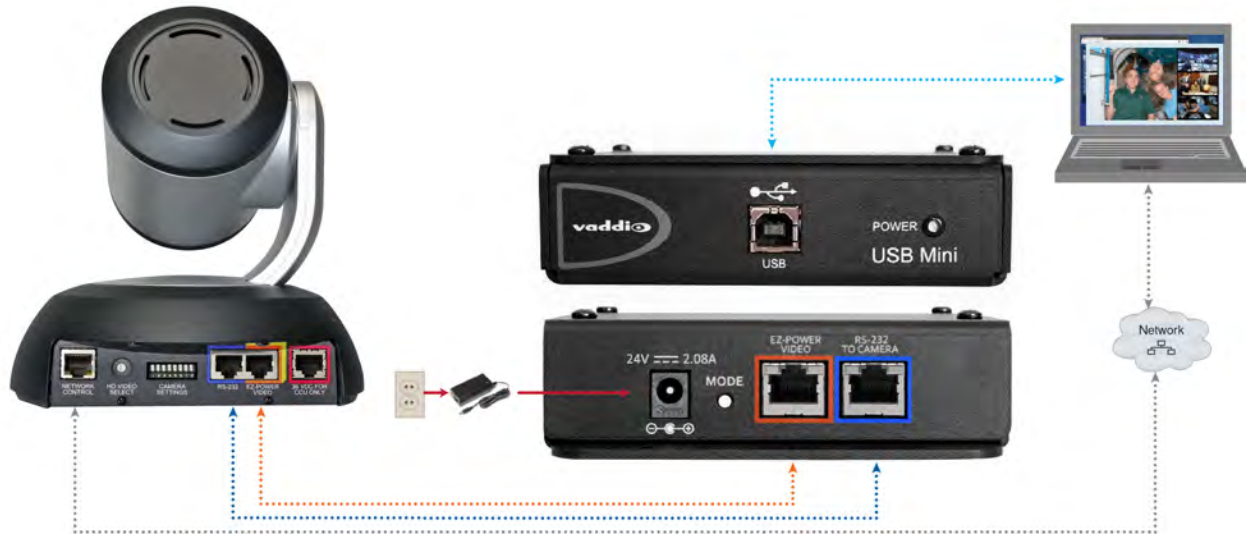

Basic Connections: RoboSHOT QDVI System

The Quick-Connect DVI/HDMI-SR provides power and control to the camera, brings camera video to the connected display, and offers daisy-chaining capability for legacy equipment. DVI/HDMI and YPbPr (analog component video) outputs accommodate older displays.

If using the IR FORWARD connector:

- Use the MOD and GND pins (1 and 2) for balanced (differential) IR. Because it is a differential signal, you can swap the two wires.
- Use the GND and NON-MOD pins (2 and 3) for unbalanced (single-ended) IR, for example if connecting to Polycom equipment. Because it is not a differential signal, pin 2 must go to the GND connection at the other end of the cable.

This diagram shows a RoboSHOT 12 camera. The RoboSHOT 30, RoboSHOT 12E CAT-5, and RoboSHOT 30E CAT-5 connect in the same way.



Basic Connections: RoboSHOT QSR System

The Quick-Connect SR interface provides power and control to the camera, and a YPbPr (analog component video) output. External control is via an RS-232 connected device.

If using the IR FORWARD connector:

- Use the MOD and GND pins (1 and 2) for balanced (differential) IR. Because it is a differential signal, you can swap the two wires.
- Use the GND and NON-MOD pins (2 and 3) for unbalanced (single-ended) IR, for example if connecting to Polycom equipment. Because it is not a differential signal, pin 2 must go to the GND connection at the other end of the cable.

This diagram shows a RoboSHOT 12 camera. The RoboSHOT 30 camera connects in the same way. The Quick-Connect SR has been discontinued and is not available for the RoboSHOT 12E CAT-5 and RoboSHOT 30E CAT-5 cameras.



Basic Connections: RoboSHOT AVBMP

RoboSHOT AVBMP cameras ship with a remote and a wall mount. Connect the camera to an AV Bridge MATRIX PRO for power, control, and connectivity. Up to three cameras can be connected at once.

This diagram shows a RoboSHOT 12 camera. The RoboSHOT 30, RoboSHOT 12E CAT-5, and RoboSHOT 30E CAT-5 connect in the same way.



Installing the Camera

Be sure you have already set the camera's switches.

If you are installing the camera with a Quick-Connect USB or Quick-Connect USB Mini on a network that uses static IP addressing (a non-DHCP network), be sure you have already configured the camera appropriately for the network.

Caution

Check your cables. Connecting a cable to the wrong port or using the wrong pin-out can result in equipment damage and will void the warranty.

1. Route the cables to the camera location.
2. Route the cables through the mount, and install the mount on the wall or attach it to the wall box. Leave the screws loose enough to adjust the position of the mount.
3. Level the mount and tighten the mounting screws.
4. Connect the cables to the camera.
 - If using a Quick-Connect Universal CCU, connect the **36 VDC To Camera** output to the camera's **36 VDC From QCCU Only** port.
 - If connecting the camera to any other Quick-Connect device or to an AV Bridge Matrix Pro, connect power to the **EZ Power Video** port.

Be sure to connect the cables correctly. Connecting a cable to the wrong port could damage the camera and void the warranty.

5. Place the camera on the mount.

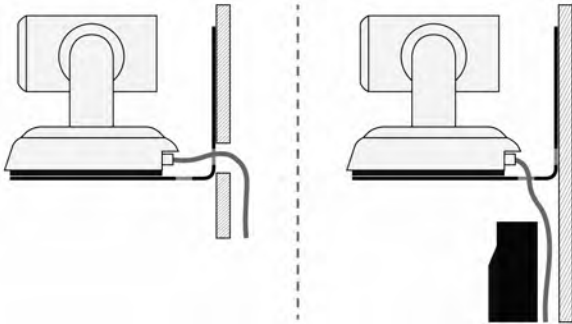

6. Attach the camera to the mount using the 1/4"-20 x .375 mounting screw supplied with the camera.

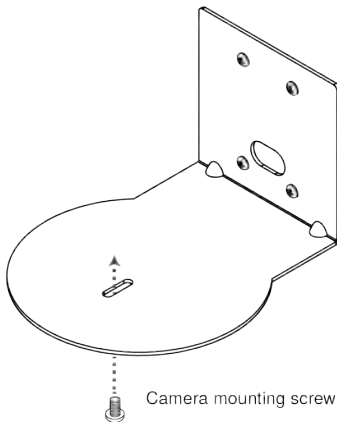

Images for illustration only; not to scale. Camera and mount details may differ.

Installing the Quick-Connect Device

If you are installing the camera with a Universal CCU or other Quick-Connect device, mount the Quick-Connect device appropriately. Follow the instructions provided with the mounting solution.

- The Universal CCU may be mounted in a rack using the rack mounting brackets provided.
- The Quick-Connect SR may be mounted directly to the camera wall mount.
- Rack mounting brackets and under-table mounting brackets are available for the Quick-Connect USB.
- Rack mounting brackets are available for the other Quick-Connect devices.

Contact us if you don't have the mount you need.

Powering Up the Camera

Connect power to the device that powers the camera – Universal CCU, Quick-Connect device, or AV Bridge MATRIX PRO. The device and the camera will initialize. This will take a few seconds. When the camera is initialized and ready, its front indicator is blue. At this point, it is ready to accept control information.

Note

Wait until the camera finishes initializing before trying to control it using the IR remote or other command input.

Status Light

The light in the camera's base indicates its current state.

- **Blue:** Normal operation (blinks once when the camera receives a command from the remote)
- **Red:** On-air tally (signal provided by external device via serial connection)
- **Blinking red:** Video is muted (UC color scheme only)
- **Purple:** In standby mode or booting
- **Yellow:** Firmware update in progress

Caution

Do not remove power or reset the camera while the indicator is yellow, showing a firmware update in progress. Interrupting a firmware update can make the camera unusable.

Note

By default, the camera's status light is active during normal operation; however, it can be configured to remain off when the camera is powered up. The camera may be sending video even if the indicator light is off.

Using the IR Remote

The IR remote provides basic camera control.

IR Remote Cheat Sheet

What do you need to do?	Button(s)	
Power on or standby	Power (green button at top right)	
Select the camera to control (if this remote controls more than one)	Camera Select buttons 1 through 3 (second row of buttons)	
Discover the camera's IP address	Data Screen button (top left) – press and hold for 3 seconds.	
Move the camera	Arrow buttons and Home button (dark red)	
Move the camera to a preset position	Position Preset buttons 1 through 6 (bottom two rows)	
Focus the camera	Auto Focus button (near arrow buttons) Manual Focus buttons Near and Far (below Zoom Speed buttons)	
Control zoom speed	Zoom Speed buttons (light gray) - Slow T and W , Fast T and W for telephoto (zoom in) and wide-angle (zoom out) modes	
Adjust for excess light behind the camera's subject	Back Light button (top center)	

IR Remote Details

The Vaddio remote provides the following functions:

Power – Switch the selected camera on or off.

Power indicator – Lights momentarily when you press a button.

Back Light – Use or turn off Back Light Compensation.

Data Screen – Display the camera's IP address and MAC address. Press this button again to dismiss the display.

Camera Select – In multi-camera installations, selects the camera to be controlled.

For older cameras with DIP switches on the back, see [DIP Switches: Camera Behavior Settings](#) for information on configuring the camera as camera 1, 2, or 3. For the newer Elite series cameras, see [Basic Camera Settings for RoboSHOT 12E CAT-5 and RoboSHOT 30E CAT-5](#).

Pan/Tilt (arrow button) controls and Home button – Control the camera's position.

Rev. Pan and Std. Pan– Control how the camera responds to the arrow buttons. Helpful for ceiling-mounted cameras and for presenters who are controlling the camera.

Pan/Tilt Reset – Not used.

Auto Focus – Switch the camera to Auto-Focus mode.

Zoom Speed – Select Slow or Fast movements for telephoto and wide-angle shots.

- T slow and T fast – Telephoto (zoom in)
- W slow and W fast – Wide-angle (zoom out)

Manual Focus – Switch the camera to Manual Focus mode.

Near (-) adjustment – Moves the focus nearer when in manual focus mode.

Far (+) adjustment – Moves the focus farther when in manual focus mode.

Preset – Save the camera's current position as one of the numbered presets.

Reset – Clear a saved preset.

Position Presets 1 through 6 – Move the camera to a predefined position, or specify the preset to save or clear.

The web interface offers greater control over camera movements to presets (such as setting the speed for Tri-Synchronous Motion), and provides additional presets.

Storing a Preset Using the Remote

Position the camera. Then hold down the Preset button and press one of the numbered preset buttons.

Clearing a Preset Using the Remote

Press and hold the Reset button while pressing the preset number you want to clear.



Web Interface

The camera's web interface allows control via a network connection, using a browser. Password-protected pages provide administrative access to tasks such as setting passwords, changing the IP address, viewing diagnostics, and installing firmware updates. The user login (or guest access, if it is enabled) provides access to camera controls similar to those available from the IR remote.

You will need to know the camera's IP address to use its web interface. If the network has a DHCP server, the camera will get its IP address, gateway and routing information automatically and you will be able to browse to it. If not, you will need to configure the camera to use a static IP address.

For cameras powered by a Quick-Connect USB or Quick-Connect USB Mini: These devices have network connectivity and web interfaces. In an network that does not automatically assign IP addresses, you will need to configure the camera with a different IP address to prevent IP address conflicts.

Getting the Camera's IP Address

You will need to be able to view the camera's video output.

1. Press the Data Screen button on the remote. The display presents the camera's IP address and MAC address.
2. Press the Data Screen button again to dismiss the information.

If the address is 169.254.1.1, the camera is using its default IP address. This usually means one of these things:

- The network automatically assigns IP addresses, but the camera is not connected to the network.
- The network does not automatically assign IP addresses, and you need to configure the camera for the network. See [Configuring the Camera with a Static IP Address](#).

Accessing the Web Interface

Enter the IP address or hostname in your browser's address bar. You may need to enter `http://` or `https://` as a prefix to keep the browser from treating it as a search query.

(Example: `http://10.30.200.125`)

Note

The cameras in the RoboSHOT product line all have very similar web interfaces. Although some of the screen shots in this manual may be from different models of camera than the one you have, your camera's web interface should present the same controls, organized in the same way.

Browser Support

We have tested this product with these web browsers:

- Chrome®
- Microsoft® Internet Explorer®
- Safari®
- Firefox®

We test using the browser version available from the vendor at that time. Older versions of these browsers are likely to work, and other browsers may also work.

User Access

By default, the web interface opens to the Controls page, but the camera can be configured to require a user login. The default user password is **password**, but this can be changed. Check with the system administrator if the camera's web interface requires you to log in.

Only the Controls page is available with user-level access.

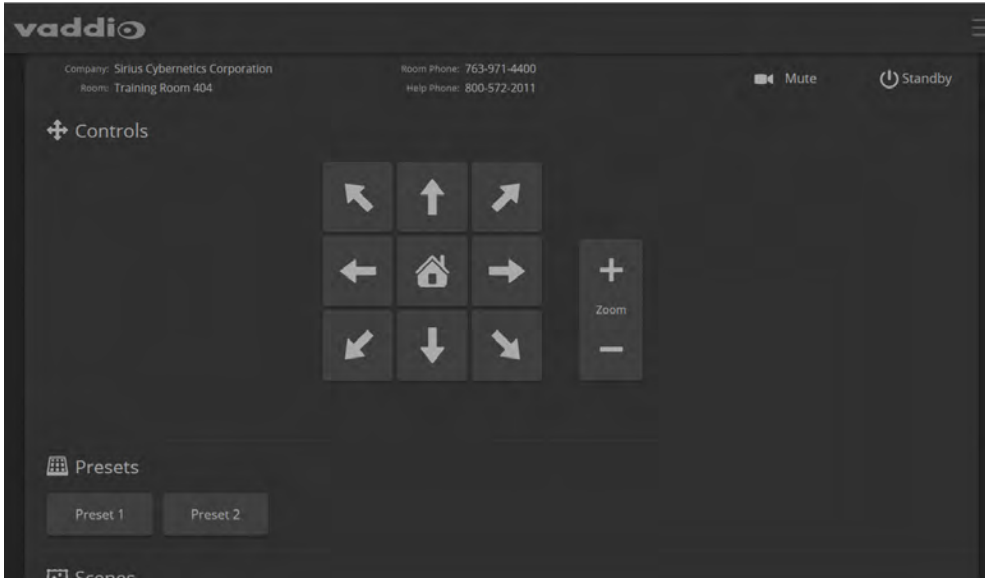

Your camera's Controls page will look somewhat different.

Administrative Access

If you are on the Controls screen, you're logged in at the user level, or guest access is enabled and you're not logged in at all.

Your camera's web interface will look somewhat different from this image.

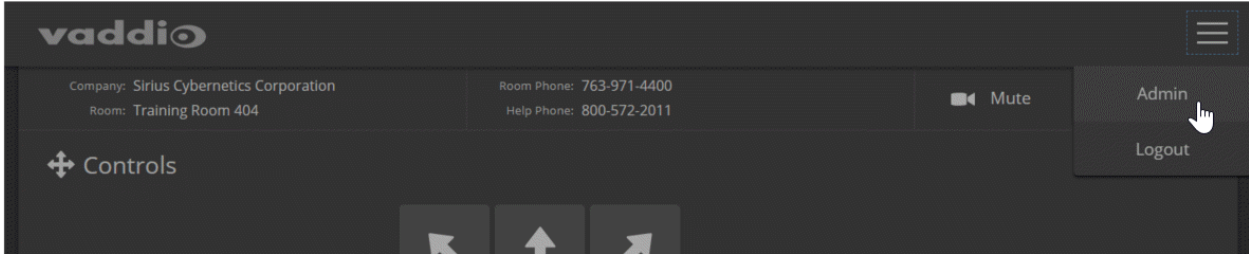

Open the menu to log on as Admin. The default admin password is **password**, but this can be changed.

Note

For best security, Vaddio strongly recommends changing the user and admin passwords from the default. Using the default passwords leaves the product vulnerable to tampering.

The admin account has access to system administration tasks and performance/behavior configuration tasks. System administration tasks are on the following pages, listed in the lower portion of the left navigation panel:

- Networking page – Configure date and time settings, hostname, and IP addressing.
- Security page – Set passwords, manage guest access, and enable/disable Telnet access.
- System page – View firmware version and switch settings, reboot, restore factory defaults, and update firmware.
- Room Labels page – Information to display on the web interface screens, including the conference room name and phone number and the in-house number for AV assistance.
- Help page – Tech support contact information and a link to the product information library on the Vaddio website.
- Diagnostics page – View or download the diagnostic log when troubleshooting issues.

Performance and behavior configuration tasks are on the following pages, listed in the upper portion of the left navigation panel:

- Camera page – Control the camera, make adjustments, create and manage presets and CCU scenes.

Compact Menu View

By default, the navigation buttons in the camera's administrative interface display an icon and a text label. You can also select the compact view of the menu buttons along with the standard view. The button at the bottom of the menu toggles between the two views.

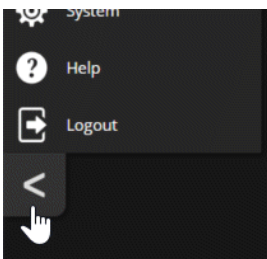

Working with the Quick-Connect Device's Web Interface

Quick-Connect USB and Quick-Connect USB Mini devices have their own web interfaces. Other Quick-Connect devices have no network connectivity, so they do not have web interfaces and do not need to be configured for your environment.

In addition to the administrative control pages, the Quick-Connect USB and Quick-Connect USB Mini web interfaces provide minimal camera controls, which are normally used with older cameras. For full camera functionality, use the IR Remote Commander or the camera's web interface.

Because the web interfaces for the Quick-Connect USB and Quick-Connect USB Mini are very similar, in many cases only the Quick-Connect USB web interface is shown in this manual.

During initial set-up and configuration, you may find it convenient to access the web interfaces for the camera and the Quick-Connect USB or Quick-Connect USB Mini on separate browser tabs.

Getting the Quick-Connect Device's IP Address

To access the web interface of the Quick-Connect USB or Quick-Connect USB Mini device, you will need to know its IP address.

- The Quick-Connect USB device displays its IP address on its front panel.
- The Quick-Connect USB Mini device's IP address is 169.254.1.1, and is not configurable.

Note

If a RoboSHOT camera is used with a Quick-Connect USB or Quick-Connect USB Mini device in a non-DHCP environment, the camera and the Quick-Connect device will default to the same IP address. You will need to configure the camera with a different IP address before connecting it to the network.

Quick-Connect USB Mini: Video Mode vs. Control Mode

When you try to access the web interface for the Quick-Connect USB Mini, your browser may present an error message.

The Quick-Connect USB Mini has two operating modes:

- **Video mode** – The Quick-Connect USB Mini passes camera control and video signals. The web interface is not available.
- **Control mode** – The web interface for the Quick-Connect USB Mini is available. The device does not pass control or video signals.

Press the Mode button to switch between video mode and control mode.

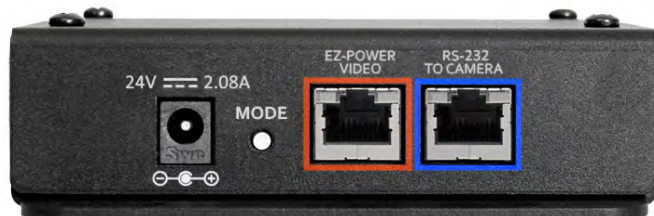

Accessing the Web Interface for the Quick-Connect USB or Quick-Connect USB Mini

1. **Quick-Connect USB Mini only:** If video is currently available on the connected display, press the Mode button on the Quick-Connect USB Mini.
2. Access the Quick-Connect device's web interface the same way you access the camera's web interface: Enter the IP address or hostname in your browser's address bar.
3. Select Admin to log in. The default admin password is **password**.
4. **Quick-Connect USB Mini only:** After you have finished working with the web interface, press the Mode button again to return to video mode.

The Quick-Connect USB and Quick-Connect USB Mini web interfaces open to the Camera Controls page. From this page, you can log in as admin to manage the device.



As admin, you have access to administrative and configuration pages similar to those available in the camera's web interface, plus a few controls for the camera. The camera controls were designed to be used with older cameras that lacked web interfaces. When using a Quick-Connect device with a RoboSHOT camera, Vaddio recommends using the Quick-Connect device's web interface only for managing the Quick-Connect device itself.

Web Interface Cheat Sheet

Where to find the camera controls you need right now.

What controls do you need?	Go to this screen
Camera operation <ul style="list-style-type: none"> ■ Stop sending video (video mute) ■ Enter or exit standby mode 	(any page)
Camera operation <ul style="list-style-type: none"> ■ Move or zoom the camera manually ■ Move to a camera preset (Presets section, if available) ■ Select the appropriate lighting adjustments (CCU Scenes section, if available) 	Controls (user or guest access) or Camera (admin access)
Camera behavior and adjustments <ul style="list-style-type: none"> ■ Set or clear presets ■ Set the speed for pan, tilt, or zoom motions ■ Focus the camera ■ Work with color and lighting adjustments (CCU scenes) ■ Set motors for inverted operation (Settings button reveals the control) 	Camera
Camera behavior settings – RoboSHOT 12E CAT-5 and RoboSHOT 30E CAT-5 On older RoboSHOT cameras, these settings are on the rear panel DIP switches. <ul style="list-style-type: none"> ■ IR1, IR2, IR3 (Frequency Selection) for controlling up to 3 cameras independently with the remote ■ IR on/off for enabling/disabling control via the remote ■ Image Flip for inverted camera installation ■ Baud rate for RS-232 serial communication 	System (DIP Switches tab)
Advanced camera settings <ul style="list-style-type: none"> ■ HDMI color space (YCbCr or sRGB; default is YCbCr) ■ Super-wide field of view (not available on 12E and 30E models) ■ Indicator light – select color scheme, enable/disable, set behavior in standby mode ■ Codec control mode 	System (DIP switches tab, General tab)
Read-outs of the camera's hardware switch settings	System (DIP switches tab)
Access management <ul style="list-style-type: none"> ■ Guest access ■ Account passwords ■ Idle session time-out ■ Telnet access enabled/disabled 	Security

What controls do you need?	Go to this screen
Network settings <ul style="list-style-type: none">■ Hostname■ DHCP or static addressing■ Static: IP address, subnet mask, gateway	Networking
Time zone and NTP server (source for system time/date)	Networking
Information about the camera location Help desk phone number for end users	Room Labels
Vaddio Technical Support contact information	Help
Diagnostic logs	Diagnostics

The structure of the Quick-Connect USB and Quick-Connect USB Mini web interfaces is nearly identical to the structure of the camera's web interface.

System Administration

This chapter covers settings for managing the camera as an element of your network.

Administrative tasks are on these pages of the web interface:

- Networking – Time settings, hostname, and other network configuration
- Security – Passwords, guest access, other IT security-related settings
- Room Labels – Helpful information to display in the web interface
- System – Controls to reboot, reset to factory defaults, and run firmware updates, read the rear panel switches, and access the soft DIP switches
- Help – Contact information for Vaddio Technical Support and a link to the documentation for this product
- Diagnostics – Logs to help Vaddio Technical Support troubleshoot issues

See [Configuring Camera Behavior](#) for information on image adjustments, streaming configuration, and other items related to camera behavior.

Note

Vaddio's RoboSHOT series cameras all have very similar web interfaces. Some of the screen shots in this manual may be from other models in the RoboSHOT series.

Note

Quick-Connect USB and Quick-Connect USB Mini devices provide a web interface that allows them to be configured and managed separately. The Quick-Connect web interfaces follow the same structure as the camera's web interface, and present similar system administration pages. This chapter includes information about the camera and the Quick-Connect device.

For Non-DHCP Environments: Configuring the Device with a Static IP Address for Initial Installation

NETWORKING PAGE

Caution

Consult your IT department before editing network settings. Errors in network configuration can make the camera inaccessible from the network. Do not change DHCP/Static addressing, IP address, subnet mask, or gateway unless you are very familiar with the characteristics and configuration of the network where you install the camera.

By default, the camera is set to DHCP and you do not need to configure it with a static IP address. However, if no DHCP server is available to automatically assign an address, the camera will use the default IP address of 169.254.1.1. If this is the case, you may need to follow this procedure.

The Quick-Connect USB is also set to DHCP by default. If no DHCP server is available to automatically assign an address, the Quick-Connect USB uses the same default IP address as the camera: 169.254.1.1.

If you install more than one camera on a network that does not automatically assign IP addresses (a non-DHCP network), follow this procedure to prevent IP address conflicts.

If you are installing in any of these environments, you will need to follow this procedure.

- Installing cameras with Quick-Connect USB devices on a non-DHCP network: *configure each camera and each Quick-Connect USB device* with static IP addresses before connecting them to the network.
- Installing cameras with other Quick-Connect devices on a non-DHCP network: *configure each camera* with a static IP address before connecting it to the network.
- Installing cameras with an AV Bridge MATRIX PRO on a non-DHCP network: *configure each camera* with a static IP address before connecting it to the network. The AV Bridge MATRIX PRO will also need a static IP address.

Note

If the camera is currently at an IP address other than 169.254.1.1, skip this section unless you are instructed to configure the camera with a static IP address.

To access the camera's Networking page during installation (skip this procedure if the camera has already been in service on this network):

1. Connect the camera to the Quick-Connect device according to the appropriate connection diagram, but *do not connect the camera to the network*.
2. Connect the network port on the camera to the network port on a computer. Depending on the computer, you may need a crossover cable.
3. On the computer, open a browser and access the camera's web interface at **http://169.254.1.1**.
4. Log in as admin. The default password is **password**.

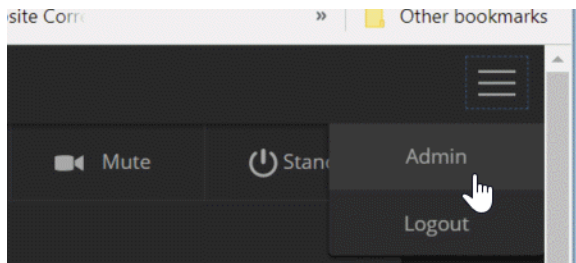

5. Navigate to the Networking page.

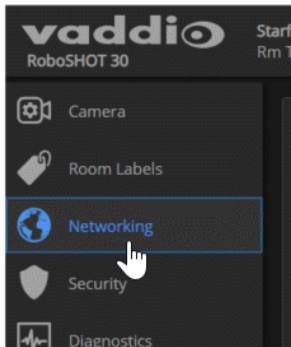

To configure the camera with a static IP address:

1. Work with your IT department to determine the correct IP address, subnet mask, and gateway to assign.

If you are connecting a camera with a Quick-Connect USB device, get the same information for both. The camera and the Quick-Connect device must have different IP addresses.

2. On the Networking page, set IP Address to Static.
3. Enter the IP address, subnet mask, and gateway as directed by the IT staffer; then save your work.

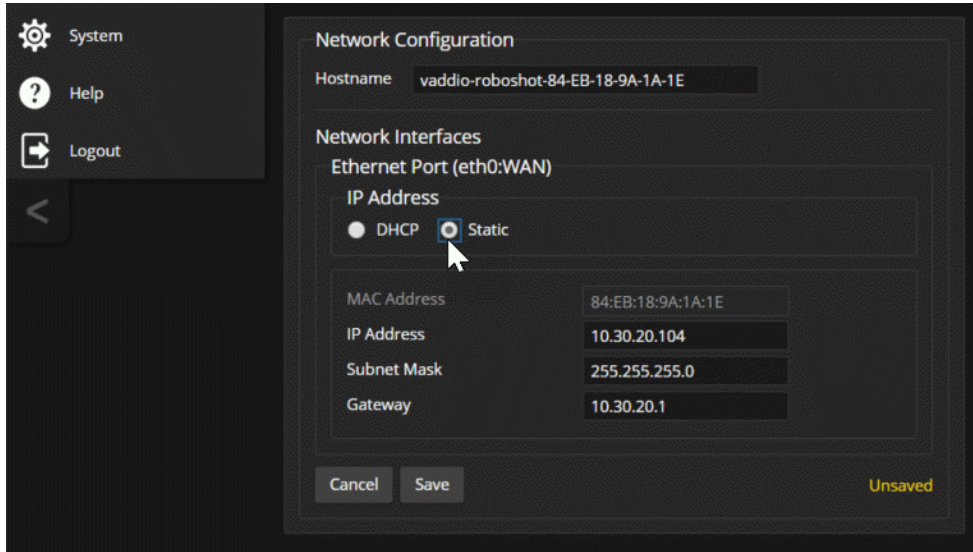

The camera is now ready to be connected to the network.

Configuring the Quick-Connect USB Device with a Static IP Address

NETWORKING PAGE, QUICK-CONNECT USB WEB INTERFACE

Caution

Consult your IT department before editing network settings. Errors in network configuration can make the device inaccessible from the network. Do not change DHCP/Static addressing, IP address, subnet mask, or gateway unless you are very familiar with the characteristics and configuration of the network where you install the camera.

Like the camera, the Quick-Connect USB defaults to DHCP. If no DHCP server is available, the Quick-Connect USB uses the same default static IP address as the camera: 169.254.1.1.

1. Work with your IT department to determine the correct IP address, subnet mask, and gateway to assign, if you have not done so already.
2. Connect the network port on the Quick-Connect USB to the network port on a computer. Depending on the computer, you may need a crossover cable.
3. On the computer, open a browser and access the Quick-Connect USB device's web interface.
4. Log in as admin. The default password is **password**.
5. Select Networking from the navigation pane.

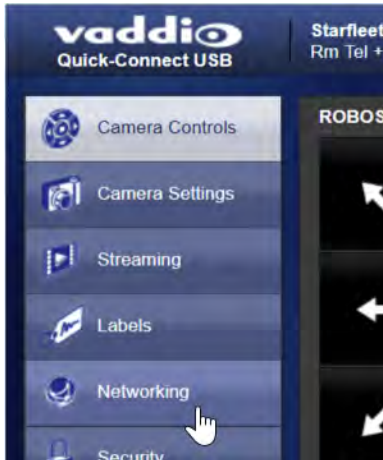

6. Set IP Address to Static.
7. Enter the IP address, subnet mask, and gateway as directed by the IT staffer; then save your work.

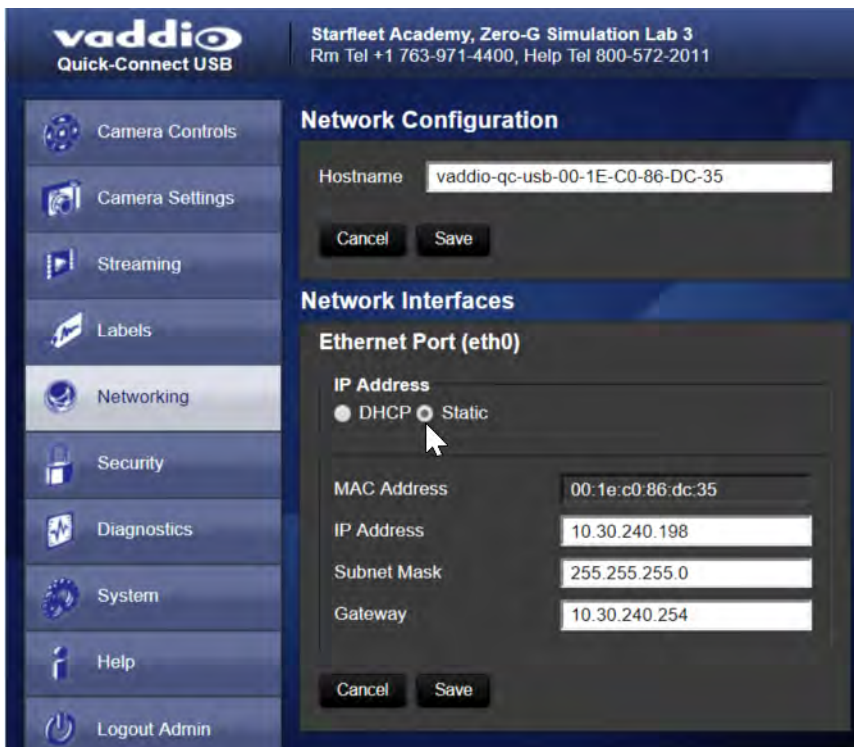

The Quick-Connect USB device is now ready to be connected to the network.

Changing the Camera's Hostname

NETWORKING PAGE

If your network supports hostname resolution, you may find it convenient to change the camera's hostname to something easy to remember, such as **camera-center-boardroom**.

Work with your IT department to ensure that the new hostname conforms to the organization's naming conventions.

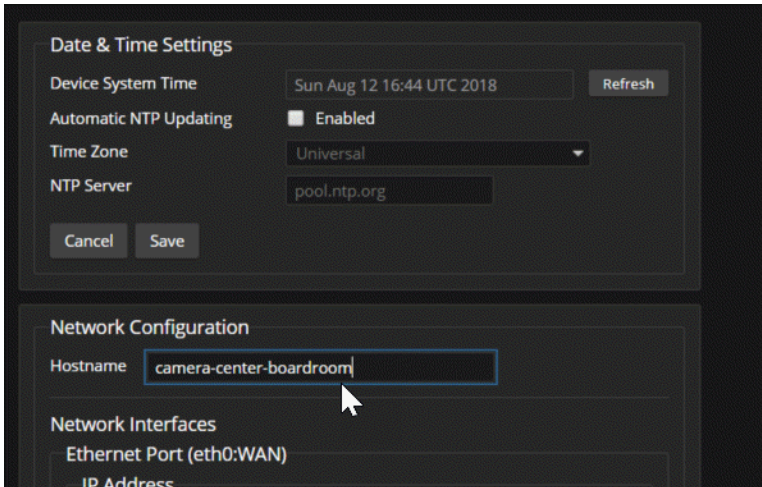

Changing the Quick-Connect Device's Hostname

NETWORKING PAGE, QUICK-CONNECT WEB INTERFACE

If the camera is connected to a Quick-Connect USB or Quick-Connect USB Mini, you can also assign a hostname to Quick-Connect device.

The Networking page in the web interface for the Quick-Connect USB Mini is similar to the one for the Quick-Connect USB shown here.

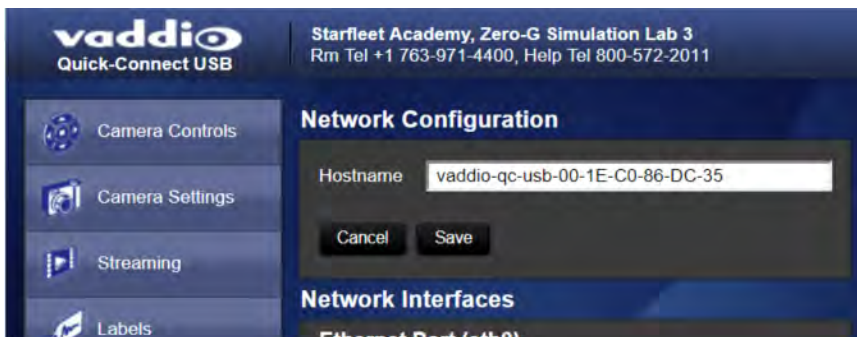

Optional For DHCP Environments: Changing from a DHCP Address to a Static IP Address

NETWORKING PAGE

In a network that assigns IP addresses automatically, the camera's IP address may change from time to time. To keep this from happening, set the IP address to Static. *Do not change the IP address, subnet mask, or gateway unless the network administrator instructs you to do so.*

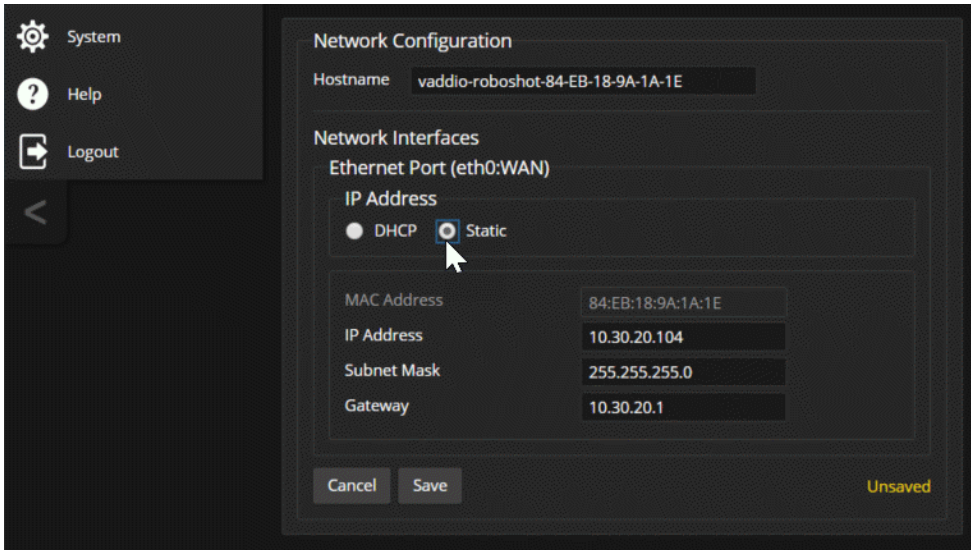

If you install the camera with a Quick-Connect USB device, you can make its IP address static also. This setting is on the Networking page of the Quick-Connect USB web interface.

Specifying Time Zone and NTP Server

NETWORKING PAGE

Using automatic NTP updating ensures that the timestamps in the camera's diagnostic log are accurate. Specifying your time zone may make it easier to match logged events with other actions and external events.

1. To make the time zone and NTP server editable, enable Automatic NTP Updating.
2. Select the desired time zone from the list.
3. If desired, specify the NTP server to use. Otherwise, use the default.

You may need to refresh the system time display.

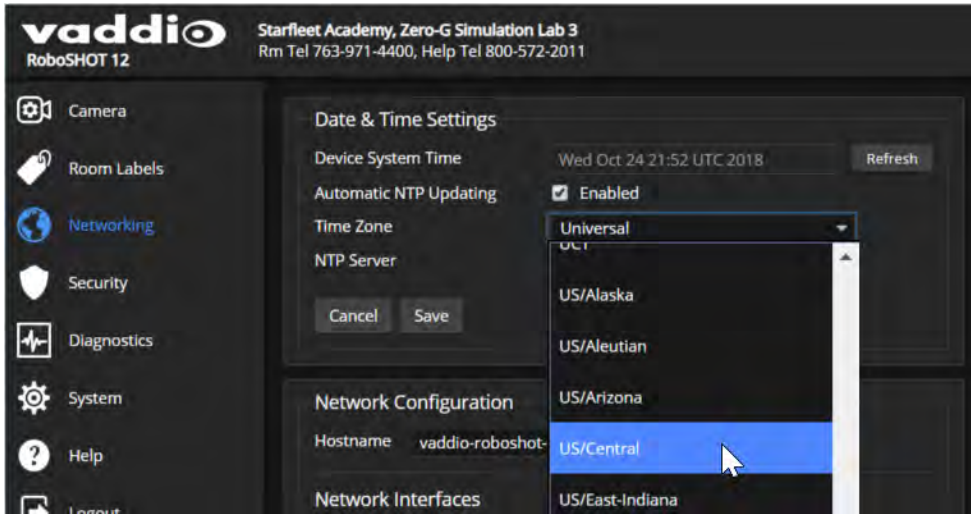

Managing Access and Passwords

SECURITY PAGE

Set the camera according to your organization's security policies:

- Allow or deny access to the Camera screen without logging on (Allow Guest Access) – this is enabled by default
- Set whether inactive sessions log off automatically or not (Automatically Expire Idle Sessions) – by default, inactive sessions expire after 30 minutes
- Change the password for the `admin` account
- Change the password for the `user` account
- Allow or disable access via Telnet (by default, access via Telnet is enabled)
- Require HTTPS for web access (by default, HTTP is also permitted)
- Allow or deny device discovery (allowed by default)

Note

Consult your network security specialist before changing any of these settings.

Note

For best security, Vaddio strongly recommends changing the user and admin passwords from the default. Using the default passwords leaves the product vulnerable to tampering.

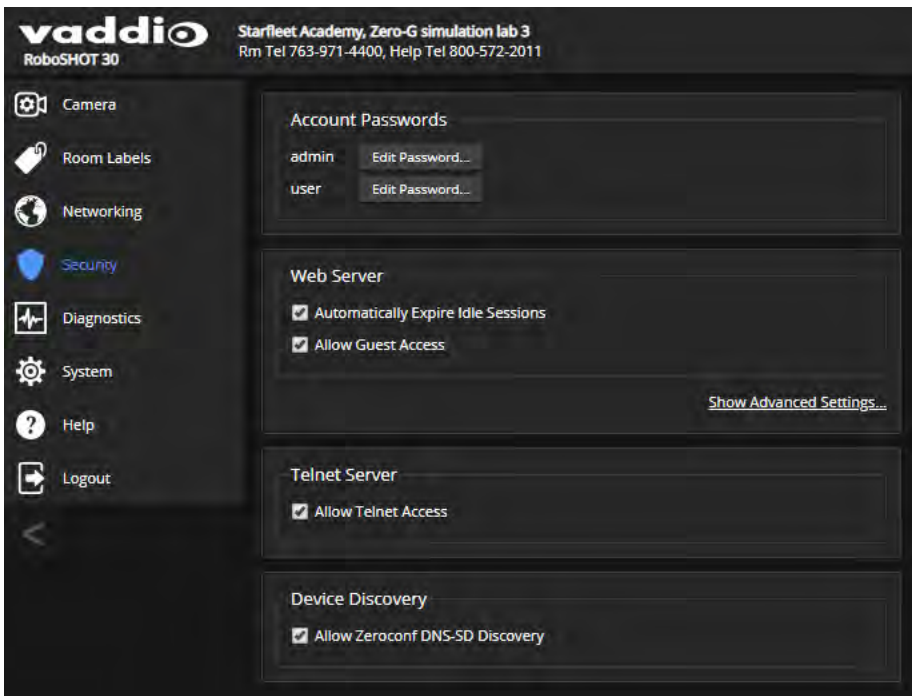

Disabling Telnet Access

SECURITY PAGE

If your installation does not require camera access via Telnet, you may choose to disable the camera's internal Telnet server.

Enabling or Requiring HTTPS

SECURITY PAGE

By default, the web interface uses the HTTP protocol. You can configure the camera's web interface to require a secure HTTPS connection instead.

Caution

Consult your network security professional to manage the camera's SSL certificate. Do not make any changes in the Certificate or Private Key text boxes without guidance from your organization's network security professional.

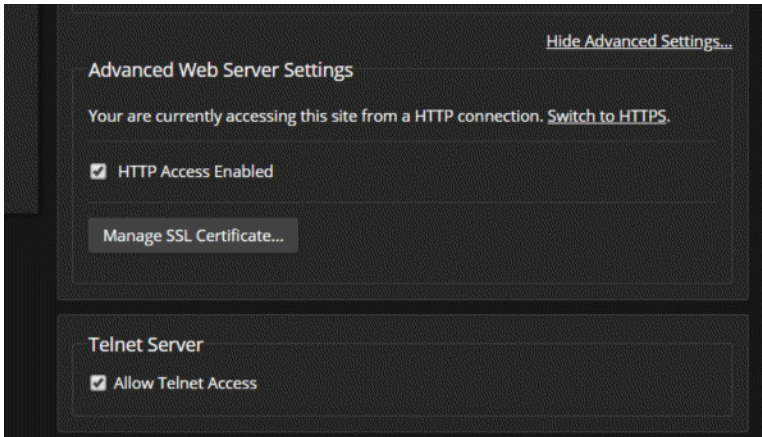

1. Select Show Advanced Settings. The advanced options open.
2. To switch to a secure HTTPS connection, select Switch to HTTPS.

Note

Your browser may present messages warning you that your connection is not secure, because the site's certificate is not valid. This happens when HTTPS is used but no SSL certificate is installed.

3. To require HTTPS connections, clear the box labeled HTTP Access Enabled. The camera's web interface will only be available via an HTTPS connection.

Changing the Admin Password on the Quick-Connect Device

SECURITY PAGE, QUICK-CONNECT WEB INTERFACE

Default passwords for both User and Admin are **password**. At this time, the User password is not required.

Note

For best security, Vaddio strongly recommends changing the user and admin passwords from the default. Using the default passwords leaves the product vulnerable to tampering.

Be sure you have a way to remember the Admin password if you change it.



Adding Room Information to the Camera's Web Interface

ROOM LABELS PAGE

The information you enter on this page is displayed on every page of the web interface.

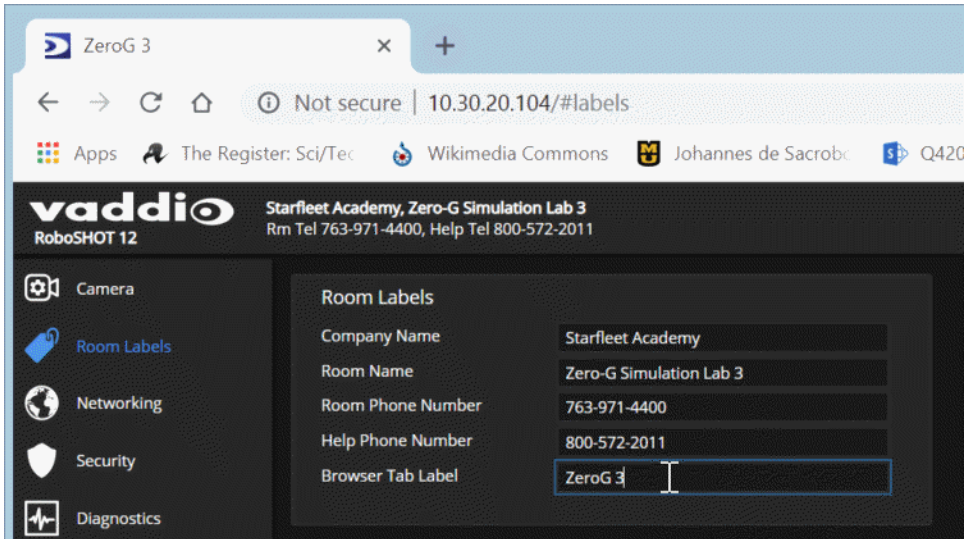

Adding Room Information to the Quick-Connect Device's Web Interface

ROOM LABELS PAGE, QUICK-CONNECT WEB INTERFACE

Use the Room Labels information to help you identify the Quick-Connect USB or Quick-Connect USB Mini connected to a specific camera.

The Room Labels page in the web interface for the Quick-Connect USB Mini is similar to the one for the Quick-Connect USB shown here.

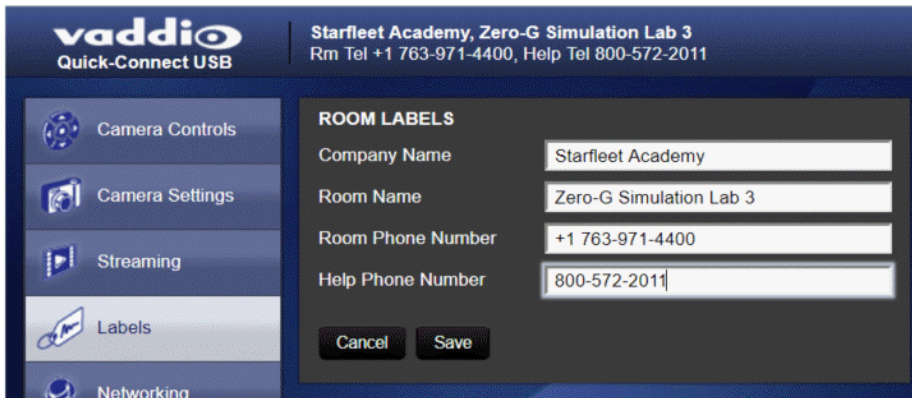

Saving (Exporting) or Restoring (Importing) a Camera Configuration

SYSTEM PAGE, FIRMWARE TAB

You can import a configuration to several cameras if you need to configure them the same way. Cameras must be of the same model, and must have a compatible firmware version installed. Configuration data does not include passwords or unique information such as hostname.

1. Configure the first camera.
2. Export its configuration (Export Data button). The export downloads to your computer as a .dat file. The filename is the camera's hostname.

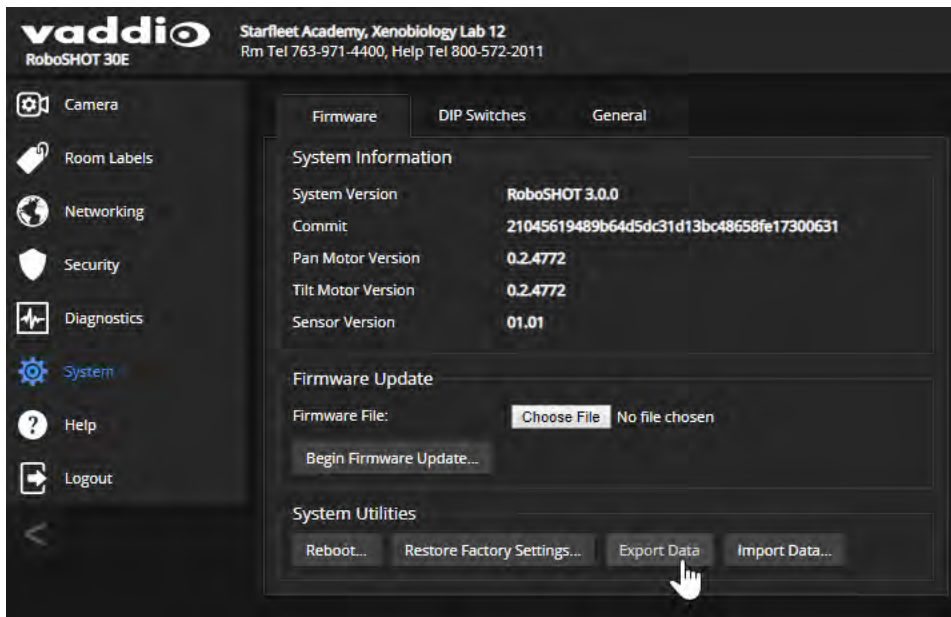

3. Import the configuration to the other cameras (Import Data button in each camera's web interface). The web interface prompts you to browse to the .dat file that will be imported.

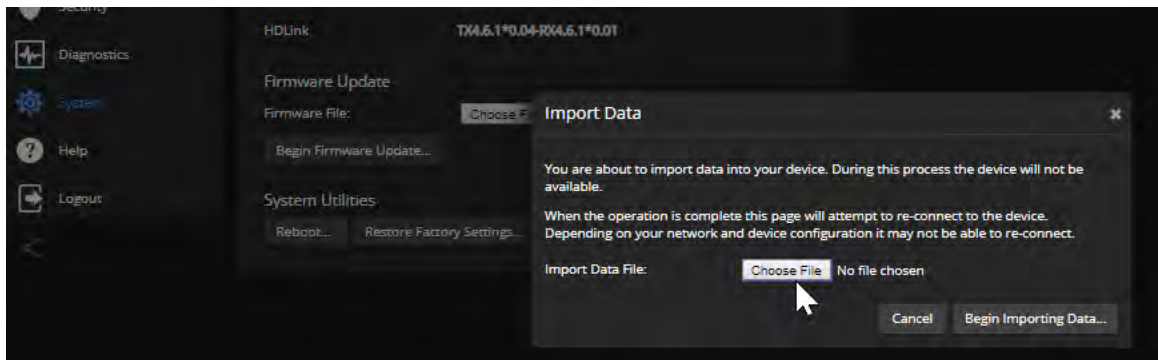

Note

If the camera is using an older firmware version, it may be unable import a configuration that was exported from a camera using a different version of firmware.

Installing a Camera Firmware Update

SYSTEM PAGE, FIRMWARE TAB

Caution

The camera must remain connected to power and to the network during the update. Interrupting the update could make the camera unusable.

1. Download the firmware and its release notes.
2. Select Choose File, then browse to the downloaded firmware and select it. The filename ends with .p7m.
3. Select Begin Firmware Update.
4. Read and understand the information in the Confirm dialog box. It's dull, but it could save you some time and aggravation.
5. Select Continue. A progress message box opens and the indicator light on the front of the camera turns yellow. If the update process presents warnings or error messages, read them carefully.

The camera reboots when the update is complete.

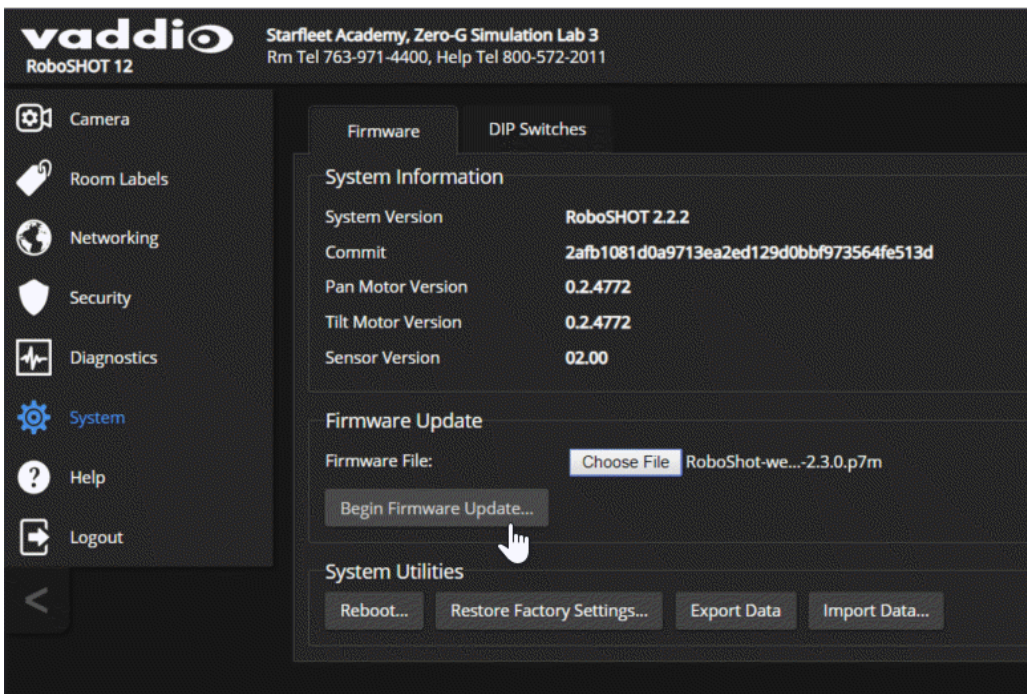

Installing a Quick-Connect USB or Quick-Connect USB Mini Firmware Update

SYSTEM PAGE, QUICK-CONNECT WEB INTERFACE

The procedure for updating the firmware on a Quick-Connect USB or Quick-Connect USB Mini device is similar to the procedure for updating the camera's firmware.

1. Download the firmware and its release notes.
2. Select Choose File, then browse to the downloaded firmware and select it. The filename ends with .p7m.
3. Select Begin Firmware Update.
4. Read and understand the information in the Confirm dialog box. It's dull, but it could save you some time and aggravation.
5. Select Continue. A progress message box opens. If the update process presents warnings or error messages, read them carefully.

The Quick-Connect device reboots when the update is complete.

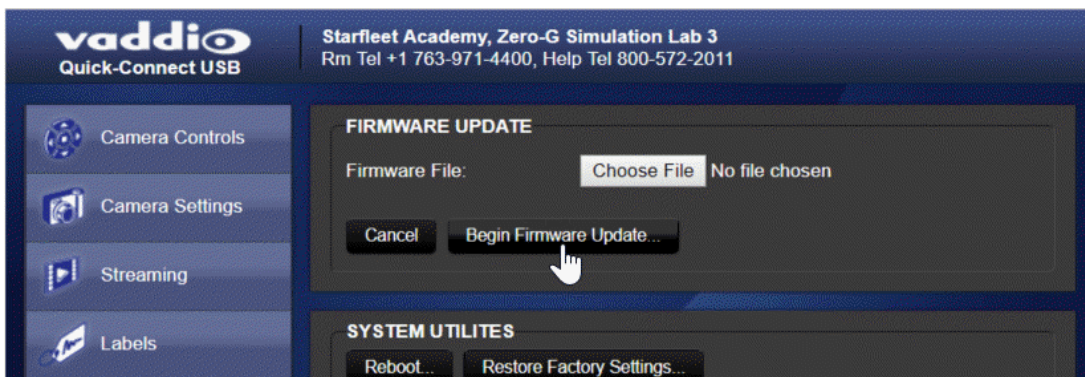

Caution

The Quick-Connect device must remain connected to power and to the network during the update. Interrupting the update could make the camera unusable.

Note

For instructions on updating the Universal CCU, see [Installing a Firmware Update on the Universal CCU](#).

Installing a Firmware Update on the Universal CCU

1. Download the firmware and its release notes. The release notes include detailed instructions on installing the firmware.
2. If you have Vaddio Loader installed on your computer, check the version (Help::About). If you have a version earlier than what is specified in the Universal CCU release notes, uninstall it.

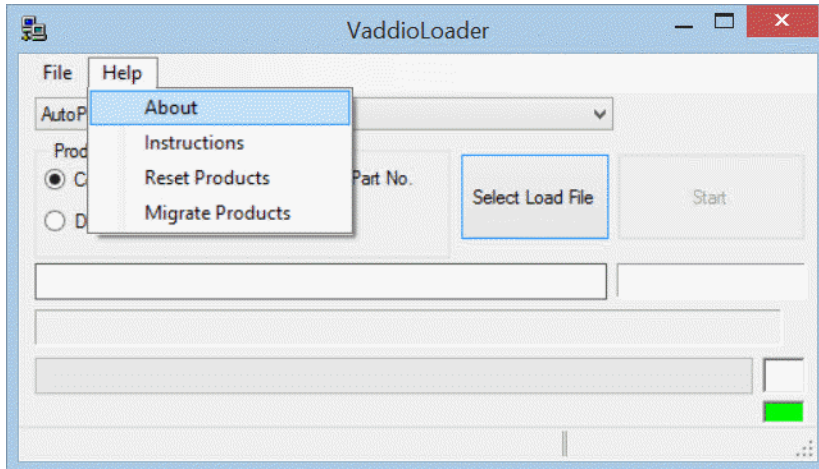

3. If you do not already have the latest version of Vaddio Loader, download it from support.vaddio.com and install it on your computer.
4. Disconnect power from the Universal CCU.
5. Connect the Universal CCU's RS-232 IN port to your computer's serial port. Be sure you know which COM port it is. (For Windows operating systems, this information is available in the Device Manager.)
6. On the Universal CCU, press and hold the recessed button near the power socket while reconnecting power. The Tally light will blink once, and the LCD screen will be black with no text.

Note

If the LCD screen displays information, the Universal CCU is NOT in boot-loader mode. Disconnect power and repeat this step.

7. Follow the instructions in the release notes to install the firmware on the Universal CCU.

Rebooting the Camera

SYSTEM PAGE, FIRMWARE TAB

This can help if the camera stops responding as you expect.

In the System Utilities section, select Reboot.

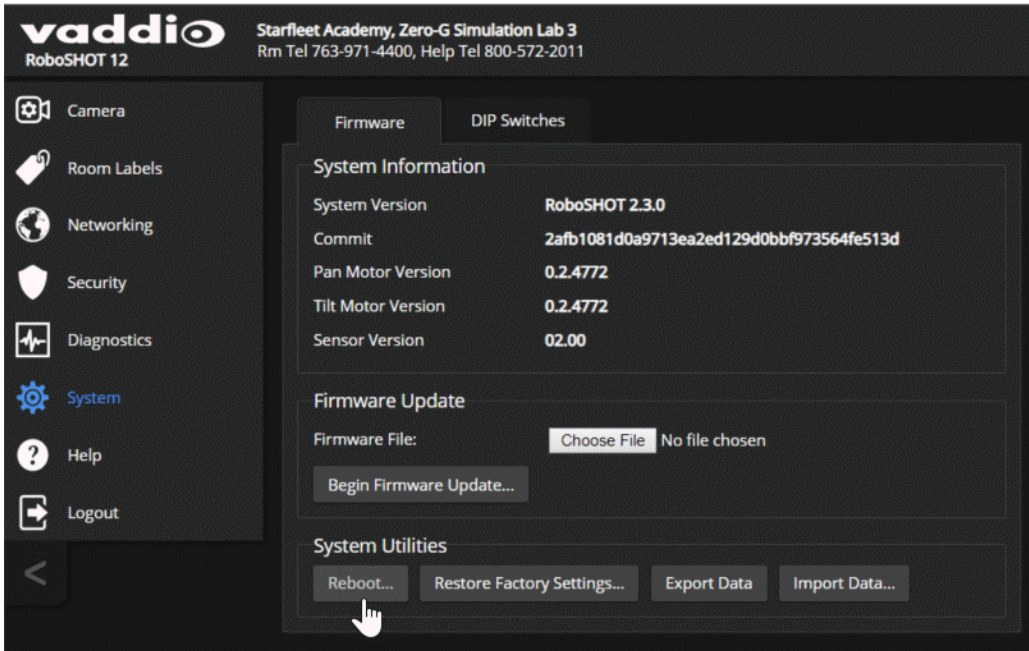

Rebooting the Quick-Connect Device

SYSTEM PAGE, QUICK-CONNECT WEB INTERFACE

You can reboot the Quick-Connect USB or Quick-Connect USB Mini device the same way you reboot the camera. Select Reboot from the System page.

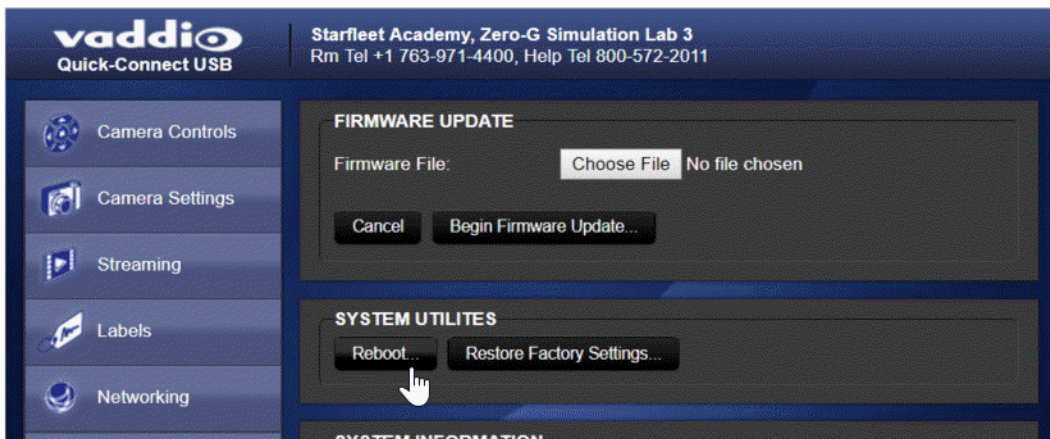

Contacting Vaddio Technical Support

HELP PAGE

If you can't resolve an issue using your troubleshooting skills (or the [Troubleshooting](#) table in this manual), we are here to help.

You'll find information for contacting Vaddio Technical Support on the Help page. The model identifier and the link for support information vary depending on the camera model.

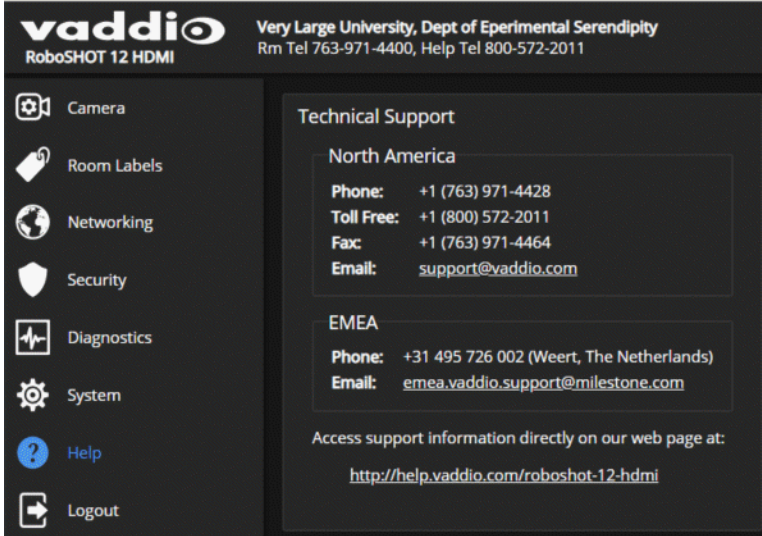

Accessing the Diagnostic Logs

DIAGNOSTICS PAGE

When you contact Vaddio technical support, your support representative may ask you to download and email the log file available from the Diagnostics page.

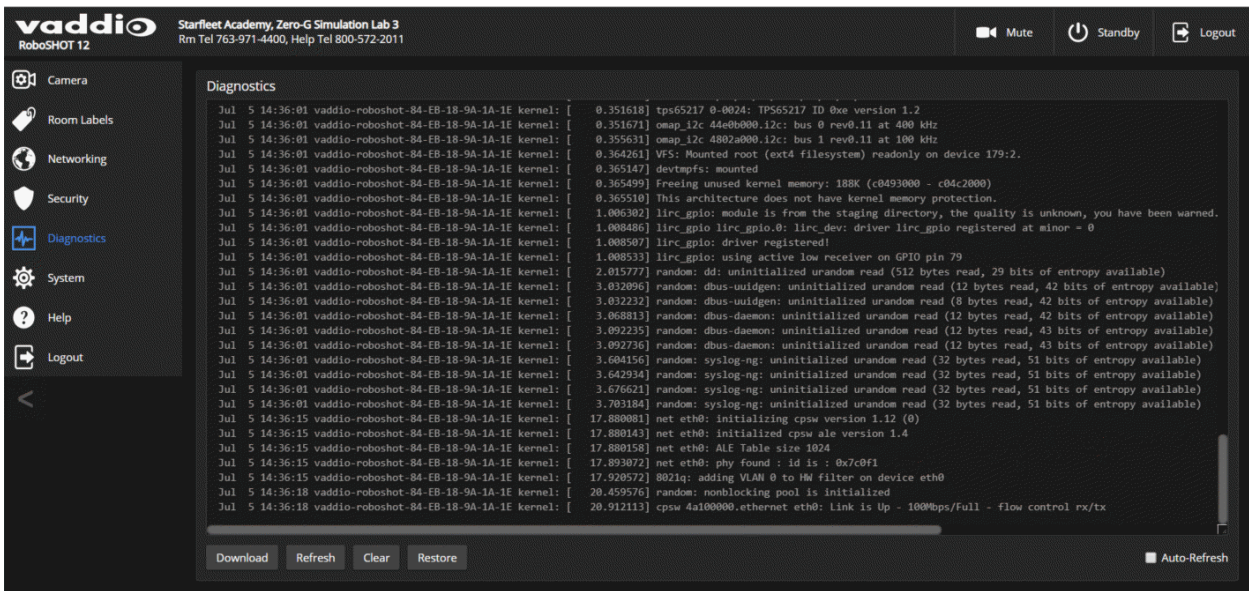

If the camera is connected to a Quick-Connect USB or Quick-Connect USB Mini device, you can access the device's diagnostic logs on the Diagnostics page of its web interface.

Configuring Camera Behavior

This chapter covers managing the camera as a part of the room's AV environment.

Camera configuration tasks are available on these pages:

- Camera – Color and lighting adjustments, presets (including custom Home), and real-time camera control
- System (DIP Switches tab) – Camera identification (Camera 1, 2, or 3 on the remote), status light behavior, codec control mode, and more
- Streaming (available with Quick-Connect USB and Quick-Connect USB Mini only) –
 - Quick-Connect USB Mini: USB device name and color space only; both are optional
 - Quick-Connect USB: Streaming mode (USB or IP); USB device name and color space; IP video quality, bandwidth, and more

Note

Vaddio's RoboSHOT series cameras all have very similar web interfaces. Some of the screen shots in this manual may be from other models in the RoboSHOT series.

Setting the Custom Home Position and Other Preset Shots

CAMERA PAGE

The camera's default home position is 0° pan and 0° tilt; you can set a different home position.

You can also define other presets, for shots that you will want to use repeatedly.

Note

Storing a preset overwrites any information that was previously associated with that preset. The Store Preset dialog does not show which presets have already been defined. Vaddio recommends renaming presets when you store them.

To store a preset or custom home position:

1. Set up the shot.
2. Select Store to open the Store Preset dialog.
3. Select the preset to define.
4. Select Store with Current Color Settings to save the current CCU settings along with the camera position.
5. Select Save with Tri-Sync to allow the pan, tilt, and zoom motors to move simultaneously from other presets to this position.
6. Store the preset.

Note

Tri-Synchronous Motion works best for on-air shots requiring significant movement. It is not useful when moving the camera less than 10° or when the camera is not on the air.

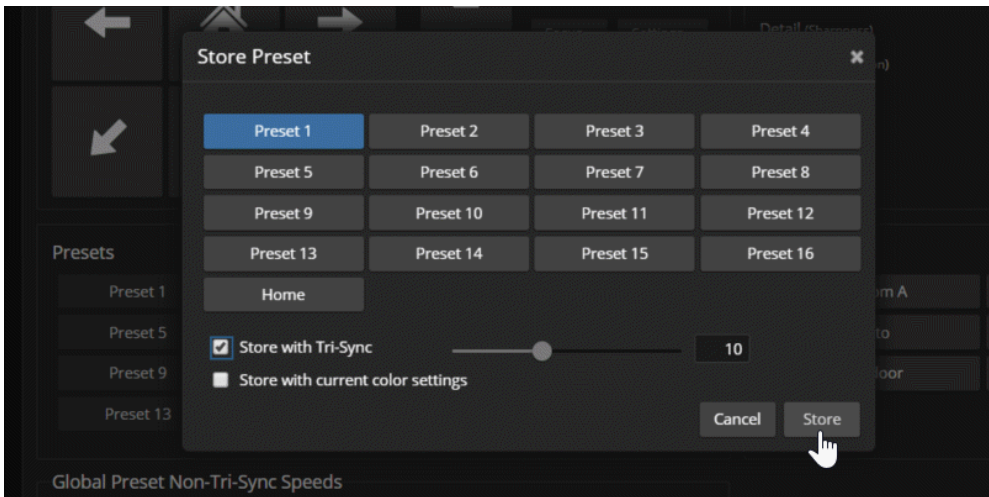

Renaming Presets and Custom CCU Scenes

You can rename presets and custom scenes. The process is the same for both. Right-click the button for the custom scene or preset, and edit the label.

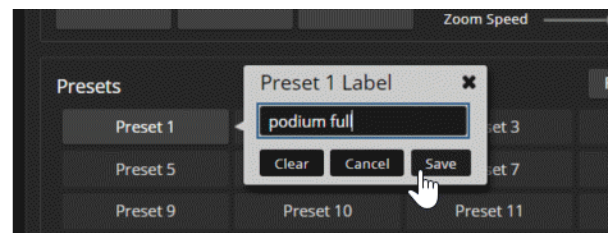

Initial Lighting and Color Settings

CAMERA PAGE

No two rooms are exactly alike – but a lot of rooms are a lot alike. The technical folks at Vaddio (Scott, to be specific) have already set up presets for common lighting scenarios (CCU scenes) – Incandescent Hi, Incandescent Lo, Fluorescent Hi, Fluorescent Lo, and Outdoor. The Auto setting allows the camera to determine the appropriate adjustments.

Adjust the camera for the lighting in use by selecting the CCU scene that best fits your environment.

Note

If the camera is connected to a Universal CCU, use the Universal CCU to manage lighting and color adjustments when you are in the same room as the equipment. See [Managing Lighting and Color Adjustments with the Universal CCU](#).

You can still manage lighting and color adjustments from the camera's web interface, if you are not in the same room with the equipment.

Some adjustments to lighting and color may be necessary.

Note

Color adjustments are not available when the Auto CCU scene is selected.

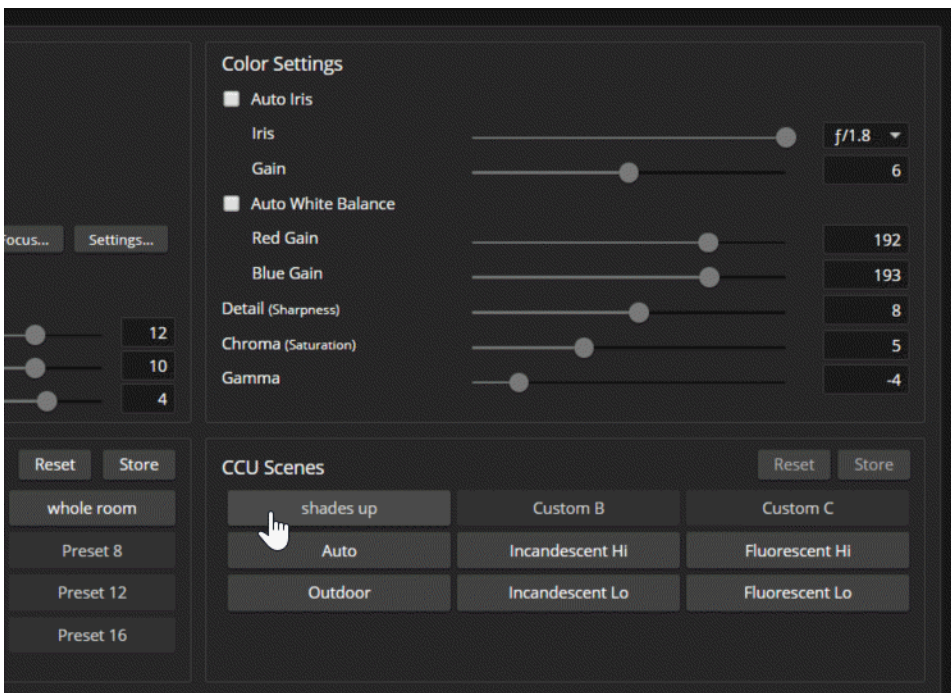

Lighting Adjustments

CAMERA PAGE

The camera provides settings to compensate for common lighting problems.

- **Auto Iris** allows the camera to compensate automatically for the light level.
- **Backlight Compensation** reduces contrast to adjust for bright light behind the main subject of the shot. Use this if the subject is in front of a window, projector screen, or other bright area and appears as a silhouette. This setting can't be used with Wide Dynamic Range.
- **Wide Dynamic Range** automatically darkens bright areas and brightens dark areas to provide a more properly exposed image in challenging lighting conditions. This setting can't be used with Backlight Compensation.
- **Point Light Compensation** reduces the intensity of small, extremely bright areas (point light sources) that would otherwise swamp the camera with light and make it difficult to see details in areas with less intense lighting. *This setting is only available on the RoboSHOT 12E CAT-5 and RoboSHOT 30E CAT-5 cameras. It is on the General tab of the System page.*

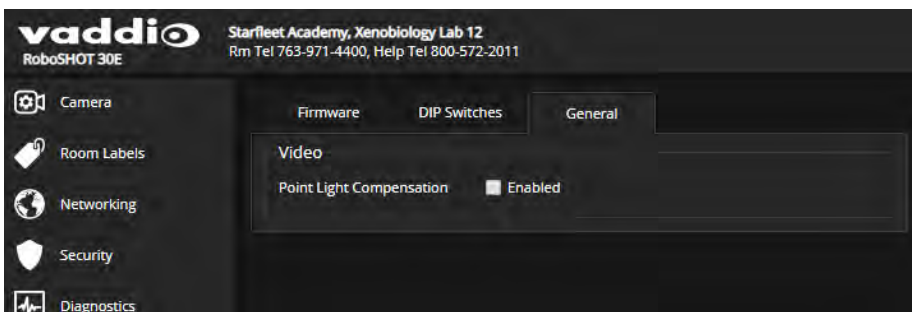

Depending on the camera's firmware version, additional settings may also be available on this tab.

The [Lighting and Image Quality Cheat Sheet](#) may be helpful.

Fine-Tuning Image Quality and Color

CAMERA PAGE

Fine-tune the color and lighting as needed using the Color Settings controls.

- **Auto White Balance** adjusts color automatically. Red gain and blue gain controls are not available when Auto White Balance is selected.
- **Red Gain** and **Blue Gain** provide manual color adjustment.
- **Detail** adjusts the image sharpness. If the video looks grainy or "noisy," try a lower Detail setting. (As in conversation, too much detail is bad.)
- **Chroma** adjusts the color intensity.
- **Gamma** adjusts the range (grey density) between bright areas and shadows.

If you change Red Gain or Blue Gain and you don't like the results, start over by selecting and then deselecting Auto White Balance.

The [Color Adjustment Cheat Sheet](#) may be helpful.



Lighting and Image Quality Cheat Sheet

Here are some tips for using the CCU settings for lighting and image quality. For more detailed information on each setting, see [Lighting Adjustments](#) and [Fine-Tuning Image Quality and Color](#).

What do you need to correct?	Make this adjustment:
The image is too dark	Increase Iris (lower F-stop value)
	Increase Iris Gain
The image looks washed out or faded	Decrease Iris (higher F-stop value)
	Decrease Iris Gain
	Increase Chroma
	Decrease Gamma
The subject is silhouetted against a bright background	Enable Backlight Compensation
Small sources of bright light (point sources) make it hard to see details in areas with less intense lighting.	Enable Point Light Compensation (RoboSHOT 12E and 30E CAT-5 only)
Highlights and shadows look right, but mid-tones are too dark.	Increase Gamma
Shadows are too dark	Enable Wide Dynamic Range (WDR)
	Decrease Gamma
The image looks grainy	Decrease Detail
	Decrease Iris Gain
"Soft focus" effect; the image looks unrealistically smooth	Increase Detail

Color Adjustment Cheat Sheet

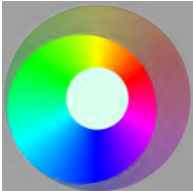
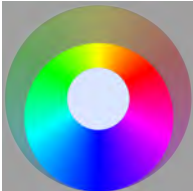
Here are some tips for using the color-related CCU settings. For more detailed information on each setting, see [Fine-Tuning Image Quality and Color](#).

What do you need to correct?	Make this adjustment:
Colors look less vivid than they should	Increase Chroma
Colors look too vivid	Decrease Chroma
Colors look wrong; white objects do not appear white	Enable Auto White Balance
	One Push White Balance
	Disable Auto White Balance and <ul style="list-style-type: none"> ■ adjust Red Gain (decrease for less red, increase for less green) ■ adjust Blue Gain (decrease for less blue, increase for less yellow)
<div style="display: flex; justify-content: space-around; text-align: center;"> <div> <p>Too much red</p>  </div> <div> <p>Not enough red</p>  </div> <div> <p>Too much blue</p>  </div> <div> <p>Not enough blue</p>  </div> <div> <p>Balanced</p>  </div> </div>	

Saving Color and Lighting Settings

CAMERA PAGE

If you are adjusting for lighting conditions that are likely to recur, you can save your adjustments as a custom scene.

1. Adjust lighting, image quality, and color.
2. When the scene looks the way you want it to, click Store CCU Scene.
3. In the Store CCU Scene dialog box, select which custom scene to store (Custom A, B, or C) and select Save.

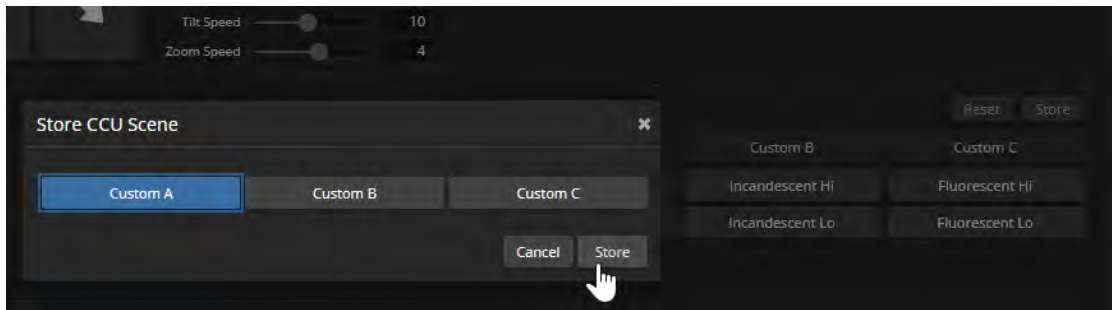

4. Optional: Name the new scene by right-clicking its button. A dialog box opens. Enter the name and save it.

Adjusting the Focus

CAMERA PAGE

Open the Focus control to select Auto-focus, or set manual focus with the + (near) and – (far) buttons. I know you already understand this, but I'm going to say it anyway: The + and – buttons don't work when Auto Focus is selected.



For users who are not logged in as admin, focus control is available via the IR Remote Commander.

Speed Adjustments

CAMERA PAGE

The following speed adjustments are available:

- Manual pan, tilt, and zoom speeds – Used when you control camera movements with the IR Remote Commander or the arrow buttons in the web interface
- Global Preset Non-Tri-Sync Speeds – Separate pan, tilt, and zoom speeds used for movements between presets that do not use Tri-Synchronous Motion.
- Tri-Synchronous Motion speed – Only available when storing a preset with the Store with Tri-Sync option selected.

About Tri-Synchronous Motion

The Tri-Synchronous Motion algorithm calculates the pan, tilt and zoom speeds needed for the camera to move to a preset position, so that all three movements begin together and arrive at the same time. It ensures smooth on-air movements when making large changes in position, particularly when the zoom also changes. Tri-Synchronous Motion is only available as an option for moving to specific preset position.

Tri-Synchronous Motion is not helpful in movements of less than 10°, and is typically used only for on-air operation.

Setting the Speed for Manual Movements

CAMERA PAGE

The Pan Speed, Tilt Speed, and Zoom Speed sliders control how fast the camera moves in response to the direction and zoom controls on the IR remote and in the web interface.

To set speeds for movements using the arrow buttons:

Use the speed sliders to adjust the speed of movements that you control with the buttons for pan, tilt, and zoom. For tight shots, slower is usually better.



Setting the Speed of Movements to Presets

CAMERA PAGE

To set speeds for movements to presets:

1. Store presets at several points in the room, at different zoom levels, saving them without selecting the Tri-Sync option.
2. Move among the presets using the preset buttons.
3. Use the Global Preset Non-Tri-Sync Speed sliders to adjust as needed.

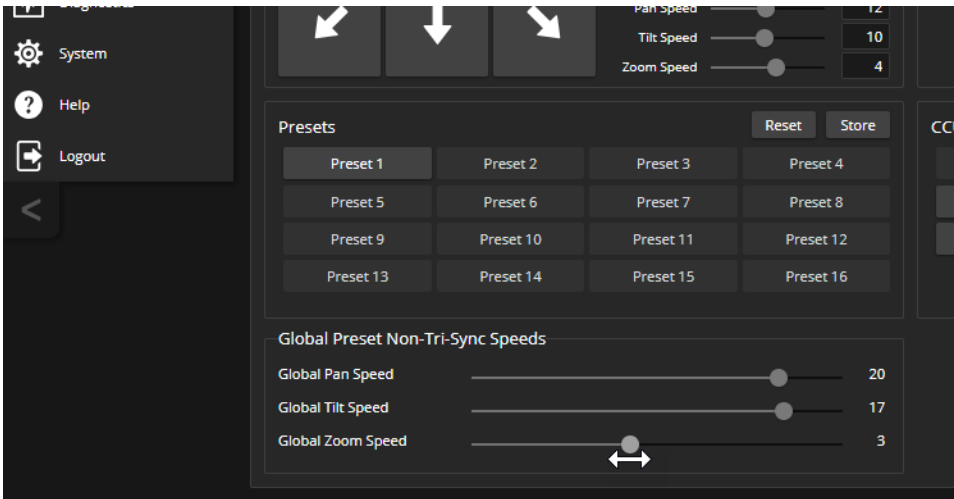

Adjusting Tri-Synchronous Motion Speed

CAMERA PAGE

The Tri-Synchronous Motion algorithm calculates the pan, tilt and zoom speeds needed for the camera to move from one preset to the next so that all three movements begin together and arrive at the same time. You may need to experiment to find the best Tri-Sync speed setting. Here is a simple method:

1. Store a preset, checking Save with Tri-Sync and setting the speed slider about a third of the way along the scale.
2. Move the camera to a different pan, tilt, and zoom position, and save this position as another preset. Again, check Save with Tri-Sync; but set the speed slider to about the halfway point.
3. Move the camera from one preset to the other to evaluate which movement is closer to the speed you want. Use the Tri-Sync speed associated with that preset, or adjust it as needed.
4. Store all the presets you will need.
5. Switch among the presets to determine whether any of them should use different Tri-Sync speeds.
6. Adjust the speeds as needed.



Setting the Direction for Camera Movements

CAMERA PAGE

By default, the arrow buttons on the remote and in the web interface show the direction you would see the camera move if you were looking the same direction as the camera. If a person facing the camera is controlling it with the remote, using the right arrow pans the camera to the person's left.

To make the arrow buttons indicate camera movement from the perspective of a person facing the camera, open the Settings control and invert the pan direction.

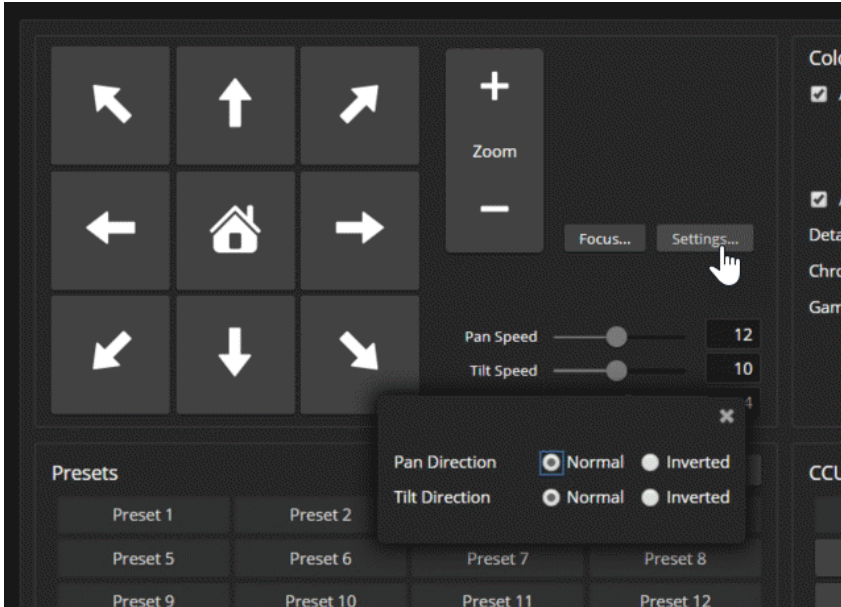

Reading the Camera's Switches

SYSTEM PAGE, DIP SWITCHES TAB

Open the DIP Switches tab to see the camera's current switch settings and configure certain camera behaviors.

Note

Sorry, this tab only controls the soft DIP switches. If your camera has physical switches, you have to physically move them to change the settings.

This screen shot shows the DIP Switches tab for the older RoboSHOT 30 camera. The lower array of DIP switches is a read-out of the physical DIP switches on the back of the camera.

Note

If your camera has been updated to firmware version 3.1.0 or later, most of the soft DIP switch settings are now on the General tab.

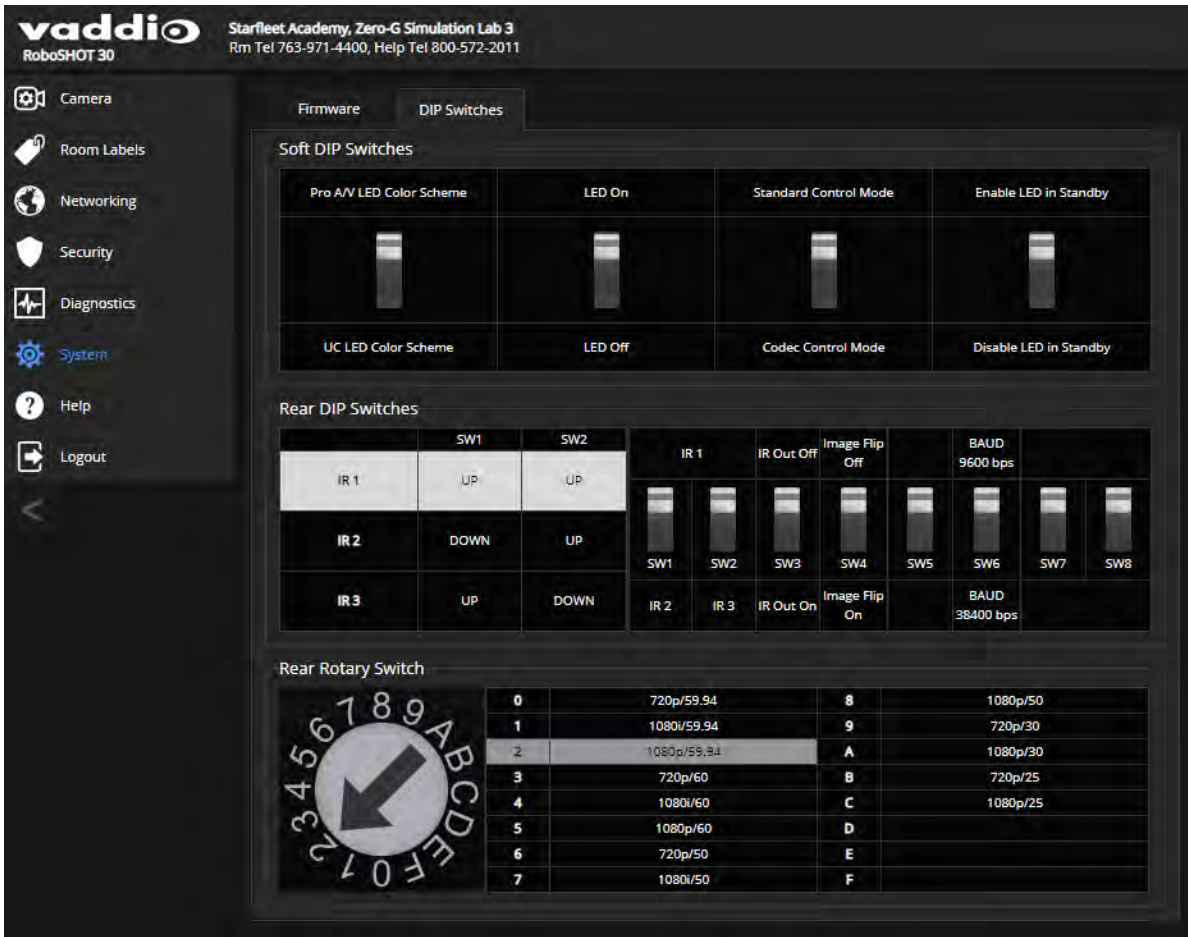

Basic Camera Settings for RoboSHOT 12E CAT-5 and RoboSHOT 30E CAT-5

SYSTEM PAGE, DIP SWITCHES TAB

Basic settings for the RoboSHOT E-series cameras are on the lower row of soft DIP switches. These correspond to the physical switches on the older RoboSHOT cameras.

IR1, IR2, IR3 (Frequency Selection): If there are multiple cameras in the room, use these two switches to configure each camera with a different IR frequency. Then use the Camera Select buttons at the top of the remote to select the camera you want to control. This allows the IR Remote Commander to control them independently.

- Left and right IR switches up: IR frequency 1
- Left IR switch down, right IR switch up: IR frequency 2
- Left IR switch up, right IR switch down: IR frequency 3

IR On/Off: Leave this switch UP if the IR remote will be used.

Image Flip: If mounting the camera upside-down, set the Image Flip switch ON. This orients the video image correctly and sets the tilt motors to respond appropriately to tilt up and down commands from the remote, web interface, and connected control devices.

Baud Rate: Set this switch to match the baud rate of the device connected to the RS-232 port.

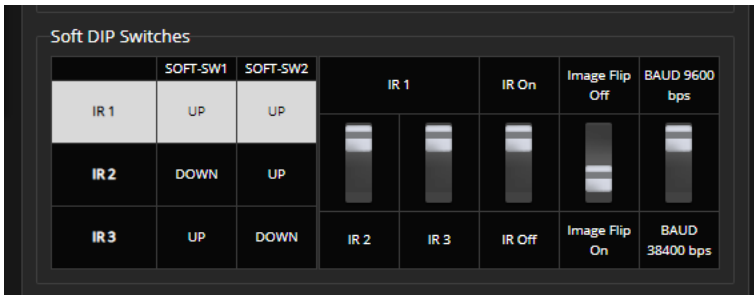

Software-Controlled Video Output Resolution Setting

RoboSHOT 12E CAT-5 and RoboSHOT 30E CAT-5 only: If the camera has been updated to version 3.1.0 firmware or later, Position 0 selects software control. The default resolution is 720p/59.94. This capability is not available in earlier firmware versions or on the older RoboSHOT 12 and RoboSHOT 30 cameras.

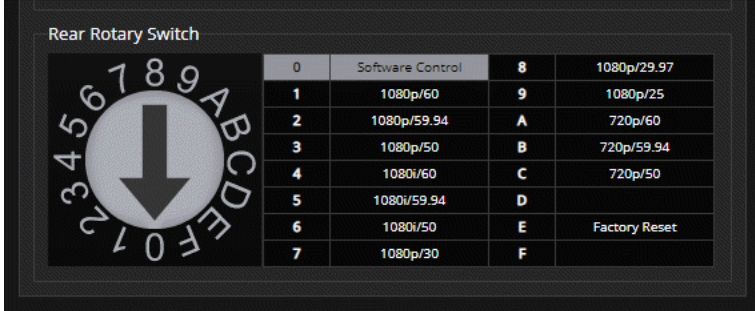

Set the video output resolution on the System page, General tab.

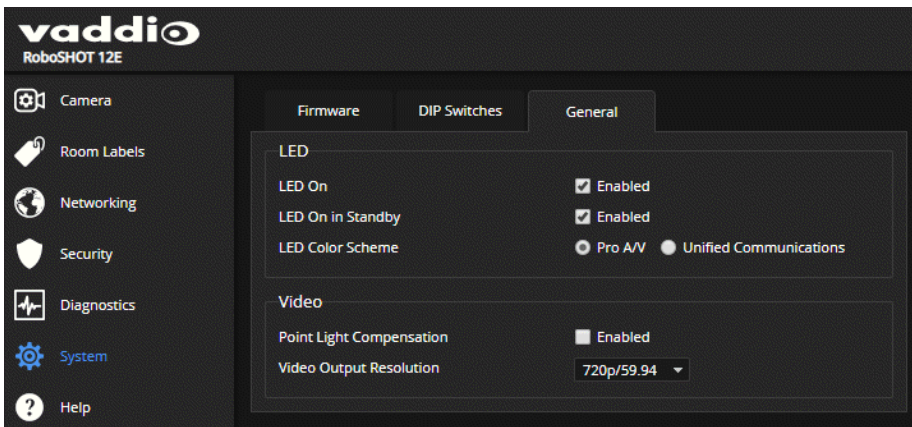

Additional Camera Behavior Settings

SYSTEM PAGE, DIP SWITCHES TAB AND GENERAL TAB

If your camera has not been updated to version 3.1.x, additional features are available on the upper row of soft DIP switches. In firmware version 3.1.0 and later, most of these settings are on the General tab.

These settings are the same for all cameras in the RoboSHOT CAT-5 family.

- **LED color scheme** – Status light color codes for Pro AV (broadcast, the default setting) or UC (unified conferencing).
- **LED on/off** – When the LED is set to OFF, it remains off even when the camera is sending video.
- **Standard Control Mode/Codec Control Mode** – Select Codec Control Mode if using the camera with a third-party codec.
- **Enable LED in Standby** – When the LED is enabled in standby mode, it illuminates purple to show that the camera is in standby but connected to power. When the LED is disabled in standby mode, it is only on when the camera is active (sending video or updating firmware).

Pre-3.1.0 firmware:

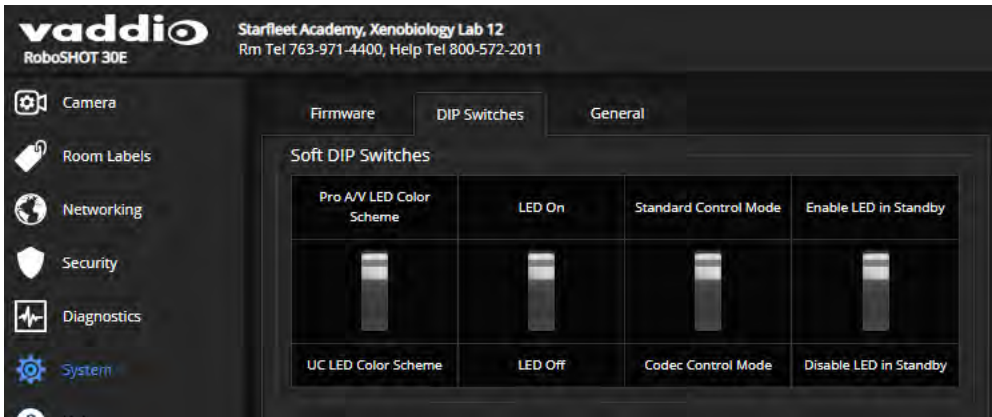

Version 3.1.0 and later firmware:

Note

When the camera's rotary switch is at position 0, you can set video output resolution from this page. This capability is not available when the switch is in any other position.

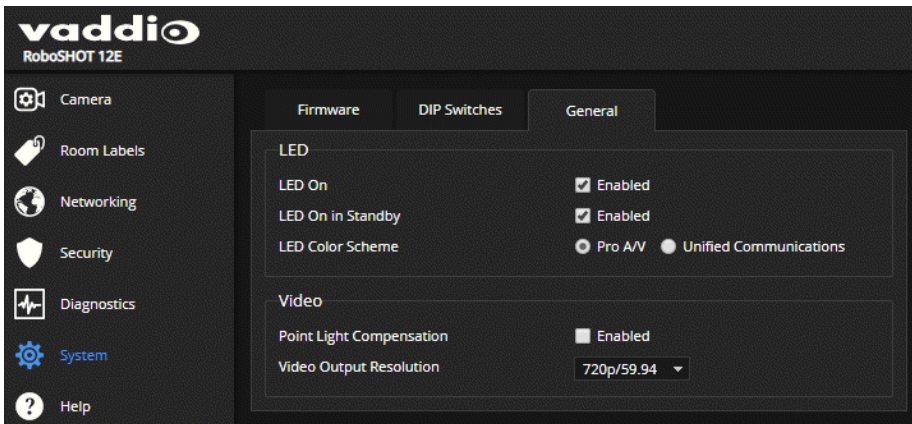

Configuring Streaming (Quick-Connect USB or Quick-Connect USB Mini)

STREAMING PAGE, QUICK-CONNECT WEB INTERFACE

The Quick-Connect USB and Quick-Connect USB Mini devices provide streaming capability for RoboSHOT cameras.

- Quick-Connect USB Mini: USB 2.0 streaming only
- Quick-Connect USB: USB 2.0 or IP (H.264) streaming; configurable

The Quick-Connect USB defaults to USB 2.0 streaming.

Most aspects of USB streaming are negotiated automatically between the Quick-Connect device and the conferencing application, and in many cases no configuration is needed for either USB or IP streaming.

To select the streaming mode (Quick-Connect USB only):

Select the desired streaming mode if necessary. USB streaming is the default. The settings for the selected streaming mode are highlighted.

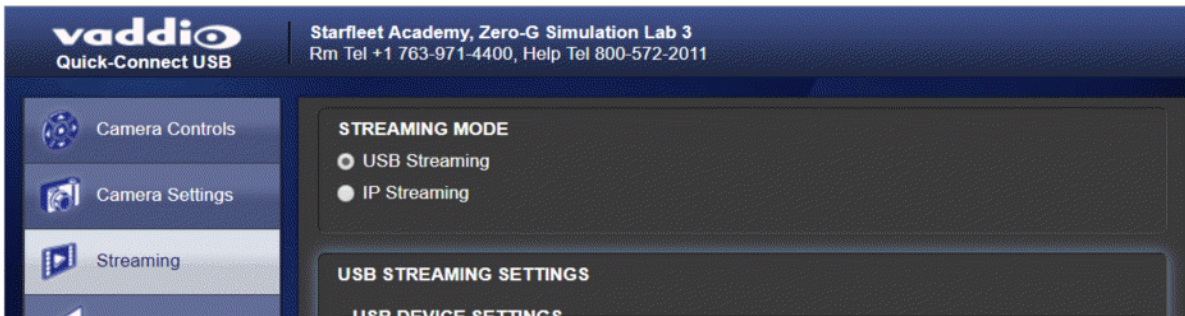

To configure USB streaming (Quick-Connect USB or Quick-Connect USB Mini):

If desired, give the Quick-Connect device a device name that helps people to identify and select it when setting up their laptops for conferencing.

In most cases you do not need to set the color space; this is automatically negotiated with the conferencing application.



To configure IP streaming (Quick-Connect USB only):

1. Select the desired video resolution. This cannot be higher than the video resolution set on the camera. Video resolution determines the size of the media player window displaying the stream on people's computers.

2. Select the video quality. This determines how much bandwidth the stream uses.

Pro tip

A higher bandwidth setting provides better video if the network can support it, but can result in poor-quality video if the network has bandwidth limitations. A high video resolution setting combined with a high quality (bandwidth) setting requires the most network bandwidth. If the network cannot easily support this, video errors will be more likely and more obvious than at lower quality and/or resolution settings.

3. Select the streaming protocol if necessary. RTSP on port 554 is the default; the port number can be changed. *Do not change the port number unless your IT staff directs you to do so.* HLS is available for streaming to Apple iOS devices. HLS streaming is always on port 80.
4. Optional: Change the streaming URL path to help people identify the URL in their media player's list of recent streams.
5. Save the changes you make on this page.

IPv4 4.2.0

IP STREAMING SETTINGS

VIDEO SETTINGS

Video Resolution: 720p

Video Quality: High Quality (Best)

PROTOCOL

HLS HLS Port: 80

RTSP RTSP Port: 554

STREAMING URL

Path: exec-conf-rm-stream

URL: rtsp://10.30.240.197:554/exec-conf-rm-stream

Cancel Save

Managing Lighting and Color Adjustments with the Universal CCU

RoboSHOT cameras offer lighting and color adjustments through the web interface; the Universal CCU provides direct access to these adjustments at any time.

A Quick Look at the Menu Controls

- **Scenes buttons** – Press to select one of the camera's three custom scenes when Scene Config is selected.
- **Function buttons** – Press to select an item to change while you are on the home menu.
- **Menu knob** – Navigation and adjustment modes. Not used for navigating to items on the home menu.
- **Select button** – Press to change the menu knob from navigation to adjustment.
- **Cancel button** – Press to change the menu knob from adjustment to navigation. This does not cancel or undo the current adjustment.



The items on the home menu correspond to the function buttons to the left of the menu knob.

To work with an item on the home menu:

1. Press the front panel button corresponding to the menu item. (On some older units, the Bright button is labeled Pedestal or Ped.)
2. Turn the menu knob to adjust the selected item.

Exceptions:

- When the W Bal Auto button is illuminated, automatic white balance is selected and the Red and Blue settings cannot be adjusted. Press the W Bal Auto button to deselect automatic white balance.
- When the Iris Auto button is illuminated, Auto Iris is selected and the Iris and Gain settings cannot be adjusted. Press the Iris Manual button to deselect Auto Iris.

CAT-5 CCU		ROBOSHOT 30	
RED	AUTO	GAMMA	-4
BLUE	AUTO	DETAIL	8
CHROMA	5	IRIS	AUTO
BRIGHT	---	GAIN	AUTO

3. When the item is adjusted properly, do one of these things:
 - Press another button to select a different menu item.
 - Press the Cancel button to put the menu knob back into navigation mode. This will not set the menu item back to its previous value.
 - Do nothing. After a few seconds, the display blinks once to indicate that the Menu knob has returned to navigation mode.

To work with items on other menus:

1. Turn the knob to navigate from the home menu to the item you need to change. The @ symbol indicates the menu item to which you have navigated.
2. Press the Select button to change the menu knob to adjustment mode. The @ symbol changes to a > symbol.
3. Turn the menu knob to adjust the selected item.
4. When the item is adjusted properly, do one of these things:
 - o Press the Cancel button to put the menu knob back into navigation mode. This will not set the menu item back to its previous value.
 - o Do nothing. After a few seconds, the display blinks once to indicate that the Menu knob has returned to navigation mode.

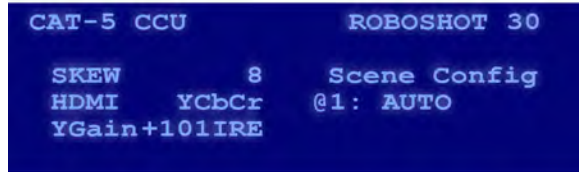

Available adjustments include:

- **Shutter** – Set the shutter speed. Range is 1 to 10000. This cannot be adjusted when Iris is in auto mode.
- **NR** (Noise Reduction) – Range is 0 through 5.
- **Wide Dynamic Range** (WDR) – On or Off. This cannot be enabled when Iris is in manual mode, nor can it be enabled when Backlight Compensation is enabled. The next three items are WDR adjustments.
 - o **Display Brightness Level** – Range is 0 (dark) through 6 (bright).
 - o **Brightness Compensation** – Range is 0 (dark) through 3 (bright).
 - o **Compensation Level** – Range is 0 (low) through 2 (high).
- **Skew** – If the cables from the Universal CCU to the camera are not all the same length, video quality may be reduced. Change the skew setting to compensate for the difference in cable length. The optimum setting is usually in the middle of the range of skew values which pass acceptable video. Range is 1 through 16.
- **HDMI** – Set the HDMI color space. Default is YCrCb; sRGB is also available.
- **Y-Gain** – Adjust the video ± 10 IRE at all outputs as needed for associated video equipment.
- **Scene Config** – Navigate through the six factory-defined CCU scenes, or press one of the three Scenes buttons to select a custom scene. If the selected custom scene has not been defined on the camera, the Universal CCU presents a message saying there is no such scene, and reverts to the default scene (Auto).

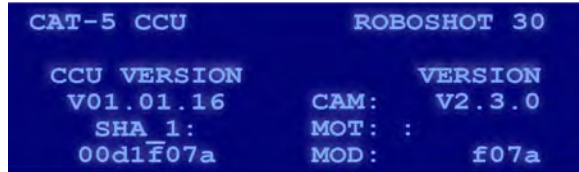

Adjusting Color

The [Color Adjustment Cheat Sheet](#) provides information on correcting specific issues.

To calibrate the camera and use the automated capabilities:

1. Ensure that Auto White Balance (the AUTO button under W BAL) is off.
2. Zoom in on a white object, such as a sheet of paper. At least 60% of the image area must be white for the calibration to work properly.
3. Press OPWB. When the Universal CCU completes the calibration and color balance adjustment, the reference object appears white in the image.
4. After the calibration and adjustment is complete, press the Auto White Balance button.

To adjust color manually:

1. Adjust the Chroma level to taste, so the colors are neither too intense nor too gray.
2. Adjust the red and blue levels. Adjusting for skin tones or using a color chart is an easy way to find a good baseline setup.

Setting the Default Lighting Adjustments

The [Lighting and Image Quality Cheat Sheet](#) provides information on correcting specific issues.

The Universal CCU includes six predefined lighting scenes to use as starting-points for fine-tuning:

- AUTO – automatic lighting management
- Incand Lo – incandescent, low intensity
- Incand Hi – incandescent, bright
- Fluor Lo – fluorescent, low intensity
- Fluor Hi – fluorescent, bright
- Outdoor – daylight

To specify a stored scene to use on power-up:

1. Open the Cat-5 Adjustments menu on the display panel.

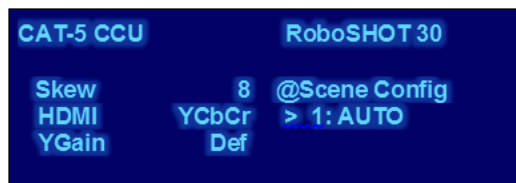

2. Select the scene that best fits the lighting needs:
3. Press the SELECT button to save your change.

Adjusting Light Level and Detail

1. Press the MANUAL button under IRIS to disable Auto Iris.
2. Dial the Iris to the largest aperture (lowest 'f' number).
3. Press GAIN and dial it down until the image is too dark. Then bring it back up until it is properly exposed.
4. Exposures that require high gain settings will have a grainy video image. Press DETAIL and adjust the detail setting for a smoother image.

Working with Custom Scenes

You can store up to three customized sets of lighting and color adjustments (CCU scenes) so you can use them whenever you need them.

To store a scene:

1. Adjust color, lighting, and detail as needed.
2. Decide which scene to assign as the current set of adjustments - A, B, or C.
3. Press and hold the appropriate scene button until it blinks.

To select a stored scene:

Press the appropriate SCENES button – A, B, or C. The button illuminates to show that the scene is in use.

To delete a stored scene:

Press and hold the appropriate scene button (A, B, or C) while pressing the Cancel button.

Adjusting for Cable Length

Long runs of cable from the Universal CCU to the camera can result in poor signal quality. If the video quality is higher when you connect the camera to the Universal CCU with short cables, the skew adjustment may help.

1. Open the Cat-5 Adjustments menu.
2. Select Skew.
3. Change the value as needed to produce the best video output from the Universal CCU. Available values range from 1 to 16; higher values correct for longer cable lengths.
4. Press the SELECT button to save the change.

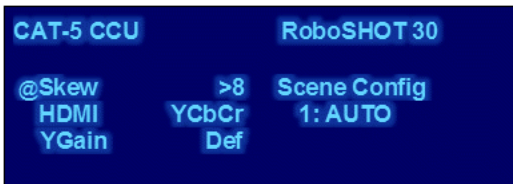

Pro Tip

For the best adjustment, start at the lowest skew value and increase to the first value that produces a visible improvement. Note the value, and increase the skew until the video begins to look worse. Choose a value about halfway between those two values.

If the skew value is too high, the video may drop.

Adjusting the Front Panel Display

Depending on the lighting conditions where the Universal CCU is installed, you may choose to adjust the front panel display.

The display menu is only available when DIP switch 5 is up.

Note

Disconnect power before changing the position of the DIP switch.

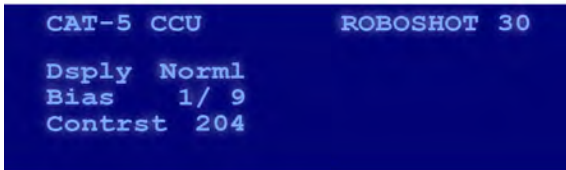

To adjust the display:

1. Navigate to the display menu, which is after the version information.
2. Work with the settings in the same way you work with the other items that are not on the home menu.

Available settings are:

- **Display** – Normal (light text on dark background) or Invert (dark text on light background).
- **Bias** – Changes the overall brightness. Range is 1/9 (bright) to 1/11 (dim).
- **Contrast** – Changes the brightness of the background; settings below about 195 also dim the text. Range is 180 to 230.

Note

The display menu does not time out and return you to the home menu.

Operating the Camera from the Web Interface

CONTROLS PAGE

The Controls page does not require administrative access. If guest access is enabled, you do not need to log in to access this page. If guest access is disabled, you will need to log in as `user`.

The Controls page provides most of the same controls as the IR Remote Commander. See [Using the IR Remote](#).

- Move to camera presets, if any have been stored
- Pan, tilt, zoom, or return it to its home position
- Put the camera in standby or bring it back to the ready state
- Select a custom lighting adjustment, if any have been stored

Since the web interface is specific to the camera you are working with, it does not offer camera selection.

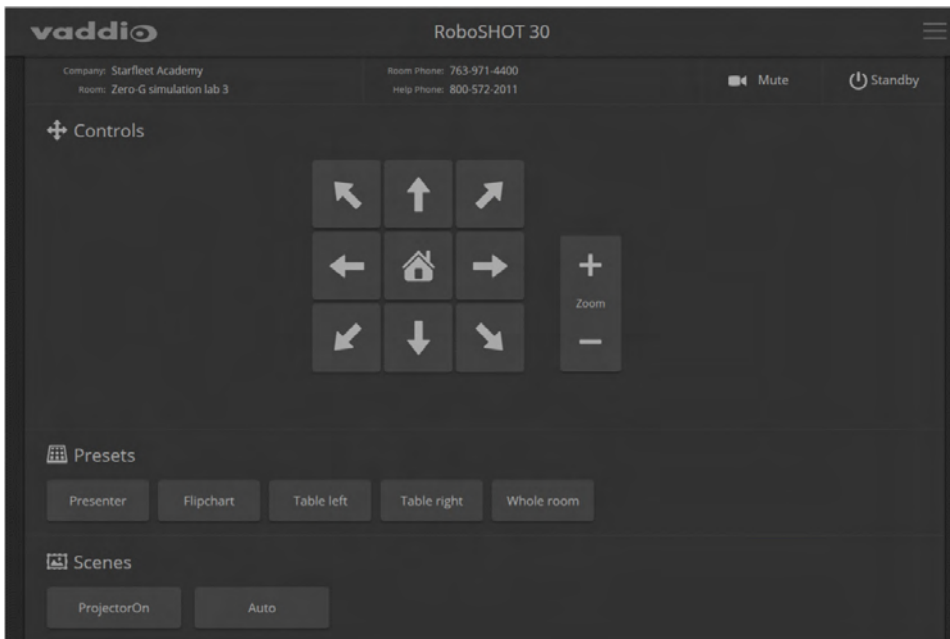

Switching the Camera Off or On (Standby)

Use the Standby button to switch between low-power (standby) and ready states. On entering standby mode, the camera moves to its standby position and stops sending video.

Stop or Resume Sending Video (Mute)

Use the Mute button to stop sending live video without putting the camera in standby mode. When the video is muted, the camera sends a blue or black screen. If the camera is part of a conferencing system, this does not mute the audio.

Moving the Camera

Use the arrow buttons for camera pan and tilt. The center button moves the camera to the home position.

Zooming In or Out

Use the Zoom + button to zoom in and the Zoom - button to zoom out.



Moving the Camera to a Preset Position

Presets are camera shots that have been stored. They include pan, tilt, and zoom information, and may include color and speed information as well. If no presets are defined, the Controls page does not present the Presets section.

Use the Preset buttons to move the camera to any of its preset positions.

Adjusting the Color and Lighting

If any color and lighting adjustments (CCU scenes) have been saved, they are available in the Scenes area, along with the Auto setting. In most cases, the Auto setting is appropriate. This setting allows the camera to adjust to current conditions automatically.

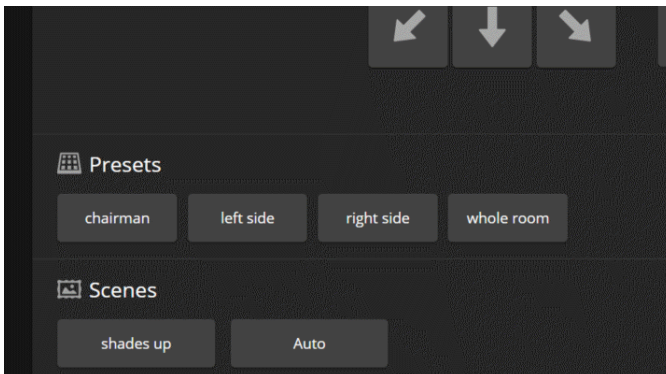

Telnet Command Reference

Vaddio's Telnet command protocol allows external devices to control the camera. Network connectivity and a Telnet client are required; Telnet port 23 is used. Telnet sessions require the administrator account login.

In addition to the camera control commands, Telnet session management commands are available – help, history, and exit.

Note

If an AV Bridge MATRIX PRO is used, the Telnet session is with the AV Bridge MATRIX PRO, not the camera. The camera commands specify camera 1, camera 2, or camera 3, but are otherwise identical to the camera commands in this manual. Refer to the Telnet command information in the AV Bridge MATRIX PRO manual for more detailed information.

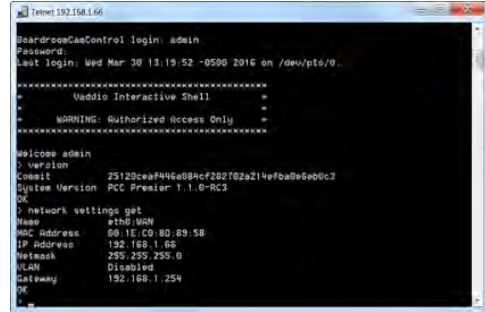

Things to know about Telnet:

- The > character is the command prompt.
- Using a question mark as a command parameter will bring up a list of available subcommands or parameters. Example:

```

camera focus ?
camera focus
near      Focus the camera near
far       Focus the camera far
stop     Stop the camera focus
mode     Camera focus mode
    
```

- CTRL-5 clears the current serial buffer on the device.

Typographical conventions used in this manual:

- { x | y | z } – Choose x, y, or z. Example: camera led { on | off | toggle }
- <variable> – Substitute the desired value here. Example: camera ccu get <param>
- < x - y > – Valid range of values is from x through y. Example: camera ccu set detail <0 -15>
- [parameter] – Parameter is not required. Example: camera pan left [<speed>]

camera home

Moves the camera to its home position.

RoboSHOT AVBMP only: Specify `camera1`, `camera2`, or `camera3`.

Synopsis	<code>camera home</code>
Example	<pre>>camera home OK ></pre>

camera pan

Moves the camera horizontally.

RoboSHOT AVBMP only: Specify `camera1`, `camera2`, or `camera3`.

Synopsis	<code>camera pan { left [<speed>] right [<speed>] stop get set }</code>	
Options	<code>left</code>	Moves the camera left.
	<code>right</code>	Moves the camera right.
	<code>speed <1 – 24></code>	Optional: Specifies the pan speed as an integer (1 to 24). Default speed is 12.
	<code>stop</code>	Stops the camera's horizontal movement.
	<code>get</code>	Returns the camera's absolute pan position in degrees, as a floating point value between approximately -150.00 (left) and 150.00 (right).
	<code>set <position></code>	Sets the camera's absolute pan position in degrees, as a floating point value between approximately -150.00 and 150.00. This is the minimum range. Individual cameras may have an additional degree or two of travel before they reach their physical limits. If the value is out of range, the camera returns an error message and no motion occurs.
Examples	<pre>>camera pan left OK ></pre> <p>Pans the camera left at the default speed.</p> <pre>>camera pan right 20 OK ></pre> <p>Pans the camera right using a speed of 20.</p> <pre>>camera pan stop OK ></pre> <p>Stops the camera's horizontal motion.</p>	

camera tilt

Moves the camera vertically.

RoboSHOT AVBMP only: Specify `camera1`, `camera2`, or `camera3`.

Synopsis	<code>camera tilt{ up [<speed>] down [<speed>] stop get set}</code>	
Options	<code>up</code>	Moves the camera up.
	<code>down</code>	Moves the camera down.
	<code>speed <1 – 20></code>	Optional: Specifies the tilt speed as an integer (1 to 20). Default speed is 10.
	<code>stop</code>	Stops the camera's vertical movement.
	<code>get</code>	Returns the camera's absolute tilt position in degrees, as a floating point value between approximately -30.00 (down) and 90.00 (up). Note that the range is roughly 30.00 to -90.00 if Image Flip is selected.
	<code>set <position></code>	Sets the camera's absolute tilt position in degrees, as a floating point value between approximately -30.00 and 90.00 (-90 to 30 if the camera is configured for inverted operation). This is the minimum range; individual cameras may have an additional degree or two of travel before they reach their physical limits. If the value is out of range, the camera returns an error message and no motion occurs.
Examples	<pre>>camera tilt up OK > Tilts the camera up at the default speed. >camera tilt down 20 OK > Tilts the camera down using a speed of 20. >camera tilt stop OK > Stops the camera's vertical motion.</pre>	

camera zoom

Zooms the camera in toward the subject or out away from the subject.

RoboSHOT AVBMP only: Specify `camera1`, `camera2`, or `camera3`.

Synopsis	camera zoom { in [<speed>] out [<speed>] stop get set}	
Options	in	Moves the camera in.
	out	Moves the camera out.
	speed [1 – 7]	Optional: Specifies the zoom speed as an integer (1 to 7). Default speed is 3.
	stop	Stops the camera's zoom movement.
	get	Returns the camera's current zoom level as a floating point value.
	set <1 – n>	Sets the zoom level as a floating point value. The value of n (maximum zoom) depends on the camera's capabilities. For example, the range is 1.00 to 12.00 for a 12x camera. If the value is out of range, the camera returns an error message and no zoom change occurs.
Examples	<pre>>camera zoom in OK > Zooms the camera in at the default speed. >camera zoom out 7 OK > Zooms the camera out using a speed of 7. >camera zoom stop OK > Stops the camera's zoom motion. >camera zoom set 14 OK > Sets the camera's zoom level to 14x. >camera zoom get 14 OK > Returns the camera's current zoom level.</pre>	

camera focus

Changes the camera focus.

RoboSHOT AVBMP only: Specify `camera1`, `camera2`, or `camera3`.

Synopsis	<code>camera focus { near [<speed>] far [<speed> stop mode {get auto manual}}</code>	
Options	<code>near</code>	Brings the focus nearer to the camera. Can only be used when camera is in manual mode.
	<code>far</code>	Moves the focus farther from the camera. Can only be used when camera is in manual mode.
	<code>speed <1 – 8></code>	Optional: integer (1 to 8) specifies the focus speed.
	<code>stop</code>	Stops the camera's focus movement.
	<code>mode {get auto manual}</code>	Returns the current focus mode, or specifies automatic or manual focus.
Examples	<pre>camera focus near OK ></pre> <p>Brings the focus near at the default speed.</p> <pre>camera focus far 7 OK ></pre> <p>Moves the focus farther from the camera at a speed of 7.</p> <pre>camera focus mode get auto_focus: on OK ></pre> <p>Returns the current focus mode.</p>	



camera preset

Moves the camera to the specified preset, or stores the current camera position and optionally CCU information, either with or without specifying that Tri-Synchronous Motion is to be used when moving to this position.

RoboSHOT AVBMP only: Specify `camera1`, `camera2`, or `camera3`.

Note

This command corresponds to the CAM_Memory commands in the RS-232 command set.

Synopsis	camera preset { recall store} <1 – 16> [tri-sync <1 – 24>] [save-ccu]	
Options	recall <1 – 16>	Moves the camera to the specified preset, using Tri-Synchronous Motion if this was saved with the preset. If CCU information was saved with the preset, the camera switches to the CCU setting associated with the preset.
	store <1 – 16>	Stores the current camera position as the specified preset.
	tri-sync <1 – 24>	Optional: Specifies that the camera uses Tri-Synchronous Motion to move to this position, using the specified speed.
	save-ccu	Optional: Saves the current CCU settings as part of the preset. If not specified, the last color settings are used when recalled.
Examples	<pre>>camera preset recall 3 OK ></pre> <p>Moves the camera to preset 3.</p> <pre>>camera preset store 1 OK ></pre> <p>Saves the camera's current position as preset 1.</p> <pre>>camera preset store 4 tri-sync 15 OK ></pre> <p>Stores the camera's current position as preset 4. The camera will use Tri-Synchronous Motion at speed 15 when it is recalled to this preset.</p> <pre>>camera preset store 2 save-ccu OK ></pre> <p>Stores the camera's current position as preset 2. The camera applies the current CCU settings when it is recalled to this preset.</p>	

camera ccu get

Returns CCU (lighting and color) information.

RoboSHOT AVBMP only: Specify `camera1`, `camera2`, or `camera3`.

Synopsis	<code>camera ccu get <param></code>	
	all	Returns all current CCU settings.
	auto_white_balance	Returns the current state of the auto white balance setting (on or off).
	red_gain	Returns red gain as an integer (0 to 255).
	blue_gain	Returns blue gain as an integer (0 to 255).
	backlight_compensation	Returns the current state for backlight compensation (on or off).
	auto_iris	Returns the current auto-iris state (on or off).
	iris	Returns the iris value as an integer (0 to 11).
	gain	Returns gain as an integer (0 to 11).
	detail	Returns detail as an integer (0 to 15).
	chroma	Returns chroma as an integer (0 to 14).
	wide_dynamic_range	Returns the current state for Wide Dynamic Range (on or off).
Examples	<pre>>camera ccu get iris iris 6 OK ></pre> <p>Returns the current iris value.</p> <pre>>camera ccu get red_gain red_gain 201 OK ></pre> <p>Returns the current red gain value.</p> <pre>>camera ccu get all auto_iris on auto_white_balance on backlight_compensation off blue_gain 193 chroma 2 detail 8 gain 3 iris 11 red_gain 201 wide_dynamic_range off OK ></pre> <p>Returns all current CCU settings.</p>	

camera ccu set

Sets the specified CCU (lighting and color) information.

RoboSHOT AVBMP only: Specify `camera1`, `camera2`, or `camera3`.

Synopsis	<code>camera ccu set <param> <value></code>	
<p>Options</p> 	<code>auto_white_balance {on off}</code>	Sets the current state of the auto white balance setting (on or off). Auto white balance overrides red gain and blue gain manual settings.
	<code>red_gain <0 – 255></code>	Sets the red gain value as an integer (0 to 255). Can only be used when auto white balance is off.
	<code>blue_gain <0 – 255></code>	Sets the blue gain value as an integer (0 to 255). Can only be used when auto white balance is off.
	<code>backlight_compensation {on off}</code>	Sets the current state of the backlight compensation setting (on or off). Can only be used when wide dynamic range mode is off.
	<code>iris <0 – 11></code>	Sets the iris value as an integer (0 to 11). Can only be used when auto-iris is off.
	<code>auto_iris {on off}</code>	Sets the auto-iris state (on or off). Auto-iris disables manual iris and gain when it is on.
	<code>gain <0 – 11></code>	Sets gain value as an integer (0 to 11). Can only be used when auto-iris is off.
	<code>detail <0 – 15></code>	Sets the detail value as an integer (0 to 15).
	<code>chroma <0 – 14></code>	Sets the chroma value as an integer (0 to 14).
	<code>wide_dynamic_range {on off}</code>	Sets Wide Dynamic Range mode on or off. Can only be used when backlight compensation is off.
Examples	<pre>>camera ccu set auto_iris off OK > Turns off auto-iris mode, returning the camera to manual iris control. >camera ccu set red_gain 10 OK > Sets the red gain value to 10.</pre>	

camera ccu scene

Stores the current CCU scene or recalls the specified ccu scene.

RoboSHOT AVBMP only: Specify `camera1`, `camera2`, or `camera3`.

Synopsis	<code>camera ccu scene {recall {factory <1 – 6> custom <1 – 3>} store custom <1 – 3>}</code>	
Options	<code>recall factory <1 – 6></code>	Recalls the camera to the specified scene (factory 1 to 6 or custom 1 to 3) .
	<code>recall custom <1 – 3></code>	Saves the current scene as the specified custom scene.
Examples	<pre>>camera ccu scene recall factory 2 OK > Sets the camera to use factory CCU scene 2. >camera ccu scene store custom 1 OK > Saves the current CCU scene as custom CCU scene 1.</pre>	

camera led

Set or change the behavior of the indicator light.

RoboSHOT AVBMP only: Specify `camera1`, `camera2`, or `camera3`.

Synopsis	<code>camera led { get off on }</code>	
Options	<code>get</code>	Returns the indicator light's current state (on or off).
	<code>off</code>	Disables the indicator light.
	<code>on</code>	Enables the indicator light.
Examples	<pre>>camera led off OK > Disables the indicator light. You cannot tell by looking at the camera whether it is sending video. >camera led get led: on OK > Returns the current state of the indicator light.</pre>	

camera standby

Set or change camera standby status.

RoboSHOT AVBMP only: Specify `camera1`, `camera2`, or `camera3`.

Synopsis	<code>camera standby { get off on toggle }</code>	
Options	<code>get</code>	Returns the camera's current standby state.
	<code>off</code>	Brings the camera out of standby (low power) mode.
	<code>on</code>	Stops video and puts the camera in standby mode.
	<code>toggle</code>	Changes the camera's standby state – if it was not in standby mode, it enters standby; if it was in standby mode, it "wakes up."
Examples	 <pre>>camera standby off OK > Brings the camera out of standby mode. >camera standby get standby: on OK > Returns the current standby state.</pre>	

network settings get

Returns the current network settings for MAC address, IP address, subnet mask, and gateway.

Synopsis	<code>network settings get</code>	
Example	<pre>> network settings get Name eth0:WAN MAC Address 48:6F:77:64:79:21 IP Address 192.168.1.67 Netmask 255.255.255.0 VLAN Disabled Gateway 192.168.1.254 OK ></pre>	

network ping

Sends an ICMP ECHO_REQUEST to the specified IP address or hostname.

Synopsis	network ping [count <count>] [size <size>] <string>	
Options	<count>	The number of ECHO_REQUEST packets to send. Default is five packets.
	<size>	The size of each ECHO_REQUEST packet. Default is 56 bytes.
	<string>	The hostname or IP address where the ECHO_REQUEST packets will be sent.
Examples	<pre>>network ping 192.168.1.66 PING 192.168.1.66 (192.168.1.66): 56 data bytes 64 bytes from 192.168.1.66: seq=0 ttl=64 time=0.476 ms 64 bytes from 192.168.1.66: seq=1 ttl=64 time=0.416 ms 64 bytes from 192.168.1.66: seq=2 ttl=64 time=0.410 ms 64 bytes from 192.168.1.66: seq=3 ttl=64 time=0.410 ms 64 bytes from 192.168.1.66: seq=4 ttl=64 time=3.112 ms --- 192.168.1.66 ping statistics --- 5 packets transmitted, 5 packets received, 0% packet loss round-trip min/avg/max = 0.410/0.964/3.112 ms ></pre> <p>Sends five ECHO_REQUEST packets of 56 bytes each to the host at 192.168.1.66.</p>	
	<pre>>network ping count 10 size 100 192.168.1.1</pre> <p>Sends 10 ECHO_REQUEST packets of 100 bytes each to the host at 192.168.1.1. The command returns data in the same form as above.</p>	

system reboot

Reboots the system either immediately or after the specified delay. Note that a reboot is required when resetting the system to factory defaults (system factory-reset).

Synopsis	system reboot [<seconds>]	
Options	<seconds>	The number of seconds to delay the reboot.
Examples	<pre>>system reboot OK ></pre> <p>The system is going down for reboot NOW! roboshot-48-6F-77-64-79-21</p> <p>Reboots the system immediately.</p>	
	<pre>>system reboot 30</pre> <p>Reboots the system in 30 seconds. The response is in the same form; the system message appears at the end of the delay.</p>	

system factory-reset

Gets or sets the factory reset status. When the factory reset status is on, the system resets to factory defaults on reboot.

Synopsis	system factory-reset { get on off }	
Options	get	Returns the camera's current factory reset status.
	on	Enables factory reset on reboot.
	off	Disables factory reset on reboot.
Examples	<pre>>system factory-reset get factory-reset (software): off factory-reset (hardware): off OK ></pre> <p>Returns the factory reset status.</p> <p>This evaluates the most recent <code>system factory-reset on</code> or <code>off</code> command, if one has been received, then reads the rear panel DIP switches and returns the status <code>on</code> if they are all in the down position.</p> <pre>>system factory-reset on factory-reset (software): on factory-reset (hardware): off OK ></pre> <p>Enables factory reset upon reboot.</p> <p>Note <i>This command does not initiate a factory reset. The factory reset takes place on the next reboot.</i></p>	

version

Returns the current firmware version.

Synopsis	version
Example	<pre>> version Commit d033ddb2378357a871011eb820706dcaa64ec0e2 Pan Motor Version 0.2.4772 Sensor Version 02.00 System Version RoboSHOT 2.3.0 Tilt Motor Version 0.2.4772 OK</pre> <p>Returns current firmware version information. Your camera may return slightly different information.</p>

history

Returns the most recently issued commands from the current Telnet session. Since many of the programs read user input a line at a time, the command history is used to keep track of these lines and recall historic information.

Synopsis	history <limit>	
Options	<limit>	Integer value specifying the maximum number of commands to return.
Examples	<p>history Displays the current command buffer.</p> <p>history 5 Sets the history command buffer to remember the last 5 unique entries.</p>	
Additional information	<p>You can navigate the command history using the up and down arrow keys.</p> <p>This command supports the expansion functionality from which previous commands can be recalled from within a single session. History expansion is performed immediately after a complete line is read.</p> <p>Examples of history expansion:</p> <ul style="list-style-type: none"> * !! Substitute the last command line. * !4 Substitute the 4th command line (absolute as per 'history' command) * !-3 Substitute the command line entered 3 lines before (relative) 	



help

Displays an overview of the CLI syntax.

Synopsis	help
Example	<p>help</p>

exit

Ends the command session and then closes the socket.

Synopsis	exit
Example	exit

RS-232 Serial Command Reference

The Vaddio RS-232 Serial Control Protocol is similar to the Sony® VISCA command set in order to be compatible with several popular control devices. Not all VISCA commands are supported, and there are Vaddio-specific commands in the following command and inquiry lists.

Be sure the camera is set to the same baud rate as the controller or other device originating the commands. For the older RoboSHOT cameras, see [DIP Switches: Camera Behavior Settings](#). For the newer RoboSHOT 12E CAT-5 and RoboSHOT 30E CAT-5 cameras, see [Basic Camera Settings for RoboSHOT 12E CAT-5 and RoboSHOT 30E CAT-5](#).

Camera Movement, Zoom, and Focus Commands

Command Set	Command	Command Packet	Comments
CAM_Zoom	Stop	8x 01 04 07 00 FF	Variable speed: p = 0 (low) to 7 (high) Direct: pqrs = zoom position (0h-4000h for 12x, 0h-7AC0h for 30x)
	Tele (std)	8x 01 04 07 02 FF	
	Wide (std)	8x 01 04 07 03 FF	
	Tele (variable)	8x 01 04 07 2p FF	
	Wide (variable)	8x 01 04 07 3p FF	
	Direct	8x 01 04 47 0p 0q 0r 0s FF	
Corresponds to <code>camera zoom</code> in Telnet API			
CAM_Focus	Stop	8x 01 04 08 00 FF	Variable speed: p = 0 (low) to 7 (high) Direct and Near Limit: pqrs = focus position (1000h – F000h)
	Far (std)	8x 01 04 08 02 FF	
	Near (std)	8x 01 04 08 03 FF	
	Far (variable)	8x 01 04 08 2p FF	
	Near (variable)	8x 01 04 08 3p FF	
	Direct	8x 01 04 48 0p 0q 0r 0s FF	
	One Push Trigger	8x 01 04 18 01 FF	
	Near Limit	8x 01 04 28 0p 0q 0r 0s FF	
Corresponds to <code>camera focus</code> in Telnet API			
CAM_Focus Mode	Auto Focus	8x 01 04 38 02 FF	
	Manual Focus	8x 01 04 38 03 FF	
	Auto/Manual	8x 01 04 08 10 FF	

Command Set	Command	Command Packet	Comments
Pan-TiltDrive	Up	8x 01 06 01 vv ww 03 01 FF	vv= Pan speed (01h-18h) ww=Tilt speed (01h-14h)
	Down	8x 01 06 01 vv ww 03 02 FF	
	Left	8x 01 06 01 vv ww 01 03 FF	
	Right	8x 01 06 01 vv ww 02 03 FF	
	UpLeft	8x 01 06 01 vv ww 01 01 FF	
	UpRight	8x 01 06 01 vv ww 02 01 FF	
	DownLeft	8x 01 06 01 vv ww 01 02 FF	
	DownRight	8x 01 06 01 vv ww 02 02 FF	
	Stop	8x 01 06 01 vv ww 03 03 FF	
	Home	8x 01 06 04 FF	Returns the camera to its default position
Pan-TiltDrive	Absolute Position	8x 01 06 02 vv ww 0Y 0Y 0Y 0Y 0Z 0Z 0Z 0Z FF	0Y0Y0Y0Y = Pan position (90E2h-6BD8h) 0Z0Z0Z0Z = Tilt position (EB99h-3D59h)
Pan-Tilt-ZoomDrive	Up	8x 01 06 0A vv ww rr 03 01 03 FF	vv= Pan speed (01h-18h) ww=Tilt speed (01h-14h) rr=Zoom speed (00h - 07h)
	Down	8x 01 06 0A vv ww rr 03 02 03 FF	
	Left	8x 01 06 0A vv ww rr 01 03 03 FF	
	Right	8x 01 06 0A vv ww rr 02 03 03 FF	
	In	8x 01 06 0A vv ww rr 03 03 01 FF	
	Out	8x 01 06 0A vv ww rr 03 03 02 FF	
	Stop	8x 01 06 0A vv ww rr 03 03 03 FF	
	Home	8x 01 06 0C FF	Returns the camera to the default position and zoom
Pan-Tilt-ZoomDrive	Absolute Position	8x 01 06 0B vv ww 0Y 0Y 0Y 0Y 0Z 0Z 0Z 0Z 0R 0R 0R 0R FF	0Y0Y0Y0Y = Pan position (90E2h-6BD8h) 0Z0Z0Z0Z = Tilt position (EB99h-3D59h) 0R0R0R0R = Zoom position (0h-4000h for 12x, 0h-7AC0h for 30x)

Command Set	Command	Command Packet	Comments
CAM_Memory	Reset	8x 01 04 3F 00 0p FF	Corresponds to camera preset in Telnet API. p= preset number(0h-0Fh) qr= Speed(01h-18h)
	Set standard	8x 01 04 3F 01 0p FF	
	Set standard with 'scene'	8x 01 04 3F 21 0p FF	
	Set Tri-sync	8x 01 04 3F 11 0p 0q 0r FF	
	Set Tri-Sync with 'scene'	8x 01 04 3F 31 0p 0q 0r FF	
	Recall	8x 01 04 3F 02 0p FF	
			Corresponds to camera preset in Telnet API.
CAM_PTZ_PresetSpeed		8x 01 7e 01 0b pp qq rr FF	pp: pan speed (01h-18h) qq: tilt speed (01h-14h) rr: zoom speed (0h-07h)

Movement, Zoom, and Focus Inquiry Commands

Inquiry Command	Command	Response Packet	Comments
Pan-TiltPosInq	8x 09 06 12 FF	y0 50 0w 0w 0w 0w 0z 0z 0z 0z FF	www= Pan position zzzz=Tilt Position
CAM_ZoomPosInq	8x 09 04 47 FF	y0 50 0p 0q 0r 0s FF	pqrs: Zoom position
CAM_FocusPosInq	8x 09 04 48 FF	y0 50 0p 0q 0r 0s FF	pqrs: Focus position
CAM_FocusModeInq	8x 09 04 38 FF	y0 50 02 FF	Auto focus
		y0 50 03 FF	Manual focus
			Corresponds to camera focus mode get in Telnet API.
CAM_MemoryInq	8x 09 04 3F FF	y0 50 pp FF	pp: Preset number recalled last (00h - 0Fh)
CAM_MemoryStatusInq	8x 09 04 3F 0p FF	y0 50 0p 0q 0r 0s FF	p: Preset number (00h - 0Fh) q: mode (00-std, 10-std /w ccu, 01-trisync, 11-trisync /w ccu) rs: speed (0x1-0x18) 1 - 24
CAM_MemSaveInq	8x 09 04 23 0X FF	y0 50 0p 0q 0r 0s FF	X: 00h to 0Fh (preset number) pqrs: 0000h to FFFFh (Data)
CAM_PTZ_PresetSpeedInq	8x 09 7E 01 0B FF	y0 50 p q r FF	p:pan speed (01h-18h) q:tilt speed (01h-14h) r:zoom speed (0h-07h)

Color and Light Management Commands

Command Set	Command	Command Packet	Comments
CAM_WB	Auto	8x 01 04 35 00 FF	Normal auto
	Manual	8x 01 04 35 05 FF	Manual control mode
Corresponds to <code>camera ccu set auto_white_balance</code> in Telnet API.			
CAM_RGain	Reset	8x 01 04 03 00 FF	Manual control of red gain pq = red gain (00h – FFh)
	Up	8x 01 04 03 02 FF	
	Down	8x 01 04 03 03 FF	
	Direct	8x 01 04 43 00 00 0p 0q FF	
Corresponds to <code>camera ccu set red_gain</code> in Telnet API.			
CAM_BGain	Reset	8x 01 04 04 00 FF	Manual control of blue gain pq = blue gain (00h – FFh)
	Up	8x 01 04 04 02 FF	
	Down	8x 01 04 04 03 FF	
	Direct	8x 01 04 44 00 00 0p 0q FF	
Corresponds to <code>camera ccu set blue_gain</code> in Telnet API.			
CAM_AE	Auto	8x 01 04 39 00 FF	Auto exposure mode
	Manual	8x 01 04 39 03 FF	Manual control mode
Corresponds to <code>camera ccu set auto_iris</code> in Telnet API.			
CAM_Shutter	Reset	8x 01 04 0A 00 FF	Shutter setting pq = shutter position (00h – 15h) See Shutter Speed Values – CAM_Shutter Command
	Up	8x 01 04 0A 02 FF	
	Down	8x 01 04 0A 03 FF	
	Direct	8x 01 04 4A 00 00 0p 0q FF	
CAM_Iris	Reset	8x 01 04 0B 00 FF	Iris setting pq = iris position (0h, 05h-11h) See Iris Values – CAM_Iris Command
	Up	8x 01 04 0B 02 FF	
	Down	8x 01 04 0B 03 FF	
	Direct	8x 01 04 4B 00 00 0p 0q FF	
Corresponds to <code>camera ccu set iris</code> in Telnet API.			
CAM_Gain	Reset	8x 01 04 0C 00 FF	Iris gain setting pq = gain position (01h – 0Fh) p = gain limit (04h-0Fh) See Iris Gain and Gain Limit Values – CAM_Gain Command
	Up	8x 01 04 0C 02 FF	
	Down	8x 01 04 0C 03 FF	
	Direct	8x 01 04 4C 00 00 0p 0q FF	
	+Gain Limit	8x 01 04 2C 0p FF	
Corresponds to <code>camera ccu set gain</code> in Telnet API.			
CAM_BackLight	On	8x 01 04 33 02 FF	Backlight compensation On/Off
	Off	8x 01 04 33 03 FF	
Corresponds to <code>camera ccu set backlight_compensation</code> in Telnet API.			

Command Set	Command	Command Packet	Comments
CAM_WD	On	8x 01 04 3D 02 FF	Wide Dynamic Range On
	Off	8x 01 04 3D 03 FF	Wide Dynamic Range Off
	Corresponds to <code>camera ccu set wide_dynamic_range</code> in Telnet API. May be unavailable on some cameras.		
CAM_Aperture	Reset	8x 01 04 02 00 FF	Aperture setting pq = aperture position (0h-0fh)
	Up	8x 01 04 02 01 FF	
	Down	8x 01 04 02 02 FF	
	Direct	8x 01 04 42 00 00 0p 0q FF	
	Corresponds to <code>camera ccu set detail</code> in Telnet API.		
CAM_Chroma	Direct	8x 01 7E 55 00 00 0p 0q FF	pq: 00h – 14h
	Corresponds to <code>camera ccu set chroma</code> in Telnet API.		
CAM_GammaOffset	Direct	8x 01 04 1E 00 00 00 0s 0t 0u FF	s: polarity offset (0 is plus, 1 is minus) tu: offset s=0 (00h to 40h) offset s=1 (00h to 10h)
	Corresponds to <code>camera ccu set gamma</code> in Telnet API.		

Shutter Speed Values (CAM_Shutter)

Value	60/59.94/30/29.97 fps	50/25 fps
0x15	1/10000	1/10000
0x14	1/6000	1/6000
0x13	1/4000	1/3500
0x12	1/3000	1/2500
0x11	1/2000	1/1750
0x10	1/1500	1/1250
0x0F	1/1000	1/1000
0x0E	1/725	1/600
0x0D	1/500	1/425
0x0C	1/350	1/300
0x0B	1/250	1/215
0x0A	1/180	1/150
0x09	1/125	1/120
0x08	1/100	1/100
0x07	1/90	1/75
0x06	1/60	1/50
0x05	1/30	1/25
0x04	1/15	1/12
0x03	1/8	1/6
0x02	1/4	1/3
0x01	1/2	1/2
0x00	1/1	1/1

Iris Values (CAM_Iris)

Value	Iris
0x11	F1.6
0x10	F2
0x0F	F2.4
0x0E	F2.8
0x0D	F3.4
0x0C	F4
0x0B	F4.8
0x0A	F5.6
0x09	F6.8
0x08	F8
0x07	F9.6
0x06	F11
0x05	F14
0x00	CLOSED

Iris Gain and Gain Limit Values (CAM_Gain)

Iris Gain			Iris Gain Limit		
Value	Steps	Gain in dB	Value	Steps	Gain in dB
0x0F	28	77.8	0x0F	28	77.8
0x0E	26	44.4	0x0E	26	44.4
0x0D	24	41.0	0x0D	24	41.0
0x0C	22	37.5	0x0C	22	37.5
0x0B	20	34.1	0x0B	20	34.1
0x0A	18	30.7	0x0A	18	30.7
0x09	16	27.3	0x09	16	27.3
0x08	14	23.9	0x08	14	23.9
0x07	12	20.5	0x07	12	20.5
0x06	10	17.1	0x06	10	17.1
0x05	8	13.7	0x05	8	13.7
0x04	6	10.2	0x04	6	10.2
0x03	4	6.8			
0x02	2	3.4			
0x01	0	0			

Color and Light Management Inquiry Commands

Inquiry Command	Command	Response Packet	Comments
CAM_WBModelInq	8x 09 04 35 FF	y0 50 00 FF	Auto
		y0 50 05 FF	Manual
CAM_RGainInq	8x 09 04 43 FF	y0 50 00 00 0p 0q FF	pq: Red gain
CAM_BGainInq	8x 09 04 44 FF	y0 50 00 00 0p 0q FF	pq: Blue gain
CAM_AEModelInq	8x 09 04 39 FF	y0 50 00 FF	Auto
		y0 50 03 FF	Manual
CAM_ShutterPosInq	8x 09 04 4A FF	y0 50 00 00 0p 0q FF	pq: Shutter position
CAM_IrisPosInq	8x 09 04 4B FF	y0 50 00 00 0p 0q FF	pq: Iris position
CAM_GainPosInq	8x 09 04 4C FF	y0 50 00 00 0p 0q FF	pq: Gain position
CAM_WDModelInq	8x 09 04 3D FF	y0 50 02 FF	On
		y0 50 03 FF	Off
CAM_BackLightModelInq	8x 09 04 33 FF	y0 50 02 FF	On
		y0 50 03 FF	Off
CAM_ApertureInq	8x 09 04 42 FF	y0 50 00 00 0p 0q FF	pq: Aperture gain
CAM_ChromaInq	8x 09 7E 55 FF	y0 50 05 00 00 00 0p FF	p: 0 – Eh
CAM_GammaOffsetInq	8x 09 04 1E FF	y0 50 00 00 00 0s 0t 0u FF	s: Polarity offset (0 is plus, 1 is minus) tu: Offset s=0 (00h to 40h) Offset s=1 (00h to 10h)

CCU Scene Commands for the Universal CCU

This command is sent to the Universal CCU, not the camera.

Command Set	Command	Command Packet	Comments
CCU Scene	Reset	81 01 04 3F 00 7p FF	p: Scene number
	Set	81 01 04 3F 01 7p FF	Scene A = 1 Scene B = 2
	Recall	81 01 04 3F 02 7p FF	Scene C = 3

Other Commands

Command Set	Command	Command Packet	Comments
CommandCancel		8x 2p FF	p= socket (1 or 2)
CAM_Power	On	8x 01 04 00 02 FF	Power on
	Off	8x 01 04 00 03 FF	Power off
Corresponds to <code>camera standby</code> in Telnet API.			
CAM_Tally	On	8x 01 7E 01 0A 00 02 FF	
	Off	8x 01 7E 01 0A 00 03 FF	
CAM_NR	--	8x 01 04 53 0p FF	p = noise reduction level (0: off, 1 – 5)
CAM_Mute	On	8x 01 04 75 02 FF	Video mute on/off
	Off	8x 01 04 75 03 FF	
	Toggle	8x 01 04 75 10 FF	
Corresponds to <code>video mute</code> in Telnet API.			

Other Inquiry Commands

Inquiry Command	Command	Response Packet	Comments
CAM_PowerInq	8x 09 04 00 FF	y0 50 02 FF	On
		y0 50 03 FF	Off (standby)
Corresponds to <code>camera standby get</code> in Telnet API			
CAM_TallyInq	8x 09 7E 01 0A FF	y0 50 02 FF	On
		y0 50 03 FF	Off
CAM_NRInq	8x 09 04 53 FF	y0 50 0p FF	Noise reduction p: 00h to 05h
CAM_MuteModelInq	8x 09 04 75 FF	y0 50 02 FF	On
		y0 50 03 FF	Off
Corresponds to <code>video mute get</code> in Telnet API			
Vaddio_ModelInq	8x 09 08 0e FF	y0 50 05 00 00 00 00 FF	RoboSHOT 12
		y0 50 05 01 00 00 00 FF	RoboSHOT 30

Specifications

Cameras

Camera and image

Image device	1/2.8-Type Exmor® CMOS sensor
Video Resolutions	1080p/60, 59.94, 50, 30, 25 1080i/60, 59.94, 50 720p/60, 59.94, 50, 30, 25
Video Aspect Ratio	16:9 for all resolutions
Pan and tilt	Pan ± 150°, tilt +90° -30°; speed 0.35°/sec to 120°/sec
Lens and horizontal FOV	12 model: <ul style="list-style-type: none"> ○ Normal mode: 10x zoom, 67.3° (wide) to 7.6° (tele), f=3.8mm to 38.0mm, F1.8 to F3.4 ○ Super Wide mode: 12x zoom, 73.0° (wide) to 6.6° (tele), f=3.91mm to 47.0mm, F1.8 to F3.4 12E model: 12x zoom, 70.2° (wide) to 6.8° (tele), f=4.4mm wide end to 88.4mm tele end, F2 to F3.8 30 model: 30x zoom, 65° (wide) to 2.3° (tele), F1.6 to F4.7 30E model: 30x zoom, 70.2° (wide) to 3.1° (tele), f=4.4mm wide end to 88.4mm tele end, F2 to F3.8
Min. working distance	RoboSHOT 12: 8 in. (0.2 m) wide, 30 in. (0.8 m) tele RoboSHOT 30: 10 in. (0.25 m) wide, 48 in. (1.2 m) tele RoboSHOT 12E and 30E CAT-5: 3 in. (0.08 m) wide, 31 in. (0.8 m) tele
Min. illumination	Recommended: 100+ lux
Gain	Auto/Manual (28 steps)
Backlight compensation	On/off
Aperture/detail	16 steps
Focusing system	Auto Focus, Manual Focus, One Push Trigger Mode, Infinity Mode, Near Limit Mode
White balance	Auto, ATW, Indoor, Outdoor, One-push, Manual
Noise reduction	On/Off, 6 Steps
Sync system	Internal
S/N ratio	More than 50 dB
Remote management	IR Remote Commander, web interface, Telnet and VISCA/RS-232 command APIs
Power	12 VDC from Quick-Connect or AV Bridge MATRIX PRO, or 36 VDC from Universal CCU

Physical and Environmental

Height	6.9 in. (17.6 cm)	Weight	4.85 lbs (2.2 kg)
Width	7.1 in. (17.9 cm)	Operating/storage temperature	0°C to +40°C (32°F to 104°F)
Depth	6.8 in. (17.2 cm)	Operating/storage humidity	20% to 80% RH, non-condensing

Quick-Connect Devices

Universal CCU

Video Outputs	HD-YPbPr on DE-15-F connector HDMI on HDMI-F connector HD-SDI on Edge Mount Carrier Class, Gold BNC-F (3Gb/s Single Link 1080p/60 HD-SDI)		
Compatible with	RoboSHOT 12, RoboSHOT 30, PowerVIEW series, and ClearView series cameras.		
Maximum Cable Length	500 ft (152.4 m)	Power	36 VDC, 2.78 A
Height	1 RU / 1.72 in. (4.4 cm)	Width	18.93 in. (48.1 cm) without rack mounting brackets
Depth	7 in. (17.8 cm)	Weight	
Operating/storage temperature	0°C to +40°C (32°F to 104°F)		
Operating/storage humidity	20% to 80% RH, non-condensing		

Quick-Connect USB

Video Outputs			
Compatible with	RoboSHOT 12, RoboSHOT 30, ZoomSHOT, WideSHOT SE, PowerVIEW series, and ClearView series cameras.		
Maximum Cable Length	100 ft (30 m)	Power	24 VDC, 2.08 A
Height	1 RU / 1.72 in. (4.4 cm)	Width	8.38 in. (21.3 cm)
Depth	6 in. (15.2 cm)	Weight	1.4 lb. (0.64 kg)
Operating/storage temperature	0°C to +40°C (32°F to 104°F)		
Operating/storage humidity	20% to 80% RH, non-condensing		

Quick-Connect USB Mini

Video Outputs			
Compatible with	RoboSHOT 12, RoboSHOT 30, ZoomSHOT, WideSHOT SE, PowerVIEW series, and ClearView series cameras.		
Maximum Cable Length	100 ft (30 m)	Power	24 VDC, 2.08 A
Height	1.24 in. (3.1 cm)	Width	4.46 in. (11.3 cm)
Depth	3.58 in. (9.1 cm)	Weight	1.1 lb (0.5 kg)
Operating/storage temperature	0°C to +40°C (32°F to 104°F)		
Operating/storage humidity	20% to 80% RH, non-condensing		

Quick-Connect DVI/HDMI-SR

Video Outputs			
Compatible with	RoboSHOT 12, RoboSHOT 30, ZoomSHOT, PowerVIEW series, and ClearView series cameras.		
Maximum Cable Length	100 ft (30 m)	Power	24 VDC, 2.08 A
Height	1.47 in. (3.7 cm)	Width	8.0 in. (20.3 cm)
Depth	6.66 in. (16.9 cm)	Weight	1.2 lb. (0.55 kg)
Operating/storage temperature		0°C to +40°C (32°F to 104°F)	
Operating/storage humidity		20% to 80% RH, non-condensing	

Quick-Connect SR

Video Outputs			
Compatible with	RoboSHOT 12, RoboSHOT 30, PowerVIEW series, and ClearView series cameras.		
Maximum Cable Length	100 ft. (30 m)	Power	24 VDC, 2.08 A
Height	1.6 in. (4.1 cm)	Width	5.5 in (14 cm)
Depth	3.25 in. (8.3 cm)	Weight	0.45 lb. (0.2 kg)
Operating/storage temperature		0°C to +40°C (32°F to 104°F)	
Operating/storage humidity		20% to 80% RH, non-condensing	

Specifications are subject to change without notice.

Troubleshooting and Care

Use this information to determine whether it's time to call Vaddio Technical Support.

Check the Status Light First

When the camera doesn't behave as you expect, check the indicator light before you do anything else.

- **Blue:** Normal operation (blinks once when the camera receives a command from the remote)
- **Red:** On-air tally (signal provided by external device via serial connection)
- **Blinking red:** Video is muted (UC color scheme only)
- **Purple:** In standby mode or booting
- **Yellow:** Firmware update in progress

If the status light is off, check whether you can access the camera via its web interface or Telnet. If so, the status light is disabled.

Check the Cables Next

If the equipment behaves in a way that suggests even a remote possibility of a bad cable, please try a known good cable with the same pin-out.

Cables can be defective, whether they are purchased from a vendor or made at the installation site. Crimping tools can crimp unevenly, contacts can break internally, and individual conductors in the cable can break inside the jacketing material. Any of these can result in a cable that passes a continuity check but does not work reliably, or does not pass enough power to the connected device.

(The author would like to confess having made a certain number of almost-good cables. It happens.)

Power/Responsiveness Issues

What is it doing?	Possible causes	Check and correct
<p>Nothing. The status light is off, there is no video, and the camera does not respond to the remote.</p> 	Camera is not connected to a power source.	Verify that the camera is connected to the Universal CCU, Quick-Connect device, or AV Bridge MATRIX PRO installed with it.
	No power to the device providing power to the camera.	Verify that the Universal CCU, Quick-Connect device, or AV Bridge MATRIX PRO is connected to power.
	At least one of the cables is bad.	Check using known good cables.
	The wall outlet is not active. (Check by finding out if it powers something else, such as a laptop or phone charger.)	Use a different outlet.
	The device providing power is bad. Universal CCU, Quick-Connect USB, or AV Bridge MATRIX PRO: Buttons and display do not illuminate. Quick-Connect USB Mini or Quick-Connect DVI/HDMI-SR: Power light does not illuminate.	Contact your reseller or Vaddio Technical Support for help troubleshooting this issue if the camera is connected to a Quick-Connect SR or if it is connected to a device that appears to be bad.
The camera does not respond to the remote and the light is yellow.	A firmware update is in progress.	Wait a few minutes, and try again when the light turns blue.

Video Issues

What is it doing?	Possible causes	Check and correct
No video signal or black video. The camera's web interface is available and the camera responds to the directional controls on the remote.	The camera is set to a resolution not supported on the Quick-Connect device (for example, 1080p/60 on a camera with a Quick-Connect USB Mini).	Disconnect power, change the resolution to one that is supported on the Quick-Connect device, and reconnect power.
	Camera connected to a Quick-Connect USB Mini: The Quick-Connect device is in control mode.	Press the white button on the QMini to switch from control mode to video mode. Video is not available when the device is in control mode.
Blue or black video. The camera's web interface is available and the camera responds to the directional controls on the remote.	Video is muted.	Select the Mute button in the web interface. This button is available on every page of the web interface.
No H.264 video stream from the Quick-Connect USB.	The Quick-Connect USB is set for USB streaming.	In the Quick-Connect USB device's web interface, select IP streaming mode on the Streaming page.

Camera Control and Other Issues

What is it doing?	Possible causes	Check and correct
The camera does not respond to the remote, but the web interface is available.	The remote and the camera are not using the same IR channel.	Press the Camera Select 1 button on the remote. Try the other Camera Select buttons if necessary.
	The remote's batteries are dead.	Put new batteries in the remote.
The camera responds to the remote but not to the web interface.	The web interface is controlling a different camera. (Check by removing power from the camera; the web interface should become unavailable.)	Check the camera's IP address. See Getting the camera's IP address .
	More than one device is using this IP address.	
The camera responds to the remote but the web interface is not available.	The camera is not using the IP address you browsed to.	Press the Data Screen button on the remote to see camera information.
	The camera is not connected to the network.	Connect the network cable.
The camera responds to the remote but the web interface is not available.	The camera is not using the IP address you browsed to.	Press the Data Screen button on the remote to see camera information.
	Camera connected to a Quick-Connect USB Mini: The Quick-Connect device is in video mode.	Press the white button on the QMini to switch from video mode to control mode. Web control is not available when the device is in video mode.
The camera loses all its settings when power is cycled.	All the DIP switches are in the ON (down) position.	Set the DIP switches to their proper positions. Default is all OFF (up). See DIP Switches: Camera Behavior Settings for more information.



Status Light

The light in the camera's base indicates its current state.

- **Blue:** Normal operation (blinks once when the camera receives a command from the remote)
- **Red:** On-air tally (signal provided by external device via serial connection)
- **Blinking red:** Video is muted (UC color scheme only)
- **Purple:** In standby mode or booting
- **Yellow:** Firmware update in progress

Caution

Do not remove power or reset the camera while the indicator is yellow, showing a firmware update in progress. Interrupting a firmware update can make the camera unusable.

Note

By default, the camera's status light is active during normal operation; however, it can be configured to remain off when the camera is powered up. The camera may be sending video even if the indicator light is off.

Restoring Factory Settings from the Web Interface

SYSTEM PAGE, FIRMWARE TAB

Sometimes it's easiest to just start over. To restore the original factory settings...click Restore Factory Settings. This will overwrite everything you have customized – custom CCU scenes and presets, soft DIP switch settings, passwords, room labels, and more. For this reason, you may want to back up (export) the camera's configuration after you set up the customizations you want. See [Saving \(Exporting\) or Restoring \(Importing\) a Configuration](#).

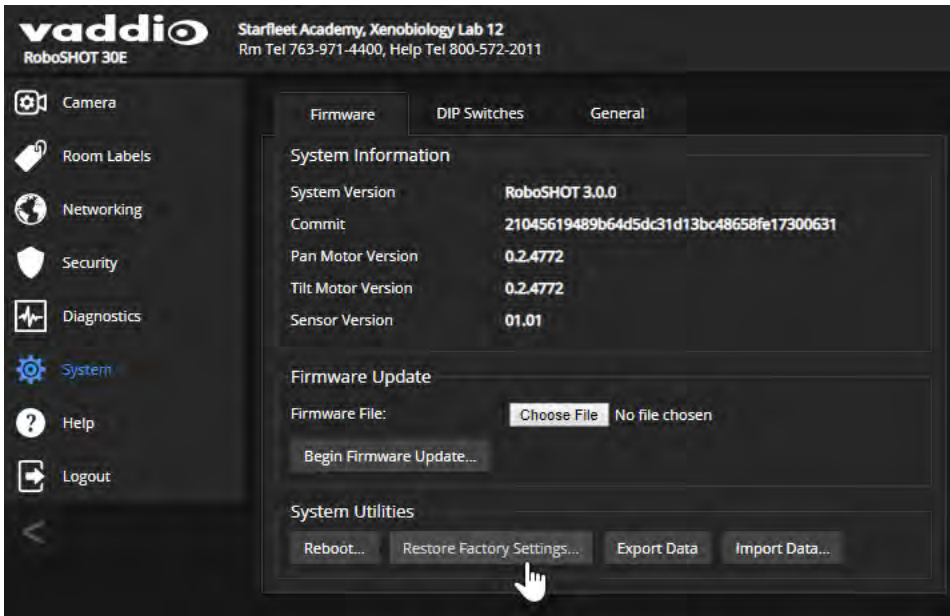

Restoring Factory Default Settings Via Hardware

If the camera's administrative controls are not accessible, you can restore factory defaults using the switches on the back of the camera.

This procedure is also available for the Quick-Connect USB device. It is not available for the Universal CCU, which stores very little information other than CCU scenes A, B, and C.

To restore factory default settings on an older RoboSHOT camera:

Set all DIP switches DOWN and cycle the power. Then return all DIP switches to the desired settings.

To restore factory default settings on a RoboSHOT 12E CAT-5 or RoboSHOT 30E CAT-5 camera:

Set the rotary switch to the Factory Reset position (E) and cycle the power. Then return the rotary switch to its previous position.

Operation, Storage, and Care

For smears or smudges on the product, wipe with a clean, soft cloth. Use a lens cleaner on the lens. Do not use any abrasive chemicals.

Keep this device away from food and liquids.

Do not operate or store the device under any of the following conditions:

- Temperatures above 40°C (104°F) or below 0°C (32°F)
- High humidity, condensing or wet environments
- Inclement weather
- Severe vibration
- Lunar environments not pressurized and climate-controlled to Earth-normal
- Dry environments with an excess of static discharge

Do not attempt to take this product apart. There are no user-serviceable components inside.

And a friendly reminder from our Training department...

As much as you might love our gear, do not attempt to romance your camera. As a robot it cannot return your love.



Compliance and Conformity Statements

Applicable to RoboSHOT cameras and Quick-Connect USB extensions

Compliance testing was performed to the following regulations:

FCC Part 15 (15.107, 15.109), Subpart B	Class A
ICES-003, Issue 54: 2012	Class A
EMC Directive 2014/30/EU	Class A
EN 55032: 2015	Class A
EN 55024: November 2010	Class A
KN24 2008 (CISPR 24: 1997 + A1: 2000 + A2: 2002)	Class A
IEC 60950-1:2005 (2nd Edition); Am 1: 2009 + Am 2: 2013	Safety
EN 60950-1: 2006 + A11: 2009 + A1: 2010 + A12: 2011 + A2: 2013	Safety

FCC Part 15 Compliance

This equipment has been tested and found to comply with the limits for a Class A digital device, pursuant to Part 15, Subpart B, of the FCC Rules. These limits are designed to provide reasonable protection against harmful interference when the equipment is operated in a commercial environment. This equipment generates, uses, and can radiate radio frequency energy and, if not installed and used in accordance with the instruction manual, may cause harmful interference to radio communications. Operation of this equipment in a residential area is likely to cause harmful interference in which case the user will be required to correct the interference at his/her own expense.

Operation is subject to the following two conditions: (1) This device may not cause interference, and (2) This device must accept any interference including interference that may cause undesired operation of the device.

Changes or modifications not expressly approved by Vaddio can affect emission compliance and could void the user's authority to operate this equipment.



ICES-003 Compliance

This digital apparatus does not exceed the Class A limits for radio noise emissions from digital apparatus set out in the Radio Interference Regulations of the Canadian Department of Communications.

Le présent appareil numérique n'émet pas de bruits radioélectriques dépassant les limites applicables aux appareils numériques de la classe A prescrites dans le Règlement sur le brouillage radioélectrique édicté par le ministère des Communications du Canada.



European Compliance

This product has been evaluated for Electromagnetic Compatibility under the EMC Directive for Emissions and Immunity and meets the requirements for a Class A digital device. In a domestic environment this product may cause radio interference in which case the user may be required to take adequate measures.

Standard(s) To Which Conformity Is Declared:



EMC Directive 2014/30/EU

EN 55032: 2015

Conducted and Radiated Emissions

EN 55024: November 2010

Immunity

EN 61000-4-2: 1995 + Amendments A1: 1998 + A2: 2001

Electrostatic Discharge

EN 61000-4-3: 2006 + A1: 2008

Radiated Immunity

EN 61000-4-4: 2004 + Corrigendum 2006

Electrical Fast Transients

EN 61000-4-5: 2006

Surge Immunity

EN 61000-4-6: 2009

Conducted Immunity

EN 61000-4-8: 2010

Power Frequency Magnetic Field

EN 61000-4-11: 2004

Voltage Dips, Interrupts and Fluctuations

KN24 2008 (CISPR 24: 1997 + A1: 2000 + A2: 2002)

IT Immunity Characteristics

EN 61000-4-2

Electrostatic Discharge

EN 61000-4-3

Radiated Immunity

EN 61000-4-4

Electrical Fast Transients

EN 61000-4-5

Surge Immunity

EN 61000-4-6

Conducted Immunity

EN 61000-4-8

Power Frequency Magnetic Field

EN 61000-4-11

Voltage Dips, Interrupts and Fluctuations

IEC 60950-1: 2005 (2nd Edition); Am 1: 2009 + Am 2: 2013

Safety

EN 60950-1: 2006 + A11: 2009 + A1: 2010 + A12: 2011 + A2: 2013

Safety

Compliance and Conformity Statements for Quick-Connect Devices

Applicable to Universal CCU, Quick-Connect USB Mini, Quick-Connect DVI/HDMI-SR, and Quick-Connect SR power/connectivity solutions.

Compliance testing was performed to the following regulations:

FCC Part 15 (15.107, 15.109), Subpart B	Class A
ICES-003, Issue 54: 2012	Class A
EMC Directive 2004/108/EC	Class A
EN 55022: December 2010	Class A
EN 55024: November 2010	Class A
KN22 2008 (CISPR 22: 2006)	Class A
KN24 2008 (CISPR 24: 1997 + A1: 2000 + A2: 2002)	Class A
IEC 60950-1:2005 (2nd Edition); Am 1: 2009 + Am 2: 2013	Safety
EN 60950-1: 2006 + A11: 2009 + A1: 2010 + A12: 2011 + A2: 2013	Safety

FCC Part 15 Compliance

This equipment has been tested and found to comply with the limits for a Class A digital device, pursuant to Part 15, Subpart B, of the FCC Rules. These limits are designed to provide reasonable protection against harmful interference when the equipment is operated in a commercial environment. This equipment generates, uses, and can radiate radio frequency energy and, if not installed and used in accordance with the instruction manual, may cause harmful interference to radio communications. Operation of this equipment in a residential area is likely to cause harmful interference in which case the user will be required to correct the interference at his/her own expense.

Operation is subject to the following two conditions: (1) This device may not cause interference, and (2) This device must accept any interference including interference that may cause undesired operation of the device.

Changes or modifications not expressly approved by Vaddio can affect emission compliance and could void the user's authority to operate this equipment.



ICES-003 Compliance

This digital apparatus does not exceed the Class A limits for radio noise emissions from digital apparatus set out in the Radio Interference Regulations of the Canadian Department of Communications.

Le présent appareil numérique n'émet pas de bruits radioélectriques dépassant les limites applicables aux appareils numériques de la classe A prescrites dans le Règlement sur le brouillage radioélectrique édicté par le ministère des Communications du Canada.



European Compliance

This product has been evaluated for Electromagnetic Compatibility under the EMC Directive for Emissions and Immunity and meets the requirements for a Class A digital device. In a domestic environment this product may cause radio interference in which case the user may be required to take adequate measures.

Standard(s) To Which Conformity Is Declared:



EMC Directive 2004/108/EC

EN 55022: 2010

EN 55024: November 2010

EN 61000-4-2: 1995 + Amendments A1: 1998 + A2: 2001

EN 61000-4-3: 2006 + A1: 2008

EN 61000-4-4: 2004 + Corrigendum 2006

EN 61000-4-5: 2006

EN 61000-4-6: 2009

EN 61000-4-8: 2010

EN 61000-4-11: 2004

KN22 2008 (CISPR 22: 2006)

KN24 2008 (CISPR 24: 1997 + A1: 2000 + A2: 2002)

EN 61000-4-2

EN 61000-4-3

EN 61000-4-4

EN 61000-4-5

EN 61000-4-6

EN 61000-4-8

EN 61000-4-11

IEC 60950-1: 2005 (2nd Edition); Am 1: 2009 + Am 2: 2013

EN 60950-1: 2006 + A11: 2009 + A1: 2010 + A12: 2011 + A2: 2013

Conducted and Radiated Emissions

Immunity

Electrostatic Discharge

Radiated Immunity

Electrical Fast Transients

Surge Immunity

Conducted Immunity

Power Frequency Magnetic Field

Voltage Dips, Interrupts and

Fluctuations

Conducted and Radiated Emissions

IT Immunity Characteristics

Electrostatic Discharge

Radiated Immunity

Electrical Fast Transients

Surge Immunity

Conducted Immunity

Power Frequency Magnetic Field

Voltage Dips, Interrupts and

Fluctuations

Safety

Safety

Warranty and Return Policy

Hardware warranty: Two (2) year limited warranty on all parts and labor for Vaddio manufactured products. Vaddio warrants its manufactured products against defects in materials and workmanship for a period of two years from the day of purchase, to the original purchaser, if Vaddio receives notice of such defects during the warranty. Vaddio, at its option, will repair or replace products that prove to be defective. Vaddio manufactures its hardware products from parts and components that are new or equivalent to new in accordance with industry standard practices.

Exclusions: The above warranty shall not apply to defects resulting from improper or inadequate maintenance by the customer, customers applied software or interfacing, unauthorized modifications or misuse, mishandling, operation outside the normal environmental specifications for the product, use of the incorrect power supply, modified power supply or improper site operation and maintenance. OEM and special order products manufactured by other companies are excluded and are covered by the manufacturer's warranty.

Vaddio Customer Service: Vaddio will test, repair, or replace the product or products without charge if the unit is under warranty. If the product is out of warranty, Vaddio will test then repair the product or products. The cost of parts and labor charge will be estimated by a technician and confirmed by the customer prior to repair. All components must be returned for testing as a complete unit. Vaddio will not accept responsibility for shipment after it has left the premises.

Vaddio Technical Support: Vaddio technicians will determine and discuss with the customer the criteria for repair costs and/or replacement. Vaddio Technical Support can be contacted by email at support@vaddio.com or by phone at one of the phone numbers listed on support.vaddio.com.

Return Material Authorization (RMA) number: Before returning a product for repair or replacement request an RMA from Vaddio's technical support. Provide the technician with a return phone number, e-mail address, shipping address, product serial numbers and original purchase order number. Describe the reason for repairs or returns as well as the date of purchase. See the General RMA Terms and Procedures section for more information. RMAs are valid for 30 days and will be issued to Vaddio dealers only. End users must return products through Vaddio dealers. Include the assigned RMA number in all correspondence with Vaddio. Write the assigned RMA number clearly on the shipping label of the box when returning the product. All products returned for credit are subject to a restocking charge without exception. Special order products are not returnable.

Voided warranty: The warranty does not apply if the original serial number has been removed or if the product has been disassembled or damaged through misuse, accident, modifications, use of incorrect power supply, use of a modified power supply or unauthorized repair.

Shipping and handling: Vaddio will not pay for inbound shipping transportation or insurance charges or accept any responsibility for laws and ordinances from inbound transit. Vaddio will pay for outbound shipping, transportation, and insurance charges for all items under warranty but will not assume responsibility for loss and/or damage by the outbound freight carrier. If the return shipment appears damaged, retain the original boxes and packing material for inspection by the carrier. Contact your carrier immediately.

Products not under warranty: Payment arrangements are required before outbound shipment for all out of warranty products.

General RMA Terms and Procedures: RMA's are valid for 30 days and will be issued to Vaddio dealers only.

- End users must return products through Vaddio dealers.
- Before a defective product can be authorized to send in for repair, it must first go through the troubleshooting process with a member of the Vaddio Technical Support team.
- Products authorized for repair must have a valid RMA (Return Material Authorization) number.
 - Vaddio RMA Team will issue the RMA number.
 - An RMA number is to be included in all correspondence with Vaddio.
 - The RMA number must appear clearly on the shipping label (not the box) when the product is returned.
 - A packing slip must be included on the inside of the box with the RMA number listed and reason for RMA return.
- Products received at Vaddio that do not have a valid RMA number clearly marked on the outside of the shipping container may be refused and returned to sender.
- Boxes showing external damage will be refused and sent back to the sender regardless of the clearly marked RMA number and will remain the responsibility of the sender.

RMA Charges (Restocking): All qualified returns must be made in unopened, original packaging with all original materials.

- Initial shipments of equipment that are refused upon attempted delivery, for any reason, are subject to restocking charges.
- The Dealer has up to 60 days from the date of purchase to return Vaddio product for credit for future purchases of Vaddio product only.
- The Dealer has 61 to 90 days from the date of purchase to return Vaddio product with a 15% restocking fee or \$50.00 fee, whichever amount is greater
- The Dealer has up to 30 days from the date of purchase to return OEM and other manufacturer's products with a 15% restocking fee or \$50.00 fee, whichever amount is greater.
- NOTE: Special Order products from other manufacturers (identified in the Vaddio Price Guide as noncancelable, nonreturnable and not refundable) are not eligible for advance replacement from Vaddio.

Advance Replacement Policies: For Vaddio manufactured products, advance replacement will be provided for up to one (1) year after the initial shipment of products.

- NOTE: OEM and other manufacturer's products are excluded from the Vaddio advance replacement policy. Advance replacement will be provided for up to 30 days after initial shipment of OEM products. Thereafter, a return to Vaddio and factory repair is offered during the other manufacturer's warranty period. Vaddio will determine if the returned product is qualified for the OEM warranty.
- NOTE: Special Order products from other manufacturers (identified in the Vaddio Price Guide as noncancelable, nonreturnable and not refundable) are not eligible for advance replacement from Vaddio.

Advance Replacement Procedures: The Vaddio Dealer must submit a non-revocable purchase order for advance replacement equipment at normal dealer pricing. Credit shall be issued upon complete product return (including all accessories) for dealers with Net 30 terms. For credit card accounts, charges will be assessed to the credit card for the replacement and credited back upon complete product return.

- Returns must be made in the original Vaddio packaging with all original materials if at all possible. Vaddio products with missing original materials will be billed to the dealer at dealer price.
- NOTE: OEM products must be returned in the original packaging with all materials and the RMA number written on the shipping label only and not on the OEM box. If the return is incomplete and/or the OEM box is defaced, the product shall be returned to the dealer and the RMA will not be credited.
- Equipment returned with “No Trouble Found” after advanced replacement will be assessed a full 15% or \$50.00 restocking fee (whichever is greater) for each item and may also be assessed for additional charges to compensate for wear, damages and reconditioning.
- All returns must be accompanied by RMA # as stated above.
- All Advanced Replacement products are sent via 2-day service in the continental USA. If the product is requested to be sent via priority or overnight shipping, the Dealer shall pay shipping costs. The dealer can elect to supply their preferred shipping account number.
- International customers are responsible for all freight charges for equipment returned to Vaddio, including international shipping, taxes, and duties, insurance and all other associated logistic charges.

Warranty Repair Terms and Procedures: Vaddio will repair any product free of charge, including parts and labor, within the terms outlined in the warranty agreement for that product.

- Customers must provide proof of the product’s purchase date.
- Product that is within the warranty period will be repaired under the non-warranty terms if:
 - The equipment has been damaged by negligence, accident, act of God, mishandling, used with the incorrect, modified or extended power supply or has not been operated in accordance with the procedures described in the operating and technical instructions.
 - The equipment has been altered or repaired by other than the Manufacturer or an authorized service representative.
 - Adaptations or accessories other than those manufactured or provided by the Manufacturer have been made or attached to the equipment, which in the determination of the Manufacturer, shall have affected the performance, safety or reliability of the equipment; or the equipment’s original serial number has been modified or removed.
- Customer is responsible for shipping charges to send defective product under warranty to Vaddio. Vaddio will pay ground service return shipping charges during the 2nd year of the warranty period.
- Standard return shipping method for products under warranty, but out of the advance replacement warranty period, is ground shipment. Extra charges associated with priority shipping, when requested, will be the responsibility of the customer.

Non-Warranty Repair Terms: Vaddio will repair any non-obsolete product that does not meet the terms of the warranty. Non-warranty repair terms are as follows:

- The customer is responsible for, and agrees to pay, all parts and labor costs associated with the repair. Standard non-warranty repair charges are outlined below.
- Customers must provide payment method and one of the following, prior to receiving an RMA:
 - Hard copy of a PO, for dealers with Net 30 terms and in good standing with Vaddio.
 - Valid credit card number - Credit card will be charged upon shipping repaired product back to customer.
- Request for COD: Customers will be notified of COD charges prior to shipping repaired unit.
- Customer is responsible for all shipping charges both to and from Vaddio, and may use their own carrier.
- Customers will receive a courtesy call notifying them of total repair charges prior to return shipping.

Non-Warranty Repair Charges: Total repair charges (per unit) for a non-warranty repair consist of the following:

- Cost of any replacement parts needed to repair the defect.
- Labor costs billed per hour after minimum charges/time.
- Labor charges include troubleshooting and repair time only.
- Burn-in time and final test time is not included in the labor charges.
- Labor time is rounded to the nearest quarter hour.
- Labor charges are billed at the prevailing rate for the category of equipment repaired, after minimum charges/time. For prevailing labor rates, please contact the Vaddio technical support.
- All shipping and handling costs are the responsibility of the customer for non-warranty repairs.

Minimum Labor Charges: All non-warranty repairs are subject to a minimum evaluation/repair labor charge even if there is no problem found. Please contact Vaddio technical support for the current applicable rate.

Repair Charge Estimates: Estimates on repair charges for a specific problem will not be given before an RMA is issued and the actual product has been evaluated by a Vaddio technician. Repair estimates will be given after the repair department receives and evaluates the unit.

- Customers requesting an estimate on repair charges must do so up front when they call in for an RMA. The RMA team will call or email with the estimate after evaluating the unit and before proceeding with the repair.
- Any product evaluated for a repair estimate is still subject to the minimum labor charges even if the customer decides not to proceed with the repair.
- Vaddio does not guarantee estimates given on repair charges. Actual repair costs may exceed the estimate.
- Customer is responsible for actual repair charges, regardless of estimate.

Repair Policy Notes:

- **Duration of Repair:** Products are repaired on a first come first serve basis. The turn-a-round time of a particular repair is dependent upon circumstances such as product type, the nature of the problem and current repair volumes. Requests for expedited repair service will be considered on a case-by-case basis.
- **Repair Warranty:** Vaddio guarantees all of its repair work, performed on non-warranty items, for 90 days from the day the repaired product is shipped back to the customer. If the original problem described was not resolved or reoccurs within the 90-day period, Vaddio will repair the unit free of labor charges. However additional material charges may apply unless the parts used to affect the repair are again deemed defective.

Photo Credits

This manual may include some or all of these photos.

European Space Agency (ESA) astronaut Samantha Cristoforetti, a Flight Engineer with Expedition 42, photographs the Earth through a window in the Cupola on the International Space Station

By NASA - https://blogs.nasa.gov/ISS_Science_Blog/2015/03/06/women-in-space-part-two-whats-gender-got-to-do-with-it/, Public Domain, <https://commons.wikimedia.org/w/index.php?curid=38834990>

Carl Sagan, Bruce Murray, Louis Friedman (founders) and Harry Ashmore (advisor), on the occasion of signing the papers formally incorporating The Planetary Society

By credit NASA JPL - JPL, Public Domain, <https://commons.wikimedia.org/w/index.php?curid=1180927>

Main Control Room / Mission Control Room of ESA at the European Space Operations Centre (ESOC) in Darmstadt, Germany

By European Space Agency - ESOC flickr, Credit: ESA - Jürgen Mai, CC BY-SA 3.0-igo,

<https://commons.wikimedia.org/w/index.php?curid=36743173>

Expedition 42 on orbit crew portrait, International Space Station, Mar. 7, 2015 – Barry Wilmore (Commander) Top, Upside down, to the right cosmonaut Elena Serova, & ESA European Space Agency Samantha Cristoforetti. Bottom center US astronaut Terry Virts, top left cosmonauts Alexander Samokutyaev and Anton Shkaplerov.

By NASA - <https://www.flickr.com/photos/nasa2explore/16166230844/>, Public Domain,

<https://commons.wikimedia.org/w/index.php?curid=38931301>

European Space Agency astronaut Luca Parmitano, Expedition 36 flight engineer, outside the International Space Station

By NASA - <http://spaceflight.nasa.gov/gallery/images/station/crew-36/html/iss036e016704.html>, Public Domain, <https://commons.wikimedia.org/w/index.php?curid=27263573>

Chris Cassidy, Luca Parmitano, and Karen Nyberg, ISS, 2013. Photo Credit: NASA

Nicolas Altobelli, Rosetta Scientist at ESA's European Space Astronomy Centre, Villanueva de la Cañada, Madrid, Spain

By European Space Agency - Nicolas Altobelli talks to the media, CC BY-SA 3.0-igo,

<https://commons.wikimedia.org/w/index.php?curid=36743144>

Andrea Accomazzo, ESA Rosetta Spacecraft Operations Manager, providing a live update from the Main Control Room at ESA's European Space Operations Centre, Darmstadt, Germany during the Rosetta wake-up day.

By European Space Agency - Live update from the Main Control Room, CC BY-SA 3.0-igo,

<https://commons.wikimedia.org/w/index.php?curid=36743150>

Sleeping goose

By ladypine - Own work, CC BY-SA 3.0, <https://commons.wikimedia.org/w/index.php?curid=1695227>

STS-123 and Expedition 16 crews on the STS-123 crew's last full day onboard the International Space Station.

By NASA - <http://www.spaceflight.nasa.gov/gallery/images/shuttle/sts-123/html/iss016e033684.html>,

Public Domain, <https://commons.wikimedia.org/w/index.php?curid=3773505>

Index

A

- admin login 43, 45, 56, 58
 - changing 56
 - changing on Quick-Connect device 58
 - default 43
 - QUSB or QMini 45
- anatomy of the camera 15-17
- anatomy of the Quick-Connect device 21-24
 - Quick-Connect DVI/HDMI-SR (QDVI) 23
 - Quick-Connect SR (QSR) 24
 - Quick-Connect USB (QUSB) 21
 - Quick-Connect USB Mini (QMini) 22
- anatomy of the Universal CCU (QCCU) 19
- API 89-102, 104-105, 107-110
 - RS-232 (VISCA) 102, 104-105, 107-110
 - Telnet 90-101
- auto focus 72, 93
- auto iris 69, 95-96
- auto white balance 69, 71, 82, 95-96
- automatic NTP updating 55

B

- backing up a configuration 60
- backlight compensation 69-70, 95-96
- Baud Rate setting 28, 77
- behavior on power-up 66
- blue gain 69, 71, 82, 95-96
- Brightness compensation adjustment (QCCU) 83
- brightness setting 82
- browser compatibility 41

C

- cable 16-17, 85, 114
 - connectors 16-17
 - please check them (PLEASE) 114
 - skew adjustment for long cables 85
- camera control issues, troubleshooting 117
- Camera ID setting 28, 77
- camera mount, installing 26
- Camera page (web) 68-69
- camera select 39-40
- camera specifications 111
- camera standby position 87

- capabilities 2-4, 111-113
 - Quick-Connect DVI/HDMI-SR (QDVI) 4, 113
 - Quick-Connect SR (QSR) 4, 113
 - Quick-Connect USB (QUSB) 3, 112
 - Quick-Connect USB Mini (QMini) 4, 112
 - Universal CCU (QCCU) 3, 112
- CCU scenes 66-68, 71, 83-85, 88, 97
 - custom 67, 71, 97
 - custom (UCCU) 85
 - recalling 97
 - RS-232 commands for QCCU 109
- CCU settings 70-71, 94-96
- ceiling-mounted cameras 26
- cheat sheet 39, 46, 70-71
 - color adjustment 71
 - lighting and image quality 70
 - Vaddio IR Remote Commander 39
 - web interface 46
- chroma setting 69-71, 82, 95-96
- cleaning 119
- Codec Control Mode setting 78
- color codes for status light 38, 114, 117
- color settings 68-69, 71, 84, 95-96
 - adjusting 84
- command history 101
- command set, RS-232 (VISCA) 102, 104-105, 107-110
- compatibility, browsers 41
- Compensation level adjustment (QCCU) 83
- configuration, saving or restoring 60
- connection example 33-36
 - RoboSHOT QDVI system 35
 - RoboSHOT QMini system 34
 - RoboSHOT QSR system 36
 - RoboSHOT QUSB system 33
- connector identification 16-17, 19, 21-24
 - Quick-Connect DVI/HDMI-SR (QDVI) 23
 - Quick-Connect SR (QSR) 24
 - Quick-Connect USB (QUSB) 21
 - Quick-Connect USB Mini (QMini) 22
 - Universal CCU (QCCU) 19
- connector pin-out, RS-232 30
- control mode (QMini) 44
- Controls page (web) 87
- custom CCU scenes 71
- custom home position, setting 66

D

damage, preventing 25, 30
 default 41-43, 100, 118
 admin password 43
 IP address, camera 41
 settings, restoring 100, 118
 user password 42
 detail setting 69-70, 82, 95-96
 DHCP 51
 diagnostic logs 65
 Diagnostics page (web) 65
 DIP switch settings 28, 76-78
 reading from web interface 76
 directional controls 39-40, 88
 Display brightness level adjustment (QCCU) 83

E

Enable LED in Standby setting 78

F

factory defaults, restoring 100, 118
 fault isolation 114-117
 firmware update 61-63
 camera 61
 QUSB or QMini 62
 Universal CCU (QCCU) 63
 firmware version 61-62, 100
 focus 39-40, 72, 93
 front panel display adjustments (QCCU) 86

G

gain 69-71, 95
 blue 69, 71
 iris 70
 red 69, 71
 gamma setting 69-70, 82
 getting help 65
 guest access 56

H

HDMI Color Space setting 83
 HDMI resolution, setting 27
 Help page (web) 65
 home position 66, 88, 90
 custom 66
 hostname 51, 53
 camera 53

QUSB or QMini 53

HTTPS, enabling or requiring 57

I

Image Flip setting 28, 77
 importing a configuration 60
 inactive sessions (web interface) 56
 indicator light 15, 38, 78, 97, 114, 117
 color scheme 78
 enabling/disabling 97
 location 15
 meaning of colors 38, 114, 117
 information, conference room 59
 installation, typical 33-36
 RoboSHOT QDVI system 35
 RoboSHOT QMini system 34
 RoboSHOT QSR system 36
 RoboSHOT QUSB system 33
 inverted installation 26
 IP address 31, 39-41, 44, 49, 51, 54
 camera 41
 camera, default 41
 camera, discovering 41
 default 49, 51, 54
 preventing conflicts 31, 51
 Quick-Connect USB Mini 44
 Quick-Connect USB, discovering 44
 static 51
 static, configuring before installation 31, 49, 51
 IP streaming 80-81
 configuring (QUSB) 81
 selecting (QUSB) 80
 IR On/Off setting 77
 IR Out setting 28
 IR remote 39-40
 iris settings 69-70, 82, 95-96

L

labels, room 59
 LED 15, 38, 78, 97, 114, 117
 enabling/disabling 97
 location 15
 meaning of colors 38, 114, 117
 LED Color Scheme setting 78
 LED On/Off setting 78
 light, status indicator 15, 38, 78, 97, 114, 117
 color scheme 78
 enabling/disabling 97

- location 15
- meaning of colors 38, 114, 117
- lighting settings 68-69, 84, 88, 95-97
 - adjusting 84
 - default 84
- locations of connectors 16-17, 19, 21-24
 - Quick-Connect DVI/HDMI-SR (QDVI) 23
 - Quick-Connect SR (QSR) 24
 - Quick-Connect USB (QUSB) 21
 - Quick-Connect USB Mini (QMini) 22
 - Universal CCU (QCCU) 19
- log files 65
- login 42-43, 45
 - admin 43
 - admin (QUSB or QMini) 45
 - user 42
- low-power (standby) state 87, 98

M

- making a scene 85
- manual focus 39-40, 72, 93
- Mode button (QMini) 44
- mounting cameras 26, 37
- mounting the Quick-Connect device 38
- muting video 87

N

- navigation buttons, hiding/showing 43
- network configuration 41, 49, 51, 53-54, 98
 - current 98
 - default 51
- Networking page (web) 49, 51, 53-55
- Networking page (web), QUSB or QMini 53
- noise reduction adjustment 83
- NTP server 55

O

- One Push White Balance 71
- operating environment 119
- output resolution 27

P

- packing lists 5
- page 49, 51, 53-57, 59, 61-62, 64-65, 68-69, 78, 80-81, 87
 - Camera 68-69
 - Control 87
 - Diagnostics 65
 - Help 65

- Networking 49, 51, 53-55
- Networking (QUSB or QMini) 53
- Room Labels 59
- Security 56-57
- Streaming (QUSB or QMini) 80-81
- System 61, 64, 78
- System (QUSB or QMini) 62, 64
- pan 73, 75, 90
 - direction 75
 - speed 73
- pan/tilt/zoom controls 39-40, 88
- passwords 42-43, 45, 56, 58
 - admin, default 43
 - admin, default (QUSB or QMini) 45
 - user, default 42
- pedestal 82
- performance specifications 111-113
- physical and environmental specifications 111-113
- pin-out, RS-232 connector 30
- ping command 99
- point light compensation 69-70
- power 16-17, 39-40, 115
 - issues, troubleshooting 115
 - on and off 39-40
- power-up settings 66
- presets 39-40, 67, 88, 94
 - clearing 40
 - moving to 88
 - recalling 94
 - renaming 67
 - setting 40, 94
- privacy 87
- Pro AV LED Color Scheme setting 78
- product capabilities 2-4
 - Quick-Connect DVI/HDMI-SR (QDVI) 4
 - Quick-Connect SR (QSR) 4
 - Quick-Connect USB (QUSB) 3
 - Quick-Connect USB Mini (QMini) 4
 - Universal CCU (QCCU) 3
- product returns and repairs 124

Q

- QCCU (Universal CCU) 3, 19, 63, 82-86, 109
 - connector identification 19
 - DIP switches 19
 - front panel display adjustments 86
 - front panel features 19
 - menu navigation 82-83

- updating 63
- Quick-Connect 3-4, 16-17, 19, 21-24, 33-36, 38, 44-45, 80-86, 109, 112-113
 - DVI/HDMI-SR (QDVI) 4, 23, 35
 - mounting options 38
 - specifications 112-113
 - SR (QSR) 4, 24, 36
 - Universal CCU (QCCU) 3, 19, 82-86, 109
 - USB (QUSB) 3, 21, 33, 44-45, 80-81
 - USB Mini (QMini) 4, 22, 34, 44-45, 80
- quick reference 39, 46, 70-71
 - Vaddio IR Remote Commander 39
 - web interface 46

R

- ready state 87, 98
- rebooting the camera 64, 99
- rebooting the Quick-Connect device 64
- red gain 69, 71, 82, 95-96
- remote control 39-40
- reset See also rebooting the camera; restoring default settings
- resolution 27, 78
 - setting in web interface 78
- restoring a configuration 60
- restoring default settings 100, 118
- room information 59
- Room Labels page (web) 59
- rotary switch 27
- RS-232 commands 102, 104-105, 107-110
 - setting values 107-108
- RS-232 connector 16-17, 30

S

- safety requirements 25
- saving a configuration 60
- scenes, CCU 67-68, 84-85, 88
 - naming 67
 - storing 71, 85
- Scott 68
- Security page (web) 56-57
- session time-out 56
- settings, default, restoring 100, 118
- shelf-mounted cameras 37
- shelf, camera mount 26
- shutter adjustment 83
- skew adjustment (QCCU) 83, 85
- soft DIP switches 77-78
- software control of video output resolution 78

- solving problems 85, 114-117
- specifications 111-113
- speed 73, 90-93
 - focus 93
 - pan/tilt/zoom 73, 90-92
- SSL certificate 57
- Standard Control/Codec Control setting 78
- standby (low-power) state 87, 98
- start-up behavior, setting 66
- static IP address 49, 51, 54
- status light 15, 38, 78, 97, 114, 117
 - color scheme 78
 - enabling/disabling 97
 - location 15
 - meanings of colors 38, 114, 117
- storage environment 119
- storing a configuration 60
- Streaming page (web, QUSB or QMini) 80-81
- Super-Wide Mode setting 28
- supported web browsers 41
- switch settings 26-29, 61, 76-78
 - 3G Level A/Level B 78
 - Baud Rate 28, 77
 - Camera ID 28, 77
 - Enable LED in Standby 78
 - for Quick-Connect USB 29
 - for Universal CCU 29
 - Image Flip 26, 28, 77
 - IR On/Off 77
 - IR Out 28
 - LED Color Scheme 78
 - LED On/Off 78
 - reading from web interface 61
 - Standard Control/Codec Control 78
 - Super Wide Mode 28
 - video resolution 27
- System page (web) 61, 64, 78
- System page (web, QUSB or QMini) 62, 64
- system time 55

T

- technical specifications 111-113
- technical support 65
- Telnet 56, 89
 - disabling access via 56
 - session 89
 - session history 101
 - session, ending 101

Telnet API 89-101
 command help 89
 syntax help 101
 temperature, operating and storage 119
 tilt 73, 75, 91
 direction 75
 speed 73
 time zone 55
 Tri-Synchronous Motion (Tri-Sync) 74, 94
 troubleshooting 114-117
 typical installation 37

U

UC LED Color Scheme setting 78
 Universal CCU (QCCU) 19, 63, 82-86
 connector identification 19
 DIP switches 19
 front panel display adjustments 86
 front panel features 19
 menu navigation 82-83
 updating 63
 update 61-63
 camera 61
 QUSB or QMini 62
 Universal CCU (QCCU) 63
 USB device name (QUSB or QMini) 80
 USB streaming 80
 selecting (QUSB) 80
 user login 42, 56
 changing 56
 default 42

V

Vaddio IR Remote Commander 39
 Vaddio Loader 63
 version, firmware 100
 video mode (QMini) 44
 video mute 87
 Video Output Resolution (setting) 78
 video resolution 27
 VISCA commands 102, 104-105, 107-110
 voilà, a small cat 117

W

wall-mounted cameras 37
 wall mount 26
 warranty 25, 124
 web browsers supported 41

web interface 41, 43-45, 49-51, 53-57, 59, 61-62, 64-65, 68-69, 78, 80-81, 87
 accessing 41
 accessing via direct connection 50
 Camera page 68-69
 Controls page 87
 Diagnostics page 65
 Help page 65
 navigation button labels 43
 Networking page 49, 51, 53-55
 Networking page (QUSB or QMini) 53
 QUSB or QMini 44-45
 Room Labels page 59
 Security page 56-57
 Streaming page (QUSB or QMini) 80-81
 System page 61, 64, 78
 System page (QUSB or QMini) 62, 64
 white balance auto/manual 82
 wide dynamic range setting 69-70, 83, 95-96

Y

Y gain adjustment (QCCU) 83

Z

zoom 88, 92
 zoom speed 39-40, 73, 92

Vaddio is a brand of Legrand AV Inc. · www.legrandav.com · Phone 800.572.2011 / +1.763.971.4400 · Fax +1.763.971.4464 · Email av.vaddio.support@legrand.com

Visit us at support.vaddio.com for firmware updates, specifications, drawings, manuals, technical support information, and more.

©2019 Legrand AV Inc.

Vaddio is a registered trademark of Legrand AV Inc. All other brand names or marks are used for identification purposes and are trademarks of their respective owners. All patents are protected under existing designations. Other patents pending.

A brand of  legrand®

Commercial AV Brands Chief | Da-Lite | Middle Atlantic | Projecta | Vaddio

vaddio®