



Complete Manual for

EasyIP CeilingMIC/AMP D

Network-Connected Amplifier and Overhead Microphone

Document 411-0063-30 Rev A
December 2022

Contents

Overview	1
About this Manual	1
Features	1
A Quick Look at the EasyIP CeilingMIC/AMP D	2
Amp Specifications	2
Installation	3
Tools You Will Need	3
Safety Information	3
Placement Tips	3
Don't Void Your Warranty!	4
Cabling Notes	4
Connecting the Microphone Drop Cable	5
Preparing the Ceiling	6
Installing the Ceiling Box	7
Connecting the Microphone Body	7
Basic Connections	8
Completing the Set-Up	9
About Dante Technology and Devices	9
Locating and Renaming Dante Devices	10
Pairing Audio Devices to the Host Device	12
Using More than Two EasyIP Microphones with a Vaddio Host Device	13
About Channels and Flows	13
Creating a Multicast Flow	14
Combining Channels into Flows	15
Working with EasyIP Microphones	17
About the Vaddio Dante Interface Application	17
Fine-Tuning EasyIP Microphone Performance	17
Installing a Firmware Update for an EasyIP Microphone	19
Troubleshooting	20
Use, Storage, and Care	20

Overview

This guide covers:

EasyIP CeilingMIC/AMP D network-connected amplifier and overhead microphone

- 999-86810-000, worldwide (white)
- 999-86820-000, worldwide (black)

About this Manual

Information in this manual includes:

- Physical features
- Installation
- Pairing and audio adjustments
- Updating firmware
- Troubleshooting

Features

With Dante networked microphone and co-located Dante amplifier, the EasyIP CeilingMIC/AMP D provides a convenient solution that brings existing analog speakers into the EasyIP system.

- Combines the EasyIP CeilingMIC D circuitry with an EasyIP AMP D in the same ceiling box
- Dante networked audio – microphone and amp are addressed and managed separately with the Dante Controller application from Audinate
- Bring an analog speaker into your EasyIP or Dante environment via the amp connection
- Microphone available in white or black, with matching drop cable and easy-to-install trim plates
- Three-element overhead microphone design with built-in digital signal processor (DSP) and improved geometry for 360° coverage and better audio pick-up
- Easy access to the microphone cable connector; designed for customizable ceiling drop cable length
- Amp uses PoE+ or PoE power; adaptive output – 25 W if powered by an EasyIP Switch or other PoE+ source, 15 W if powered by a PoE source
- Convenient, simple, easy to install and connect

A Quick Look at the EasyIP CeilingMIC/AMP D

Easy-to-install interface box

- **Network/PoE+ port** – Just one connection to an EasyIP Switch or other PoE+ connection
- **Speaker Output port** – Amplifier connection to analog speaker
- **Microphone cable opening** – sized to accommodate included grommet for strain relief

Microphone body and drop cable

- Drop cable and trim plates match microphone color
- Easy access to the cable connector in the microphone body
- Flexible strain relief boot at the top of the microphone body accommodates standard category cable – build cable to length if needed
- Up to 15 ft. (4.6 m) drop-down cable length
- Pair to the host device using the Dante Controller application

Amplifier

- Connect to an analog speaker – use existing speakers with new EasyIP installations
- Pair to the host device using the Dante Controller application
- Manage speaker volume from the EasyIP host device



Amp Specifications

Power requirements	PoE+
Input	Balanced audio, one channel
Input impedance	> 100K ohms
Output	One channel
Output power	25 W if PoE+ powered, 15 W if PoE powered
Minimum output impedance	4 ohms

Installation

This section covers:

- Tools you will need
- Safety information
- Tips for a successful audio installation
- Cabling notes
- Physical installation
- Connection diagrams

Tools You Will Need

- Hole saw for the appropriate type of ceiling
- #2 Phillips screwdriver
- Wire cutters
- Tape measure
- Ladder or lift
- Appropriate personal protective equipment

We recommend suspending the tile brace using Chief's "Speed Connect Hardware Kit," part number CMSHDW, available from legrandav.com.

Safety Information

Warning

Follow standard safety practices when using ladders or lifts. Failure to do so can result in injury or death.



Note

All above-ceiling work must conform to local building codes and should be performed by qualified personnel.

Placement Tips

Avoid common audio problems:

- The effective range for each Vaddio microphone and each Vaddio speaker is about 12 ft. (3.7 m) under most circumstances. Be sure the room design includes enough microphones and speakers to provide adequate coverage.
- To prevent audio feedback, install microphones at least 4 ft. (1.2 m) from speakers. More separation is better.
- Place microphones closer to the people talking than to the room's speakers. This helps maintain good echo cancellation.
- Because of its geometry, the overhead microphone is less sensitive in a small area directly below it. In a small to medium room, it may make sense to install the microphone(s) above the centerline of the conference table.
- Do not route microphone cables across or beside fluorescent light fixtures. Electrical interference from the ballasts may degrade the audio signal.
- Mount the EasyIP CeilingMIC/AMP D away from air vents, to keep the microphone from picking up the sounds of the HVAC system.

Don't Void Your Warranty!

Caution

This product is for indoor use. Do not install it outdoors or in a humid environment without the appropriate protective enclosure. Do not allow it to come into contact with any liquid.

Do not install or operate this product if it has been dropped, damaged, or exposed to liquids. If any of these things happen, return it to Vaddio for safety and functional testing.

Cabling Notes

Caution

Do not use pass-through RJ-45 connectors when making cables for this product. Poorly crimped connectors of this type can cause intermittent connections and degraded signal quality. They can also damage the connectors on the product, which will void your warranty.



Intact – will make reliable contact with cable connector

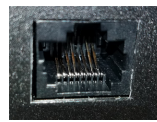

Damaged – Bent contact fingers will NOT make reliable contact with cable connector

When making cables for this product, use Cat-5e or better cable. We recommend using high-quality connectors and a high-quality crimping tool.



We recommend shielded cabling if the cables will be coiled, run tightly with other cables, or routed near sources of electromagnetic interference such as power lines or fluorescent light fixtures.

Caution

Check your cables. Connecting a cable to the wrong port or using the wrong pin-out can result in equipment damage and will void the warranty.

Pro Tip

Label all cables at both ends.

Connecting the Microphone Drop Cable

1. Remove the cover from the ceiling box.

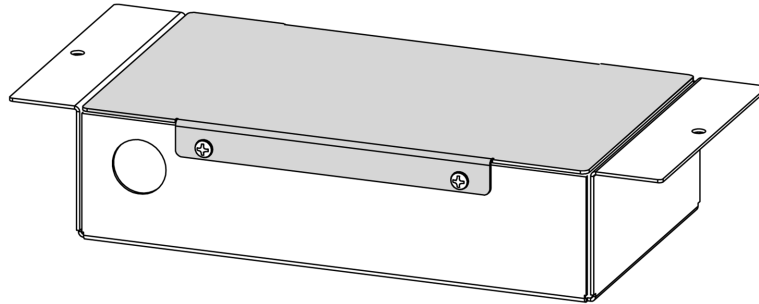

2. Determine the desired length of the microphone drop cable, from the ceiling to the top of the microphone body (not the top of the strain relief boot). Be sure this leaves enough cable inside the ceiling box to avoid placing tension on the connector.

Note

If desired, you can use a Cat-5e cable made to the desired length (not to exceed 15 ft or 4.6 m) for the microphone drop-down cable. Please contact Vaddio Technical Support if your installation requires a longer drop cable. Cat-5e or better SSTP cable may provide better performance in some electrically noisy environments.

3. Thread the drop cable through the opening in the floor of the box.
4. Snap the strain relief grommet onto the drop cable at the desired cable length, and press it into the opening in the floor of the box.
5. Connect the drop cable to the port labeled MIC CABLE.
6. If there is excess cable above the grommet, thread a zip tie through the tie loop in the side of the box and secure the cable.



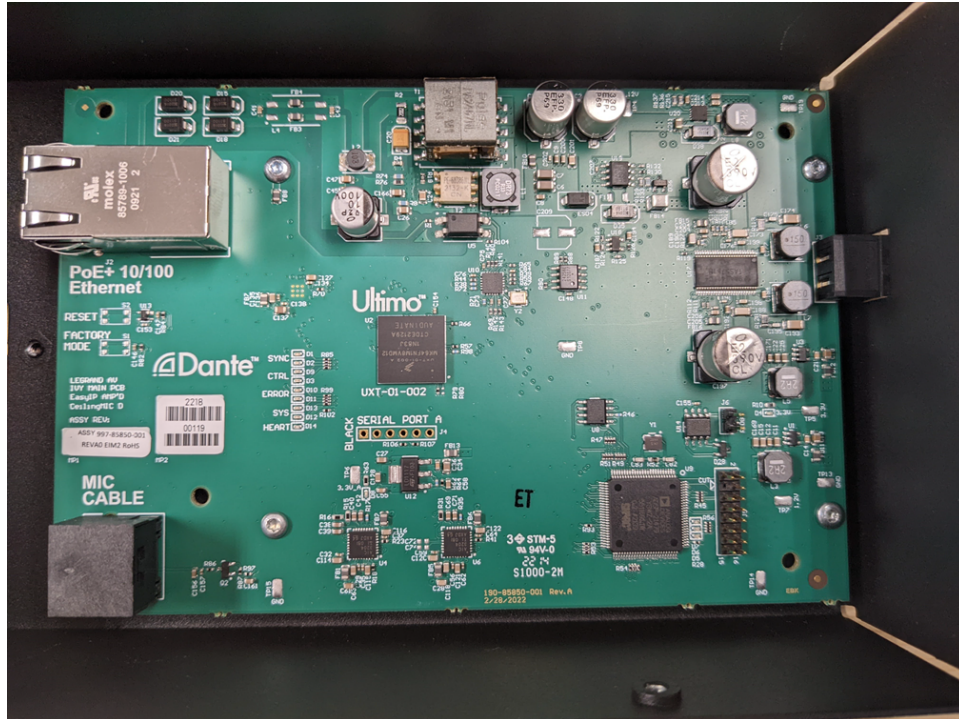

Note

The photo shows the ceiling box for a CeilingMIC. The EasyIP CeilingMIC D has a larger circuit board.

Preparing the Ceiling

You will need to make a hole in the ceiling. The hole needs to be slightly smaller than the trim plates.

Warning

Follow standard safety practices when using ladders or lifts. Failure to do so can result in injury or death. We like you, we don't want you to be injured or killed, and we hope you understand the gravity of the situation.

If installing in a hard ceiling:

Make sure there is room for the ceiling box and its cables at the location where you want to install it.

If installing in a suspended tile ceiling:

1. Remove the ceiling tile where the microphone will be mounted, and make a hole in the tile.
2. Reinstall the ceiling tile and position the tile brace.

Note

Because the microphone assembly weighs very little, the tile brace does not need to be physically attached to the tile support grid unless this is required by local building codes.

Installing the Ceiling Box

Working above the ceiling:

1. Route one Cat-5e (or better) cable from the EasyIP Switch to the ceiling box. The cable may be up to 328 ft. (100 m.) long.
2. Thread the cable from the EasyIP Switch through the opening in the side of the ceiling box and connect it to the PoE+ connector on the board.
3. Install the split grommet in the opening in the side of the ceiling box to keep the cable from chafing.
4. Connect a cable from the Speaker Output connector to an analog speaker.
5. Reinstall the cover on the ceiling box.
6. Thread the microphone drop cable through the opening in the tile brace and ceiling, and place the ceiling box flat.

Connecting the Microphone Body

Working below the ceiling:

1. Connect the drop cable to the port in the microphone body.

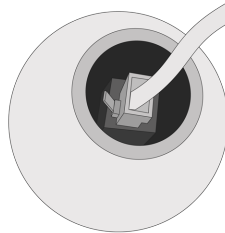

2. Fit the strain relief boot over the drop cable.
3. Fit the strain relief boot into place in the microphone body.
4. Making sure the countersinks face outward, slide both the slotted trim plates over the cable, with the slots on opposite sides. Use the 3/4 inch flat head screws to secure the trim plates to the threaded posts on the bottom of the interface box.

(Illustration shaded for clarity)

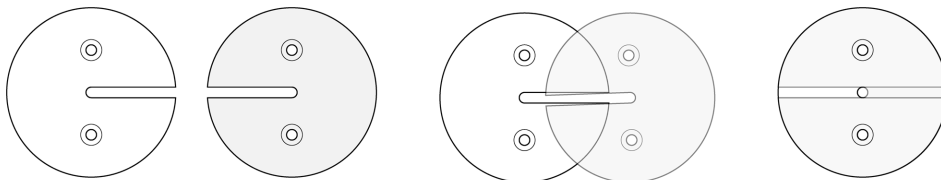

Contact Vaddio Technical Support if you have questions or encounter any problems.

Basic Connections

This is a simple installation for a medium conference room, using two EasyIP CeilingMIC/AMP D devices for audio. In this installation, each EasyIP CeilingMIC/AMP D connects to an analog speaker and the system's PoE+ switch, and pairs to an EasyIP Mixer over the network. The EasyIP Mixer also manages EasyIP cameras and originates a USB 3 stream, making audio and video available to soft conferencing applications.

The EasyIP CeilingMIC/AMP D can also be used with other host devices that support Dante connectivity.

Note

Because the EasyIP CeilingMIC/AMP D houses two separate devices that are not directly connected to the host device (an EasyIP Mixer in the diagram above), the microphone and amp must both be paired to the device in order to operate.

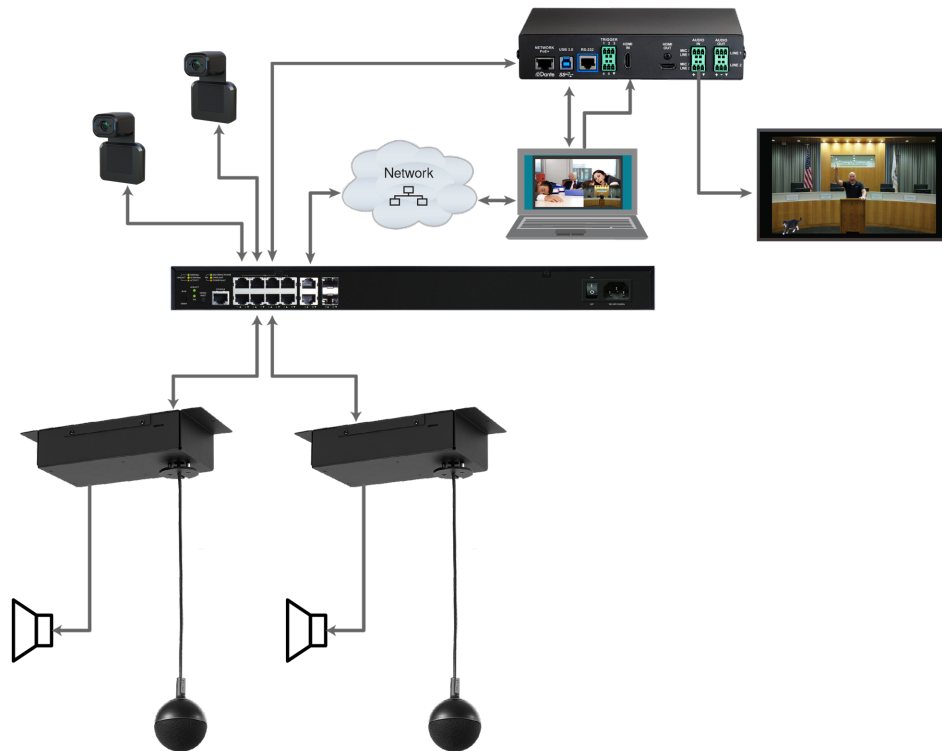

Note

The amp can drive more than one speaker; total load must be at least 4 ohms.

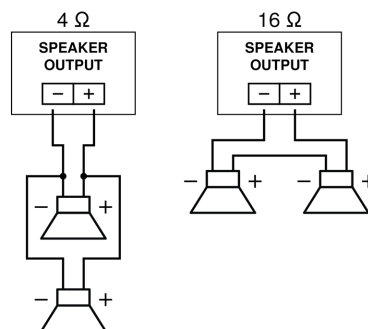

Completing the Set-Up

You will need the following applications to work with the EasyIP CeilingMIC/AMP D.

- **Dante Controller** – For routing audio devices with Dante® connectivity to the A/V equipment. Download and install the free Dante Controller application from Audinate Pty. Ltd.: www.audinate.com/products/software/dante-controller
- **Vaddio Dante Interface Application** – For accessing EasyIP microphone settings and adjustments, and for updating EasyIP audio device firmware. Download the Vaddio Dante Interface Application from the Vaddio resources page at https://www.legrandav.com/en/tools_and_training/tools/vaddio_tools.
- For muting and volume control, use the Audio page of the host device's web interface.

About Dante Technology and Devices

Audinate Pty. Ltd (www.audinate.com) provides the latest information, training, and documentation for Dante technology on their website. Information in this manual about Dante technology and Audinate products may be out of date.

Things to know about Dante technology and the Dante Controller application:

- **Dante audio does not work over Wi-Fi.**
- Without additional software, **Dante Controller does not work across subnets.** Your computer must be on the same subnet as the Dante devices you need to configure and manage.
- **Default device names and IP addresses shown in Dante Controller do not match the corresponding information shown in Vaddio devices' web interfaces.** The Dante chip in each Dante device has its own IP address and device name. The Dante Controller application uses this information.
- **Dante Controller allows you to rename devices**, so you can make their identifying labels match what's displayed in the Vaddio web interface. We recommend doing this as your first step. We have a saying at Vaddio: the first rule of Dante Club is renaming the device in the Dante controller.

Locating and Renaming Dante Devices

DANTE CONTROLLER APPLICATION

Notes

The Dante chip in each EasyIP device has its own IP address and device name. The host device's name and IP address shown in the Dante Controller application may differ from the hostname and IP address in its web interface.

We recommend renaming your Dante devices as a first step, because renaming the device removes any routing that has been configured on that device.

To physically locate Dante devices using the Dante Controller application:

1. Open the Device Info tab to see the IP address and other information about each Dante device on the subnet that your computer is on.
2. From the main Network View, select Device : Device View. The Device View window opens.
Note that EasyIP devices will show the IP address of the Dante chip, not device's web server IP address.

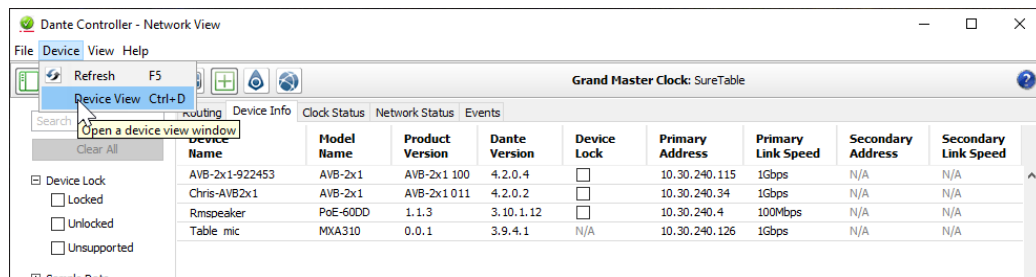

3. In the Device View window, select the device of interest. The window presents information about the device.

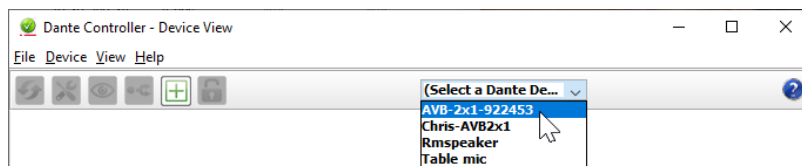

4. Select the Identify icon. The EasyIP microphone responds by blinking its mute light. To stop the identifying behavior, select the Identify icon again.

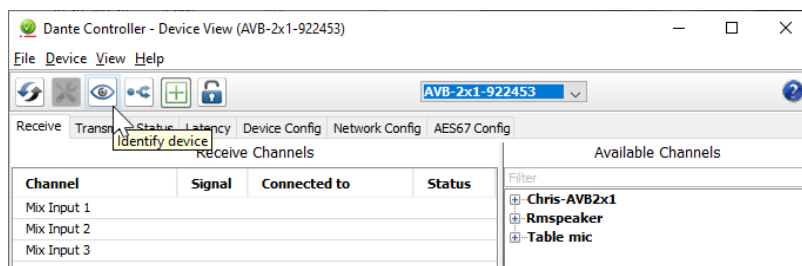

Other ways to access the Identify function:

The host device's Audio page provides an Identify button for EasyIP microphones.

The Vaddio Dante Interface Application includes an Identify button.

To rename a device in the Dante Controller application:

In the Device View window, select the device and go to its Device Config tab. The Rename Device option is near the top of the tab.

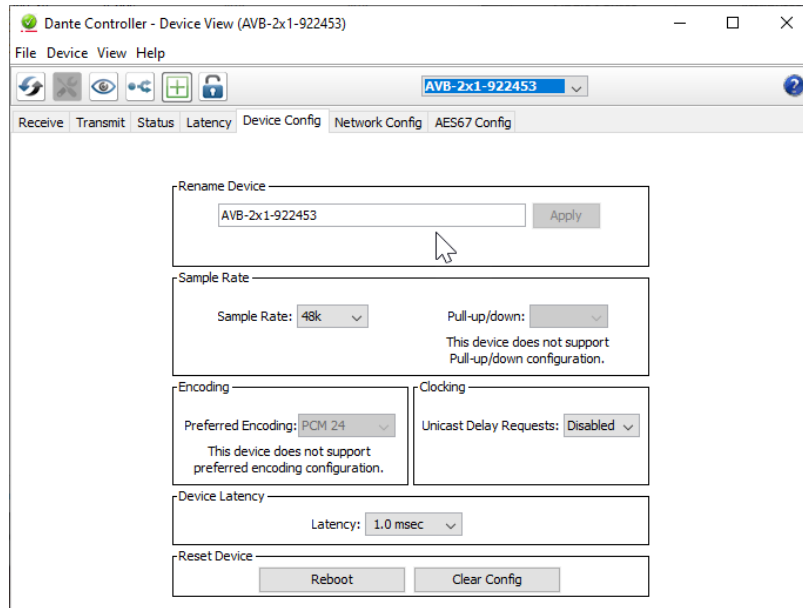

Pairing Audio Devices to the Host Device

Devices using Dante technology may be **transmitters**, **receivers**, or both.

- **Host devices are both:** they receive audio from the microphone(s) and transmit audio to speakers and amplifiers. They also transmit the AEC reference signal to the microphone(s).
- **Microphones are both:** they originate an audio signal and transmit it to the EasyIP host device, and they receive the AEC reference signal for acoustic echo cancellation.
- **Speakers are receivers:** they receive an audio signal from the EasyIP host device.
- **Amplifiers are receivers:** they receive an audio signal from the EasyIP system, which they convert to a signal for an analog speaker.

Follow these steps to pair network-connected audio devices to the host device.

Note

Because the EasyIP CeilingMIC/AMP D houses two separate devices that are not directly connected to the host device (an EasyIP Mixer in the diagram above), the microphone and amp must both be paired to the device in order to operate.

If you need to pair more than two microphones to the host device, see [Using More than Two EasyIP Microphones with a Vaddio Host Device](#).

To pair EasyIP audio devices to the host device:

1. From the main Network View, select Routing.
2. Use the matrix to pair Dante receivers and transmitters to the host device, which is both a receiver and a transmitter.

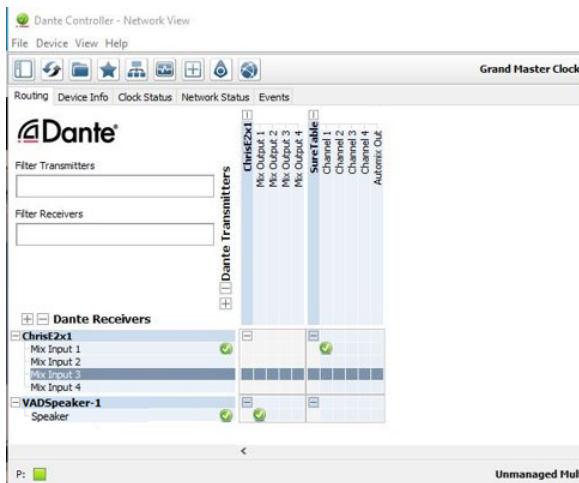

In this example, the receiver "Speaker" is routed to Dante output 1 of the device "ChrisE2x1". The transmitter "Table" (a tabletop microphone) is routed to the device's Dante input 1.

Using More than Two EasyIP Microphones with a Vaddio Host Device

In the examples that follow, we're working with a system that uses four Dante-connected microphones and a Dante-connected speaker. The system in the screen shots uses an AV Bridge 2x1; the way it's configured in the Dante Controller application is exactly the same as it would be for EasyIP host devices. Your devices will be labeled differently from the devices in these screen shots.

For this configuration to work properly, we will need to do these things:

- *Route audio from the host device to the speaker, and route the same audio to the microphones as their AEC reference.* In the example set-up, this audio channel needs to be transmitted to five devices. To allow the signal to go to five places, we will need to **set up a multicast flow**.
- *Create two flows to route audio from the microphones back to the host device.* Although the AV Bridge 2x1 has four Dante input channels, it is limited to two transmit flows and two receive flows. This is also true of the EasyIP Mixer. We will need to **combine the four microphone channels into two flows**.

About Channels and Flows

- A **channel** in a Dante environment is the same thing it would be in other environments: a signal from a single source.
- A **flow** in a Dante environment is one to four channels that can be routed from device to device. Channels remain separate within the flow. For example, left and right audio channels can be part of the same flow.
- By default, flows are **unicast** – they can only be routed to one receiving device.
- If a channel needs to be routed to more than one device, the flow containing that channel needs to be **multicast**. A multicast flow goes to all the receiving devices. Each device subscribes only to the channel it needs to receive.

This manual only covers the very most basic information about working with Dante products; Audinate Pty. Ltd. provides a great deal of useful information on their website. Please visit www.audinate.com/learning for documentation, tutorials, white papers, and more.

Creating a Multicast Flow

DANTE CONTROLLER APPLICATION

To allow one audio channel from the host device to go to the speaker and also serve as the AEC reference signal that goes to the four microphones in our example set-up, define a multicast flow containing only that channel.

To define the multicast flow:

1. Select Device : Device View, and go to the Transmit tab.
2. Select the Multicast icon (labeled 1 in this screen shot).
3. Select the output from the host device. In this case we're using Mix Output 1.
4. Select Create.

Now Mix Output 1 is available to every device that can receive it – the speaker and the four microphones. These devices will only use the channel in the multicast flow if it is routed to them.

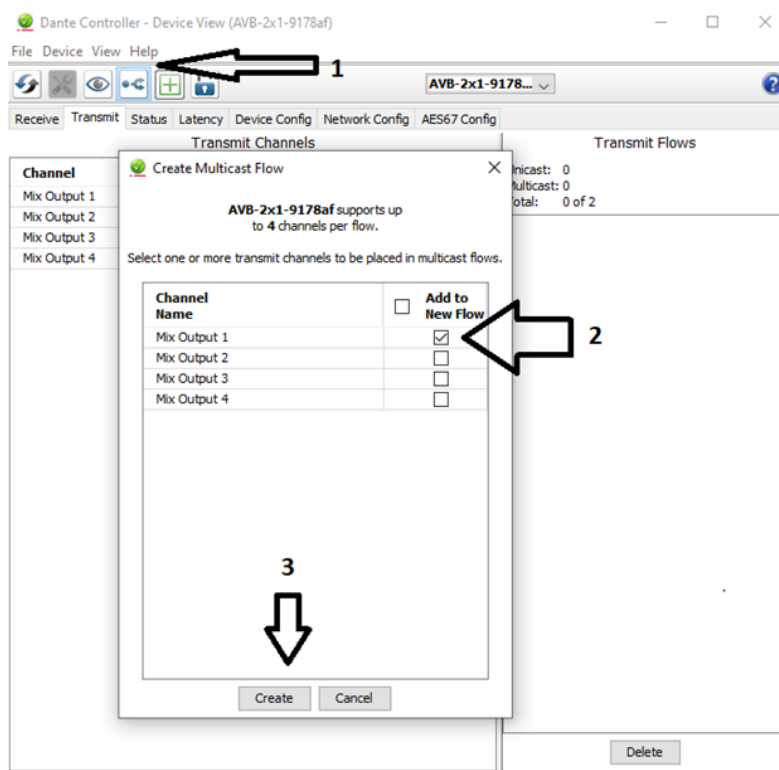

Combining Channels into Flows

DANTE CONTROLLER APPLICATION

The EasyIP Mixer or AV Bridge 2x1 can only receive two Dante audio flows. Each EasyIP microphone provides a pass-through channel as well as its own audio channel, so one microphone can be routed to another, which creates a flow with two microphone channels that can be routed to the host device. Think of it as daisy-chaining the microphones, but without the cable.

In the screen shot below, locate the microphones in the Dante Receivers column. Each receives its AEC reference from the Mix Output 1 channel that we set up as a multicast flow. Microphone EasyIP-1 also receives a pass-through channel from microphone EasyIP-3; microphone EasyIP-2 receives a pass-through channel from microphone EasyIP-4.

Each of the host device's four Mix Inputs receives the channel from the corresponding microphone, but the four channels are all coming from microphones EasyIP-1 and EasyIP-2.

The screenshot shows the Dante Controller interface with the following components:

- Grand Master Clock:** AVB-2x1-9178af
- Routing Tab:** Active, showing a routing matrix.
- Transmitters:** AVB-2x1-9178af (1..4), EasyIP-1 (1..2), EasyIP-2 (1..2), EasyIP-3 (1..2), EasyIP-4 (1..2), and Speaker (1..4).
- Receivers:** AVB-2x1-9178af (1..4) with Mix Input 1-4; EasyIP-1 (1..2) with AEC Reference passthrough; EasyIP-2 (1..2) with AEC Reference passthrough; EasyIP-3 (1..2) with AEC Reference passthrough; EasyIP-4 (1..2) with AEC Reference passthrough; and Speaker (1..4) with Output 1, NA, NA, NA.

Receiver	AVB-2x1-9178af 1..4	EasyIP-1 1..2	EasyIP-2 1..2	EasyIP-3 1..2	EasyIP-4 1..2	Speaker 1..4
Mix Input 1		✓				
Mix Input 2			✓			
Mix Input 3				✓		
Mix Input 4					✓	
AEC Reference passthrough		✓			✓	
AEC Reference passthrough		✓				✓
AEC Reference passthrough		✓				
AEC Reference passthrough		✓				
Output 1	✓					
NA						
NA						
NA						

To route four microphones as two flows:

1. Decide which two microphones will be routed directly to the host device, and carry the passthrough audio from the other two microphones. In our example, it's EasyIP-1 and EasyIP-2.
2. Go to the Network View and select the Routing tab.
3. Look under Dante Receivers to find the **passthrough** row for each of these two microphones. Read across the Dante Transmitters to find the EasyIP Microphone column for the microphone originating the signal that will pass through, and select the box where they intersect.

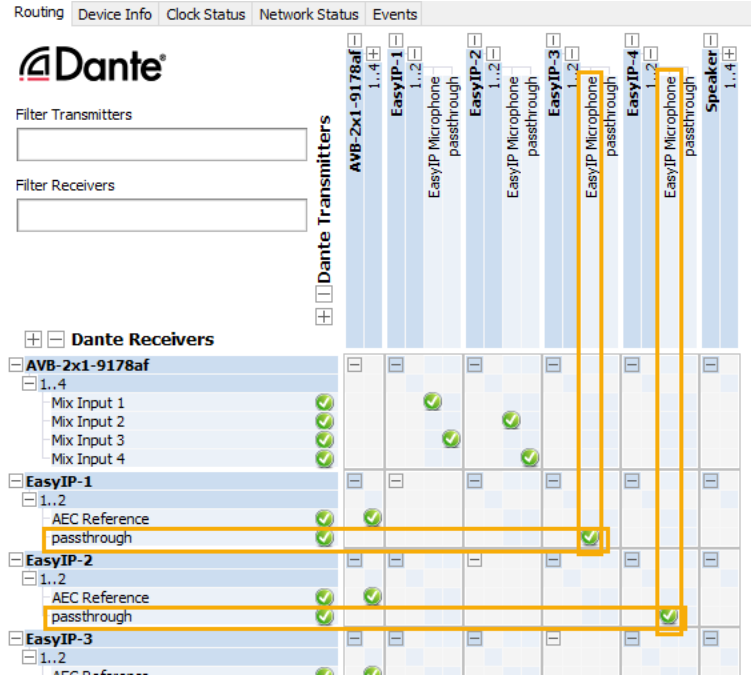

4. Find the rows for the host device's Dante inputs. In this example, it's Mix Input 1 through Mix Input 4 of AVB-2x1-9178af. Read across the Dante transmitters to find the two microphones receiving passthrough channels.
5. For each Mix Input, select the box where the Mix Input row intersects with either the EasyIP Microphone channel or the passthrough channel, to route each microphone to the desired input.

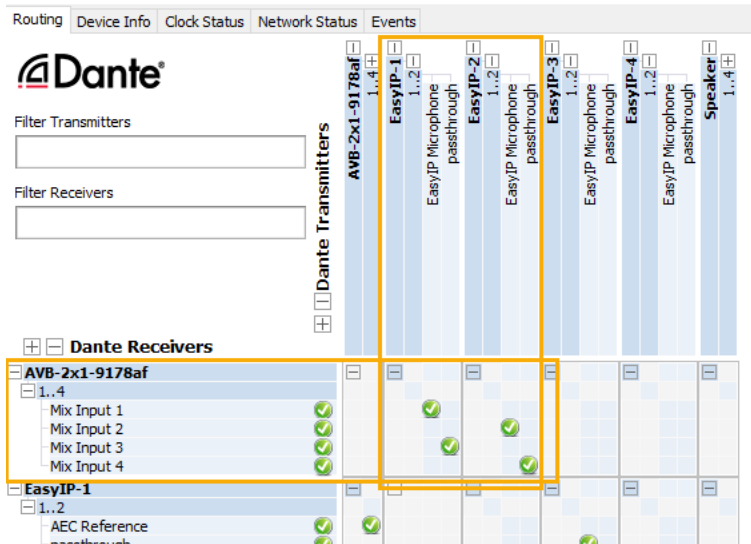

Working with EasyIP Microphones

To fine-tune EasyIP microphones, you will need the free Vaddio Dante Interface Application. The Audio page of the host device’s web interface provides volume controls and muting for individual microphones.

About the Vaddio Dante Interface Application

EasyIP and Dante technologies use differing communication protocols. This means:

- Controls for EasyIP microphones and speakers are not available from the web interface of the EasyIP host device. .
- The Vaddio Deployment Tool does not recognize EasyIP microphones and speakers as Vaddio devices.

To work with EasyIP microphones or speakers, you will need the Vaddio Dante Interface Application, which provides access to microphone and speaker adjustments and firmware update capability. This is available as a free download from the Vaddio resources page at https://www.legrandav.com/en/tools_and_training/tools/vaddio_tools. We update this tool with new features and enhancements from time to time. Please be sure you have the latest version.

Things to know about the Vaddio Dante Interface Application:

- The application only detects EasyIP microphones and speakers.
- The application does not scan across subnets. To use it, your computer must be on the same subnet as the microphones and speakers.

Note

The Vaddio Dante Interface Application has been updated to allow you to disable/enable the Mute button and audio meter on tabletop microphones. Some of the screen shots in this section are from an older version and do not reflect this enhancement.

Fine-Tuning EasyIP Microphone Performance

When you open the Vaddio Dante Interface Application, it displays the IP addresses of the EasyIP microphones on the subnet that your computer is on. Select a microphone to enable its controls.

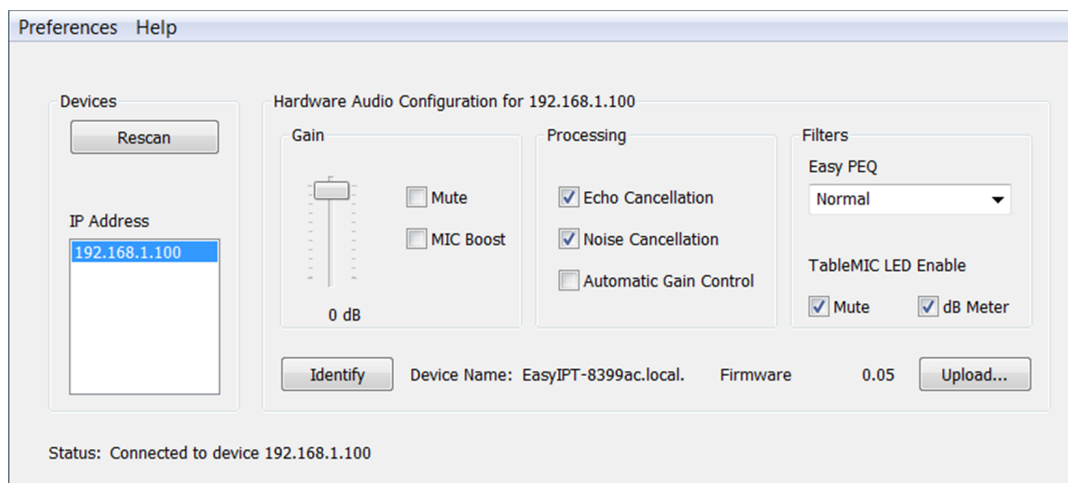

The adjustments and settings are generally the same as for the EasyMic family CeilingMIC and TableMIC microphones.

Presentation Adjustments

VADDIO DANTE INTERFACE APPLICATION

You may need to adjust the microphones for the participants.

To accomplish this...	Do this
Help participants hear the person who is speaking.	Select the Mic Boost processing option to increase microphone gain overall. Use the slider to set the gain. From the Easy PEQ menu, select Speech Enhancement to increase gain in the frequency range for speech.
Automatically adjust for differences in volume as different people speak	Enable Automatic Gain Control for the appropriate microphone.

Performance Adjustments

VADDIO DANTE INTERFACE APPLICATION

You may need to adjust the microphones to suit the room. Echo cancellation and noise cancellation are on by default; we recommend leaving them on.

To correct this...	Do this
Reverberant room	From the Easy PEQ menu, select Reverberant Room.
Noisy environment	From the Easy PEQ menu, select Ambient Noise to reduce gain in the frequencies above and below the normal speech range.
Participants may be seated beyond the microphones' optimum pick-up range	From the Easy PEQ menu, select Speech Enhancement to increase gain in the frequency range for speech. Select the Mic Boost processing option to increase microphone gain overall.

The screenshot displays the 'Hardware Audio Configuration' window for the device at IP 192.168.1.127. On the left, the 'Devices' panel shows the IP address and a 'Rescan' button. The main configuration area is divided into four sections: 'Gain' with a slider set to 0 dB and checkboxes for 'Mute' and 'MIC Boost'; 'Processing' with checkboxes for 'Echo Cancellation', 'Noise Cancellation', and 'Automatic Gain Control'; and 'Filters' with an 'Easy PEQ' dropdown menu currently showing 'Normal'. At the bottom, the 'Identify' button is visible, along with the device name 'EasyIP-828037.local' and firmware version '1.03'. The status bar at the very bottom reads 'Status: Connected to device 192.168.1.127'.

Installing a Firmware Update for an EasyIP Microphone

VADDIO DANTE INTERFACE APPLICATION

You will need the **Vaddio Dante Interface Application** to update EasyIP microphone firmware. When you open the Vaddio Dante Interface Application, it displays the IP addresses of the EasyIP microphones on the subnet that your computer is on.

To update EasyIP microphone firmware:

1. Download the firmware and release notes. Microphone firmware is available on the microphone product page.
2. Open the Vaddio Dante Interface Application if you have not done so already.
3. Select the microphone to update.

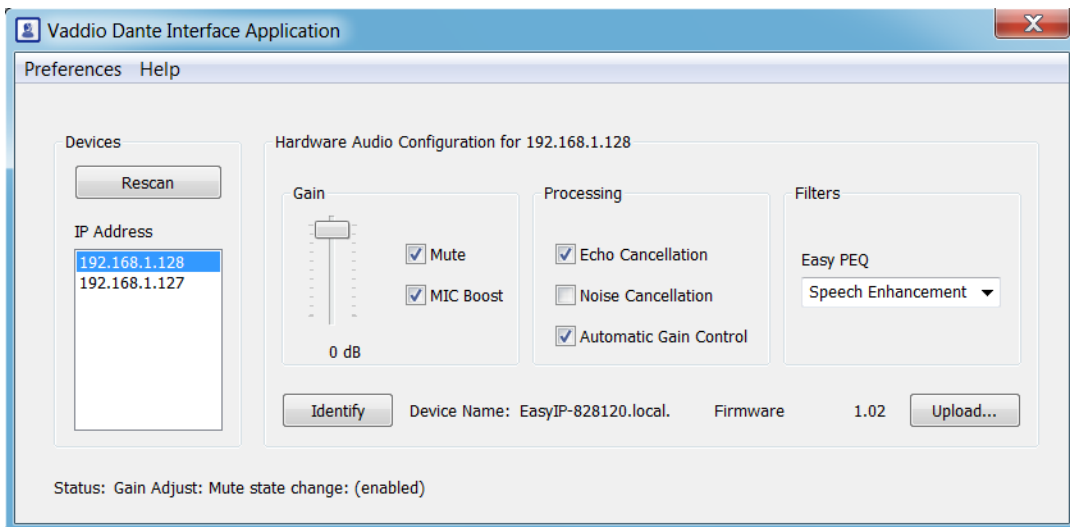

4. Select Upload and navigate to the firmware file.
Do not disconnect the microphone while the progress bar is displayed.

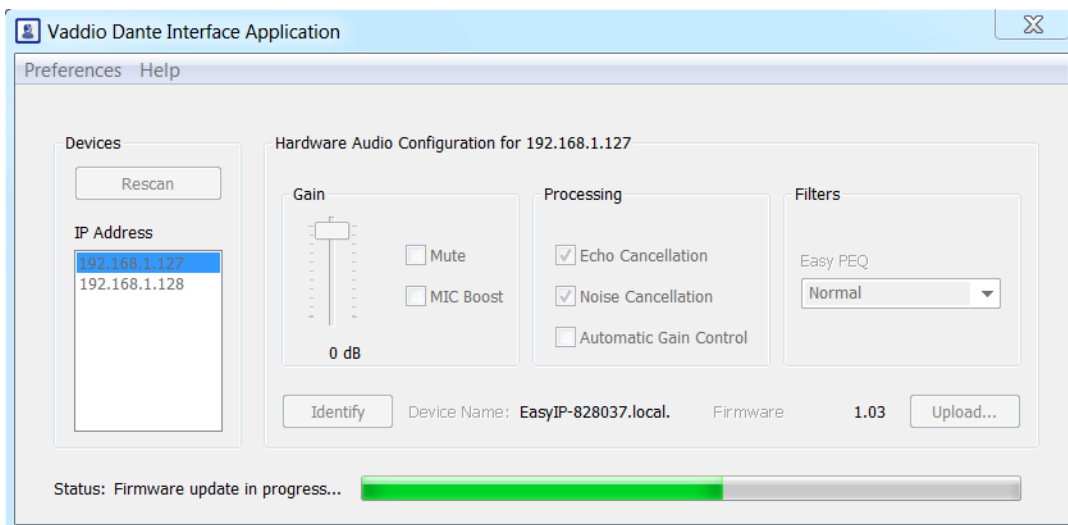

Troubleshooting

What is it doing?	Possible causes	Check and correct
The microphone is unresponsive.	The drop cable is not fully seated at one end, or is bad.	Check the cable for correct pin-out and continuity.
	The cable from the ceiling box to the PoE+ switch is not connected, or is bad.	Verify that the cable is connected to the switch.
The connected speaker is unresponsive.	The cable from the ceiling box to the speaker is not fully seated at one end, or is bad.	Check the cable for correct pin-out and continuity.
	The amp is not paired to the host device.	Use the Dante Controller application to pair the amp with the host device.
The Dante Controller application cannot locate the microphone or the amp	The cable from the ceiling box to the EasyIP Switch is not fully seated at one end, or is bad.	Check the cable for correct pin-out and continuity.
The Vaddio Deployment Tool cannot locate the microphone or the amp.	EasyIP audio devices are not available through the Vaddio Deployment Tool.	Use the Vaddio Dante Interface Application to locate the microphone.
Participants at the far end report no audio.	The microphone is muted.	If the indicator light on the microphone is on, it is muted. Unmute it from the device that controls it.
	The microphone is not paired to the host device.	Use the Dante Controller application to pair the microphone with the host device.

Use, Storage, and Care

Keep this device away from food and liquids. Do not attempt to take this product apart. There are no user-serviceable components inside. Do not operate or store the device under any of the following conditions:

- Temperatures above 104° F (40° C) or below 32° F (0° C)
- High humidity, condensing or wet environments
- Inclement weather
- Severe vibration
- Inside a particle accelerator
- Dry environments with an excess of static discharge

Vaddio is a brand of Legrand AV Inc. · www.legrandav.com · Phone 800.572.2011 / +1.763.971.4400 · Fax +1.763.971.4464 · Email av.vaddio.techsupport@legrand.com

Vaddio is a registered trademark of Legrand AV Inc. Audinate[®], the Audinate logo and Dante[®] are registered trademarks of Audinate Pty Ltd. All other brand names or marks are used for identification purposes and are trademarks of their respective owners. All patents are protected under existing designations. Other patents pending.

©2022 Legrand AV Inc.

VADDIO[®]

A brand of  **legrand[®]**