

Installing CeilingMIC and EasyIP CeilingMIC D Overhead Microphones

This guide contains only the information required to install this product. Refer to the **Complete Manual for CeilingMIC and EasyIP CeilingMIC D Overhead Microphones** for additional product information, compliance statements, and warranty information.

Overview

This manual covers:

- **CeilingMIC** Conference Room Microphone (worldwide) – 999-85100-000 (white); 999-85150-000 (black)
- **EasyIP CeilingMIC D** Overhead Microphone with Dante Networked Audio (worldwide) – 999-85810-000 (white); 999-85820-000 (black)



What's in the Box

Make sure you received all the items you expected.

CeilingMIC conference room microphone (worldwide) – 999-85100-000 (white); 999-85150-000 (black)

- In-ceiling interface box
- Microphone body and strain-relief boot (white or black)
- Tile brace
- Trim plates, qty. 2, with mounting hardware (white or black)
- Drop-down cable (white or black)
- Small zip-tie
- Strain relief clamp
- Split grommet

EasyIP CeilingMIC D network-connected overhead microphone (worldwide) – 999-85810-000 (white); 999-85820-000 (black)

- In-ceiling interface box
- Microphone body and strain-relief boot (white or black)
- Tile brace
- Trim plates, qty. 2, with mounting hardware (white or black)
- Drop-down cable (white or black)
- Small zip-tie
- Strain relief clamp
- Split grommet

Contact Vaddio Technical Support if you did not receive all the items listed.

Find full product documentation on the applicable product page(s) at legrandav.com.

Features

The CeilingMIC offers the great features and performance you expect from the EasyMic family of microphones.

The EasyIP CeilingMIC D provides the same capabilities plus Dante connectivity.

- Three-element design with improved geometry for 360° coverage and better audio pick-up
- Built-in digital signal processor (DSP)
- Easy access to the microphone cable connector
- Designed for customizable ceiling drop cable length
- EasyIP CeilingMIC D only: Dante networked audio
- CeilingMIC only: Vaddio EasyMic connectivity

Installation

This section covers:

- Safety information
- Tips for a successful audio installation
- Tools you will need
- Cabling notes
- Installing the CeilingMIC
- Connection diagrams

Safety Information

Warning

Follow standard safety practices when using ladders or lifts. Failure to do so can result in injury or death.



Note

All above-ceiling work must conform to local building codes and should be performed by qualified personnel.

Preparing for a Successful Audio Installation

Here are a few tips for avoiding common audio problems.

- The effective range for each Vaddio conference room microphone is about 12 ft. (3.7 m) under most circumstances. Be sure the room design includes enough microphones to provide adequate coverage.
- Because of its geometry, the overhead microphone is less sensitive in a small area directly below it. In a small to medium corporate conference room, it may make sense to suspend the microphone(s) above the centerline of the conference table.
- To prevent audio feedback, keep microphones at least 4 ft. (1.2 m) from speakers. More separation is better.
- Place microphones closer to the people talking than to the room's speakers. This helps maintain quality echo cancellation.
- Do not route microphone cables across or beside fluorescent light fixtures. Electrical interference from the ballasts may degrade the audio signal.
- Mount the overhead microphone away from air vents, to avoid picking up the sounds of the HVAC system.

Tools You Will Need

To install the overhead microphone, you will need:

- Hole saw for the appropriate type of ceiling
- #2 Phillips screwdriver
- Wire cutters
- Tape measure
- Ladder or lift
- Appropriate personal protective equipment

Don't Void Your Warranty!

Caution

This product is for indoor use. Do not install it outdoors or in a humid environment without the appropriate protective enclosure. Do not allow it to come into contact with any liquid.

Do not install or operate this product if it has been dropped, damaged, or exposed to liquids. If any of these things happen, return it to Vaddio for safety and functional testing.

Cabling Notes

Ceiling microphones are shipped with one Cat-5e cable to connect to the interface box.

Caution

When building cables for Vaddio products, do not use pass-through RJ-45 connectors. If they are crimped incorrectly, they can cause intermittent connections and degrade signal quality. Incorrectly crimped pass-through connectors can also damage the connectors on the product, which will void your warranty.



Intact – will make reliable contact with cable connector

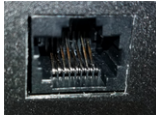

Damaged – Bent contact fingers will NOT make reliable contact with cable connector

Use Cat-5e or better cable. We recommend using high-quality connectors and a high-quality crimping tool.

We recommend shielded cabling if the cables will be coiled, run tightly with other cables, or routed near sources of electromagnetic interference such as power lines or fluorescent light fixtures.

Caution

Check your cables. Connecting a cable to the wrong port or using the wrong pin-out can result in equipment damage and will void the warranty.

Pro Tip

Label all cables at both ends.

Preparing the Ceiling Box

1. Remove the cover from the ceiling box.

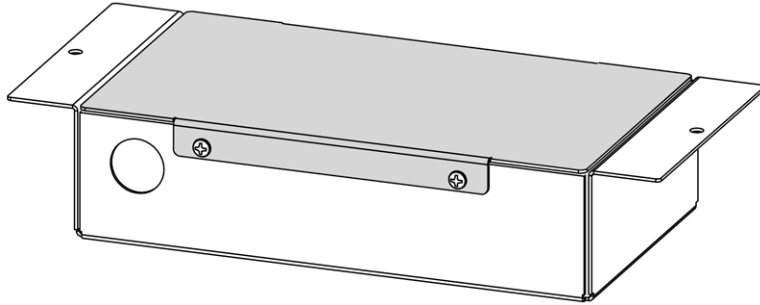

2. Determine the desired length of the drop cable, from the ceiling to the top of the microphone body (not the top of the strain relief boot). Be sure this leaves enough cable inside the ceiling box to avoid placing tension on the connector.

Note

If desired, you can use a Cat-5e cable made to the desired length for the microphone drop-down cable. The cable may be up to 15 ft. (4.6 m); contact Vaddio Technical Support if your installation requires a longer drop cable.

3. Thread the drop cable through the opening in the floor of the box.
4. Snap the strain relief grommet onto the drop cable at the desired cable length, and press it into the opening in the floor of the box.
5. Connect the drop cable to the port labeled IN FROM MIC.
6. If there is excess cable above the grommet, thread a zip tie through the tie loop in the side of the box and secure the cable.

Note

The photo shows the ceiling box for a CeilingMIC. The EasyIP CeilingMIC D has a larger circuit board.



Preparing the Ceiling

Warning

Follow standard safety practices when using ladders or lifts. Failure to do so can result in injury or death.

We like you, we don't want you to be injured or killed, and we hope you understand the gravity of the situation.

If installing in a hard ceiling:

Using the tile brace as a template, make a hole in the ceiling where the microphone will be mounted.

If installing in a suspended tile ceiling:

1. Remove the ceiling tile where the microphone will be mounted, and make a hole in the ceiling tile using the tile brace as a template.
2. Reinstall the ceiling tile and position the tile brace.

Note

Because the microphone assembly weighs very little, the tile brace does not need to be physically attached to the tile support grid unless this is required by local building codes.

Installing the Ceiling Box

Working above the ceiling:

1. CeilingMIC: Route a Cat-5e (or better) cable from the ceiling box to the mixer or other audio device. The cable may be up to 100 ft. (30 m.) long.
EasyIP CeilingMIC D: Route a Cat-5e (or better) cable from the ceiling box to the PoE+ switch. The cable may be up to 100 ft. (30 m.) long.
2. Thread the cable through the opening in the side of the ceiling box.
3. Install the split grommet in the opening in the side of the ceiling box to keep the cable from chafing.
4. Connect the cable to the port labeled OUT TO MIXER.
5. Reinstall the cover on the ceiling box.
6. Thread the drop cable through the opening in the tile brace and ceiling, and place the ceiling box flat.

Connecting the Microphone Body

Working below the ceiling:

1. Connect the drop cable to the port in the microphone body.

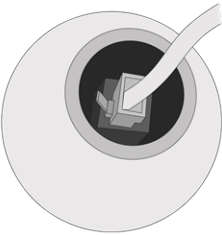

2. Fit the strain relief boot over the drop cable.
3. Fit the strain relief boot into place in the microphone body.
4. Making sure the countersinks face outward, slide both the slotted trim plates over the cable, with the slots on opposite sides. Use the 3/4 inch flat head screws to secure the trim plates to the threaded posts on the bottom of the interface box.

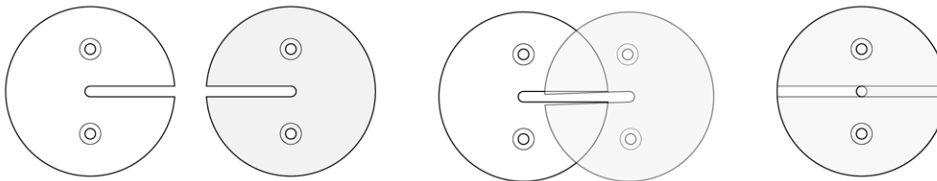

(Illustration shaded for clarity)

Contact Vaddio Technical Support if you have questions or encounter any problems. Phone 800.572.2011 / +1.763.971.4400, email av.vaddio.support@legrand.com.

Basic Connections – CeilingMIC

This is a simple installation for a small conference room, using the CeilingMIC with a ConferenceSHOT AV camera with speaker. In this installation, the CeilingMIC connects to a ConferenceSHOT AV camera with speaker. The camera connects to a computer over a USB 3 connection, making audio and video available to soft conferencing applications.

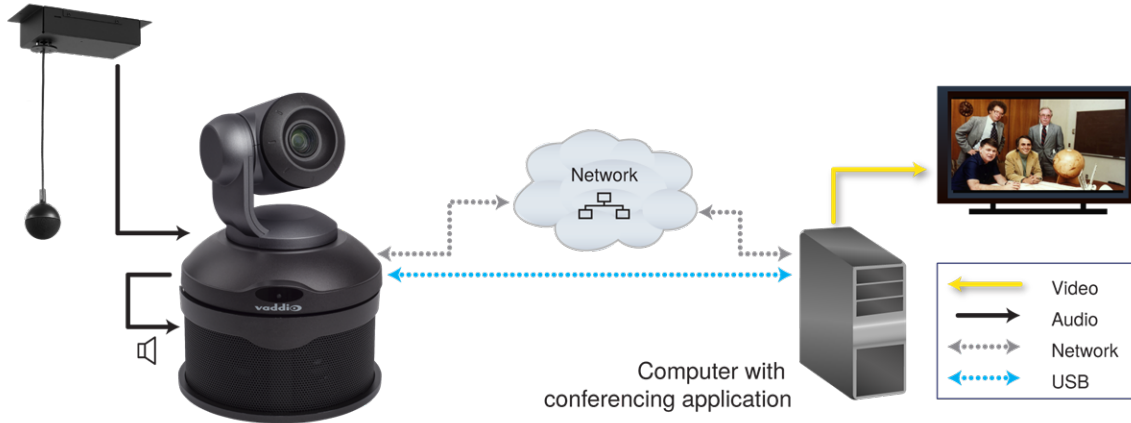

This installation is for a larger room, using an AV Bridge MATRIX PRO to manage the room audio and video. The four CeilingMIC microphones connect directly to EasyMic ports on the AV Bridge MATRIX PRO. The speaker(s) require an amplifier, as shown by the amplifier symbol in the diagram. This system can include multiple cameras.

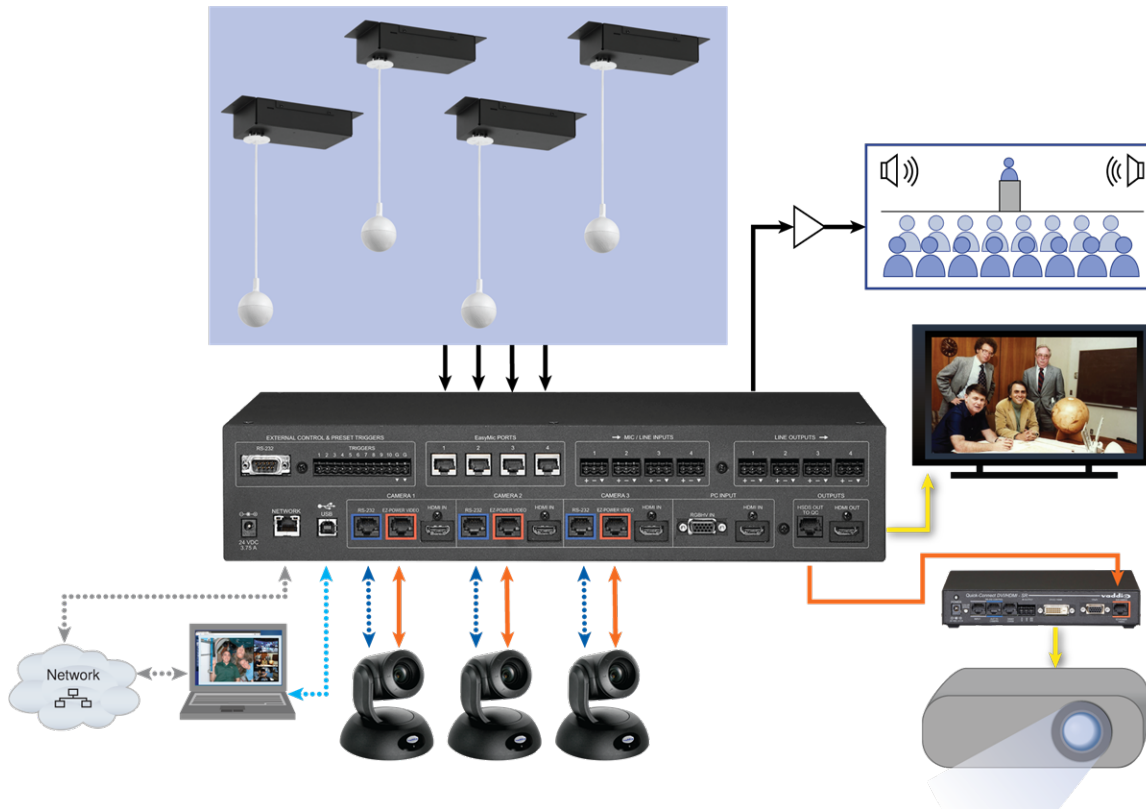

Basic Connections – EasyIP CeilingMIC D

This is a simple installation for a medium to large conference room, using the EasyIP CeilingMIC D with an EasyIP system. In this installation, the EasyIP CeilingMIC D microphones pair to an EasyIP Mixer over the network. The EasyIP Mixer also manages speakers and video, and originates a USB 3 stream, making audio and video available to soft conferencing applications.

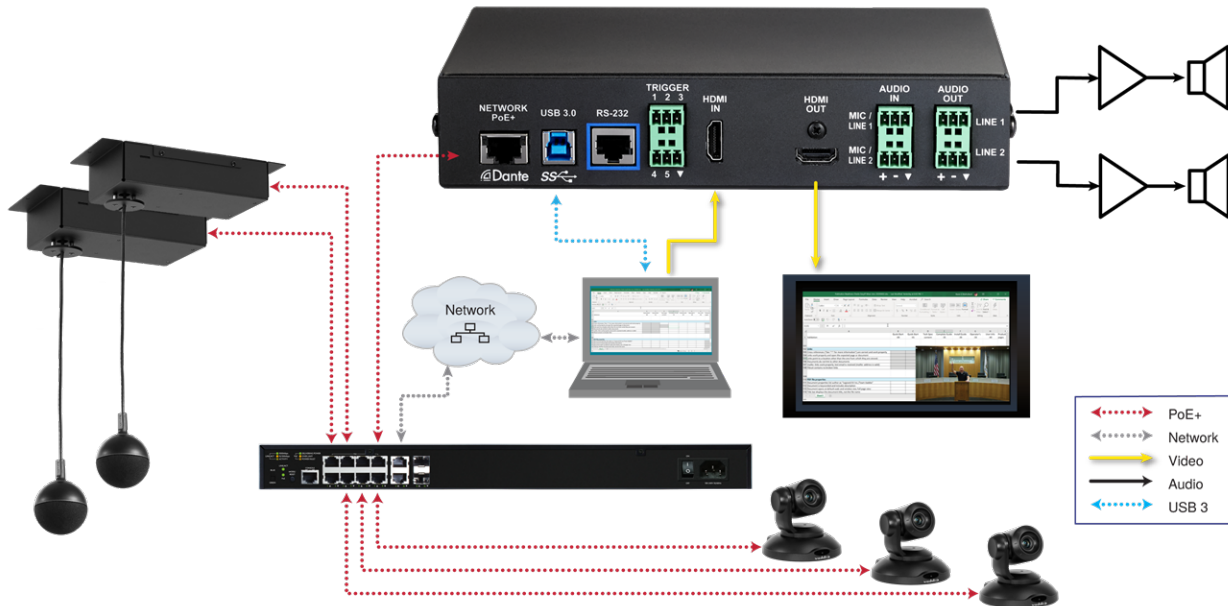

EasyIP CeilingMIC D microphones can also be used with other devices that support Dante connectivity.

Note

Because EasyIP CeilingMIC D microphones are not directly connected to the device that manages them (an EasyIP Mixer in the diagram above), they must be paired to the device in order to operate.

To work with EasyIP CeilingMIC D and other Dante devices, you will need to download and install the free Dante Controller application from Audinate Pty. Ltd.: www.audinate.com/products/software/dante-controller

Things to know about Dante Controller:

- Dante Controller does not work over Wi-Fi or across subnets. Your computer must be on the same subnet as the Dante devices you need to work with.
- Device names and IP addresses shown in Dante Controller do not match the corresponding information shown in devices' web interfaces.

Audinate provides information, training, and documentation for Dante technology on their website.

Use, Storage, and Care

Keep this device away from food and liquids. Do not attempt to take this product apart. There are no user-serviceable components inside. Do not operate or store the device under any of the following conditions:

- Temperatures above 104° F (40° C) or below 32° F (0°C)
- High humidity, condensing or wet environments
- Inclement weather
- Severe vibration
- Dry environments with an excess of static discharge

Do not let cats play with overhead microphones, as their claws could snag the fabric.

Vaddio is a brand of Legrand AV Inc. · www.legrandav.com · Phone 800.572.2011 / +1.763.971.4400 · Fax +1.763.971.4464 · Email av.vaddio.support@legrand.com

Visit us at www.legrandav.com for firmware updates, specifications, drawings, manuals, technical support information, and more.

©2020 Legrand AV Inc.

Vaddio is a registered trademark of Legrand AV Inc. Audinate®, the Audinate logo and Dante® are registered trademarks of Audinate Pty Ltd. All other brand names or marks are used for identification purposes and are trademarks of their respective owners. All patents are protected under existing designations. Other patents pending.

A brand of  legrand®

Commercial AV Brands Chief | Da-Lite | Middle Atlantic | Projecta | Vaddio

vaddio®