



Complete Manual for the

ConferenceSHOT AV

Enterprise-Class Conferencing System

Document 411-0001-30 Rev G
November 2020

Contents

Overview	1
What's in this Guide	1
Features	1
Unpacking the Conferencing System	2
A Quick Look at the System	3
Front of the Camera and Speaker	3
Back of the Camera	4
Back of the Speaker	4
Installation	5
Don't Void Your Warranty!	5
Before You Install the Camera	5
Cabling Notes	6
Pre-Installation Functional Check	7
Status Indicator Light	8
About Ceiling-Mounted Cameras	8
About Echo Cancellation	8
Installing the Wall Mount	9
Basic Connections	9
Installing the Camera without the Speaker	11
Installing the Camera and Speaker	12
Powering Up the System	13
Initial Device Set-Up and System Administration Tasks	14
Browser Support	14
Initial Device Set-up Process Overview	14
Initial Device Set-Up Using the Vaddio Device Controller	15
Initial Device Set-Up Using the Vaddio Deployment Tool	16
Manual Access and Initial Device Set-Up	18
Getting the Camera's IP Address for Access via Browser	18
If the Camera Is At 169.254.1.1	19
Initial Access to the Web Interface	19
Completing the Initial Device Set-up	21
Web Interface Quick Reference	21
User or Guest Access – Camera Page	21
Administrative Pages	22
System Administration	23
Setting Passwords and Access	23
Configuring Other Security Settings	24
Enabling Telnet Access	24
Enabling HTTP Access	24
Installing an SSL Certificate	25

Configuring the Camera for Your Network	25
Configuring the Device with a Static IP Address	26
Changing the Camera's Hostname	27
Specifying Time Zone and NTP Server	28
Adding Room Information to the Camera's Web Interface	28
Configuring Camera Behavior	29
Setting the Home Position and Other Preset Shots	29
Renaming Presets	31
Adjusting Color, Lighting, and Image Quality Settings	32
Lighting and Image Quality Quick Reference	33
Color Adjustment Quick Reference	33
Adjusting the Focus	34
Speed Adjustments	35
Setting the Speeds for Manual Movements	35
Setting the Speeds of Movements to Presets	36
Setting the Direction for Camera Movements	37
Managing Audio	38
Muting All Audio Inputs Together	38
Controlling Volume and Muting Per Input or Output	38
Fine-Tuning Microphone Performance	39
Setting the Microphone's One Touch Button Behavior	39
Fine-Tuning Speaker Performance	40
Configuring Streaming Behavior	41
Viewing the USB Stream	41
Configuring USB Streaming	42
Enabling or Disabling IP Streaming	42
Viewing the IP Stream (RTSP)	43
RTSP Streaming Protocol and URL	43
Setting up IP Streaming in Easy Mode	44
Setting up IP Streaming in Custom Mode	45
Configuring RTMP Streaming	46
Changing MTU	47
Setting up Custom Functions and Third-Party Control	48
Writing and Editing Macros	49
Testing Macros	50
Assigning Macros to Triggers	51
Testing Triggers	52
Example: Assigning a Function to the Connected Microphone's Home Button	52
Additional Camera Settings	53
Indicator Light and Standby Behavior	54
System Maintenance	55

Saving (Exporting) or Restoring (Importing) a Configuration	55
Installing a Firmware Update	57
Installing a Firmware Update for a Connected Microphone	58
Rebooting the Camera	59
Contacting Vaddio Technical Support	60
Viewing Diagnostic Logs	61
Using the Remote Control	62
Quick Reference	62
IR Remote Details	63
Storing a Preset Using the Remote	63
Clearing a Preset Using the Remote	63
Operating the Camera from the Web Interface	64
Stopping or Resuming Video	64
Managing the Camera Ready State	65
Muting Your Microphones	65
Adjusting Speaker and Microphone Volume	65
Moving the Camera	66
Zooming In or Out	66
Moving the Camera to a Preset Position	66
Telnet Serial Command API	67
Camera and Video Management Commands	68
camera home	68
camera pan	69
camera tilt	70
camera zoom	71
camera ptz-position	72
camera focus	73
camera preset	74
camera ccu get	75
camera ccu set	76
camera led	77
camera icr	77
video mute	78
Audio Commands	79
audio volume	79
audio mute	80
Control and Power Commands	81
trigger	81
camera standby	81
Network and Communication Commands	82
streaming ip enable	82

streaming settings get	83
network settings get	84
Maintenance and Troubleshooting Commands	85
camera recalibrate	85
network ping	85
system reboot	86
system factory-reset	86
version	87
Telnet Information and Session Management Commands	88
history	88
help	88
exit	88
Specifications	89
Troubleshooting and Care	90
Power and Control	90
Video and Streaming	90
Audio	91
Other Issues	91
Status Indicator Light	92
Correct a Motor Calibration Error	92
Restoring Default Camera Settings	93
Operation, Storage, and Care	93
Glossary	94
Compliance and Conformity Statements	98
FCC Part 15 Compliance	98
ICES-003 Compliance	98
European Compliance	99
Photo Credits	100
Index	101

Overview

This guide covers the ConferenceSHOT AV system – a camera and detachable speaker available in black or white, available individually or in conference room bundles.

ConferenceSHOT AV Camera

- North America – 999-9995-000B (black), 999-9995-000W (white)
- Europe and UK – 999-9995-001B (black), 999-9995-001W (white)
- Australia and New Zealand – 999-9995-009B (black), 999-9995-009W (white)

This camera is no longer available in silver/black.



ConferenceSHOT AV Speaker

- Worldwide – 999-9995-003 (black)
- Worldwide – 999-9995-003W (white)

The ConferenceSHOT AV camera and speaker are also available in bundles that include other audio accessories.

Refer to legrandav.com for the latest information on ConferenceSHOT AV product bundles.

What's in this Guide

This guide covers

- Unpacking
- Physical features
- Installation
- Initial set-up and system administration
- Performance/behavior configuration
- System maintenance
- Operation
- Telnet API reference
- Specifications
- Troubleshooting
- Compliance/conformity information

For your convenience, the information you need to install this product is also available in the smaller, stand-alone **Installation Guide for ConferenceSHOT AV Enterprise-Class Conferencing Systems**.

Features

- Integrated HD camera and audio system ideal for small to medium conference rooms
- 10x optical zoom, horizontal field of view of 74° in super-wide mode
- 2.14 Megapixel effective, native 1080p/60 full HD image sensor
- Audio inputs for two Vaddio microphones
- Audio output for optional matching speaker – or integrate into existing audio infrastructure
- Simultaneous uncompressed USB 3.0 and IP (H.264) video with full-duplex audio streaming
- Selectable IP stream resolution; USB stream resolution auto-negotiated with conferencing client
- Precise pan and tilt movements at up to 90° per second
- Universal Video Class (UVC) and Universal Audio Class (UAC) drivers supported in Windows®, macOS®, and Linux operating systems, compatible with most UC conferencing applications
- Integration-ready Telnet control
- Enterprise-class IT administrative capabilities with full web controls for remote management
- Presenter-friendly IR remote control

Unpacking the Conferencing System

Make sure you received all the items you expected. Here are the packing lists for the ConferenceSHOT AV system.

Caution

Always support the camera's body when lifting or moving it. Lifting the camera by its head or mounting arm will damage it.



ConferenceSHOT AV camera

North America: 999-9995-000 (black/silver) or 999-9995-000W (white)

Europe and UK: 999-9995-001 (black/silver) or 999-9995-001W (white)

Australia and New Zealand: 999-9995-009 (black/silver) or 999-9995-009W (white)

- ConferenceSHOT AV camera (silver/black or white)
- Vaddio IR Remote Commander
- PoE+ mid-span power injector with AC cord set(s)
- Cat-5e cable, 10 ft (3 m)
- USB 3.0 cable, 6 ft (1.8 m)
- 4-contact Phoenix-style connector
- Thin Profile Wall Mount with mounting hardware

ConferenceSHOT AV speaker

All locales: 998-9995-003 (black) or 998-9995-003W (white)

- ConferenceSHOT AV speaker
- Rail mount kit (mounts to the camera or the camera mount)
- Power/audio cable, 6 in. (15 cm)

For bundle contents, refer to the ConferenceSHOT AV product pages on legrandav.com.

A Quick Look at the System

This section covers the physical features of the system.

Front of the Camera and Speaker



Camera and zoom lens – The ConferenceSHOT AV camera features a 10X optical zoom lens (11X in Super-Wide mode).

IR sensor – Receives signals from the IR remote. Make sure there's nothing directly in front of the camera base, and point the remote at the camera.

Status light – The multi-colored LED indicates the camera's current state. This light can be turned off in the administrative web interface.

Note

By default, the camera's status indicator light is active during normal operation; however, it can be configured to remain off when the camera is powered up. The camera may be sending video even if the light is off.

Speaker – Far-end conference audio for small rooms. Available in some ConferenceSHOT AV bundles or separately.

Back of the Camera



- **Network PoE+** – RJ-45 connector. Connect to the network and to power via the Power and Data Out port of the mid-span PoE+ power injector. Provides power and network access for IP streaming and camera control via web interface or Telnet.
- **USB 3.0** – USB type B connector. Connect to a computer for use with soft conferencing applications. Provides uncompressed USB 3.0 stream.
- **EasyMic ports** – RJ-45 connectors. Connect Vaddio CeilingMIC, TableMIC, or other EasyMic-compatible microphones.
- **Audio output** – Line level differential audio and 12 VDC power output to the optional amplified speaker or other audio infrastructure.

Back of the Speaker



Use the provided speaker cable to connect the speaker to the camera's audio output.

Installation

This section covers:

- Selecting the location for the camera
- Verifying that the camera is ready to install
- Installing the mount
- Connection diagrams
- Mounting the camera

And a required safety note here:

Note

PoE type networks connected to this equipment are for intra-building use only and should not be connected to lines that run outside of the building in which this product is located.

Don't Void Your Warranty!



Caution

Always support the camera's body when lifting or moving it. Lifting the camera by its head or mounting arm will damage it.

Caution

This product is for indoor use. Do not install it outdoors or in a humid environment without the appropriate protective enclosure. Do not allow it to come into contact with any liquid.

Caution

Do not install or operate this product if it has been dropped, damaged, or exposed to liquids. If any of these things happen, return it to Vaddio for safety and functional testing.

Before You Install the Camera

Things to keep in mind when deciding where to install the camera:

- Consider camera viewing angles, lighting conditions, line-of-sight obstructions, and in-wall obstructions where the camera is to be mounted.
- Ensure that the camera body can move freely and will normally point away from the ceiling and lights. The camera will not perform well if it is pointed toward a light source such as a light fixture or window.
- If the remote will be used, ensure that nothing blocks the IR lens in the camera's base.

Prepare for a successful installation:

- Be sure you can identify all cables correctly.
- Check Cat-5 cables for continuity.
- Talk to the network administrator. If installing the camera in a non-DHCP network (one that does not automatically assign IP addresses), you will need to configure the camera with a static IP address as directed by the network administrator.

Cabling Notes

Caution

When building cables for Vaddio products, do not use pass-through RJ-45 connectors. If they are crimped incorrectly, they can cause intermittent connections and degrade signal quality. Incorrectly crimped pass-through connectors can also damage the connectors on the product, which will void your warranty.



Intact – will make reliable contact with cable connector

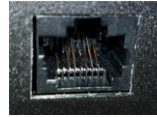

Damaged – Bent contact fingers will NOT make reliable contact with cable connector

Use Cat-5e or better cable. We recommend using high-quality connectors and a high-quality crimping tool. We recommend shielded cabling if the cables will be coiled, run tightly with other cables, or routed near sources of electromagnetic interference such as power lines or fluorescent light fixtures.

Caution

Check your cables. Connecting a cable to the wrong port or using the wrong pin-out can result in equipment damage and will void the warranty.

Pro Tip

Label all cables at both ends.

Pre-Installation Functional Check

If you're installing the camera where it's hard to reach, you may want to verify functionality before you install it.

1. Connect the camera in its minimum functional configuration.



2. Connect power. The camera moves and the indicator light turns blue.
3. Open a media player such as VLC Media Player and view the USB stream (If you use VLC Media Player, this is the "Open Capture Device" option under Media.). The camera is available as a video capture device; the device name is ConferenceSHOT AV.

The screen shots below show how you would access the USB stream using VLC Media Player. In this example, the capture device is a ConferenceSHOT 10 camera. The steps are the same for the ConferenceSHOT AV camera; only the video device name differs.

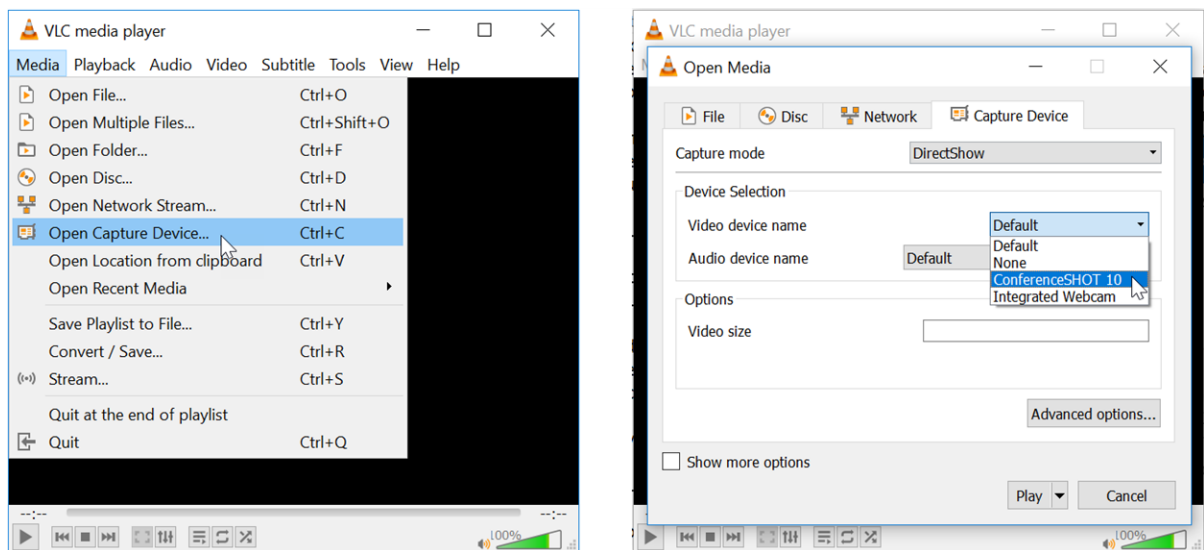

If the camera turns on and sends video, continue with the installation.

Status Indicator Light

The light in the camera's base indicates its current state.

- Blue – Camera is active
- Purple – Standby mode or booting
- Yellow – Firmware update is in progress
- Blinking blue – USB cable is disconnected (UC color scheme)
- Blinking red – Video mute is on (UC color scheme)
- Blinking yellow – Motor out of calibration

Caution

Do not remove power or reset the camera while the indicator is yellow, showing a firmware update in progress. Interrupting a firmware update can make the camera unusable.

Note

By default, the camera's status indicator light is active during normal operation; however, it can be configured to remain off when the camera is powered up. The camera may be sending video even if the light is off.

About Ceiling-Mounted Cameras

If you use an inverted mount, set the camera's Image Flip mode ON for inverted operation. This orients the video image correctly and sets the tilt motors to respond appropriately to tilt up and down commands from the remote, web interface, and connected control devices. This control is available to the administrator on the web interface's System page.

See [Additional Camera Settings](#) for more information.

About Echo Cancellation

When a microphone picks up the audio from a speaker (far-end audio) during a conference, it sends the far-end audio back to the participants at the far end, creating an echo. Acoustic echo cancellation prevents this.

Here's how it works:

1. The speaker feeds the far-end audio into the room. This signal also goes to the audio processor as the reference that needs to be canceled.
2. The audio processor inverts the signal and sends it to the microphone.
3. The sum of the audio that the microphone picks up from the speaker and the inverted signal is 0: The echo is canceled.

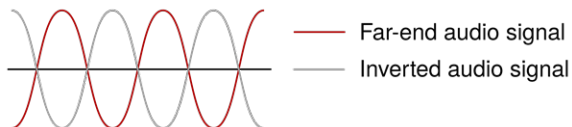

With the audio from the speaker canceled out, the audio from the microphone includes only the sounds originating at your end of the conference.

For the ConferenceSHOT AV system's acoustic echo cancellation to work,

- The line outputs or the powered speaker must be connected to provide the audio to be canceled, and
- The microphone(s) must be connected, to route the audio from the speakers to the audio processor.
- In the soft conferencing client, you must select the speakers and microphone connected to the camera as the conference audio devices.

Installing the Wall Mount

The camera is shipped with a wall mount. Other mounting options are available as well. Contact us if you don't have the camera mount you need.

You can install the camera wall mount to a 2-gang wall box or directly to the drywall.

- If you mount it to drywall, use the wall anchors provided with the wall mount.
- If you mount it to a wall box, use the cover plate screws supplied with the wall box.

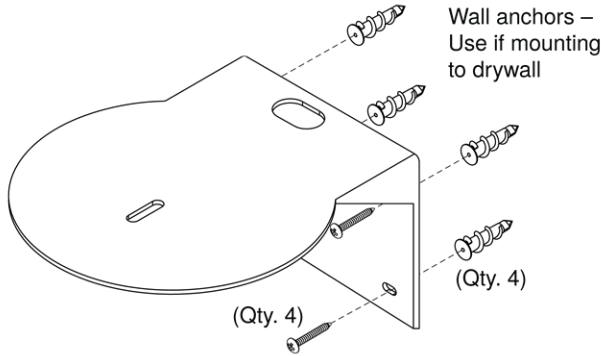

This mount may be installed as shown, or flipped 180° so that the wall attachment is directly behind the camera.

Basic Connections

Here is an example of how the camera might be set up in a medium-size conference room. (Shown: ConferenceSHOT AV bundle – TableMIC 2.) In this setup, a PC uses a unified communications conferencing application to manage the camera and connected microphones and speaker. When connected in this way, the system provides echo cancellation.

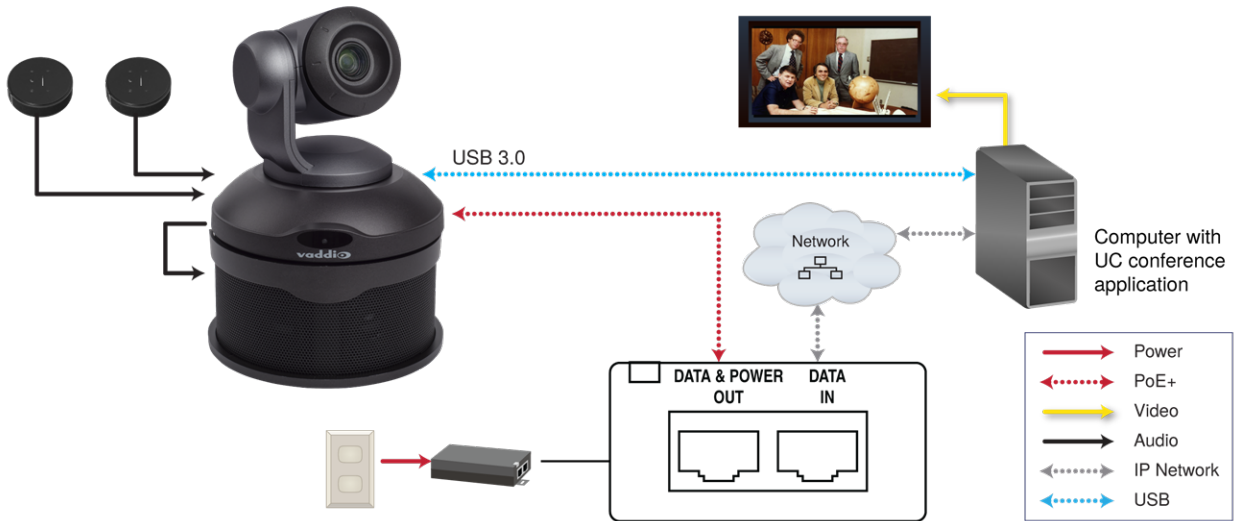

The camera can also be connected without the speaker, using an HDMI audio embedder to include the far-end audio in the HDMI output. (Shown: ConferenceSHOT AV bundle – TableMIC 1 without speaker.) This allows you to use a display with integrated speakers. When connected this way, the system provides echo cancellation.

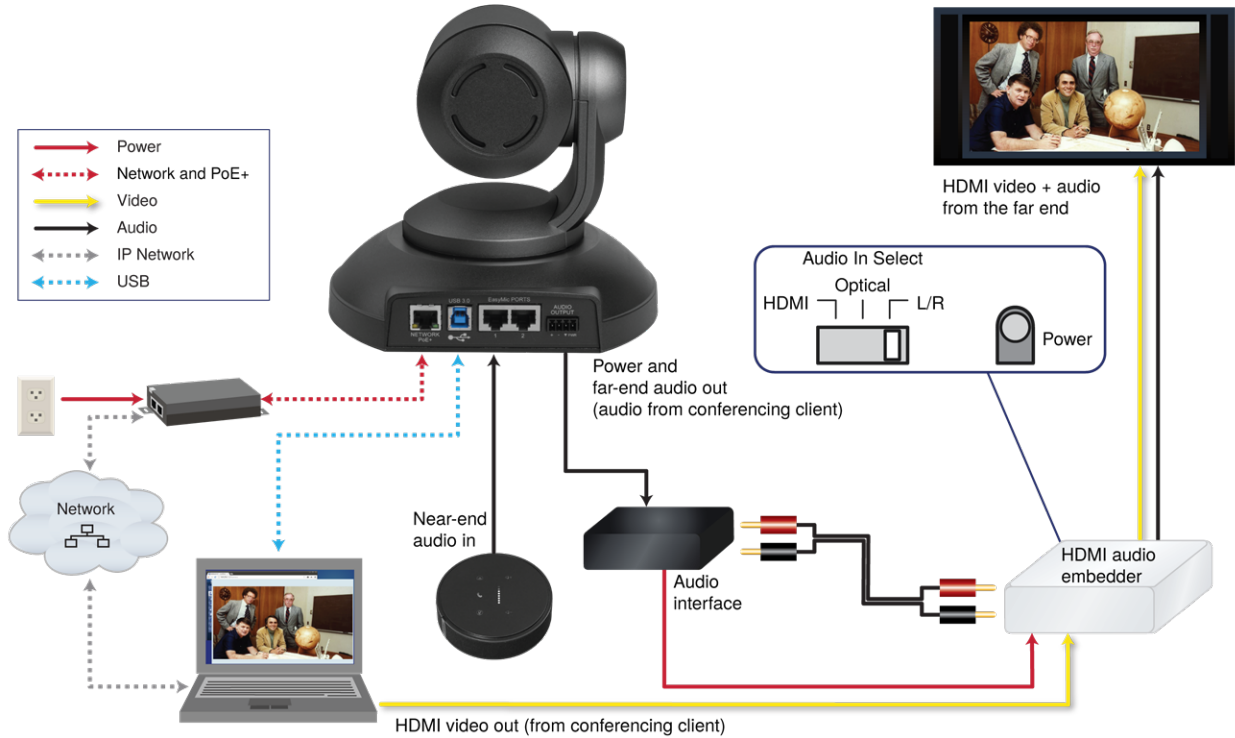

This product is intended for installation and use only in environments where all PoE/PoE+ connections originate within the building. It is not to be connected to lines that run outside the building where it is installed.

Installing the Camera without the Speaker

Caution

Before you start, be sure you can identify all cables correctly. Connecting a cable to the wrong port can result in equipment damage.

Caution

Check your cables. Connecting a cable to the wrong port or using the wrong pin-out can result in equipment damage and will void the warranty.

1. Route the cables through the opening in the mounting shelf.
2. Connect all required cables to the camera.
3. Secure the camera to the mounting shelf using the mounting screw ($\frac{1}{4}$ -20 x .375 in.) supplied with the camera.

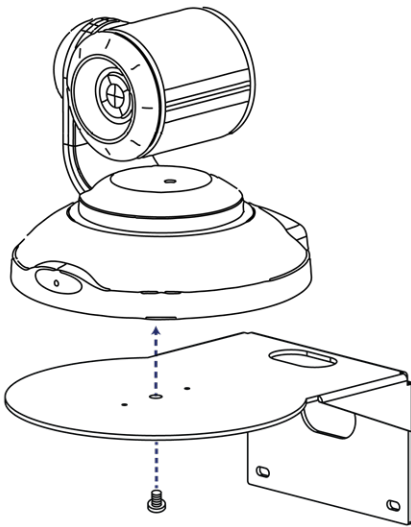

Note

If the camera is jostled or bumped while it is connected to power, it may require a pan-tilt reset.

Installing the Camera and Speaker

1. If you are adding a speaker to a previously-installed ConferenceSHOT AV camera, remove its mounting screw.
2. Place the camera on the mounting shelf if you have not already done so.
3. Secure the speaker rail, gasket, and camera to the mounting shelf with the 0.5 in. 1/4-20 flathead screw.

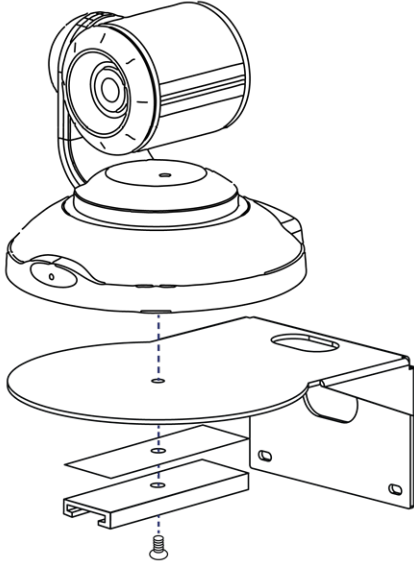

4. Connect the speaker cable (power and line level signal) to the speaker.
5. Slide the speaker into place.

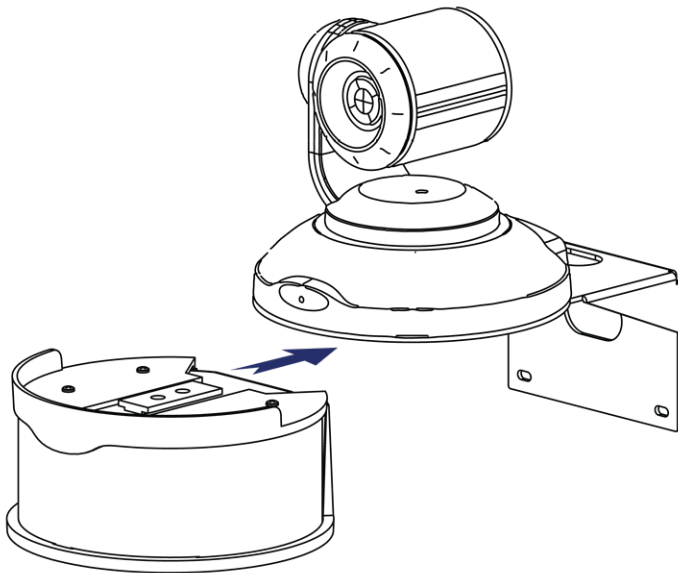

Note

If the camera is jostled or bumped while it is connected to power, it may require a pan-tilt reset.

Powering Up the System

Connect camera power. The camera will initialize and move. This will take a few seconds. When an image is available, the camera is ready to accept control information.

Initial Device Set-Up and System Administration Tasks

Vaddio cameras have a web interface for initial device set-up, administrative control, and operation.

When any Vaddio product is shipped from the factory, there is no admin password and the administrative controls are not available. This is also true if you restore factory defaults, which returns the device to a "like new" state. Initial device set-up includes setting the admin password, and may include additional tasks.

After initial device set-up is complete, you will need to complete system administration tasks to define how the device behaves as an element of your network.

Browser Support

We have tested this product with these web browsers:

- Chrome®
- Firefox®
- Microsoft® Edge and Internet Explorer®
- Safari®

We test using the browser version available from the vendor at that time. Other browsers (including older versions of the ones on this list) are likely to work also.

Initial Device Set-up Process Overview

The sequence of tasks for initial device set-up and system administration differs somewhat, depending on which method you use.

Ways to access the camera for initial device set-up:

- **Access the web interface from a Vaddio Device Controller** – The touch-panel automatically scans the subnet to locate Vaddio devices. Select the desired device and exit to the device's web interface to complete the initial device set-up.
- **Locate and set up the camera using the Vaddio Deployment Tool** – This tool is available as a free download at <https://info.legrandav.com/VaddioDeploymentTool>. The tool scans the network for Vaddio devices, lists them by model and IP address, identifies all devices that are not set up, provides the controls to complete the initial device set-up, and provides links to each device's web interface.
- **Access the web interface directly** – The classic method. Discover the camera's IP address and browse to its web interface.

Initial Device Set-Up Using the Vaddio Device Controller

The Vaddio Device Controller is a stand-alone appliance for working with Vaddio products' web interfaces.



Ways the Vaddio Device Controller makes your tasks easier:

- Easily scan your network for Vaddio devices – no more complicated procedures for discovering devices' IP addresses.
- Following the scan, select a device and exit straight to its web interface.
- No annoying messages about HTTPS connections - you automatically connect via HTTPS.

Unlike the Vaddio Deployment Tool, it does not need to be updated to support new products. For detailed instructions on installation and use, refer to the Vaddio Device Controller's manual.

To complete the initial device set-up with the Vaddio Device Controller:

1. Be sure the touch-panel is installed on the same subnet as the products you need to work with – for example, connect both to the same PoE+ switch.
2. Go to the touch-panel's Configuration page and select Scan. You will need to enter the Vaddio Device Controller's PIN to access the Configuration page.
3. Locate the device you need to work with, and select Use.
4. Select Exit to leave the Configuration page and open the device's web interface.

Note

The first time you access a device at a specific IP address, the Vaddio Device Controller's screen may remain blank for 20 seconds or more.

5. Complete the initial device set-up.

If the Vaddio Device Controller does not find the camera:

- Verify that the camera is connected to the network, on the same subnet as the Vaddio Device Controller.
- [Check the camera's IP address manually.](#)

Initial Device Set-Up Using the Vaddio Deployment Tool

The Vaddio Deployment Tool simplifies provisioning and system administration for most products, and provides a shortcut to each device's web interface.

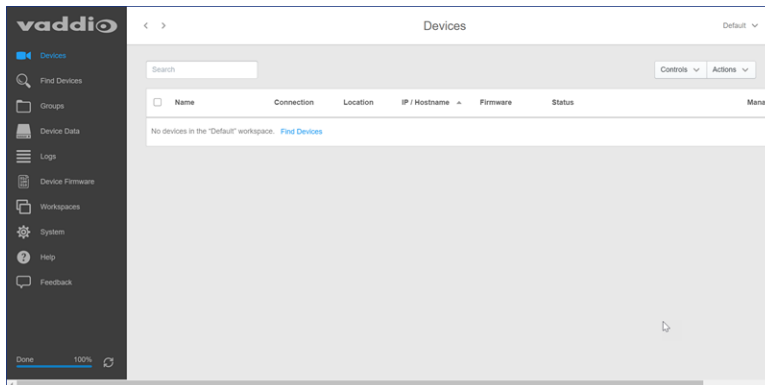

Ways the Vaddio Deployment Tool makes your tasks easier:

- Easily scan your network for devices – no more complicated procedures for discovering devices' IP addresses.
- View scan results as a dashboard; easily identify unprovisioned and unauthenticated devices.
- Provision new devices or update device firmware from the dashboard.
- Import or export device configurations, reboot, or restore a device to factory defaults from its detail page.
- Access devices' web interfaces directly.
- Change a device's admin password from its detail page.
- Standby and mute controls available on the dashboard for authenticated devices.
- Organize devices into groups – for example, by product type or physical location.

Note

Be sure you have the current version of the Vaddio Deployment Tool. If it notifies you that an update is available, install the update. This ensures that you have access to the full capabilities of the tool.

To complete the initial device set-up with the Vaddio Deployment Tool:

1. Download and install the Vaddio Deployment Tool if you have not done so already, then open it.
2. Power up the camera and other devices if you have not done so already.
3. On the Find Devices page, click Scan. If the scan does not locate the devices you are setting up, your computer may be on a different subnet. Return to the Find Devices page and click Advanced and specify the appropriate portion of the network to scan.
4. In the list of equipment that the scan discovers, locate the devices marked Not Set Up.

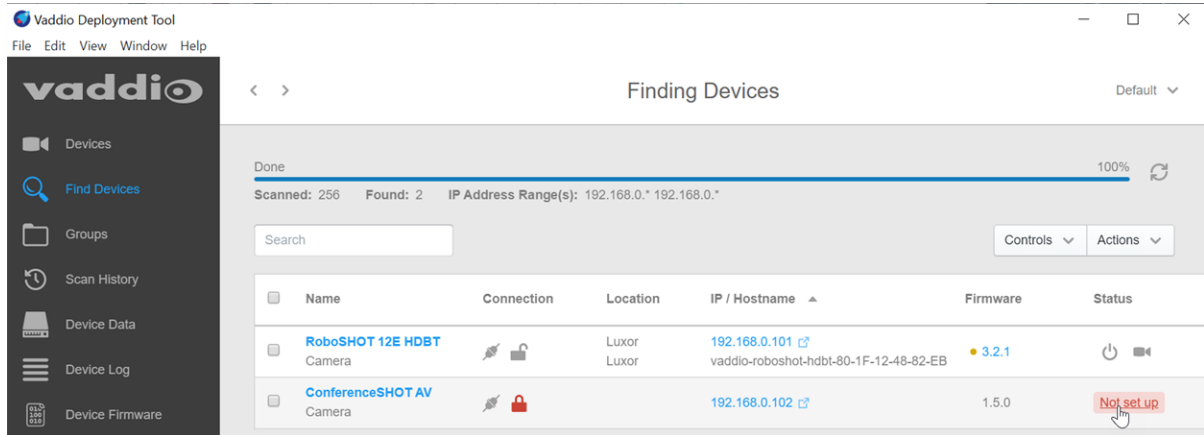

5. For each device that you need to work with, click the Not Set Up button and set the admin password on the device detail page that opens.

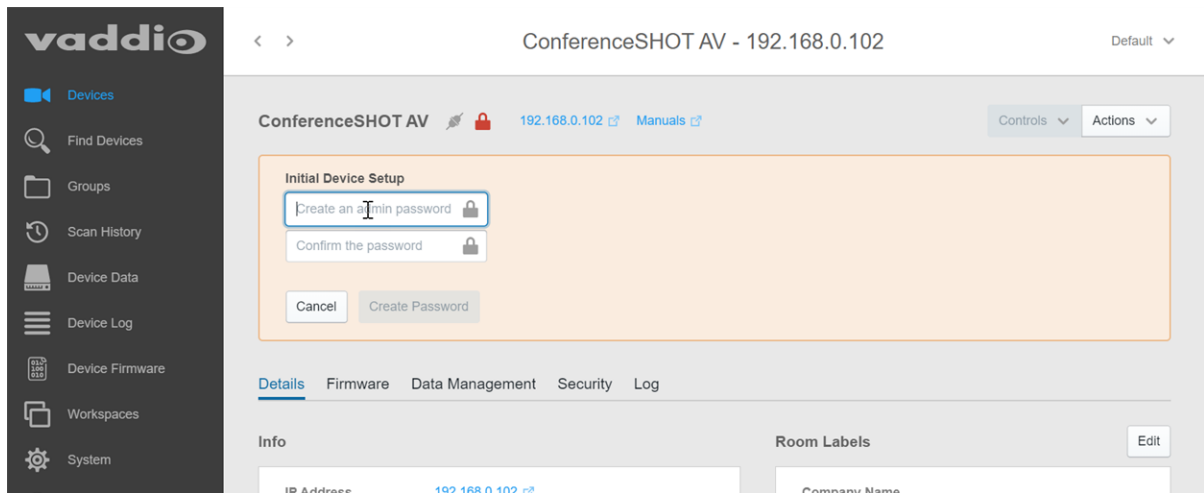

The device shows up as unlocked after you set the admin password. You can now access the administrative web interface to complete system administration and other configuration tasks. That's it. No complicated procedures for finding all the newly installed devices on your network. You can find and manage your whole Vaddio deployment from the Vaddio Deployment Tool.

Manual Access and Initial Device Set-Up

To complete the initial device set-up from the web interface, you will need to do these things:

- Discover the device's IP address.
- Browse to the device's IP address using HTTPS. This will generate warnings from your browser.
- Complete the initial device set-up.

Getting the Camera's IP Address for Access via Browser

If you are not using the Vaddio Deployment Tool or the Vaddio Device Controller to locate and work with the camera, you will need to know its IP address so you can browse to it.

If you know that your network does not automatically assign IP addresses, skip this section: The camera's address is 169.254.1.1. You will need to connect your computer's network port to the camera's network port to do the initial device configuration and network configuration.

If you are not sure, or you know that your network automatically assigns IP addresses, you will need to be able to view the camera's USB stream to get the IP address.

To get the camera's IP address:

1. Connect the camera to the network, and connect the camera's USB cable to your computer. Then power up the camera. If necessary, your computer loads the appropriate USB driver.
2. Open a media player such as VLC Media Player and view the USB stream (If you use VLC Media Player, this is the "Open Capture Device" option under Media.). The camera is available as a video capture device; the device name is ConferenceSHOT AV.

The screen shots below show how you would access the USB stream using VLC Media Player. In this example, the capture device is a ConferenceSHOT 10 camera. The steps are the same for the ConferenceSHOT AV camera; only the video device name differs.

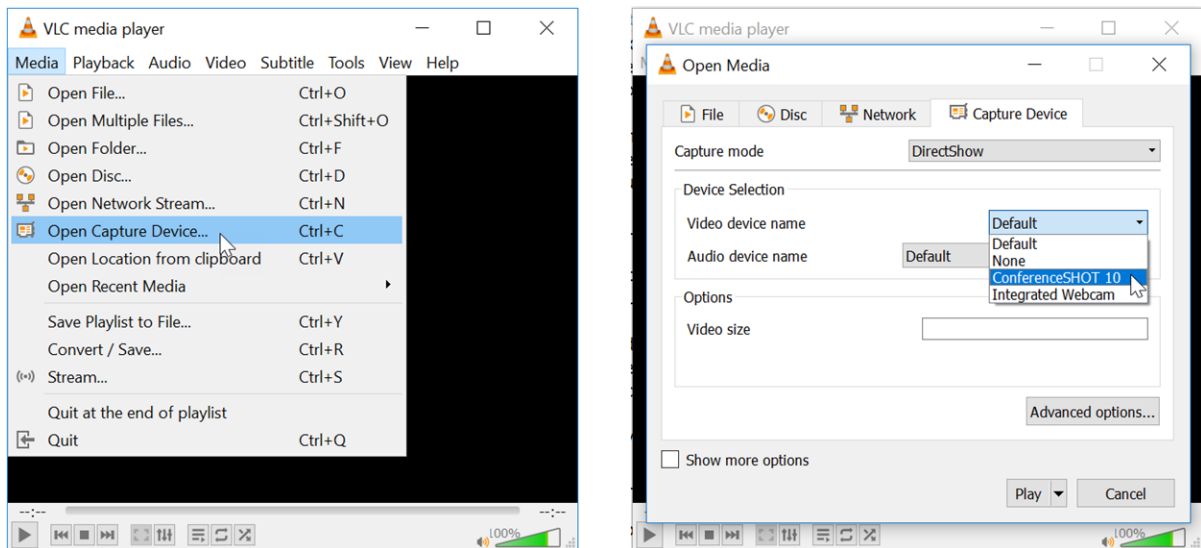

3. Point the remote at the camera and press the Data Screen button. The camera overlays its IP address and MAC address on the video output.
4. Press the button again to dismiss the information display.

If the Camera Is At 169.254.1.1

This is the camera's default IP address. This means one of these things:

- The camera is not connected to the network.
- The network does not automatically assign IP addresses, and you need to configure the camera for the network.

To communicate directly with the camera, connect a cable from your computer's network port to the camera's network port.

After you have done the initial device set-up, you will need to configure the camera for the network.

Initial Access to the Web Interface

Enter the camera's IP address in your browser's address bar. You may need to enter `https://` as a prefix to keep the browser from treating it as a search query. (Example: `https://10.30.200.125`)

HTTP access is disabled initially. **This is also true after restoring factory defaults.** When you access the web interface without using the `https://` prefix, you may encounter this message:

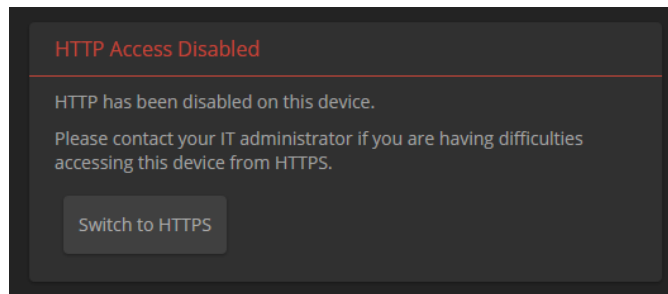

Switch to HTTPS if you see this message.

Expect a security warning from your browser the first time you access the device's web interface.

Different browsers will respond with different messages and options. Your browser will probably present a message indicating one of these things:

- The connection is not private
- The site is not secure
- The site is not trusted
- The site poses a security threat

This is because the certificate (the product's website security credential) is self-signed rather than being issued by an external certificate authority. *The HTTPS connection is secure and traffic is encrypted, however.*

You will need to make the selections that your browser's security message discourages.

Depending on the browser, the warning presents an option to learn more, view details, or go to the "Advanced" page. When you select this, your browser provides an explanation and a button or link to continue to the IP address you entered, with a reminder that it may be unsafe. Select the option to continue. *Your HTTPS connection is safe.*

Here is a sample HTTPS warning page from Firefox, showing the "Advanced" information:

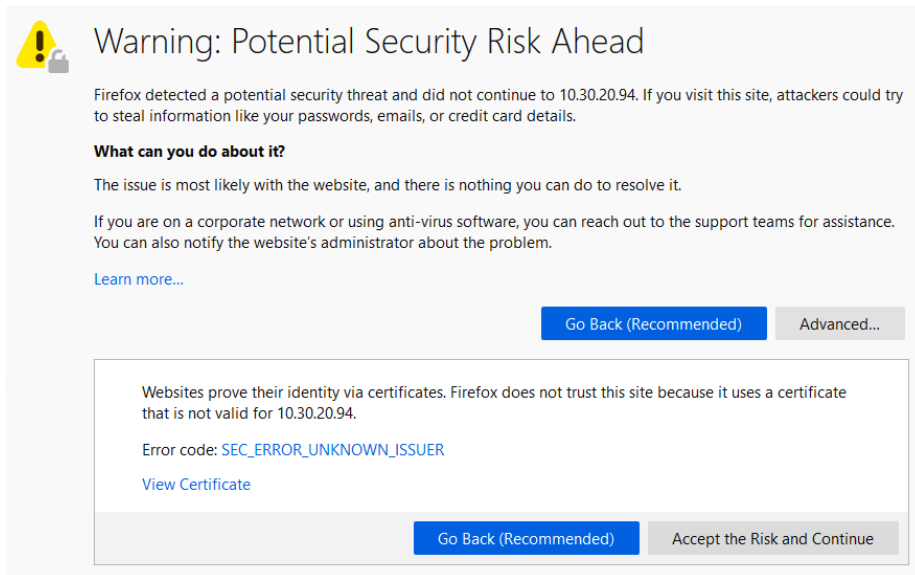

After you have accessed the product's web interface once, your browser may remember its IP address and not present the security message again.

Completing the Initial Device Set-up

If the device has never been in service, or if factory defaults have been restored, the web interface opens to the initial device set-up page.

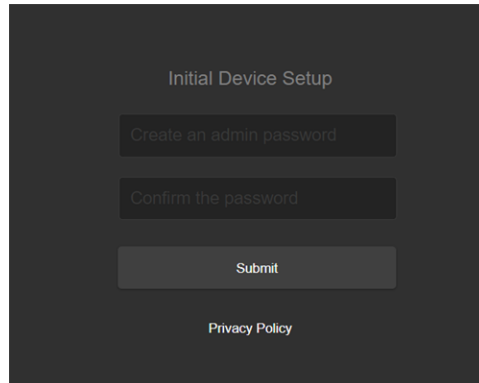

Set the admin password. If there are other tasks on the page (such as reading and accepting policies and agreements), complete them also.

Note

Be sure you have a way to remember the admin password. We cannot reset it for you. If the password is lost, you will need to restore factory defaults.

Note

This page may include a link to the company's standard privacy policy. This product does not record or save audio or video files, and it does not store any identifying information other than what you may choose to enter on the Room Labels page of the web interface. However, the device's IP address is considered "personally identifiable information" for the purposes of the privacy policy.

The full administrative interface opens when you finish.

Web Interface Quick Reference

Where to find the controls you need right now for camera operation, administration, and configuration. If guest access is enabled, the web interface opens to the Controls page. You must log in as admin to gain access to the administrative pages.

Note

Vaddio cameras have very similar web interfaces. Some of the screen shots in this manual may be from other models of camera.

User or Guest Access – Camera Page

The operator's Camera page is available after you do at least one of these things:

- Set a password for the `user` account, or
- Enable guest access.

On the operator's Camera page, you can:

- Stop sending video (video mute)
- Move or zoom the camera
- Go to a camera position preset
- Mute all audio
- Control audio volume
- Enter or exit standby mode

Administrative Pages

System administration

What do you need?	Go to this page
Passwords and access management	Security
IP address, hostname, and other network settings	Networking
Settings related to date and time	Networking
Information about the camera's location; helpful phone numbers	Room Labels

Camera behaviors and operation

What do you need?	Go to this page
Camera operation <ul style="list-style-type: none"> ■ Movements and zoom ■ Preset positions ■ Color and lighting settings ■ Focus 	Camera
Camera behavior <ul style="list-style-type: none"> ■ Normal or super-wide mode ■ Image flip ■ IR frequency – respond to the IR remote as camera 1, 2, or 3 ■ UVC-Compliant or Client Custom USB streaming ■ LED behavior 	System (has multiple tabs)
USB and IP streaming settings	Streaming
Speaker and microphone settings	Audio
Programmable behaviors	Control Devices

Maintenance and Troubleshooting

What do you need?	Go to this page
<ul style="list-style-type: none"> ■ Update camera firmware or view the current firmware version ■ Save (export) and restore (import) the camera's configuration ■ Reboot or reset to factory defaults 	System: Firmware
Update microphone firmware	System: Peripherals
Camera adjustment: Recalibrate pan and tilt motors	System : Firmware
Locate Vaddio Technical Support contact information	Help
View diagnostic logs	Diagnostics

System Administration

This chapter covers settings for managing the camera as an element of your network.

System administration

What do you need?	Go to this page
Passwords and access management	Security
IP address, hostname, and other network settings	Networking
Settings related to date and time	Networking
Information about the camera <ul style="list-style-type: none"> ■ Room location and phone number ■ Help desk phone number 	Room Labels

See [Configuring Camera Behavior](#) for information on image adjustments, streaming configuration, and other items related to camera behavior.

Setting Passwords and Access

SECURITY PAGE

The Account Passwords and Web Server areas of the Security page provide basic security for the web interface:

- **Admin password** – Required for access to the admin pages of the web interface and for Telnet access to the device. There is no default admin password.
- **User password** – Required for access to the operator’s page of the web interface unless guest access is enabled. There is no default user password.
- **Allow Guest Access** – Allows people to browse to the operator’s page of the web interface without logging in. If guest access is not enabled, no controls are available until you log in. Guest access is disabled by default.
- **Automatically Expire Idle Sessions** – By default, sessions expire after 30 minutes with no interactions.

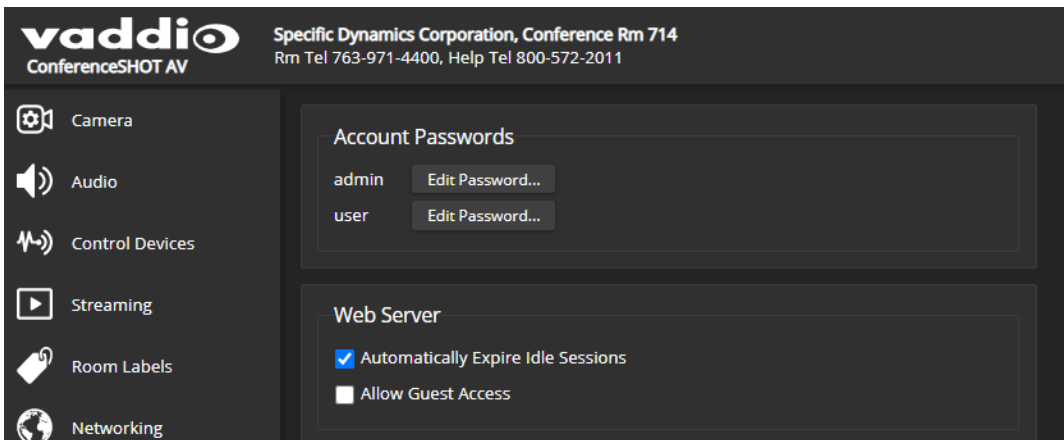

Configuring Other Security Settings

SECURITY PAGE

Security settings include:

- Enabling or disabling access via Telnet (by default, access via Telnet is disabled)
- Enabling or disabling HTTP for web access (by default, access via HTTP is disabled) and installing the SSL certificate
- Allowing or denying device discovery (allowed by default)

Note

Consult your network security specialist before changing any of these settings.

Enabling Telnet Access

SECURITY PAGE

If your installation requires camera access via Telnet, you may choose to enable the camera's internal Telnet server.

Enabling HTTP Access

SECURITY PAGE

By default, the web interface uses the HTTPS protocol, and HTTP is disabled. You can configure the camera's web interface to allow a less secure HTTP connection instead.

1. Select Show Advanced Settings. The advanced options open.
2. To allow HTTP connections, select HTTP Access enabled. The camera's web interface will be available via HTTP or HTTPS connection.
3. To switch to an HTTP connection, select Switch to HTTP.

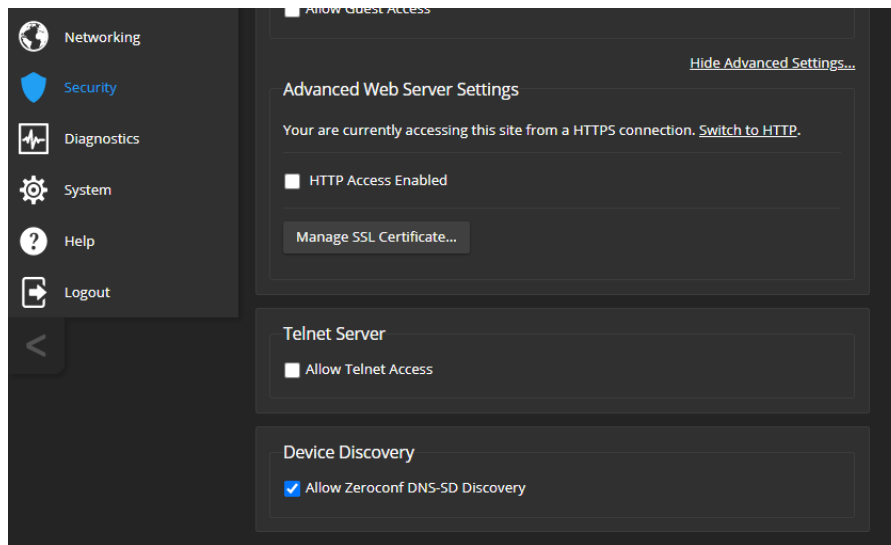

Installing an SSL Certificate

SECURITY PAGE

When the camera does not have an SSL certificate, your browser's address bar may display a security indication.

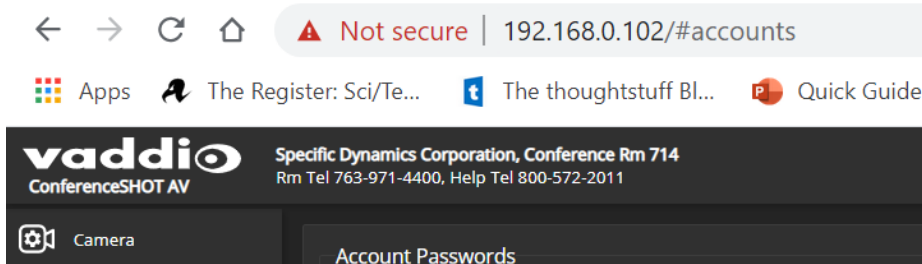

Work with your network security professional to install the camera's SSL certificate.

Caution

Consult your network security professional to manage the camera's SSL certificate. Do not make any changes in the Certificate or Private Key text boxes without guidance from your organization's network security professional.

Configuring the Camera for Your Network

By default, the camera is set to DHCP, and will receive an IP address automatically if your network assigns IP addresses. However, many organizations have policies concerning hostnames, static address assignments for certain equipment, and other aspects of network configuration. Work with your network specialist to ensure that the camera is configured to comply with the organization's network policies.

Configuring the Device with a Static IP Address

NETWORKING PAGE

If no DHCP server is available to automatically assign an IP address, the camera will use the default IP address of 169.254.1.1. If this is the case, you may need to follow this procedure. If you also need to install another camera or other device on this network, you *will* need to do this to prevent IP address conflicts.

Caution

Consult your IT department before changing network settings. Errors in network configuration can make the camera inaccessible from the network. Do not change DHCP/Static addressing, IP address, subnet mask, or gateway unless you are very familiar with the characteristics and configuration of the network where you install the camera.

If the camera is currently at an IP address other than 169.254.1.1:

Work with your IT department to determine whether the device's current IP address is suitable.

If it is, set IP Address to Static. If not, follow the steps for a device at 169.254.1.1.

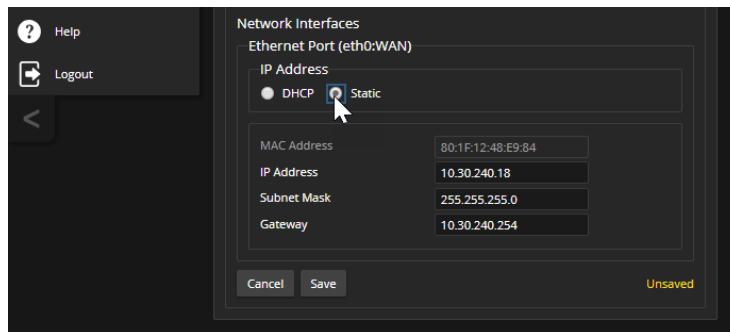

If the camera is currently at 169.254.1.1:

1. Work with your IT department to determine the correct IP address, subnet mask, and gateway to assign.
2. If necessary, connect your computer's network port to the camera's network port.
3. Set IP Address to Static.
4. Enter the IP address, subnet mask, and gateway as directed by the IT staffer; then save your work. The camera is now ready to be connected to the network.

Changing the Camera's Hostname

NETWORKING PAGE

If your network supports hostname resolution, you may find it convenient to change the camera's hostname to something easy to remember. Work with your IT department to ensure that the new hostname conforms to the organization's naming conventions.

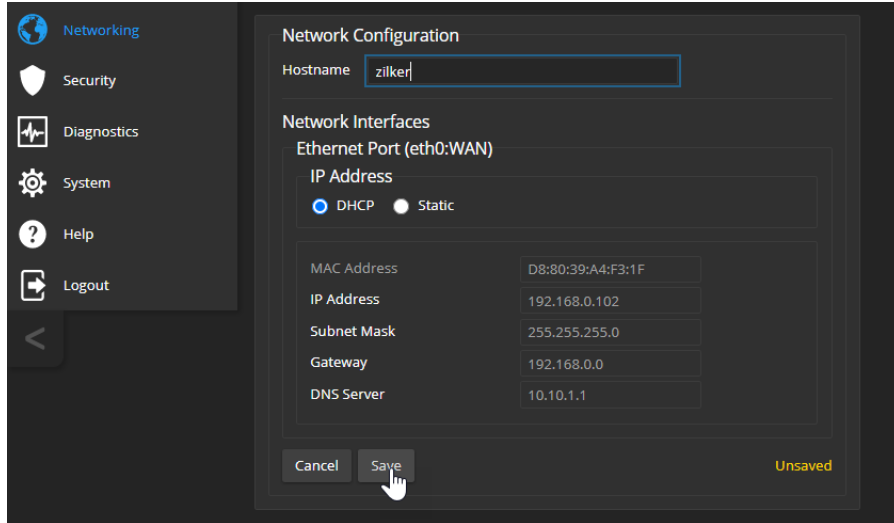

Note

You may need to log in to the web interface again after changing the hostname.

Specifying Time Zone and NTP Server

NETWORKING PAGE

Using automatic NTP updating ensures that the timestamps in the camera's diagnostic log are accurate. Specifying your time zone may make it easier to match logged events with other actions and external events.

1. To make the time zone and NTP server editable, enable Automatic NTP Updating.
2. If desired, specify the NTP server to use. If you are not sure about this, use the default.
3. Select the desired time zone from the list.

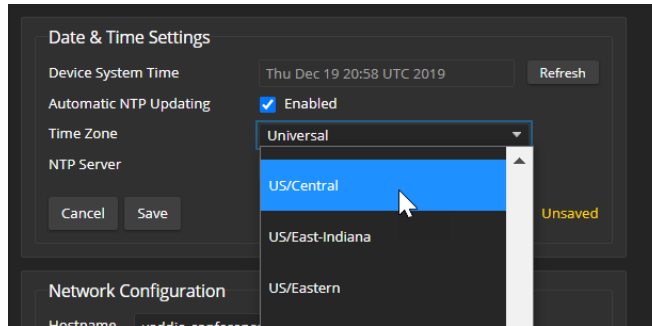

You may need to refresh the system time display.

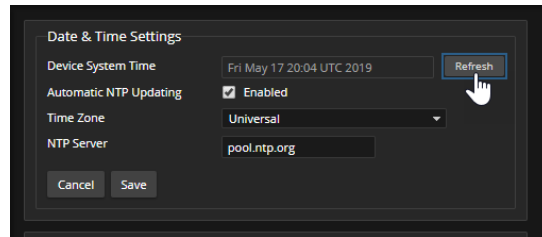

Adding Room Information to the Camera's Web Interface

ROOM LABELS PAGE

The information you enter on this page is displayed on every page of the web interface. In a multi-camera environment, you may also wish to specify what appears on the browser tab.

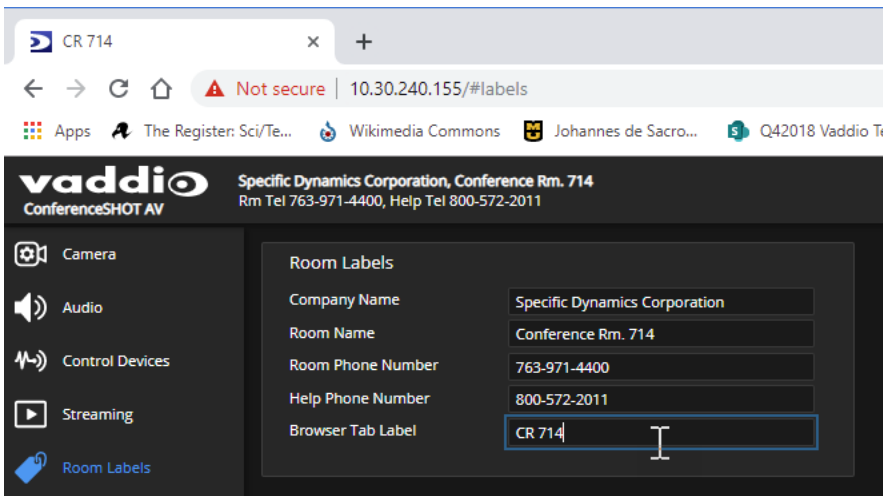

Configuring Camera Behavior

This chapter covers settings for defining how the camera performs in your environment – for example, streaming settings.

What do you need?	Go to this page
Camera operation <ul style="list-style-type: none"> ■ Preset positions ■ Color and lighting settings ■ Focus ■ Speed adjustments 	Camera
Speaker and microphone settings	Audio
Programmable behaviors	Control Devices
USB and IP streaming settings	Streaming
Other camera behaviors <ul style="list-style-type: none"> ■ IR frequency – respond to the IR remote as camera 1, 2, or 3 ■ Normal or super-wide mode ■ Image flip ■ UVC-Compliant or Client Custom USB streaming ■ LED and standby behavior 	System (has multiple tabs)

Setting the Home Position and Other Preset Shots

CAMERA PAGE

Presets are saved shots. Each preset includes pan, tilt, zoom, and (optionally) color settings. When you reboot the camera or bring it out of standby, it returns to the Home preset.

Home and presets 1 through 6 are available with the IR Remote Commander; the others are only available from the web interface and Telnet API.

To store a preset:

1. Set up the shot.
2. In the Presets area, select Store to open the Store Preset dialog.

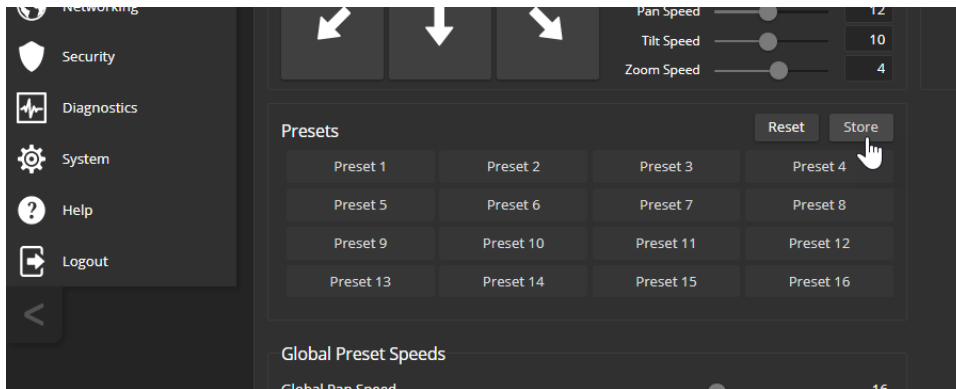

3. Select the preset to store. The preset button changes color.

Note

The Store Preset dialog box does not indicate whether presets have already been defined, but the main display dims the preset buttons if they have no preset information stored.

4. To save the current color settings along with the camera position, check Store with Current Color Settings.
5. Store the preset.

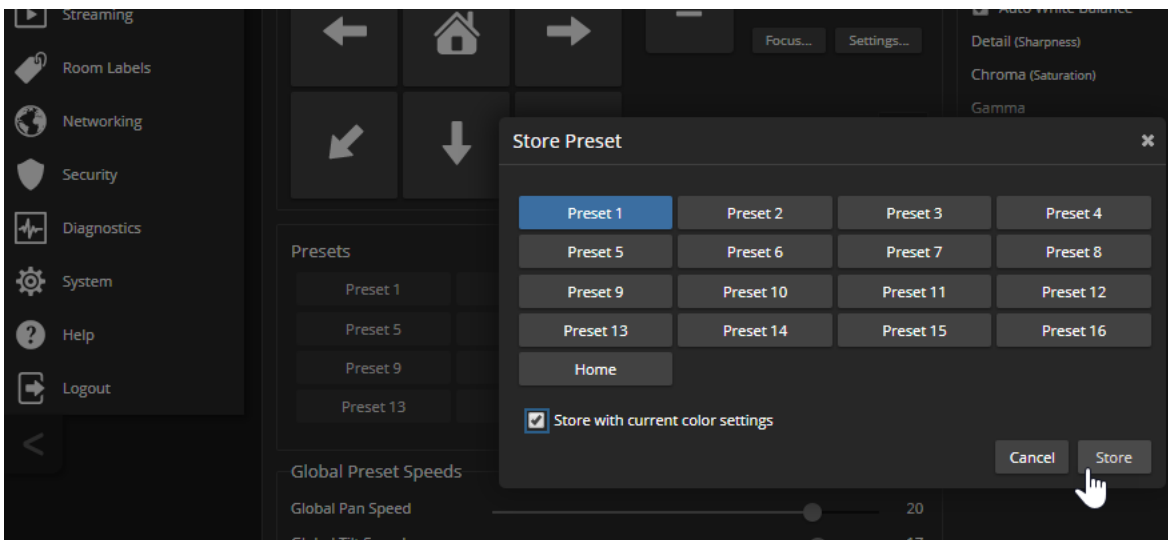

Renaming Presets

CAMERA PAGE

You can rename presets to identify the shots. This also helps you identify and avoid overwriting stored presets when you store a new preset.

Right-click the button for the custom scene or preset, and edit the label.

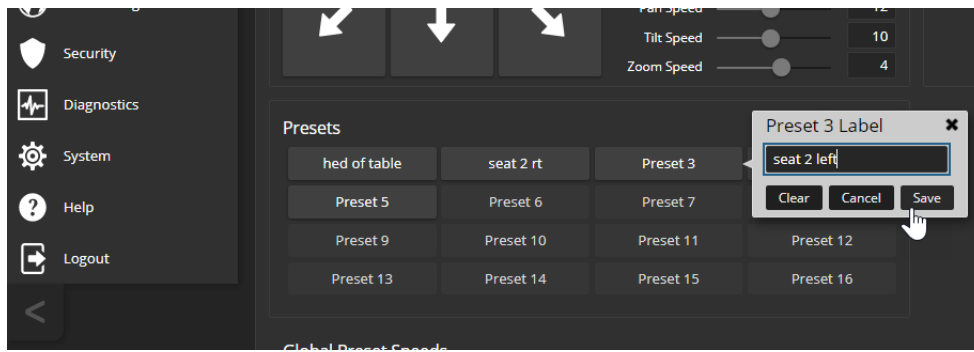

Adjusting Color, Lighting, and Image Quality Settings

CAMERA PAGE

Fine-tune the color and lighting as needed using the Color Settings controls.

- **Auto Iris** allows the camera to compensate automatically for the light level. Clear this box to adjust iris and gain manually.
- **Backlight Compensation** (available when Auto Iris is selected) reduces contrast to adjust for bright light behind the main subject of the shot. This setting can't be used with Wide Dynamic Range.
- **Wide Dynamic Range** (available when Auto Iris is selected) increases the contrast between the brightest and darkest areas. This setting can't be used with Backlight Compensation.
- **Auto White Balance** adjusts color automatically. Clear this box to adjust red gain and blue gain manually.
- **Red Gain** and **Blue Gain** (available when Auto White Balance is not selected) provide manual color adjustment.
- **Detail** adjusts the image sharpness. If the video looks grainy or “noisy,” try a lower Detail setting.
- **Chroma** adjusts the color intensity.
- **Gamma** adjusts the range (grey density) between bright areas and shadows.

The [Lighting and Image Quality Quick Reference](#) and [Color Adjustment Quick Reference](#) may be helpful.

If you make a change that you don't like, start over by selecting and then deselecting Auto White Balance.

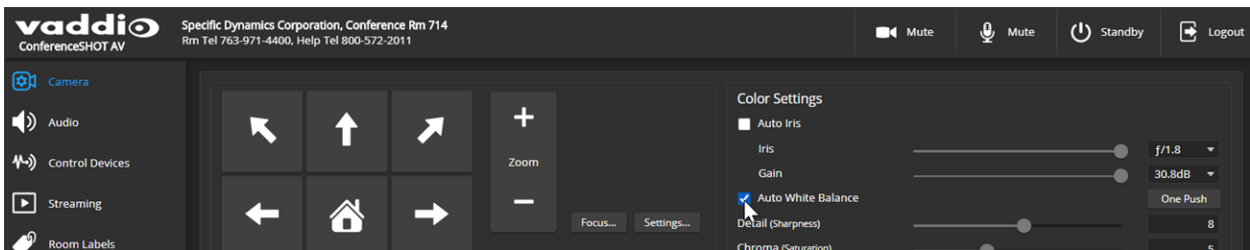
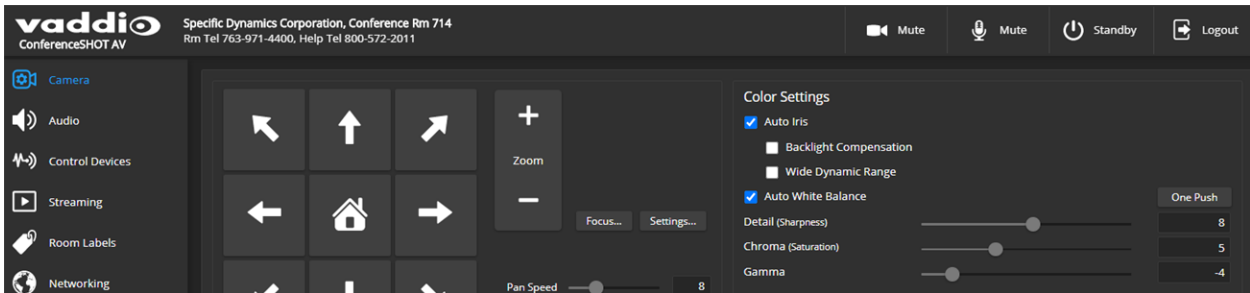





Lighting and Image Quality Quick Reference

Here are some tips for using the color settings for lighting and image quality.

What do you need to correct?	Make this adjustment:
The image is too dark	Increase Iris (lower F-stop value)
	Increase Iris Gain
The image looks washed out or faded	Decrease Iris (higher F-stop value)
	Decrease Iris Gain
	Increase Chroma
	Decrease Gamma
The subject is silhouetted against a bright background	Enable Backlight Compensation
Highlights and shadows look right, but mid-tones are too dark.	Increase Gamma
Shadows are too dark	Enable Wide Dynamic Range (WDR)
	Decrease Gamma
The image looks grainy	Decrease Detail
	Decrease Iris Gain
"Soft focus" effect; the image looks unrealistically smooth	Increase Detail

Color Adjustment Quick Reference

Here are some tips for using the color-related CCU settings.

What do you need to correct?	Make this adjustment:
Colors look less vivid than they should	Increase Chroma
Colors look too vivid	Decrease Chroma
Colors look wrong; white objects do not appear white	Enable Auto White Balance
	One Push White Balance
	Disable Auto White Balance and... <ul style="list-style-type: none"> ■ adjust Red Gain (decrease for less red, increase for less green) ■ adjust Blue Gain (decrease for less blue, increase for less yellow)
<div style="display: flex; justify-content: space-around; align-items: flex-end;"> <div style="text-align: center;"> <p>Too much red</p>  </div> <div style="text-align: center;"> <p>Not enough red</p>  </div> <div style="text-align: center;"> <p>Too much blue</p>  </div> <div style="text-align: center;"> <p>Not enough blue</p>  </div> <div style="text-align: center;"> <p>Balanced</p>  </div> </div>	

If you are adjusting for lighting conditions that are likely to recur, you can store presets with color settings.

Adjusting the Focus

CAMERA PAGE

Open the Focus control to select Auto-focus, or set manual focus with the + (near) and – (far) buttons. The + and – buttons only work when Auto Focus is not selected.

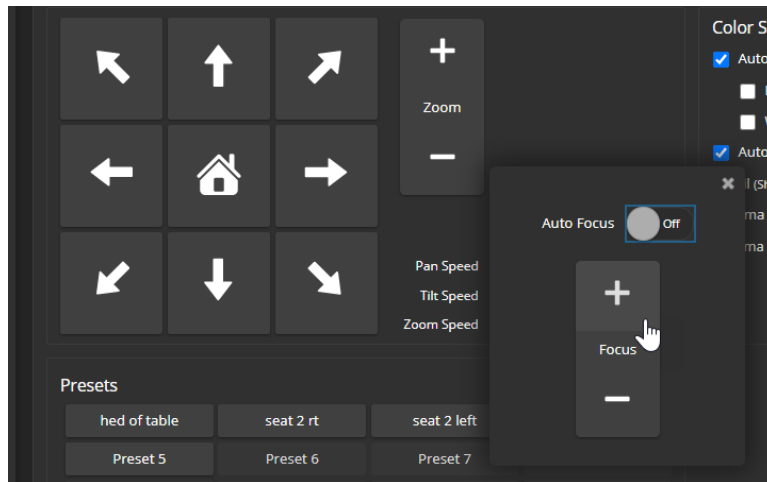

Focus control is available to non-administrative users via the IR Remote Commander.

Speed Adjustments

CAMERA PAGE

The following speed adjustments are available:

- Manual pan, tilt, and zoom speeds – Used when you control camera movements with the IR Remote Commander or the arrow buttons in the web interface
- Global Preset Speeds – Separate pan, tilt, and zoom speeds used for movements between presets.

Setting the Speeds for Manual Movements

CAMERA PAGE

The Pan Speed, Tilt Speed, and Zoom Speed sliders control how fast the camera moves in response to the direction and zoom controls on the IR remote and in the web interface.

To set speeds for movements using the arrow buttons:

Use the speed sliders to adjust the speed of movements that you control with the buttons for pan, tilt, and zoom. For tight shots, slower is usually better.

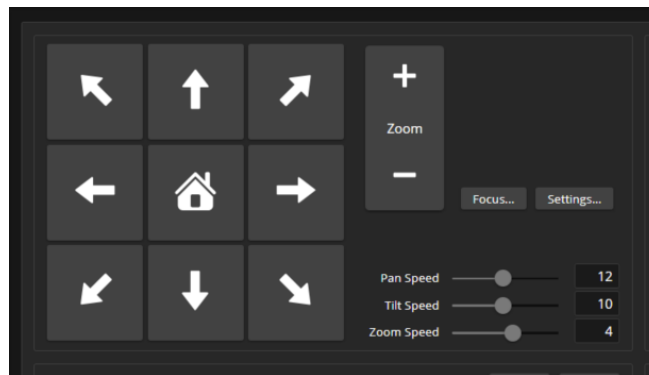

Setting the Speeds of Movements to Presets

CAMERA PAGE

The Pan Speed, Tilt Speed, and Zoom Speed sliders in the Global Preset Speeds control how fast the camera moves to presets.

To set speeds for movements to presets:

In the Global Preset Speeds section, set the speeds for movements to presets.

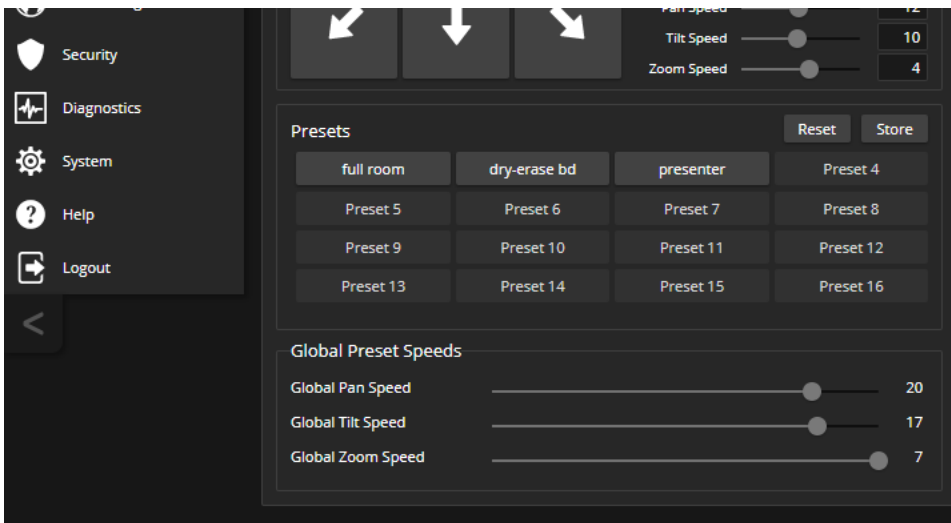

Setting the Direction for Camera Movements

CAMERA PAGE

The camera's default references for left, right, up, and down may not suit your situation.

By default, the arrow buttons on the remote and in the web interface show the direction you would see the camera move if you were looking the same direction as the camera.

If the presenter will control the camera with the remote:

1. Select Settings to open the direction control box.
2. Set Pan Direction to Inverted to make the camera move to the presenter's left when they press the left arrow button.

If controlling the camera with a joystick:

1. Select Settings to open the direction control box.
2. Set Tilt Direction to Inverted to make the camera tilt down when you push the joystick forward.

Note

Inverting tilt direction is only for joystick control. For ceiling-mounted cameras, use the Image Flip setting to invert the video and make the arrow controls on the remote and in the web interface match the actual tilt direction.

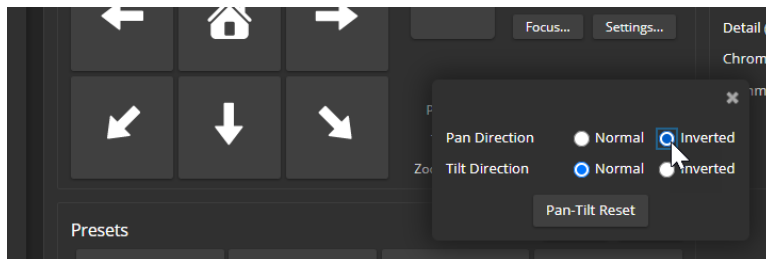

Managing Audio

The web interface provides separate controls for each of the audio inputs (microphones 1 and 2, USB playback) and outputs (line out, IP stream, and USB record).

Muting All Audio Inputs Together

Use the audio mute button at the top of any page of the web interface.

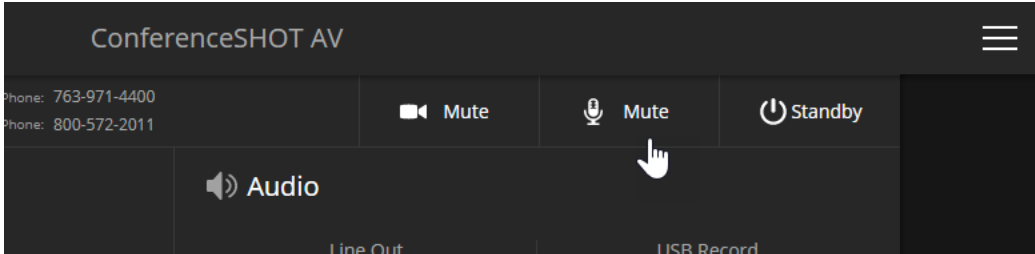

Controlling Volume and Muting Per Input or Output

AUDIO PAGE

Inputs (audio from your site) and outputs (audio from the far end of the conference) are on separate tabs.

To manage individual audio inputs or outputs:

Select the appropriate tab if necessary; then use the slider for the appropriate audio input or output to set the volume. The audio level meter and numeric value can be helpful.

Note

For best performance with most computers, we recommend setting the USB Record volume high.

To mute individual inputs or outputs:

Use the button to mute the desired audio input or output.

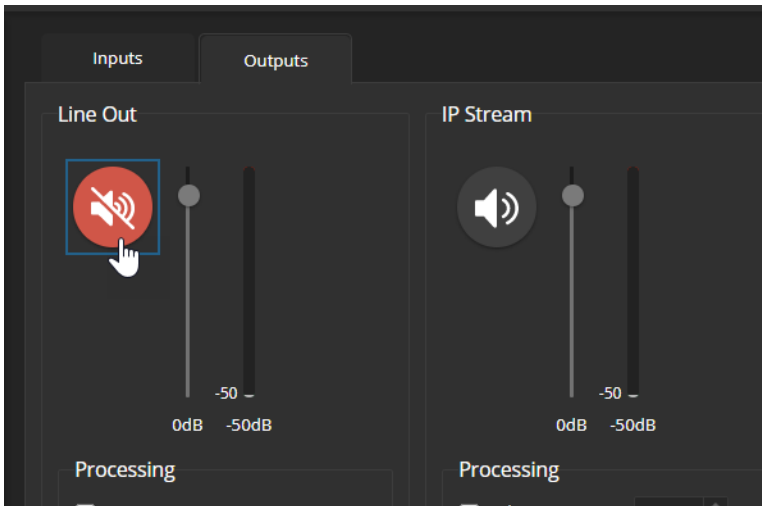

Fine-Tuning Microphone Performance

AUDIO PAGE, INPUTS TAB

To adjust microphones for best far-end audio performance:

Check or clear the checkboxes for the desired adjustments:

- **Echo Cancellation** – Keeps microphones from feeding the speaker output back into the system. Under most circumstances, echo cancellation is desirable.
- **Noise Cancellation** – Suppresses ambient noise such as the conference room's heating/air conditioning.
- **Automatic Gain Control** – Adjusts gain to compensate for differences in the volume of people's voices.
- **Mic Boost** – Provides a 3 dB boost.

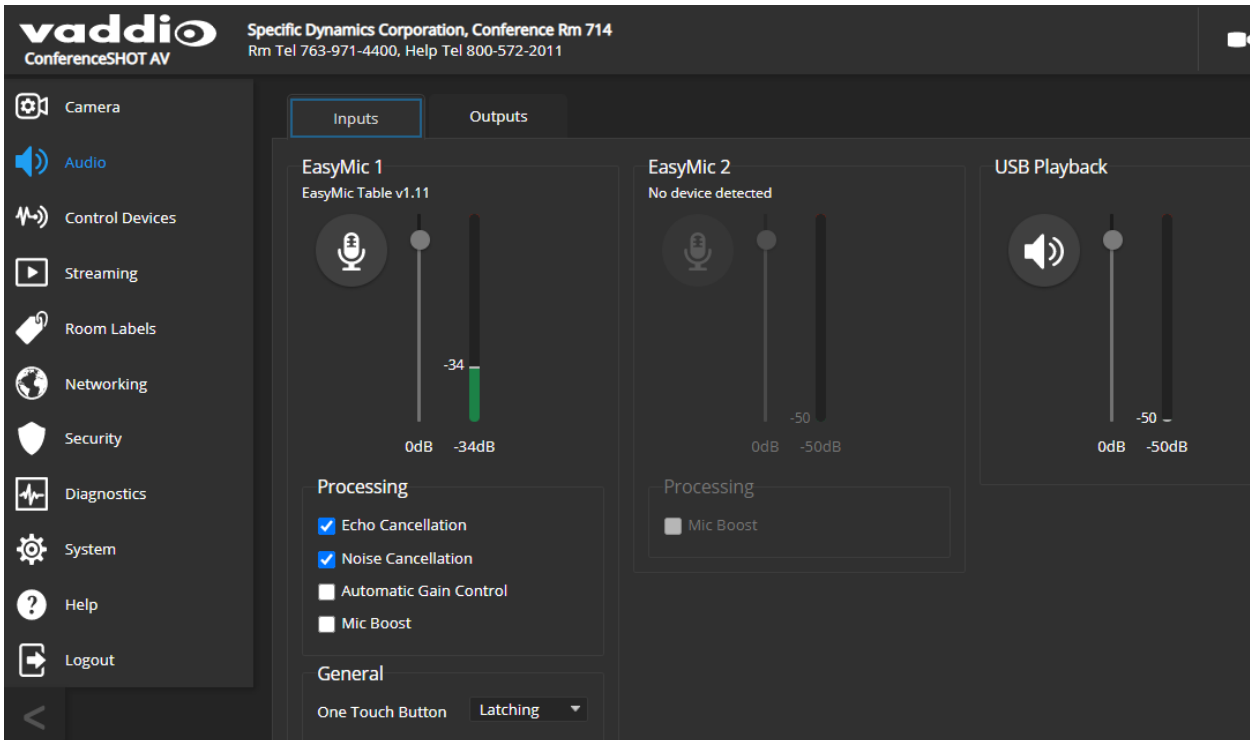

Setting the Microphone's One Touch Button Behavior

The Home button on any EasyMic microphone can be associated with programmed behaviors (macros).

Set the One Touch Button behavior according to how you want the button to behave:

- **Latching** works like a light switch and allows you to associate the button with two macros – one that runs when you turn it on, another that runs when you turn it off.
- **Momentary** works like a doorbell and allows you to associate the button with one macro that runs every time you tap the button.

See [Setting up Custom Functions and Third-Party Control](#) for information on writing macros and associating them to the microphone's home button or other triggers.

Fine-Tuning Speaker Performance

AUDIO PAGE, OUTPUTS TAB

To reduce the dynamic range from the connected speaker:

If some people on the far end are inaudible while others are too loud, check the Compressor box.

To adjust for more natural sound:

Use the equalizer to adjust specific frequency ranges. We recommend reducing the volume for frequencies where you are experiencing undesirable effects first. For example, if people seem to hiss when they speak, start by reducing the volume at 10000 Hz.

To sync the sound with the video in the IP stream:

Check the Delay box and enter a delay value in milliseconds.

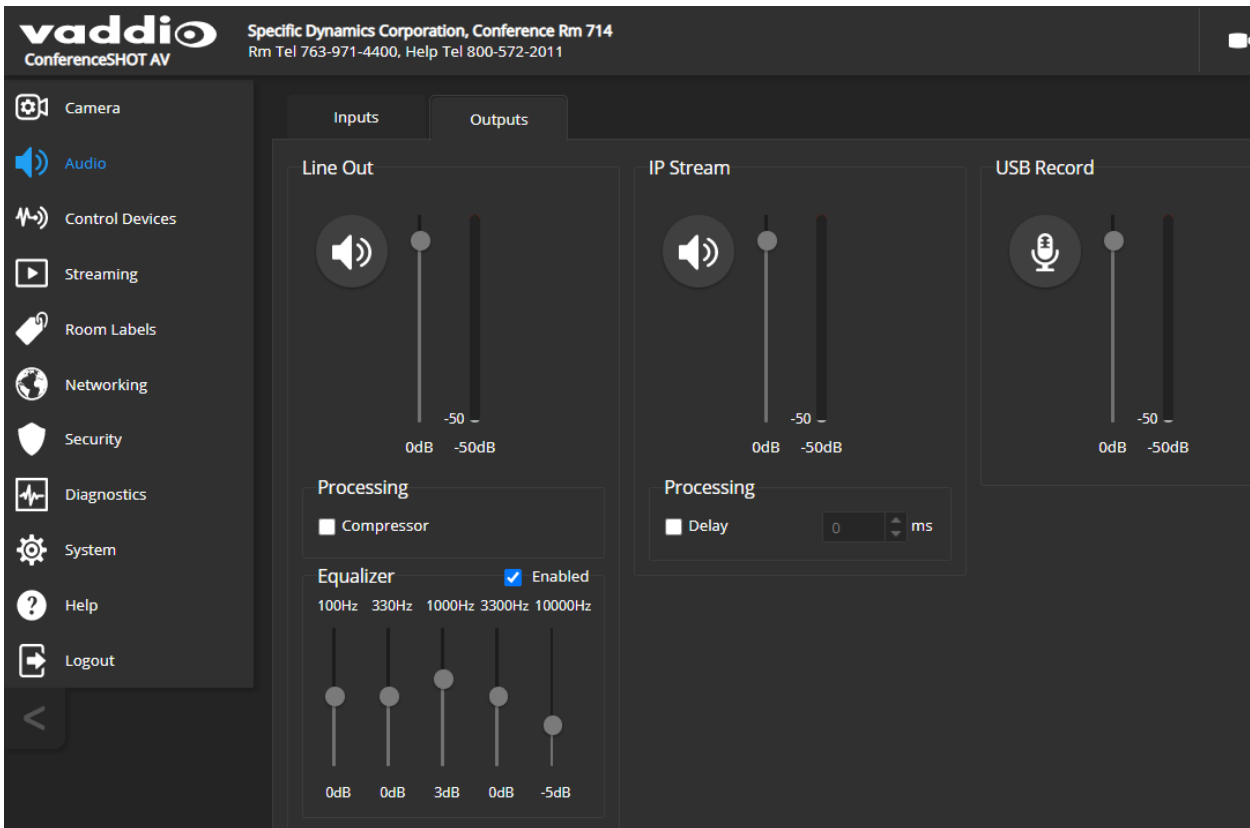

Configuring Streaming Behavior

Conferencing applications use *USB streaming*. The camera's USB stream is always enabled, and is available when the camera is connected to a computer. The USB stream can be viewed using the computer, either in a conference or using a media player.

Two *IP streaming* protocols are available: RTSP and RTMP. IP streaming is off by default.

- *RTSP streaming* delivers an IP stream that people can access from your network using a media player. This is the camera's default protocol for IP streaming.
- *RTMP streaming* sends a stream to a content service provider such as YouTube. No local preview is available. To use RTMP streaming, you must have an account with a streaming service.

Note

Your camera's web interface may differ slightly from the images in these procedures.

Viewing the USB Stream

Do one of these things:

- Start or join a conference.
- Open a stream viewer and select the camera as the video capture device.

The image below shows how you would select a ConferenceSHOT 10 camera as the capture device for VLC Media Player. The media player will correctly identify your camera by model.

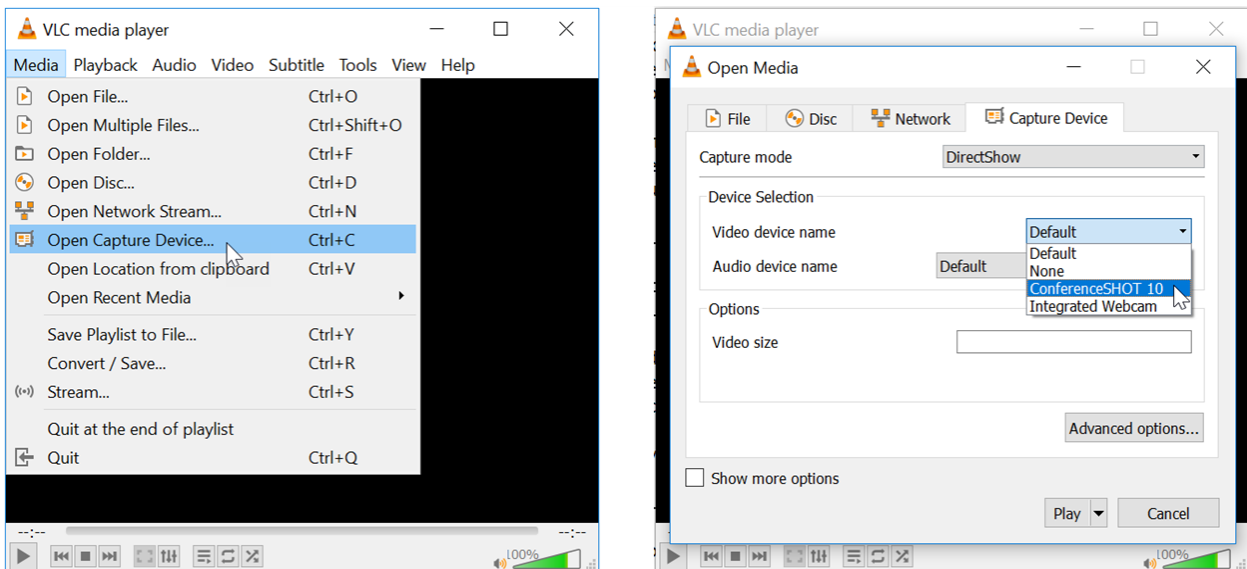

Configuring USB Streaming

STREAMING PAGE

These settings affect how the camera works with soft conferencing applications.

To change the way the camera shows up in your soft client's camera selection list:

Edit the USB Device Name.

To allow conferencing applications to control the audio:

Check the Enabled box for HID Audio Controls.

To allow conferencing applications to control the camera:

Check the box marked Enable UVC Extensions.

Note

USB streaming resolution and frame rate are automatically negotiated between the camera and the conferencing application.

Depending on the conferencing application that you use, you may also need to change the USB stream format setting. See [Additional Camera Settings](#).

Enabling or Disabling IP Streaming

STREAMING PAGE

IP streaming is disabled by default. Enabling it makes the RTSP stream available for viewing on your network, or sends the RTMP stream to the configured destination, depending on which protocol you select.

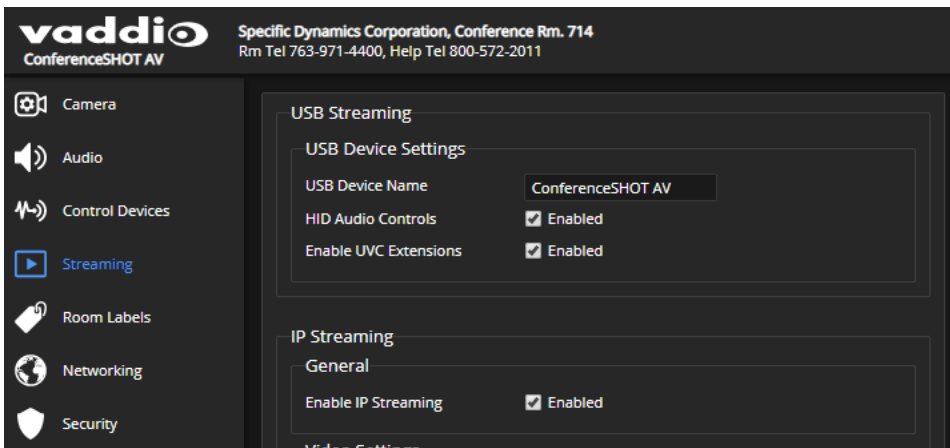

Viewing the IP Stream (RTSP)

1. Open a stream viewer such as VLC Media Player.
2. Select "Network stream" or your viewer's equivalent option.
3. Copy the streaming URL from the camera's Streaming page and paste it into the viewer as the URL for the network stream.

The image below shows how you would view a ConferenceSHOT AV camera's IP stream using VLC Media Player.

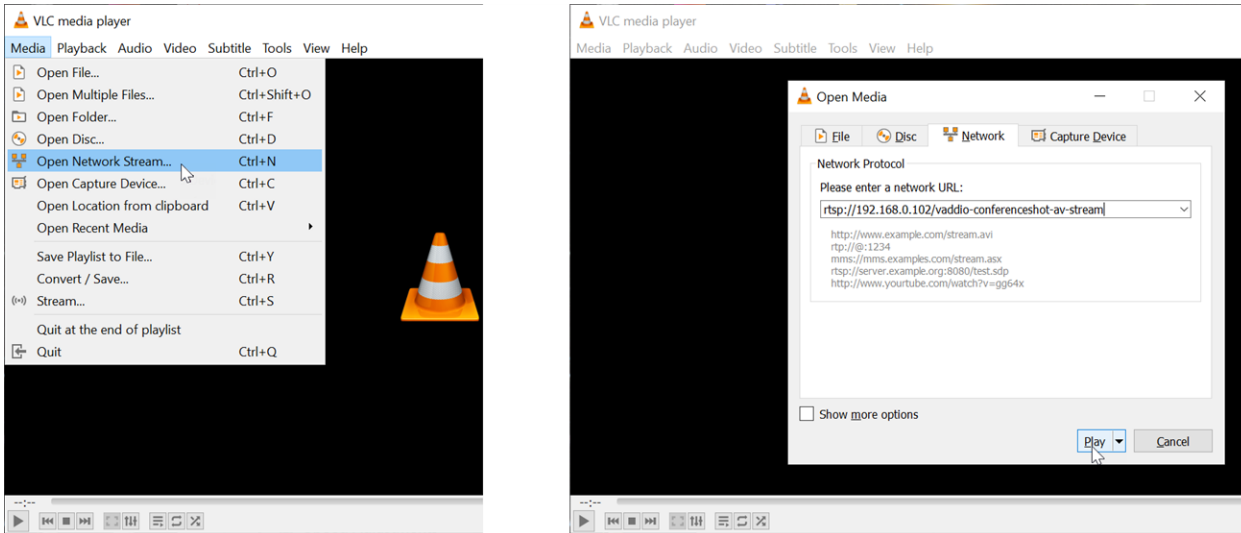

RTSP Streaming Protocol and URL

STREAMING PAGE

RTSP is the default streaming protocol. When IP streaming is enabled, the RTSP stream is automatically available at the streaming URL shown.

Consult your IT department before changing these settings.

RTSP port: Vaddio strongly recommends using the default RTSP port number.

Path: The portion of the streaming URL that appears after the IP address. You may wish to change this to help identify the stream source – for example, `demo-studio-3`.

URL: The location where the stream can be viewed. This will change if you edit the path.

Setting up IP Streaming in Easy Mode

STREAMING PAGE

Note

Consult your network specialist when setting up IP streaming, to be sure that you select settings that are appropriate for the network.

If you are not sure about these settings, start with the defaults.

1. Select Easy Quality Mode.
2. Select the desired IP streaming resolution. This determines the size of the window in which the stream is displayed.

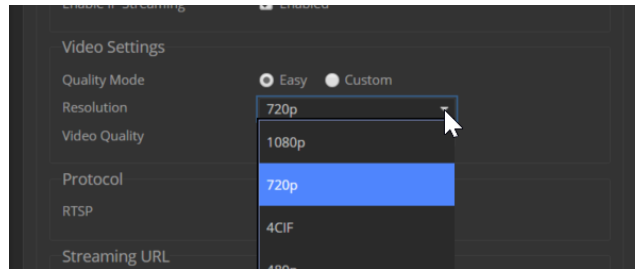

3. Select Video Quality.

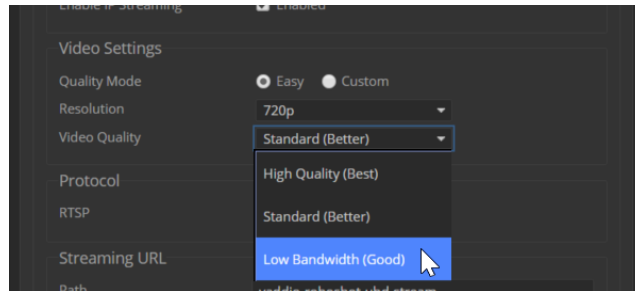

4. Save your changes.

Setting up IP Streaming in Custom Mode

STREAMING PAGE

Note

Consult your network specialist when setting up IP streaming, to be sure that you select settings that are appropriate for the network.

1. Select Custom quality mode.
2. Select the desired resolution.
3. Select the desired frame rate.

Note

Some combinations of resolution and frame rate are not valid, and will generate notifications.

4. Select Constant or Variable Bit Rate.
5. Constant Bit Rate only: Set Max Bandwidth.

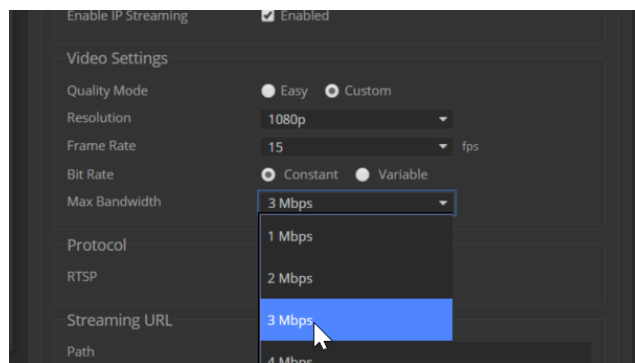

6. Variable bit rate only: Set the Quality (Quantization) slider.

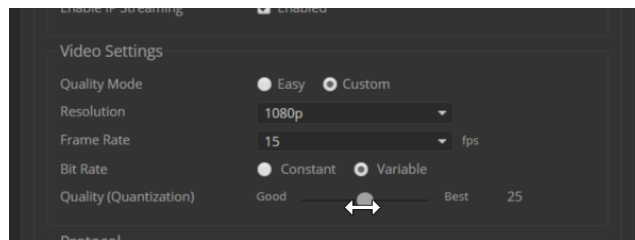

7. Save your changes.

Configuring RTMP Streaming

STREAMING PAGE

To use RTMP streaming, you must have an account with a streaming service.

To configure an RTMP streaming service:

1. Select RTMP streaming, and select Settings.

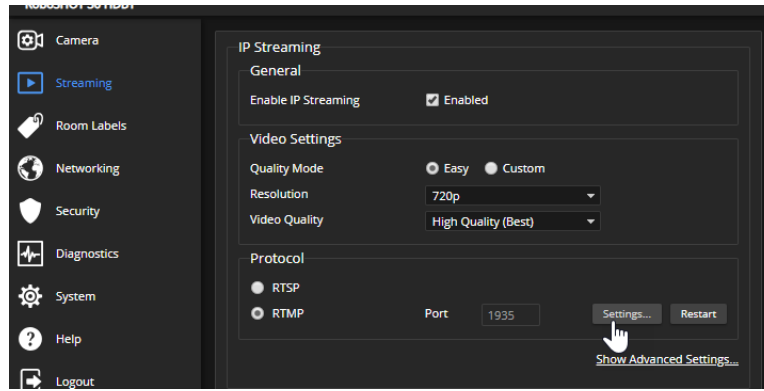

2. Expand the information box for the service.

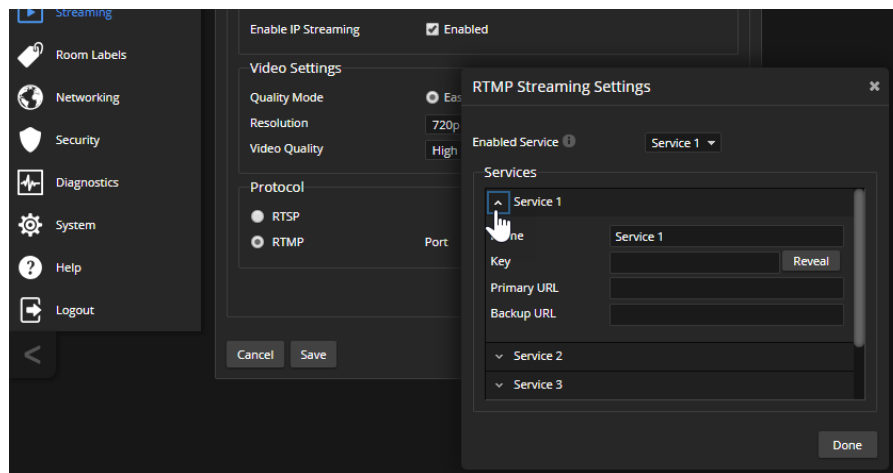

3. Enter the name of the service.
4. Paste in the key and URL(s) provided by the service.

To select the enabled RTMP streaming service:

Expand the list of available streaming services, and select the one to use.

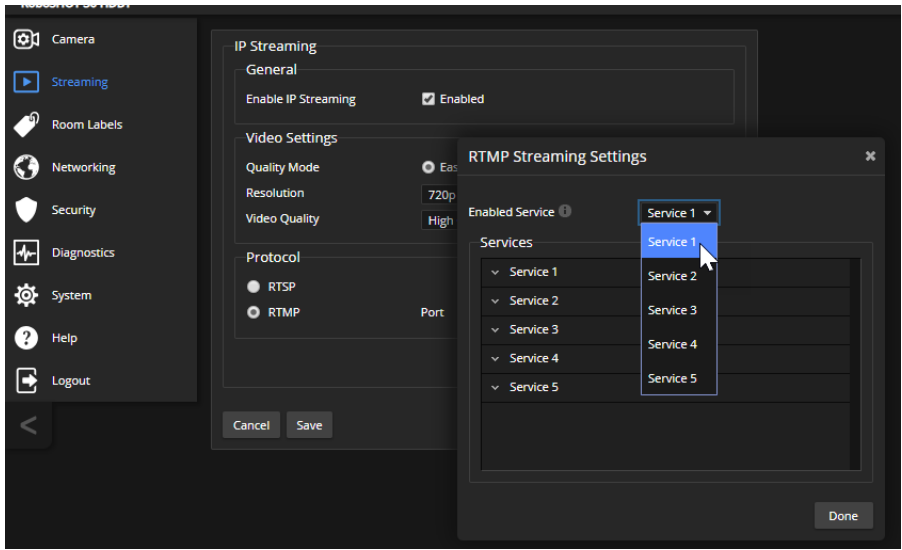

Note

When RTMP streaming is selected and a service is configured, the camera streams to that service until you stop the stream.

Changing MTU

STREAMING PAGE

The default packet size for streaming is 1400. Do not change this except in consultation with your network administrator.

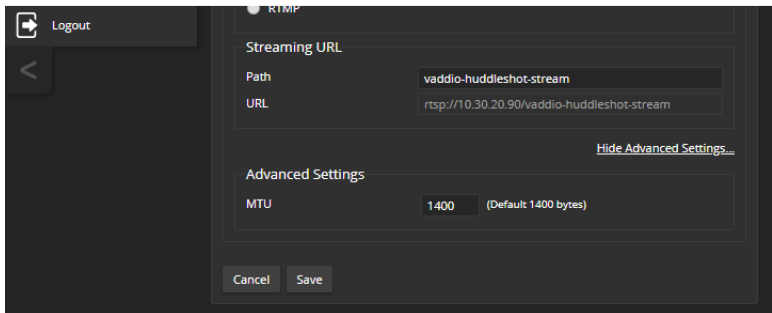
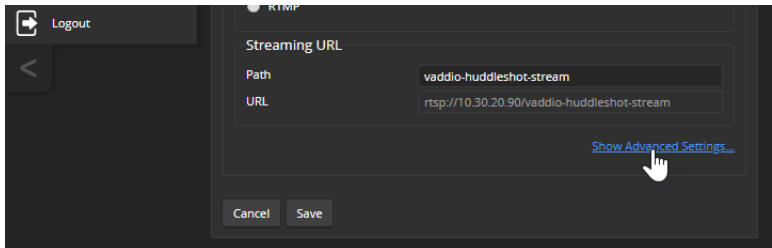

Setting up Custom Functions and Third-Party Control

The Control Devices page provides a way to define programmed behaviors and use third-party control devices to manage the camera.

Macros are sequences of commands. A macro can only run successfully if all the commands are able to run successfully. For example, if the macro sends the camera to a preset position, that preset must be defined. Refer to the [Telnet Serial Command API](#) section for a full list of commands.

Triggers, whether hardware or software, register events or state changes that can be associated with macros, to make them run. For example, the One Touch (Home) button on a TableMIC is a hardware trigger.

Software triggers allow you to program custom functions for third-party control devices, such as defining the buttons on a conference room touch-screen. Hardware triggers (labeled One Touch in the web interface) allow you to define responses to connected Vaddio trigger devices such as tabletop microphones.

Writing and Editing Macros

CONTROL DEVICES PAGE, MACROS TAB

If your camera has a current version of firmware, it has two example macros, Preset 1 and Preset 2. You can safely rename, edit, or delete these macros.

To define a macro:

1. Enter a name in the Macro Editor's Name field.
2. Enter one or more Telnet commands in the editing area.
3. Optional but strongly recommended: Use the Test button to check your work while you are writing the macro.
4. Save your work when you are finished, or select New to start over.

Note

If the macro has external requirements, it will only run properly if those requirements are met. For example, if the macro includes a camera preset command, the applicable preset must be stored before the macro can run successfully. I know I'm repeating myself, but this is important.

The screenshot displays the vaddio ConferenceSHOT AV web interface. At the top, it shows the user's location: Specific Dynamics Corporation, Conference Rm. 714, Rm Tel 763-971-4400, Help Tel 800-572-2011. The interface is divided into a sidebar on the left with icons for Camera, Audio, Control Devices (highlighted), Streaming, Room Labels, Networking, Security, Diagnostics, System, Help, and Logout. The main content area has two tabs: 'Macros' and 'Triggers'. Under the 'Macros' tab, there is a table listing three macros:

ID	Name	Test	Edit	Delete
1	Preset 1	Test	Edit	✕
2	Preset 2	Test	Edit	✕
3	Camera dance	Test	Edit	✕

Below the table is the 'Macro Editor' section. The 'Name' field contains 'Camera dance'. The main editing area is a text box containing the following Telnet commands:

```
camera tilt up 3
camera pan left 3
camera pan right 3
camera pan left 3
camera pan right 3
camera tilt down 5
camera tilt up 4
camera home
```

At the bottom of the editor, there are buttons for 'Cancel', 'Save', 'Save As...', 'Test' (highlighted with a mouse cursor), 'Unsaved', and 'New'. To the right of the editor is a 'Macro Execution Log' section with columns for 'ID' and 'Macro', and buttons for 'Cancel All' and 'Clear Finished'.

To edit an existing macro:

Select the Edit button associated with the macro, make your changes in the Macro Editor, and save your work.

To create a new macro based on an existing one:

Select the Edit button for the existing macro to open it, and use the Save As button to give it a new name. Then select its Edit button again, and make the desired changes.

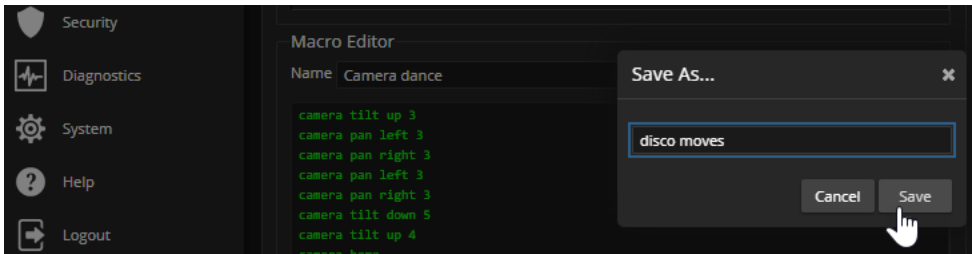

Testing Macros

CONTROL DEVICES PAGE, MACROS TAB

The Macro Editor has a Test button to run a macro while you are editing it. You can also test macros after saving them. The Macro Execution Log shows the result of each test.

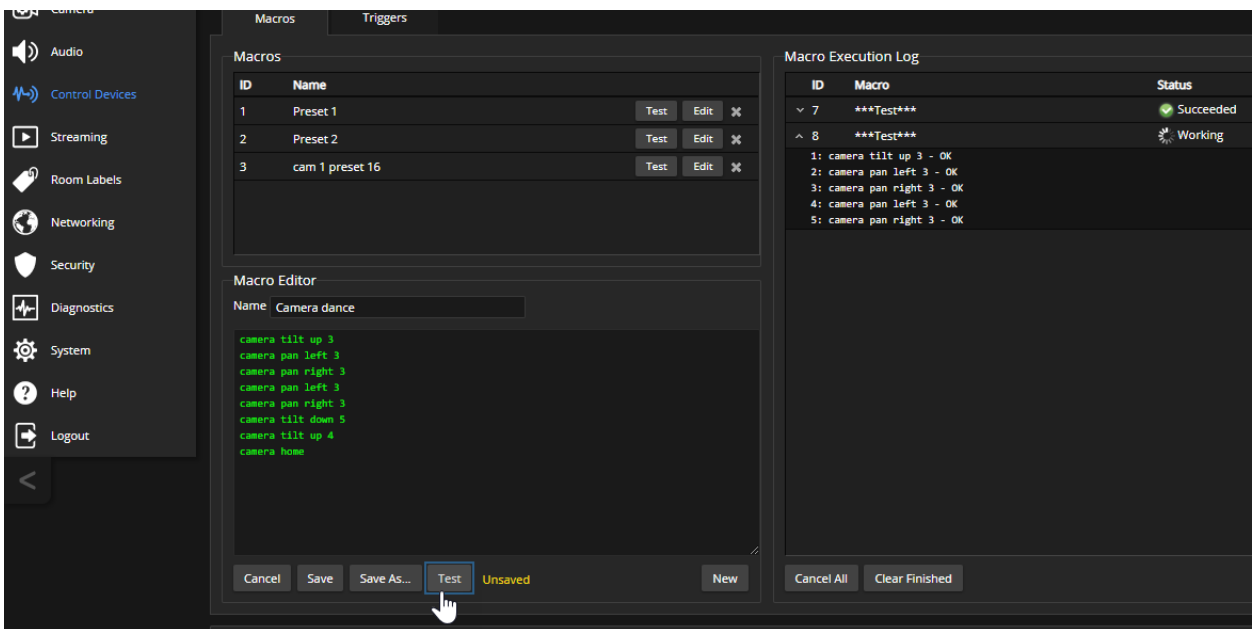

Assigning Macros to Triggers

CONTROL DEVICES PAGE, TRIGGERS TAB

When you associate a macro with a trigger, you must specify whether it runs when the trigger turns on, or when it turns off – so you can associate two macros with each trigger, one to run when the trigger is activated, and one to run when the trigger is turned off.

If you assign two macros to a microphone's One Touch trigger (the Home button), ensure that the One Touch trigger is set to Latching mode. If you assign only one macro to the One Touch trigger, ensure that it is set to Momentary mode, so the macro runs every time you tap the button. See [Setting the Microphone's OneTouch Button Behavior](#).

To assign a macro to a trigger:

Do at least one of these things:

- Select a macro in the Execute Macro on Enter field. This macro will start when the trigger turns on.
- Select a macro in the Execute Macro on Exit field. This macro will start when the trigger turns off.

Right-click a trigger label or test button to rename the trigger.

To remove macro assignments from a trigger:

Select the X on that trigger's row. This is equivalent to setting both macros to (none) .

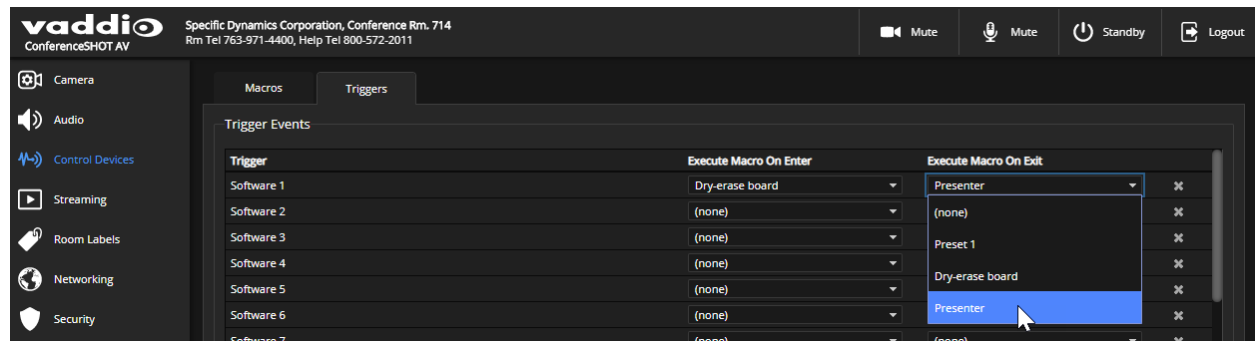

Testing Triggers

CONTROL DEVICES PAGE

Just as it can be helpful to test macros when you write them, it can also be helpful to test triggers when you assign macros to them. The Trigger Testing section is available from both tabs of the Control Devices page.

To test a trigger:

1. Set Test Mode on. The web interface displays a notification.
2. Select the trigger to run the macro associated with turning the trigger on.
3. Select the trigger again to run the macro associated with turning the trigger off, if there is one.
4. Turn off Test Mode when you finish testing.

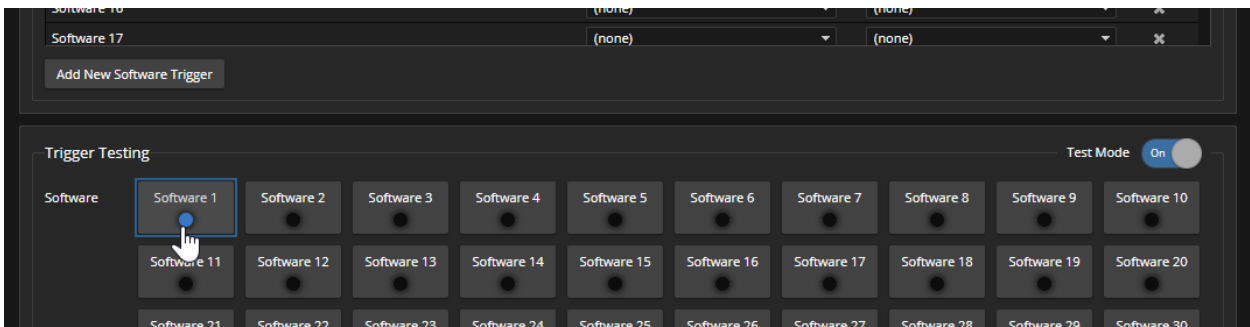

Note

Triggers are not available to the control device when Test Mode is selected.

Example: Assigning a Function to the Connected Microphone's Home Button

CAMERA PAGE, CONTROL DEVICES PAGE

In this example, TableMIC microphones are connected to both of the camera's EasyMic ports. The team that uses the conference room most frequently has requested that the Home button on the remote and the Home buttons on the two microphones should all do the same thing.

Tasks to accomplish this:

1. **Camera page:** Set up the shot and color adjustments, and store the Home preset.
2. **Control Devices page, Macros tab:** Create, name, test, and save a new macro that runs the `camera home` command. For this example, we'll assume you name it Home.
3. **Control Devices page, Triggers tab:** For the OneTouch 1 trigger, click the box in the Execute on Enter column and select the Home macro from the list. Do the same thing for the OneTouch 2 trigger.

Additional Camera Settings

CAMERA PAGE, CAMERA SETTINGS BUTTON

SYSTEM PAGE, DIP SWITCHES TAB

To see the camera's current soft DIP switch settings and configure certain camera behaviors, do one of these things:

- Select the Camera Settings button on the Camera page.
- Select the DIP Switches tab of the System page.

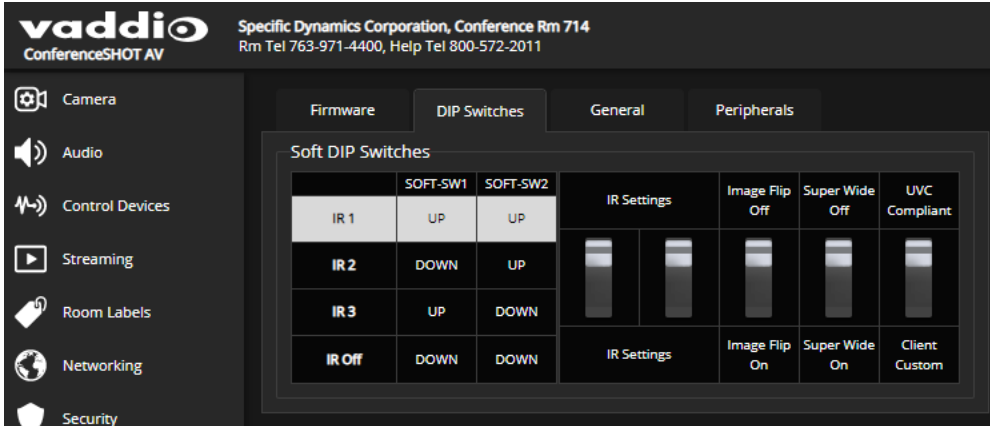

IR Frequency Selection: If there are multiple cameras in the room, use **switches 1 and 2** to configure each with a different IR frequency to allow the IR Remote Commander to control them independently. Then use the Camera Select buttons at the top of the remote to select the camera you want to control.

- SW1 and SW2 up: IR frequency 1
- SW1 down, SW2 up: IR frequency 2
- SW1 up, SW2 down: IR frequency 3

Image Flip – If mounting the camera upside-down, set IMAGE FLIP ON. This orients the video image correctly and sets the tilt motors to respond appropriately to tilt commands from the remote, web interface, and connected control devices.

Super Wide mode – Provides a wider horizontal field of view and greater zoom. Some distortion may be present.

USB stream format (UVC Compliant or Client Custom) – Client Custom enables far-end camera control when used with the Zoom soft client. Use the default UVC Compliant setting with most other conferencing applications.

Indicator Light and Standby Behavior

SYSTEM PAGE, GENERAL TAB

Cameras using older firmware may include these settings on the DIP Switches tab.

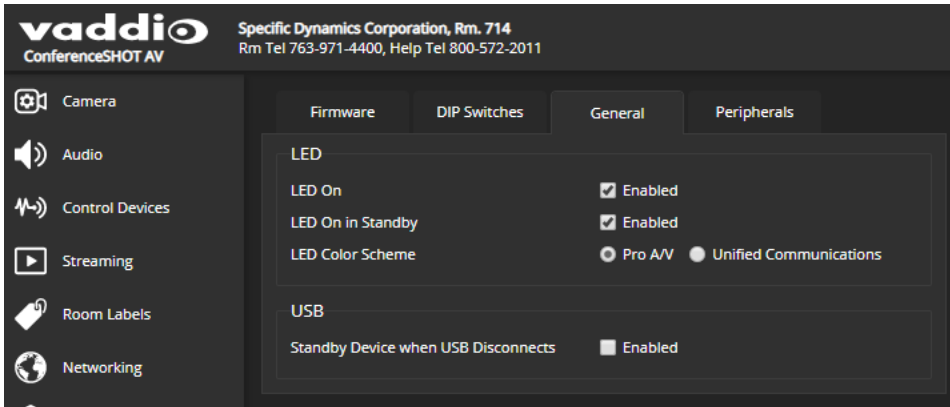

LED On – Clear the check box to turn off the LED. In most cases, Vaddio recommends leaving the status light on, to let people in the room know whether the camera is currently sending video.

LED On in Standby – Clear the check box to turn off the LED when the camera is in standby mode.

LED color scheme – Pro A/V cameras and conferencing cameras use different color schemes for the indicator light. Select the color scheme that suits your needs.

Standby Device when USB Disconnects – Check this box to set the camera in standby mode when no USB stream is present (camera is not in a conference).

System Maintenance

This chapter covers tasks for keeping your system up-to-date and operating properly.

Maintenance and Troubleshooting

What do you need?	Go to this page
<ul style="list-style-type: none"> ■ Update camera firmware or view the current firmware version ■ Save (export) and restore (import) the camera's configuration ■ Reboot or reset to factory defaults 	System: Firmware
Update microphone firmware	System: Peripherals
Camera adjustment: Recalibrate pan and tilt motors	System : Firmware
Locate Vaddio Technical Support contact information	Help
View diagnostic logs	Diagnostics

Saving (Exporting) or Restoring (Importing) a Configuration

SYSTEM PAGE, FIRMWARE TAB

You can import a configuration to several cameras if you need to configure them the same way. Cameras must be of the same model, and must have a compatible firmware version installed.

Note

If the camera is using an older firmware version, it may be unable import a configuration that was exported from a camera using a different version of firmware.

In the event that you need to restore a camera's factory default settings, you may want to export the configuration beforehand so that you can restore customized information.

Included	Not Included
Home and other presets	Color settings
NTP and time zone information	Speed settings
Room Labels	Hostname
	Passwords and other security settings

Configuration data does not include security information or unique information such as hostname.

To export a configuration:

1. Configure the camera – set the time zone, create the room label, and store the presets you need.
2. Export the configuration (Export Data button). The export downloads to your computer as a .dat file. The filename is the camera's hostname.

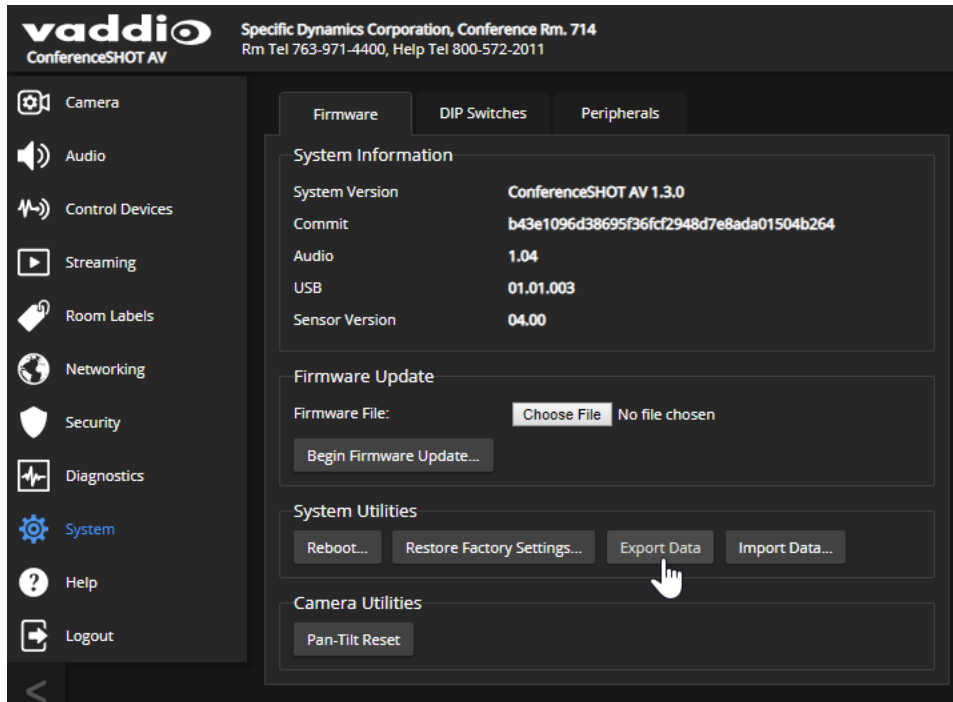

3. When you are ready to restore the configuration, select Import Data. The web interface prompts you to browse to the .dat file that will be imported.

To copy the configuration to a different camera, do this step from the web interface of the camera being configured.

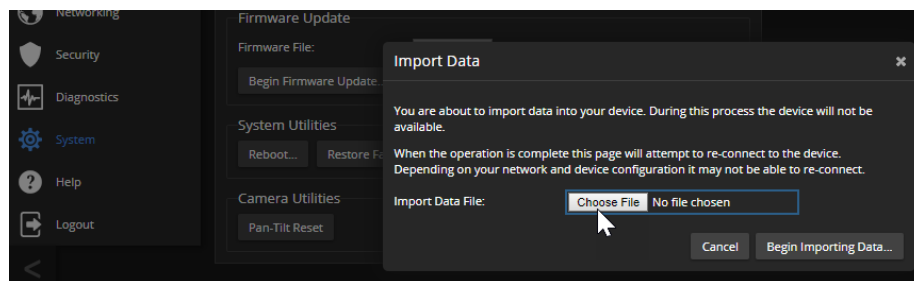

Installing a Firmware Update

SYSTEM PAGE, FIRMWARE TAB

The latest firmware and release notes are available on the product's web page at www.legrandav.com. The release notes provided with each update can help you to decide whether to install the update.

Caution

Be sure the camera stays connected to power and to the network during the update. Interrupting the update could make it unusable.

1. Download the firmware and its release notes.
2. Select Choose File, then browse to the downloaded firmware and select it. The filename ends with .p7m.

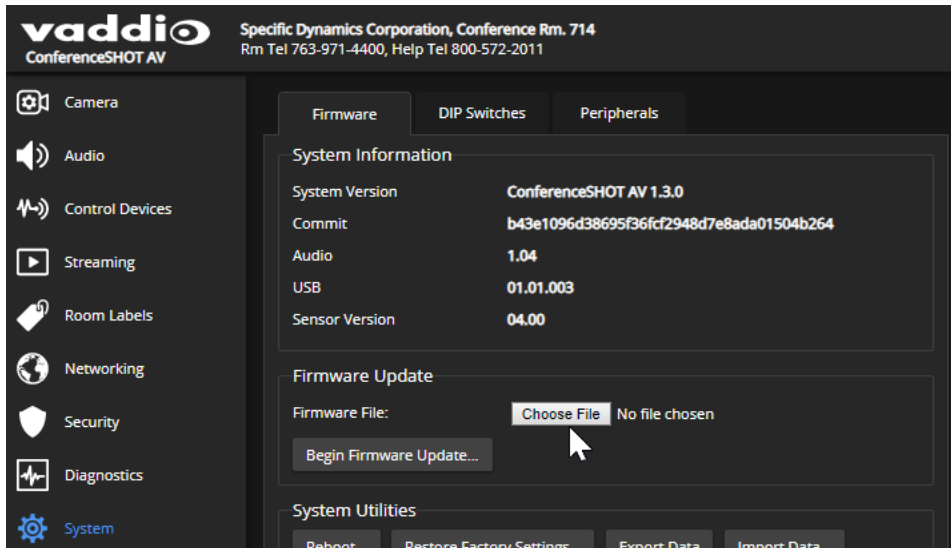

3. Select Begin Firmware Update.

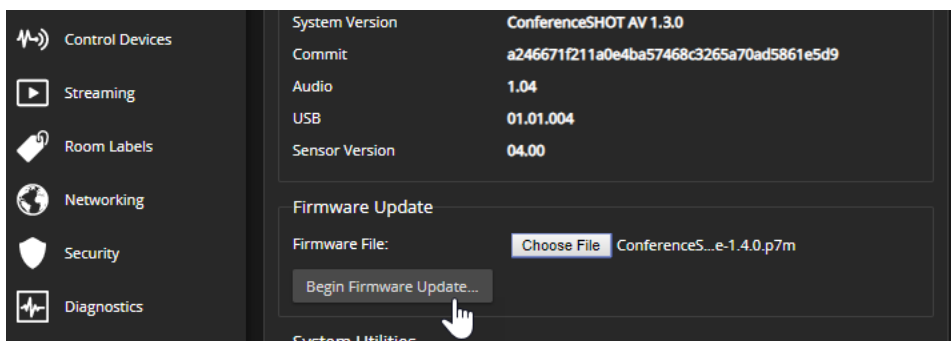

4. Read and understand the information in the Confirm dialog box.
5. Select Continue. A progress message box opens and the indicator light on the front of the camera turns yellow. If the update process presents warnings or error messages, read them carefully.

The camera reboots when the update is complete, and the web interface prompts you to log in again. Contact Vaddio Technical Support if you encounter any problems with the update.

Installing a Firmware Update for a Connected Microphone

SYSTEM PAGE, PERIPHERALS TAB

The process to update microphone firmware is the same as for updating the camera.

1. Download the firmware and release notes from the legrandav.com website. Microphone firmware is available on the microphone product page and the pages for the camera bundles that include the microphone that you have.
2. Select Choose File and navigate to the firmware file you downloaded.
3. Select the appropriate EasyMic port (1 or 2). You can only update one microphone at a time; this selection specifies which EasyMic connector the data will flow through.

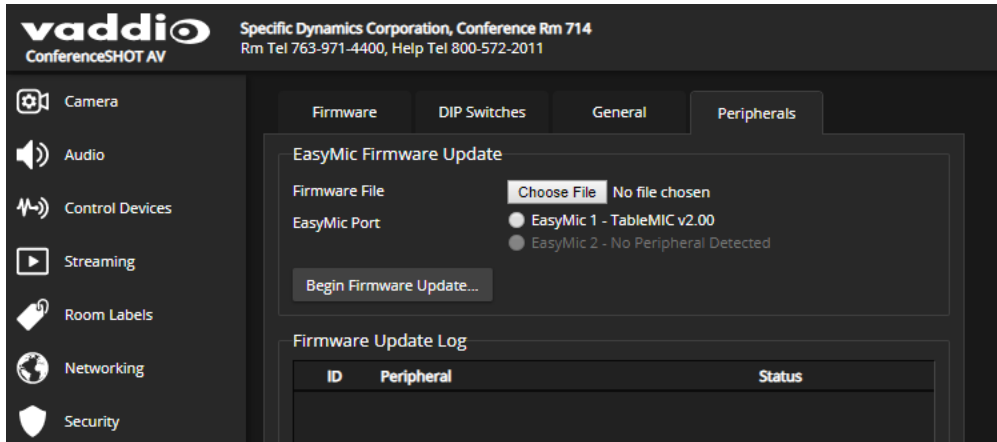

4. Select Begin Firmware Update.

Rebooting the Camera

SYSTEM PAGE, FIRMWARE TAB

This can help if the camera stops responding as you expect. In the System Utilities section, select Reboot.

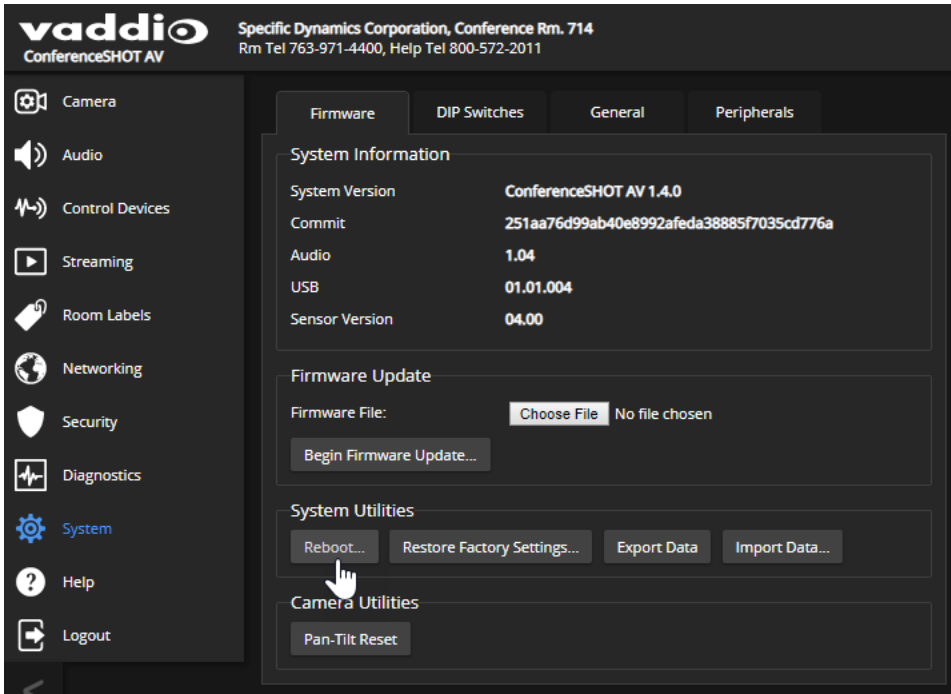

Contacting Vaddio Technical Support

HELP PAGE

If you can't resolve an issue using your troubleshooting skills (or the [Troubleshooting](#) tables in this manual), we are here to help.

You'll find information for contacting Vaddio Technical Support on the Help screen.

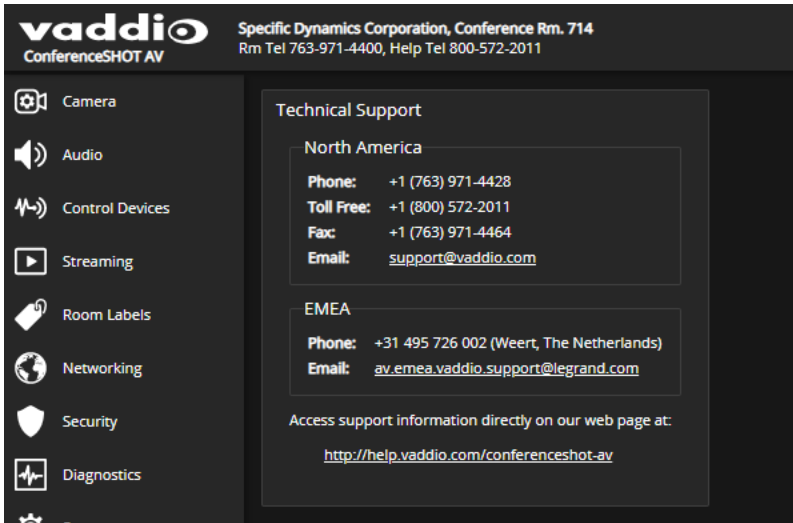

The screenshot shows the Vaddio ConferenceSHOT AV interface. At the top left is the Vaddio logo and 'ConferenceSHOT AV'. To the right, it says 'Specific Dynamics Corporation, Conference Rm. 714' and 'Rm Tel 763-971-4400, Help Tel 800-572-2011'. A sidebar on the left lists various system components: Camera, Audio, Control Devices, Streaming, Room Labels, Networking, Security, and Diagnostics. The main content area is titled 'Technical Support' and is divided into two sections: 'North America' and 'EMEA'. The North America section lists: Phone: +1 (763) 971-4428, Toll Free: +1 (800) 572-2011, Fax: +1 (763) 971-4464, and Email: support@vaddio.com. The EMEA section lists: Phone: +31 495 726 002 (Weert, The Netherlands) and Email: av.emea.vaddio.support@legrand.com. At the bottom of the technical support section, it says 'Access support information directly on our web page at: <http://help.vaddio.com/conferenceshot-av>'.

Viewing Diagnostic Logs

DIAGNOSTICS PAGE

If you encounter a problem that you can't solve, your Vaddio technical support representative may ask you to download and email the log file available from the Diagnostics screen.

Note

The log may include large numbers of internal events even when no errors have occurred. Rebooting generates over 100 log entries.

The screenshot shows the Vaddio ConferenceSHOT AV interface. At the top, it displays the Vaddio logo and the text "Specific Dynamics Corporation, Conference Rm. 714 Rm Tel 763-971-4400, Help Tel 800-572-2011". On the right side, there are control buttons for Mute, Standby, and Logout. On the left side, there is a navigation menu with icons for Camera, Audio, Control Devices, Streaming, Room Labels, Networking, Security, Diagnostics (highlighted), System, Help, and Logout. The main area is titled "Diagnostics" and displays a list of kernel log entries. At the bottom of the log area, there are buttons for Download, Refresh, Clear, and Restore, along with an "Auto-Refresh" checkbox.

```

Jan 28 07:53:06 vaddio-conferenceshot-av-D8-88-39-62-10-05 kernel: [ 1.110240] h264: Default mode is EWCODE
Jan 28 07:53:06 vaddio-conferenceshot-av-D8-88-39-62-10-05 kernel: [ 1.114126] aze_h264s 60000000.h264_axis_core: h264: added driver successfully
Jan 28 07:53:06 vaddio-conferenceshot-av-D8-88-39-62-10-05 kernel: [ 1.122230] sdhci: Secure Digital Host Controller Interface driver
Jan 28 07:53:06 vaddio-conferenceshot-av-D8-88-39-62-10-05 kernel: [ 1.128354] sdhci: Copyright (C) Pierre Ossman
Jan 28 07:53:06 vaddio-conferenceshot-av-D8-88-39-62-10-05 kernel: [ 1.132667] sdhci-pltfm: SDHCI platform and OF driver helper
Jan 28 07:53:06 vaddio-conferenceshot-av-D8-88-39-62-10-05 kernel: [ 1.197933] mmc0: SDHCI controller on e0100000.sdhci [e0100000.sdhci] using ADMA
Jan 28 07:53:06 vaddio-conferenceshot-av-D8-88-39-62-10-05 kernel: [ 1.208310] ledtrig-cpu: registered to indicate activity on CPUs
Jan 28 07:53:06 vaddio-conferenceshot-av-D8-88-39-62-10-05 kernel: [ 1.210010] nf_conntrack version 0.5.0 (6144 buckets, 24576 max)
Jan 28 07:53:06 vaddio-conferenceshot-av-D8-88-39-62-10-05 kernel: [ 1.224310] ip_tables: (C) 2000-2006 Netfilter Core Team
Jan 28 07:53:06 vaddio-conferenceshot-av-D8-88-39-62-10-05 kernel: [ 1.229843] Initializing XFRM netlink socket
Jan 28 07:53:06 vaddio-conferenceshot-av-D8-88-39-62-10-05 kernel: [ 1.234056] NET: Registered protocol family 17
Jan 28 07:53:06 vaddio-conferenceshot-av-D8-88-39-62-10-05 kernel: [ 1.238508] 8021q: 802.1Q VLAN Support v1.8
Jan 28 07:53:06 vaddio-conferenceshot-av-D8-88-39-62-10-05 kernel: [ 1.242773] Registering SWP/SWPB emulation handler
Jan 28 07:53:06 vaddio-conferenceshot-av-D8-88-39-62-10-05 kernel: [ 1.253799] ALSA device list:
Jan 28 07:53:06 vaddio-conferenceshot-av-D8-88-39-62-10-05 kernel: [ 1.256690]  #0: xylon-logii12s 0
Jan 28 07:53:06 vaddio-conferenceshot-av-D8-88-39-62-10-05 kernel: [ 1.258442] mmc0: new high speed SD card at address 0007
Jan 28 07:53:06 vaddio-conferenceshot-av-D8-88-39-62-10-05 kernel: [ 1.258833] mmcblk0: mmc0:0007 DDINC 951 MiB
Jan 28 07:53:06 vaddio-conferenceshot-av-D8-88-39-62-10-05 kernel: [ 1.264314] mmcblk0: p1 p2 p3 p4 < p5 p6 p7 p8 >
Jan 28 07:53:06 vaddio-conferenceshot-av-D8-88-39-62-10-05 kernel: [ 1.279188] Freeing unused kernel memory: 4096K
Jan 28 07:53:06 vaddio-conferenceshot-av-D8-88-39-62-10-05 kernel: [ 2.386290] lirc_gpio: module is from the staging directory, the quality is unknown, you
Jan 28 07:53:06 vaddio-conferenceshot-av-D8-88-39-62-10-05 kernel: [ 2.397290] lirc_gpio lirc_gpio.0: lirc_dev: driver lirc_gpio registered at minor = 0
Jan 28 07:53:06 vaddio-conferenceshot-av-D8-88-39-62-10-05 kernel: [ 2.405038] lirc_gpio: driver registered!
Jan 28 07:53:06 vaddio-conferenceshot-av-D8-88-39-62-10-05 kernel: [ 2.409066] lirc_gpio: using active low receiver on GPIO pin 981
Jan 28 07:53:06 vaddio-conferenceshot-av-D8-88-39-62-10-05 kernel: [ 6.545458] random: crng init done
Jan 28 07:53:10 vaddio-conferenceshot-av-D8-88-39-62-10-05 watchdog[1134]: starting daemon (5.15):
Jan 28 07:53:16 vaddio-conferenceshot-av-D8-88-39-62-10-05 kernel: [ 17.747354] macb e00b0000.ethernet eth0: link up (1000/Full)
Jan 28 07:53:41 vaddio-conferenceshot-av-D8-88-39-62-10-05 usbctl-service: become_master: FX3 did not to give us access to port..we have a request to parse f
Jan 28 07:54:01 vaddio-conferenceshot-av-D8-88-39-62-10-05 root: Rotating /var/log/boot to /media/vng-logs/
    
```

Using the Remote Control

The remote provides basic camera control. Some additional functionality is available from the non-administrative web interface.

Quick Reference

What do you need to do?	Button(s)
Power on or standby	Power (green button at top right)
Select the camera to control (if this remote controls more than one)	Camera Select buttons 1 through 3 (second row on the remote)
Discover the camera's IP address	Data Screen button (top left) – press and hold for 3 seconds
Move the camera	Arrow buttons and Home button (dark red)
Move the camera to a preset position	Position Preset buttons 1 through 6 (bottom two rows)
Focus the camera	Auto Focus button (near arrow buttons) Manual Focus buttons Near and Far (below Zoom Speed buttons)
Mute the microphone(s)	Mic Mute button (center)
Change the speaker volume	Volume buttons (center left)
Change zoom	Zoom buttons – T (telephoto) to zoom in and W (wide-angle) to zoom out. (center right)
Adjust for excess light behind the camera's subject	Back Light button (top center)
Correct a motor calibration fault condition (blinking yellow light)	Pan-Tilt Reset button (center right, beside arrow buttons)



IR Remote Details

The remote provides the following functions:

Data Screen – Press and hold for 3 seconds to display the camera's IP address and MAC address on the near-end display. Press momentarily to dismiss the information.

Power indicator – Shows power on, IR transmission, and battery level.

Power – Switch the selected camera on or off.

Back Light – Use or turn off back light compensation.

Camera Select – In multi-camera installations, selects the camera to be controlled. See [Camera Switch Settings](#) for information on configuring the camera as camera 1, 2, or 3.

Pan/Tilt (arrow button) controls and Home button – Control the camera's position.

Std. Pan and Rev. Pan – Control how the camera responds to the arrow buttons. Helpful for ceiling-mounted cameras and installations where the camera will point at the person using the remote.

Pan/Tilt Reset – Recalibrate the pan and tilt motors. If the camera gets jostled, you may need to push this button to ensure that the camera moves accurately to its home and preset positions.

Auto Focus – Switch the camera to Auto-Focus mode.

Volume Increase and Decrease – Control the speaker volume.

Mic Mute – Stop sending audio.

Zoom – Select **T** (telephoto) to zoom in or **W** (wide-angle) to zoom out.

Manual Focus – Switch the camera to Manual Focus mode.

Near (-) adjustment – Moves the focus nearer when in manual focus mode.

Far (+) adjustment – Moves the focus farther when in manual focus mode.

Position Presets 1 through 6 – Move the camera to a predefined position.

Preset – Save the camera's current position as one of the numbered presets.

Reset – Clear the saved position presets.

The web interface offers greater control over camera movements to presets, and provides additional presets.

Storing a Preset Using the Remote

Set up the shot using the pan, tilt, and zoom controls. Then hold down the **Preset** button and press one of the numbered preset buttons.

Clearing a Preset Using the Remote

Press and hold the **Reset** button while pressing the preset number you want to clear.

Operating the Camera from the Web Interface

CAMERA PAGE (USER OR GUEST ACCESS)

By default, the operator's page of the web interface is not available. The administrator must set a password for the `user` account or enable guest access.

Only the operator's page is available with user or guest access.

The operator's Camera page provides most of the same controls as the IR Remote Commander, along with some that are not available from the remote:

- Pan, tilt, zoom, or return to home position
- Stop or resume transmitting live camera video (video mute)
- Mute or unmute the microphone(s)
- Change the speaker volume
- Put the camera in standby or bring it back to the ready state
- Move to camera presets, if any have been stored

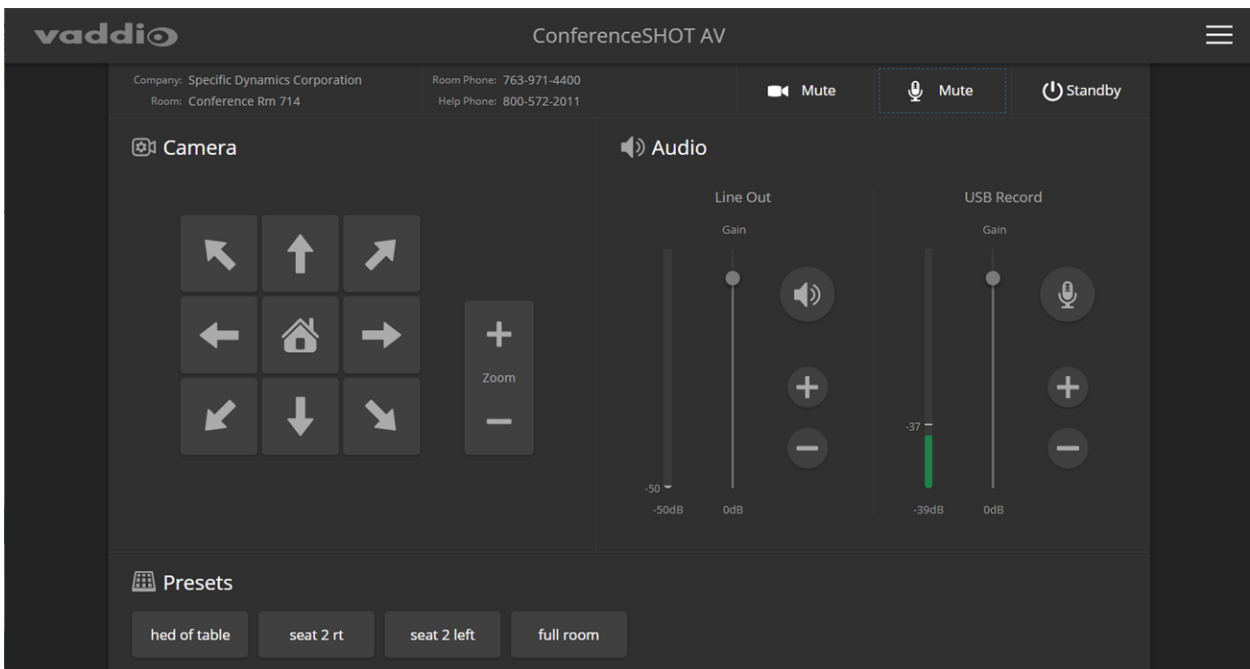

Stopping or Resuming Video

Use the video mute button to temporarily stop video from the camera without placing it in standby.

Remember that the mute button does not mute the room's microphones. In video mute mode, the camera transmits blue or black video, with a message that the video is muted.

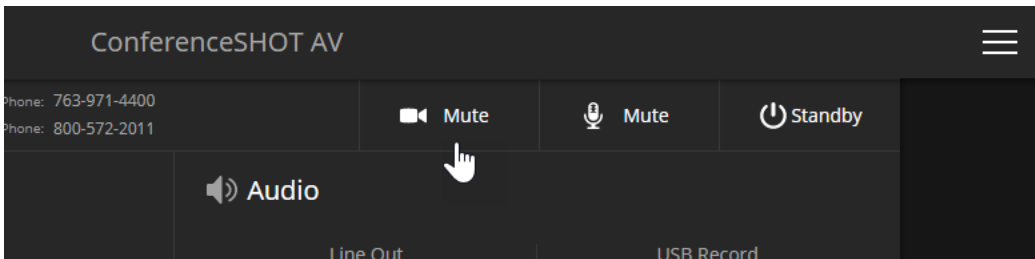

Managing the Camera Ready State

Use the Standby button to switch between low-power (standby) and ready states.

In standby mode, the screen presents the message “Device is in standby.” On entering standby mode, the camera pans 90° from center and 30° downward.

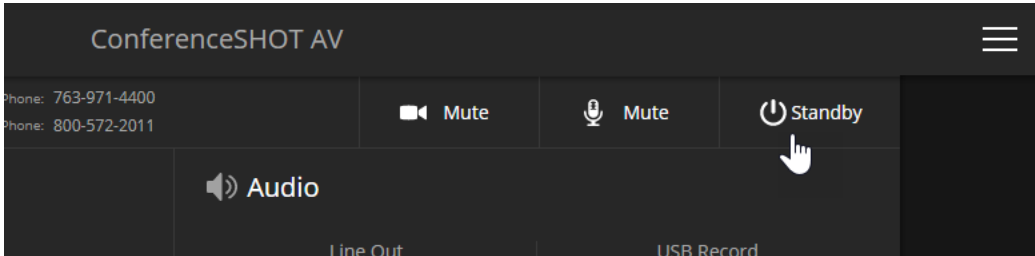

Muting Your Microphones

Use the audio mute button at the top of the web interface.

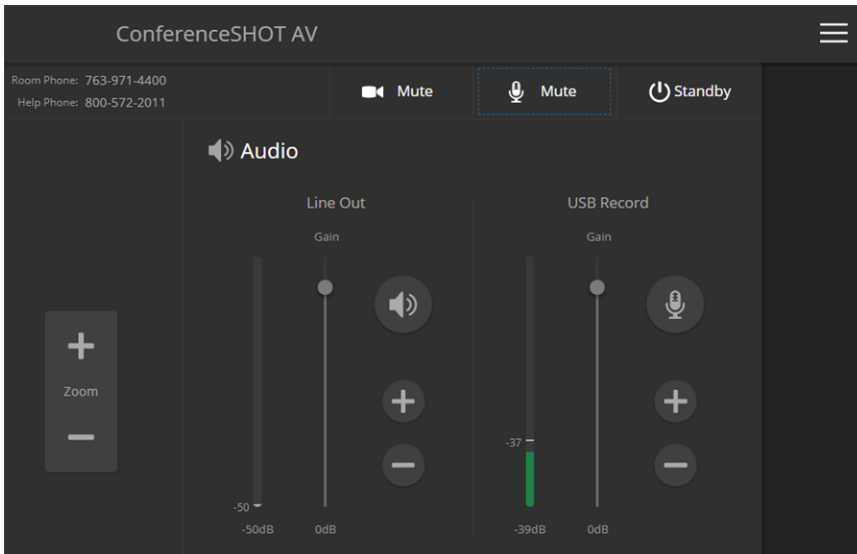

Adjusting Speaker and Microphone Volume

Use the Line Out slider or the + and - buttons to set the speaker volume.

Use the USB Record slider or the + and - buttons to set the microphone volume.

Note

For best performance with most computers, we recommend setting the USB Record volume high. If it is set too low, the people at the far end of the conference may have trouble hearing you.

Moving the Camera

Use the arrow buttons for camera pan and tilt. The center button moves the camera to the home position.

Zooming In or Out

Use the Zoom + button to zoom in and the Zoom – button to zoom out.

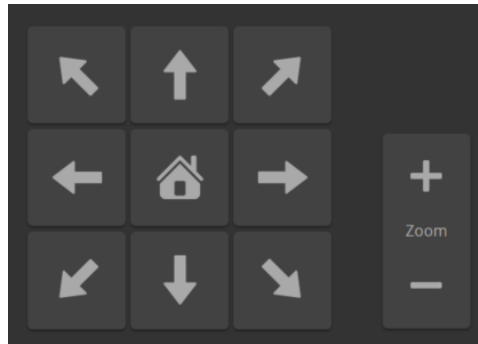

Moving the Camera to a Preset Position

Use the Preset buttons (if available) to move the camera to any of its programmed positions. Presets are only available if they have been set in the administrative interface.

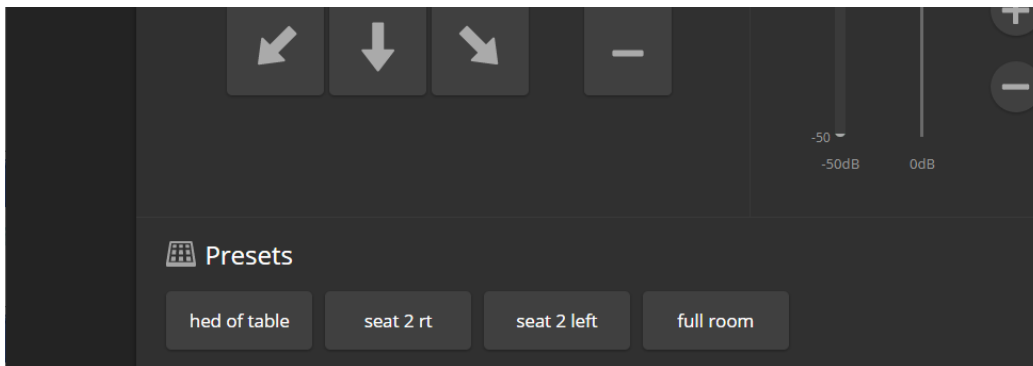

Camera and Video Management Commands

The following camera and video management commands are available:

- camera home
- camera pan
- camera tilt
- camera zoom
- camera ptz-position
- camera focus
- camera preset
- camera ccu get
- camera ccu set
- camera led
- camera icr
- video mute

camera home

Moves the camera to its home position and zoom level. Color settings may also be part of the home preset.

Synopsis	camera home
Example	> camera home OK >

camera pan

Moves the camera horizontally.

Synopsis	camera pan { left [<speed>] right [<speed>] stop get set <position> [<speed>] [no_wait] }	
Options	left	Moves the camera left.
	right	Moves the camera right.
	speed <1 - 24>	Optional: Specifies the pan speed as an integer (1 to 24). Default speed is 12.
	stop	Stops the camera's horizontal movement.
	set <position>	Sets the camera's absolute pan position in degrees, as a floating point value between approximately -160.00 (left) and 160.00 (right). This is the minimum range. Individual cameras may have slightly more travel before they reach their physical limits. The camera pan set command blocks execution of subsequent commands until the camera reaches the specified position.
	no_wait	Optional – allows the camera pan set command to return the command prompt immediately, while the requested camera movement is still in progress.
	get	Returns the camera's absolute pan position in degrees, as a floating point value between approximately -160.00 (left) and 160.00 (right).
Examples	<pre>>camera pan left OK ></pre> <p>Pans the camera left at the default speed.</p> <pre>>camera pan right 20 OK ></pre> <p>Pans the camera right using a speed of 20.</p> <pre>>camera pan stop OK ></pre> <p>Stops the camera's horizontal motion.</p> <pre>>camera pan set -15 OK ></pre> <p>Pans the camera to 15° left of its centerline at the default speed.</p>	

camera tilt

Moves the camera vertically.

Synopsis	camera tilt{ up [<speed>] down [<speed>] stop get set <position> [<speed>] [no_wait] }	
Options	up	Moves the camera up.
	down	Moves the camera down.
	speed <1 - 20>	Optional: Specifies the tilt speed as an integer (1 to 20). Default speed is 10.
	stop	Stops the camera's vertical movement.
	set <position>	Sets the camera's absolute tilt position in degrees, as a floating point value between approximately -30.00 and 90.00. This is the minimum range; individual cameras may have an additional degree or two of travel before they reach their physical limits. The <code>camera tilt set</code> command blocks execution of subsequent commands until the camera reaches the specified position.
	no_wait	Optional – allows the <code>camera tilt set</code> command to return the command prompt immediately, while the requested camera movement is still in progress.
	get	Returns the camera's absolute tilt position in degrees, as a floating point value between approximately -30.00 (down) and 90.00 (up). Note that the range is roughly 30.00 to -90.00 if Image Flip is selected.
Examples	<pre>>camera tilt up OK > Tilts the camera up at the default speed. >camera tilt down 20 OK > Tilts the camera down at a speed of 20. >camera tilt set -5 OK > Tilts the camera 5° down from level at the default speed.</pre>	

camera zoom

Moves the camera in toward the subject or out away from the subject.

Synopsis	camera zoom { in [<speed>] out [<speed>] stop get set <position> [<speed>] [no_wait] }	
Options	in	Zooms the camera in.
	out	Zooms the camera out.
	stop	Stops the camera's zoom movement.
	set <zoom>	Sets the camera's zoom level as a floating point value between 1.00 and 10.00 (12.00 in Super Wide Mode). The <code>camera zoom set</code> command blocks execution of subsequent commands until the camera reaches the specified position.
	no_wait	Optional – allows the <code>camera zoom set</code> command to return the command prompt immediately, while the requested camera movement is still in progress.
	get <zoom>	Returns the camera's zoom setting as a floating point value between 1.00 and 10.00 (12.00 in Super Wide Mode).
Examples	<pre>>camera zoom in OK > Zooms the camera in at the default speed. >camera zoom out 7 OK > Zooms the camera out using a speed of 7. >camera zoom stop OK > Stops the camera's zoom motion.</pre>	

camera ptz-position

Specifies multiple-axis movements to absolute positions.

Pan, tilt, and zoom may be specified in any order. All movements start simultaneously.

Synopsis	camera ptz-position pan <position> tilt <position> zoom <position> [no_wait]	
Options	pan <position>	<position> is a floating-point value approximately -160.00 to 160.00. Individual cameras may have slightly more travel.
	tilt <position>	<position> is a floating-point value approximately -30.0 to 93.0. Individual cameras may have slightly more travel.
	zoom <position>	<position> is a floating-point value 1.0 to 10.0.
	no_wait	Optional – allows the command to return the command prompt immediately, while the requested camera movement is still in progress.
Examples	<pre>>camera ptz-position pan -15 tilt 5 zoom 1.5 no_wait OK ></pre> <p>Moves the camera 15° left from its centerline and 5° up from horizontal, and zooms to 1.5. The command prompt appears while the camera is still in motion.</p>	

camera focus

Changes the camera focus.

Synopsis	<code>camera focus { near [<speed>] far [<speed> stop mode {get auto manual} }</code>	
Options	<code>near</code>	Brings the focus nearer to the camera. Can only be used when camera is in manual mode.
	<code>far</code>	Moves the focus farther from the camera. Can only be used when camera is in manual mode.
	<code>speed <1 - 8></code>	Optional: integer (1 to 8) specifies the focus speed.
	<code>mode [get auto manual]</code>	Returns the current focus mode, or specifies automatic or manual focus.
	<code>stop</code>	Stops the camera's focus movement.
Examples	<p>camera focus near OK > Brings the focus near at the default speed.</p> <p>camera focus far 7 OK > Moves the focus farther from the camera at a speed of 7.</p> <p>camera focus mode get auto_focus: on OK > Returns the current focus mode.</p>	



camera preset

Moves the camera to the specified preset, or stores the current camera position and optionally CCU information.

Synopsis	<code>camera preset { recall store} [1 - 16] [save-ccu]</code>	
Options	<code>recall [1 - 16]</code>	Moves the camera to the specified preset.
	<code>store [1 - 16]</code>	Stores the current camera position as the specified preset.
	<code>save-ccu</code>	Optional: Saves the current CCU (color and lighting) settings as part of the preset. If not specified, the last color settings are used when recalled.
Examples	<pre>>camera preset recall 3 OK > Moves the camera to preset 3. >camera preset store 1 OK > Saves the camera's current position as preset 1.</pre>	

camera ccu get

Returns CCU (lighting and color) information. Entering the command without specifying a parameter returns all current CCU settings.

Synopsis	camera ccu get <param>	
Options	auto_white_balance	Returns the current state of the auto white balance setting (on or off).
	red_gain	Returns the red gain value as an integer (0 to 255).
	blue_gain	Returns the blue gain value as an integer (0 to 255).
	backlight_compensation	Returns the current state of the backlight compensation setting (on or off).
	iris	Returns the iris value as an integer (0 to 11).
	auto_iris	Returns the current auto-iris state (on or off).
	gain	Returns the gain value as an integer (0 to 11).
	detail	Returns the detail value as an integer (0 to 15).
	chroma	Returns the chroma value as an integer (0 to 14).
	gamma	Returns gamma as an integer (-16 to 64)
	wide_dynamic_range	Returns the current setting for Wide Dynamic Range (on or off).
	all	Returns all current CCU settings.
Examples	<pre>>camera ccu get iris iris 6 OK ></pre> <p>Returns the current iris value.</p> <pre>>camera ccu get auto_iris on auto_white_balance on backlight_compensation off blue_gain 193 chroma 2 detail 8 gain 3 iris 11 red_gain 201 wide_dynamic_range off OK ></pre> <p>Returns all current CCU settings.</p>	

camera ccu set

Sets the specified CCU (lighting) information.

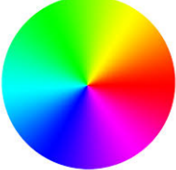
Synopsis	camera ccu set <param> <value>	
<p>Options</p> 	auto_white_balance {on off}	Sets the current state of the auto white balance setting (on or off). Auto white balance overrides red gain and blue gain manual settings.
	red_gain <0 - 255>	Sets the red gain value as an integer (0 to 255). Can only be used when auto white balance is off.
	blue_gain <0 - 255>	Sets the blue gain value as an integer (0 to 255). Can only be used when auto white balance is off.
	backlight_compensation {on off}	Sets the current state of the backlight compensation setting (on or off). Can only be used when wide dynamic range mode is off.
	iris <0 - 11>	Sets the iris value as an integer (0 to 11). Can only be used when auto-iris is off.
	auto_iris {on off}	Sets the auto-iris state (on or off). Auto-iris disables manual iris and gain when it is on.
	gain <0 - 11>	Sets gain value as an integer (0 to 11). Can only be used when auto-iris is off.
	detail <0 - 15>	Sets the detail value as an integer (0 to 15).
	chroma <0 - 14>	Sets the chroma value as an integer (0 to 14).
	gamma <-16 - 64>	Sets the gamma value as an integer (-64 to 64)
	wide_dynamic_range {on off}	Sets Wide Dynamic Range mode on or off. Can only be used when backlight compensation is off.
Examples	<pre>>camera ccu set auto_iris off OK > Turns off auto-iris mode, returning the camera to manual iris control. >camera ccu set red_gain 10 OK > Sets the red gain value to 10.</pre>	

camera led

Set or change the behavior of the indicator light.

Synopsis	camera led { get off on }	
Options	get	Returns the indicator light's current state (on or off).
	off	Disables the indicator light.
	on	Enables the indicator light.
Examples	<pre>>camera led off OK ></pre> <p>Disables the indicator light. When the LED is off, you cannot tell by looking at the camera whether it is sending video.</p> <pre>>camera led get led: on OK ></pre> <p>Returns the current state of the indicator light.</p>	

camera icr

Gets or sets the state of the camera's IR cut filter.

Synopsis	camera icr { get on off }	
Options	get	Returns the IR cut filter mode.
	on	Sets the IR cut filter on.
	off	Sets the IR cut filter off.
Examples	<pre>camera icr get IR(Cut) filter off(In) ></pre> <p>Returns the current IR cut filter state (off, in this case).</p> <pre>camera icr on OK ></pre> <p>Sets the IR cut filter on.</p>	

video mute

Gets or sets the camera's video mute status. When video is muted, the camera sends blue or black video with an on-screen message stating that video mute is on. This can be desirable when preparing the room, or when privacy is needed.

Note

In systems with audio, this command does not affect the audio.

Synopsis	video mute { get off on toggle }	
Options	get	Returns the current video mute status.
	off	Unmutes the video. (Normal video resumes.)
	on	Mutes the video. (Blue or black screen with message)
	toggle	Changes the camera's video mute status.
Examples	<pre>>video mute get mute: off OK ></pre> <p>Returns video mute status.</p> <pre>>video mute on OK ></pre> <p>Transmits blue or black video.</p>	

Audio Commands

The following audio commands are available:

- audio volume
- audio mute

audio volume

Gets or sets the volume of the specified audio channel.

Synopsis	audio < channel > volume { get up down set }	
Channels	master	Applies the command to all audio channels.
	easy_mic_1 easy_mic_2	EasyMic microphone inputs 1 and 2.
	usb_playback	Audio portion of the incoming (far-end) USB stream.
	line_out_1	Line Out port (speaker output).
	usb_record	Outbound (near-end) audio portion of the USB stream.
	ip_stream	Audio portion of the IP stream output.
Options	get	Returns the current volume of the specified channel.
	up	Increases the volume of the specified channel.
	down	Reduces the volume of the specified channel.
	set	Sets the volume of the specified channel.
Examples	<pre>audio line_in_1 volume set -5 OK ></pre> <p>Sets -5 dB as the volume for the device connected to the Line In 1 port.</p> <pre>audio line_out_1 volume get volume -10.0 dB OK ></pre> <p>Returns the current volume for the speaker connected to the line out port.</p>	

audio mute

Gets or sets the mute status of the specified audio channel.

Synopsis	<code>audio < channel > mute { get on off toggle }</code>	
Channels	<code>master</code>	Applies the command to all audio channels.
	<code>easy_mic_1</code> <code>easy_mic_2</code>	EasyMic microphone inputs 1 and 2.
	<code>usb_playback</code>	Audio portion of the incoming (far-end) USB stream.
	<code>line_out_1</code>	Line Out port (speaker output).
	<code>usb_record</code>	Outbound (near-end) audio portion of the USB stream.
	<code>ip_stream</code>	Audio portion of the IP stream output.
Options	<code>get</code>	Returns the current mute status of the specified channel.
	<code>on</code>	Mutes the audio for the specified channel.
	<code>off</code>	Unmutes the audio for the specified channel.
	<code>toggle</code>	Changes the mute state for the specified channel – unmutes if it was muted, mutes if it was not.
Examples	<pre>> audio line_out_1 mute get mute: off OK ></pre> <p>Returns the current mute state of the device connected to audio line out 1. Mute is off, so the audio is on.</p> <pre>> audio master mute on OK ></pre> <p>Mutes all audio.</p>	

Control and Power Commands

The following control and power commands are available:

- trigger
- camera standby

trigger

Turn an existing trigger on or off. This command has no effect if the specified trigger has not been defined or if the associated macro is unable to run.

Note

If the web interface's macro/trigger test mode is in use, this command may return parse errors.

Synopsis	trigger <1..10> { off on }	
Parameters	<1..10>	The trigger index (identifier) – triggers 1 through 10 are available.
	{off on}	Set the state of the trigger.
	block	Prevents subsequent commands from running until the macro finishes.
Example	<pre>> trigger 3 on OK Turns trigger 3 on.</pre>	

camera standby

Set or change camera standby status.

Synopsis	camera standby { get off on toggle }	
Options	get	Returns the camera's current standby state.
	off	Brings the camera out of standby (sleep) mode.
	on	Stops video and puts the camera in standby mode.
	toggle	Changes the camera's standby state - if it was not in standby mode, it enters standby; if it was in standby mode, it "wakes up."
Examples	<pre>> camera standby off OK > Brings the camera out of standby mode. > camera standby get standby: on OK > Returns the current standby state.</pre>	

Network and Communication Commands

The following communication-related commands are available:

- streaming ip enable
- streaming settings get
- network settings get

streaming ip enable

Set or change the state of IP streaming.

Synopsis	streaming ip enable { get on off toggle }	
Parameters	get	Returns the current state of IP streaming
	on	Enables IP streaming.
	off	Disables IP streaming.
	toggle	Changes the state of IP streaming (on if it was off, or off if it was on). streaming ip enable toggle has the same effect as selecting the Enable IP Streaming checkbox in the web interface.
Example	<pre>>streaming ip enable on > OK Enables IP streaming. >streaming ip enable get enabled: true > OK Returns the current state of IP streaming.</pre>	

streaming settings get

Returns current IP and USB streaming settings.

Synopsis	streaming settings get	
Parameters	IP Custom_Frame_Rate	Frame rate (Custom mode).
	IP Custom_Resolution	Resolution (Custom mode).
	IP Enabled	True if IP streaming is enabled, False if it is not.
	IP MTU	The current MTU setting (1400 is default)
	IP Port	Port number used for IP streaming. RTSP default is 554; RTMP default is 1935.
	IP Preset_Quality	Video quality (Easy mode).
	IP Preset_Resolution	Resolution (Easy mode).
	IP Protocol	IP streaming protocol in use (RTSP or RTMP).
	IP URL	URL where the RTSP stream is available.
	IP Video_Mode	Video quality mode (preset or custom).
	USB Active	True if a USB stream is present; false if not.
	USB Device	The USB Device Name currently assigned.
	USB Frame_Rate	Frame rate for the USB stream (negotiated with conferencing client). 0 when no USB stream is present.
	USB Resolution	Resolution of the USB stream (negotiated with conferencing client). 0x0 when no USB stream is present.
	USB Version	2 or 3, as negotiated with the conferencing client. 0 if no USB stream is present.
UVC Extensions_Enabled	Allow or disable far-end control of the camera.	
Example	<pre> >streaming settings get IP Custom_Frame_Rate 30 IP Custom_Resolution 1080p IP Enabled true IP Port 554 IP Preset_Quality Standard (Better) IP Preset_Resolution 1080p IP Protocol RTSP IP URL vaddio-conferenceshot-av-stream IP Video_Mode preset USB Active false USB Device ConferenceSHOT AV USB Frame_Rate 0 USB Resolution 0x0 USB Version 3 UVC Extensions_Enabled false OK > </pre>	

network settings get

Returns the camera's current network settings and MAC address.

Synopsis	<code>network settings get</code>
Example	<pre>network settings get Name eth0:WAN MAC Address 00:1E:C0:F6:CA:7B IP Address 192.168.1.67 Netmask 255.255.255.0 VLAN Disabled Gateway 192.168.1.254 OK ></pre>

Maintenance and Troubleshooting Commands

The following commands are available for maintenance and troubleshooting:

- camera recalibrate
- network ping
- system reboot
- system factory-reset
- version

camera recalibrate

Recalibrates the pan and tilt motors. This is typically done in response to a motor fault indication or error message.

Synopsis	camera recalibrate
Example	>camera recalibrate OK >

network ping

Sends an ICMP ECHO_REQUEST to the specified hostname or IP address.

Synopsis	network ping [count <count>] [size <size>] <string>	
Options	<count>	The number of ECHO_REQUEST packets to send. Default is five packets.
	<size>	The size of each ECHO_REQUEST packet. Default is 56 bytes.
	<string>	The hostname or IP address where the ECHO_REQUEST packets will be sent.
Examples	<pre>>network ping 192.168.1.66 PING 192.168.1.66 (192.168.1.66): 56 data bytes 64 bytes from 192.168.1.66: seq=0 ttl=64 time=0.476 ms 64 bytes from 192.168.1.66: seq=1 ttl=64 time=0.416 ms 64 bytes from 192.168.1.66: seq=2 ttl=64 time=0.410 ms 64 bytes from 192.168.1.66: seq=3 ttl=64 time=0.410 ms 64 bytes from 192.168.1.66: seq=4 ttl=64 time=3.112 ms --- 192.168.1.66 ping statistics --- 5 packets transmitted, 5 packets received, 0% packet loss round-trip min/avg/max = 0.410/0.964/3.112 ms ></pre> <p>Sends five ECHO_REQUEST packets of 56 bytes each to the host at 192.168.1.66.</p>	
	<pre>>network ping count 10 size 100 192.168.1.1</pre> <p>Sends 10 ECHO_REQUEST packets of 100 bytes each to the host at 192.168.1.1. The command returns data in the same form as above.</p>	

system reboot

Reboots the system either immediately or after the specified delay. Note that a reboot is required when resetting the system to factory defaults (system factory-reset).

Synopsis	system reboot [<seconds>]	
Options	<seconds>	The number of seconds to delay the reboot.
Examples	<pre>>system reboot OK > The system is going down for reboot NOW!conferenceshot-av-D8-80-39-62-A7-C5 Reboots the system immediately. >system reboot 30 Reboots the system in 30 seconds. The response is in the same form; the system message appears at the end of the delay.</pre>	

system factory-reset

Gets or sets the factory reset status. When the factory reset status is on, the system resets to factory defaults on reboot.

Synopsis	system factory-reset { get on off }	
Options	get	Returns the camera's current factory reset status.
	on	Enables factory reset on reboot and returns the camera's current factory reset status.
	off	Disables factory reset on reboot and returns the camera's current factory reset status.
Examples	 <pre>>system factory-reset get factory-reset (software): off factory-reset (hardware): off OK > Returns the factory reset status. This evaluates the most recent system factory-reset on or off command, if one has been received. >system factory-reset on factory-reset (software): on factory-reset (hardware): off OK > Enables factory reset upon reboot. Note This command does not initiate a factory reset. The factory reset takes place on the next reboot.</pre>	

version

Returns the current firmware version.

Synopsis	<code>version</code>
Example	<pre>>version Audio 1.04 Commit a3f80d6fc1dd20dd4578579be44942c02dc0ca45 Sensor Version 06.00 System Version ConferenceSHOT AV 1.5.0 USB 01.02.000 OK ></pre>

Telnet Information and Session Management Commands

The following commands are available for Telnet help and session management:

- history
- help
- exit

history

Returns the most recently issued commands from the current Telnet session. Since many of the programs read user input a line at a time, the command history is used to keep track of these lines and recall historic information.

Synopsis	history <limit>	
Options	<limit>	Integer value specifying the maximum number of commands to return.
Examples	history Displays the current command buffer. history 5 Sets the history command buffer to remember the last 5 unique entries.	
Additional information	You can navigate the command history using the up and down arrow keys. This command supports the expansion functionality from which previous commands can be recalled from within a single session. History expansion is performed immediately after a complete line is read. Examples of history expansion: * !! Substitute the last command line. * !4 Substitute the 4th command line (absolute as per 'history' command) * !-3 Substitute the command line entered 3 lines before (relative)	



help

Displays an overview of the CLI syntax.

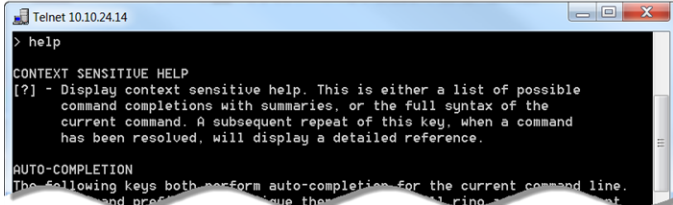
Synopsis	help
Example	help 



exit

Ends the command session and closes the socket.

Synopsis	exit
Example	exit

Specifications

Camera and Image

Image device	1/2.8-type Exmor CMOS sensor	Pixels	2.14 million (effective)
IP (H.264) RTSP and RTMP Video Resolutions	1080p down to 180p 1080p at 30/25/15; others 60/30/25/15	USB 3.0 (UVC) Video Resolutions	1080p down to 180p at 60/30/15
Pan angle and speed	± 160°, up to 90°/sec	Tilt angle and speed	+90° -30°, up to 90°/sec
Lens and horizontal FOV	10x optical zoom, 67.0° wide to 7.6° tele, f=3.8mm to 38mm, F1.8 to F3.4 Super-wide: 12x optical zoom, 74° wide to 7.6° tele, f=3.8mm to 41.8mm, F1.8 to F3.4		
Min. working distance	10mm (wide), 1.0m (tele)	Min. illumination	100+ lux recommended
Aperture/detail	16 steps	Gain	Auto or manual
Backlight compensation	On or off	White balance	Auto, manual, One-Push
Focusing system	Auto or manual	Noise reduction	On or off
Sync system	Internal	S/N ratio	Over 50 dB
Remote management	Web interface, Telnet	Power	PoE+ (25 watts)

Audio

EasyMic Inputs (2 channels available)	RJ-45 12V, bidirectional, balanced	Line Out	4-pin Phoenix type terminal block Impedance: 50 ohms Frequency response 20Hz - 20KHz THD + noise < 0.02% Maximum output level +12 dBu differential audio Power to speaker: 12V, 0.84A max (10 watt speaker)
IP Streaming	1 Channel (PCM), 16-bit resolution, 48 KHz sample rate		
USB streaming (record, playback)	2 Channel (UAC), 16-bit resolution, 48 KHz sample rate		

Physical and Environmental

Height	Camera: 6.54 in. (16.6 cm) Speaker: 3.6 in. (9.2 cm)	Operating temperature	0°C to +40°C (32°F to 104°F)
Width	Camera: 7.12 in. (18.1 cm) Speaker: 7.34 in. (18.6 cm)	Operating humidity (relative)	20% to 80% non-condensing
Depth	Camera: 6.5 in. (16.5 cm) Speaker: 6.7 in. (17.1 cm)	Storage temperature	-5°C to +60° C (23°F to 140°F)
Weight	Camera: 3.6 lbs.(1.63 kg) Speaker: 1.6 lbs. (0.72 kg)	Storage humidity (relative)	20% to 80% non-condensing

Specifications are subject to change without notice.

Troubleshooting and Care

When the camera doesn't behave as you expect, check the indicator light on the front before you do anything else.

Use this table to determine whether it's time to call Vaddio Technical Support.

Power and Control

What is it doing?	Possible causes	Check and correct
Nothing. The light on the front is off and no video is available.	At least one of the cables is bad.	Check using known good cables.
	The wall outlet is not active. (Check by finding out if it powers something else, such as a laptop or phone charger.)	Use a different outlet.
	The camera or its power supply is bad.	Contact your reseller or Vaddio Technical Support.
The light on the front of the camera is off but the web interface and video are available.	The status light is turned off.	You can turn it on again using the LED On setting on the General tab of the System page, or using the Telnet command <code>camera led on</code> .
The camera is not responding to the remote and the light is yellow.	A firmware update is in progress.	Wait a few minutes, and try again when the light turns blue.
The camera does not respond to the remote, but the web interface is available.	The remote is not using the same IR channel as the camera.	Change the IR channel with the Camera Select buttons on the remote.
	The batteries in the remote are dead.	Put new batteries in the remote.
	The batteries were installed incorrectly in the remote.	Install the batteries as shown in the diagram inside the remote.
The camera responds to the remote but the web interface is not available.	The camera is not using the IP address you browsed to.	Press the Data Screen button on the remote to see camera information.

Video and Streaming

What is it doing?	Possible causes	Check and correct
No H.264 video stream.	IP streaming is not enabled.	Enable IP streaming: Streaming page in the web interface.
Black and white video.	The IR cut filter is on. Send the Telnet command <code>camera icr get</code> to verify.	Send the Telnet command <code>camera icr off</code> to turn off the IR cut filter and return to normal video.

Audio

What is it doing?	Possible causes	Check and correct
No audio from the speaker (far-end audio)	Far-end microphone is muted (the conferencing window may show a mute icon for that site's microphone)	Ask the participants at that site to unmute their microphone.
	Speaker is not connected.	Check all connections carefully.
	HDMI audio embedder is connected incorrectly.	
	Speaker volume is turned all the way down.	You checked that first, right?
Far end reports that they can't hear you. (No near-end audio)	Microphone is not connected.	Check all connections carefully.
	Your microphone is muted.	Unmute your microphone.
Echo cancellation is not working.	Conference audio from the far end is going to the computer speaker or to external speakers connected to the computer	Connect least one Vaddio microphone to the camera, and do one of these things: <ul style="list-style-type: none"> ■ Use the ConferenceSHOT AV speaker ■ Use the HDMI Audio Embedder to send far-end conference audio to the display's speakers. These solutions both provide echo cancellation.
	The soft conferencing client is not using the speaker and microphone(s) connected to the camera.	In the soft conferencing client, select the speakers and microphone connected to the camera as the conference audio devices.

Other Issues

What is it doing?	Possible causes	Check and correct
Status light continues to blink blue.	The USB cable is not connected.	Connect the USB cable.
Status light blinks yellow	Pan or tilt motor is out of calibration	Reset the pan and tilt motors. See Correct a Motor Calibration Error (next section).

Need help? Call Vaddio Technical Support at (+1) 763-971-4400 or 800-572-2011.

Status Indicator Light

The light in the camera's base indicates its current state.

- Blue – Camera is active
- Purple – Standby mode or booting
- Yellow – Firmware update is in progress
- Blinking blue – USB cable is disconnected (UC color scheme)
- Blinking red – Video mute is on (UC color scheme)
- Blinking yellow – Motor out of calibration

Caution

Do not remove power or reset the camera while the indicator is yellow, showing a firmware update in progress. Interrupting a firmware update can make the camera unusable.

Note

By default, the camera's status indicator light is active during normal operation; however, it can be configured to remain off when the camera is powered up. The camera may be sending video even if the light is off.

Correct a Motor Calibration Error

If the web interface presents an error message about the motors, or if the camera's status light is blinking yellow, you will need to reset the pan and tilt motors.

1. On the Camera Controls page, select Settings to open the pan and tilt settings box;
OR
On the System page, go to the Firmware tab if you are on a different tab.
2. Select Pan-Tilt Reset. The motors recalibrate. This takes a few seconds.

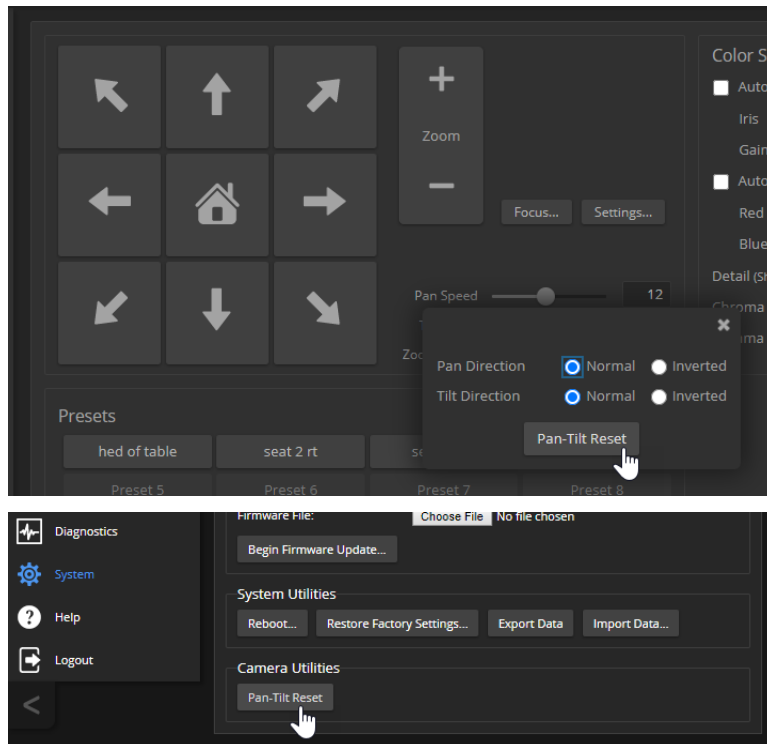

Restoring Default Camera Settings

SYSTEM PAGE

This returns the camera to its original state. If you export the camera's configuration before restoring factory defaults, you will be able to restore the room label, time zone information, and home information by importing the configuration afterward.

Log on using the admin account, go to the System page's Firmware tab, and select Restore Factory Settings.

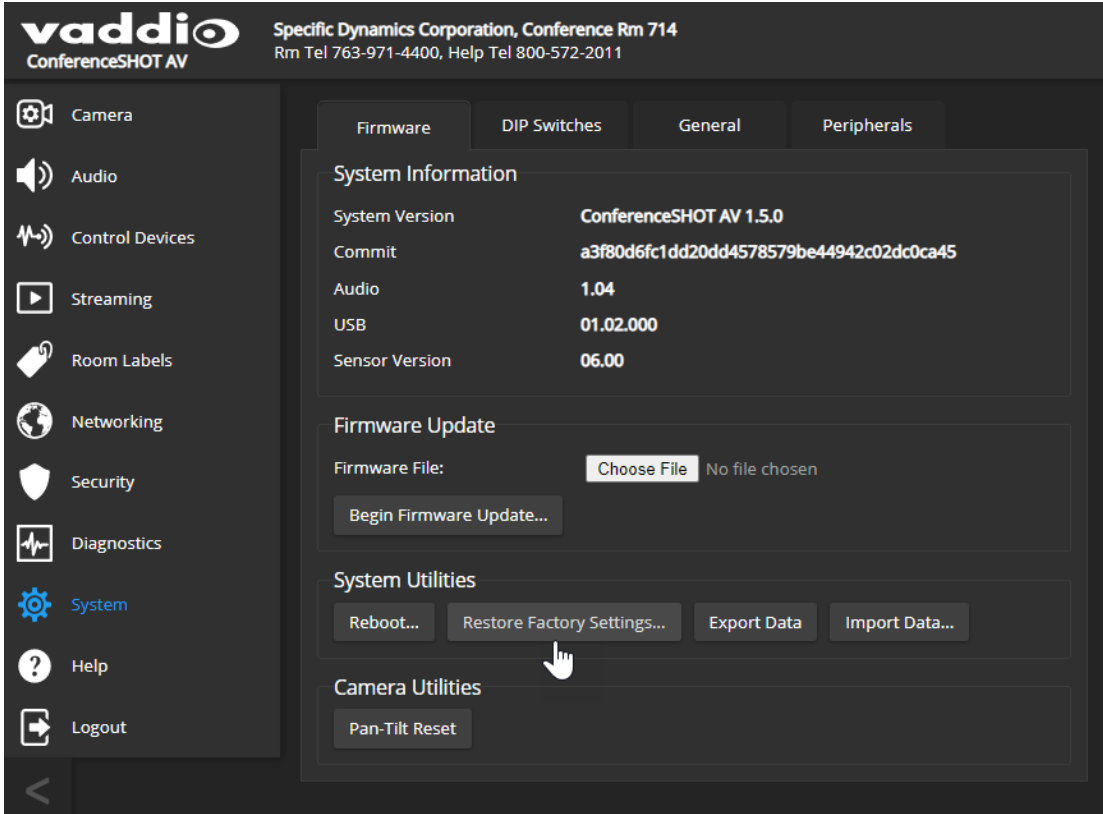

Operation, Storage, and Care

For smears or smudges on the product, wipe with a clean, soft cloth. Use a lens cleaner on the lens. Do not use any abrasive chemicals.

Keep this device away from food and liquids.

Do not operate or store the device under any of the following conditions:

- Temperatures above 40° C (104° F) or below 0° C (32° F)
- High humidity, condensing or wet environments
- Inclement weather
- Severe vibration
- In a wind tunnel
- Dry environments with an excess of static discharge

Do not attempt to take this product apart. There are no user-serviceable components inside.

Glossary

AEC

Acoustic echo cancellation. Audio processing that subtracts the far-end (speaker) audio from the sound that your microphone picks up.

auto white balance

A setting that allows the camera to manage color adjustments automatically.

backlight compensation

A setting that reduces contrast to adjust for bright light behind the main subject of the shot.

bandwidth

Data transfer rate (bits per second) for the stream. In some cases, using a high bandwidth can slow down other network traffic. On networks with very low bandwidth, video issues may result. Streaming at a lower resolution or frame rate can reduce bandwidth usage.

chroma

A setting that adjusts color intensity.

detail

A setting that adjusts image sharpness. If detail is set too low, the image may appear unrealistically smooth.

DHCP

Dynamic Host Configuration Protocol. A network management protocol that assigns an IP address to a device automatically when it is connected to the network.

DIY

Do It Yourself. As in, "You can copy information from this document to create a DIY room guide customized for your conference room." Yes! You can do that! In fact, the "Info for DIY Room Guides" document is specifically designed for you to adapt and customize.

dynamic range

The amount of difference between extremes - for example, the darkest and lightest areas in a shot, or the softest and loudest sounds that a microphone picks up.

EasyMic

Vaddio's proprietary connectivity standard for conferencing microphones.

echo cancellation

Audio processing that subtracts the far-end (speaker) audio from the sound that your microphone picks up.

far end

(conferencing) A location in the conference other than the one where you are. Far-end video is what you typically see in a conference – the people at the other end of the call.

Field of View (FOV)

How wide the video image is. Vaddio measures horizontal field of view. Some manufacturers use diagonal field of view, which yields a bigger number for the same actual image area. Tilt your head to one side and diagonal FOV will make sense.

flombodulator

A technically complex item the name of which you can't recall at the moment.

frame rate

The number of output video frames per second. Different outputs (such as the IP stream and the USB stream) may use different frame rates. For streaming, higher frame rates use more bandwidth.

full-duplex

Simultaneous two-way (or multi-way) audio; conference participants at the near end can talk and still hear the participants at the far end(s), as in a face-to-face meeting.

gamma

A setting that adjusts the range (gray density) between bright areas and shadows.

gateway

Network information automatically assigned in a DHCP network. If installing equipment on a non-DHCP network, get this information from the network administrator.

HDMI

A video output format; may also carry audio information.

HID audio controls

(Human Interface Device) Controls to enable conference participants to use the conferencing client to control the audio.

home (camera)

The settings to which the camera returns after a reboot or on exiting standby mode. Depending on the camera's capabilities, home may include zoom, color and lighting settings, and (for PTZ cameras) pan/tilt position.

home button (microphone)

A One Touch trigger control on a tabletop microphone. The button can be associated with one macro in momentary mode, or two macros in latching mode.

HTTP

HyperText Transfer Protocol. The magic that makes websites work.

HTTPS

HyperText Transfer Protocol Secure. The magic that uses encryption to make websites work securely. See SSL certificate for more information.

IP address

Where a given device is on the IP network, logically. The IP address enables the network to route data to the right device – and that's the reason IP address conflicts are bad.

IP address conflict

Two or more devices attempting to use the same IP address on a network. Results are unpredictable but never good.

LED

Light-Emitting Diode. An indicator light.

macro

A defined sequence of commands that a device performs in response to a trigger event.

mic

Microphone. Pronounced "mike" because the etymology matters more than English pronunciation rules, which are inconsistent anyway.

MTU

Maximum Transmission Unit. The largest number of bytes allowed in a packet. If you don't know what that means, don't change MTU size.

near end

(conferencing) Your location in a conference. When you mute the video, your camera stops sending near-end video.

NTP

Network Time Protocol. Ensures that NTP-enabled devices on the network all show the same system time, so timestamps are accurate.

PoE, PoE+, PoE++

Power over Ethernet; a means of powering a device using its network connection. Requires a mid-span power injector. PoE+ and PoE++ deliver more power than PoE.

preset

A stored camera position. Contains pan, tilt, and zoom position; may also include color settings.

RCLB

Really Cool Logo Badge. A visual cue that the device is a genuine Vaddio product. Accept no substitutes!

resolution

1. The image size. For Vaddio cameras, resolution is expressed in terms of digital TV standards, with 1080p being the default in most cases. Resolution and frame rate are set together on Vaddio cameras.
2. The thing that usually flies out the window by January 10th.

RTMP

Real-Time Messaging Protocol. Used for livestreaming video (and audio, if available) to a service such as YouTube Live.

RTSP

Real-Time Streaming Protocol. Used for streaming video and audio over your network.

soft conferencing client

A conferencing application (such as Zoom, Google Hangouts, or Skype for Business) that uses a computer rather than requiring a conferencing codec.

SSL certificate

A file used with HTTPS proving that a web page really originates from its purported source. If you enable or require HTTPS on a camera or other device without installing an SSL certificate, your browser will pop up security warnings when you try to browse to the device's web interface.

streaming protocol

A set of rules that define how video and audio data are sent over the network. See RTMP and RTSP.

subnet mask

Network information automatically assigned in a DHCP network. If installing equipment on a non-DHCP network, get this information from the network administrator.

trigger

An event, such as pressing the Home button on a connected TableMIC, that can be associated with a macro (defined command sequence). Devices that originate trigger events are sometimes called triggers or trigger devices.

UAC drivers

(Universal Audio Class) Standard USB audio drivers used by Vaddio conferencing products with audio capabilities.

UCC, UC conferencing

Unified Communications Conferencing; refers to soft-client conferencing (such as Zoom or Skype for Business) using a computer with USB-connected peripherals.

USB 2

An older, lower-speed USB protocol; good for audio but offers lower maximum resolutions for video conferencing. USB 2 products can be connected to USB 2 or USB 3 ports on your computer.

USB 3

A high-speed USB protocol, capable of handling high-quality video and audio as in conferencing applications. USB 3 products should be connected to USB 3 ports; performance may be degraded otherwise.

USB playback

Audio from other sites (far-end audio) in a conference call.

USB record

Audio from your site (near-end audio) in a conference call.

UVC drivers

(Universal Video Class) Standard USB video drivers used by Vaddio cameras. They're the reason your computer doesn't have to stop and download a driver when you connect your new Vaddio USB camera to it.

UVC extensions

Controls in UVC drivers to allow participants at the far end of a conference to control your camera, if it processes UVC commands. The administrator may choose to disable these.

Compliance and Conformity Statements

Compliance testing was performed to the following regulations:

FCC Part 15 (15.107, 15.109), Subpart B	Class A
ICES-003, Issue 54: 2012	Class A
EMC Directive 2014/30/EU	Class A
EN 55032: 2015	Class A
EN 55024: November 2010	Class A
IEC 60950-1:2005 (2nd Edition); Am 1: 2009 + Am 2: 2013	Safety
EN 60950-1: 2006 + A11: 2009 + A1: 2010 + A12: 2011 + A2: 2013	Safety

FCC Part 15 Compliance

This equipment has been tested and found to comply with the limits for a Class A digital device, pursuant to Part 15, Subpart B, of the FCC Rules. These limits are designed to provide reasonable protection against harmful interference when the equipment is operated in a commercial environment. This equipment generates, uses, and can radiate radio frequency energy and, if not installed and used in accordance with the instruction manual, may cause harmful interference to radio communications. Operation of this equipment in a residential area is likely to cause harmful interference in which case the user will be required to correct the interference at his/her own expense.

Operation is subject to the following two conditions: (1) This device may not cause interference, and (2) This device must accept any interference including interference that may cause undesired operation of the device.



Changes or modifications not expressly approved by Vaddio can affect emission compliance and could void the user's authority to operate this equipment.

ICES-003 Compliance

This digital apparatus does not exceed the Class A limits for radio noise emissions from digital apparatus set out in the Radio Interference Regulations of the Canadian Department of Communications.

Le présent appareil numérique n'émet pas de bruits radioélectriques dépassant les limites applicables aux appareils numériques de la classe A prescrites dans le Règlement sur le brouillage radioélectrique édicté par le ministère des Communications du Canada.



European Compliance

This product has been evaluated for Electromagnetic Compatibility under the EMC Directive for Emissions and Immunity and meets the requirements for a Class A digital device. In a domestic environment this product may cause radio interference in which case the user may be required to take adequate measures.

Standard(s) To Which Conformity Is Declared:



EMC Directive 2014/30/EU

EN 55032: 2015 – Conducted and Radiated Emissions

EN 55024: November 2010 – Immunity

IEC 60950-1: 2005 (2nd Edition); Am 1: 2009 + Am 2: 2013 – Safety

EN 60950-1: 2006 + A11: 2009 + A1: 2010 + A12: 2011 + A2: 2013 – Safety

IEC 62368-1: 2014 (2nd Edition) – Safety

Photo Credits

This guide may include some or all of these photos.

European Space Agency (ESA) astronaut Samantha Cristoforetti, a Flight Engineer with Expedition 42, photographs the Earth through a window in the Cupola on the International Space Station

By NASA - https://blogs.nasa.gov/ISS_Science_Blog/2015/03/06/women-in-space-part-two-whats-gender-got-to-do-with-it/, Public Domain, <https://commons.wikimedia.org/w/index.php?curid=38834990>

Carl Sagan, Bruce Murray, Louis Friedman (founders) and Harry Ashmore (advisor), on the occasion of signing the papers formally incorporating The Planetary Society

By credit NASA JPL - JPL, Public Domain, <https://commons.wikimedia.org/w/index.php?curid=1180927>

Main Control Room / Mission Control Room of ESA at the European Space Operations Centre (ESOC) in Darmstadt, Germany

By European Space Agency - ESOC flickr, Credit: ESA - Jürgen Mai, CC BY-SA 3.0-igo,

<https://commons.wikimedia.org/w/index.php?curid=36743173>

Expedition 42 on orbit crew portrait, International Space Station, Mar. 7, 2015 – Barry Wilmore (Commander) Top, Upside down, to the right cosmonaut Elena Serova, & ESA European Space Agency Samantha Cristoforetti. Bottom center US astronaut Terry Virts, top left cosmonauts Alexander Samokutyaev and Anton Shkaplerov.

By NASA - <https://www.flickr.com/photos/nasa2explore/16166230844/>, Public Domain,

<https://commons.wikimedia.org/w/index.php?curid=38931301>

European Space Agency astronaut Luca Parmitano, Expedition 36 flight engineer, outside the International Space Station

By NASA - <http://spaceflight.nasa.gov/gallery/images/station/crew-36/html/iss036e016704.html>, Public Domain, <https://commons.wikimedia.org/w/index.php?curid=27263573>

Chris Cassidy, Luca Parmitano, and Karen Nyberg, ISS, 2013. Photo Credit: NASA

Nicolas Altobelli, Rosetta Scientist at ESA's European Space Astronomy Centre, Villanueva de la Cañada, Madrid, Spain

By European Space Agency - Nicolas Altobelli talks to the media, CC BY-SA 3.0-igo,

<https://commons.wikimedia.org/w/index.php?curid=36743144>

Andrea Accomazzo, ESA Rosetta Spacecraft Operations Manager, providing a live update from the Main Control Room at ESA's European Space Operations Centre, Darmstadt, Germany during the Rosetta wake-up day.

By European Space Agency - Live update from the Main Control Room, CC BY-SA 3.0-igo,

<https://commons.wikimedia.org/w/index.php?curid=36743150>

Sleeping goose

By ladypine - Own work, CC BY-SA 3.0, <https://commons.wikimedia.org/w/index.php?curid=1695227>

By Rick Dikeman - Image:Wayne Gretzky 1997.jpg, CC BY-SA 3.0,

<https://commons.wikimedia.org/w/index.php?curid=945698>

Photo AS11-40-5948, Aldrin assembles seismic experiment, by National Aeronautics and Space Administration, courtesy of the NASA History Office and the NASA JSC Media Services Center

Index

A

- absolute position 69-70, 72
- admin password 21, 23
 - changing 23
 - initial 21
- AEC 8-10, 39
- AGC (automatic gain control) 39
- anatomy of the system 3-4
- audio 4, 38-40, 62, 79-80
 - connections 4
 - controls 39-40
 - delay 40
 - muting 38, 62, 80
 - volume 79
 - volume controls 38
- Audio page (web) 38-40
- auto focus 34, 73
- auto iris 32, 75-76
- auto white balance 32-33, 75-76

B

- backing up a configuration 55
- backlight compensation 32-33, 75-76
- bandwidth 45
- behavior on power-up 13
- bit rate (IP streaming setting) 45
- blue gain 32-33, 75-76
- browsers 14, 19
 - compatibility 14
 - HTTP and HTTPS access 19
 - security warnings 19

C

- cable connectors 4, 6
- calibration fault, correcting 85, 92
- camera ID setting 53
- camera mount 5, 9
- camera placement 5
- camera select 62-63
- camera specifications 89
- camera standby position 65
- capabilities 1, 89
- CCU settings 29, 32-33, 74-76
 - adjusting 33
 - in the web interface 32

- storing with a preset 29, 74
- ceiling-mounted cameras 8
- cheat sheet 21, 33, 62-63
 - color adjustment 33
 - lighting and image quality 33
 - remote control 62
 - web interface 21
- chroma setting 32-33, 75-76
- cleaning 93
- color codes for status light 8, 92
- color settings 32-33, 75-76
- command history 88
- compatibility, browsers 14
- conferencing 41-42
- configuration, saving or restoring 55
- connecting the speaker 12
- connection diagram 9-10
- connectors 4
- Constant Bit Rate (IP streaming setting) 45
- Control Devices page (web) 48
- Controls page (web) 64
- custom home position 29

D

- damage, preventing 2, 5-6
- default IP address 26
- default settings, restoring 86, 93
- detail setting 32-33, 75-76
- DHCP vs. non-DHCP networks 19, 26
- diagnosing issues 85, 90
- diagnostic logs 61
- Diagnostics page (web) 61
- diagram, connection 9-10
- DIP switches 53
- directional controls 62-63, 66
- dynamic range (audio) 39-40

E

- echo cancellation 8-10, 39
- equalizer 40

F

- factory defaults, restoring 86, 93
- fault isolation 85, 90
- firmware update 57
- firmware version 87
- focus 34, 62-63, 73

G

- gain 32-33
 - blue 32-33
 - iris 33
 - red 32-33
- gamma setting 32-33
- getting help 60
- guest access 23

H

- HDMI audio embedder 10
- Help page (web) 60
- home position 29, 66, 68
- hostname 27
- HTTP, enabling 24
- HTTPS 19, 25
 - browser warnings 19
 - SSL certificate 25

I

- Image Flip setting 53
- importing a configuration 55
- inactive sessions (web interface) 23
- indicator light 8, 54, 77, 92
 - behavior 54, 77
 - color scheme 54
 - enabling/disabling 54
 - meaning of colors 8, 92
- information, conference room 28
- initial device set-up 14-15, 17-19, 21
 - using the Vaddio Device Controller 15, 21
 - using the web interface 18-19, 21
 - using Vaddio Deployment Tool 17
- installation 9-12
 - basic connections 9-10
 - camera 11
 - camera mount 9
 - speaker 12
- inverted installation 8
- IP address 18-19, 26, 62-63
 - camera, discovering 18
 - default 18-19, 26-27
 - static, configuring 26
- IP streaming 41-46, 82-83
 - enabling/disabling 42
 - settings 43-46, 82-83
- IR cut filter 77
- IR remote 62-63

- iris settings 33, 75-76

L

- labels, room 28
- LED control 77
- light, status indicator 8, 54, 77, 92
 - behavior 54, 77
 - color scheme 54
 - enabling/disabling 54
 - meaning of colors 8, 92
- lighting settings 32, 75-76
- location of the camera 5, 28
- locations of connectors 4
- log files 61
- low-light adjustment 77
- low-power (standby) state 65, 77, 81

M

- macros 48-50, 81
 - creating and editing 49
 - testing 50
- manual focus 34, 62-63, 73
- Max Bandwidth (IP streaming setting) 45
- media player 41
- mic boost 39
- MicPOD ports 4
- microphone 62
 - muting 62
- microphones 9-10, 38-39, 80
 - adjusting 39
 - muting 38, 80
- motor calibration 85, 92
- mount 5, 9
- mounting the camera 5, 11
- mounting the speaker 12
- MTU (IP streaming setting) 47
- muting 38, 62, 64, 78, 80
 - audio inputs 38, 80
 - audio outputs 38, 80
 - microphones 62, 80
 - speakers 80
 - video 64, 78

N

- network configuration 27, 84
 - current 84
- Networking page (web) 27
- noise cancellation 39
- NTP server 28

O

One Push White Balance 33
operating environment 5, 93

P

packing list 2
page 23-25, 27-28, 38-48, 60-61, 64
 Audio 38-40
 Control Devices 48
 Controls 64
 Diagnostics 61
 Help 60
 Networking 27
 Room Labels 28
 Security 23-25
 Streaming 41-47
pan 35-37, 62-63, 66, 69, 72
 absolute position 69, 72
 direction 37
 speed 35-36, 69
pan/tilt 74, 85, 92
 recalibration 85, 92
 storing as a preset 74
part numbers 2
passwords 21, 23
 admin 21
Path (IP streaming setting) 43
performance specifications 89
physical and environmental specifications 89
ping command 85
Point Light Compensation setting 33
position, absolute 69-70, 72
power connector 4
power on/power off 13, 62-63, 65, 81
precautions 2, 5
 for handling the camera 2
 for operating the system 5
presets 29, 31, 62-63, 66, 74
 clearing 63
 moving to 66, 74
 renaming 31
 setting 29, 63, 74
Pro A/V status light color scheme 53
product capabilities 1, 89

Q

Quality/Quantization (IP streaming setting) 45

quick reference 21, 33, 62-63
 remote control 62
 Vaddio IR Remote Commander 63
 web interface 21

R

ready state 65, 81
rebooting 59, 86
recalibration, pan and tilt 85, 92
red gain 32-33, 75-76
remote control 62-63
requirements 5
 installation 5
 mounting 5
reset 85, 92. See also rebooting; restoring
 default settings
 pan and tilt motors 85, 92
Resolution (IP streaming setting) 44-45
restoring a configuration 55
restoring default settings 86, 93
RJ-45 connectors 6
room information 28
Room Labels page (web) 28
RTMP streaming 41, 46
RTSP streaming 41, 43

S

saving a configuration 55
Security page (web) 23-25
self-signed certificate 19
settings, default, restoring 86, 93
shelf, camera mount 9
site requirements 5
soft DIP switches 53
software update 57
solving problems 90
speaker 9-10, 12, 40, 62
 mounting and connecting 12
 volume, adjusting 62
speaker port 4
speakers 80
 muting 80
specifications 89
speed 35-36, 62-63, 69-71, 73
 focus 73
 Global Preset (defined) 35
 Global Preset Non-Tri-Sync, setting 36
 manual (defined) 35
 manual, setting 35

- pan 35-36, 69
- tilt 35-36, 70
- zoom 35-36, 62-63, 71
- SSL certificate 25
- standby (low-power) state 65, 77, 81
- static IP address 26
 - configuring 26
- status light 8, 54, 77, 92
 - behavior 53-54, 77
 - color scheme 54
 - enabling/disabling 54
 - meanings of colors 8, 92
- storage environment 93
- storing a configuration 55
- stream viewer 41
- streaming 41-46, 82-83
 - configuring 42
 - enabling/disabling 42
 - IP 41-42, 44-45
 - settings 42-43, 45-46, 83
 - state 82
 - USB 41-42
- Streaming page (web) 41-47
- streaming URL 43
- Super-Wide Mode setting 53
- supported web browsers 14
- switch settings 8, 53
 - image flip 8
 - in web interface 53
- synchronizing audio and video 40
- syntax help, Telnet commands 67, 88

T

- tablet 15
- technical specifications 89
- technical support 60
- Telnet 24, 67-88
 - commands 68-88
 - disabled by default 67
 - enabling access via 24
 - session history 88
 - session, ending 88
 - syntax help 67, 88
 - typographical conventions in command reference 67
- temperature, operating and storage 93
- testing 50, 52
 - macros 50
 - triggers 52

- third-party control 67
- tilt 35-36, 62-63, 66, 70, 72
 - absolute position 70, 72
 - speed 35-36, 70
- time zone 28
- trigger command, failure to execute 52
- trigger devices 39, 48
- triggers 48, 51-52, 81
 - defining 51
 - deleting 51
 - testing 52
- troubleshooting 85, 90

U

- UC conferencing status light color scheme 53
- update 57
- URL, RTSP streaming 43, 46
- USB stream format setting 53
- USB streaming 41-42, 83
 - configuring 42
 - settings 83
- user password 23

V

- Vaddio Deployment Tool 14, 16-17
 - check for the latest version 16
 - initial device set-up 17
- Vaddio Device Controller 14-15
- Vaddio IR Remote Commander 62-63
- Variable Bit Rate (IP streaming setting) 45
- version, firmware 87
- video mute 64, 78
- Video Quality (IP streaming setting) 44
- video resolution (IP streaming setting) 44
- virtual DIP switches 53
- visual parts identification 3
- volume controls 38, 62, 79

W

- wall mount 9
- warranty 5
- web browsers supported 14
- web interface 15, 18, 23-25, 27-28, 38-48, 60-61, 64
 - accessing 15, 18
 - Audio page 38-40
 - Control Devices page 48
 - Controls page 64
 - Diagnostics page 61

Help page 60
Networking page 27
Room Labels page 28
Security page 23-25
Streaming page 41-47
Wide Dynamic Range setting 33

Z

zoom 35-36, 62-63, 66, 71-72, 74
 absolute position 71-72
 in stored presets 74
 speed 35-36, 62-63, 71

Vaddio is a brand of Legrand AV Inc. · www.legrandav.com · Phone 800.572.2011 / +1.763.971.4400 · Fax +1.763.971.4464 · Email av.vaddio.support@legrand.com

Visit us at www.legrandav.com for firmware updates, specifications, drawings, manuals, technical support information, and more.

©2020 Legrand AV Inc.

Vaddio is a registered trademark of Legrand AV Inc. All other brand names or marks are used for identification purposes and are trademarks of their respective owners. All patents are protected under existing designations. Other patents pending.

A brand of  legrand®

Commercial AV Brands Chief | Da-Lite | Middle Atlantic | Projecta | Vaddio

vaddio®