

User Guide

Vaisala HUMICAP[®] Humidity and Temperature
Transmitter Series

HMT120

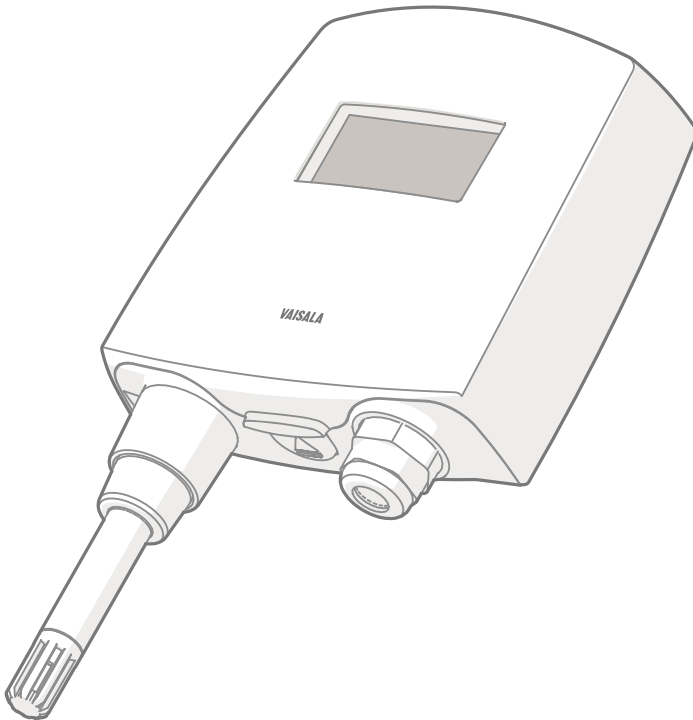

VAISALA

PUBLISHED BY

Vaisala Oyj

Street address: Vanha Nurmijärventie 21, FI-01670 Vantaa, Finland

Mailing address: P.O. Box 26, FI-00421 Helsinki, Finland

Phone: +358 9 8949 1

Visit our Internet pages at www.vaisala.com.

© Vaisala Oyj 2018

No part of this manual may be reproduced, published or publicly displayed in any form or by any means, electronic or mechanical (including photocopying), nor may its contents be modified, translated, adapted, sold or disclosed to a third party without prior written permission of the copyright holder. Translated manuals and translated portions of multilingual documents are based on the original English versions. In ambiguous cases, the English versions are applicable, not the translations.

The contents of this manual are subject to change without prior notice.

Local rules and regulations may vary and they shall take precedence over the information contained in this manual. Vaisala makes no representations on this manual's compliance with the

local rules and regulations applicable at any given time, and hereby disclaims any and all responsibilities related thereto.

This manual does not create any legally binding obligations for Vaisala towards customers or end users. All legally binding obligations and agreements are included exclusively in the applicable supply contract or the General Conditions of Sale and General Conditions of Service of Vaisala.

This product contains software developed by Vaisala or third parties. Use of the software is governed by license terms and conditions included in the applicable supply contract or, in the absence of separate license terms and conditions, by the General License Conditions of Vaisala Group.

Table of Contents

1.	About This Document	7
1.1	Version Information.....	7
1.2	Related Manuals.....	7
1.3	Documentation Conventions.....	7
1.4	Trademarks.....	8
1.5	Patent Notice.....	8
2.	Product Overview	9
2.1	Introduction to HMT120.....	9
2.2	Accessories.....	9
2.3	Fixed and Remote Probe Models.....	9
2.4	Optional Display.....	10
2.5	Interchangeable Probe.....	10
2.6	Constant Output Probe.....	10
2.7	Transmitter Parts.....	11
2.8	Safety.....	12
2.8.1	ESD Protection.....	12
2.9	Regulatory Compliances.....	12
3.	Installation	13
3.1	Opening the Transmitter Cover.....	13
3.2	Wall Mounting.....	14
3.3	Installation with Rain Shield.....	15
3.4	Installation with Radiation Shield.....	16
3.5	Duct Installation Kit.....	17
3.5.1	Probe Assembly with Duct Installation Kit.....	18
3.5.2	Drilling Instructions for Duct Installation Kit.....	19
3.6	Probe Mounting Clamp.....	19
3.7	Probe Mounting Flange.....	20
3.8	Connections.....	21
3.8.1	Wiring.....	22
4.	Serial Line Operation	23
4.1	Using the Service Port.....	23
4.2	Serial Interface Settings.....	23
4.3	Installing the Driver for the USB Service Cable.....	23
4.4	Connecting with a Computer.....	24
4.5	List of Serial Commands.....	26
4.6	Device Information and Status.....	27
4.7	Serial Line Output and Communication.....	32
4.8	Calibration Commands.....	34
4.9	Configuring Serial Line Operation.....	37
4.10	Measurement Parameter Configuration Commands.....	39
4.11	Analog Output Configuration Commands.....	40
4.12	Other Commands.....	42

- 5. Maintenance**.....48
 - 5.1 Removing and Fastening Fixed Humidity Probe.....48
 - 5.2 Removing and Fastening Remote Humidity Probe.....49
 - 5.3 Testing Analog Outputs.....50
 - 5.4 Replacing the HUMICAP® Sensor.....51

- 6. Calibration and Adjustment**.....52
 - 6.1 Calibration and Adjustment Overview52
 - 6.2 Push-Button Calibration.....53
 - 6.2.1 Adjusting Humidity and Temperature with Push Buttons.....53
 - 6.3 Adjusting RH and T with MI70 Hand-Held Indicator.....56
 - 6.3.1 Field Checking and Adjustment Using a Calibrated Reference Probe.....57
 - 6.3.2 1-Point Adjustment Using a Calibrator.....58
 - 6.3.3 2-Point Adjustment Using a Calibrator.....58
 - 6.3.4 LiCl-NaCl Adjustment.....59
 - 6.3.5 Temperature Field Check and Adjustment Using a Calibrated Reference Probe.....60
 - 6.4 Adjustment with HMI41.....60
 - 6.4.1 Connections and Selecting the Calibrator Function.....62
 - 6.4.2 Adjusting Offset and Gain with HMI41.....63
 - 6.4.3 Troubleshooting HMI41 Adjustment.....67

- 7. Troubleshooting**.....69
 - 7.1 Error Codes.....69
 - 7.2 Solving Typical Problems.....70
 - 7.3 Analog Output Error Notification.....71

- 8. Technical Data**.....72
 - 8.1 Specifications.....72
 - 8.2 Spare Parts and Accessories.....74
 - 8.3 Transmitter Dimensions.....75

- Appendix A: Calculation Formulas**.....77
 - A.1 Calculation Formulas Overview.....77
 - A.2 Dewpoint Temperature.....77
 - A.3 Dew/frostpoint Temperature Calculation.....78
 - A.4 Mixing Ratio Calculation.....78
 - A.5 Saturation Vapor Pressure Calculation.....79
 - A.6 Water Vapor Pressure Calculation.....79
 - A.7 Absolute Humidity Calculation.....80
 - A.8 Enthalpy Calculation.....80
 - A.9 Accuracies of Calculated Variables.....80
 - A.9.1 Accuracy of Dewpoint Temperature °C.....80
 - A.9.2 Accuracy of Mixing Ratio g/kg (Ambient Pressure 1013 mbar).....81
 - A.9.3 Accuracy of Wet Bulb Temperature °C.....81
 - A.9.4 Accuracy of Absolute Humidity g/m³.....82

Index	83
Warranty	85
Technical Support	85
Recycling	85

List of Figures

Figure 1	Main Transmitter Parts.....	11
Figure 2	Opening the Transmitter Cover.....	13
Figure 3	Wall Mounting Measurements.....	14
Figure 4	Installation with Rain Shield.....	15
Figure 5	Probe Installation with Radiation Shield.....	16
Figure 6	Probe Installation with the Duct Installation Kit.....	17
Figure 7	Probe Assembly with Duct Installation Kit.....	18
Figure 8	Drilling Instructions.....	19
Figure 9	Optional Probe Mounting Clamp.....	20
Figure 10	Optional Probe Mounting Flange.....	20
Figure 11	HMT120 Component Board.....	21
Figure 12	Isolated Current Loop Wiring.....	22
Figure 13	Removing the Humidity Probe (Fixed Probe Model).....	48
Figure 14	Removing the Humidity Probe (Remote Probe Model).....	49
Figure 15	HMT120 Output Current Measurement.....	50
Figure 16	Adjustment Buttons.....	53
Figure 17	Location of the HMI41 Calibration Connector.....	61
Figure 18	Fixed Probe Model Dimensions in mm(in).....	75
Figure 19	Remote Probe Model Dimensions in mm(in).....	76

List of Tables

Table 1	Document Versions.....	7
Table 2	Related Manuals.....	7
Table 3	Applicable Patents.....	8
Table 4	Wiring Table.....	22
Table 5	Default Serial Interface Settings.....	23
Table 6	List of Serial Commands.....	26
Table 7	? Command.....	27
Table 8	Calcs Command.....	28
Table 9	Cdate Command.....	29
Table 10	Ctext Command.....	29
Table 11	Aout Command.....	30
Table 12	System Command.....	31
Table 13	Vers Command.....	31
Table 14	R Command.....	32
Table 15	S Command.....	32
Table 16	Intv Command.....	33
Table 17	Send Command.....	33
Table 18	CRH Command.....	34
Table 19	CRHCLR Command.....	35
Table 20	CT Command.....	35
Table 21	CTCLR Command.....	36
Table 22	ACAL Command.....	36
Table 23	SERI Command.....	37
Table 24	ECHO Command.....	38
Table 25	SMODE Command.....	38
Table 26	ENV Command.....	39
Table 27	AERR Command.....	40
Table 28	ASEL Command.....	40
Table 29	ATEST Command.....	42
Table 30	DSEL Command.....	42
Table 31	FORM Command.....	43
Table 32	HELP Command.....	44
Table 33	ERRS Command.....	44
Table 34	SAVE Command.....	45
Table 35	RESTORE Command.....	45
Table 36	RESET Command.....	46
Table 37	FRESTORE Command.....	46
Table 38	UNIT Command.....	46
Table 39	Common Problems During HMI41 Adjustment and Their Remedies.....	67
Table 40	Error Codes, Descriptions and Texts.....	69
Table 41	Problems and Solutions.....	70
Table 42	Measurement Performance.....	72
Table 43	Operating Environment.....	73
Table 44	Inputs and Outputs.....	73

Table 45	Mechanical Specifications.....	73
Table 46	Spare Parts and Accessories.....	74
Table 47	Temperature Dependence for A, m, and Tn.....	77
Table 48	Temperature Dependence for A, m, and Tn.....	78
Table 49	Accuracy of Dewpoint Temperature °C.....	80
Table 50	Accuracy of Mixing Ratio g/kg (Ambient Pressure 1013 mbar).....	81
Table 51	Accuracy of Wet Bulb Temperature °C.....	81
Table 52	Accuracy of Absolute Humidity g/m ³	82

1. About This Document

1.1 Version Information

Table 1 Document Versions

Document Code	Date	Description
M211244EN-C	January 2018	This version. Factory calibration uncertainty specification updated. Spare parts list updated. Document template updated, content structure revised.
M211244EN-B	June 2013	Previous version. New probe options added. Installation and operating instructions updated.
M211244EN-A	November 2010	First version.

1.2 Related Manuals

Table 2 Related Manuals

Document Code	Description
M210185EN	Humidity Calibrator HMK15 User's Guide
M210297EN	Hand-held Humidity and Temperature Meter HM70 User's Guide
M210316EN	HMI41 Indicator and HMP41/45/46 Probes Operating Manual
M211060EN	HMP60 and HMP110 Series Probe User's Guide

1.3 Documentation Conventions



WARNING! Warning alerts you to a serious hazard. If you do not read and follow instructions carefully at this point, there is a risk of injury or even death.



CAUTION! Caution warns you of a potential hazard. If you do not read and follow instructions carefully at this point, the product could be damaged or important data could be lost.



Note highlights important information on using the product.



Tip gives information for using the product more efficiently.



Lists tools needed to perform the task.



Indicates that you need to take some notes during the task.

1.4 Trademarks

Vaisala® and HUMICAP® are registered trademarks of Vaisala Oyj.

1.5 Patent Notice

This product is protected by the following patents and their corresponding national rights:

[Table 3](#) [Applicable Patents](#)

Patent	Patent Number
Finnish patent	98861
French patent	6650303
German patent	69418174
Japanese patent	3585973
UK patent	0665303
U.S. patent	5607564

2. Product Overview

2.1 Introduction to HMT120

HMT120 measures relative humidity and temperature and converts it to analog current loop outputs. Other quantities, such as dewpoint (T_d) can be calculated from the basic RH and T values according to the device configuration. HMT120 is powered with a 10 ... 30 VDC external loop voltage (20 ... 30 VDC when $R_L < 500$ ohms) and it outputs two analog current signals with nominal 4 ... 20 mA range.

HMT120 transmitter's output quantities are configurable. Available quantities for outputs are limited to two at a time. These two quantities can be used freely at any outputs (display, service port and analog current loop outputs).

Available quantities are RH, T, T_d , $T_{d/f}$, a, x, h, T_w , p_{ws} , and p_w .

The default output quantities are set at the factory during order time. These factory preset quantity selections can be changed afterwards via service port if necessary.

The HMT120T and HMT120H models are single-parameter transmitters. The only output quantity of HMT120T is temperature. The output of the HMT120H can be configured to be any one of the humidity-related quantities (RH, T_d , $T_{d/f}$, a, x, h, T_w , p_{ws} and p_w).

Vaisala Relative Humidity Measurement Instruments

The Vaisala range of relative humidity measurement instruments covers all the applications from ventilation to process control in demanding conditions. For more information about other Vaisala relative humidity instruments, please contact your Vaisala representative or visit www.vaisala.com.

2.2 Accessories

The following accessories are optionally available:

- Duct installation kit
- Rain shield with installation kit
- Rain/solar radiation shield installation kit (for pole installation)
- Probe mounting flange
- Probe mounting clamp
- Constant output probe (HMP1100REF, gives constant RH and T values)

2.3 Fixed and Remote Probe Models

The transmitter is available either with a fixed probe directly attached to the transmitter housing or a remote probe with different (3/5/10/20 m) cable lengths. All extension cables can be easily cascaded in order to obtain longer reach: see [Spare Parts and Accessories](#) (page 74).

2.4 Optional Display

The transmitter is also available with an optional graphical 128*64 pixel resolution LCD display. The display shows the measurement results of selected parameters in selected units (defined when ordering the transmitter). The parameters are displayed simultaneously on two separate rows on the display.

2.5 Interchangeable Probe

The HMP110 relative humidity probe used in the transmitter is fully interchangeable. You can easily remove the probe and replace it with a new one without having to adjust the transmitter. You have the following options when purchasing a new probe from Vaisala:

- Order a new probe and keep your current one.
- Order a new probe and return the old one to Vaisala (replacement probe).



Only probes that have a compatible digital output (VDIGI mode) can be used with the transmitter. Compatible probes have the letter "V" as the first letter in their order code. The order code is written on the probe.

2.6 Constant Output Probe

The constant output probe HMP110REF is a testing accessory that can be used to check transmitter's functions and measurement signal transfer chain all the way to the control system. The constant output probe does not measure humidity and temperature; instead, it outputs constant humidity and temperature readings.

The values output by the constant output probe are specified when ordering. These values are written on an additional label on the probe body.

The procedure for using the constant output probe is simply to replace the original probe for the duration of the testing:

1. Disconnect the normal probe from transmitter.
2. Connect the constant output probe to the transmitter.
3. Check that all used outputs (analog, display, serial line) show the correct measurement values.
4. After checking the outputs, disconnect the constant output probe and reconnect the original probe.



The transmitter goes to the error state for a short time when the probe is changed. This is normal.

2.7 Transmitter Parts

Figure 1 (page 11) shows the main transmitter parts. On the left is a remote probe model without display, and on the right is a fixed probe model with the optional display.

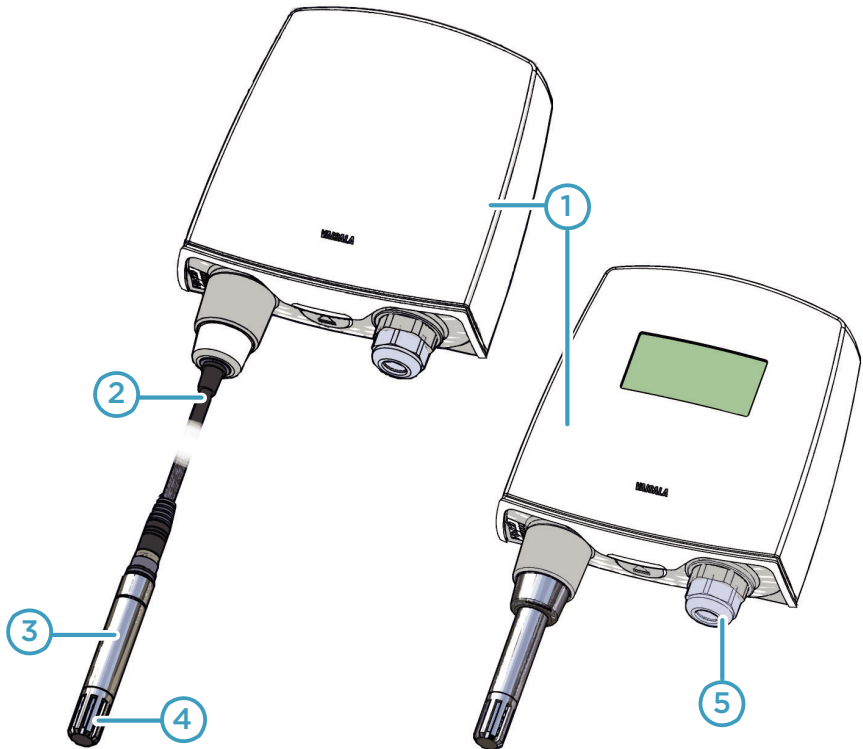

Figure 1 Main Transmitter Parts

- 1 Transmitter enclosure
- 2 Probe cable
- 3 HMP110 probe
- 4 Plastic grid filter
- 5 Cable bushing: cable gland, cable grommet, or conduit fitting

More Information

- [Spare Parts and Accessories \(page 74\)](#)

2.8 Safety

The transmitter delivered to you has been tested for safety and approved as shipped from the factory. Note the following precautions:



CAUTION! Do not modify the unit or use it in ways not described in the documentation. Improper modification may lead to safety hazards, equipment damage, failure to perform according to specification, or decreased equipment lifetime.

2.8.1 ESD Protection

Electrostatic Discharge (ESD) can cause immediate or latent damage to electronic circuits. Vaisala products are adequately protected against ESD for their intended use. It is possible to damage the product, however, by delivering electrostatic discharges when touching, removing, or inserting any objects inside the equipment housing.

To make sure you are not delivering high static voltages yourself:

- Handle ESD sensitive components on a properly grounded and protected ESD workbench.
- When an ESD workbench is not available, ground yourself to the equipment chassis with a wrist strap and a resistive connection cord.
- If you are unable to take either of the above precautions, touch a conductive part of the equipment chassis with your other hand before touching ESD sensitive components.
- Always hold component boards by the edges and avoid touching the component contacts.

2.9 Regulatory Compliances

Vaisala HUMICAP® Humidity and Temperature Transmitter Series HMT120 is in conformity with the provisions of the following EU directives:

- EMC-Directive (2004/108/EC)

Conformity is shown by compliance with the following standards:

- EN 61326-1: Electrical equipment for measurement, control and laboratory use – EMC requirements – for use in industrial locations.
- EN 55022 + Am1: Information technology equipment – Radio disturbance characteristics – Limits and methods of measurement.



3. Installation

3.1 Opening the Transmitter Cover

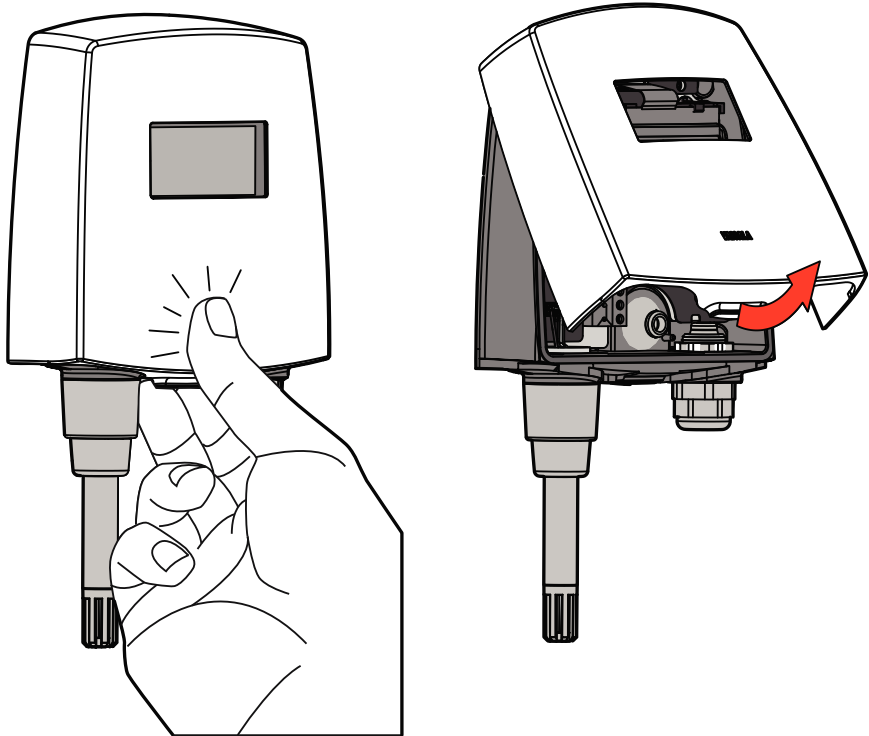

Figure 2 Opening the Transmitter Cover

To open the transmitter cover:

- ▶ 1. If the transmitter is not mounted already, hold it against a flat surface.
2. Push on the cover with your thumb, and pull the bottom part of the cover towards yourself.

3.2 Wall Mounting

To mount the transmitter on a wall:

- ▶ 1. Remove the transmitter cover.
- 2. Make sure that the transmitter is correctly aligned and attach it directly to the wall with up to four screws (not included in the package). [Figure 3 \(page 14\)](#) shows the distances between attachment points.

 **CAUTION!** It is possible to damage the display when tightening the screws, as there is not much room between the upper fastening holes and the exposed display component. Be particularly careful when using a cordless drill.

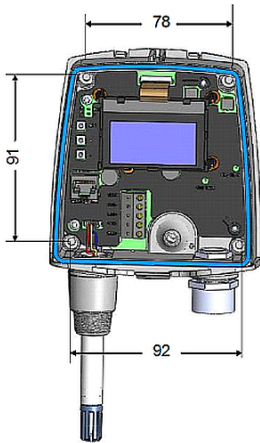



Figure 3 Wall Mounting Measurements

 Select the size and type of the fastening screws according to the wall material (for example, wood or stone). Even though using all four screws is strongly recommended, the transmitter enclosure fastening holes are initially covered with a thin plastic membrane, so less than four screws could be also be used without sacrificing the ingress protection (IP) class of the enclosure. The diameter of the fastening screws is typically between 3,5 and 4 mm.

More Information

- ▶ [Opening the Transmitter Cover \(page 13\)](#)

3.3 Installation with Rain Shield

The installation kit with rain shield (Vaisala order code: 215109) includes a metal mounting plate and a rain shield for the transmitter.

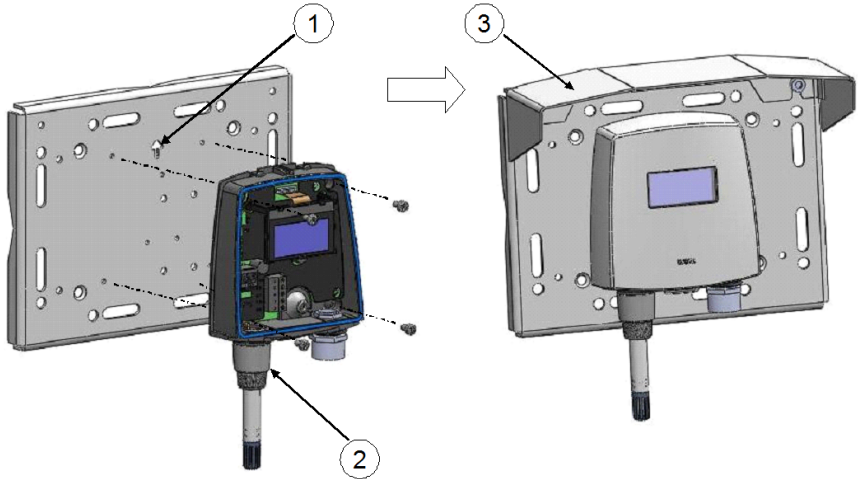
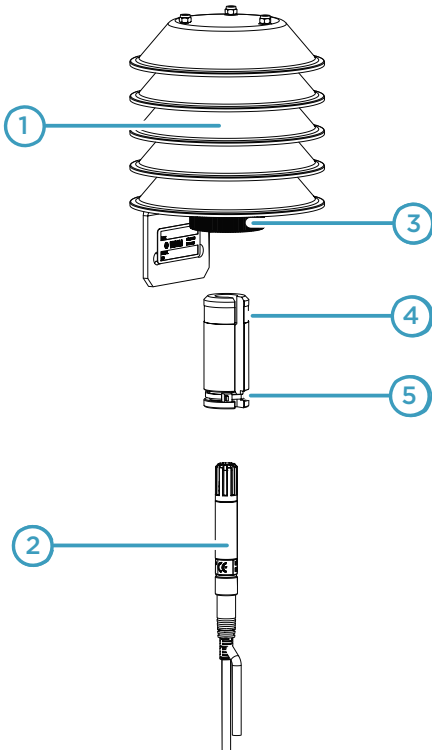

Figure 4 Installation with Rain Shield

To install the transmitter with the rain shield:

- ▶ 1. Fasten the metal mounting plate to the wall or pole with screws. Note the arrow on the mounting plate. Attach the mounting plate with the arrow pointing upwards.
- 2. Drill holes for the screws in the transmitter frame, and fasten the transmitter to the metal mounting plate with four (M4) screws.
- 3. Fasten the rain shield to the metal mounting plate with two (M6) mounting screws.

3.4 Installation with Radiation Shield



DTR504 with probe installation kit (Vaisala order code: DTR504A) includes the rain/solar radiation shield DTR504 and a plastic installation support for the humidity probe. If you already have the DTR504 shield and need only the installation support for the probe, the installation support is available with Vaisala order code 227777.

Figure 5 Probe Installation with Radiation Shield

- 1 DTR504
- 2 Probe
- 3 Plastic nut
- 4 Installation support (order code: 227777)
- 5 Cable tie

To install the probe with a radiation shield:

- ▶ 1. Fasten the probe (item 2 in [Figure 5 \(page 16\)](#)) to the installation support with a cable tie (item 5).
2. Insert and attach the support to the radiation shield by tightening the plastic nut (3).
3. Attach the entire radiation shield/probe assembly to a pole mast (pole mast diameter: 30 ... 60 mm/1.2 ... 2.3") with a U-bolt and a support arm.

3.5 Duct Installation Kit

The duct installation kit includes a plastic pipe with a flange (Vaisala order code: 215619). To install the HMP110 probe with the duct installation kit, drill a hole to the duct wall, assemble the probe to the duct installation kit, slide the probe head through the hole, and attach the flange to the duct wall with four screws.

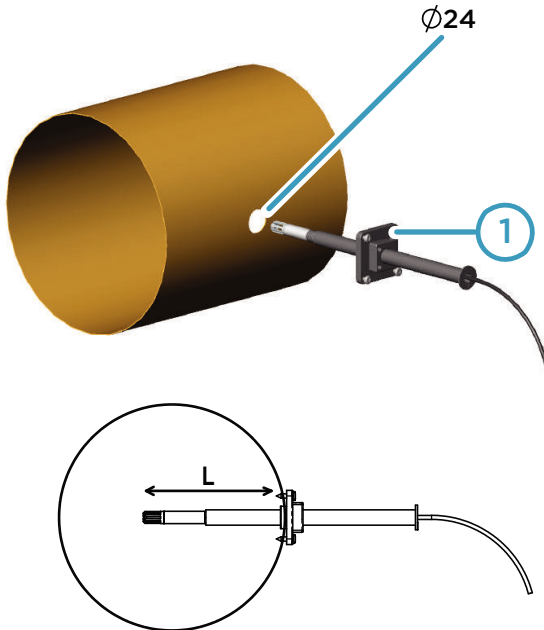

Figure 6 Probe Installation with the Duct Installation Kit

1 Tension screw

The installation depth (distance L) can be adjusted and locked in place with the tension screw.

3.5.1 Probe Assembly with Duct Installation Kit

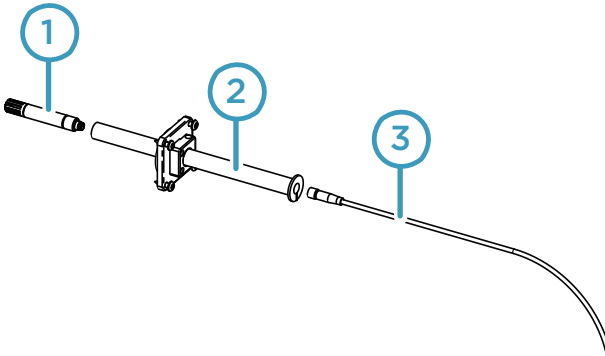

Figure 7 Probe Assembly with Duct Installation Kit

- 1 HMP110
- 2 Duct installation kit
- 3 Probe cable

- ▶ 1. Slide the probe cable through the duct installation kit plastic pipe.
- 2. Attach the probe cable to the HMP110 Humidity Probe.
- 3. Attach probe assembly to the duct.

3.5.2 Drilling Instructions for Duct Installation Kit

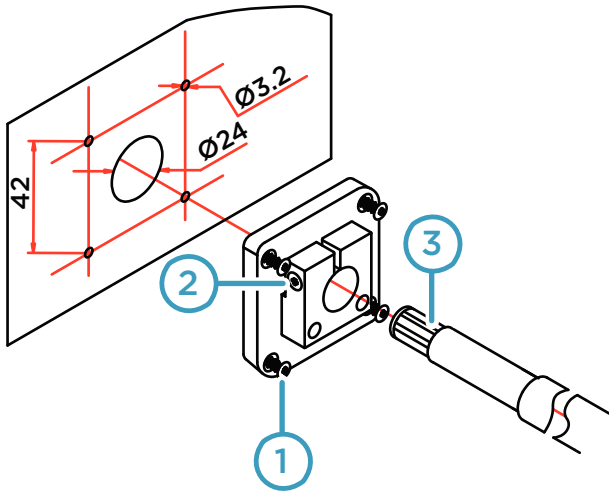

Figure 8 Drilling Instructions

- 1 Mounting screw
- 2 Tension screw
- 3 HMP110 assembled in duct installation kit plastic pipe

To drill the holes for the duct installation kit:

- ▶ 1. Use a 24-mm drill bit to drill a hole to the duct wall for the humidity probe.
- 2. Drill holes for the duct installation kit mounting screws around the hole in a square arrangement, 42 mm apart from each other. Use a 3.2-mm drill bit to drill the holes for the mounting screws (four ST4.2×16-C-Z DIN 7981 screws).

3.6 Probe Mounting Clamp

The optional mounting clamp makes it easy to install the probe on the wall of the measurement environment. The probe can be detached for calibration simply by loosening the lower screw. You can order a single clamp (Vaisala order code 225501) or a set of 10 clamps (226067).

Installing the entire probe in the measurement environment prevents heat conduction to the sensor, and is the recommended installation method.



Figure 9 Optional Probe Mounting Clamp



CAUTION! Attaching the probe mounting clamp to a conductive wall material should be avoided, since the potential galvanic connection to the power supplies and uncontrolled earth current loops could cause measurement errors or even damage to the transmitter.

3.7 Probe Mounting Flange

The probe mounting flange (Vaisala order code: 226061) is a general purpose mounting flange for 12 mm diameter probes. It can be used to hold the HMP110 probe in a through-wall installation.



The coaxial silicone plug that is delivered with the flange is not suitable for use with the transmitter's probe cable.

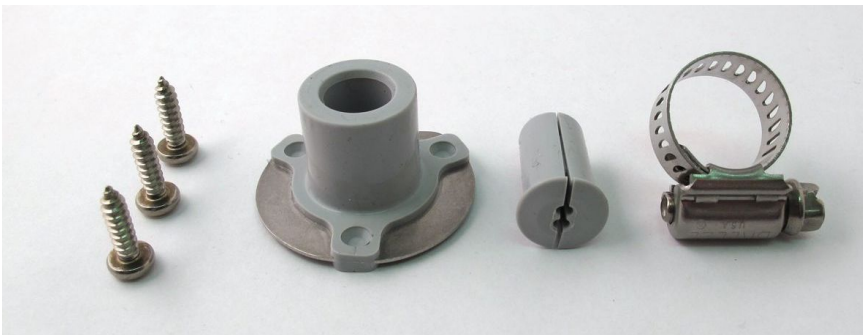

Figure 10 Optional Probe Mounting Flange

3.8 Connections

Figure 11 (page 21) shows the main parts of the HMT120 component board, including the wiring connectors.

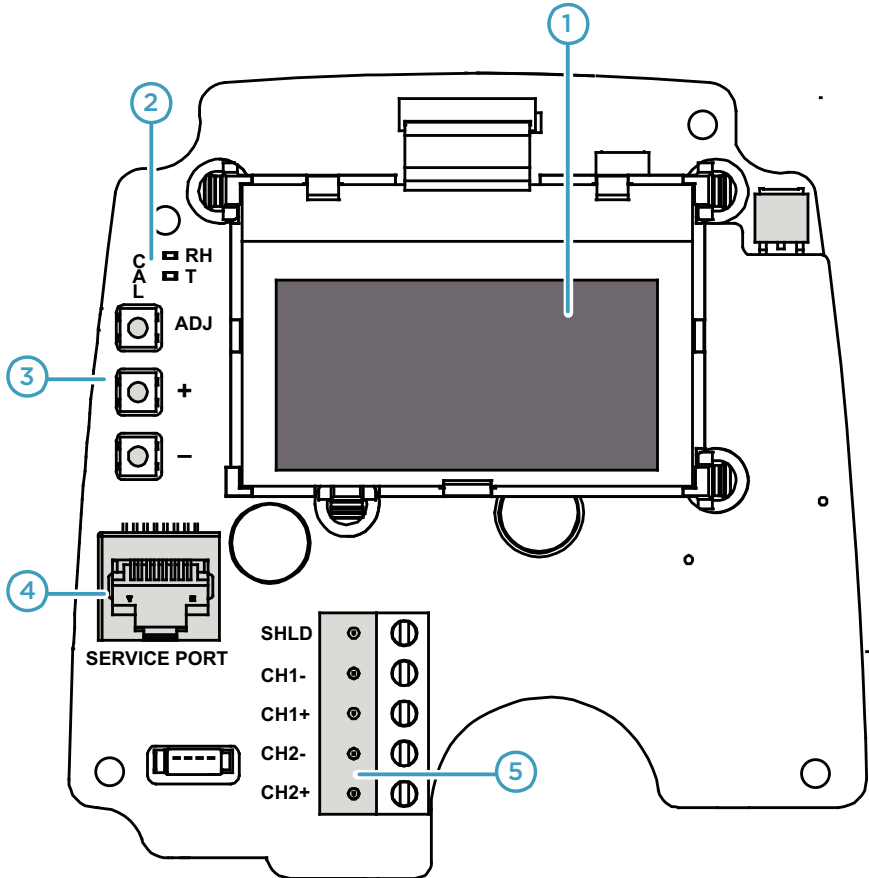

Figure 11 HMT120 Component Board

- 1 Optional LCD display
- 2 Indicator LEDs
- 3 Adjustment buttons
- 4 Service port
- 5 Field wire terminals

3.8.1 Wiring

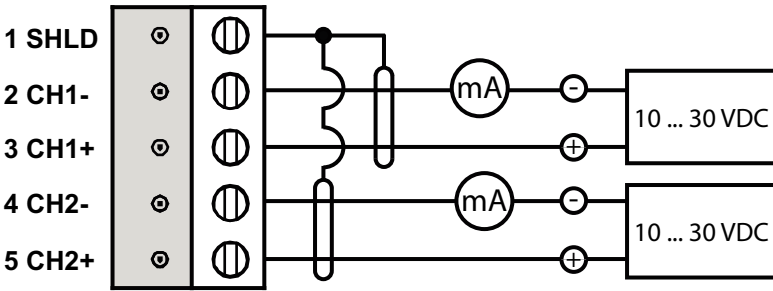

Figure 12 Isolated Current Loop Wiring

Table 4 Wiring Table

Terminal ¹⁾	Current Output (2-Wire, CH2 Isolated)
1	Cable shield (optional)
2	CH1- (signal and power supply -)
3	CH1+ (signal and power supply +)
4	CH2- (signal and power supply -)
5	CH2+ (signal and power supply +)

1) Terminal numbers 1 ... 5 in the first column of the wiring table refer to [Figure 12 \(page 22\)](#)

To connect the wiring:

- ▶ 1. Remove the transmitter cover as instructed in [Opening the Transmitter Cover \(page 13\)](#).
- 2. Insert the signal wires through the selected cable gland/conduit fitting in the bottom of the transmitter or alternatively through the rubber grommet at the back side of the transmitter.
- 3. Connect the wires as instructed in [Figure 12 \(page 22\)](#) and [Table 4 \(page 22\)](#). Suitable wire size is 0.5 ... 1.5 mm².

i If an isolated output is required with current outputs, both channels require their own power supply. CH1 must always be powered because CH1 is the main output, and the transmitter will not operate if only CH2 is connected.

- 4. Close the cover by keeping it slightly tilted and first attaching it to the fixing snaps at the top of the enclosure base and then pushing the lower part of the cover firmly forward until it locks. The transmitter is ready for use.

4. Serial Line Operation

4.1 Using the Service Port

The transmitter's motherboard has an 8-pin RJ-45 connector for service use. The service port uses RS-232 signaling levels. Vaisala offers an optional USB cable (Vaisala order code 219685) for connecting the transmitter to your computer.



The service port is intended for short-term use such as calibration. For permanent installation, use the analog output.

Connecting a computer to the service port may cause erroneous analog output because of a possible ground loop. Use the service port for service only and disconnect the computer after the service operation.

The cable can also provide operation power to the transmitter, so the wires at the screw terminals need not to be connected in order to operate the transmitter.

If you have not used the transmitter's USB cable before, install the driver that came with the cable.

4.2 Serial Interface Settings

Table 5 Default Serial Interface Settings

Property	Description/Value
Bit rate	19200
Parity	None
Data bits	8
Stop bits	1
Flow control	None

4.3 Installing the Driver for the USB Service Cable



Only Windows® operating systems are supported by the driver of the USB service cable.

- ▶ 1. Connect the USB service cable to a USB port on your computer. Windows® detects the new device and installs the appropriate driver.

2. Open **Devices and Printers** from the Windows® Start menu. Use search to find it if necessary (search for "devices").
3. Locate the cable in the list of devices:
 - If the device is listed as **Vaisala USB Device** with a COM port number in brackets, the cable is ready for use. **Note the COM port number, you will need it later.**
 - If the device is listed as **Vaisala USB Instrument Cable** without a COM port number listed, you must install the driver manually.

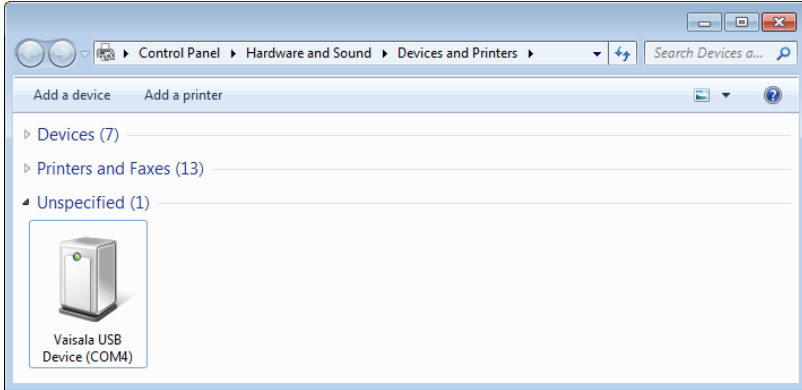

4. To install the driver manually:
 - a. Disconnect the USB service cable from the computer.
 - b. Download the Vaisala USB driver at <http://www.vaisala.com/software> (select the appropriate USB Instrument Driver Setup for your cable).
 - c. Run the USB driver installation program *Vaisala USB Device Driver Setup.exe*. Accept the installation defaults.
 - d. Go back to and verify that the driver installation works as expected.

4.4 Connecting with a Computer



- Vaisala USB service cable (order code 219685)
- Computer with:
 - Windows operating system
 - Terminal application (for example PuTTY, available from <http://www.vaisala.com/software>)
 - Free USB port
 - Driver for Vaisala USB service cable installed (available on the cable installation media and at <http://www.vaisala.com/software>)

The steps below describe how to connect to the transmitter using the PuTTY terminal application for Windows and a USB computer connection cable.

- ▶ 1. If you have not used the Vaisala USB cable before, install the driver before attempting to use the cable.
2. Connect the USB cable between your computer and the transmitter's service port.
3. Start the PuTTY application.
4. Select **Connection > Serial & USB** and check that the correct COM port is selected in the **Serial or USB line to connect to** field. If you are using the PuTTY terminal application supplied by Vaisala, you can press the **USB Finder** button to open the Vaisala USB Instrument Finder program.
5. Check that the other serial settings are correct for your connection, and change if necessary. **Flow control** should be set to **None** unless you have a reason to change it.

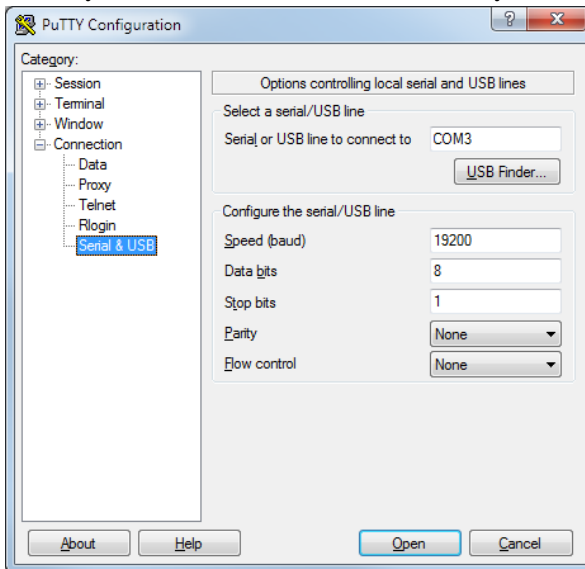

6. Select **Terminal**. Use the following settings:
 - **Local Echo**
Select **Force on**. This setting ensures that your typing is shown on the session window.
 - **Send line ends with line feeds (CR+LF)**
Make sure this option is not selected. Enabling line end sending with line feeds can cause issues with the terminal connection.

- To open the connection window and start using the serial line, select **Open**.



If PuTTY is unable to open the serial port you selected, it shows you an error message instead. If this happens, restart PuTTY and check the settings.

4.5 List of Serial Commands

All commands can be issued either in uppercase or lowercase.

The notation **<cr>** refers to pressing the carriage return (**ENTER**) key on your computer keyboard. Enter a **<cr>** to clear the command buffer before starting to enter commands.

Whenever you change any of the parameters and want to store the changes permanently, use the **SAVE** command.

Table 6 List of Serial Commands

Command	Description
?	Show transmitter information
acal	Calibrate analog outputs
aerr	Set/show analog output error levels
aout	Show analog output status
asel	Set/show analog output quantities and scaling
atest	Test analog outputs
calcs	Set/show measured quantities
cdate	Set/show calibration date
crh	Calibrate probe RH
crhclr	Restore probe RH factory calibration
ct	Calibrate probe T
ctclr	Restore probe T factory calibration
ctext	Set/show calibration info
dssel	Set/show displayed quantities
echo	Set/show terminal echo mode
env	Set/show environmental parameters
errs	Display active errors
form	Set/show output formatting

Command	Description
frestore	Restore all transmitter settings to factory defaults
help	List available commands
intv	Set/show the continuous output interval
r	Start continuous outputting
reset	Reset transmitter
restore	Restores the latest saved settings
s	Stop continuous outputting
save	Save changed settings to FLASH memor
send	Output the reading once
seri	Set/show Service Port settings (Default: 19200 N 8 1)
smode	Set/show the serial interface mode
system	Show transmitter information and build date
unit	Set/show output unit
vers	Show firmware version of the transmitter

4.6 Device Information and Status

Table 7 ? Command

Syntax	Description
?<cr>	Show listing of device information.
??<cr>	Show listing of device information even if device is in poll mode and connection has not been opened using the open command.

Syntax	Description
Example:	
<pre> ? Device Name : HMT120 SW Name : HMT120 SW model : HMT130 SW version : 0.9.3.389 Serial number : "F2220101" Address : 0 Unit : METRIC Ch1 Status : ON Ch2 Status : ON Probe name : "HMP110" Probe SW : "1.01.1" Probe SW date : "" Probe SN : "F0740011" </pre>	

Table 8 Calcs Command

Syntax	Description
<p>calcs [q1 q2]<cr></p> <p>where</p> <p>q1, q2 Any two of the allowed quantity parameters, that is, RH, T, TD, TDF, A, X, H, TW, PWS, PW</p>	<p>The calcs command shows the abbreviations of the quantities measured by the transmitter. The command can also be used to select the desired quantities for measurement. Only after the quantities have been set with the calcs command, can these quantities be selected for different outputs (see commands dssel, asel, and form). The quantities in dssel, asel, rsel and form must match with calcs.</p>
Examples:	
<pre> >calcs RH Td > calcs td t > </pre>	
<p> Single-parameter transmitters HMT120H and HMT120T have only one quantity (T for HMT120T, and RH, TD, TDF, A, X, H, TW, PWS, PW for HMT120H.)</p>	

Table 9 Cdate Command



Syntax	Description
cdate<cr>	Show calibration date.  Calibration refers to the calibration of the transmitter's analog outputs.
cdate [yyyymmdd]<cr>	Set a new calibration date. yyyy-mm-dd = Year (yyyy), month (mm) and day (dd) of calibration
Example:	
<pre>>cdate Calibrated : "NOT SET" ></pre>	
Example (set a new calibration date to June 30, 2017):	
<pre>cdate 2017-06-30 Calibrated : "2017-06-30"</pre>	

Table 10 Ctext Command

Syntax	Description
ctext<cr>	Show calibration information text.  Calibration refers to the calibration of the transmitter's analog outputs.
ctext [text]<cr>	Set a new calibration information text to be shown after the automatic text " Calib. info ".
Example:	
<pre>ctext Calib. info: "VAISALA HELSINKI" ></pre>	

Syntax	Description
Example (set a new information text):	
<pre> ctext Calibration lab 2 Calib. info: "Calibration lab 2" > </pre>	

Table 11 Aout Command

Syntax	Description
aout<cr>	<p>The aout command shows the following information:</p> <ul style="list-style-type: none"> • Analog out mode is the output mode for the channel, for example 0 ... 10 V. • Error level is the level that the analog output is set to in case of transmitter error. • Status indicates the current status of the channel. The statuses are: <ul style="list-style-type: none"> • ON: Normal measurement operation. • OFF: No quantity selected for the channel using the asel command. See Table 28 (page 40). • ERROR: Transmitter error, channel set to error level. • TEST: Analog channel being tested using the atest command. See Table 29 (page 42).

Syntax	Description
Example (no active errors):	
<pre> >aout *** ANALOG OUTPUT 1 *** Ch1 Analog out mode : 4_20MA Ch1 Notification : ON Ch1 Error level : 3.6 Ch1 Status : ON Ch1 Quantity : RH RH lo : 0 RH hi : 100 RH : 23.32 % Current : 7.73 mA *** ANALOG OUTPUT 2 *** Ch2 Analog out mode : 4_20MA Ch2 Notification : ON Ch2 Error level : 3.6 Ch2 Status : ON Ch2 Quantity : T T lo : -60 T hi : 100 T : 23.66 'C Current : 12.37 mA > </pre>	

Table 12 System Command

Syntax	Description
system<cr>	Show probe firmware information.
Example:	
<pre> system Device Name : HMT120 SW Name : HMT120 SW model : HMT120 SW version : 1.0.0.500 Serial number : A1234567 > </pre>	

Table 13 Vers Command

Syntax	Description
vers<cr>	Show firmware version of the probe.

Syntax	Description
Example:	
<pre> vers HMT120 / 0.1.0.103 </pre>	

4.7 Serial Line Output and Communication

Table 14 R Command

Syntax	Description
r <cr>	<p>S</p> <p>Use the r command to start the continuous outputting of measurement values as an ASCII text string to the serial line. The output always includes the readings of the currently selected analog output quantities.</p> <p>Outputting the results continues in intervals issued with the command intv. You can stop the output by entering the s command.</p> <p>You can define the output data formatting with the form command. With X parameter the transmitter will output RH + T value in predefined format regardless of what quantities are selected.</p>
Example:	
<pre> r RH= 25.10% T= 24.77'C RH= 25.12% T= 24.96'C ... </pre>	

Table 15 S Command

Syntax	Description
s <cr>	Stop the continuous outputting that was started with the r command.

Syntax	Description
Example:	
<pre> ... RH= 25.10% T= 24.77'C RH= 25.12% T= 24.96'C s </pre>	

Table 16 Intv Command

Syntax	Description
intv<cr>	Use the intv command to show or set the output interval of the serial line measurement messages (applies when r command or RUN mode is used). The shortest output interval is one second. This command has no effect on the operation of the analog outputs.
intv [iii uuu]<cr>	Set the output interval. iii = interval, range 0 ... 255. u = unit for interval setting: <ul style="list-style-type: none"> • s = seconds • min = minutes • h = hours If you set the interval to 0, the output messages are output as quickly as they are generated, without additional delay.
Example:	
<pre> intv 5 s Output interval: 5 S > </pre>	

Table 17 Send Command

Syntax	Description
send [x] <cr>	Use the send command to output a single measurement reading from the transmitter. When you enter the x parameter, the transmitter will output RH + T value in predefined format regardless of what quantities are selected.

Syntax	Description
Example:	
<pre> send RH= 25.12 % T= 24.91 'C ></pre>	

4.8 Calibration Commands



Serial commands that are related to calibration are described in this section. For the actual calibration procedures, see [Calibration and Adjustment Overview \(page 52\)](#).

Table 18 CRH Command

Syntax	Description
crh<cr>	<p>Use the crh command to perform a 1-point or 2-point humidity (RH) calibration.</p> <p>When performing a one-point calibration, you need to place the probe in a single humidity reference with RH < 50%. Run the command and enter the exact RH of the reference after the measurement has stabilized. Exit the command by pressing the ESC key before proceeding to the second point (see example 3).</p> <p>To update the value, press ENTER without inputting a value. For two-point calibration, the first point requires a RH < 35% humidity reference, the second point must be RH > 50%.</p>
Example 1: 1-point calibration	
<pre> >crh RH: 11.29915720 Ref1 ? 11.3 Press ENTER to continue or ESC to exit OK ></pre>	
Example 2: 2-point calibration	
<pre> >crh RH: 11.29915720 Ref1 ? 11.3 Press ENTER to continue or ESC to exit RH: 75.04306440 Ref2 ? 75 OK ></pre>	

Syntax	Description
Example 3: No calibration, only updating the value	
<pre>>crh RH: 20.28000200 Ref1 ? RH: 20.14000000 Ref1 ? Calibration terminated with ESC ></pre>	

Table 19 CRHCLR Command

Syntax	Description
crhclr<cr>	Use the crhclr command to restore the probe RH factory calibration.
Example:	
<pre>>crhclr OK ></pre>	

Table 20 CT Command

Syntax	Description
ct<cr>	<p>Use the ct command to perform a 1-point or 2-point temperature calibration.</p> <p>When performing a 1-point calibration, you need to place the probe in a single temperature reference. Run the command and enter the exact temperature of the reference after the measurement has stabilized. Exit the command by pressing the ESC key before proceeding to the second point. To update the value, press ENTER without inputting a value.</p> <p>For two-point calibration, the second reference point must be at least 20 °C warmer than the first. The measurement reading for the second point will appear when this requirement is met.</p>
Example 1: 1-point calibration	
<pre>>ct T 21.9827 Ref1 ? 22 Press ENTER to continue or ESC to exit OK ></pre>	

Syntax	Description
<p>Example 2: 2-point calibration</p> <pre>>ct T 22.0007 Ref1 ? 22 Press ENTER to continue or ESC to exit T 44.9847 Ref2 ? 45 OK ></pre>	
<p>Example 3: No calibration, only updating the value</p> <pre>>ct T 22.0007 Ref1 ? T 22.0145 Ref1 ? Calibration terminated with ESC ></pre>	

Table 21 CTCLR Command

Syntax	Description
ctclr<cr>	Use the ctclr command to restore the probe temperature factory calibration.
<p>Example:</p> <pre>>ctclr OK ></pre>	

Table 22 ACAL Command

Syntax	Description
acal<cr>	<p>Use the acal command to calibrate the analog current loop outputs.</p> <p>After you give this command, the CH1 analog output of the transmitter is set to the low limit (4mA). Measure the output and enter the measured value. After entering the low limit, you must measure and enter the high limit (20mA) also. The same procedure is then repeated with CH2. Calculated coefficients are printed after the measured values are given.</p>

Syntax	Description
<p>Example:</p> <pre>>acal Ch1 I1 (mA) ? 5.60 Ch1 I2 (mA) ? 18.40 -1.40562890E+03 a0 1.41171900E+03 a1 OK Ch2 I1 (mA) ? 5.60 Ch2 I2 (mA) ? 18.40 -1.40562890E+03 a0 1.41171900E+03 a1 OK ></pre>	
	<p>The question mark is displayed after a certain stabilization time has expired. Only enter values after the question mark is displayed. Values entered before the question mark are discarded.</p>

4.9 Configuring Serial Line Operation

Table 23 SERI Command

Syntax	Description
<p>seri [b p d s]<cr></p> <p>where</p> <p>b baud rate (9600, 19200, 38400, 76800, 115200)</p> <p>p parity (n = none, e = even, o = odd)</p> <p>d data bits (7 or 8)</p> <p>s stop bits (1 or 2)</p>	<p>Use the seri command to show or set the serial line settings for the serial port that you are currently using. Use the SAVE command after changing the settings to store them. The new settings will be taken into use when the transmitter is reset or powered up.</p>

Syntax	Description
Examples	
<pre>>seri Baud P D S : 19200 N 8 1 ></pre>	
<pre>>seri 9600 e 7 1 Baud rate : 9600 Parity : E Data bits : 7 Stop bits : 1 >save Saving settings...done ></pre>	

Table 24 ECHO Command

Syntax	Description
echo [on] [off]<cr>	To show or set the terminal echo status, use the echo command.
Examples:	
<pre>>echo COM1 Echo : OFF ></pre>	
<pre>>echo on COM1 Echo : ON</pre>	

Table 25 SMODE Command

Syntax	Description
smode [stop/run]<cr>	Use the smode command to show or set the serial interface mode. Note that a separate save command is not needed to store the new serial interface mode setting. STOP mode outputting only when command is issued, any command can be used. RUN mode outputting automatically, only command S can be used.

Syntax	Description
<p>Example:</p> <pre>>smode stop Output mode : STOP ></pre>	

4.10 Measurement Parameter Configuration Commands

Table 26 ENV Command

Syntax	Description
<p>env [x.xxxx]<cr></p> <p>where x.xxxx Absolute pressure in the measuring environment. The default is 1.013. The pressure unit is bar.</p>	<p>Use the env command to show or set the environmental compensation values. In HMT120, the humidity measurement can be compensated for ambient pressure. The value set with the env command is a permanent value which remains in use after a restart.</p>
<p>Examples:</p> <pre>>env Pressure (bar) : 1.013 ></pre> <pre>>env 0.980 Pressure (bar) : 0.98 >save Saving settings...done ></pre>	
<p> You can use the Vaisala Humidity Calculator to simulate the effect of pressure change to dewpoint. The Humidity Calculator can be found at: www.vaisala.com/humiditycalculator</p>	

4.11 Analog Output Configuration Commands

Table 27 AERR Command

Syntax	Description
<p>aerr [level1 level2]<cr></p> <p>where</p> <p>level 1 level 2 Error levels for analog output channel</p>	<p>Use the aerr command to show or set the analog output error levels.</p>
<p>Examples:</p> <pre>>aerr Ch1 Error level : 3.6 Ch2 Error level : 3.6 ></pre> <pre>>aerr 3.85 3.86 Ch1 Error level : 3.85 Ch2 Error level : 3.86 ></pre>	

Table 28 ASEL Command

Syntax	Description
<p>asel [q1 q2] [lo1 hi1 lo2 hi2]<cr></p> <p>where</p> <p>q1 q2 Analog output channel quantities</p> <p>lo1 lo2 Low limits of scaling</p> <p>hi1 hi2 High limits of scaling</p> <p>Syntax for single-parameter transmitters:</p> <p>asel [q] [lo hi]<cr></p> <p>where</p> <p>q Analog output channel quantity</p> <p>lo Low limit of scaling</p> <p>hi High limit of scaling</p>	<p>After you have defined the quantities with the calcs command, use the asel command to show or set the quantity output by the analog channels, and the scaling that is used. If you do not enter scaling limits, default values are used. Valid quantities are: RH, T, TD, TDF, A, X, H, TW, PWS, PW and NONE. The NONE parameter disables analog output and output is forced to error level.</p>

Syntax	Description
Examples:	
<pre> >asel Ch1 Quantity : RH RH lo : 0 RH hi : 100 Ch2 Quantity : T T lo : -60 T hi : 100 > </pre>	
<pre> >asel rh td Ch1 Quantity : RH RH lo : 0 RH hi : 100 Ch2 Quantity : TD T lo : -40 T hi : 60 > </pre>	
<pre> >asel t td 0 60 -20 60 Ch1 Quantity : T T lo : 0 T hi : 60 Ch2 Quantity : TD Td lo : -20 Td hi : 60 > </pre>	
<pre> >asel rh none Ch1 Quantity : RH RH lo : 0 RH hi : 100 Ch2 Quantity : NONE > </pre>	
<pre> >asel none none Ch1 Quantity : NONE Ch2 Quantity : NONE > </pre>	

Table 29 ATEST Command

Syntax	Description
<p>atest [val1 val2]<cr></p> <p>where</p> <p>val1 val2 Analog channel output value (mA)</p>	<p>Use the atest command to test the analog outputs. The atest command will force the output to the given value, which can then be measured with a calibrated multimeter.</p> <p>The atest command affects only the analog outputs and hence it does not disable measurement functions. atest without parameters will exit the test mode and let the measurement continue. It will also indicate the current analog output levels in normal measurement state</p>
<p>Examples:</p> <pre>>atest CH1: 3.800000 CH2: 3.800000 ></pre> <pre>>atest 3.9 3.9 CH1: 3.900000 CH2: 3.900000 ></pre>	

4.12 Other Commands

Table 30 DSEL Command

Syntax	Description
<p>dsel [q1 q2]<cr></p> <p>where</p> <p>q1 q2 Quantities to be shown on the transmitter display</p> <p>Syntax for single-parameter transmitters:</p> <p>dsel [q]<cr></p> <p>where</p> <p>q Quantity to be shown on the transmitter display</p>	<p>After you have defined the quantities with the calcs command, use the dsel command to show or set the displayed quantities. The number of parameters determines the display mode (that is, one or two rows). If one quantity is given, the display switches to one-row mode. If two quantities are given, the two-row mode is used. Valid quantities are: RH, T, TD, TDF, A, X, H, TW, PWS, and PW.</p>

Syntax	Description
Examples:	
<pre>>dse1 1. quantity : RH 2. quantity : T ></pre>	
<pre>>dse1 rh t 1. quantity : RH 2. quantity : T ></pre>	
<pre>>dse1 t 1. quantity : T ></pre>	

Table 31 FORM Command

Syntax	Description
<p>form <format><cr></p> <p>where format is a formatting string that consists of one of the following fields:</p> <p>"" String constant</p> <p>x.y Value length modifier. x is numbers before dot and y is numbers after dot.</p> <p>Ux Unit field length. U...U format is also supported.</p> <p>Q Quantity name (for example, rh, t, or td)</p> <p>#t or \t Tabulator</p> <p>#r or \r Carriage return</p> <p>#n or \n Line feed (new line)</p>	<p>After you have defined the quantities with the calcs command, use the form command to set the output format for the send and r commands.</p> <div style="border: 1px solid gray; padding: 10px; background-color: #f0f0f0;"> <p> • Quantity must be after x.y and Ux modifiers.</p> <p>• There must be a space between parameters, ##n or \r\n is not supported.</p> <p>• Max. string length is 80 characters.</p> <p>• If the Ux parameter is not used, unit is not displayed.</p> </div>

Syntax	Description
Examples:	
<pre>>form "RH= " 3.2 U2 rh #r #n >send RH= 32.16 % ></pre>	
<pre>>form "t=" 4.1 U3 t \t "rh=" 3.2 U2 rh \r \n >send t= 22.5 'C rh= 29.12 % ></pre>	
<pre>>form "t=" 4.1 U3 t \t "rh=" rh \r \n >send t= 22.3 'C rh= 29.5% ></pre>	
<pre>>form 3.2 UUU "RH=" rh \t "T=" t \r \n >send RH= 27.99 % T= 23.34 'C ></pre>	
<pre>>form 3.3 rh " " t \r \n >send 26.740 23.660 ></pre>	
<pre>>form "->" "RH=" 3.2 U2 rh " " "T=" 3.1 U3 t #r #n >send ->RH= 27.79 % T= 23.4 'C ></pre>	

Table 32 HELP Command

Syntax	Description
help<cr>	Use the help command to display the list of available commands.

Table 33 ERRS Command

Syntax	Description
errs<cr>	Use the errs command to display the currently active error codes. For troubleshooting active errors, see Error Codes (page 69) .

Syntax	Description
Example (no active errors):	
<pre>>errs No errors. ></pre>	

Table 34 SAVE Command

Syntax	Description
save<cr>	<p>Use the save command to save changed settings to the transmitter FLASH memory. Most settings have to be saved or the changes are lost at the next reset or power down.</p> <div style="background-color: #f0f0f0; padding: 10px; border: 1px solid #ccc;"> <p> The smode command saves the new serial mode immediately, and a separate save command is not needed.</p> <p>The probe calibration commands (crh, ct, crhclr, ctclr) store the parameters into the probe's memory automatically without a separate save command.</p> </div>
Example:	
<pre>>save Saving settings...done ></pre>	

Table 35 RESTORE Command

Syntax	Description
restore<cr>	Use the restore command to restore saved settings from transmitter FLASH memory to RAM. All unsaved changes will be lost.
<pre>>restore Restoring default settings...done ></pre>	

Table 36 RESET Command

Syntax	Description
reset<cr>	<p>Use the reset command to reset the transmitter. Upon reset or power-up, the transmitter enters the serial mode that has been set with the smode command.</p> <p>After a reset, the configuration is loaded from FLASH memory. This configuration can be altered by saving different settings with the save command.</p>
<p>Example: Transmitter set to serial mode STOP, will output transmitter software version at reset</p> <pre>>reset HMT120 / 0.1.0.001 Type "help" for command list ></pre>	

Table 37 FRESTORE Command

Syntax	Description
frestore<cr>	<p>Use the frestore command to restore the factory settings to the transmitter. All user settings, including the user-performed calibration corrections, will be lost. The transmitter will revert back to the factory calibrated settings.</p> <p>Note that this only returns the factory settings of the transmitter and not of the interchangeable probe (see Table 19 (page 35) and Table 21 (page 36)).</p>
<p>Example:</p> <pre>>frestore Restoring factory defaults...done ></pre>	

Table 38 UNIT Command

Syntax	Description
unit [metric/non_metric]<cr>	Use the unit command to show or set the output unit (metric or non-metric).

Syntax	Description
Examples:	
<pre>>unit Unit : METRIC ></pre>	
<pre>>unit non_metric Unit : NON_METRIC ></pre>	

5. Maintenance

5.1 Removing and Fastening Fixed Humidity Probe

To remove or replace the probe:

- ▶ 1. Loosen the metal locking bushing by carefully turning it counterclockwise.
- 2. Remove the probe from the transmitter by pulling it gently downwards.
- 3. Attach the new probe to the 4-pin M8 panel connector at the transmitter (only one position possible).
- 4. Tighten the locking bushing to the M8 panel connector by turning it clockwise



Figure 13 Removing the Humidity Probe (Fixed Probe Model)

- 1 Locking bushing
- 2 Holder bushing (attached permanently to the probe)
- 3 HMP110 probe

5.2 Removing and Fastening Remote Humidity Probe

To remove or replace the probe:

- ▶ 1. Unscrew the small sleeve that secures the probe in place at the end of the probe cable and pull out the probe.
- 2. Replace the probe and screw the small sleeve back on, securing the probe tightly in place.

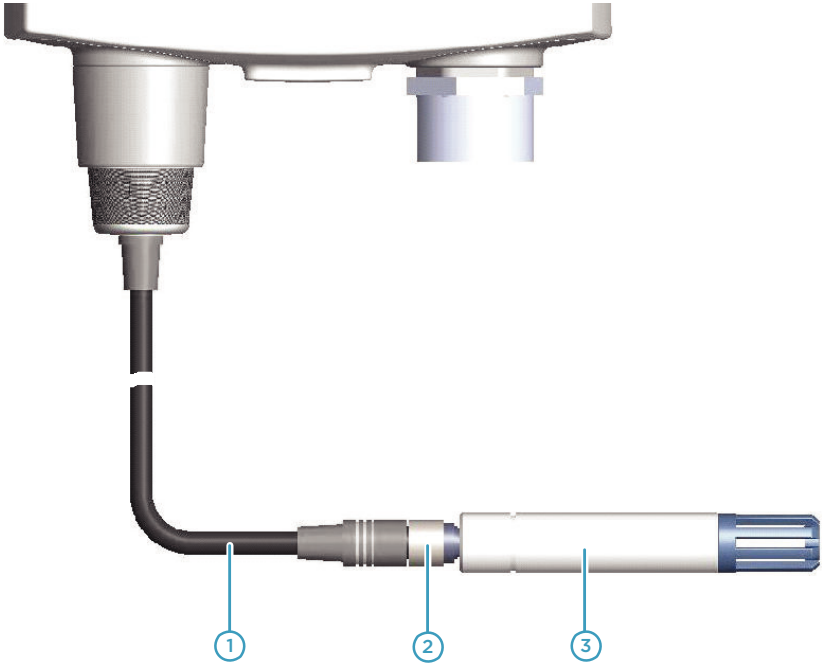

Figure 14 Removing the Humidity Probe (Remote Probe Model)

- 1 Probe cable
- 2 Sleeve securing the probe to the cable
- 3 HMP110 probe

5.3 Testing Analog Outputs

The transmitter has a built-in software function for testing analog outputs. To test the outputs:

- ▶ 1. Make sure the transmitter is not in adjustment mode (see [Calibration and Adjustment Overview \(page 52\)](#)).
- 2. Press the + adjustment button (see [Figure 11 \(page 21\)](#)).
This sets the output current level to the high point of the analog output range (20mA nominal). The output stays at this level for about 30 seconds after the + adjustment button has been pressed.
- 3. Press the - adjustment button. This sets the output current level to the low point of the analog output range (4mA nominal). The output stays at this level for about 30 seconds after the - adjustment button has been pressed.



HMT120 analog output current can be measured without removing the wires from the screw terminals by using a low-impedance multimeter between the associated + terminal and test point (CH1 or CH2) on the component board (see [Figure 15 \(page 50\)](#)).

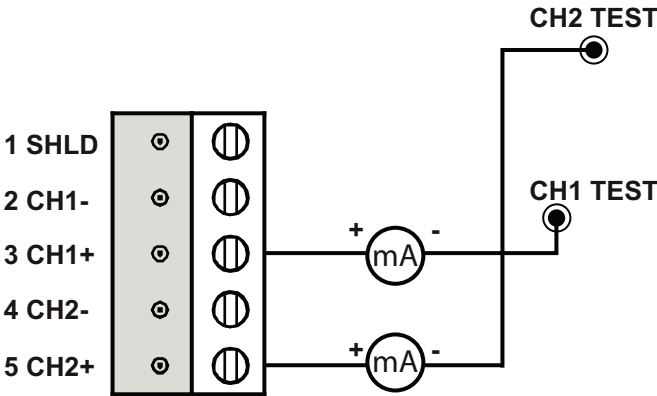

Figure 15 HMT120 Output Current Measurement



If your transmitter has the optional display, the following texts are shown on the display the during analog output test:

- **Analog output test high:** analog output set to upper limit (20 mA)
- **Analog output test low:** analog output set to low limit (4 mA)

5.4 Replacing the HUMICAP Sensor

To replace the HUMICAP® sensor on a fixed or remote probe:

- ▶ 1. Remove the filter (plastic grid or sintered stainless steel).
- 2. Remove the damaged sensor and insert a new one.
- 3. Recalibrate the probe.
- 4. If the filter is dirty, replace it to ensure maximum lifetime and fast sensor response. Do not attempt to clean the filter.

More Information

- ▶ [Calibration and Adjustment Overview \(page 52\)](#)

6. Calibration and Adjustment

6.1 Calibration and Adjustment Overview

You can calibrate and adjust the transmitter using the following tools:

- Push buttons on the transmitter motherboard
- Serial line commands
- Portable humidity meters HM70 and HMI41

A calibrator kit is needed for calibration against saturated salt solutions. The HMK15 Humidity Calibrator and pre-measured certified salts are available from Vaisala. For further information, please contact your Vaisala representative.

Vaisala Service Centers also offer accredited calibrations for humidity and temperature.

You can also remove the HMP110 probe and replace it with a new one. The old probe can be adjusted using another transmitter body, if you have one available.



RH Field Calibration and Adjustment, as instructed in this document, is restricted to a certain adjustment range to minimize the effects of special circumstances, such as chemical contamination. In case the probe is outside its adjustment/trim range due to, for example, chemical exposure, the calibration cannot be completed. In this case, it is recommended that you change the probe or contact Vaisala Services.

More Information

- › [Push-Button Calibration \(page 53\)](#)
- › [Calibration Commands \(page 34\)](#)
- › [Adjusting RH and T with MI70 Hand-Held Indicator \(page 56\)](#)
- › [Adjustment with HMI41 \(page 60\)](#)

6.2 Push-Button Calibration

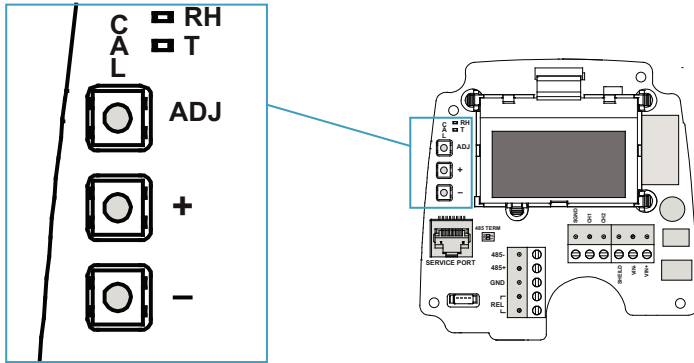

Figure 16 Adjustment Buttons

You can calibrate and adjust the transmitter with the adjustment buttons on the transmitter motherboard. The two-point humidity adjustment is carried out by using two relative humidity references: for example saturated salt points 11 % RH (LiCl) and 75 % RH (NaCl). The difference between the two humidity reference points must be at least 30 %RH. The difference between the two temperature reference points must be at least 30 °C.



In push-button calibration, the transmitter outputs are by default relative humidity in the range 0...100% RH in CH1 and temperature in the range -40...+80°C in CH2 regardless what the actual transmitter settings are. Outputs mean in this case both the display and analog current outputs.

6.2.1 Adjusting Humidity and Temperature with Push Buttons

The instructions here apply to both 1-point and 2-point calibration.

To make a humidity or temperature adjustment:

- ▶ 1. Open the transmitter cover. There are 3 buttons marked **ADJ**, **+** and **-** on the motherboard. There are also two indicator LEDs, one green and one red.
2. Press the **ADJ** button and hold it down until the green indicator LED begins to blink slowly (800ms cycle time).

3. The transmitter is now in RH calibration state. Analog output and optional display will still follow the actual measured RH value.



If you do not wish to perform the RH adjustment at this time, press the **ADJ** button one more time. The green indicator LED turns off and the red indicator LED begins to blink slowly (800ms cycle time) to indicate T calibration state. To calibrate T, follow the instructions starting from [step 7](#).

4. Remove the filter and insert the probe into a measurement hole of the dry end reference chamber (for example, LiCl: 11 % RH) to do the low humidity offset adjustment.



Do not touch the adjustment buttons before the conditions have stabilized. This takes approximately 30 minutes.

5. Press either the - or + button at least once, make sure that the I_{out} current is correct, adjust using the - and + buttons if needed, and press the **ADJ** button again. The green indicator LED begins to blink faster (400ms cycle time).



If you do not wish to perform the two-point RH adjustment at this time, press the **ADJ** button one more time. The green indicator LED turns off and the red indicator LED begins to blink slowly (800ms cycle time) to indicate T calibration state. To calibrate T, follow the instructions starting from [step 7](#). If one-point calibration is done at more than 50% RH, a gain adjustment is done instead of an offset adjustment.

6. Insert the probe into the high end reference chamber (for example, NaCl: 75 % RH chamber in the humidity calibrator HMK15) and do the high humidity gain adjustment by using the - and + buttons to make sure the I_{out} current is correct (you have to press either - or + at least once even if the value is correct). To finish the RH calibration, press the **ADJ** button. The green LED is now turned off and the red indicator LED begins to blink slowly (800ms cycle time).

7. The transmitter is now in T calibration state. Analog output and optional display will still follow the actual measured T value.



If you do not wish to perform the T adjustment at this time, press **ADJ** button one more time. The red indicator LED is turned off and the transmitter returns to normal mode. The calibration procedure is now finished.

- Insert the probe into a known reference temperature (if Vaisala Humidity Calibrator HMK15 is not used) and let the temperature reading stabilize.



Do not touch the adjustment buttons before the conditions have stabilized.

- Using the **-** and **+** buttons, make the temperature offset adjustment by making sure the I_{out} current is correct (you have to press either **-** or **+** at least once even if the value is correct) and press the **ADJ** button. The red indicator LED begins to blink faster (400ms cycle time).



If you do not wish to perform the two-point T adjustment at this time, press the **ADJ** button one more time. The red indicator LED is turned off and the transmitter returns to normal mode. The calibration procedure is now finished.

- Insert the probe into another reference temperature.



Do not touch the adjustment buttons before the conditions have stabilized.

- Using the **-** and **+** buttons, make the temperature gain adjustment by making sure the I_{out} current is correct (you have to press either **-** or **+** at least once even if the value is correct).
- Press the **ADJ** button one more time. The red indicator LED turns off and the transmitter returns to normal mode. The calibration procedure is now finished.



In case of calibration error, both LEDs blink alternately at a very fast rate (cycle time 200ms) for a period of 2s after which the transmitter returns to normal mode.



If your transmitter has the optional display, the following notifications are shown on the display during calibration:

- **Probe cal: RH 1** (corresponding the green LED blinking slowly)
- **Probe cal: RH 2** (corresponding the green LED blinking fast)
- **Probe cal: T1** (corresponding the red LED blinking slowly)
- **Probe cal: T2** (corresponding the red LED blinking fast)
- **Probe cal: Error** (corresponding both LEDs blinking alternately at very fast rate)

6.3 Adjusting RH and T with MI70 Hand-Held Indicator



- MI70 hand-held indicator (included in, for example, the HM70 package)
- MI70 connection cable (Vaisala order code: 211339)

You can check and adjust the transmitter's relative humidity and temperature measurement with the MI70 (HM70) Hand-Held Humidity and Temperature meter.

There are four types of adjustments available:

- Field checking and adjustment using a calibrated reference probe
- 1-point adjustment using a calibrator,
- 2-point adjustment using a calibrator,
- LiCl-NaCl adjustment

Start the adjustment by completing the first 7 steps and then continue according to the chosen adjustment method.

- ▶ 1. Connect the HM70 connection cable (211339) to the **SERVICE PORT** connector on the transmitter's motherboard (see [Figure 11 \(page 21\)](#)).
2. Connect the other end of the connection cable to either of the MI70 connector ports (port I or port II) located on the bottom of the indicator.

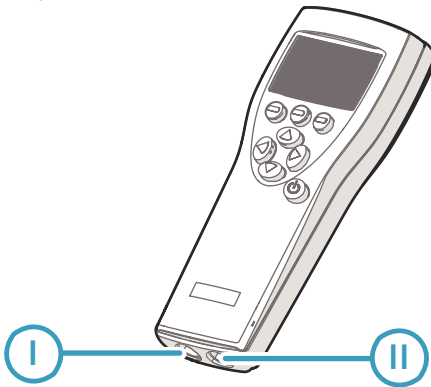

3. Turn on both devices (or just the MI70 indicator if the transmitter is on continuously).
4. The reading of the transmitter is shown on the top or middle row of the indicator display, depending on which connector port the connection cable is connected to.

5. Press the **ADJ** button on the transmitter's motherboard to open the adjustment mode. Both LEDs on the motherboard remain in **OFF** state and the text "**Starting adjustment mode for HMP110**" is shown on the MI70 display.



In transmitters with the optional display, the text **MI70 adjustment mode** is shown on the upper row of the display.



From this point onward, the transmitter's local adjustment buttons are disabled and adjustment is carried out using the MI70 indicator. The transmitter display and analog outputs will always follow the actual measured RH/T value when in MI70 adjustment mode. When operating the MI70, do not press the buttons too quickly or the calibration may fail. Wait for one second between each press.

6. Press **OK** to start the adjustment.
7. Check the environment settings if needed. Otherwise, press **NO**. Select **RH adjustment** or **T adjustment**.
8. Continue according to the instructions for one of the following adjustment methods:
 - [Field Checking and Adjustment Using a Calibrated Reference Probe \(page 57\)](#)
 - [1-Point Adjustment Using a Calibrator \(page 58\)](#)
 - [2-Point Adjustment Using a Calibrator \(page 58\)](#)
 - [LiCl-NaCl Adjustment \(page 59\)](#)
 - [Temperature Field Check and Adjustment Using a Calibrated Reference Probe \(page 60\)](#)

6.3.1 Field Checking and Adjustment Using a Calibrated Reference Probe



Complete the steps listed in [Adjusting RH and T with MI70 Hand-Held Indicator \(page 56\)](#) before continuing with this adjustment option.

- ▶ 1. Check that the probes are located in equal conditions and wait until the readings have stabilized (can take 30 minutes or more). If you are close to the probes, do not breathe in their direction.
2. Press **ADJUST** to continue adjusting.
3. Choose **To same as RHI/II** from the MI70 adjustment menu and press **SELECT**. MI70 automatically recognizes which port the HMP70 series probe is connected to.
4. Press **YES** to confirm the adjustment.
5. Turn off the MI70 and detach the connection cable.

6.3.2 1-Point Adjustment Using a Calibrator



Complete the steps listed in [Adjusting RH and T with MI70 Hand-Held Indicator](#) (page 56) before continuing with this adjustment option.

- 1. Remove the filter from the transmitter's probe and insert the probe head into the reference condition.
- 2. Press **ADJUST** to continue adjusting.
- 3. Choose **1-point adjustment** from the MI70 adjustment menu and press **SELECT**.

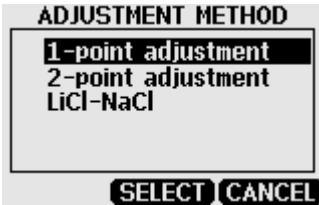

- 4. Press **READY** when the reading has stabilized in the reference condition (can take 30 minutes or more). You can follow the stabilization from the **GRAPH** display.

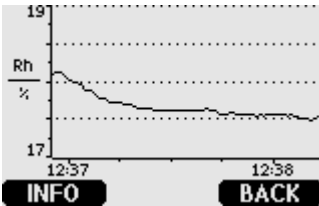

- 5. Enter the correct reference value with the arrow buttons and press **OK**.
- 6. Confirm the adjustment by pressing **YES**.
- 7. The adjustment is done. Press **BACK** and **EXIT** to return to the basic display.
- 8. Turn off the MI70 and detach the connection cable.

6.3.3 2-Point Adjustment Using a Calibrator



Complete the steps listed in [Adjusting RH and T with MI70 Hand-Held Indicator](#) (page 56) before continuing with this adjustment option.



When making a 2-point adjustment, the difference between the two reference conditions must be at least 50 %RH. If the difference is < 50 %RH, the adjustment cannot be made.

- ▶ 1. Remove the filter from the transmitter's probe and insert the probe head into the lower reference condition.
2. Press **ADJUST** to continue adjusting.
3. Choose **2-point adjustment** from the MI70 adjustment menu and press **SELECT**.
4. Press **READY** when the reading has stabilized in the first reference condition (can take 30 minutes or more). You can follow the stabilization from the **GRAPH** display.
5. Enter the correct reference value of the first condition with the arrow buttons and press **OK**.
6. Remove the probe from the first reference condition and insert the probe head into the higher humidity reference condition.
7. Press **READY** when the reading has stabilized in the second reference condition (can take 30 minutes or more). You can follow the stabilization from the **GRAPH** display.
8. Enter the correct reference value of the second condition with the arrow buttons and press **OK**.
9. Confirm the adjustment by pressing **YES** (by pressing **NO** you return to adjustment mode display and no changes are made). If the difference between the two reference conditions is less than 50 %RH, adjustment cannot be done.
10. The adjustment is done. Press **BACK** and **EXIT** to return to the basic display.
11. Turn off the MI70 and detach the connection cable.

6.3.4 LiCl-NaCl Adjustment



Complete the steps listed in [Adjusting RH and T with MI70 Hand-Held Indicator \(page 56\)](#) before continuing with this adjustment option.



This adjustment is made using relative humidity references 11.3 % RH (LiCl) and 75.5 % RH (NaCl).

- ▶ 1. Remove the filter from the transmitter's probe and insert the probe head into the LiCl salt chamber.
2. Press **ADJUST** to continue adjusting.
3. Choose **LiCl-NaCl autom.** from the MI70 adjustment menu and press **SELECT**. Press **OK** to accept the note telling about references.

4. Press **READY** when the reading has stabilized in the LiCl salt chamber (can take 30 minutes or more). You can follow the stabilization from the **GRAPH** display.
5. Remove the probe from the LiCl salt chamber and insert the probe head into the NaCl salt chamber.
6. Press **READY** when the reading has stabilized in the NaCl salt chamber (can take 30 minutes or more). You can follow the stabilization from the **GRAPH** display.
7. Confirm the adjustment by pressing **YES** (by pressing **NO** you return to adjustment mode display and no changes are made).
8. The adjustment is done. Press **BACK** and **EXIT** to return to the basic display.
9. Turn off the MI70 and detach the connection cable.

6.3.5 Temperature Field Check and Adjustment Using a Calibrated Reference Probe



Complete the steps listed in [Adjusting RH and T with MI70 Hand-Held Indicator \(page 56\)](#) before continuing with this adjustment option.

- ▶ 1. Check that the probes are located in equal conditions and wait until the readings have stabilized (can take 30 minutes or more). If you are close to the probes, do not breathe in their direction.
2. Press **ADJUST** to continue adjusting.
3. Choose **To same as THI/II** from the MI70 adjustment menu and press **SELECT**. MI70 automatically recognizes which port the HMP70 series probe is connected to.
4. Press **YES** to confirm the adjustment.



If the temperature difference between the reference probe and the transmitter is too large, the adjustment cannot be done (MI70 notifies you of this). The available reserve for T adjustment of the transmitter depends on the initial temperature calibration of the unit.

5. The adjustment is done. Press **BACK** and **EXIT** to return to the basic display.
6. Turn off the MI70 and detach the connection cable.

6.4 Adjustment with HMI41

You can check and adjust the transmitter's relative humidity measurement with the HMI41 indicator and HMP41/45/46 probes (requires the HMI41 connection cable (Vaisala order code: 25917ZZ)).

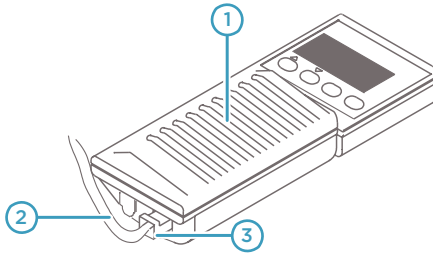

Figure 17 Location of the HMI41 Calibration Connector

- 1 HMI41 indicator
- 2 25917ZZ connection cable
- 3 EXT connector

There are three adjustment modes available: offset (dry point), gain (wet point), and 2-point adjustment. All of these can be performed using the HMI41 either as a reference meter (for example when the transmitter is mounted in an air-conditioning channel), or only as a terminal for visualizing and setting the transmitter's RH reading.

Offset and gain adjustments are performed the same way and differ only in internal calculations. Select offset adjustment when the reference humidity is $< 65\%RH$ and gain adjustment when the reference humidity is $\geq 65\%RH$. Two-point adjustment is more accurate, and includes both offset and gain corrections. For performing two-point adjustment, you need two separate measurement points with a difference of at least $50\%RH$ between them.

Start by completing the initial steps for connecting the HMI41 to the transmitter and selecting the HMI41 calibrator function, and then continue according to the chosen adjustment method.

6.4.1 Connections and Selecting the Calibrator Function

- ▶ 1. To select the calibrator function from the HMI41, press the **ON/OFF** button until you can see some text on the display. Then release the **ON/OFF** button and within 1 ... 2 seconds, press both **ENTER** and **MODE** buttons until the following display appears:









After a few seconds, the display changes to show the following:

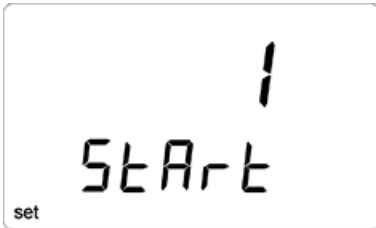

 If the basic settings (display units, automatic power off function, display quantities, and pressure) have to be changed, see the HMI41 documentation set.

- 2. Press **ENTER** repeatedly until the following display appears:



- 3. To calibrate the transmitter, select number **3** with buttons  (number up) and  (number down) and then press **ENTER**.
- 4. Next the baud rate appears on the display. Select the baud rate **19200** (= **19.2** on the HMI41 display) and press **ENTER**. Configure the rate with the  and  buttons if necessary.
- 5. The serial communications selection appears. Select the following settings: **N, 8, 1** and press **ENTER**. Configure the settings with the  and  buttons if necessary.

- Press **ON/OFF** to finish. These settings are stored in the HMI41 memory; when the HMI41 is switched on again, it automatically starts up as a calibrator for digital transmitters with these serial line settings.



After making these settings, continue with the adjustment and follow the directions of the chosen adjustment method.

6.4.2 Adjusting Offset and Gain with HMI41





Complete the HMI41 calibration setup steps listed in [Connections and Selecting the Calibrator Function \(page 62\)](#) before starting the adjustment.



Offset and gain adjustments are performed in the same way (they differ only in internal calculations), so this section is valid for both methods.

- Connect the 25917ZZ HMI41 connection cable to the **SERVICE PORT** connector on the transmitter's motherboard (see [Figure 11 \(page 21\)](#)).
- Connect the other end of the connection cable to the **EXT** connector located on the bottom of the HMI41 indicator.
- Turn on both devices. Wait until the following display appears:



- Select the appropriate adjustment mode with the  and  buttons. Select offset adjustment if the humidity is < 65 %RH and gain adjustment if the humidity is \geq 65 %RH:



or



5. Press **ENTER** to confirm the selection. A display similar to the following appears:



 If you are using a transmitter with the optional display, the message **HMI41 adjustment mode** is shown on the upper row of the display.

6. Complete the adjustment using one of the following options:
- [Adjustment Using HMI41 as Reference Meter \(page 64\)](#)
 - [Adjustment Using HMI41 as Terminal \(page 66\)](#)

6.4.2.1 Adjustment Using HMI41 as Reference Meter

 Complete the steps (connect the cable and select adjustment mode) listed in [Adjusting Offset and Gain with HMI41 \(page 63\)](#) before continuing with this adjustment method.

When you carry out an adjustment using HMI41 as a reference meter, the HMI41 humidity probe is used to show the correct humidity value (be sure that the reference probe has previously been adjusted).

To complete the adjustment:

- ▶ 1. Check the display. A display similar to the one shown below should be visible. The numbers on the first line indicate the transmitter reading, and the numbers on the second line indicate the reference probe reading.



2. Allow the readings to stabilize (can take 30 minutes or more). If you prefer, you can change the display to show the difference in the readings. Press **HOLD** and a display similar to the following appears:



The numbers on the first line indicate how much the transmitter reading differs from that of the HMI41 reference probe. The numbers on the second line indicate the reference probe reading. You can return to the previous display by pressing **HOLD** again.

3. When the readings have stabilized, press **ENTER** to complete the adjustment. When you press **ENTER**, the transmitter reading is corrected to the reference probe reading. If the adjustment has been successful, the following display appears:



4. The data is now stored in the transmitter memory. If the adjustment has not been successful, the following display appears:



In case of an error, perform the adjustment again. Whether the adjustment was successful or not, HMI41 always returns to display the selected adjustment mode.

5. When the calibration is successfully done, power off HMI41 and disconnect the cable.

6.4.2.2 Adjustment Using HMI41 as Terminal



Complete the steps (connect the cable and select adjustment mode) listed in [Adjusting Offset and Gain with HMI41 \(page 63\)](#) before continuing with this adjustment method.

When you carry out an adjustment using HMI41 as a terminal, the HMI41 humidity probe is used for visualizing and setting the transmitter's RH reading manually.

To complete the adjustment:

- 1. Check the display. A display similar to the one shown below should be visible. The numbers on the first line indicate the transmitter reading, and the numbers on the second line indicate the reference probe reading.



- 2. Allow the readings to stabilize (can take 30 minutes or more) and press **MODE**. The following display appears:



The HMI41 now works only as a terminal for setting the humidity reading. The numbers on the first line are blinking, and the numbers on the second line indicate the transmitter reading.

3. You can now set the blinking reading to the correct value (for example, the equilibrium RH of a salt solution) with the ▲ and ▼ buttons. Press **ENTER** to complete the adjustment. If the adjustment has been successful, the following display appears:



4. The data is now stored in the transmitter memory. If the adjustment has not been successful, the following display appears:



In case of an error, perform the adjustment again. Whether the adjustment was successful or not, HMI41 always returns to display the selected adjustment mode.



5. When the calibration is successfully done, power off HMI41 and disconnect the cable.

6.4.3 Troubleshooting HMI41 Adjustment

Table 6 presents a summary of the error messages that can appear during adjustment with the HMI41.

Table 39 Common Problems During HMI41 Adjustment and Their Remedies

Error Message	Probable Cause	Remedy
	This message can appear, for example, if the difference between the reference humidities is too small (< 50 %RH).	Carry out the adjustment again.

Error Message	Probable Cause	Remedy
	This message can appear during adjustment when the HMI41 is trying to contact the transmitter.	Wait.
	The connection cable is not properly connected or the serial line settings of the HMI41 and the transmitter do not correspond.	Check the connection of the calibration cable. Check that the serial line settings in the HMI41 memory correspond to those of the transmitter.

7. Troubleshooting

7.1 Error Codes

The transmitter's software provides a variety of self diagnostics information, for example, FLASH and program memory checksum, probe communication status, probe checksum, operation voltage check, and oscillator fault check.

At startup, the transmitter's software checks the factory/user settings checksum, program memory checksum, and oscillator fault status. Other checks are made during runtime. The possible error codes are listed in [Table 40 \(page 69\)](#).

Table 40 Error Codes, Descriptions and Texts

Code	Description	Error Text
1	Probe T measurement error	Probe T meas
2	Probe RH measurement error	Probe RA meas
3	Probe communication error	Probe communication
4	Probe checksum error	Probe checksum
5	Probe message form error	Probe message form
6	Program's flash checksum error	Program code checksum
7	Current settings checksum error (RAM)	Settings checksum
8	Factory FLASH not initialised	Factory defaults empty
9	User FLASH not initialised	User defaults empty
10	Voltage is too low to operate correctly	Voltage too low
11	Measurements not available	Measurements not available
12	Oscillator fault bit active	HW fault 1
13	Analog output quantity invalid	Analog output quantity invalid
14	Display quantity invalid	Display quantity invalid

You can view the error text with the **errs** serial line command. If you are using a transmitter with the optional display, the error code is shown on the display in the following format: **ERR:Code-1[.Code-2][.Code-n]**. Multiple errors are separated by a period (".") between the error codes.

7.2 Solving Typical Problems

You can check error messages with the **errs** serial line command. For a list of the possible error messages, see [Error Codes \(page 69\)](#). In case of constant error, contact Vaisala Technical Support.

Table 41 Problems and Solutions

Problem or Message	Likely Causes and Solutions
Measurement not working, any of the following errors is active: <ul style="list-style-type: none"> • Probe RH measurement error • Probe T measurement error 	<ul style="list-style-type: none"> • Sensor(s) damaged or missing. Open the probe filter and check. • Calibration is not done. Calibrate the probe. • Check the supply voltage of the transmitter.
Transmitter cannot communicate with the probe, any of the following errors is active: <ul style="list-style-type: none"> • Probe communication error • Probe checksum error • Probe message form error • Measurements not available 	<ul style="list-style-type: none"> • Check the attachment of the probe to the transmitter. • In case of remote probe, check also the interconnection cables. • Replace the probe if necessary.
Serial line command not working, outputs Unknown command .	Mistyped or unknown command, check the command syntax and parameters.
Cannot connect to serial line, current serial settings of the module are unknown.	Perform the following steps to connect: <ol style="list-style-type: none"> 1. Set your terminal settings to 19200 8 N 1 (the default settings of the transmitter). 2. Connect to the service port of the transmitter. 3. Power up the transmitter, and type "Z" on the serial line at least five times. 4. The transmitter will come online with the default settings. 5. Use the seri serial line command to set the desired serial settings and save the settings with the save command.
Any of the following errors is active: <ul style="list-style-type: none"> • Current settings checksum error • Default settings checksum error 	Internal error. Perform the following steps: <ol style="list-style-type: none"> 1. Reset or power cycle the module. Check if the error disappears. 2. Return the module to factory settings with the frestore serial line command. Check again. 3. If the error is still active, contact a Vaisala service center.

Problem or Message	Likely Causes and Solutions
Any of the following errors is active: <ul style="list-style-type: none"> • Program checksum error • Factory flash defaults checksum error • Factory flash not initialized • Oscillator fault bit active 	Faulty transmitter, contact a Vaisala service center.
Any of the following errors is active: <ul style="list-style-type: none"> • Analog output quantity invalid • Display quantity invalid 	<ul style="list-style-type: none"> • In case of Analog output quantity invalid error, select the correct output quantities (set with the calcs command) with the asel command. • In case of Display quantity invalid error, select the correct display quantities with the dsel command.

7.3 Analog Output Error Notification

If the transmitter is unable to operate due to an error, the analog outputs are set to an error level.

The default output voltage in error state is 0 V. The error voltage value can be changed using the serial interface (**aerr** serial line command): see [Analog Output Configuration Commands \(page 40\)](#).

8. Technical Data

8.1 Specifications

Table 42 Measurement Performance

Property	Description/Value
Relative Humidity	
Measurement range	0 ... 100 %RH
Accuracy (including non-linearity, hysteresis, and repeatability) at 0 ... +40 °C (+32 ... +104 °F):	
0 ... 90 %RH	±1.5 %RH
90 ... 100 %RH	±2.5 %RH
Accuracy (including non-linearity, hysteresis, and repeatability) at -40 ... 0 °C, +40 ... +80 °C (-40 ... 32 °F, 104 ... 176 °F):	
0 ... 90 %RH	±3.0 %RH
90 ... 100 %RH	±4.0 %RH
Factory calibration uncertainty at +20 °C (+68 °F):	
0 ... 90 %RH	±1.1 %RH
90 ... 100 %RH	±1.8 %RH
Humidity sensor	Vaisala HUMICAP® 180R
Stability	±2 %RH over 2 years
Stability in typical HVAC applications	±0.5 %RH per year
Temperature	
Measurement range	-40 ... +80 °C (-40 ... 176 °F)
Temperature sensor	Pt1000 RTD Class F0.1 IEC 60751
Accuracy over temperature range:	
At +15 ... +25 °C (59 ... 77 °F)	±0.2 °C (±0.36 °F)
At 0 ... +15 °C and at +25 ... +40 °C (at 32 ... 59 °F and at 77 ... 104 °F)	±0.25 °C (±0.45 °F)
At -40 ... +0 °C and at +40 ... +80 °C (at -40 ... 32 °F and at 104 ... 176 °F)	±0.4 °C (±0.72 °F)
Other Variables (Optional)	
Dew point/frost point, wet bulb temperature, enthalpy, absolute humidity, mixing ratio, vapor pressure, and saturation vapor pressure	

Table 43 Operating Environment

Property	Description/Value
Operating temperature of transmitter body, no display	-40 ... +60 °C (-40 ... 140 °F)
Operating temperature of transmitter body with display	-20 ... +60 °C (-4 ... 140 °F)
Operating temperature, HMP110 probe	-40 ... +80 °C (-40 ... 176 °F)
Storage temperature	-50 ... +70 °C (-58 ... 158 °F)
EMC compliance	EN 61326-1 and EN 55022

Table 44 Inputs and Outputs

Property	Description/Value
Current output signals	4 ... 20 mA
External loop voltage	10 ... 30 VDC ($R_L = 0 \Omega$) 20 ... 30 VDC ($R_L < 500 \Omega$)
Max. additional error caused by the analog outputs after calibration at +20 °C (68 °F) ambient temperature	±0.1 % of FS output signal
Temperature dependence of the analog outputs	±0.005 % of FS output signal

Table 45 Mechanical Specifications

Property	Description/Value
IP rating	IP65
Weight	270 g
Probe cable lengths	3 m, 5 m, 10 m - up to 50 m
Display (optional)	128 x 64 resolution full graphics B&W display without backlight
Material	
Transmitter housing	PBT plastic
Display window	PC plastic
Probe body	Stainless steel (AISI 316)
Probe grid filter	Chrome coated ABS plastic
Connections	

Property	Description/Value
Inputs and outputs	Screw terminals 0.5 ... 1.5 mm ²
Probe interface	4-pin M8 female panel connector

8.2 Spare Parts and Accessories

Table 46 Spare Parts and Accessories

Description	Order Code
HMP110 probe for HMT120	HMP110 – separate order form
HMP110R replacement probe for HMT120	HMP110R – separate order form
HMP110T temperature only probe for HMT120	HMP110T – separate order form
Constant output probe	HMP110REF – separate order form
Humidity sensor	Humicap180R
Bushing for converting remote probe to fixed probe, 10 pcs	DRW232413SP
Probe mounting flange	226061
Probe mounting clamp, 1 piece	225501
Probe mounting clamp set, 10 pcs	226067
Plastic grid filter	DRW010522SP
Plastic grid with membrane filter	DRW010525
Stainless steel sintered filter	HM46670SP
Radiation shield	DTR504A
Probe installation kit for DTR504	227777
Rain shield with installation kit	215109
Duct installation kit	215619
HMI41 connection cable	25917ZZ
HM70 connection cable	211339
Service cable for PC, USB	219685

8.3 Transmitter Dimensions

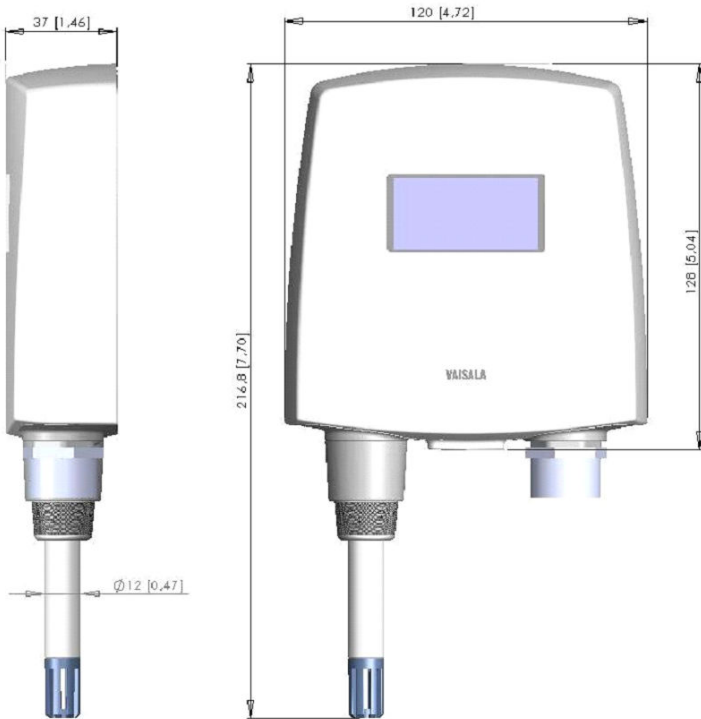

Figure 18 Fixed Probe Model Dimensions in mm(in)

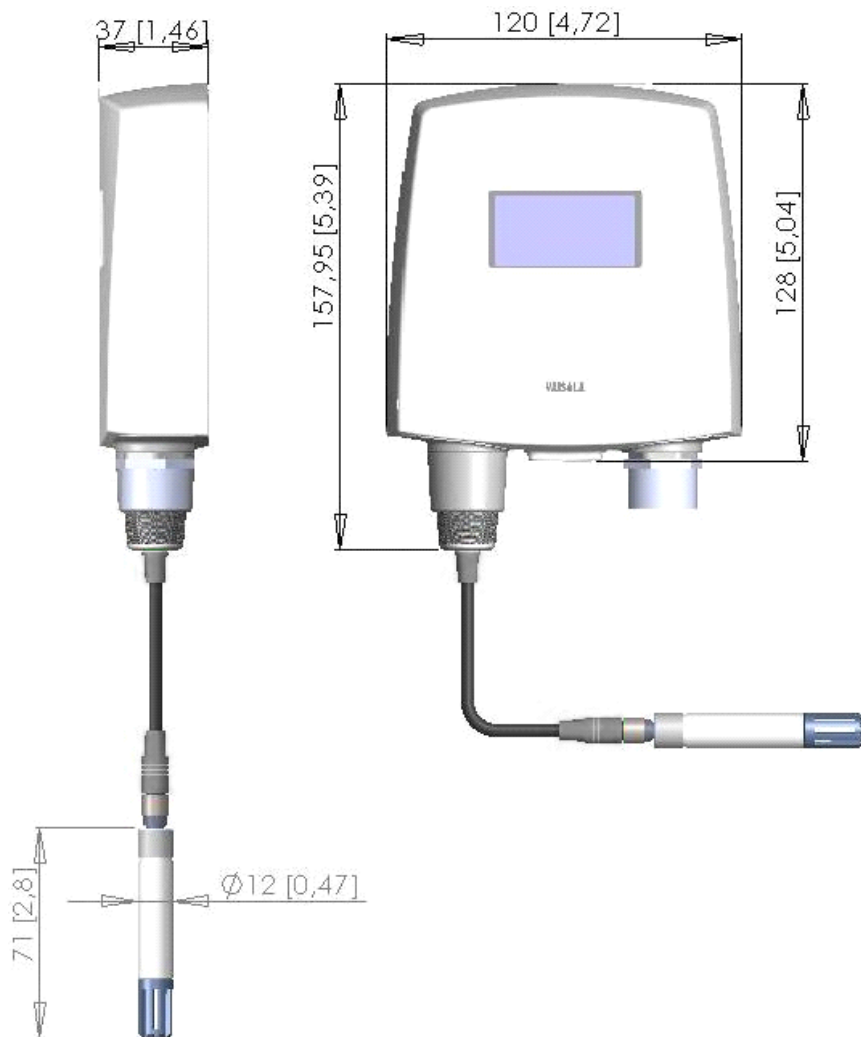

Figure 19 Remote Probe Model Dimensions in mm(in)

Appendix A. Calculation Formulas

A.1 Calculation Formulas Overview

The transmitter receives the relative humidity and temperature values from the HMP110 probe. Based on these temperature and relative humidity values, the transmitter calculates dewpoint, frostpoint, absolute humidity, mixing ratio, enthalpy, wet bulb temperature, saturation vapor pressure and vapor pressure in normal pressure.

Symbols:

T_d	Dewpoint temperature (°C)
P_w	Water vapor pressure (hPa)
P_{ws}	Saturation vapor pressure (hPa)
RH	Relative humidity (%)
x	Mixing ratio (g/kg)
p	Atmospheric pressure (hPa)
a	Absolute humidity (g/m ³)
T	Temperature (°C)
h	Enthalpy (kJ/kg)
T_w	Wet bulb temperature (°C)
T_{df}	Dew/frostpoint temperature (°C)

A.2 Dewpoint Temperature

The dewpoint temperature (T_d) of a moist air sample is the temperature to which the sample must be cooled to reach saturation with respect to liquid water.

Dewpoint temperature (T_d) is calculated with the following formula:

$$T_d = \frac{\frac{T_n}{m}}{\log\left(\frac{P_w}{A}\right)} - 1 \quad [^{\circ}C]$$

P_w is the water vapor pressure (see the separate calculation formula for **P_w**). The parameters **A**, **m**, and **T_n** depend on the temperature as shown in [Table 47 \(page 77\)](#).

Table 47 Temperature Dependence for A, m, and T_n

T	A	m	T _n
... 0 °C	6.119866	7.926104	250.4138
0 ... 50 °C	6.1078	7.5000	237.30

T	A	m	Tn
50 ... 100 °C	5.9987	7.3313	229.10
100 ... 150 °C	5.8493	7.2756	225.00
150 ... °C	6.2301	7.3033	230.00

A.3 Dew/frostpoint Temperature Calculation

Dew/frostpoint temperature (T_{df}) is calculated with the following formula:

$$T_d \geq 0 \rightarrow T_{df} = T_d$$

$$T_d < 0 \rightarrow T_{df} = \frac{\frac{T_n}{m}}{\log\left(\frac{P_w}{A}\right)} - 1 \quad [^\circ C]$$

P_w is the water vapor pressure (see the separate calculation formula for P_w). The parameters **A**, **m**, and **T_n** depend on the temperature as shown in [Table 48 \(page 78\)](#).

Table 48 Temperature Dependence for A, m, and Tn

T	A	m	Tn
... 0 °C	6.1134	9.7911	273.47

A.4 Mixing Ratio Calculation

The mixing ratio (**x**, mass of water vapour/mass of dry gas) is calculated with the following formula:

$$x = B \times \frac{P_w}{p - P_w} \quad [g/kg]$$

where

B 621.9907 g/kg

The value of B depends on the gas. 621.9907 g/kg is valid for air.

A.5 Saturation Vapor Pressure Calculation

Saturation vapor pressure (P_{ws}) is the equilibrium water vapor pressure in a closed chamber containing liquid water. It is a function only of temperature, and it indicates the maximum amount of water that can exist in the vapor state.

Water vapor saturation pressure (P_{ws}) is calculated with the following 2 formulas:

$$\theta = T - \sum_{i=0}^3 C_i T^i \quad [hPa]$$

where

T Temperature in K

C_i Coefficients

C_0 0.49313580

C_1 $-0.46094296 \cdot 10^{-2}$

C_2 $0.13746454 \cdot 10^{-4}$

C_3 $-0.12743214 \cdot 10^{-7}$

$$\ln P_{ws} = T - \sum_{i=-1}^3 b_i \theta^i + b_4 \ln \theta$$

where

b_i Coefficients

b_{-1} $-0.58002206 \cdot 10^4$

b_0 $0.13914993 \cdot 10^1$

b_1 $-0.48640239 \cdot 10^{-1}$

b_2 $0.41764768 \cdot 10^{-4}$

b_3 $-0.14452093 \cdot 10^{-7}$

b_4 6.5459673

A.6 Water Vapor Pressure Calculation

Vapor pressure refers to the vapor pressure of water in air or other gas. Water vapor has a partial pressure P_w which is part of the total pressure of the gas.

Water vapor pressure (**Pw**) is calculated with the following formula:

$$P_w = RH \cdot \frac{P_{ws}}{100} \quad [hpa]$$

A.7 Absolute Humidity Calculation

Absolute humidity (**a**) is defined as the mass of water vapour in a certain volume. If ideal gas behaviour is assumed, the absolute humidity can be calculated using the following formula:

$$a = C \cdot \frac{P_w}{T + 273.15} \quad [g/m^3]$$

where

C 216.679 gK/J

A.8 Enthalpy Calculation

Enthalpy (**h**) can be calculated from the mixing ratio (**x**) using the following formula:

$$h = T \cdot (1.01 + 0.00189 \cdot x) + 2.5 \cdot x \quad [kJ/kg]$$

A.9 Accuracies of Calculated Variables

Accuracies of the calculated variables depend on the calibration accuracy of the humidity and temperature sensors; here the accuracies are given for ± 2 %RH and ± 0.2 °C.

A.9.1 Accuracy of Dewpoint Temperature °C

Table 49 Accuracy of Dewpoint Temperature °C

Relative Humidity (%RH)										
Temp	10	20	30	40	50	60	70	80	90	100
-40 °C	1.86	1.03	0.76	0.63	0.55	0.50	0.46	0.43	—	—
-20 °C	2.18	1.19	0.88	0.72	0.62	0.56	0.51	0.48	—	—
0 °C	2.51	1.37	1.00	0.81	0.70	0.63	0.57	0.53	0.50	0.48
20 °C	2.87	1.56	1.13	0.92	0.79	0.70	0.64	0.59	0.55	0.53
40 °C	3.24	1.76	1.27	1.03	0.88	0.78	0.71	0.65	0.61	0.58
60 °C	3.60	1.96	1.42	1.14	0.97	0.86	0.78	0.72	0.67	0.64
80 °C	4.01	2.18	1.58	1.27	1.08	0.95	0.86	0.79	0.74	0.70
100 °C	4.42	2.41	1.74	1.40	1.19	1.05	0.95	0.87	0.81	0.76
120 °C	4.86	2.66	1.92	1.54	1.31	1.16	1.04	0.96	0.89	0.84
140 °C	5.31	2.91	2.10	1.69	1.44	1.26	1.14	1.05	0.97	0.91

Relative Humidity (%RH)										
Temp	10	20	30	40	50	60	70	80	90	100
160 °C	5.80	3.18	2.30	1.85	1.57	1.38	1.24	1.14	1.06	0.99

A.9.2 Accuracy of Mixing Ratio g/kg (Ambient Pressure 1013 mbar)

Table 50 Accuracy of Mixing Ratio g/kg (Ambient Pressure 1013 mbar)

Relative Humidity (%RH)										
Temp	10	20	30	40	50	60	70	80	90	100
-40 °C	0.003	0.003	0.003	0.003	0.003	0.004	0.004	0.004	—	—
-20 °C	0.017	0.018	0.019	0.021	0.022	0.023	0.025	0.026	—	—
0 °C	0.08	0.09	0.09	0.10	0.10	0.11	0.11	0.12	0.13	0.13
20 °C	0.31	0.33	0.35	0.37	0.39	0.41	0.43	0.45	0.47	0.49
40 °C	0.97	1.03	1.10	1.17	1.24	1.31	1.38	1.46	1.54	1.62
60 °C	2.68	2.91	3.16	3.43	3.72	4.04	4.38	4.75	5.15	5.58
80 °C	6.73	7.73	8.92	10.34	12.05	14.14	16.71	19.92	24.01	29.29
100 °C	16.26	21.34	28.89	40.75	60.86	98.85	183.66	438.56	—	—
120 °C	40.83	74.66	172.36	—	—	—	—	—	—	—

A.9.3 Accuracy of Wet Bulb Temperature °C

Table 51 Accuracy of Wet Bulb Temperature °C

Relative Humidity (%RH)										
Temp	10	20	30	40	50	60	70	80	90	100
-40 °C	0.20	0.20	0.20	0.20	0.20	0.20	0.20	0.20	—	—
-20 °C	0.21	0.21	0.22	0.22	0.22	0.22	0.23	0.23	—	—
0 °C	0.27	0.28	0.28	0.29	0.29	0.29	0.30	0.30	0.31	0.31
20 °C	0.45	0.45	0.45	0.44	0.44	0.44	0.43	0.43	0.42	0.42
40 °C	0.84	0.77	0.72	0.67	0.64	0.61	0.58	0.56	0.54	0.52
60 °C	1.45	1.20	1.03	0.91	0.83	0.76	0.71	0.67	0.63	0.60
80 °C	2.23	1.64	1.32	1.13	0.99	0.89	0.82	0.76	0.72	0.68

Relative Humidity (%RH)										
Temp	10	20	30	40	50	60	70	80	90	100
100 °C	3.06	2.04	1.58	1.31	1.14	1.01	0.92	0.85	0.80	0.75
120 °C	3.85	2.40	1.81	1.48	1.28	1.13	1.03	0.95	0.88	0.83
140 °C	4.57	2.73	2.03	1.65	1.41	1.25	1.13	1.04	0.97	0.91
160 °C	5.25	3.06	2.25	1.82	1.55	1.37	1.24	1.13	1.05	0.99

A.9.4 Accuracy of Absolute Humidity g/m³

Table 52 Accuracy of Absolute Humidity g/m³

Relative Humidity (%RH)										
Temp	10	20	30	40	50	60	70	80	90	100
-40 °C	0.004	0.004	0.005	0.005	0.005	0.006	0.006	0.006	--	-
-20 °C	0.023	0.025	0.027	0.029	0.031	0.032	0.034	0.036	-	-
0 °C	0.10	0.11	0.12	0.13	0.13	0.14	0.15	0.15	0.16	0.17
20 °C	0.37	0.39	0.41	0.43	0.45	0.47	0.49	0.51	0.53	0.55
40 °C	1.08	1.13	1.18	1.24	1.29	1.34	1.39	1.44	1.49	1.54
60 °C	2.73	2.84	2.95	3.07	3.18	3.29	3.40	3.52	3.63	3.74
80 °C	6.08	6.30	6.51	6.73	6.95	7.17	7.39	7.61	7.83	8.05
100 °C	12.2	12.6	13.0	13.4	13.8	14.2	14.6	15.0	15.3	15.7
120 °C	22.6	23.3	23.9	24.6	25.2	25.8	26.5	27.1	27.8	28.4
140 °C	39.1	40.0	41.0	42.0	43.0	44.0	45.0	45.9	46.9	47.9
160 °C	63.5	64.9	66.4	67.8	69.2	70.7	72.1	73.5	74.9	76.4

Index

A

- absolute humidity calculation..... 80
- accessories.....9
- accuracies of calculated variables...80
- accuracy of absolute humidity g/m³
82
- accuracy of dewpoint temperature °C
80
- accuracy of mixing ratio g/kg
(ambient pressure 1013 mbar)..... 81
- accuracy of wet bulb temperature °C
81
- adjusting humidity and temperature
with push buttons.....53
- adjusting offset and gain with HMI41
63
- adjusting RH with MI70 hand-held
indicator..... 56
- adjustment using HMI41 as reference
meter..... 64
- adjustment using HMI41 as terminal
66
- adjustment with HM41.....60
- analog output configuration
commands.....40
- analog output error notification..... 71

C

- calculation formulas..... 77
- calibration and adjustment
commands.....34
- calibration and adjustment overview
52
- compliance..... 12
- connecting with a computer..... 24
- connections and selecting the
calibrator function..... 62
- constant output probe..... 10

D

- device information and status..... 27
- dew/frostpoint temperature
calculation.....78
- dewpoint temperature calculation...77
- drilling instructions for duct
installation kit..... 19
- duct installation..... 17

E

- enthalpy calculation..... 80
- error codes.....69
- ESD protection.....12

F

- fixed and remote probe models.....9

H

- HMT120 component board.....21
- HMT120 overview..... 9

I

- installing with radiation shield.....16
- installing with rain shield.....15
- interchangeable probe.....10
- introduction.....9

L

- list of serial commands.....26

M

- maintenance: testing analog outputs
50
- measurement parameter
configuration commands.....39
- MI70 adjustment: 1-point adjustment
with calibrator..... 58
- MI70 adjustment: 2-point adjustment
with calibrator..... 58

MI70 adjustment: field checking and adjustment using a calibrated reference probe..... 57

MI70 adjustment: LiCl- NaCl adjustment.....59

MI70 adjustment: temperature field check and adjustment using a calibrated reference probe..... 60

mixing ratio calculation..... 78

O

opening transmitter cover.....13

optional display.....10

other serial line commands.....42

P

probe assembly with duct installation kit..... 18

probe mounting clamp.....19

probe mounting flange..... 20

push-button calibration.....53

R

removing and fastening fixed probe 48

removing and fastening remote probe..... 49

replacing the HUMICAP sensor..... 51

S

safety..... 12

saturation vapor pressure calculation 79

serial interface settings..... 23

serial line operation commands..... 37

serial line output and communication commands..... 32

service port..... 23

solving typical problems..... 70

spare parts and accessories..... 74

specifications.....72

T

trademarks.....8

transmitter dimensions..... 75

transmitter parts..... 11

troubleshooting HMI41 adjustment..67

U

USB driver.....23

using service port..... 23

W

wall mounting..... 14

water vapor pressure calculation..... 79

wiring..... 22

Warranty

For standard warranty terms and conditions, see www.vaisala.com/warranty.

Please observe that any such warranty may not be valid in case of damage due to normal wear and tear, exceptional operating conditions, negligent handling or installation, or unauthorized modifications. Please see the applicable supply contract or Conditions of Sale for details of the warranty for each product.

Technical Support



Contact Vaisala technical support at helpdesk@vaisala.com. Provide at least the following supporting information:

- Product name, model, and serial number
- Name and location of the installation site
- Name and contact information of a technical person who can provide further information on the problem

For more information, see www.vaisala.com/support.

Recycling



Recycle all applicable material.



Follow the statutory regulations for disposing of the product and packaging.

VAISALA

www.vaisala.com

