

ViewSonic®



CDE4320

Commercial Display

User Guide

IMPORTANT: Please read this User Guide to obtain important information on installing and using your product in a safe manner, as well as registering your product for future service. Warranty information contained in this User Guide will describe your limited coverage from ViewSonic Corporation, which is also found on our web site at <http://www.viewsonic.com> in English, or in specific languages using the Regional selection box in the upper right corner of our website. “Antes de operar su equipo lea cuidadosamente las instrucciones en este manual”

Model No. VS17890

Thank you for choosing ViewSonic

As a world leading provider of visual solutions, ViewSonic is dedicated to exceeding the world's expectations for technological evolution, innovation, and simplicity. At ViewSonic, we believe that our products have the potential to make a positive impact in the world, and we are confident that the ViewSonic product you have chosen will serve you well.

Once again, thank you for choosing ViewSonic !



Compliance Information

This section addresses all connected requirements and statements regarding regulations. Confirmed corresponding applications shall refer to nameplate labels and relevant markings on the unit.

FCC Statement

This device complies with Part 15 of the FCC Rules. Operation is subject to the following two conditions: (1) this device may not cause harmful interference, and (2) this device must accept any interference received, including interference that may cause undesired operation.

NOTE: This equipment has been tested and found to comply with the limits for a Class B digital device, pursuant to part 15 of the FCC Rules. These limits were designed to provide reasonable protection against harmful interference in a residential installation. This equipment generates, uses, and can radiate radio frequency energy, and if not installed and used in accordance with the instructions, may cause harmful interference to radio communications. However, there is no guarantee that interference will not occur in a particular installation. If this equipment does cause harmful interference to radio or television reception, which can be determined by turning the equipment off and on, the user is encouraged to try to correct the interference by one or more of the following measures:

- Reorient or relocate the receiving antenna.
- Increase the separation between the equipment and receiver.
- Connect the equipment into an outlet on a circuit different from that to which the receiver is connected.
- Consult the dealer or an experienced radio/TV technician for help.

Warning: You are cautioned that changes or modifications not expressly approved by the party responsible for compliance could void your authority to operate the equipment.

CAN ICES-3 (B)/NMB-3(B)

CE Conformity for European Countries

 The device complies with the EMC Directive 2014/30/EU and Low Voltage Directive 2014/35/EU.

WARNING: This equipment is compliant with Class B of EN55032. In a residential environment this equipment may cause radio interference.

Following information is only for EU-member states:

The mark shown to the right is in compliance with the Waste Electrical and Electronic Equipment Directive 2012/19/EU (WEEE). The mark indicates the requirement NOT to dispose the equipment as unsorted municipal waste, but use the return and collection systems according to local law.



Declaration of RoHS2 Compliance

This product has been designed and manufactured in compliance with Directive 2011/65/EU of the European Parliament and the Council on restriction of the use of certain hazardous substances in electrical and electronic equipment (RoHS2 Directive) and is deemed to comply with the maximum concentration values issued by the European Technical Adaptation Committee (TAC) as shown below:

Substance	Proposed Maximum Concentration	Actual Concentration
Lead (Pb)	0.1%	< 0.1%
Mercury (Hg)	0.1%	< 0.1%
Cadmium (Cd)	0.01%	< 0.01%
Hexavalent Chromium (Cr ⁶⁺)	0.1%	< 0.1%
Polybrominated biphenyls (PBB)	0.1%	< 0.1%
Polybrominated diphenyl ethers (PBDE)	0.1%	< 0.1%
Bis(2-ethylhexyl) phthalate (DEHP)	0.1%	< 0.1%
Butyl benzyl phthalate (BBP)	0.1%	< 0.1%
Dibutyl phthalate (DBP)	0.1%	< 0.1%
Diisobutyl phthalate (DIBP)	0.1%	< 0.1%

Certain components of products as stated above are exempted under the Annex III of the RoHS2 Directives as noted below: Examples of exempted components are:

1. Lead as an alloying element in aluminium containing up to 0.4% lead by weight
2. Copper alloy containing up to 4% lead by weight
3. Lead in high melting temperature type solders (i.e. lead-based alloys containing 85% by weight or more lead)
4. Electrical and electronic components containing lead in a glass or ceramic other than dielectric ceramic in capacitors, e.g. piezoelectronic devices, or in a glass or ceramic matrix compound

ENERGY STAR® statement

ENERGY STAR® is a U.S. Environmental Protection Agency voluntary program that helps businesses and individuals save money and protect our climate through superior energy efficiency. Products that earn the ENERGY STAR® prevent greenhouse gas emissions by meeting strict energy efficiency criteria or requirements set by the U.S. Environmental Protection Agency.

As an ENERGY STAR® Partner, ViewSonic is determined to meet the ENERGY STAR® Guidelines and mark all certified models with the ENERGY STAR® logo.

The following logo appears on all ENERGY STAR®-certified models:



NOTE: The power management features significantly reduce energy consumption when the product is not in use. Power management allows the device to automatically enter a low power “sleep” mode after a defined period of inactivity. And the power management features also enter Sleep Mode or Off Mode within 5 minutes of being disconnected from a host computer. Please note any change in energy settings will increase energy consumption.

Safety Precautions

FOR OPTIMUM PERFORMANCE, PLEASE NOTE THE FOLLOWING WHEN SETTING UP AND USING THE LCD COLOR MONITOR:

- DO NOT REMOVE MONITOR BACK COVER. There are no user serviceable parts inside and opening or removing covers may expose you to dangerous shock hazards or other risks. Refer all servicing to qualified service personnel.
- Do not spill any liquids into the cabinet or use your monitor near water.
- Do not insert objects of any kind into the cabinet slots, as they may touch dangerous voltage points, which can be harmful or fatal or may cause electric shock, fire or equipment failure.
- Do not place any heavy objects on the power cord. Damage to the cord may cause shock or fire.
- Do not place this product on a sloping or unstable cart, stand or table, as the monitor may fall, causing serious damage to the monitor.
- Do not place any objects onto the monitor and do not use the monitor outdoors.
- The inside of the fluorescent tube located within the LCD monitor contains mercury. Please follow the laws or rules of your municipality to dispose of the tube properly.
- Do not bend power cord.
- Do not use monitor in high temperature, humid, dusty, or oily areas.
- If monitor or glass is broken, do not come in contact with the liquid crystal and handle with care.
- Allow adequate ventilation around the monitor, so that heat can properly dissipate. Do not block ventilated openings or place the monitor near a radiator or other heat sources. Do not put anything on top of the monitor.
- The power cable connector is the primary means of detaching the system from the power supply. The monitor should be installed close to a power outlet, which is easily accessible.
- Handle with care when transporting. Save packaging for transporting.
- Please clean the holes of back cabinet to reject dirt and dust at least once a year because of set reliability.
- If using the cooling fan continuously, it's recommended to wipe holes a minimum of once a month.
- When installing the remote control batteries;
 - Align the batteries according to the (+) and (-) indications inside the case.
 - Align the (-) indication of the battery first inside the case.
- Usage of other than specified head- or earphones can result in hearing loss due to excessive sound pressures.
- The terms HDMI and HDMI High-Definition Multimedia Interface, and the HDMI Logo are trademarks or registered trademarks of HDMI Licensing Administrator, Inc. in the United States and other countries.

CAUTION:

Immediately unplug your monitor from the wall outlet and refer servicing to qualified service personnel under the following conditions:

- When the power supply cord or plug is damaged.
- If liquid has been spilled, or objects have fallen into the monitor.
- If the monitor has been exposed to rain or water.
- If the monitor has been dropped or the cabinet damaged.
- If the monitor does not operate normally by following operating instructions.

Recommended Use**CAUTION:**

- For optimum performance, allow 20 minutes for warm-up.
- Rest your eyes periodically by focusing on an object at least 5 feet away. Blink often.
- Position the monitor at a 90° angle to windows and other light sources to minimize glare and reflections.
- Clean the LCD monitor surface with a lint-free, nonabrasive cloth. Avoid using any cleaning solution or glass cleaner!
- Adjust the monitor's brightness, contrast and sharpness controls to enhance readability.
- Avoid displaying fixed patterns on the monitor for long periods of time to avoid image persistence (after image effects).
- Get regular eye checkups.

Ergonomics

To realize the maximum ergonomic benefits, we recommend the following:

- Use the preset Size and Position controls with standard signals.
- Use the preset Color Setting.
- Use non-interlaced signals.
- Do not use primary color blue on a dark background, as it is difficult to see and may produce eye fatigue due to insufficient contrast.

Table Of Contents

1. Unpacking and Installation	1
1.1. Unpacking	1
1.2. Package Contents	1
1.3. Installation Notes	1
1.4. Mounting on a Wall	2
1.4.1. VESA Grid	2
2. Parts and Functions	4
2.1. Control Panel	4
2.2. Input/Output Terminals	5
2.3. Remote Control	6
2.3.1. General functions	6
2.3.2. Inserting batteries in the remote control	7
2.3.3. Handling the remote control	7
2.3.4. Operating range of the remote control	7
3. Connecting External Equipment	8
3.1. Connecting External Equipment (DVD/VCR/VCD)	8
3.1.1. Using HDMI video input	8
3.2. Connecting a PC	8
3.2.1. Using DVI input	8
3.2.2. Using HDMI input	8
3.3. Connecting Audio Equipment	9
3.3.1. Connecting an external audio device	9
3.4. IR Pass-through Connection	10
3.5. IR Pass-through Connection	10
4. Operation	11
4.1. Start-up and initial Setting	11
4.1.1. Welcome	11
4.1.2. Ethernet	11
4.1.3. Date & Time	11
4.2. Watch the Connected Video Source	11
5. Launcher	12
5.1. Setting	12
5.2. Ethernet	12
5.2.1. DHCP	12
5.2.2. Static IP	12
5.3. Device	13
5.3.1. General Settings	13
5.3.2. Source Settings	14
5.3.3. Security	14
5.3.4. Clear Storage	14
5.3.5. Reset	15
5.3.6. Import & Export	15
5.3.7. Clone	15
5.3.8. Backlight	15
5.4. System	16
5.4.1. Date & time	16
5.4.2. About	16
6. OSD Menu	17
6.1. Settings	17
6.1.1. Picture menu	17
6.1.2. Screen menu	18
6.1.3. Audio menu	18
6.1.4. Time	19
6.1.5. Advanced	19
6.1.6. About	21
7. Supported Media Formats	22
8. Input mode	26
9. Cleaning and Troubleshooting	29
9.1. Cleaning	29
9.2. Troubleshooting	30
10. Technical Specifications	31
11. RS232 Protocol	33
11.1. Introduction	33
11.2. Description	33
11.2.1. Hardware specification	33
11.2.2. Communication Setting	33
11.2.3. Command Message Reference	33
11.3. Protocol	34
11.3.1. Set-Function Listing	34
11.3.2. Get-Function Listing	38
11.3.3. Remote Control Pass- through mode	42
12. Other Information	44
Customer Support	44
Limited Warranty	45
Mexico Limited Warranty	47

Copyright Information

Copyright © ViewSonic® Corporation, 2019. All rights reserved.

ViewSonic®, the three birds logo, OnView, ViewMatch, and ViewMeter are registered trademarks of ViewSonic® Corporation.

Macintosh and Power Macintosh are registered trademarks of Apple Inc.

Microsoft, Windows, and the Windows logo are registered trademarks of Microsoft Corporation in the United States and other countries.

VESA is a registered trademark of the Video Electronics Standards Association. DPMS, DisplayPort, and DDC are trademarks of VESA.

Disclaimer: ViewSonic® Corporation shall not be liable for technical or editorial errors or omissions contained herein; nor for incidental or consequential damages resulting from furnishing this material, or the performance or use of this product.

In the interest of continuing product improvement, ViewSonic® Corporation reserves the right to change product specifications without notice. Information in this document may change without notice.

No part of this document may be copied, reproduced, or transmitted by any means, for any purpose without prior written permission from ViewSonic® Corporation.

Product Registration

To meet your future needs, and to receive any additional product information as it becomes available, please register your product on the Internet at:
www.viewsonic.com.

For Your Records

Product Name:	CDE4320 ViewSonic Commercial Display
Model Number:	VS17890
Document Number:	CDE4320_UG_ENG Rev. 1A 08-12-19
Serial Number:	_____
Purchase Date:	_____

Product disposal at end of product life

ViewSonic® respects the environment and is committed to working and living green. Thank you for being part of Smarter, Greener Computing. Please visit the ViewSonic® website to learn more.

USA & Canada: <http://www.viewsonic.com/company/green/recycle-program/>

Europe: <http://www.viewsoniceurope.com/eu/support/call-desk/>

Taiwan: <https://recycle.epa.gov.tw/>

1. Unpacking and Installation

1.1. Unpacking

- This product is packed in a carton, together with the standard accessories.
- Any other optional accessories will be packed separately.
- Due to the size and weight of this display it is recommended for two people to move it.
- After opening the carton, ensure that the contents are complete and in good condition.

1.2. Package Contents

Please verify that you received the following items with your package content:

- LCD display
- Remote control with AAA batteries
- Quick Start Guide
- Power cord (1.8 m)
- RS232 cable (1.8 m)
- HDMI cable (1.8 m)

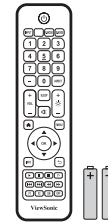
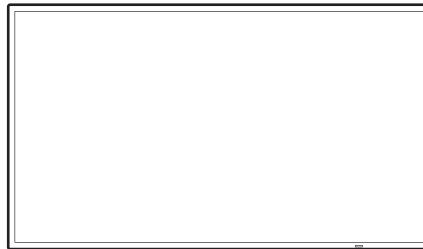

Remote Control and AAA Batteries

* The supplied power cord varies depending on destination.

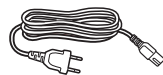

For EU



For China

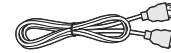

HDMI Cable



Quick Start Guide

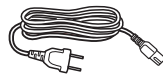

For North America



For UK



RS232 Cable

NOTES:

- For all other regions, apply a power cord that conforms to the AC voltage of the power socket and has been approved by and complies with the safety regulations of the particular country.
- Keep the package box and packing material for shipping the display.

1.3. Installation Notes

- Due to the high power consumption, always use the plug exclusively designed for this product. If an extended line is required, please consult your service agent.
- The product should be installed on a flat surface to avoid tipping. The distance between the back of the product and the wall should be maintained for proper ventilation. Avoid installing the product in the kitchen, bathroom or any other places with high humidity so as not to shorten the service life of the electronic components.
- The product can normally operate only under 3000 m in altitude. In installations at altitudes above 3000 m, some abnormalities may be experienced.

1.4. Mounting on a Wall

To mount this display to a wall, you will have to obtain a standard wall-mounting kit (commercially available). We recommend using a mounting interface that complies with UL1678 standard in North America.

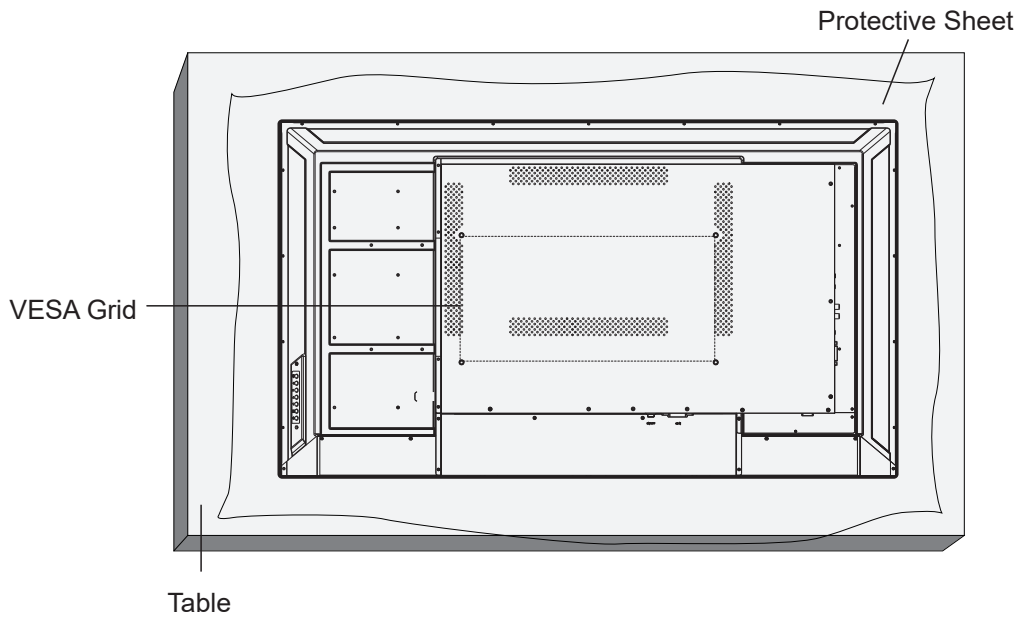

1. Lay a protective sheet on a table, which was wrapped around the display when it was packaged, beneath the screen surface so as not to scratch the screen face.
2. Ensure you have all accessories for mounting this display (wall mount, ceiling mount, table stand, etc)
3. Follow the instructions that come with the base mounting kit. Failure to follow correct mounting procedures could result in damage to the equipment or injury to the user or installer. Product warranty does not cover damage caused by improper installation.
4. For the wall-mounting kit, use M6 mounting screws (having a length 25 mm longer than the thickness of the mounting bracket) and tighten them securely.
5. Unit without base weight= 10.5 Kg. The equipment and its associated mounting means still remain secure during the test. For use only with UL Listed Wall Mount Bracket with minimum weight/load: 10.5 Kg.
6. Portrait is not allowed.

1.4.1. VESA Grid

Model	Vesa Grid
CDE4320	400(H) x 200(V)mm

Caution:

To prevent the display from falling:

- For wall or ceiling installation, we recommend installing the display with metal brackets which are commercially available. For detailed installation instructions, refer to the guide received with the respective bracket.
- To lessen the probability of injury and damage resulting from fall of the display in case of earthquake or other natural disaster, be sure to consult the bracket manufacturer for installation location.

Ventilation Requirements for enclosure locating

To allow heat to disperse, leave space between surrounding objects as shown in the diagram below.

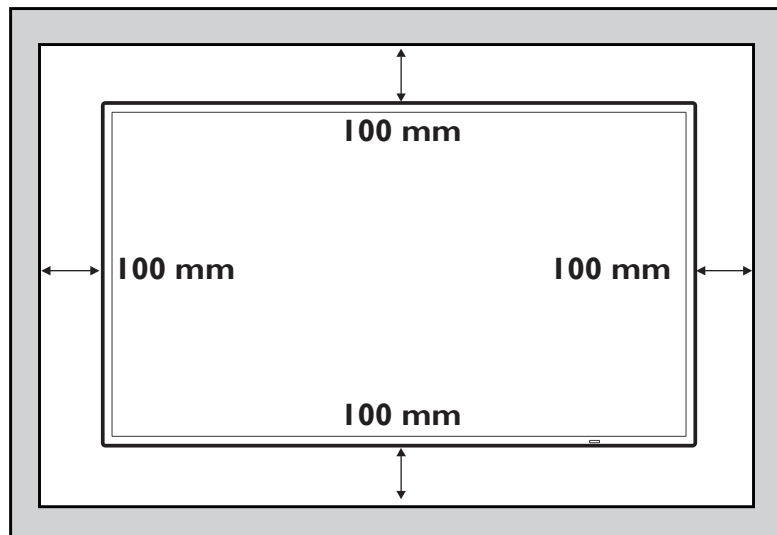







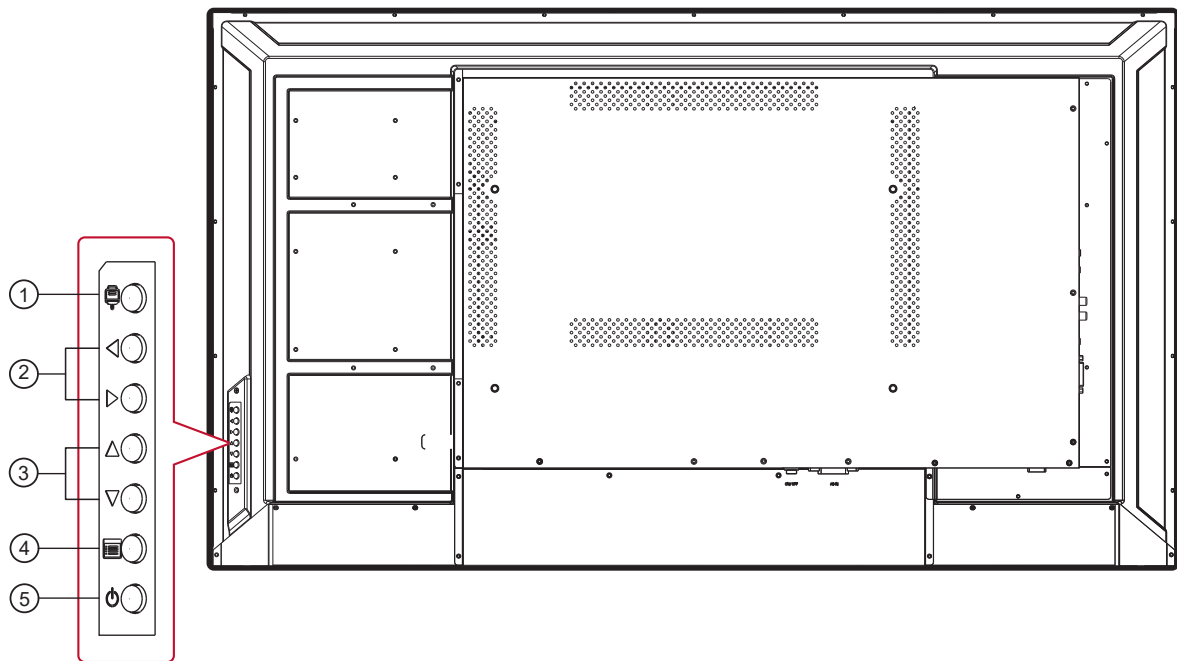

NOTES:

When installing the display on a wall, proper installation. We accept no liability for installations not performed by a professional technician.

2. Parts and Functions

2.1. Control Panel



- ① Press the  key to enter the signal source selection menu, and to select the signal source. It is used to confirm the operation under the MENU operations.
- ② : It is used to adjust the volume. In the OSD menu, press the  key to adjust the value of the selected item.
- ③ : In the OSD menu, press the  key to select an item.
- ④ Press the  key to enter the main menu, and it confirms the operation in the SOURCE menu.
- ⑤ Press  to On or Off the display.

2.2. Input/Output Terminals

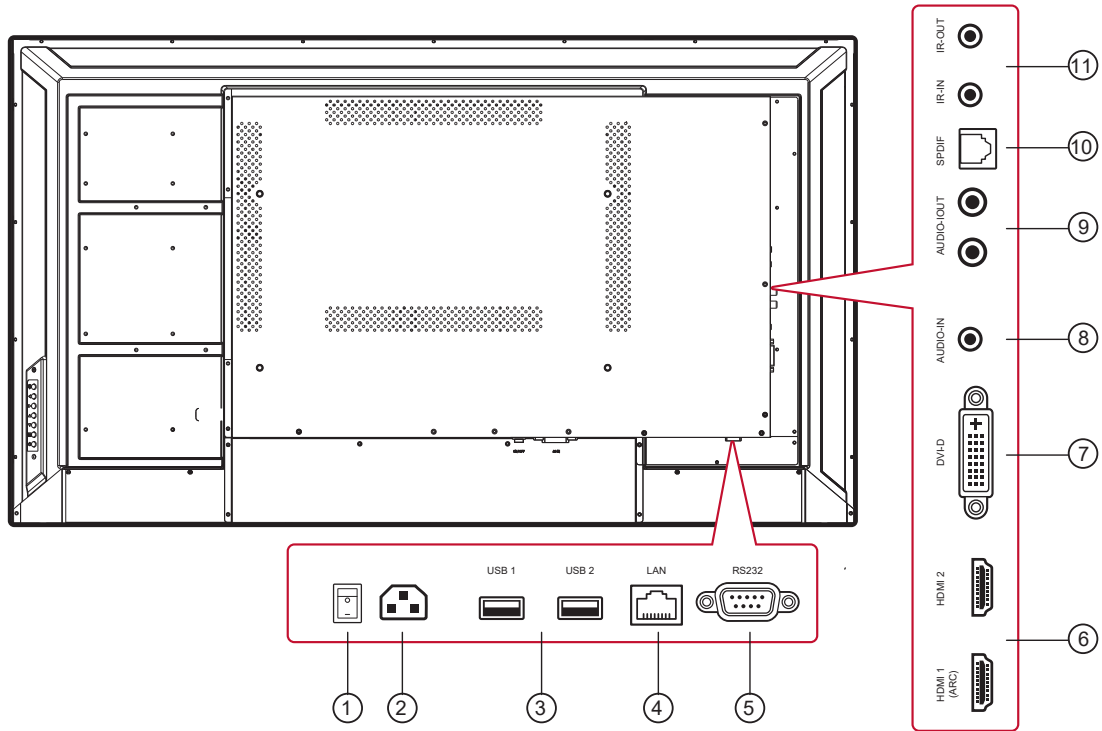

① MAIN POWER SWITCH

Switch the main power on/off.

② AC IN

AC power input from the wall outlet.

③ USB PORT

Connect your USB storage device

⑤ RS232 IN

RS232C network output / input for the loop-through function.

⑥ HDMI IN

HDMI video/audio input.

⑦ DVI-D IN

DVI-D video input.

⑧ PC LINE IN

Audio input from DVI source (3.5mm stereo phone).

⑨ AUDIO OUT

Audio output to external AV device.

⑪ IR OUT / IR IN

IR signal output /input for the loop-through function.





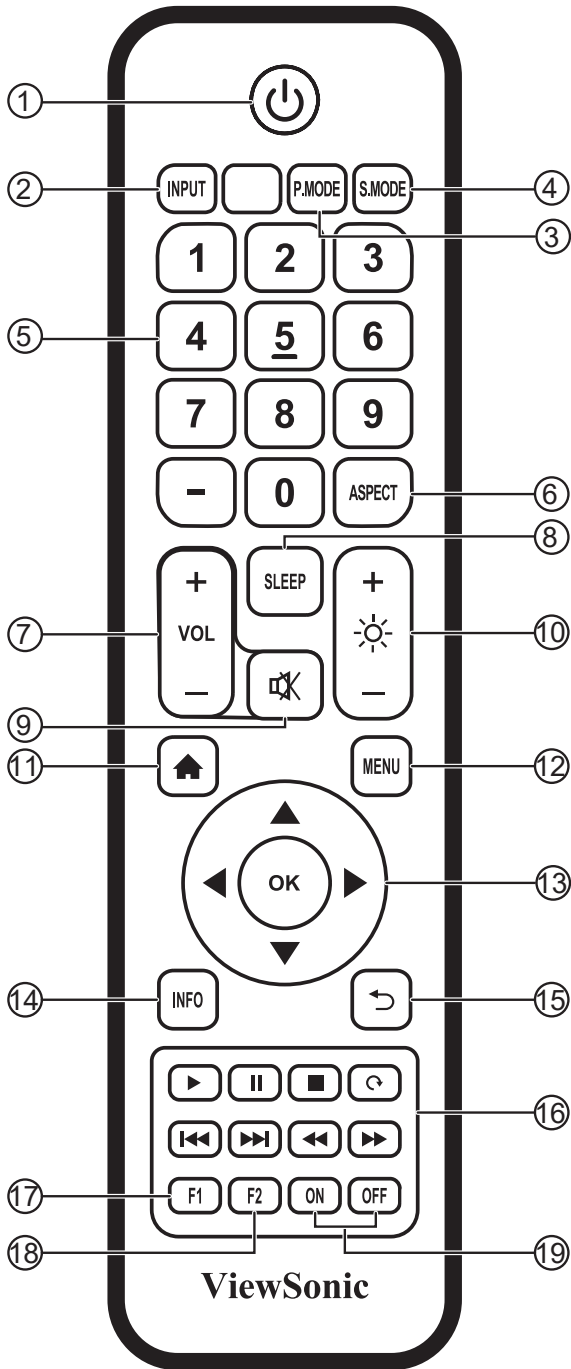

NOTES:

- This display's remote control sensor will stop working if the jack [IR IN] is connected.
- To remotely control your A/V device via this display, refer to page 14 for or IR Pass Through connection.

2.3. Remote Control

2.3.1. General functions



- ① [] button
Power on/off
- ② [INPUT] button
Input Source selection
- ③ [P.MODE] button
Image adjustment menu for HDMI/DVI
- ④ [S.MODE] button
Audio adjustment menu for HDMI/DVI
- ⑤ [NUMERIC] buttons
Numbers keypad
- ⑥ [ASPECT] button
Adjust aspect ratio for HDMI/DVI
- ⑦ [VOL +/-] button
Volume +/- 1
- ⑧ [SLEEP] button
Backlight On/Off
- ⑨ [] button
Mute
- ⑩ [] button
Backlight +/- 1
- ⑪ [] button
Back to Embedded player Home screen
- ⑫ [MENU] buttons
Setting menu
- ⑬ [] button
Up/Down/Right/Left/Ok keys
- ⑭ [INFO] button
Channel information
- ⑮ [] button
Return to previous page
- ⑯ [] button
Media control
- ⑰ [F1] button
Screen capture
The files would be saved in the embedded player under the path of System files\Screenshots\
- ⑱ [F2] button
Screen Freeze
- ⑲ [ON/OFF] button
Power on/off

2.3.2. Inserting batteries in the remote control

The remote control is powered by two 1.5V AAA batteries.

To install or replace batteries:

1. Press and then slide the cover to open it.
2. Align the batteries according to the (+) and (-) indications inside the battery compartment.
3. Replace the cover.

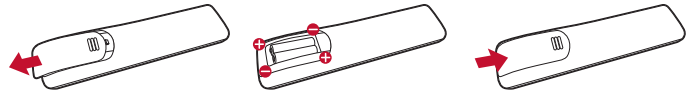

Caution:

The incorrect use of batteries can result in leaks or bursting. Be sure to follow these instructions:

- Place “AAA” batteries matching the (+) and (-) signs on each battery to the (+) and (-) signs of the battery compartment.
- Do not mix battery types.
- Do not combine new batteries with used ones. It causes shorter life or leakage of batteries.
- Remove the dead batteries immediately to prevent them from liquid leaking in the battery compartment. Don't touch exposed battery acid, as it can damage your skin.

NOTE: If you do not intend to use the remote control for a long period, remove the batteries.

2.3.3. Handling the remote control

- Do not subject to strong shock.
- Do not allow water or other liquid to splash the remote control. If the remote control gets wet, wipe it dry immediately.
- Avoid exposure to heat and steam.
- Other than to install the batteries, do not open the remote control.

2.3.4. Operating range of the remote control

Point the front of the remote control toward this display's remote control sensor when pressing a button.

Use the remote control within a distance of less than 8m/26ft from this display's sensor, and a horizontal and vertical angle of less than 30 degrees.

NOTE: The remote control may not function properly when the remote control sensor on this display is under direct sunlight or strong illumination, or when there is an obstacle in the path of signal transmission.

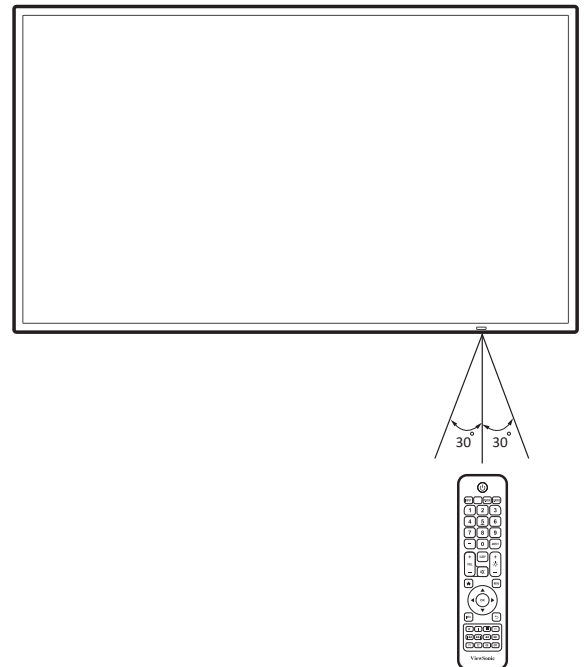

3. Connecting External Equipment

3.1. Connecting External Equipment (DVD/VCR/VCD)

3.1.1. Using HDMI video input

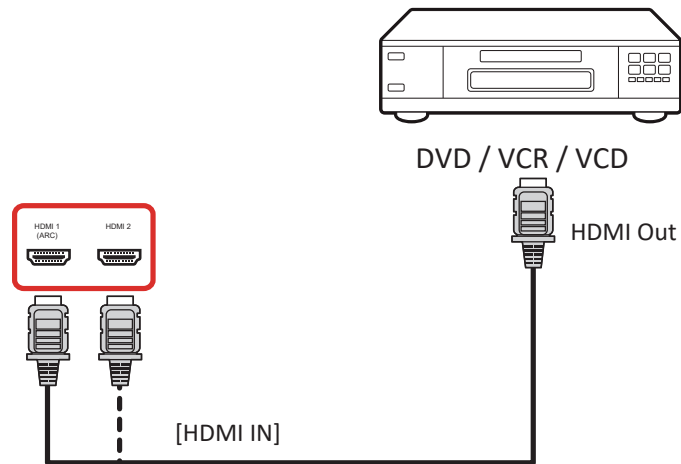

3.2. Connecting a PC

3.2.1. Using DVI input

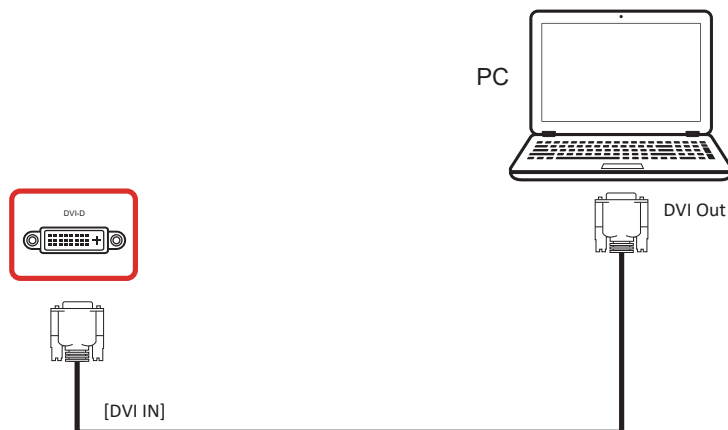

3.2.2. Using HDMI input

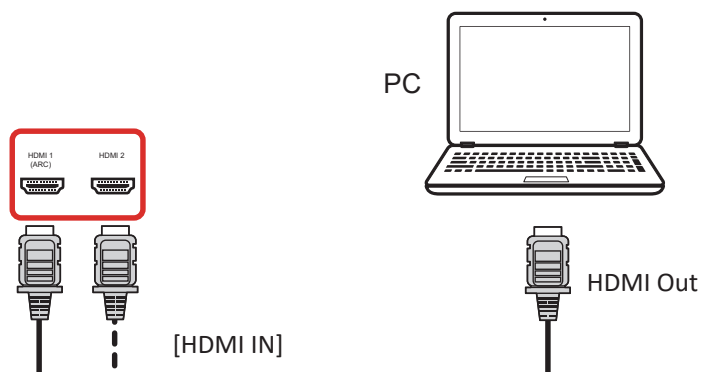

3.3. Connecting Audio Equipment

3.3.1. Connecting an external audio device

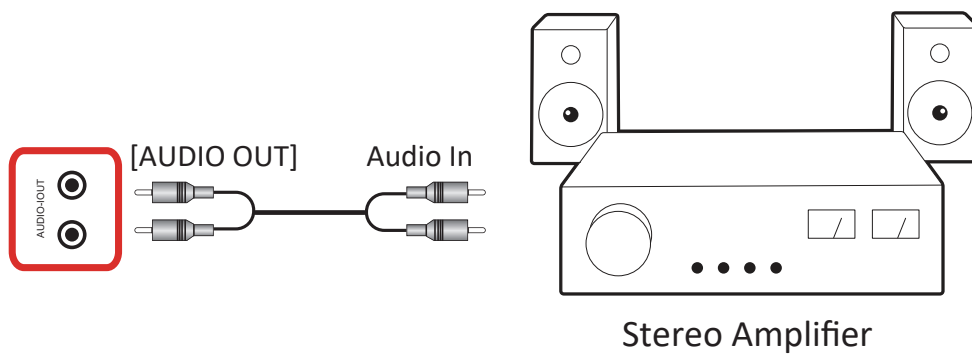

3.4. IR Pass-through Connection

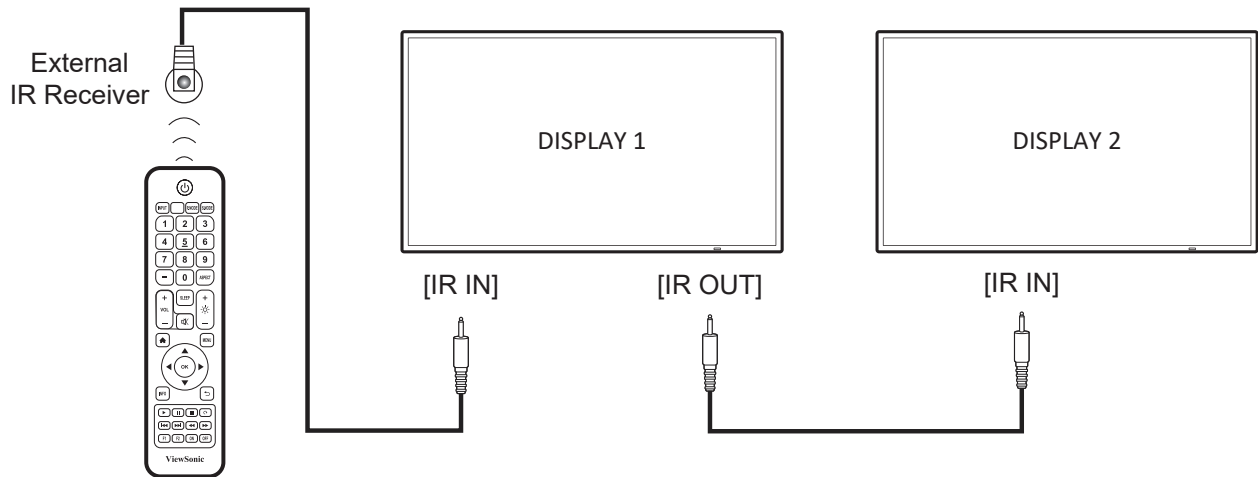

NOTE:

This display's remote control sensor will stop working if the [IR IN] is connected.

3.5. IR Pass-through Connection

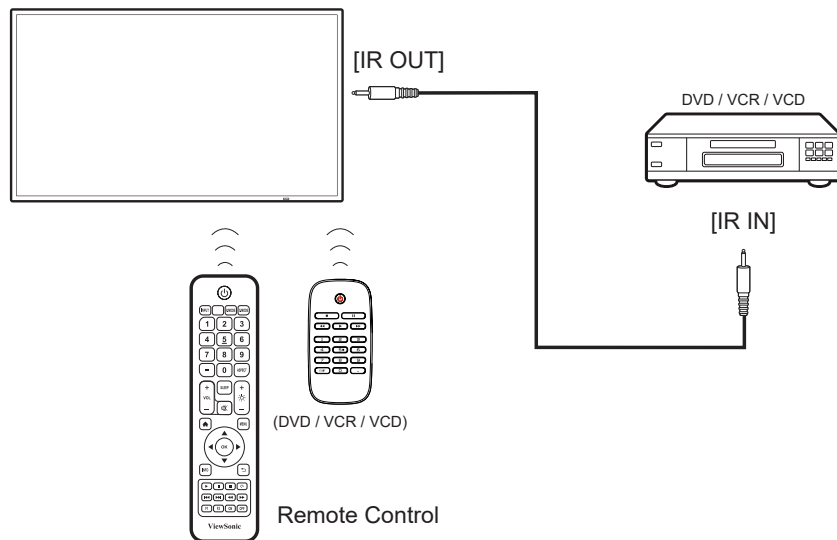

4. Operation

NOTE: The control button described in this section is mainly on the remote control unless specified otherwise.



4.1. Start-up and initial Setting

4.1.1. Welcome

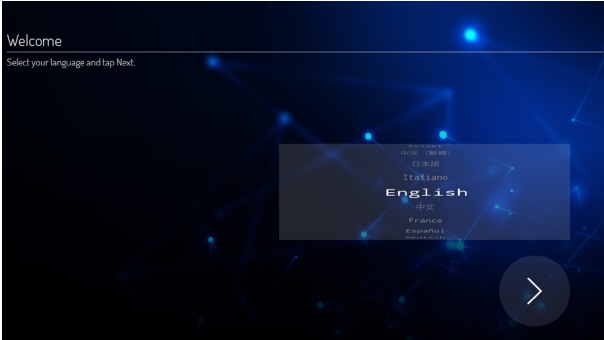
Select your language and tap “Next”.



4.2. Watch the Connected Video Source

1. Press  **INPUT** button.
2. Press  or  button to select a device, then press OK button.

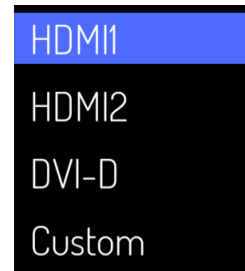

4.1.2. Ethernet

Tap “Next” button to next page and it will show.

1. Connection Type : DHCP / Static IP
2. IP Address
3. Netmask
4. DNS Address
5. Gateway

You also can tap “Back” to previous page.

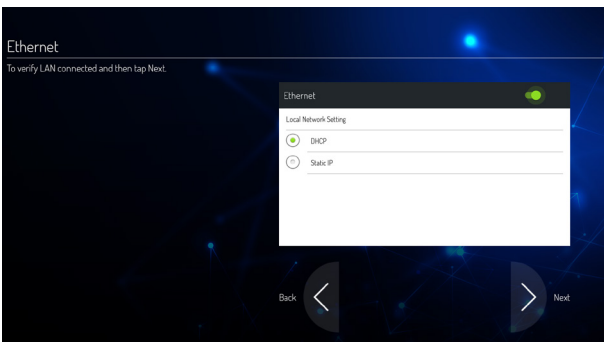

4.1.3. Date & Time

Enable “Network-provided time” to sync time with network and select time zone.

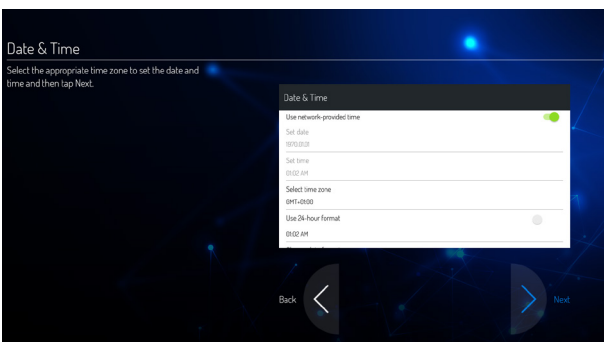

5. Launcher

Press HOME button on remote control to show the Launcher screen.

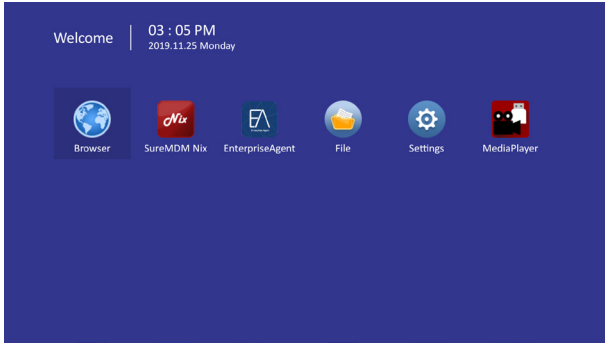

5.1. Setting

Main items:

- (1) Network
- (2) Device
- (3) System

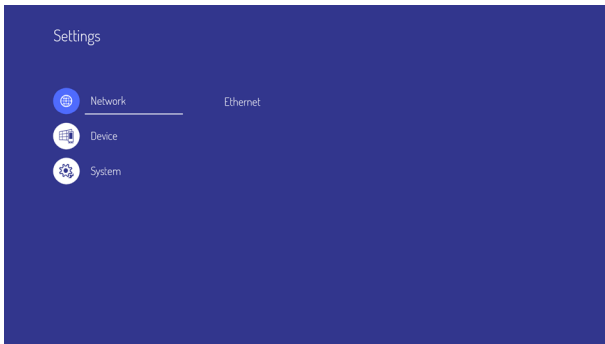

5.2. Ethernet

Enable/Disable to turn on/off Ethernet

After enable Ethernet, the settings will show:

- (1) Connection Type (Available connection type: DHCP/Static IP)
 - A. DHCP
 - B. Static IP
 - C. IP Address
 - D. Netmask
 - E. DNS Address
 - F. Gateway
- (2) Mac Address

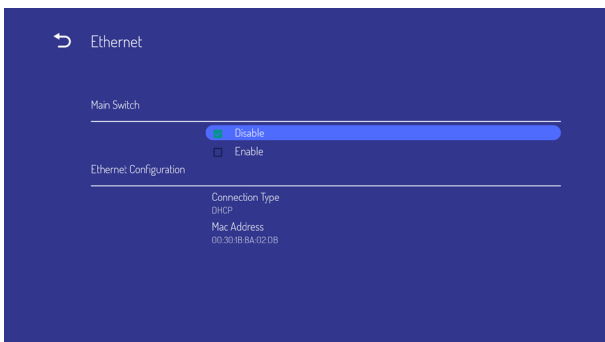

5.2.1. DHCP

DHCP mode:

- (1) Cannot modify IP Address, Netmask, DNS Address and Gateway.
- (2) If connect successfully, it will display current network configuration.

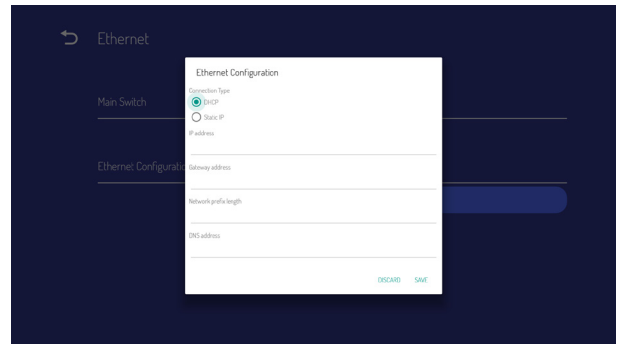

5.2.2. Static IP

In Static IP mode, user can input IP Address, Netmask, DNS address and Gateway.

Note:

IP address, netmask, DNS address and gateway address input limitation.

(1)Format:

- I. number 0-9
- II. decimal point “.”

5.3. Device

Divide into 4 groups: Signage Display/System Tools/Display/Apps

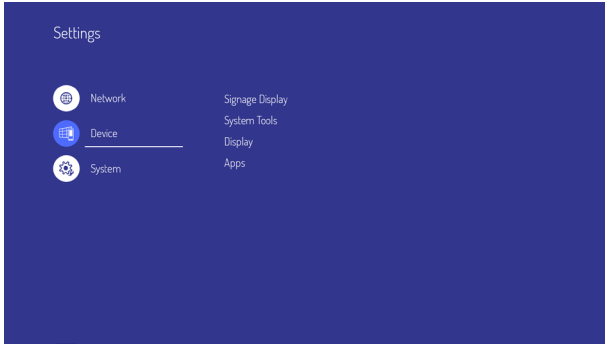

(1) Signage Display

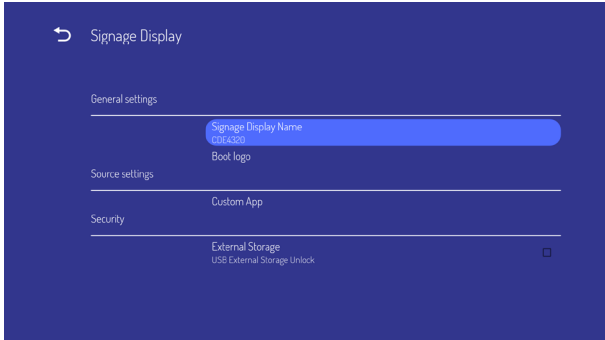

- A. General settings
- B. Source settings
- C. Security

(2) System Tools

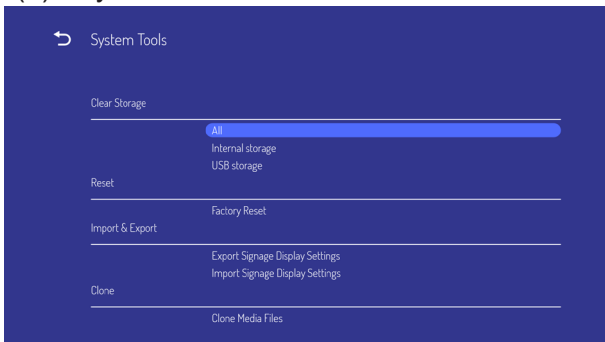

- A. Clear Storage
- B. Reset
- C. Import&Export
- D. Clone

(3) Display



- A. Backlight

(4) Apps

- A. Display applications information.

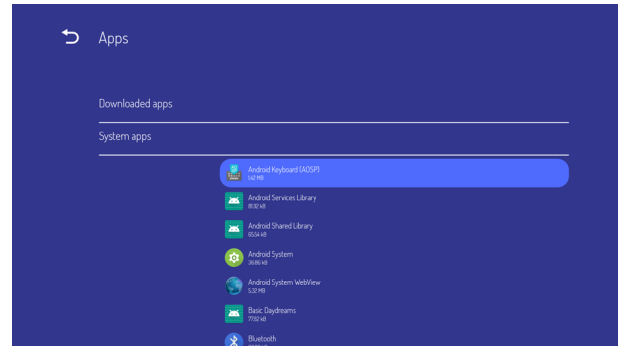

5.3.1. General Settings

- 1. Signage Display Name
- Set up Signage Display Name

Note:

Input limitation:

- (1) length: Max 36 characters
- (2) format: no limit

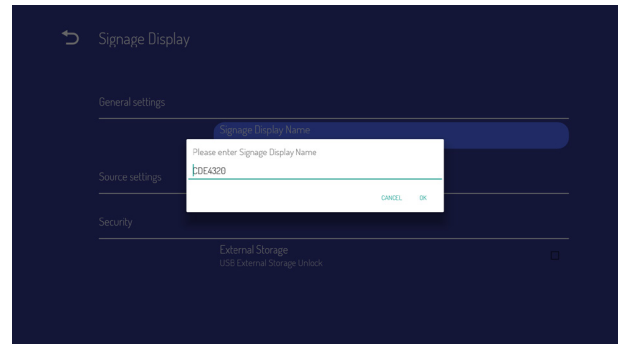

- 2. Boot Logo

1) OSD menu to control boot logo enable/disable operation

RCU: MENU -> Advanced -> Boot on logo -> On/Off/User.

In user mode, user can choose their own boot logo and animation file.

Note:

- (1) Boot logo file: Support JPG file
- (2) Boot animation file name: bootanimation.zip
- (3) Will pop-up a window for user to select file from USB. No priority issue.

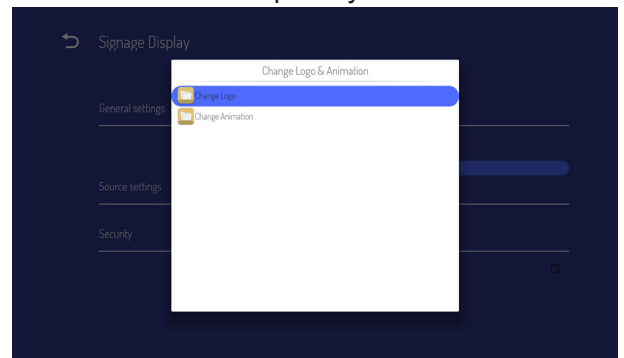

5.3.2. Source Settings

1. Custom App

User can set up the application for Customer Source. Note

- (1) Only display User Installed app.
- (2) Will not show up system pre-install app

If set up customer APK, PD will open customer app when switch source to Customer mode.

If no set up customer APK, PD will show Launcher screen when switch source to Customer mode.

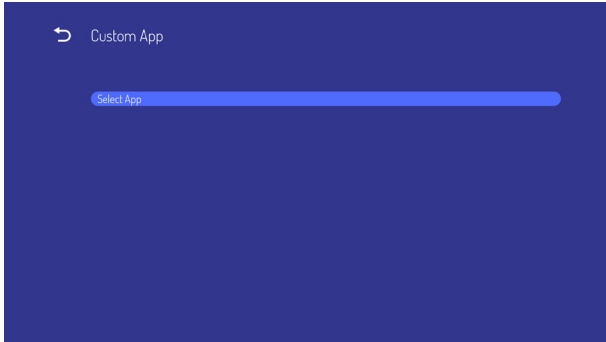

Function introduction

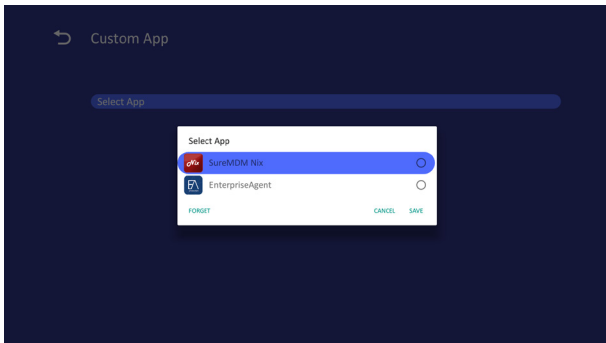

- (1) Save
Select App and press Save key to save it.
- (2) Forget
Press Forget key to clean previous stored data
- (3) Cancel
No change, close window directly
If no customer installed apk, the list will be blank.

User can select customer installed apk in list and press SAVE button to store the configuration.

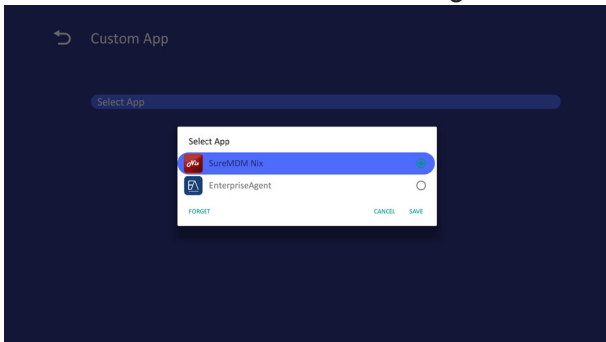

After setup, it will show App name

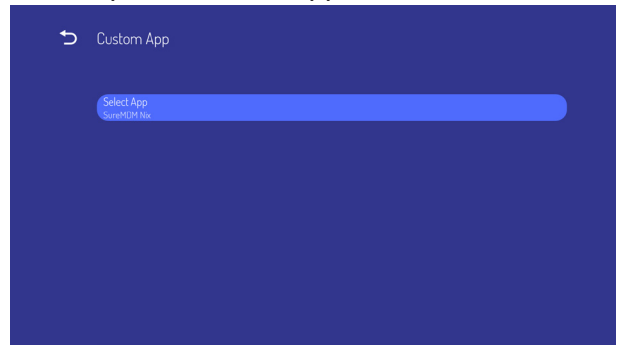

5.3.3. Security

1. External Storage

- Enable: USB External Storage Lock.
- Disable: USB External Storage Unlock.

Note:

Must re-plug USB External Storage after unlock the external storage.

5.3.4. Clear Storage

The purpose is to clear all data in viewsonic folders. Divided into 4 mode:

- (1) Clear all viewsonic folders
- (2) Only clear viewsonic folder under Internal storage.
- (3) Only clear viewsonic folder under USB storage.

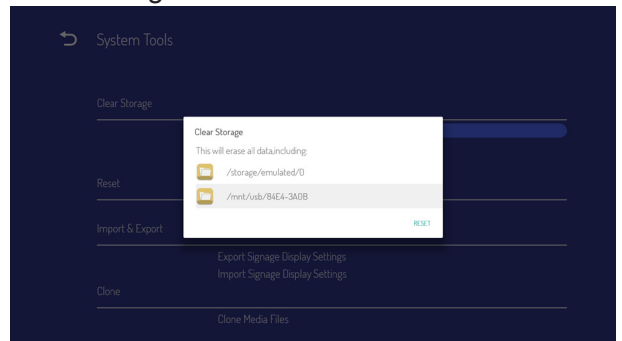

5.3.5. Reset

Factory Reset can recover to Factory default settings.

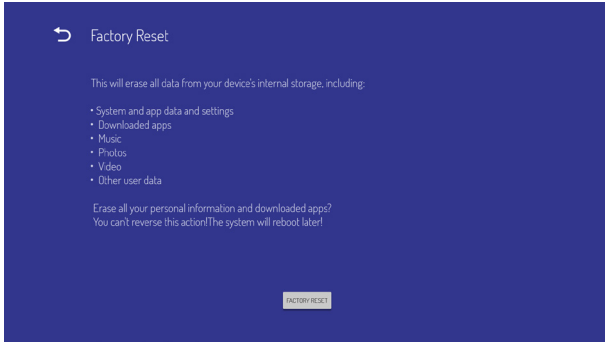

Press OK to execute Reset function automatically.

5.3.6. Import & Export

The function of Import & Export Signage Display settings.

Notes.

- (1) vs_setting.db (Saved file name: vs_setting.db)
- (2) Will save to viewsonic folder in storage

5.3.6.1 Export Signage Display Settings

Will export to viewsonic folder under USB

- (1) Export vs_setting.db. Include OSD setting, Android settings but "Signage Display Name" and "Boot Logo"
- (2) Export 3rd party apk to viewsonic/app/

Note:

If no viewsonic folder exists in USB, it will be created automatically.

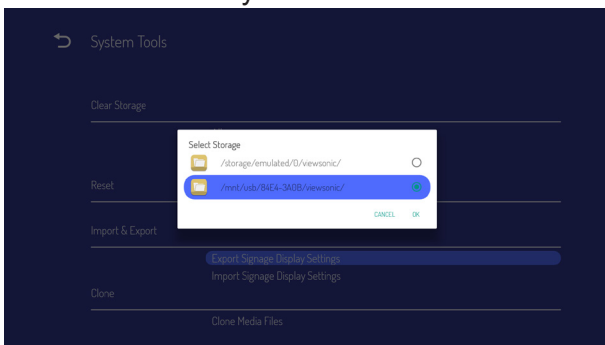

5.3.6.2 Import Signage Display Settings

Import vs_setting.db from viewsonic folder under USB.

- (1) Import vs_setting.db. Include OSD setting, Android settings but "Signage Display Name" and "Boot Logo"
- (2) Auto install 3rd party apk from viewsonic/app.

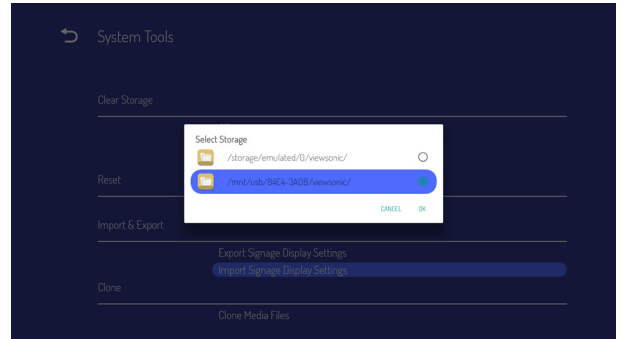

5.3.7. Clone

Clone media file from Internal viewsonic folder.

1. The cloned folder name under AutoPlayFiles folder
2. Clone Source
 - (1) Internal storage
AutoPlayFiles
 - (2) USB
Files under root
3. Target Location
 - (1) Internal storage
Save to /AutoPlayFiles/
 - (2) USB
Save to root

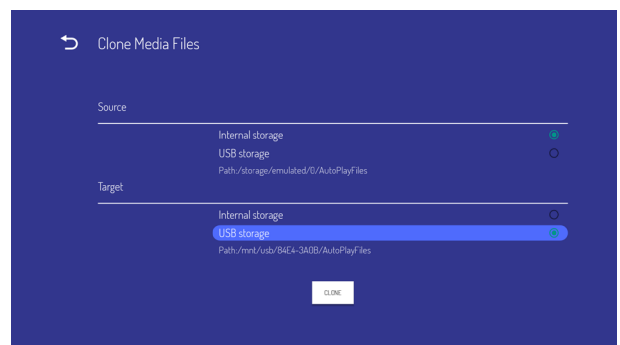

5.3.8. Backlight

User can set the panel backlight.

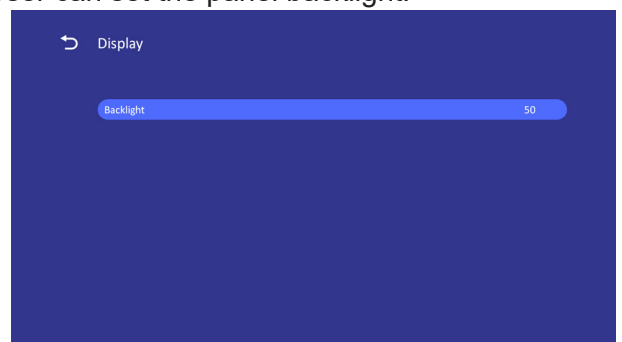

5.4. System

There are 2 item in system : Date&Time and About.

5.4.1. Date & time

To set Auto Time On/Off and time zone.

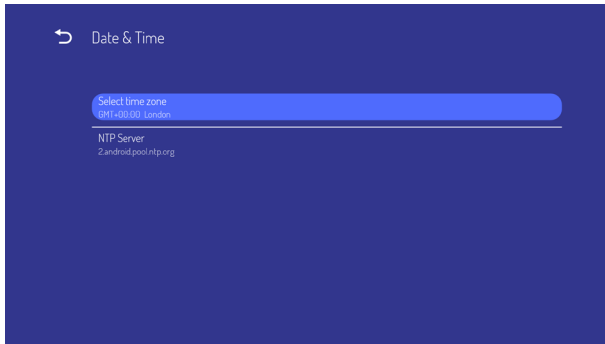

5.4.2. About

Main info in About:

- (1) Local System updates
- (2) Online System updates
- (3) Legal information
- (4) Android version
- (5) Kernel version
- (6) Build number

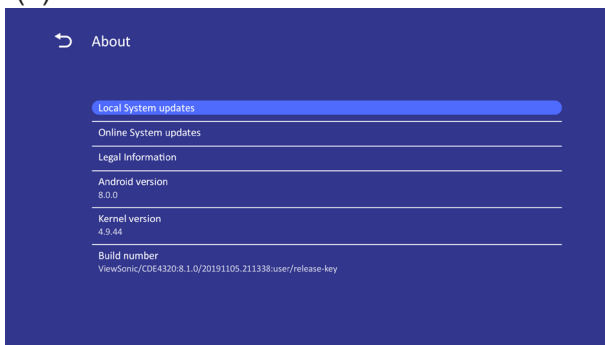

5.4.2.1 Local System updates

Will automatically search update.zip in USB. Will be shown in list for user selection if found

Note:

- (1) Only support Android Full image.
- (2) file name should be update.zip.
- (3) the file should be located in root of storage.

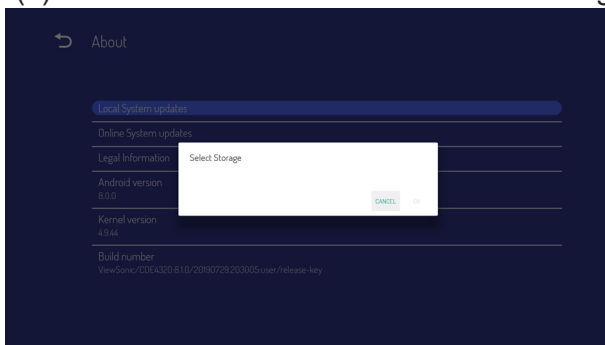

After select update.zip file, Signage Display will restart and start to update.

5.4.2.2. Online System updates

Online system update can select

- (1) Auto Update: When display power off, system will auto check the new version from OTA server. If new version found, system will auto update. After update complete, system will turn off.
- (2) Set Schedule: User can set the update time.
- (3) Manual update: User can update the OTA package manually.

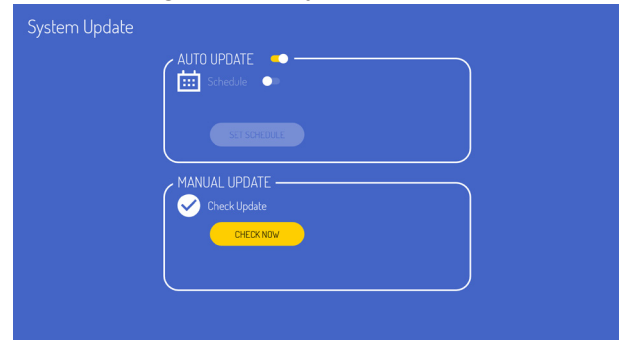

6. OSD Menu

An overall view of the On-Screen Display (OSD) structure is shown below. You can use it as a reference for further adjusting your display.

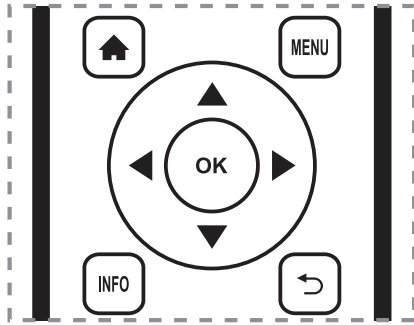

Navigating the OSD menu using the remote control:

1. Press the **MENU** button to display the OSD menu.
2. Press [**▲**] [**▼**] [**←**] or [**→**] button to select its menu item or to adjust its value. Press **OK** button to confirm.
3. Press [**↶**] button to go back to the previous menu layer.
4. Press **MENU** button to exit the OSD menu.

Navigating the OSD menu using the display's control buttons:

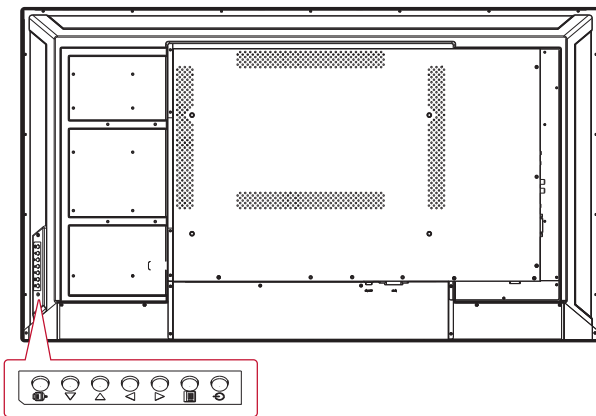

1. Press the [**Grid**] button to display the OSD menu.
2. Press the [**←/→**] or [**▲/▼**] to select menu item or adjust its value.
3. Press [**Signal Source**] button to enter the signal source selection menu, and to select the signal source. It is used to confirm the operation under the MENU operation.
4. Press [**Power**] button to On or Off the display.

6.1. Settings

6.1.1. Picture menu

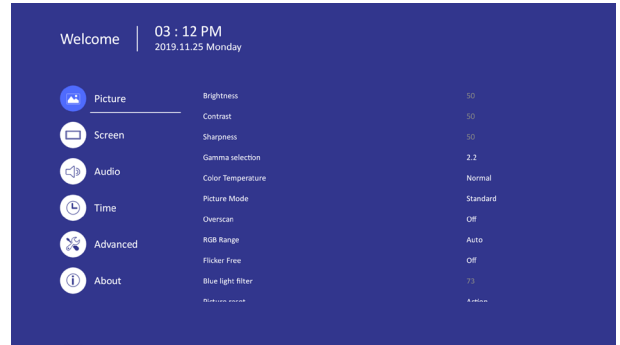

Brightness

Adjust the overall image and background screen brightness.

Contrast

Adjust the image contrast ratio for the input signal.

Sharpness

This function is digitally capable to keep crisp image at any timings.

Gamma selection

Select a display gamma. It's refer to the brightness performance curve of signal input. Choose from {2.2} / {2.3} / {2.4}.

Color temperature

It is used to adjust the color temperature.

The image becomes reddish as the color temperature decreases, and becomes bluish as the color temperature increases.

CCT	Cool	Normal	Warm
X	0.279 ± 0.005	0.283 ± 0.005	0.299 ± 0.005
Y	0.292 ± 0.005	0.298 ± 0.005	0.315 ± 0.005

Picture Mode

Select a predefined picture setting.

Overscan

Change the display area of the image. ON: Set to display area about 95%. OFF: Set to display area about 100%.

RGB Range

Select the mode to display the HDMI or DVI signal according to their signal format depending on their source device.

- {Auto} - Auto detection signal format.
- {Full Range} - displaying the signal that uses all 256 levels (from level 0 to 255).
- {Limited Range} - displaying the signal that uses 16 to 235 levels of 256 levels for each R, G, and B.

Flicker Free

Turn on/off the Flicker function.

Blue light filter

Reduce the bluelight disturbance to sight, protect sight health. You can set the level of the BlueLight Filter as your desired.

Picture reset

Reset all settings in the Picture menu.

Select “Yes” and press “SET” button to restore to factory preset data. Press [↵] button to cancel and then return to the previous menu.

6.1.2. Screen menu

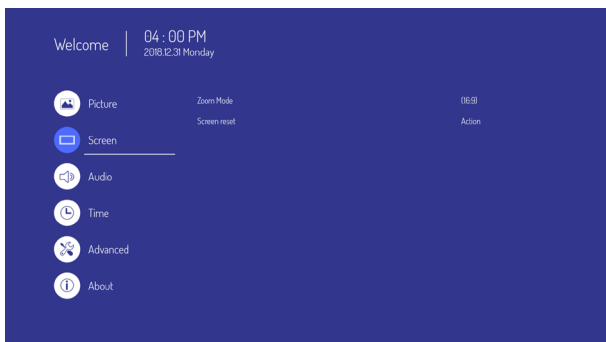

Zoom mode

HDMI, DVI: {Full} / {4:3} / {Real} / {21:9}

There are no function when in Android UI.

	Full This mode restores the correct proportions of pictures transmitted in 16:9 using the full screen display.
	4:3 The picture is reproduced in 4:3 format and a black band is displayed on either side of the picture.
	Real This mode displays the image pixel-by-pixel on screen without scaling the original image size.
	21:9 The picture is reproduced in 21:9 format and a black band at the top and bottom.

Screen reset

Reset all settings in the Screen menu to factory preset values.

6.1.3. Audio menu



Balance

Adjust to emphasize left or right audio output balance.

Treble

Adjust to increase or decrease higher-pitched sounds.

Bass

Adjust to increase or decrease lower-pitched sounds.

Volume

Adjust to increase or decrease the audio output level.

Minimum volume

Adjust your own limitation for the minimum volume setting.

Maximum volume

Adjust your own limitation for the maximum volume setting. This stops the volume from being playing at too loud a level.

Mute

Turn the mute function on/off.

Audio out volume (line out)

Adjust to increase or decrease line out output level.

Audio Out Sync

Enable/disable audio out (line out) volume adjustability to sync with internal speakers.

DVI Audio in

Select the audio input source.

Analog: audio from audio input

Digital : audio from DVI audio.

Audio reset

Reset all settings in the Audio menu to factory preset values.

6.1.4. Time

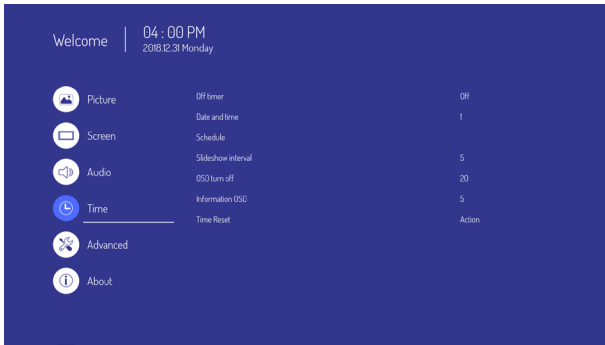

Off Timer

Set automatically power off time (in hours).

Date and time

Adjust the current date and time for the display's internal clock.

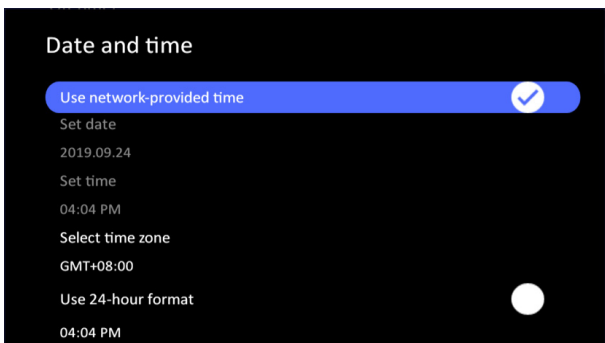

Schedule

This function allows you to program up to 7 (seven) different scheduled time intervals for the display to activate.

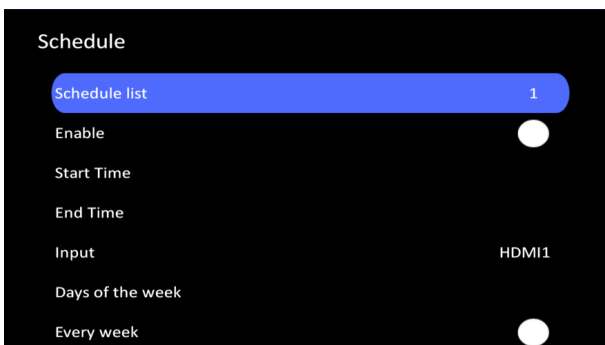

Schedule list: You can set 7 schedules.

- Enable: Enable/disable schedule. If set start/end time is conflict or empty, input is empty

or time conflict with other schedule list, you cannot enable schedule.

- Start time: Set start time.
- End time: Set end time.
- Input: Platform will go to this select source automatically after the schedule on.
- Days of the week: Set Sunday, Monday, Tuesday, Wednesday, Thursday, Friday, Saturday.
- Every week: Set lifecycle.
- Back: Does not change schedule data.
- Save: Save schedule data.

Slideshow interval

Setting the photo slideshow interval for USB auto play.

OSD turn off

Set the period of time the OSD (on-screen display) menu stays on the screen.

The options are: {Off, 5 ~ 120} seconds.

*{Off} does not disappear automatically.

Information OSD

Set the period of time the information OSD is displayed on the upper left corner of the screen.

The information OSD will display when input signal is changed.

The information OSD will remain on the screen with {Off} selection. The options are: {1 ~ 60} seconds.

Time reset

Reset all settings in Time menu to the factory preset values.

6.1.5. Advanced



Panel saving

Choose to enable the panel saving functions and thus reduce the risk of “image persistence” or “ghost-imaging”.

- {Saving} - Select {On} and the image brightness will be reduced to an appropriate level. The Brightness setting in the Picture menu will be unavailable when selected.
- {Burn-in Protection Interval} - Select the time interval ({Auto} / {10 ~ 900} Seconds/ {Off}) for the display to reduce the "image persistence".

Power Save

Mode 1 [TCP off, WOL on, auto off]

Mode 2 [TCP off, WOL on, auto on/off]

Mode 3 [TCP on, WOL off, auto on/off]

Power save modes

Mode 1: DC off -> Power off. LED: Red. Power Save -> Power off, LED: Red

Mode 2: DC off -> Power off, LED: Red. Power Save -> Power Saving. LED: Orange. Can be wake up.

Mode 3: DC off -> Back light off, LED: Red Power Save -> Back light off, LED: Orange. Can be wake up.

Eco Mode

Set this display to reduce the power consumption automatically.

Power LED light

Choose to set power indicate LED on or off.
Choose {On} for normal use

Boot on source

Choose to select source when boot up. Input: select input source when boot up.

Boot on Logo

Choose to enable or disable the picture of Logo when turn on your display.

The options are:

- {Off}
- {On} (Default)
- {User}

1. If Logo set to ON, ViewSonic logo and animation ViewSonic logo will show.
2. If Log set to OFF, neither ViewSonic logo nor animation logo will not show.
3. If Logo set to USER, custom logo option in settings is not set, then there will be no boot logo when power on.
4. If Logo set to USER, custom logo option in settings is set, there will be only custom logo when power up.

Auto signal detection

Choose to let the display detect and display available signal sources automatically.

•{Off} - Once a signal is connected, it can only be selected manually. No signal, set the display to display the image automatically according to the search order of each option.

No signal standby

Set the period of time to entry standby mode when no signal.

HDMI with One Wire

CEC control.

- {Off} - Disable CEC.(Default)
- {On} - Enable CEC.

USB Cloning

Save the OSD menu configuration into USB drive.

USB Auto Play

Set to ON, the display will copy media file from external storage to internal storage then to play the media file automatically.

Switch on state

Select the display status used for the next time you connect the power cord.

- {Power off} - The display will remain off when the power cord is connected to a wall outlet.
- {Forced on} - The display will turn on when the power cord is connected to a wall outlet.
- {Last status} - The display will return to the previous power status

WOL

Choose to turn on or off the wake on LAN function.

Choose from : {Off} / { On}

Monitor ID

Set the ID number for controlling the display via the RS232C connection. Each display must have a unique ID number when multiple sets of this display are connected. Monitor ID number range is between 1 to 98. 99 is reserve for all display.

Language

Select the language used in the OSD menu.

The options are: English/Deutsch/ 简体中文 / Français/Italiano/Español/ Русский/PolSKI/Türkçe/ 繁體中文 .

Factory reset

Reset all settings in the OSD menus of {Picture}, {Screen}, {Audio}, {Time}, and {Advanced} to the factory preset values.

Advanced option reset

Reset all settings in the Advanced menu to factory preset values.

6.1.6. About

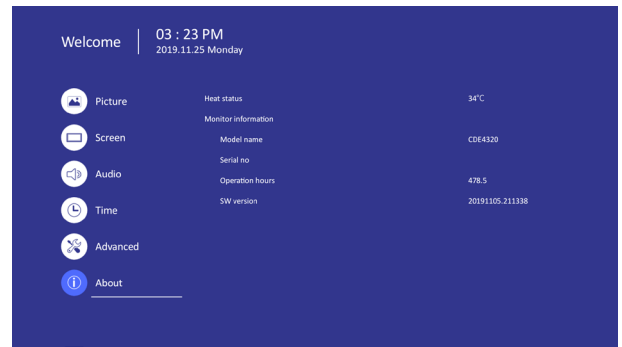

Heat status

This function allows you to check the thermal status at any time.

Monitor information

Shows information about your display, including model number, serial number, operating hours and software version.

7. Supported Media Formats

USB Multimedia Codec Formats

Type	File Type	Codec	Ability
Photo	JPEG		Photo: Base-line Resolution: 1920 x 1080 Remark: The limitation of max Resolution depends on DRAM size (up to 15360 x 8640)
			Photo: Progressive Resolution: 1024 x 768 Remark: The limitation of max Resolution depends on DRAM size (up to 7000 x 7000)
	PNG		Photo: Non-interlace Resolution: 1920 x 1080 Remark: The limitation of max Resolution depends on DRAM size (up to 15360 x 8640)
			Photo: interlace Resolution: 1920 x 1080 Remark: The limitation of max Resolution depends on DRAM size (up to 15360 x 8640)
BMP		Resolution: 15360 x 8640 Remark: The limitation of max Resolution depends on DRAM size (up to 15360 x 8640)	
Video	MKV (.mkv) WebM(.webm)	VP9	Resolution: 4096 x 2160@60fps Bit Rate: 100Mbps Profile: .Profile 0(420,8bit) Profile 2,(420,10bit)
	MP4(.mp4,.mov) 3GPP(.3gpp,3gp) MPEG transport stream(. ts,.trp,tp) MKV(.mkv)	HEVC/H.265	Resolution: 4096 x 2160@60fps Bit Rate: 100Mbps Profile: Main/Main10 Profile,HighTier @Level 5.1
	MPEG program stream(. DAT,.VOB,.MPG,.MPEG) MPEG transport stream(. ts,.trp,.tp) MP4(.mp4,.mov) 3GPP(.sgpp,.3gp) AVI(.avi) MKV(.mkv)	MPEG1/2	Resolution: 1080P@30fps Bit Rate: 30Mbps Profile: MP@HL

Video	MP4(.mp4,.mov) 3GPP(.3gpp,3gp) AVI(.avi) MKV(.mkv)	MPEG4	Resolution: 1080P@30fps Bit Rate: 40Mbps Profile: .Simple Profile .Advanced Simple Profile@Level 5 . GMC is not supported
	DivX(.divx) MP4(.mp4) AVI(.avi) MKV(.mkv)	DviX 3.11, DivX 4.12, DivX 5.x, DivX 6,XviD	Resolution: 1080P@30fps Bit Rate: 40Mbps
	FLV(.flv) MP4(.mp4,.mov) 3GPP(.3gpp) AVI(.avi) MKV(.mkv)	Sorenson H.263	Resolution: 1080P@30fps Bit Rate: 40Mbps
	FLV(.flv) MP4(.mp4,.mov) 3GPP(.3gpp) MPEG transport stream(. ts,.trp,tp) ASF(.asf) WMV(.wmv) AVI(.avi) MKV(.mkv)	H.264	Resolution: 4096 x 2160@60fps Bit Rate: 135Mbps Profile: Main and high profile up to level 5.2
	MPEG transport stream(. ts,.trp,tp)	MVC	Resolution: 1080P@60fps Bit Rate: 135Mbps
	MP4(.mp4,.mov) 3GPP(.3gpp,3gp) MPEG transport stream(. ts,.trp,tp) MKV(.mkv)	AVS	Resolution: 4096 x 2160@60fps Bit Rate: 50Mbps Profile: Jizhun profile @ Level 6.0
		AVS+	Resolution: 1080P@60fps Bit Rate: 50Mbps Profile: Broadcasting profile @Level 6.0.1.08.60
	ASF(.asf) AVI(.avi) MKV(.mkv) WMV(.wmv)	WMV3	Resolution: 1080P@30fps Bit Rate: 40Mbps
	ASF(.asf) AVI(.avi) MKV(.mkv) WMV(.wmv) MPEG transport stream(. ts,.trp,tp) MKV(.mkv)	VC1	Resolution: 2048 x 1024@30fps Bit Rate: 40Mbps Profile: Advanced profile @Level 3 . Simple profile . Main Profile
	AVI(.avi) 3GPP(.3gpp,3gp) MP4(.mp4,.mov) MKV(.mkv)	Motion JPEG	Resolution: 1280 x 720@30fps Bit Rate: 40Mbps

Video	MKV(.mkv) WebM(.webm)	VP8	Resolution: 1920 x 1080@30fps Bit Rate: 50Mbps
	RM(.rm,.rmvb) MKV(.mkv)	RV30/RV40	Resolution: 1080P@60fps Bit Rate: 40Mbps
Audio	MP3(.mp3) AVI(.avi) ASF(.asf) DivX(.divx) Matroska (.mkv,.mka) MP4(.mp4,.mov,m4a) MPEG program stream(.ts,.trp,.tp) MPEG program stream(.DAT,.VOB,.MPG,.MPEG) FLV(.flv) WAV(.wav)	MPEG1/2 Layer1	Sample rate: 16KHz ~ 48KHz Channel: Up to 2 Bit Rate: 32Kbps ~ 448Kbps
		MPEG1/2 Layer2	Sample rate: 16KHz ~ 48KHz Channel: Up to 2 Bit Rate: 8Kbps ~ 448Kbps
		MPEG1/2/2.5 Layer3	Sample rate: 8KHz ~ 48KHz Channel: Up to 2 Bit Rate: 8Kbps ~ 320Kbps
	AAC(.aac) AVI(.avi) Matroska(.mkv,mka) DivX(.divx) 3GPP(.sgpp,.3gp) MP4(.mp4,.mov,m4a) MPEG transport stream(.ts,.trp,.tp) MPEG program stream(.DAT,.VOB,.MPG,.MPEG) FLV(.flv) RM(.rm,.rmvb,.ra) WAV(.wav)	AAC,HEAAC	Sample rate: 8KHz ~ 48KHz Channel: Up to 5.1 Bit Rate: AAC-LC: 12kbps~576kbps V1: 5kbps~288kbps V2:3kbps~144kbps
	ASF(.wma,.wnv,.asf) AVI(.avi) Matroska(.mkv,.mka) WAV(.wav)	WMA	Sample rate: 8KHz ~ 48KHz Channel: Up to 2 Bit Rate: 128bps ~320Kbps Note: WMA7, WMA8, WMA9 Standard
		WMA 10 Pro M0	Sample rate: 8KHz ~ 48KHz Channel: Up to 2 Bit Rate: < 192kbps
		WMA 10 Pro M1	Sample rate: 8KHz ~ 48KHz Channel: Up to 5.1 Bit Rate: < 384kbps
WMA 10 Pro M2		Sample rate: 8KHz ~ 96KHz Channel: Up to 5.1 Bit Rate: < 768kbps	
Matroska(.mkv,.mka) WebM(.webm) 3GPP(.3gpp) MP4(.mp4,.mov,m4a)	VORBIS	Sample rate: Up to 48KHz Channel: Up to 2 Note: Supports stereo decoding only	

Audio	WAV(.wav) AVI(.avi) Matroska(.mkv,.mka) 3GPP(.3gpp,.3gp) MP4(.mp4,.mov,m4a) MPEG transport stream(.ts,.trp,.tp) MPEG program stream(.DAT,.VOB,.MPG,.MPEG)	LPCM	Sample rate: 8KHz ~ 48KHz Channel: Mono, Stereo, 5.1 Bit Rate: 64Kbps ~ 1.5Mbps
	WAV(.wav) AVI(.avi) Matroska(.mkv,.mka) 3GPP(.3gpp,.3gp) MP4(.mp4,.mov,m4a)	IMA-ADPCM MS0ADPCM	Sample rate: 8KHz ~ 48KHz Channel: Up to 2 Bit Rate: 32Kbps ~ 384Kbps
		G711 A/mu-law	Sample rate: 8KHz Channel: 1 Bit Rate: 64Kbps
	Matroska(.mkv,.mka) RM(.rm,.rmvb,.ra)	LBR(cook)	Sample rate: 8KHz, 11.025KHz, 22.05KHz, 44.1KHz Channel: Up to 5.1 Bit Rate: 6Kbps ~ 128Kbps
	Matroska(.mkv,.mka)	FLAC	Sample rate: 8KHz ~ 96KHz Channel: Up to 7.1 Bit Rate: < 1.6Mbps
	MPEG transport stream(.ts,.trp,.tp)	DRA	Sample rate: 8KHz ~ 96KHz Channel: Up to 7.1 Bit Rate: < 6Mbps
	Matroska(.mkv,.mka)	OPUS	Sample rate: 8KHz ~ 48KHz Channel: Up to 6 Bit Rate: 6Kbps ~ 510Kbps

- 1) Resolution is a kind of reference design, instead of hardware limitation. Because it is bounded by DRAM size and performance
- 2) The larger resolution, the bigger DRAM size
- 3) The larger resolution, the less performance, since it requires longer time to show a picture
- 4) Whether to adopt JPEG/PNG hardware decoder can be set. The max resolution of Jpeg Hardware decoder is 16360 x 16360
- 5) BMP decoder is a software decoder. The limitation of max resolution depends on DRAM size

8. Input mode

Graphic Resolution:

Standard Resolution	Active Resolution		Refresh Rate (V Frequency/Hz)	H Frequency (KHz)	Pixel Rate (MHz)	Stand for Mode
	H Pixels	V Lines				
DVI	640	480	59.941	31.469	25.175	VESA
			67.670	35.000	30.240	MAC
			72.810	37.861	31.500	VESA
			75.000	37.500	31.500	VESA
	720	400	70.080	31.467	28.320	IBM
			85.038	37.927	35.500	VESA
	800	600	56.250	35.156	36.000	VESA
			60.317	37.879	40.000	VESA
			72.188	48.077	50.000	VESA
			75.000	46.875	49.500	VESA
	832	624	74.550	49.725	57.283	VESA
			74.550	49.722	57.284	MAC
	1024	768	60.004	48.363	65.000	VESA
			70.069	56.476	75.000	VESA
			74.930	80.000	60.241	MAC
			75.029	60.023	78.750	VESA
	1152	864	60.053	54.348	80.000	VESA
			70.016	63.995	94.201	VESA
			75.000	67.500	108.000	VESA
	1152	870	75.060	68.681	100.000	MAC
			75.061	68.681	100.000	VESA
	1280	720	59.860	44.772	74.500	CVT
	1280	960	60.000	60.000	108.000	VESA
	1280	1024	60.002	63.981	108.000	VESA
			60.013	63.974	108.500	VESA
			75.024	79.976	134.999	VESA
	1366	768	59.790	47.712	85.500	CVT
	1360	768	60.015	47.712	85.500	VESE
			84.880	68.688	125.250	CVT
	1440	900	59.887	55.935	106.500	VESA
			59.901	55.469	88.750	VESA
	1680	1050	59.954	65.290	146.250	VESA

DVI	1600	1200	60.000	75.000	162.000	VESA
			70.000	87.500	189.000	VESA
			75.000	93.750	202.500	VESA
	1920	1080	60.000	67.500	148.500	VESA
	1920	1200	59.950	74.038	154.000	VESA
	3840	2160	23.976	53.946	296.703	VESA
			24.000	54.000	297.000	VESA
			25.000	56.250	297.000	VESA
			29.970	67.430	296.703	VESA
			30.000	297.000	67.500	VESA

HD Resolution:

Standard Resolution	Video	Active Resolution		Refresh Rate (V Frequency/ Hz)	H Frequency (KHz)	Pixel Rate (MHz)	Stand for Mode
		H Pixels	V Lines				
HDMI	480i	720	480	59.939	15.734	13.500	EIA-861D
				60.000	15.750	13.513	EIA-861D
		1440	480	59.939	15.734	27.000	EIA-861D
				60.000	15.750	27.027	EIA-861D
	576i	720	576	50.000	15.625	13.500	EIA-861D
				1440	576	50.000	15.625
	480p	720	480	59.941	31.469	27.000	EIA-861D
				60.000	31.500	27.027	EIA-861D
	576p	720	576	50.000	31.250	27.000	EIA-861D
				1440	576	50.000	31.250
	720p	1280	720	59.940	44.955	74.176	EIA-861D
				60.000	45.000	74.250	EIA-861D
	1080i	1920	1080	50.000	28.125	74.250	EIA-861D
				59.940	33.716	74.175	EIA-861D
				60.000	33.750	74.250	EIA-861D
	1080p	1920	1080	23.976	26.973	74.175	EIA-861D
				24.000	27.000	74.250	EIA-861D
				25.000	28.125	74.250	EIA-861D
				29.970	33.716	74.176	EIA-861D
				30.000	33.750	74.250	EIA-861D
50.000				56.250	148.500	EIA-861D	
59.940				67.432	148.350	EIA-861D	
60.000				67.500	148.500	EIA-861D	

HDMI	4K	3840	2160	23.976	53.946	296.703	
		3840	2160	24.000	54.000	297.000	
		3840	2160	25.000	56.250	297.000	
		3840	2160	29.970	67.430	296.703	
		3840	2160	30.000	67.500	297.000	
		3840	2160	50.000	112.500	594.000	
		3840	2160	60.000	135.000	594.000	

- The PC text quality is optimum in HD 1080 mode (1920 x 1080, 60Hz).
- Your PC display screen might appear different depending on the manufacturer (and your particular version of Windows).
- Check your PC instruction book for information about connecting your PC to a display.
- If a vertical and horizontal frequency-select mode exists, select 60Hz (vertical) and 31.5KHz (horizontal). In some cases, abnormal signals (such as stripes) might appear on the screen when the PC power is turned off (or if the PC is disconnected). If so, press the [INPUT] button to enter the video mode. Also, make sure that the PC is connected.
- When horizontal synchronous signals seem irregular in RGB mode, check PC power saving mode or cable connections.
- The display settings table complies to the IBM/VESA standards, and based on the analog input.
- The DVI support mode is regarded as same to the PC support mode.
- The best timing for the vertical frequency to each mode is 60Hz.

9. Cleaning and Troubleshooting

9.1. Cleaning

When Using the Display

- Do not bring your hands, face or objects close to the ventilation holes of the display. The top of the display is usually very hot due to the high temperature of exhaust air being released through the ventilation holes. Burns or personal injuries may occur if any body parts are brought too close. Placing any object near the top of the display could also result in heat related damage to the object as well as the display itself.
- Be sure to disconnect all cables before moving the display. Moving the display with its cables attached may damage the cables and thus cause fire or electric shock.
- Disconnect the power plug from the wall outlet as a safety precaution before carrying out any type of cleaning or maintenance procedure.

Front Panel Cleaning Instructions

- The front of the display has been specially treated. Wipe the surface gently using only a cleaning cloth or a soft, lint-free cloth.
- If the surface becomes dirty, soak a soft, lint-free cloth in a mild detergent solution. Wring the cloth to remove excess liquid. Wipe the surface of the display to remove dirt. Then use a dry cloth of the same type to dry.
- Do not scratch or hit the surface of the panel with fingers or hard objects of any kind.
- Do not use volatile substances such as insert sprays, solvents and thinners.

Cabinet Cleaning Instructions

- If the cabinet becomes dirty, wipe the cabinet with a soft, dry cloth.
- If the cabinet is extremely dirty, soak a lint-free cloth in a mild detergent solution. Wring the cloth to remove as much moisture as possible. Wipe the cabinet. Use another dry cloth to wipe over until the surface is dry.
- Do not allow any water or detergent to come into contact with the surface of the display. If water or moisture gets inside the unit, operating problems, electrical and shock hazards may result.
- Do not scratch or hit the cabinet with fingers or hard objects of any kind.
- Do not use volatile substances such as insert sprays, solvents and thinners on the cabinet.
- Do not place anything made from rubber or PVC near the cabinet for any extended periods of time.

9.2. Troubleshooting

Problems	Possible causes	Solutions
The Power indicator does not come on	A. the monitor is not powered on	A. Check if the power cord is connected, and switch ON the monitor.
The Power indicator is on, but no image is displayed	A. The Video wire is detached or connected improperly B. No video signal input	A. Connect or replace the video wire, and ensure proper and correct connection; B. Check the signal source, and check if it is properly connected at the output end.
Image jerking or ripple	A. There exists an electric device that interferes with the video signals;	A. Turn off the electric device, or relocate the monitor.
Dim or extremely bright screen	5. A. Low or high brightness/contrast	6. A. Check the brightness/contrast settings, or restore to default settings.
Color difference	A. Improper chromatic saturation; B. Improper RGB values or color temperature	A. Check the chromatic saturation; B. Adjust the RGB values or reset the color temperature; C. Restore to default settings.
Image distortion	A. Improper aspect ratio;	A. Reset the aspect ratio.
No sound	A. the Audio wire is detached or connected improperly; B. It is mute	A. Ensure proper connection at the input end; B. Reset the volume.

10. Technical Specifications

Display:

Item	Specifications
Screen Size (Active Area)	109 cm / 43 inch
Aspect Ratio	16:9
Number of Pixels	3840 (H) x 2160 (V)
Pixel Pitch	0.492 (H) x 0.492 (V) [mm]
Displayable Colors	10bit, 1.07 Billion colors
Brightness	350 cd/m ²
Contrast Ratio (Typical)	1100:1
Viewing Angle	178 degrees

In/Out Terminals:

Item	Specifications
Speaker Output	Internal Speakers 10W (L) + 10W (R) [RMS]/8Ω 1 Way 1 Speaker System 82 dB/W/M/160 Hz ~ 13 KHz
Audio Output	RCA R/L x 1 0.5V [rms] (Normal) / 2 Channel (L+R)
Audio Input	3.5mm phone jack x 1 0.5V [rms] (Normal) / 2 Channel (L+R)
RS232C	D-Sub Jack x 1 (9 pin) TXD + RXD (1:1)
RJ-45	RJ-45 Jack x 1 (8 pin) 10/100 LAN Port
HDMI Input	HDMI Jack x 2 (Type A) (19 pin) Digital RGB: TMDS (Video + Audio) MAX: Video: 720p, 1080p, 4K @ 60Hz Audio: 48 KHz / 2 Channel (L+R) Supports LPCM only
DVI-D Input	DVI-D Jack x 1 Digital RGB:TMDS (Video)
IR Input/Output	3.5mm x 2 IR pass through or IR daisy chain
USB Input	USB x 2 (Type A) USB 2.0, Multimedia play and service port

General:

Item	Specifications
Power Input	100 - 240V~, 50/60Hz, 1.5A
Power Consumption (Max)	85 W
Power Consumption (typ.)	70 W
Power Consumption (Standby & Off)	<0.5 W (RS232 in active)
Dimensions (Without Stand) [W x H x D]	969.9 x 558.3 x 84.6 mm
Weight (Without Stand)	10.5 Kg
Gross Weight (Without Stand)	15.4 Kg

Environmental Condition:

Item	Specifications	
Temperature	Operational	0 ~ 40°C
	Storage	-10 ~ 60°C
Humidity	Operational	20 ~ 80% RH (No condensation)
	Storage	10 ~ 80% RH (No condensation)
Altitude	Operational	0 ~ 5,000 m
	Storage	0 ~ 9,000 m

Internal Speaker:

Item	Specifications
Type	1 Way 1 Speaker
Input	10 W (RMS)
Impedance	8Ω
Output Sound Pressure	82 dB/W/M
Frequency Response	160 Hz ~ 13 KHz

11. RS232 Protocol

11.1. Introduction

This document describes the hardware interface spec and software protocols of RS232 interface communication between ViewSonic Commercial TV / Digital Signage and PC or other control unit with RS232 protocol.

The protocol contains three sections command:

- Set-Function
- Get-Function
- Remote control pass-through mode

* In the document below, "PC" represents all the control units that can send or receive the RS232 protocol command.

11.2. Description

11.2.1. Hardware specification

Viewsonic TV communication port on the rear side:

- (1) Connector type: DSUB 9-Pin Male
- (2) Pin Assignment

Male DSUB 9-Pin
(outside view)



Pin #	Signal	Remark
1	NC	
2	RXD	Input to Commercial TV or DS
3	TXD	Output from Commercial TV or DS
4	NC	
5	GND	
6	NC	
7	NC	
8	NC	
9	NC	
frame	GND	

* Use of crossover (null modem) cable required for use with PC

[Special case] 2.5mm barrel connector

Pin #	Signal	Remark
Tip	TXD	Output from Commercial TV or DS
Ring	RXD	Input to Commercial TV or DS
Sleeve	GND	

11.2.2. Communication Setting

- Baud Rate Select: 9600bps (fixed)
- Data bits: 8 bits (fixed)
- Parity: None (fixed)
- Stop Bits: 1 (fixed)

11.2.3. Command Message Reference

PC sends to Monitor command packet followed by "CR". Every time PC sends control command to the Monitor, the Monitor shall respond as follows:

1. If the message is received correctly it will send "+" (02Bh) followed by "CR" (00Dh)
2. If the message is received incorrectly it will send "-" (02Dh) followed by "CR" (00Dh)

11.3. Protocol

11.3.1. Set-Function Listing

The PC can control the TV/DS for specific actions. The Set-Function command allows you to control the TV/DS behavior in a remote site through the RS232 port. The Set-Function packet format consists of 9 bytes.

Set-Function description:

Length:	Total Byte of Message excluding "CR".
TV/DS ID	Identification for each of TV/DS (01~98; default is 01) If we want to set all TV/DS settings, use the TV/DS ID "99", and it will not have Reply command on this function. The TV/DS ID can be set via the OSD menu for each TV/DS set.
Command Type	Identify command type, "s" (0x73h) : Set Command "+" (0x2Bh) : Valid command Reply "- " (0x2Dh) : Invalid command Reply
Command:	Function command code: One byte ASCII code.
Value[1~3]:	Three bytes ASCII that defines the value.
CR	0x0D

Set-Function format

Send: (Command Type="s")

Name	Length	ID	Command Type	Command	Value1	Value2	Value3	CR
Byte Count	1 Byte	2 Byte	1 Byte	1 Byte	1 Byte	1 Byte	1 Byte	1 Byte
Bytes order	1	2~3	4	5	6	7	8	9

NOTE: For VT2405LED-1 and VT3205LED, the set "Power on" command is the exception

Reply: (Command Type="+" or "-")

Name	Length	ID	Command Type	CR
Byte Count	1 Byte	2 Byte	1 Byte	1 Byte
Bytes order	1	2~3	4	5

NOTE:

- The reply for "Power on" command is the exception for VT2405LED-1 and VT3205LED. It's 0x322B0D (2+<CR>).
- When PC applies command to all displays (ID=99), only the #1 set needs to reply by the name of ID=1.

Example1: Set Brightness as 76 for TV-02 and this command is valid

Send (Hex Format)

Name	Length	ID	Command Type	Command	Value1	Value2	Value3	CR
Hex	<u>0x38</u>	<u>0x30</u> <u>0x32</u>	<u>0x73</u>	<u>0x24</u>	<u>0x30</u>	<u>0x37</u>	<u>0x36</u>	<u>0x0D</u>

Reply (Hex Format)

Name	Length	ID	Command Type	CR
Hex	<u>0x34</u>	<u>0x30</u> <u>0x32</u>	<u>0x2B</u>	<u>0x0D</u>

Example2: Set Brightness as 176 for TV-02 and this command is NOT valid Send (Hex Format)

Name	Length	ID	Command Type	Command	Value1	Value2	Value3	CR
Hex	0x38	0x30 0x32	0x73	0x24	0x31	0x37	0x36	0x0D

Reply (Hex Format)

Name	Length	ID	Command Type	CR
Hex	0x34	0x30 0x32	0x2D	0x0D

Set function table:

Basic function

Set Function	Length	ID	Command Type (ASCII)	Command		Value Range (Three ASCII bytes)	Comments
				Code (ASCII)	Code (Hex)		
Power on ^{*3.2.1} /off(standby)	8		s	!	21	000: STBY 001: ON	1. The Power-on via LAN control may works only under specific mode. To see display UG for details. ^{*3.1.1} 2. "WOL by MAC address" may available as alternative. ^{*3.2.1}
Input Select	8		s	"	22	000: TV 001: AV 002: S-Video 003: YPbPr 004: HDMI1 014: HDMI2 024: HDMI3 034: HDMI4 005: DVI 006: VGA1 016: VGA2 026: VGA3 007: Slot-in PC (OPS/SDM)/HDBT 008: Internal memory 009: DP/Type-C 00A: Embedded/Main (Android)	1. No need for USB 2. For the case of two more same sources, the 2 nd digital is used to indicate the extension. 3. The HEX of 00A is 30 30 41.

Brightness	8		s	\$	24	000 ~ 100 900:Bright down (-1) 901: Bright up (+1) *3.1.1	
Backlight ^{*3.2.0}	8		A	B	42	000 ~ 100	1. For Android platform whose main mode is controlled by backlight and the other sources are controlled by brightness. 2. Derived from Color calibration. *3.2.0
Power lock	8		s	4	34	000: Unlock 001: Lock	*See note in details
Volume	8		s	5	35	000 ~ 100 900: Volume down(-1) 901:Volume up(+1)	
Mute	8		s	6	36	000: OFF 001: ON (mute)	
Button lock	8		s	8	38	000: Unlock 001: Lock	*See note in details
Menu lock	8		s	>	3E	000: Unlock 001: Lock	*See note in details
Number ^{*3.1.1}	8		s	@	40	000~009	
Key Pad ^{*3.1.1}	8		s	A	41	000: UP 001: DOWN 002: LEFT 003: RIGHT 004: ENTER 005: INPUT 006: MENU/(EXIT) 007: EXIT	
Remote Control	8		s	B	42	000: Disable 001: Enable 002: Pass through	Disable: RCU will be no function Enabled: RCU controls normally Pass through: Display will bypass the RC code to connected device via the RS232 port, but not react itself.
Restore default	8		s	~	7E	000	Recover to factory setting

Optional function

Set Function	Length	ID	Command	Command		Value Range (Three ASCII bytes)	Comments
				Type (ASCII)	Code (ASCII)		
Contrast	8		s	#	23	000 ~ 100	
Sharpness	8		s	%	25	000 ~ 100	
Color	8		s	&	26	000 ~ 100	
Tint	8		s	'	27	000 ~ 100	
Backlight On_Off ^{*3.2.3}	8		s	(28	000: Off 001: On	
Color mode	8		s)	29	000: Normal 001: Warm 002: Cold 003: Personal	
Surround sound	8		s	-	2D	000: Off 001: On	
Bass	8		s	.	2E	000 ~ 100	
Treble	8		s	/	2F	000 ~ 100	
Balance	8		s	0	30	000 ~ 100	050 is central
Picture Size	8		s	1	31	000: FULL (16:9) 001: NORMAL (4:3) 002: REAL (1:1) ^{*3.1.0}	
OSD lan- guage	8		s	2	32	000: English 001: French 002: Spanish	Could be extended for more supported languag- es by model
Date: Year	8		s	V	56	Y17~Y99	Last 2 digits (20)17~(20)99
Date: Month	8		s	V	56	M01~M12	2 digits
Date: Day	8		s	V	56	D01~D31	2 digits
Time: Hour	8		s	W	57	H00~H23	24-hr format. 2 digits.
Time: Min	8		s	W	57	M00~M59	2 digits
Time: Sec	8		s	W	57	S00~S59	2 digits

11.3.2. Get-Function Listing

The PC can interrogate the TV/DS for specific information. The Get-Function packet format consists of 9 bytes which is similar to the Set-Function packet structure. Note that the "Value" byte is always = 000

Get-Function description:

- Length:** Total Byte of Message excluding "CR".
- TV/DS ID** Identification for each of TV/DS (01~98; default is 01).
- Command Type** Identify command type,
 "g" (0x67h) : Get Command
 "r" (0x72h) : Valid command Reply
 "-" (0x2Dh) : Invalid command Reply
- Command:** Function command code: One byte ASCII code.
- Value[1~3]:** Three bytes ASCII that defines the value.
- CR** 0x0D

Get-Function format

Send: (Command Type="g")

Name	Length	ID	Command Type	Command	Value1	Value2	Value3	CR
Byte Count	1 Byte	2 Byte	1 Byte	1 Byte	1 Byte	1 Byte	1 Byte	1 Byte
Bytes order	1	2~3	4	5	6	7	8	9

NOTE: "Power STBY status" is the exception for VT2405LED-1 and VT3205LED.

Reply: (Command Type="r" or "-")

If the Command is valid, Command Type = "r"

Name	Length	ID	Command Type	Command	Value1	Value2	Value3	CR
Byte Count	1 Byte	2 Byte	1 Byte	1 Byte	1 Byte	1 Byte	1 Byte	1 Byte
Bytes order	1	2~3	4	5	6	7	8	9

NOTE: The reply for "Power STBY status" command is the exception for VT2405LED-1 and V3205LED. It's 0x36 72 6C 30 30 30 0D (6rI000<CR>).

If the Command is Not valid, Command Type="-"

Name	Length	ID	Command Type	CR
Byte Count	1 Byte	2 Byte	1 Byte	1 Byte
Bytes order	1	2~3	4	5

Example1: Get Brightness from TV-05 and this comm and is valid. The Brightness value is 67.

Send (Hex Format)

Name	Length	ID	Command Type	Command	Value1	Value2	Value3	CR
Hex	<u>0x38</u>	<u>0x30</u> <u>0x35</u>	<u>0x67</u>	<u>0x62</u>	<u>0x30</u>	<u>0x30</u>	<u>0x30</u>	<u>0x0D</u>

Reply (Hex Format)

Name	Length	ID	Command Type	Command	Value1	Value2	Value3	CR
Hex	<u>0x38</u>	<u>0x30</u> <u>0x35</u>	<u>0x72</u>	<u>0x62</u>	<u>0x30</u>	<u>0x36</u>	<u>0x37</u>	<u>0x0D</u>

Example2: Get Brightness from TV-05, but the Brightness command ID is error and it is NOT in the command table.

Send (Hex Format)

Name	Length	ID	Command Type	Command	Value1	Value2	Value3	CR
Hex	<u>0x38</u>	<u>0x30</u> <u>0x35</u>	<u>0x67</u>	<u>0XD3</u>	<u>0x30</u>	<u>0x30</u>	<u>0x30</u>	<u>0x0D</u>

Reply (Hex Format)

Name	Length	ID	Command Type	CR
Hex	<u>0x34</u>	<u>0x30</u> <u>0x35</u>	<u>0x2D</u>	<u>0x0D</u>

Get function table:

Basic function

Get Function	Length	ID	Command Type (ASCII)	Command		Response Range (Three ASCII bytes)	Comments
				Code (ASCII)	Code (Hex)		
Get-Brightness	8		g	b	62	000 ~ 100	
Get-Backlight ^{*3.2.0}	8		a	B	42	000 ~ 100	1. For Android platform whose main mode is controlled by backlight and the other sources are controlled by brightness. 2. Derived from Color calibration. ^{*3.2.0}
Get-Volume	8		g	f	66	000 ~ 100	
Get-Mute	8		g	g	67	000: Off 001: On (muted)	
Get-Input select	8		g	j	6A	000~ 100~	1. 1 st digit for signal detection: 0 means "no signal"; 1 means "signal detected" 2. 2 nd & 3 rd digit: See Set-function table
Get-Power status: ON/STBY	8		g	l	6C	001: ON 000: STBY	
Get-Remote control	S		g	n	6E	000: Disable 001: Enable 002: Pass through	Get RCU mode status
Get-Power lock	8		g	o	6F	000: Unlock 001: Lock	
Get-Button lock	8		g	p	70	000: Unlock 001: Lock	
Get-Menu lock	8		g	q	71	000: Unlock 001: Lock	
Get-ACK	8		g	z	7A	000	This command is used to test the communication link

Get-Thermal	8		g	0	30	000~100: 0~+100 deg C -01~-99: -1~-99 deg C	
Get-Operation hour ^{*3.2.0}	8		g	1	31	000	1. Accumulated hours in 6-digit integer (000,001~999,999) ^{*3.2.0} 2. Can not be reset when FW update and Factory initiation ^{*3.2.2} 3. Reply in new 32-byte format ^{*3.2.0}
Get-Device name	8		g	4	34	000	Reply in new 32-byte format ^{*3.2.0}
Get-MAC address	8		g	5	35	000	(for the model with LAN) Reply in new 32-byte format ^{*3.2.0}
Get-IP address ^{*3.2.0}	8		g	6	36	000	(for the model with LAN) Reply in new 32-byte format ^{*3.2.0}
Get-Serial number ^{*3.2.0}	8		g	7	37	000	Reply in new 32-byte format ^{*3.2.0}
Get-FW version ^{*3.2.0}	8		g	8	38	000	Reply in new 32-byte format ^{*3.2.0}

Optional function

Get Function	Length	ID	Command Type (ASCII)	Command		Response Range (Three ASCII bytes)	Comments
				Code (ASCII)	Code (Hex)		
Get-Contrast	8		g	a	61	000 ~ 100	
Get-Sharpness	8		g	c	63	000 ~ 100	
Get-Color	8		g	d	64	000 ~ 100	
Get-Tint	8		g	e	65	000 ~ 100	
Get-Backlight On_Off ^{3.2.3}	8		g	h	68	000: Off 001: On	
Get-Date: Year	8		g	2	32	Y00~Y00	Last 2 digits (20)17~(20)99
Get-Date: Month	8		g	2	32	M00~M00	2 digits
Get-Date: Day	8		g	2	32	D00~M00	2 digits
Get-Time: Hour	8		g	3	33	H00~H00	24-hr format. 2 digits
Get-Time: Min	8		g	3	33	M00~M00	2 digits
Get-Time: Sec	8		g	3	33	S00~S00	2 digits

11.3.3.Remote Control Pass-through mode

When the PC sets the TV/DS to Remote Control Pass through mode, the TV/DS will send a 7-byte packet (followed by "CR") in response to RCU button activation. Note, that in this mode the RCU shall have no effect on the TV/DS function. For example: "Volume+" will not change the volume in the LCD but only sends "Volume+" code to PC over the RS232 port.

IR Pass Through-Function format

Reply: (Command Type="p")

Name	Length	ID	Command Type	RCU Code1 (MSB)	RCU Code2 (LSB)	CR
Byte Count	1 Byte	2 Byte	1 Byte	1 Byte	1 Byte	1 Byte
Bytes order	1	2~3	4	5	6	7

Example1: Remote Control pass-through when "VOL+" key is pressed for TV-05 Send (Hex Format)

Name	Length	ID	Command Type	Command	Value1	CR
Hex	<u>0x36</u>	<u>0x30</u> <u>0x35</u>	<u>0x70</u>	<u>0x31</u>	<u>0x30</u>	<u>0x0D</u>

Key	Code (HEX)
1	01
2	02
3	03
4	04
5	05
6	06
7	07
8	08
9	09
0	0A
-	0B
RECALL (LAST)	0C
INFO (DISPLAY)	0D
	0E
ASPECT (ZOOM, SIZE)	0F
VOLUME UP (+)	10
VOLUME DOWN (-)	11
MUTE	12
CHANNEL/PAGE UP (+)/ BRIGHTNESS+	13
CHANNEL/PAGE DOWN (-)/ BRIGHTNESS-	14
POWER	15
SOURCES (INPUTS)	16
	17
	18
SLEEP	19
MENU	1A
UP	1B
DOWN	1C
LEFT (-)	1D
RIGHT (+)	1E
OK (ENTER, SET)	1F
EXIT	20
	21
	22
	23
	24
	25
	26
	27
	28
	29
	2A
	2B
RED ■ (F1)	2C
GREEN ■ (F2)	2D
YELLOW ■ (F3)	2E
BLUE ■ (F4)	2F

NOTE:

1. This IR-pass-through code is different from the RCU key code.
2. Special control sequence for POWER key under IR-pass through mode.
 - 2-1. When TV/DS is OFF and receives the IR POWER code: TV/DS will turn itself on, then forward the POWER code to the host via RS232.
 - 2-2. When TV/DS is ON and receives the IR POWER code: TV/DS will forward the POWER code to the host via RS232, then turn off itself.
 - 2-3. When SET-POWER LOCK is enabled, the TV/DS will not respond to POWER key pressing.
3. The VOLUME UP and VOLUME DOWN code will repeatedly output when you press and hold the keys.

12. Other Information

Customer Support

For technical support or product service, see the table below or contact your reseller.

NOTE: You will need the product serial number.

Country/ Region	Website	Country/ Region	Website
Asia Pacific & Africa			
Australia	www.viewsonic.com/au/	Bangladesh	www.viewsonic.com/bd/
中国 (China)	www.viewsonic.com.cn	香港 (繁體中文)	www.viewsonic.com/hk/
Hong Kong (English)	www.viewsonic.com/hk-en/	India	www.viewsonic.com/in/
Indonesia	www.viewsonic.com/id/	Israel	www.viewsonic.com/il/
日本 (Japan)	www.viewsonic.com/jp/	Korea	www.viewsonic.com/kr/
Malaysia	www.viewsonic.com/my/	Middle East	www.viewsonic.com/me/
Myanmar	www.viewsonic.com/mm/	Nepal	www.viewsonic.com/np/
New Zealand	www.viewsonic.com/nz/	Pakistan	www.viewsonic.com/pk/
Philippines	www.viewsonic.com/ph/	Singapore	www.viewsonic.com/sg/
臺灣 (Taiwan)	www.viewsonic.com/tw/	ประเทศไทย	www.viewsonic.com/th/
Việt Nam	www.viewsonic.com/vn/	South Africa & Mauritius	www.viewsonic.com/za/
Americas			
United States	www.viewsonic.com/us	Canada	www.viewsonic.com/us
Latin America	www.viewsonic.com/la		
Europe			
Europe	www.viewsonic.com/eu/	France	www.viewsonic.com/fr/
Deutschland	www.viewsonic.com/de/	Қазақстан	www.viewsonic.com/kz/
Россия	www.viewsonic.com/ru/	España	www.viewsonic.com/es/
Türkiye	www.viewsonic.com/tr/	Україна	www.viewsonic.com/ua/
United Kingdom	www.viewsonic.com/uk/		

Limited Warranty

ViewSonic® LCD Commercial Display

What the warranty covers:

ViewSonic warrants its products to be free from defects in material and workmanship, under normal use, during the warranty period. If a product proves to be defective in material or workmanship during the warranty period, ViewSonic will, at its sole option, repair or replace the product with a like product. Replacement product or parts may include remanufactured or refurbished parts or components.

Who the warranty protects:

This warranty is valid only for the first consumer purchaser.

What the warranty does not cover:

1. Any product on which the serial number has been defaced, modified or removed.
2. Damage, deterioration or malfunction resulting from:
 - a. Accident, misuse, neglect, fire, water, lightning, or other acts of nature, unauthorized product modification, or failure to follow instructions supplied with the product.
 - b. Any damage of the product due to shipment.
 - c. Removal or installation of the product.
 - d. Causes external to the product, such as electrical power fluctuations or failure.
 - e. Use of supplies or parts not meeting ViewSonic's specifications.
 - f. Normal wear and tear.
 - g. Any other cause which does not relate to a product defect.
3. Any product exhibiting a condition commonly known as "image burn-in" which results when a static image is displayed on the product for an extended period of time.
4. Removal, installation, one way transportation, insurance, and set-up service charges.

How to get service:

1. For information about receiving service under warranty, contact ViewSonic Customer Support (Please refer to Customer Support page). You will need to provide your product's serial number.
2. To obtain warranty service, you will be required to provide (a) the original dated sales slip, (b) your name, (c) your address, (d) a description of the problem, and (e) the serial number of the product.
3. Take or ship the product freight prepaid in the original container to an authorized ViewSonic service center or ViewSonic.
4. For additional information or the name of the nearest ViewSonic service center, contact ViewSonic.

Limitation of implied warranties:

There are no warranties, express or implied, which extend beyond the description contained herein including the implied warranty of merchantability and fitness for a particular purpose.

Exclusion of damages:

ViewSonic's liability is limited to the cost of repair or replacement of the product. ViewSonic shall not be liable for:

1. Damage to other property caused by any defects in the product, damages based upon inconvenience, loss of use of the product, loss of time, loss of profits, loss of business opportunity, loss of goodwill, interference with business relationships, or other commercial loss, even if advised of the possibility of such damages.
2. Any other damages, whether incidental, consequential or otherwise.
3. Any claim against the customer by any other party.
4. Repair or attempted repair by anyone not authorized by ViewSonic.

Effect of state law:

This warranty gives you specific legal rights, and you may also have other rights which vary from state to state. Some states do not allow limitations on implied warranties and/or do not allow the exclusion of incidental or consequential damages, so the above limitations and exclusions may not apply to you.

Sales outside the U.S.A. and Canada:

For warranty information and service on ViewSonic products sold outside of the U.S.A. and Canada, contact ViewSonic or your local ViewSonic dealer.

The warranty period for this product in mainland China (Hong Kong, Macao and Taiwan Excluded) is subject to the terms and conditions of the Maintenance Guarantee Card.

For users in Europe and Russia, full details of warranty provided can be found in www.viewsoniceurope.com under Support/Warranty Information.

Mexico Limited Warranty

ViewSonic® LCD Commercial Display

What the warranty covers:

ViewSonic warrants its products to be free from defects in material and workmanship, under normal use, during the warranty period. If a product proves to be defective in material or workmanship during the warranty period, ViewSonic will, at its sole option, repair or replace the product with a like product. Replacement product or parts may include re-manufactured or refurbished parts or components.

Who the warranty protects:

This warranty is valid only for the first consumer purchaser.

What the warranty does not cover:

1. Any product on which the serial number has been defaced, modified or removed.
2. Damage, deterioration or malfunction resulting from:
 - a. Accident, misuse, neglect, fire, water, lightning, or other acts of nature, unauthorized product modification, or failure to follow instructions supplied with the product.
 - b. Any damage of the product due to shipment.
 - c. Removal or installation of the product.
 - d. Causes external to the product, such as electrical power fluctuations or failure.
 - e. Use of supplies or parts not meeting ViewSonic's specifications.
 - f. Normal wear and tear.
 - g. Any other cause which does not relate to a product defect.
3. Any product exhibiting a condition commonly known as "image burn-in" which results when a static image is displayed on the product for an extended period of time.
4. Removal, installation, one way transportation, insurance, and set-up service charges.

How to get service:

For information about receiving service under warranty, contact ViewSonic Customer Support (Please refer to the attached Customer Support page). You will need to provide your product's serial number, so please record the product information in the space provided below on your purchase for your future use. Please retain your receipt of proof of purchase to support your warranty claim.

For Your Records

Product Name: _____

Model Number: _____

Document Number: _____

Serial Number: _____

Purchase Date: _____

Extended Warranty Purchase? _____ (Y/N)

If so, what date does warranty expire? _____

1. To obtain warranty service, you will be required to provide (a) the original dated sales slip, (b) your name, (c) your address, (d) a description of the problem, and (e) the serial number of the product.
2. Take or ship the product in the original container packaging to an authorized ViewSonic service center.
3. Round trip transportation costs for in-warranty products will be paid by ViewSonic.

Limitation of implied warranties:

There are no warranties, express or implied, which extend beyond the description contained herein including the implied warranty of merchantability and fitness for a particular purpose.

Exclusion of damages:

ViewSonic's liability is limited to the cost of repair or replacement of the product. ViewSonic shall not be liable for:

1. Damage to other property caused by any defects in the product, damages based upon inconvenience, loss of use of the product, loss of time, loss of profits, loss of business opportunity, loss of goodwill, interference with business relationships, or other commercial loss, even if advised of the possibility of such damages.
2. Any other damages, whether incidental, consequential or otherwise.
3. Any claim against the customer by any other party.
4. Repair or attempted repair by anyone not authorized by ViewSonic.
- 5.
- 6.
- 7.

Contact Information for Sales & Authorized Service (Centro Autorizado de Servicio) within Mexico:	
Name, address, of manufacturer and importers: México, Av. de la Palma #8 Piso 2 Despacho 203, Corporativo Interpalmas, Col. San Fernando Huixquilucan, Estado de México Tel: (55) 3605-1099 http://www.viewsonic.com/la/soporte/index.htm	
NÚMERO GRATIS DE ASISTENCIA TÉCNICA PARA TODO MÉXICO: 001.866.823.2004	
Hermosillo: Distribuciones y Servicios Computacionales SA de CV. Calle Juarez 284 local 2 Col. Bugambilias C.P: 83140 Tel: 01-66-22-14-9005 E-Mail: disc2@hmo.megared.net.mx	Villahermosa: Compumantenimietnos Garantizados, S.A. de C.V. AV. GREGORIO MENDEZ #1504 COL, FLORIDA C.P. 86040 Tel: 01 (993) 3 52 00 47 / 3522074 / 3 52 20 09 E-Mail: compumantenimientos@prodigy.net.mx
Puebla, Pue. (Matriz): RENTA Y DATOS, S.A. DE C.V. Domicilio: 29 SUR 721 COL. LA PAZ 72160 PUEBLA, PUE. Tel: 01(52).222.891.55.77 CON 10 LINEAS E-Mail: datos@puebla.megared.net.mx	Veracruz, Ver.: CONEXION Y DESARROLLO, S.A DE C.V. Av. Americas # 419 ENTRE PINZÓN Y ALVARADO Fracc. Reforma C.P. 91919 Tel: 01-22-91-00-31-67 E-Mail: gacosta@qplus.com.mx
Chihuahua Soluciones Globales en Computación C. Magisterio # 3321 Col. Magisterial Chihuahua, Chih. Tel: 4136954 E-Mail: Cefeo@soluglobales.com	Cuernavaca Compusupport de Cuernavaca SA de CV Francisco Leyva # 178 Col. Miguel Hidalgo C.P. 62040, Cuernavaca Morelos Tel: 01 777 3180579 / 01 777 3124014 E-Mail: aquevedo@compusupportcva.com
Distrito Federal: QPLUS, S.A. de C.V. Av. Coyoacán 931 Col. Del Valle 03100, México, D.F. Tel: 01(52)55-50-00-27-35 E-Mail : gacosta@qplus.com.mx	Guadalajara, Jal.: SERVICRECE, S.A. de C.V. Av. Niños Héroes # 2281 Col. Arcos Sur, Sector Juárez 44170, Guadalajara, Jalisco Tel: 01(52)33-36-15-15-43 E-Mail: mmiranda@servicrece.com
Guerrero Acapulco GS Computación (Grupo Sesicomp) Progreso #6-A, Colo Centro 39300 Acapulco, Guerrero Tel: 744-48-32627	Monterrey: Global Product Services Mar Caribe # 1987, Esquina con Golfo Pérsico Fracc. Bernardo Reyes, CP 64280 Monterrey N.L. México Tel: 8129-5103 E-Mail: aydeem@gps1.com.mx
MÉRIDA: ELECTROSER Av Reforma No. 403Gx39 y 41 Mérida, Yucatán, México CP97000 Tel: (52) 999-925-1916 E-Mail: rrrb@sureste.com	Oaxaca, Oax.: CENTRO DE DISTRIBUCION Y SERVICIO, S.A. de C.V. Murguía # 708 P.A., Col. Centro, 68000, Oaxaca Tel: 01(52)95-15-15-22-22 Fax: 01(52)95-15-13-67-00 E-Mail: gpotai2001@hotmail.com
Tijuana: STD Av Ferrocarril Sonora #3780 L-C Col 20 de Noviembre Tijuana, Mexico	FOR USA SUPPORT: ViewSonic Corporation 10 Pointe Dr. Suite 200. Brea, CA. 92821 UY.S.A Tel: 800-688-6688 E-Mail: http://www.viewsonic.com



ViewSonic®