

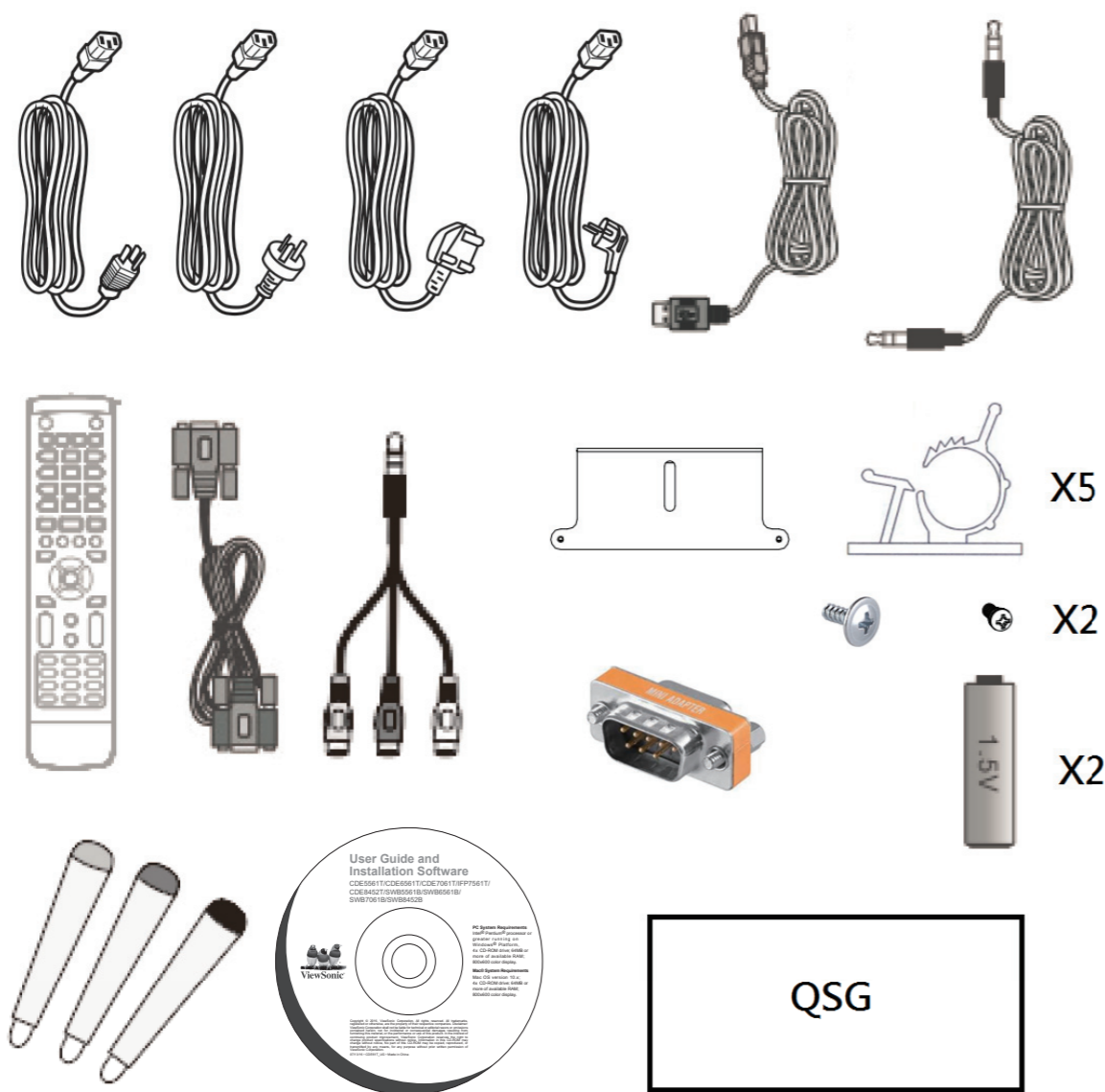

IFP50 series Commercial Touch Display Quick Start Guide

1 Package Contents

- VGA cable
- Power cable x 4
- Remote control
- AAA battery x 2
- USB cable
- Audio cable
- AV cable
- Stylus pen x 3
- User manual CD wizard
- Quick start guide
- RS232 adapter
- Clamp x 5
- Plate
- Screw x 3



2 Wall Mount Kit Specifications (VESA)

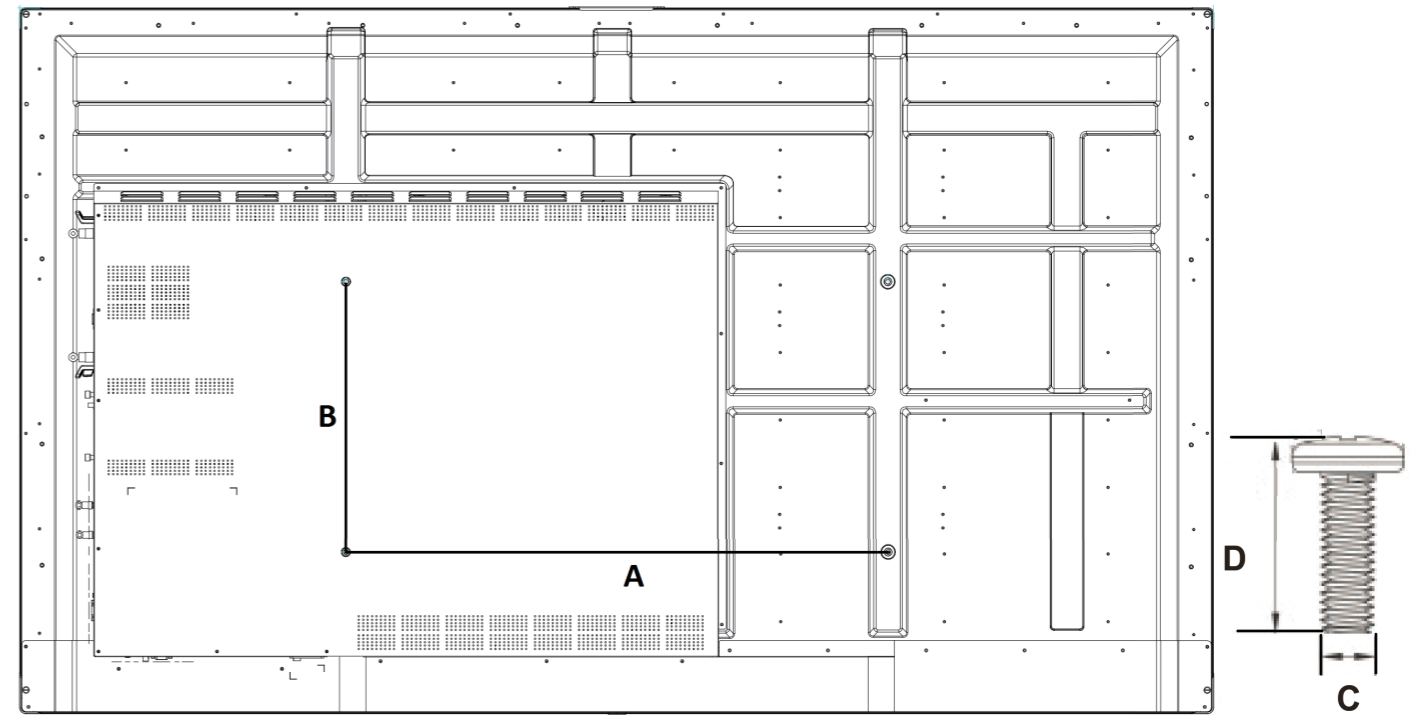

inch	VESA Spec. (A x B)	Standard Screw (C x D)	Quantity
IFP6550 - 65"	600 x 400 mm	M8 x 25 mm	4
IFP7550 - 75"	800 x 400 mm	M8 x 25 mm	4
IFP8650 - 86"	800 x 600 mm	M8 x 25 mm	4

PN-WMK-047

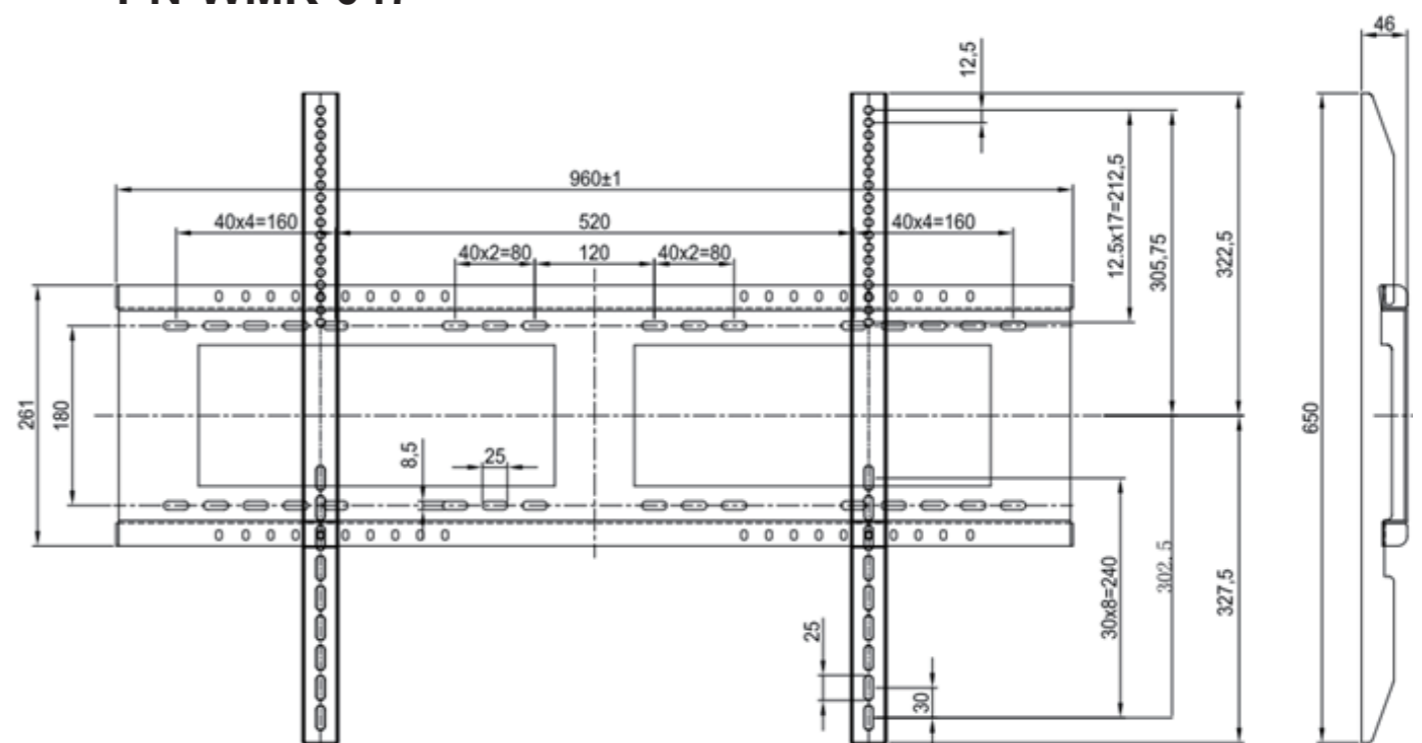

3 Control Panel Overview

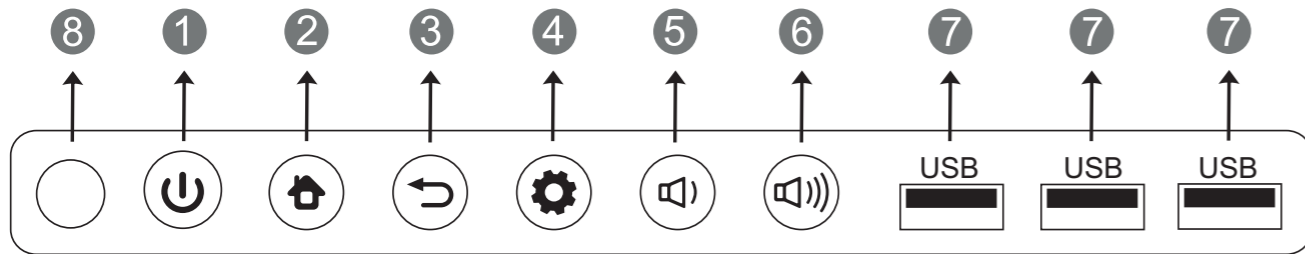

Item	Description
1	Press the key to turn on the device Press the key to turn off/on the display backlight only Press and hold the key to turn off the device
2	Back to Embedded player main interface
3	Return to Embedded player previous level
4	Call up function menu
5	Decrease volume
6	Increase volume
7	USB port for Embedded Player and internal PC
8	Receives signals from the remote control

4 Terminal Interface Overview

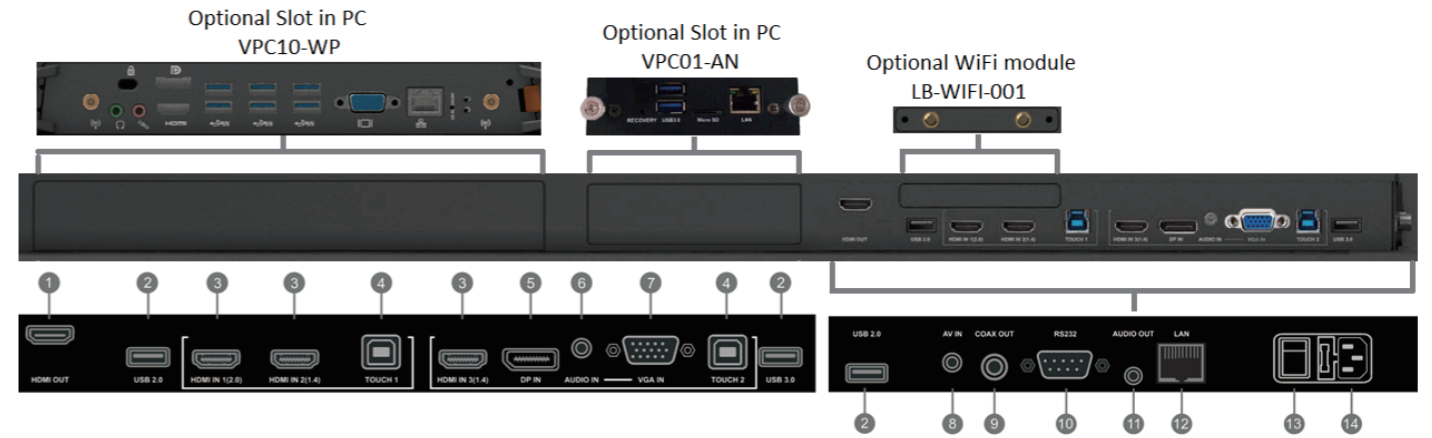

Item	Description
1	Connected to display devices with HDMI input function
2	USB port for Embedded Player
3	High-definition multimedia interface signal input, connect to PC with HDMI output, set-top box, or other video device
4	Touch signal output to the external PC Touch 1 for HDMI IN 1 and 2 Touch 2 for HDMI IN 3, DP IN and VGA IN
5	Connected to devices with DisplayPort output function
6	External computer audio input
7	External computer image input
8	Composite video and audio input
9	Coaxial output
10	Serial interface, used for mutual transfer of data between devices
11	Audio output to the external speaker
12	Standard RJ45 (10M/100M/1G) Internet connection interface (This network port is used for Embedded Player and Slot in PC)
13	Power On / Off switch
14	AC power input

5 Remote Control Overview

- | | |
|--|---|
| 1 :
Press to turn the display ON/OFF | 21 :
Press to scroll down |
| 2 :
Mute / Unmute | 22 ENTER:
Enter button. Press it to select options. |
| 3 DISPLAY :
Display information of the current input source | 23 :
Writing software startup |
| 4 P.MODE :
Blank screen | 24 ESC/EXIT, D. SETUP:
Shortcut button to exit dialog boxes |
| 5 S.MODE :
Freeze screen | 25 EPG:
Back |
| 6 Numeric button:
Numeric input button | 26 FAV, SPACE:
PC 'Space' button |
| 7 -/--, ALT+TAB:
Press to switch between PC applications | 27 CH. +, CH. - :
CH+ : PC previous page
CH- : PC next page |
| 8 0:
Numeric input button | 28 VOL+, VOL-:
Increase / Decrease volume |
| 9 , ALT+F4 :
Close current PC window | 29 F1:
Windows F1 Function |
| 10 INPUT:
Source selection button | 30 F2:
Windows F2 Function |
| 11 MENU:
Press to display Menu | 31 F3:
Windows F3 Function |
| 12 RED+ALT:
Screen capture | 32 F4:
Windows F4 Function |
| 13 GREEN+TAB:
PC 'Tab' button | 33 F5:
Windows F5 Function |
| 14 YELLOW+DESKTOP:
Switch to slot in PC desktop | 34 F6:
Windows F6 Function |
| 15 BLUE+BACKSPACE:
PC 'Backspace' button | 35 F7:
Windows F7 Function |
| 16 , 19 MENU:
PC 'Windows' button | 36 F8:
Windows F8 Function |
| 17 , D. TITLE:
PC 'Menu' button | 37 F9:
Windows F9 Function |
| 18 :
Press to scroll up | 38 F10:
Windows F10 Function |
| :
Press to scroll left | 39 F11:
Windows F11 Function |
| 20 :
Press to scroll right | 40 F12:
Windows F12 Function |

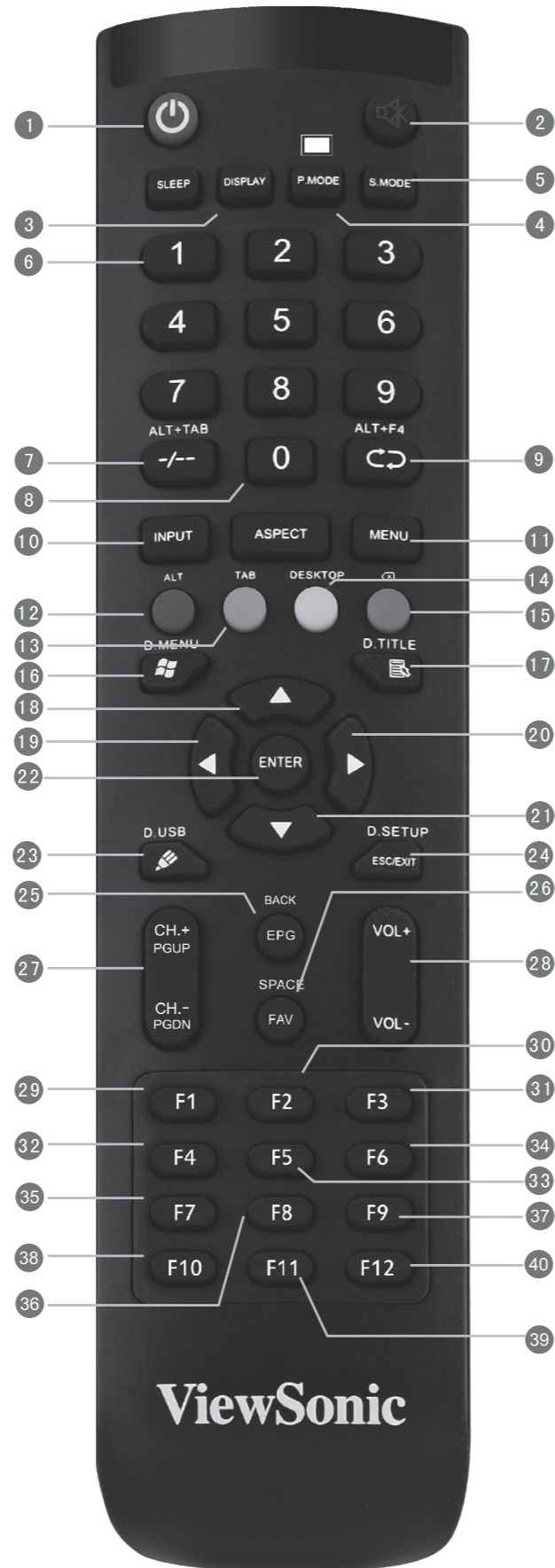

6 Connecting an External PC

- To display video and sound from an external PC follow the instructions below.
Note: External PCs can also be connected to the display via HDMI cable.
 - Connect a VGA cable (15-pin) from your external PC to the VGA IN port on the display.
 - Connect an audio cable from the AUDIO OUT port on your external PC to the AUDIO IN port on the display.
- Connect a USB cable to the external PC from the TOUCH OUT port of the display.
Note: For optimal results, select 1920x1080p as the external computer's input resolution.

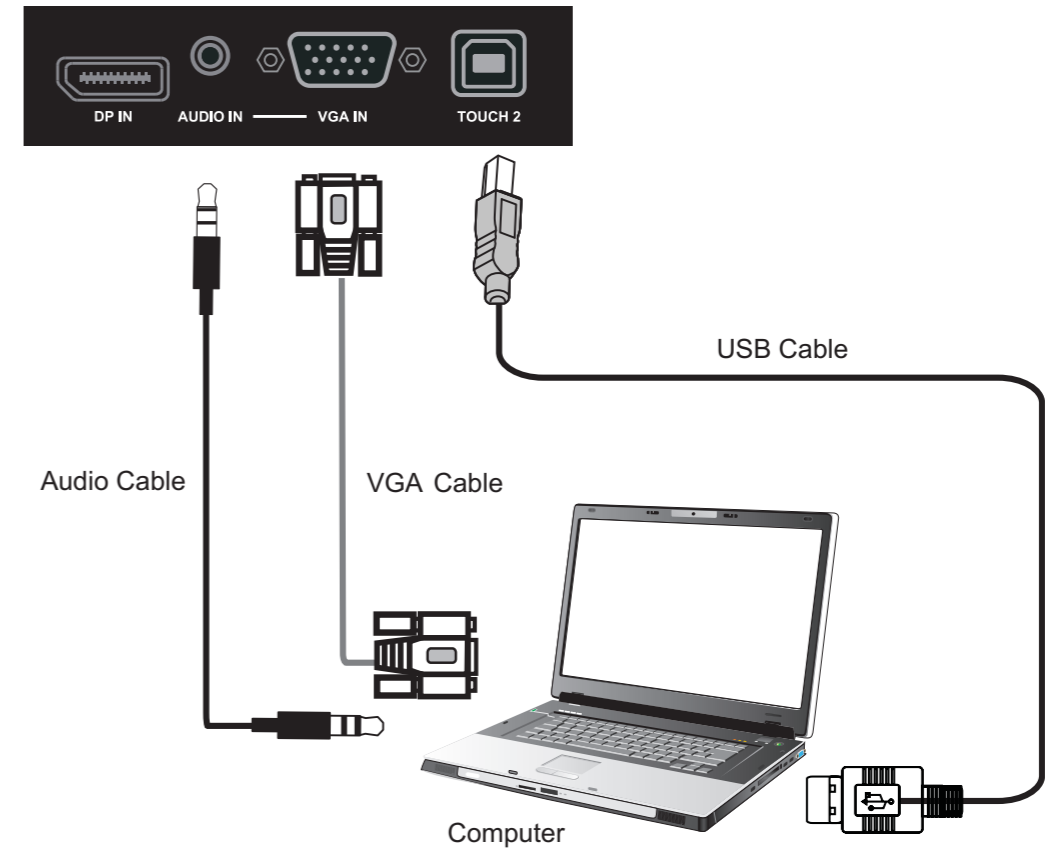

7 RS232 Connections

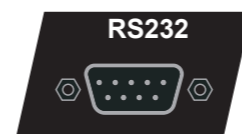

When you use an RS232 serial port cable to connect your display to an external computer, certain functions can be controlled by the PC, including power on/off, volume adjustment and more.

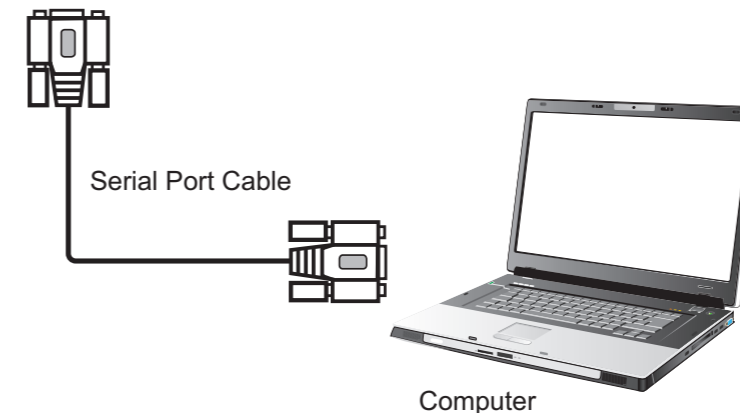

8 Connecting USB Peripherals

1. USB Peripherals: Plug the USB device cable into the USB IN port.
2. Networking and modem cables: Plug the router cable into the LAN IN port.
3. Microphone: Plug the microphone cable into the MIC port.

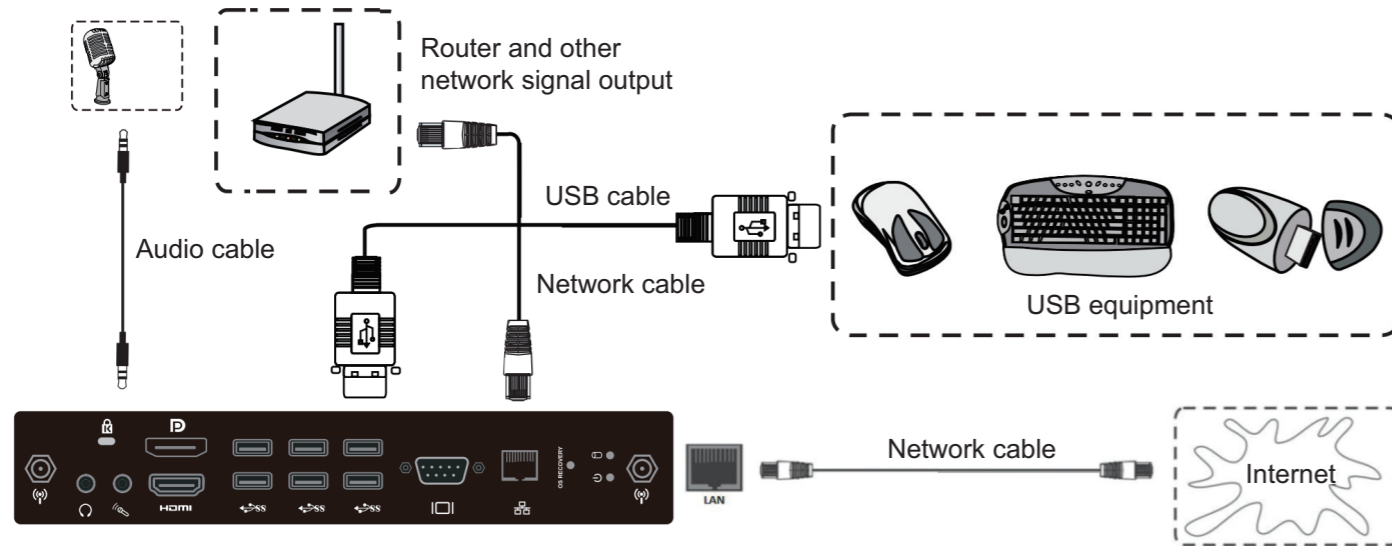

9 HDMI Connections

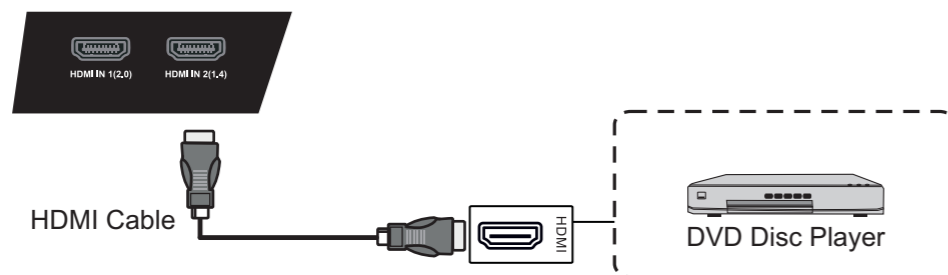

10 General Setting

Input sources, Volume, Back light and Flicker free

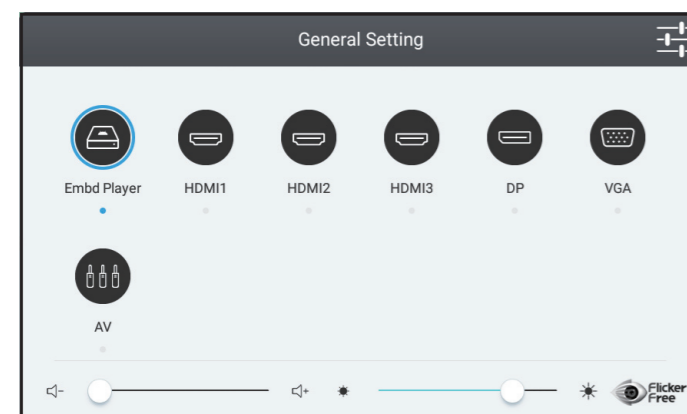

11 More OSD settings

Audio Setting



Screen Setting

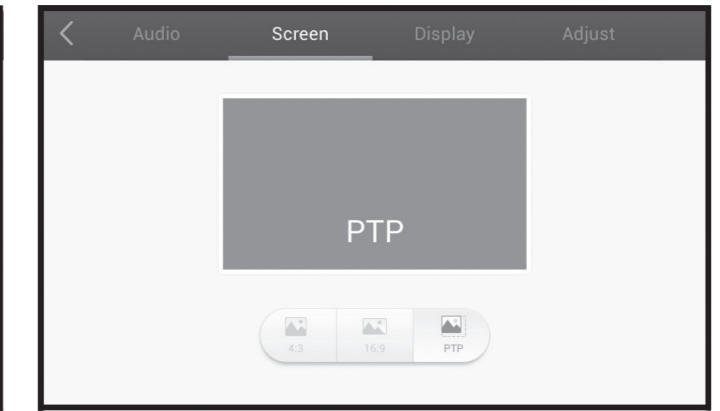

Display Setting

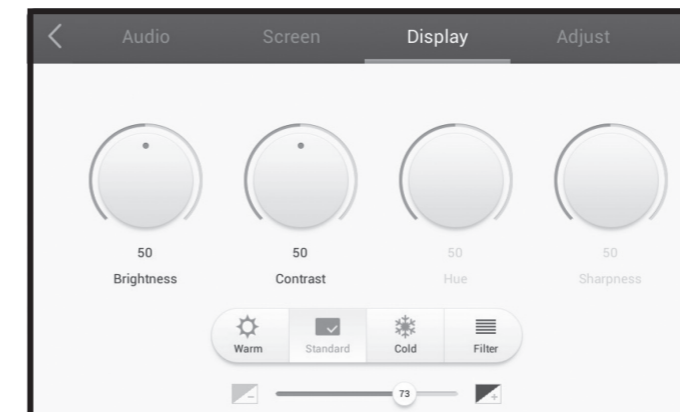

Adjust Setting

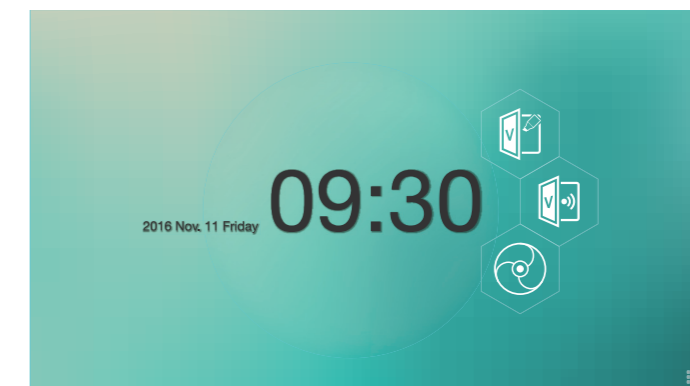
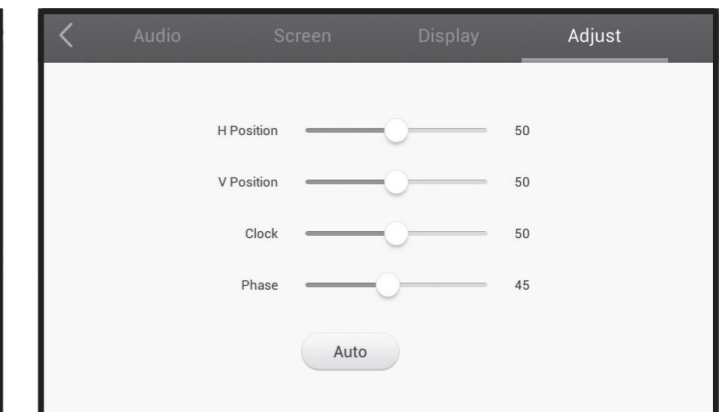

Item	Description	Item	Description
vBoard	Click to launch annotation app	Browser	Click to visitweb site
ViewBoard Cast	Click to show wireless screen sharing app	APPs	Click to pop up app list

12 vPen

1. In any input source, you can call up the annotation menu by placing two fingers on the screen (about 20-50mm spacing) and holding there for two seconds.
2. In annotation menu, user can only use floating pen to operate.

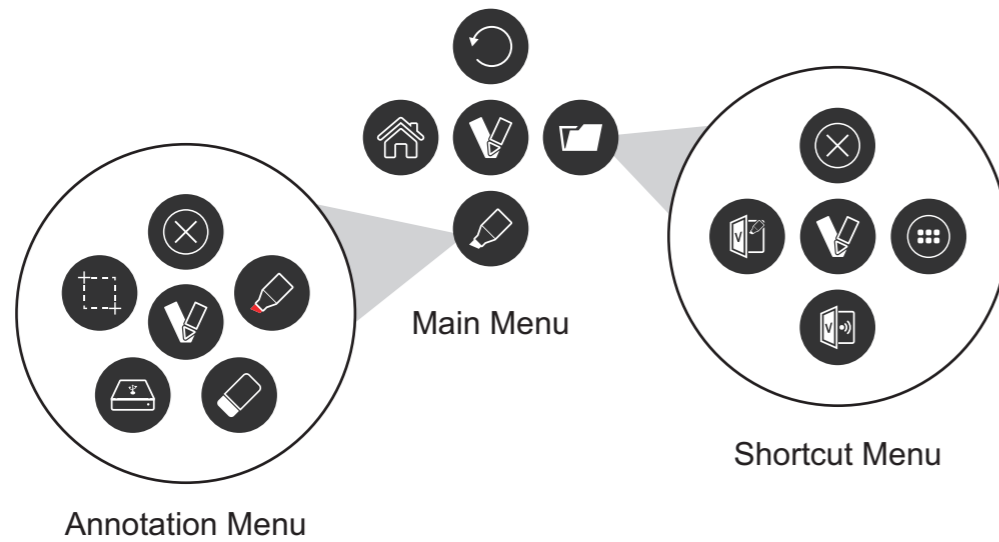

Item	Description
Floating point	Click to show/hide sub points. Or drag and drop the point somewhere on the screen.
Return	Click to return to previous operation interface.
Home	Click to return to main launcher.
Pen	Pop up annotation menu. Click to make annotation in the picture, click again to change color.
Screen capture	Click and drag a rectangle on screen. It can arbitrarily adjust position and shape of the rectangular. Storage location: /Storage/vBoard
Save as	Click to save the current image. Storage location: /Storage/vBoard
Eraser	Click to erase handwriting as required.
Shortcut	Pop up shortcut menu.
vBoard	Click to enter vBoard software.
ViewBoard Cast	Click to enter ViewBoard Cast software.
App	Click to launch apps menu.
Close	Click to close annotation menu.

13 vBoard Annotation Software

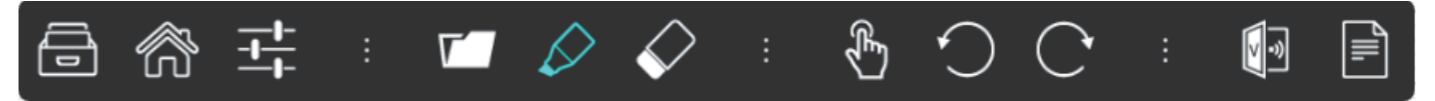

Item	Description	Item	Description
File	New/Open/Save file	Undo	Cancel the last change
Home	Return to Launcher	Redo	Revert the effects of the undo action
Settings	Open settings dialog	Page	Click to show page management
Open Doc	Open a media/document file via default app		Click to show or hide the grid
Pen	Click to pop a parameter dialog for pen drawing. Color, thickness, transparency and shape object can be selected through this dialog Then close dialog to start drawing		Click to show or hide the clock
Eraser	Click to use an eraser		Click to reverse tool bar
Select	Select any object on the board		Click to reverse tool bar
ViewBoard Cast	Click to access ViewBoard Cast for wireless screen sharing.		

14 vBoard Lite:

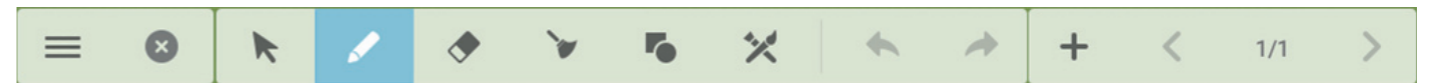

Item	Description	Item	Description
Menu	Click to pop up sub-menu	Watercolor	Click to entry watercolor page
Exit	Click to exit vBoard Lite	Undo	Cancel the last change
Select	Select any object on the board	Redo	Revert the effects of the undo action
Pen	Click to write or press and hold for three seconds to set type, color and thickness.	Add page	Click to add a new page
Eraser	Click to use an eraser	Previous	Click to previous page
Clean	Click to clean all the elements	1/1 Page	Display page number
Graphic	Click to create or press and hold for three seconds to set type, color and thickness.	Next	Click to next page

15 ViewBoard Cast

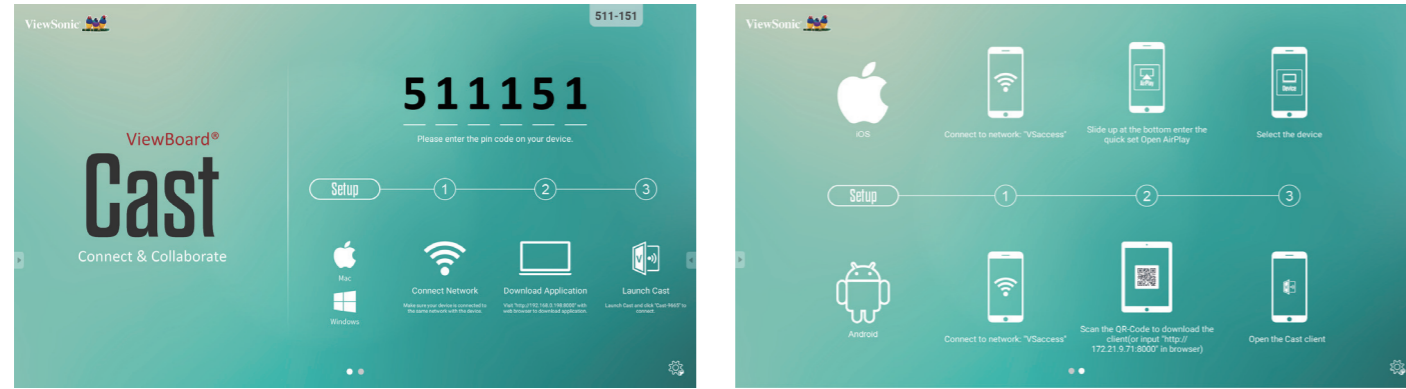

16 Cloud Drive:

User can directly set up a Google drive account for the Interactive Flat Panel (IFP) by selecting the “Cloud Drive” hotkey on tool bar.



Users can add multiple accounts and set up default accounts to save files.

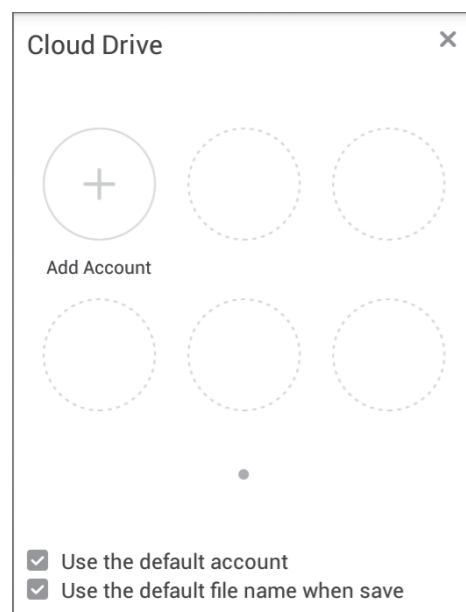

Item	Description
Add Account	Add user account.
Use the default account	The current image will be uploaded to the default cloud storage account.
Use the default file name when save	The current image will be uploaded to cloud storage without letting you change the name of the file.

When completing an annotation, user can choose a Cloud Drive hotkey from floating pen menu, create the file name, and the file will then be saved to your default Google Drive account.

17 ES File

User can use ES File to open file that in Google drive directly.

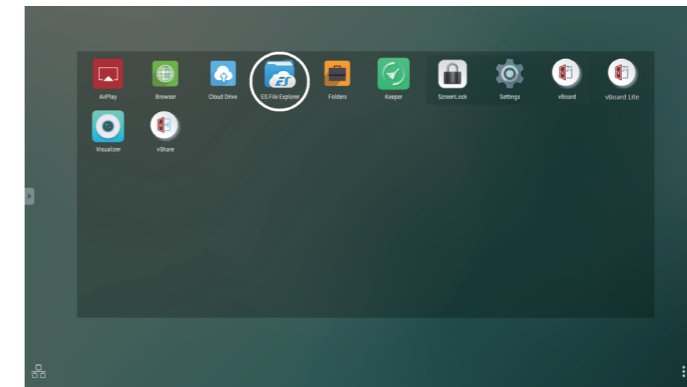

18 ES File Explorer

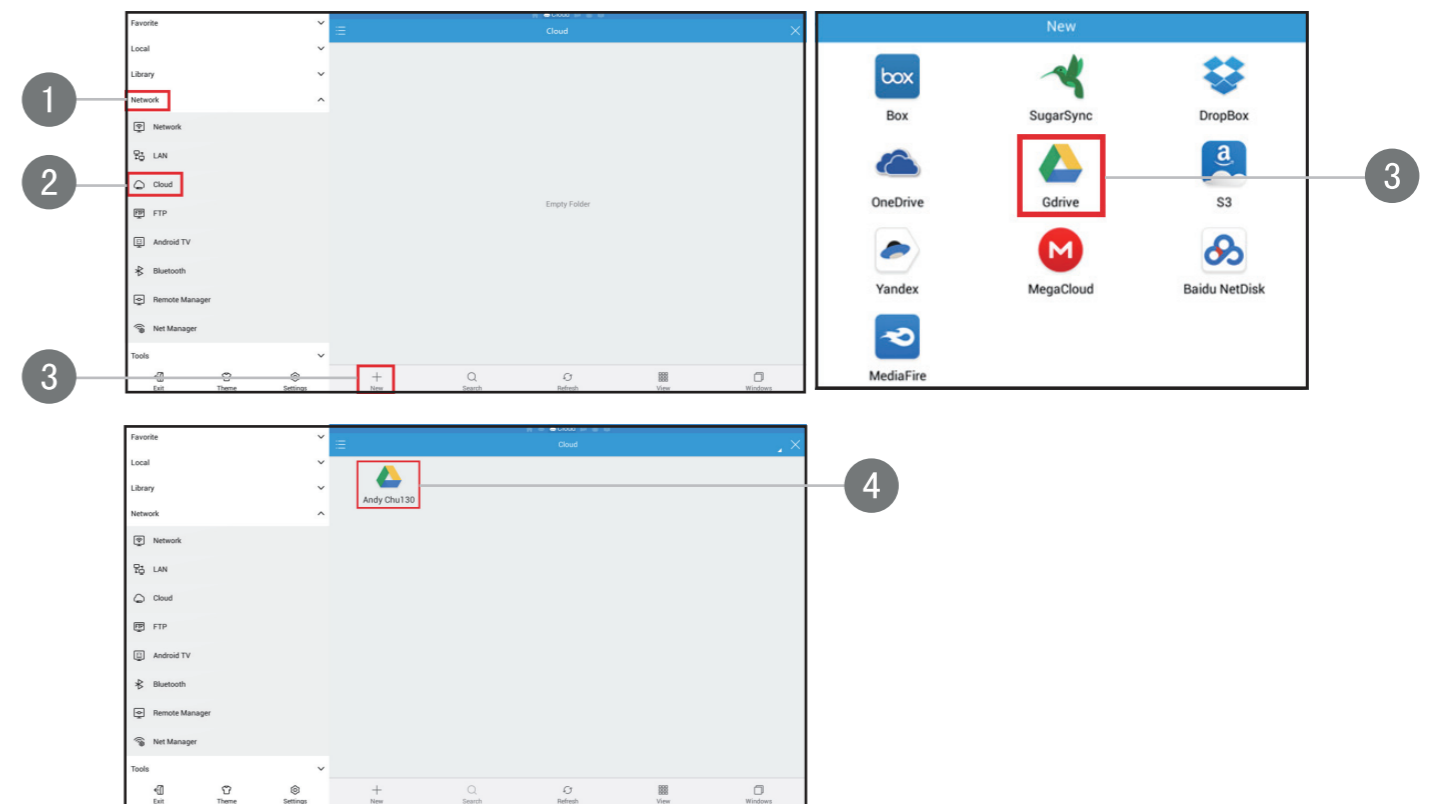

Item	Description
1	Enter to submenu.
2	Enter to operation page.
3	Touch “Gdrive” icon to add cloud account.
4	Select cloud account to access the cloud file.