

ViewSonic®



Video Wall Installation Guide User Guide

IMPORTANT: Please read this User Guide to obtain important information on installing and using your product in a safe manner, as well as registering your product for future service. Warranty information contained in this User Guide will describe your limited coverage from ViewSonic Corporation, which is also found on our web site at <http://www.viewsonic.com> in English, or in specific languages using the Regional selection box in the upper right corner of our website. "Antes de operar su equipo lea cuidadosamente las instrucciones en este manual"

Contents

1. Precaution

2. Note on moving the display

3. Installing the Product

3-1. Installation on an Indented Wall6

3-2. Mounting in Portrait Position6

4. Tiling Display

Function of Edge Alignment Kit8

Installing Edge Alignment Kit8

5. Daisy Chain Monitors

Cable connections11

Important Indication11

Signal Input Requirement.....12

6. Control Connection

IR daisy-chain connection14

RS232 daisy-chain connection15

LAN connection15

Control Indication.....16

7. Setting the Tile Mode

Tiling Mode17

Set tiling mode in OSD18

8. Other OSD Setting

9. Color Calibration for Video Wall

1. Precaution



Do not Clamp.



Do not drop from stacking.



Do not drop from clamping.



4 Persons needed for transport



2 Persons needed for transport



Do not transport horizontally.



Load with care.



Do not drop from carrying.

Don't tumble the Set box sideward down.



Don't lie on or lean on the Set box.

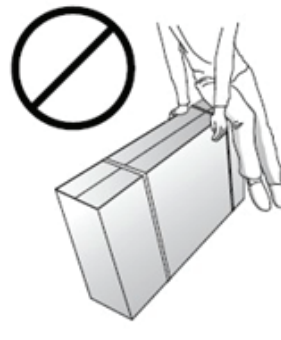
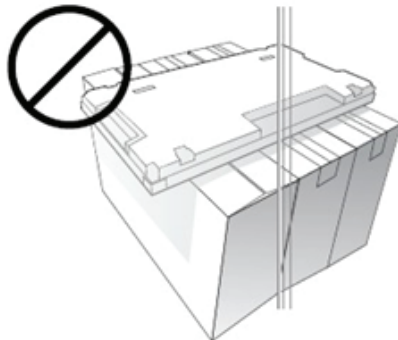

2. Note on moving the display

The display has limited mechanical strength. To prevent the display from performance failure caused by line defects, front bezel bending, glass scratch/broken, light leakage, etc, it must be handled with care. Keep the original shipping box and packaging in storage for use in the future when you may need to transport the product.

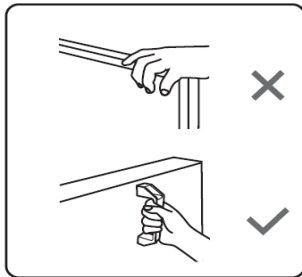

When you want to move the display, make sure the four (4) handles are held.

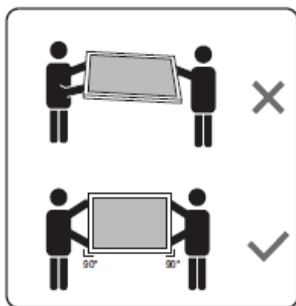

Always move the display by at least two (2) adults with both hands.



Lay down the display gently and horizontally.

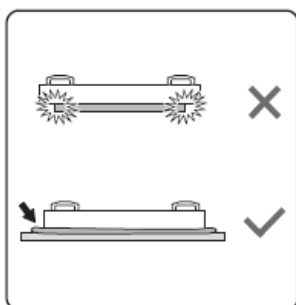

When you want to place the display face down, prepare a flat and horizontal surface that is larger than the display and spread a thick protective sheet on it.

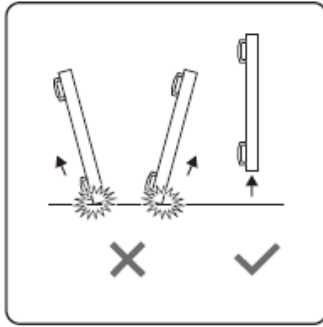

Be careful not to scratch any parts of the display when upturning the display.

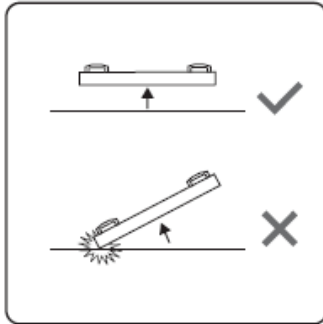

Lift the display up horizontally by holding the four (4) handles. Do not lift the display against its corner.

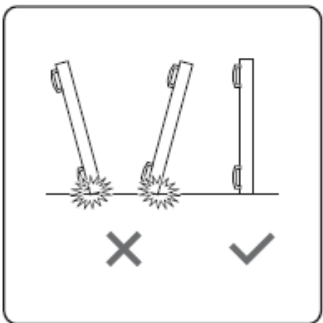

When you want to upturn the display, stand the display vertically to make sure its weight spread evenly on the surface.

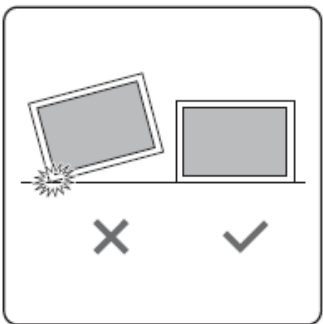

3. Installing the Product

3-1. Installation on an Indented Wall

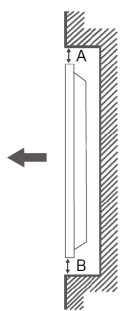
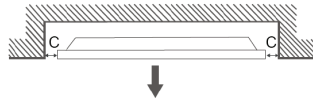

Figure 1.2 Side view

Figure 1.3 Side view



Plane view

A Minimum 100mm

B Minimum 100mm

C Minimum 100mm

When installing the product on an indented wall, allow at least the space specified above between the product and wall for ventilation

3-2. Mounting in Portrait Position

This display can be installed in portrait position.

1. Remove the table stand, if attached.
2. Rotate 90 degrees clockwise.

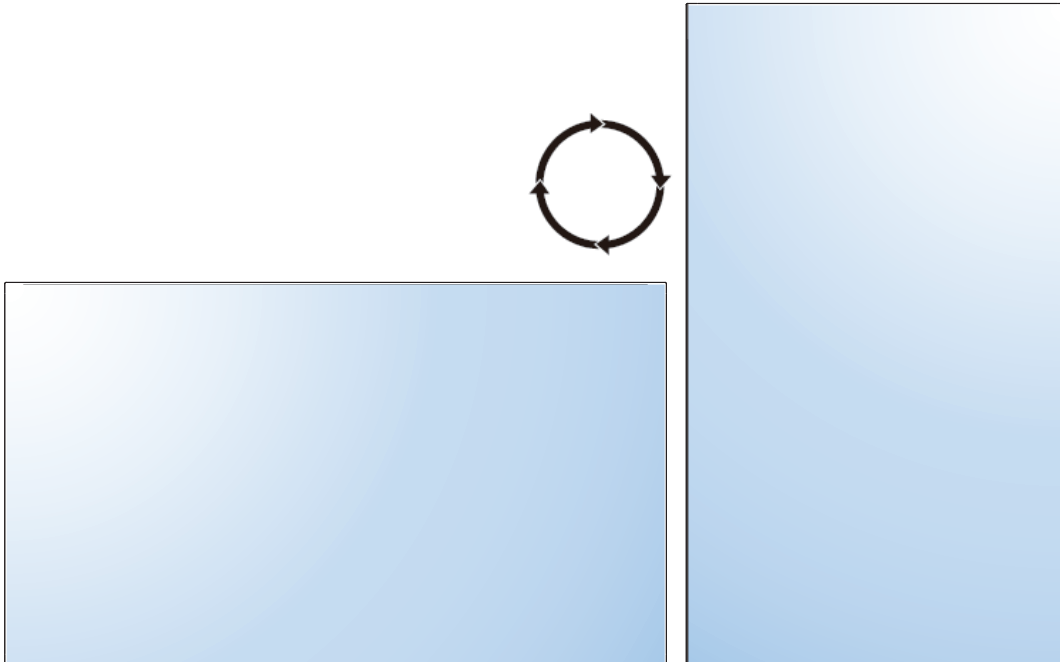

4. Tiling Display

Operating Instructions of Edge Alignment Kit

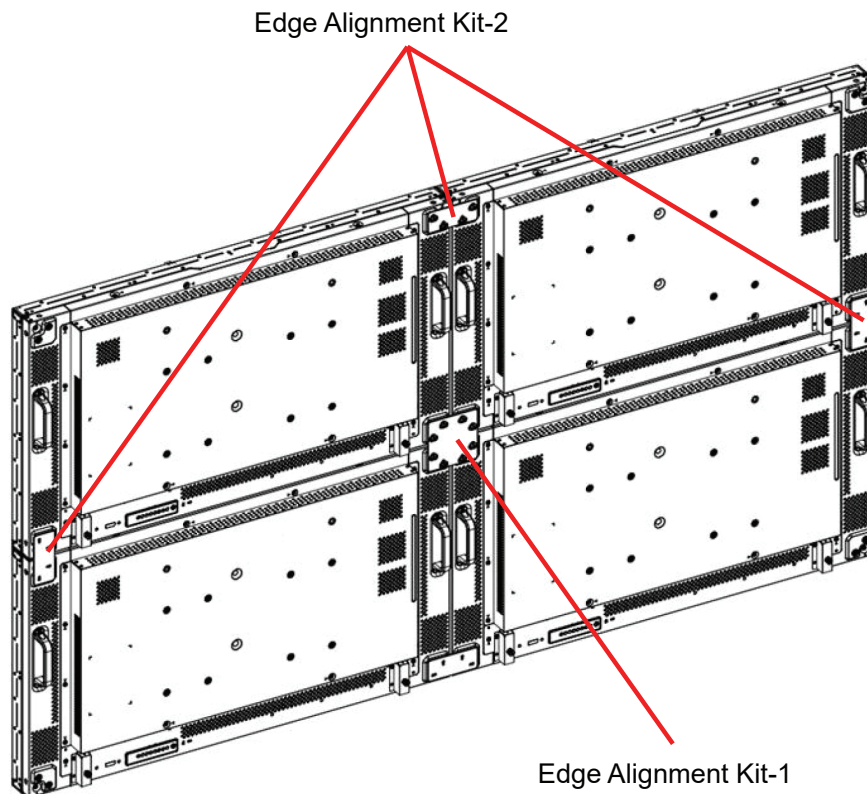

Basic Composition per set

- Edge Alignment Kit-1: 1PCS
- Edge Alignment Kit-2: 2PCS
- Thumb Screw: 8PCS

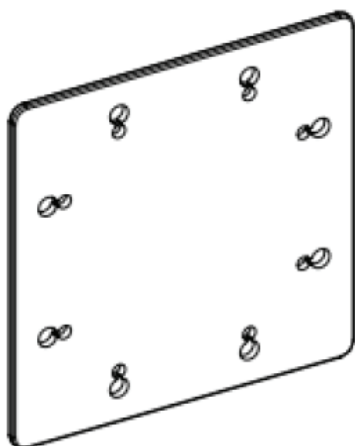

Edge Alignment Kit-1

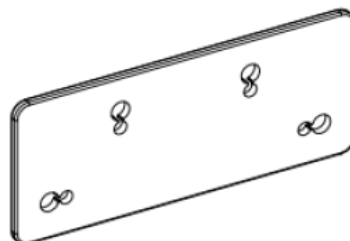

Edge Alignment Kit-2



Thumb Screw

Function of Edge Alignment Kit

- Keep adjacent Displays at the same plane and uniform gap.

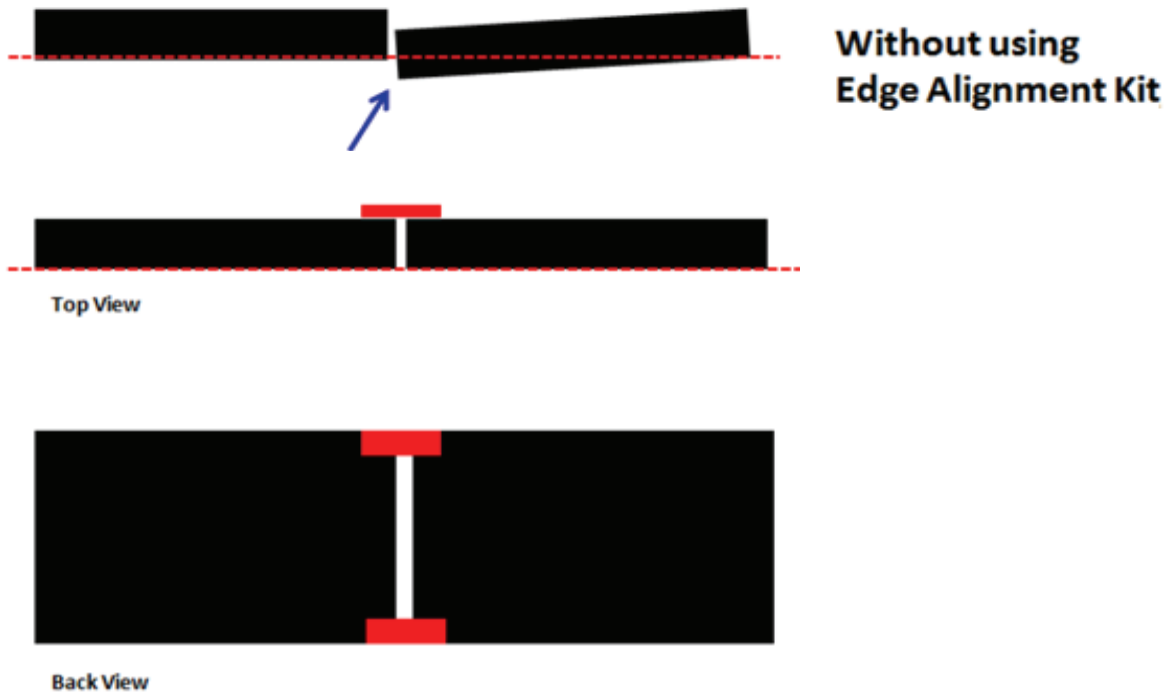

Installing Edge Alignment Kit

- Before install edge alignment kit, displays must be mounted to video wall frame correctly.
- Using “Thumb Screw” for easy installing.

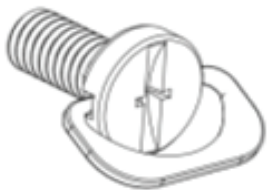

- Using “Edge Alignment Kit-1” on adjacent four displays.

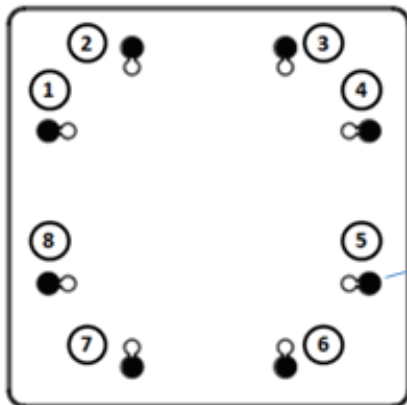
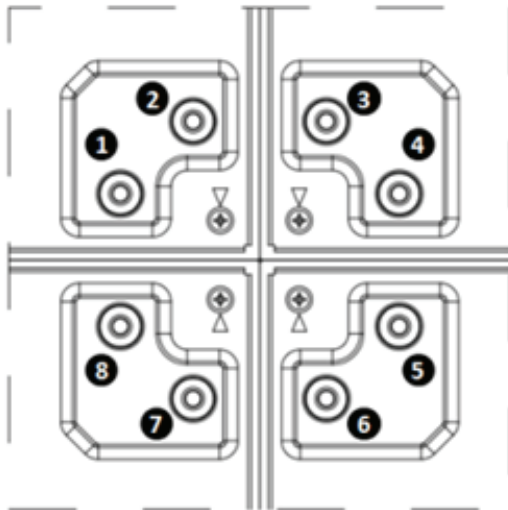

There are two loops of screw holes (outer & inner), depend on the design of each model. (Please check the user manual for using loop information)

Outer loop: Big screw holes for M6 screw.

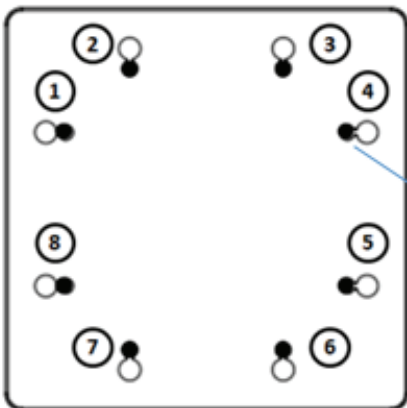

Inner loop: Small screw holes for M4 screw.

- Using “Edge Alignment Kit-2” on adjacent two displays.

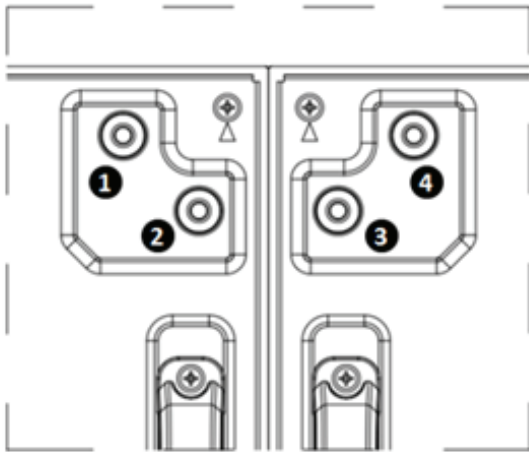

There are two loops of screw holes (outer & inner), depend on the design of each model. (Please check the user manual for [using loop information](#))↵

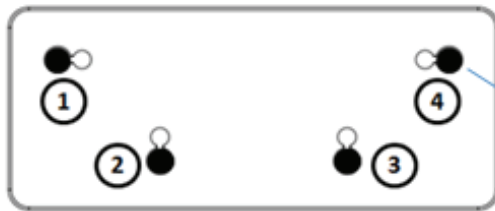

Outer loop: Big screw holes for M6 screw.↵

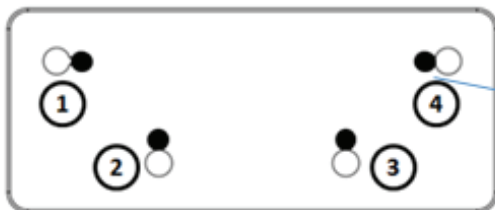

Inner loop: Small screw holes for M4 screw.↵

5. Daisy Chain Monitors

Cable connections

1. Turn off all devices.
2. Connect the first display with the video source (e.g. computer).
3. Connect one end of the cable to the appropriate OUT port on the first display.
4. Connect the other end of the cable to the appropriate IN port on the second display.

Follow Step 2 ~ 3 to connect all displays.

Refer to the user manual of the purchased model for the location of all input and output ports.

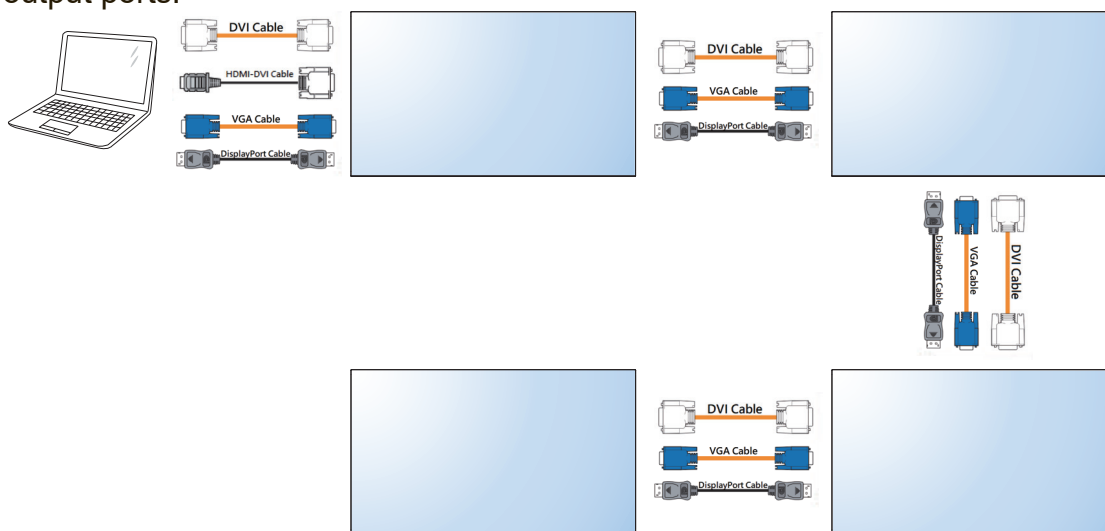

Important Indication

Item	Description
1	Support HDMI Ver. 1.4b
2	DVI cable can't exceed 5M, otherwise, a DVI extender is required
3	HDMI cable can't exceed 5M, otherwise, a HDMI extender is required
4	LAN Cable can't be used to carry video signal directly
5	Signal cable for each PD should be separated from each other, twists cables together is not allowed
6	Device for signal transmission should be ESD protected
7	HDMI used for Video wall should be certificated

Signal Input Requirement

Item	Category	Description
1	VGA Input	<ul style="list-style-type: none"> VGA sync input - TTL level, separate H/V sync only, "+" or "-" polarity, terminated with 2.2k impedance. Video pixel rate: 13.5 MHz to 165 MHz VGA analog RGB level - 0 ~ 700mV linear, positive polarity, terminated with 75 impedance.
2	HDMI Input	<ul style="list-style-type: none"> Compliance with HDMI Specification 1.3 or later, 480i/p, 576i/p, 720p, 1080i/p signal handling capability. TMDS channel: Carries audio, video and auxiliary data. Signaling method: According to HDMI Ver. 1.3b specification. (Type A HDMI). Video pixel rate: 25 MHz to 165 MHz (Type A) Pixel encodings: RGB 4:4:4, YCbCr 4:2:2, YCbCr 4:4:4. Audio sample rates: 32 kHz, 44.1 kHz, 48 kHz, 96kHz, 192 kHz. Audio channels: 2 (Linear PCM) DDC channel: Allows source to interrogate capabilities of sink. I²C signaling with 100 kHz clock. E-EDID data structure according to EIA/CEA-861B and VESA Enhanced EDID. Content protection: According to High-Definition Content Protection (HDCP) Specification 1.10. Power turn on 7sec with picture.
3	DVI Input	Compliance with DVI Specification 1.0 and supports copy protection (HDCP)
4	I ² C DDC signal	DDC2B required, DDC serial Data & Clock, DDC components are connected to both display Vcc and DDC +5V (from PC via video cable), that the PC can read the DDC data also when the display is powered off.
5	Audio Input	Sensitivity 500mVrms, the amplifier outputs full power when the input level reaches 500mVrms, terminated with impedance >10k
6	CVBS Input	1000mVpp (including 300 mV sync level), terminated with input impedance of 75(Share with Comp-Y BNC connector.)
7	Component video input	Y: 1000mVpp, PbPr: ±350mVpp, terminated with input impedance of 75. 480i/p, 576i/p, 720p, 1080i/p signal handling capability

8	No Signal Input	While no signal at external inputs, screen will display no signal .
9	USB Input	Only Supply USB Flash@5V +-5%/500mA. Supported media format please refer short spec.
10	RJ45/LAN	Support LAN control & DLNA.PC WMP share from LAN display to monitor

6. Control Connection

IR daisy-chain connection

1. Connect all displays using the IR cables.
2. Connect the supplied IR extender to the IR-IN at the back of the first display.
3. Aim the supplied remote control at the IR extender just connected within the motion range.
4. Now you are ready to control all displays using the remote control. Refer to the user manual of the purchased model for the operation of remote control.

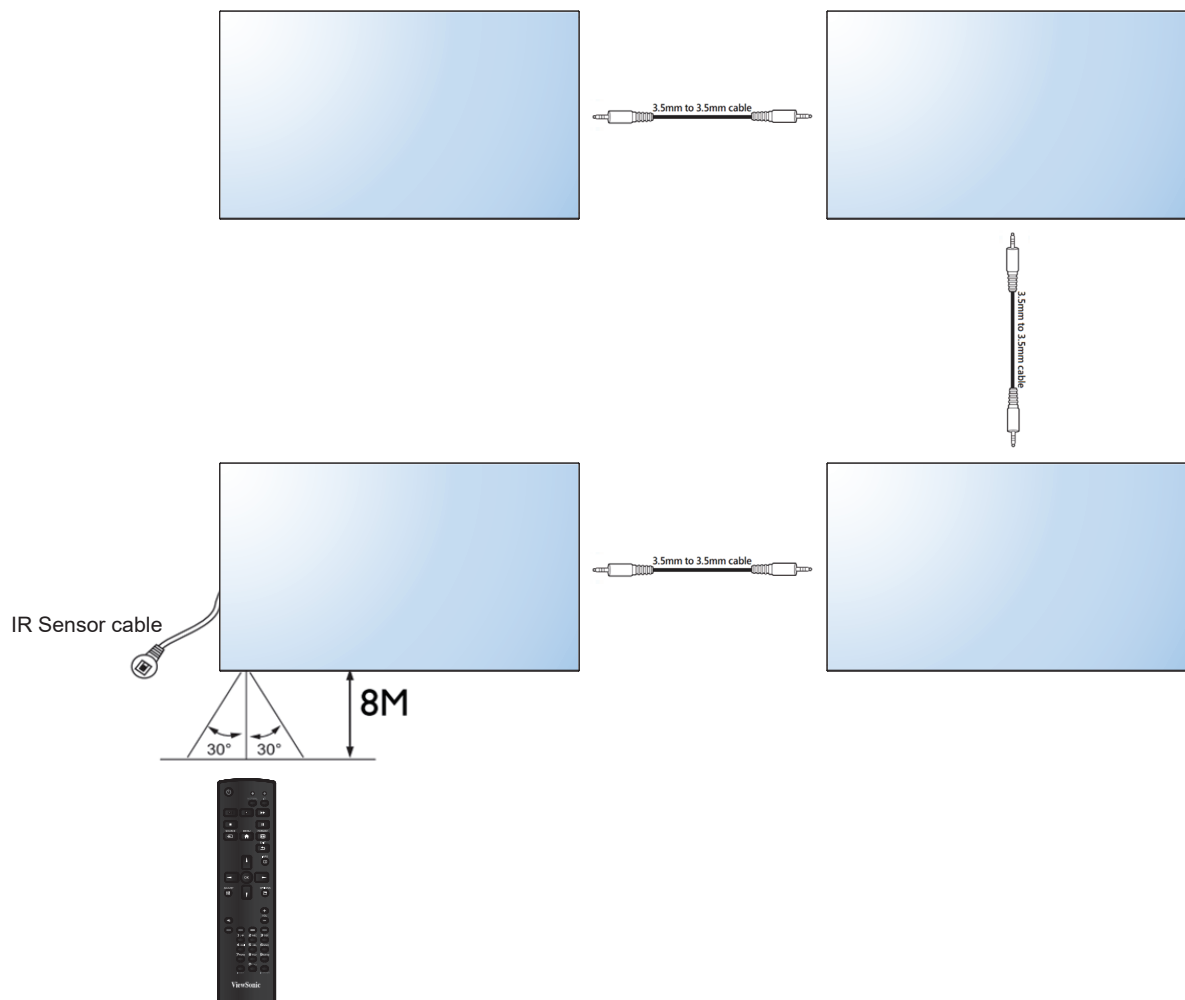

RS232 daisy-chain connection

1. Make sure the ID number has been set for each display.
2. Connect the computer to a display using a RS-232C serial null modem cable.
3. Connect all displays using the RS-232C serial null modem cables.
4. Go to Setting > Control Setting each display. Select RS-232C.
5. Refer to the RS-232 protocol document.

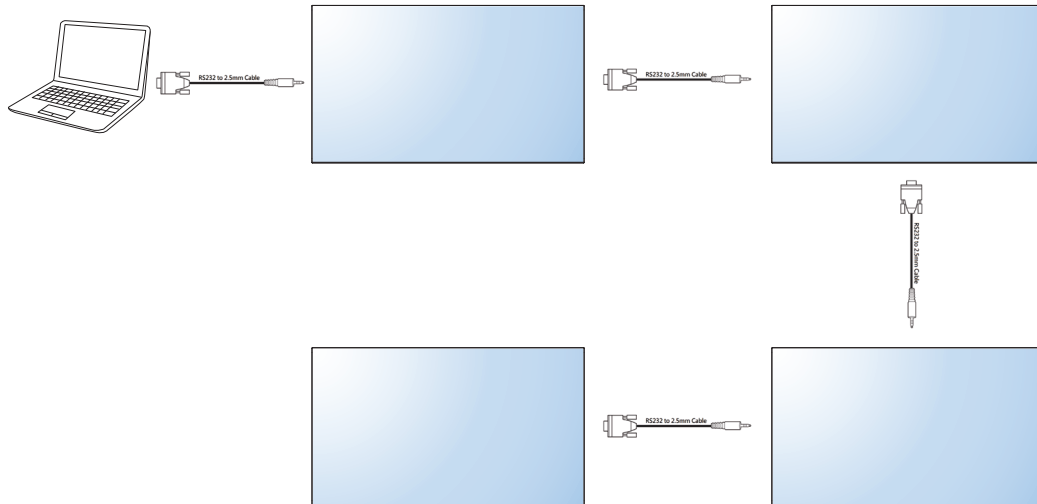

LAN connection

1. Connect the computer to a LAN switch or hub using a RJ45 cable.
2. Connect all displays separately to the same LAN switch or hub just connected with your computer using RJ45 cables. Now the computer and all displays are within the same local area network.
3. Make sure the network connection is enabled.
4. Go to Setting > Control Setting each display. Select LAN. Refer to the user manual of the purchased model for the detailed settings and the operation of LAN control.

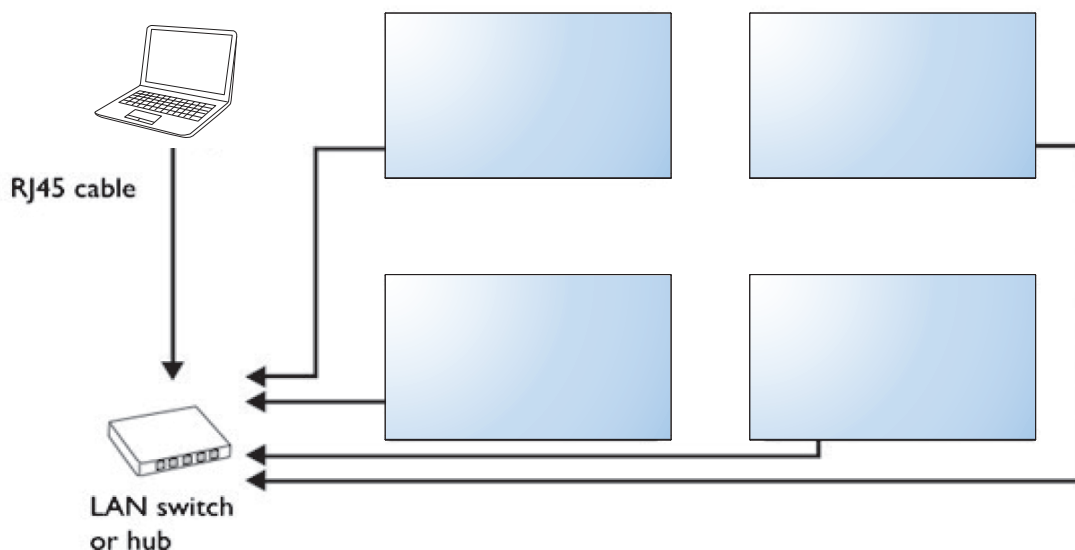

Control Indication

Item	Category	Description
1	RS-232 Protocol	Command through RS-232 or LAN should be compliance with the requirement enclosed. Please refer RS232 spec.
2	LAN Protocol	
3	External communication (RS232)	<ul style="list-style-type: none">• Its default settings as follow: Baud Rate : 9600 Data bits: 8 Parity : None Stop Bit : 1 Flow Control : None• Timing between each message should be a minimum of 500 ms

7. Setting the Tile Mode

Tiling Mode

In Tile Mode you can view an image in a larger scale by connecting multiple monitors.

After all the displays are installed properly to a video wall, you need set the position of each display to determine how to display the input image.

Without setting the display position, each display outputs the complete picture independently.

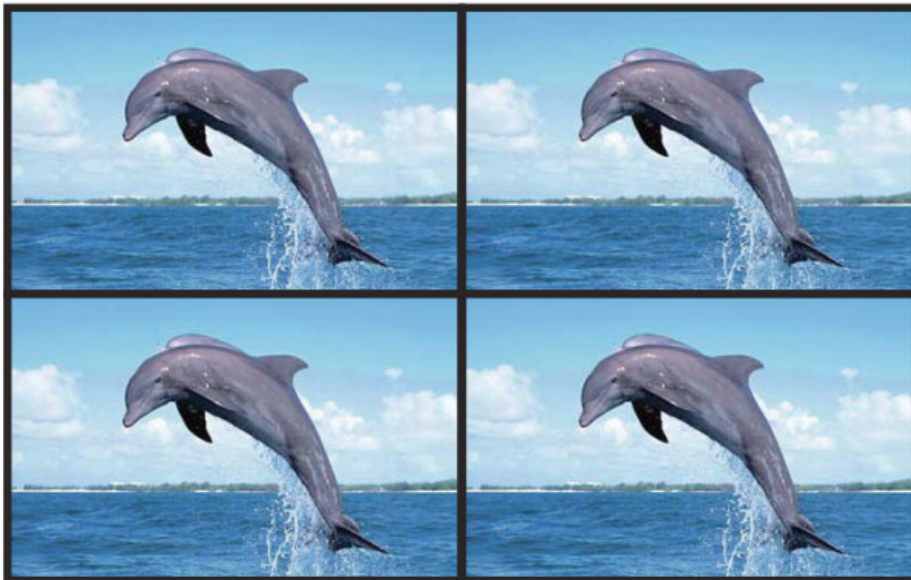

Once the position is set, the video source (e.g. computer) identifies the number of connected displays and transfer part of the picture to each display accordingly. The video wall then outputs one picture as a whole.

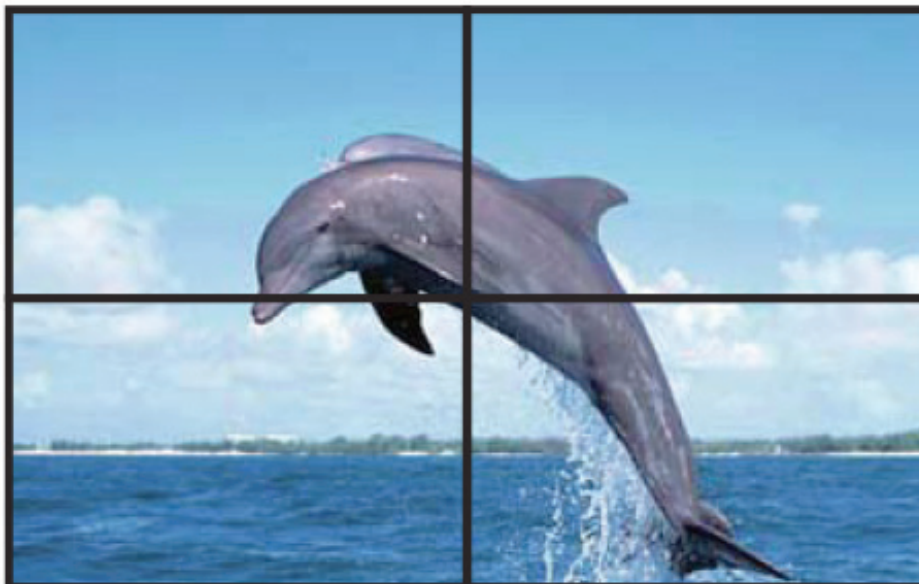

If you prefer to show different pictures on the displays of the video wall, you will need to have independent video source for each display.

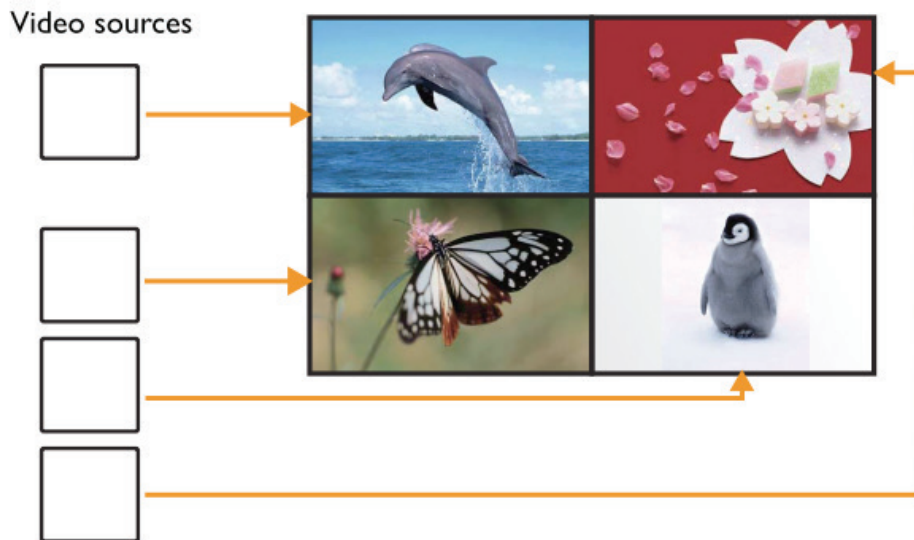

Note: Though the video sources vary, you can still manage all displays via remote control, RS-232 commands, or LAN control in this case.

Set tiling mode in OSD

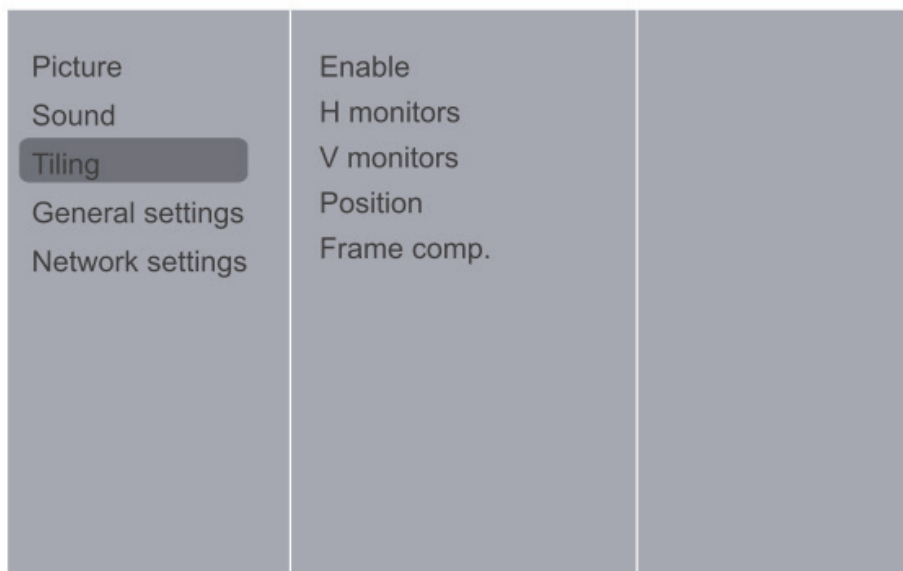

Enable

Choose to {On} or {Off} the Tiling function. If {On}, the display will apply the settings in {H monitors}, {V monitors}, {Position}, and {Frame comp.}.

H monitors/V monitors

Adjust displays on the horizontal/vertical side.

In landscape mode:

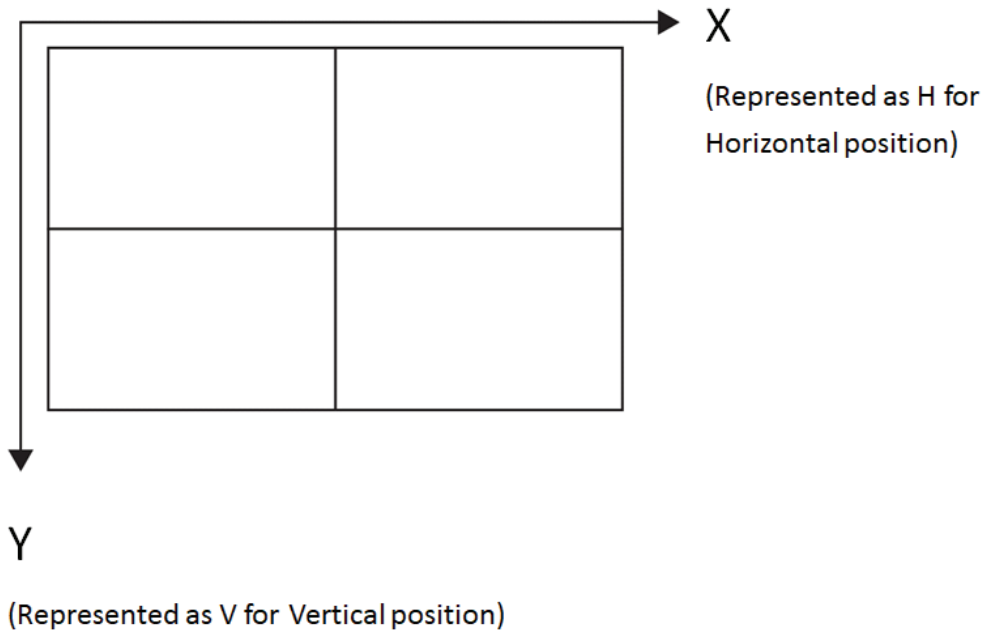

In portrait mode:

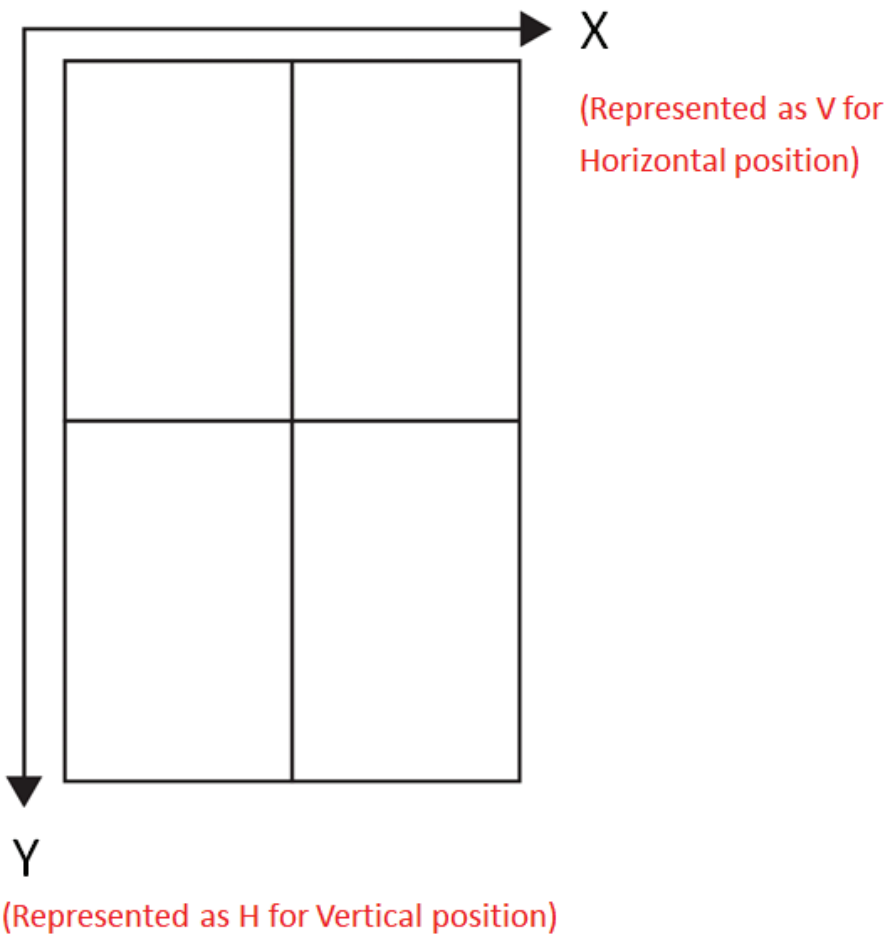

Position (Monitor ID will be set in sync with position)

Adjust the position of this display in the screen matrix.

Different video wall layouts and display position setup in landscape mode:

The position is starting from the top left of the video wall, the number increases as it goes down or goes to the right.

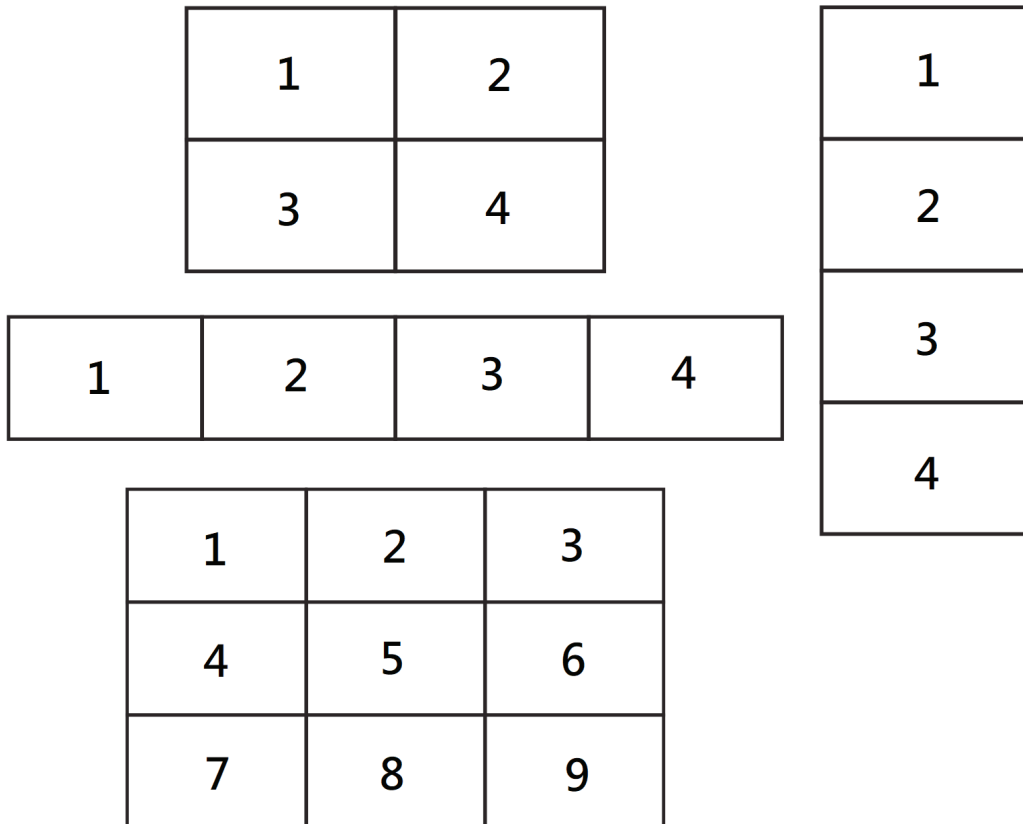

Different video wall layouts and display position setup in portrait mode:

The position is starting from the bottom left of the video wall, the number increases as it goes up or goes to the right.

2	4
1	3

1	2	3	4
---	---	---	---

3	6	9
2	5	8
1	4	7

Frame Comp.

Choose to turn the frame compensation function on or off. If turned on, the display will adjust the image to compensate for the width of the display bezels in order to accurately display the image.

8. Other OSD Setting

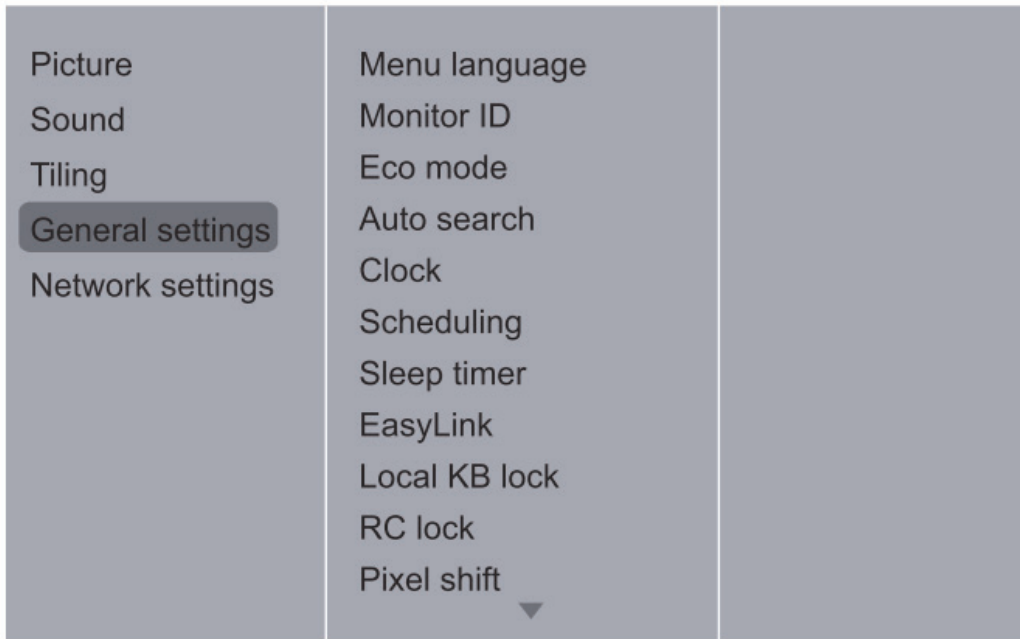

Frame Comp.

Choose to turn the frame compensation function on or off. If turned on, the display will adjust the image to compensate for the width of the display bezels in order to accurately display the image.

Eco Mode

Set the Eco mode to Normal if you need to power ON/OFF via LAN control.

APM

Set the APM to OFF if you don't need automatic turn-off display when no signal after a while.

Switch On State

Choose the display status used for the next time you connect the power cord.

- Set to **ON** the display will turn on when the power cord is connected to a wall outlet.
- Set to **STANDBY** the display will remain Standby when the power cord is connected to a wall outlet.
- Set to **LAST STATUS** the display will return to the previous power status (on/off/standby) when removing and replacing the power cord.

9. Color Calibration for Video Wall

A software program that enhances the image uniformity of all displays in a video wall application. You can also adjust color settings of each display easily on a host computer.

Refer to the color calibration user manual (VideoWallCalibration_UG_ENG) for more detail.



ViewSonic®