

ViewSonic®



EP5542/EP5542T Multimedia Digital Poster User Guide

IMPORTANT: Please read this User Guide to obtain important information on installing and using your product in a safe manner, as well as registering your product for future service. Warranty information contained in this User Guide will describe your limited coverage from ViewSonic Corporation, which is also found on our web site at <http://www.viewsonic.com> in English, or in specific languages using the Regional selection box in the upper right corner of our website. "Antes de operar su equipo lea cuidadosamente las instrucciones en este manual"

Model No.: VS18153

Thank you for choosing ViewSonic

As a world leading provider of visual solutions, ViewSonic is dedicated to exceeding the world's expectations for technological evolution, innovation, and simplicity. At ViewSonic, we believe that our products have the potential to make a positive impact in the world, and we are confident that the ViewSonic product you have chosen will serve you well.

Once again, thank you for choosing ViewSonic !



Compliance Information

NOTE: This section addresses all connected requirements and statements regarding regulations. Confirmed corresponding applications shall refer to nameplate labels and relevant markings on unit.

FCC Statement

This device complies with Part 15 of the FCC Rules. Operation is subject to the following two conditions: (1) this device may not cause harmful interference, and (2) this device must accept any interference received, including interference that may cause undesired operation.

NOTE: This equipment has been tested and found to comply with the limits for a Class A/ Class B digital device, pursuant to Part 15 of the FCC Rules. These limits are designed to provide reasonable protection against harmful interference when the equipment is operated in a commercial environment. This equipment generates, uses, and can radiate radio frequency energy and, if not installed and used in accordance with the instructions, may cause harmful interference to radio communications. Operation of this equipment in a residential area is likely to cause harmful interference in which case the user will be required to correct the interference at his/her own expense.

- Reorient or relocate the receiving antenna.
- Increase the separation between the equipment and receiver.
- Connect the equipment into an outlet on a circuit different from that to which the receiver is connected.
- Consult the dealer or an experienced radio/TV technician for help.

Warning: To comply with the limits for the Class A/Class B digital device, pursuant to Part 15 of the FCC Rules, this device must be installed in computer equipment certified to comply with the Class A/Class B limits. All cables used to connect the computer and peripherals must be shielded and grounded. Operation with non-certified computers or non-shielded cables may result in interference to radio or television reception. Changes and modifications not expressly approved by the manufacturer could void the user's authority to operate this equipment.

For Canada

CAN ICES-3 (A/B)/NMB-3(A/B)

CE Conformity for European Countries

 The device complies with the EMC Directive 2014/30/EU and Low Voltage Directive 2014/35/EU.

Following information is only for EU-member states:

The mark shown to the right is in compliance with the Waste Electrical and Electronic Equipment Directive 2012/19/EU (WEEE).

The mark indicates the requirement NOT to dispose of the equipment as unsorted municipal waste, but use the return and collection systems according to local law.

If the batteries, accumulators and button cells included with this equipment, display the chemical symbol Hg, Cd, or Pb, then it means that the battery has a heavy metal content of more than 0.0005% Mercury or more than, 0.002% Cadmium, or more than 0.004% Lead.



Industry Canada Notice

This device complies with Canadian RSS-210. To prevent radio interference to the licensed service, this device is intended to be operated indoors and away from windows to provide maximum shielding. Equipment (or its transmitting antenna) that is installed outdoors is subject to licensing. The installer of this radio equipment must ensure that the antenna is located or pointed such that it does not emit RF field in excess of Health Canada limits for the general population; consult Safety Code 6, obtainable from Health Canada's website www.hc-sc.gc.ca/rpb.

R&TTE Compliance Statement

This device complies with the Essential Requirements of the R&TTE Directive of the European Union (1999/5/EC). This equipment meets the following conformance standards:

ETSI EN 300 328

EN 301 489-01

EN 301 489-17

EN 62311

Notified Countries: Germany, UK, Netherlands, Belgium, Sweden, Denmark, Finland, France, Italy, Spain, Austria, Ireland, Portugal, Greece, Luxembourg, Estonia, Latvia, Lithuania, Czech Republic, Slovakia, Slovenia, Hungary, Poland and Malta.

Declaration of RoHS2 Compliance

This product has been designed and manufactured in compliance with Directive 2011/65/EU of the European Parliament and the Council on restriction of the use of certain hazardous substances in electrical and electronic equipment (RoHS2 Directive) and is deemed to comply with the maximum concentration values issued by the European Technical Adaptation Committee (TAC) as shown below:

Substance	Proposed Maximum Concentration	Actual Concentration
Lead (Pb)	0.1%	< 0.1%
Mercury (Hg)	0.1%	< 0.1%
Cadmium (Cd)	0.01%	< 0.01%
Hexavalent Chromium (Cr ⁶⁺)	0.1%	< 0.1%
Polybrominated biphenyls (PBB)	0.1%	< 0.1%
Polybrominated diphenyl ethers (PBDE)	0.1%	< 0.1%
Bis (2-ethylhexyl) phthalate (DEHP)	0.1%	< 0.1%
Butyl benzyl phthalate (BBP)	0.1%	< 0.1%
Dibutyl phthalate (DBP)	0.1%	< 0.1%
Diisobutyl phthalate (DIBP)	0.1%	< 0.1%

Certain components of products as stated above are exempted under the Annex III of the RoHS2 Directives as noted below:

Examples of exempted components are:

1. Mercury in cold cathode fluorescent lamps and external electrode fluorescent lamps (CCFL and EEFL) for special purposes not exceeding (per lamp):
 - (1) Short length (≤ 500 mm): maximum 3.5 mg per lamp.
 - (2) Medium length (> 500 mm and $\leq 1,500$ mm): maximum 5 mg per lamp.
 - (3) Long length ($> 1,500$ mm): maximum 13 mg per lamp.
2. Lead in glass of cathode ray tubes.
3. Lead in glass of fluorescent tubes not exceeding 0.2% by weight.
4. Lead as an alloying element in aluminium containing up to 0.4% lead by weight.
5. Copper alloy containing up to 4% lead by weight.
6. Lead in high melting temperature type solders (i.e. lead-based alloys containing 85% by weight or more lead).
7. Electrical and electronic components containing lead in a glass or ceramic other than dielectric ceramic in capacitors, e.g. piezoelectronic devices, or in a glass or ceramic matrix compound.

Safety Precautions

FOR OPTIMUM PERFORMANCE, PLEASE NOTE THE FOLLOWING WHEN SETTING UP AND USING THE LCD COLOR MONITOR:

- DO NOT REMOVE MONITOR BACK COVER. There are no user serviceable parts inside and opening or removing covers may expose you to dangerous shock hazards or other risks. Refer all servicing to qualified service personnel.
- Do not spill any liquids into the cabinet or use your monitor near water.
- Do not insert objects of any kind into the cabinet slots, as they may touch dangerous voltage points, which can be harmful or fatal or may cause electric shock, fire or equipment failure.
- Do not place any heavy objects on the power cord. Damage to the cord may cause shock or fire.
- Do not place this product on a sloping or unstable cart, stand or table, as the monitor may fall, causing serious damage to the monitor.
- Do not place any objects onto the monitor and do not use the monitor outdoors.
- The inside of the fluorescent tube located within the LCD monitor contains mercury. Please follow the laws or rules of your municipality to dispose of the tube properly.
- Do not bend power cord.
- Do not use monitor in high temperature, humid, dusty, or oily areas.
- If monitor or glass is broken, do not come in contact with the liquid crystal and handle with care.
- Allow adequate ventilation around the monitor, so that heat can properly dissipate. Do not block ventilated openings or place the monitor near a radiator or other heat sources. Do not put anything on top of the monitor.
- The power cable connector is the primary means of detaching the system from the power supply. The monitor should be installed close to a power outlet, which is easily accessible.
- Handle with care when transporting. Save packaging for transporting.
- Please clean the holes of back cabinet to reject dirt and dust at least once a year because of set reliability.
- If using the cooling fan continuously, it's recommended to wipe holes a minimum of once a month.
- When installing the remote control batteries;
 - Align the batteries according to the (+) and (-) indications inside the case.
 - Align the (-) indication of the battery first inside the case.

WARNING:

Usage of other than specified head- or earphones can result in hearing loss due to excessive sound pressures.

CAUTION:

Immediately unplug your monitor from the wall outlet and refer servicing to qualified service personnel under the following conditions:

- When the power supply cord or plug is damaged.
- If liquid has been spilled, or objects have fallen into the monitor.
- If the monitor has been exposed to rain or water.
- If the monitor has been dropped or the cabinet damaged.
- If the monitor does not operate normally by following operating instructions.

Recommended Use**CAUTION:**

- For optimum performance, allow 20 minutes for warm-up.
- Rest your eyes periodically by focusing on an object at least 5 feet away. Blink often.
- Position the monitor at a 90° angle to windows and other light sources to minimize glare and reflections.
- Clean the LCD monitor surface with a lint-free, nonabrasive cloth. Avoid using any cleaning solution or glass cleaner!
- Adjust the monitor's brightness, contrast and sharpness controls to enhance readability.
- Avoid displaying fixed patterns on the monitor for long periods of time to avoid image persistence (after image effects).
- Get regular eye checkups.

Ergonomics

To realize the maximum ergonomic benefits, we recommend the following:

- Use the preset Size and Position controls with standard signals.
- Use the preset Color Setting.
- Use non-interlaced signals.
- Do not use primary color blue on a dark background, as it is difficult to see and may produce eye fatigue due to insufficient contrast.

Table Of Contents

1. Getting Started	1
1.1. Package Contents.....	1
1.2. Fastening the poster	1
2. Parts and Functions	4
2.1. Remote Control	4
2.1.1. Installing remote control Batteries	5
2.1.2. Aiming the remote control	5
3. Connections	6
4. Basic Operations	7
4.1. Turn on the display.....	7
4.2. First initiation	7
4.3. Home Menu Overview.....	8
5. System Settings	9
5.1. Home Menu Overview.....	10
5.2. Home Menu Overview.....	11
6. File Explorer	12
7. Menu List	14
8. Using Auto Play	16
9. Using USB multi media player	17
9.1. Playing Photo	18
9.2. Playing Music.....	19
9.3. Playing Movie.....	20
10. Supported media files format	21
11. Troubleshooting	24
12. Specifications	25
13. Other Information	26
Customer Support.....	26
Limited Warranty	27
Mexico Limited Warranty	29

Copyright Information

Copyright © ViewSonic Corporation, 2020. All rights reserved.

ViewSonic® and the three birds logo are registered trademarks of ViewSonic Corporation.

ENERGY STAR® is a registered trademark of the U.S. Environmental Protection Agency (EPA). As an ENERGY STAR® partner, ViewSonic Corporation has determined that this product meets the ENERGY STAR® guidelines for energy efficiency.

Disclaimer: ViewSonic Corporation shall not be liable for technical or editorial errors or omissions contained herein; nor for incidental or consequential damages resulting from furnishing this material, or the performance or use of this product.

In the interest of continuing product improvement, ViewSonic Corporation reserves the right to change product specifications without notice. Information in this document may change without notice.

No part of this document may be copied, reproduced, or transmitted by any means, for any purpose without prior written permission from ViewSonic Corporation.

Product Registration

To meet your future needs, and to receive any additional product information as it becomes available, please register your product on the Internet at: www.viewsonic.com.

The ViewSonic® Wizard CD-ROM also provides an opportunity for you to print the registration form, which you may mail or fax to ViewSonic.

For Your Records

Product Name:	EP5542/EP5542T ViewSonic Multimedia Digital Poster
Model Number:	VS17520
Document Number:	EP5542/EP5542T_UG_ENG_1a_20200520
Serial Number:	_____
Purchase Date:	_____

Product disposal at end of product life

ViewSonic respects the environment and is committed to working and living green. Thank you for being part of Smarter, Greener Computing.

Please visit ViewSonic website to learn more.

USA & Canada: <http://www.viewsonic.com/company/green/recycle-program/>

Europe: <http://www.viewsoniceurope.com/eu/support/call-desk/>

Taiwan: <https://recycle.epa.gov.tw/>

1. Getting Started

1.1. Package Contents

The following items are included in your product box.

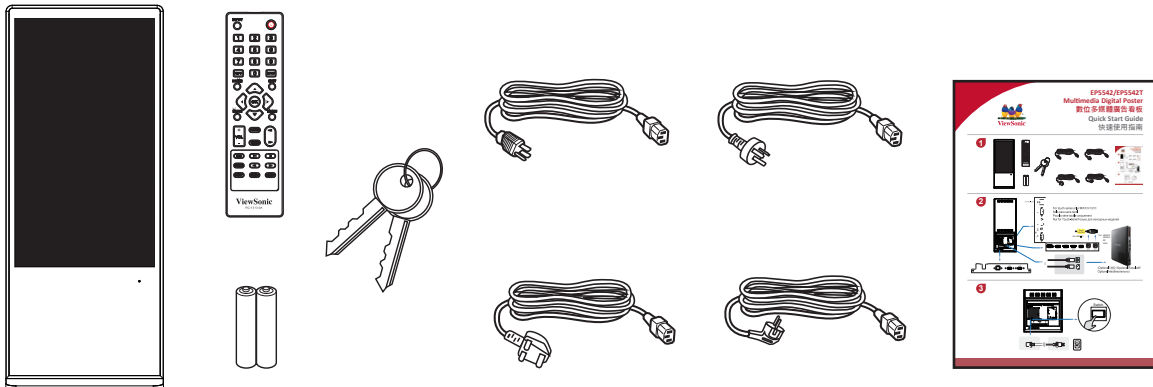

NOTE: The illustrations may differ slightly from the items shipped with your product.

1.2. Fastening the poster

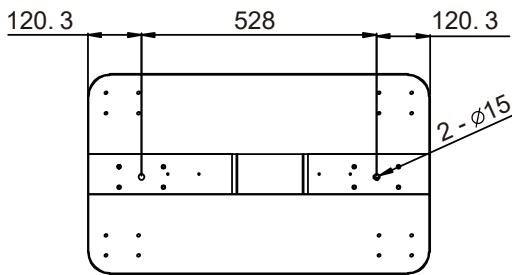

As illustrated in figure, positioning 2 holes on the earth and drill the holes at the corresponding position. The diameter of the hole on the earth should be smaller than the diameter of the screw. Fit the two fastening screws, fastening the Poster to earth.

NOTES:

1. The appearance of this product in these illustrations may differ from your actual product, and is for comparative purposes only.
2. We may change the design and specifications without notice.

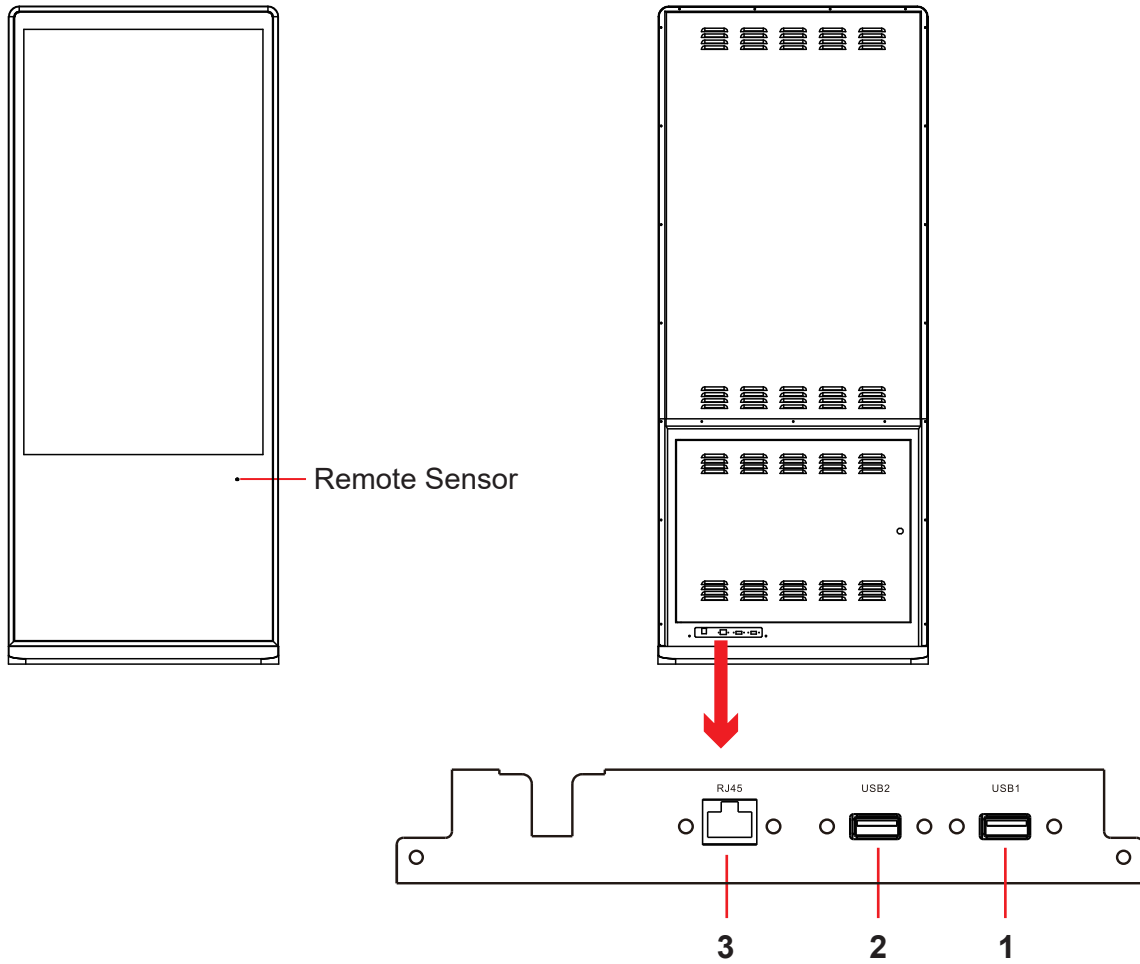

1. USB 1 (DC 5.0V/0.5A)

USB for the poster. This USB port can't not use for FW update.

2. USB 2 (DC 5.0V/0.5A)

USB for the poster. This USB port can't not use for FW update.

3. RJ45

Enable connection to cable and log on to Internet.

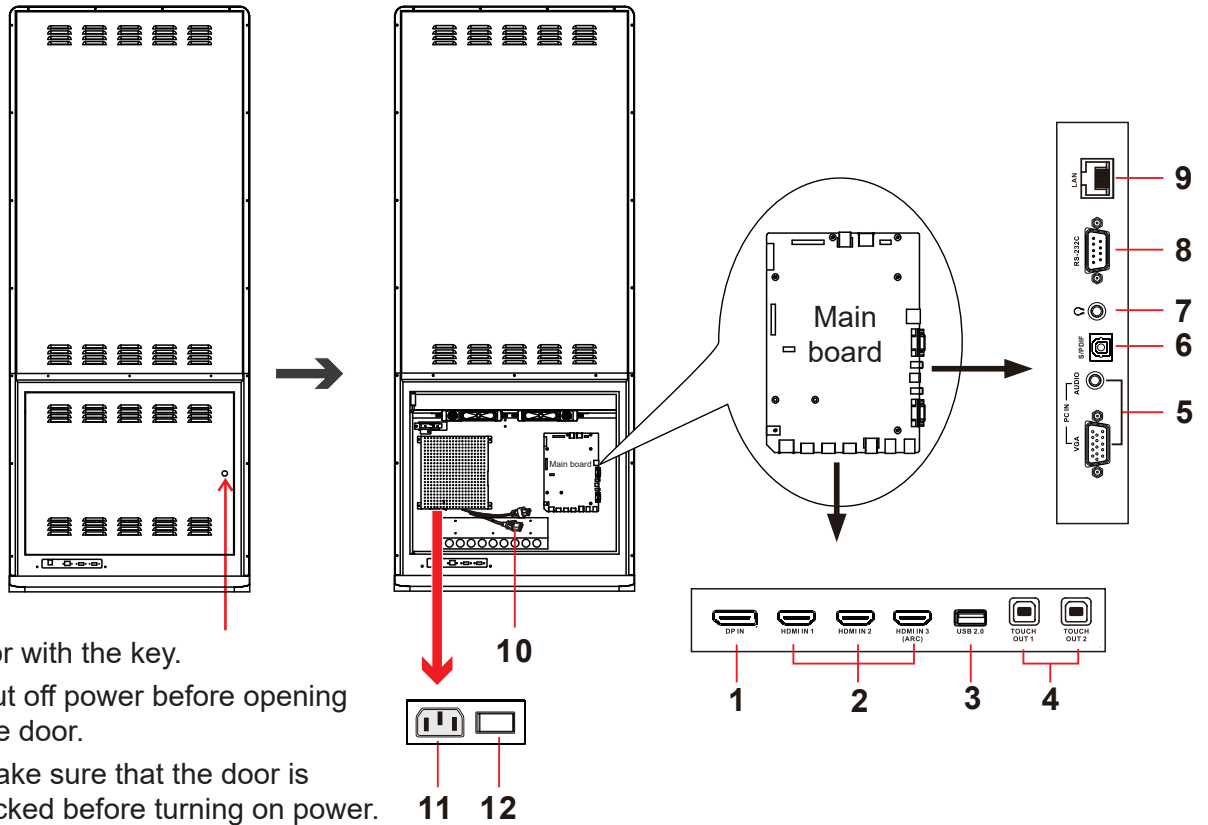

Open the door with the key.

- NOTE:** 1. Cut off power before opening the door.
 2. Make sure that the door is locked before turning on power.

1. DP(DisplayPort) INPUT

Connect an external device to DP out jack.

2. HDMI1/2/3 Input

To connect with those equipments with HDMI or DVI interface.

HDMI 3(ARC): Connect an ARC-enabled home theater receiver to this jack.

3. USB 2.0

Connect USB devices to this port for Android.

NOTE: It must be used if you upgrade software.

4. TOUCH OUT1/2

Connect an external device to support touch control of the external device on the Poster.

NOTE: Touch out 1 corresponds to the HDMI 1, Touch out 2 corresponds to the HDMI 2,HDMI3, DP or VGA.

5. PC IN

Enable connection to PC or other external devices with VGA/AUDIO ports.

6. S/PDIF digital audio output

Connect a digital sound system to this jack.

7. Ⓚ

Connect headphones to this jack. The Poster is the current audio output.

8. RS-232

For remote control, service and other uses.

9. RJ45 (LAN IN)

Enable connection to cable and log on to Internet.

10. AC OUT

Only use one power supply, ~100-240V 50Hz/60Hz, Current Max. : 0.65A.

11. AC IN

Plug the AC cord into this jack and into a power outlet.(~100-240V 50Hz/60Hz).

12. Power Switch

Push to (1) to connect the power, push to (O) to cut off.

NOTE: Power switch can not be covered, and should keep the power switch can be conveniently operated.

2. Parts and Functions

2.1. Remote Control

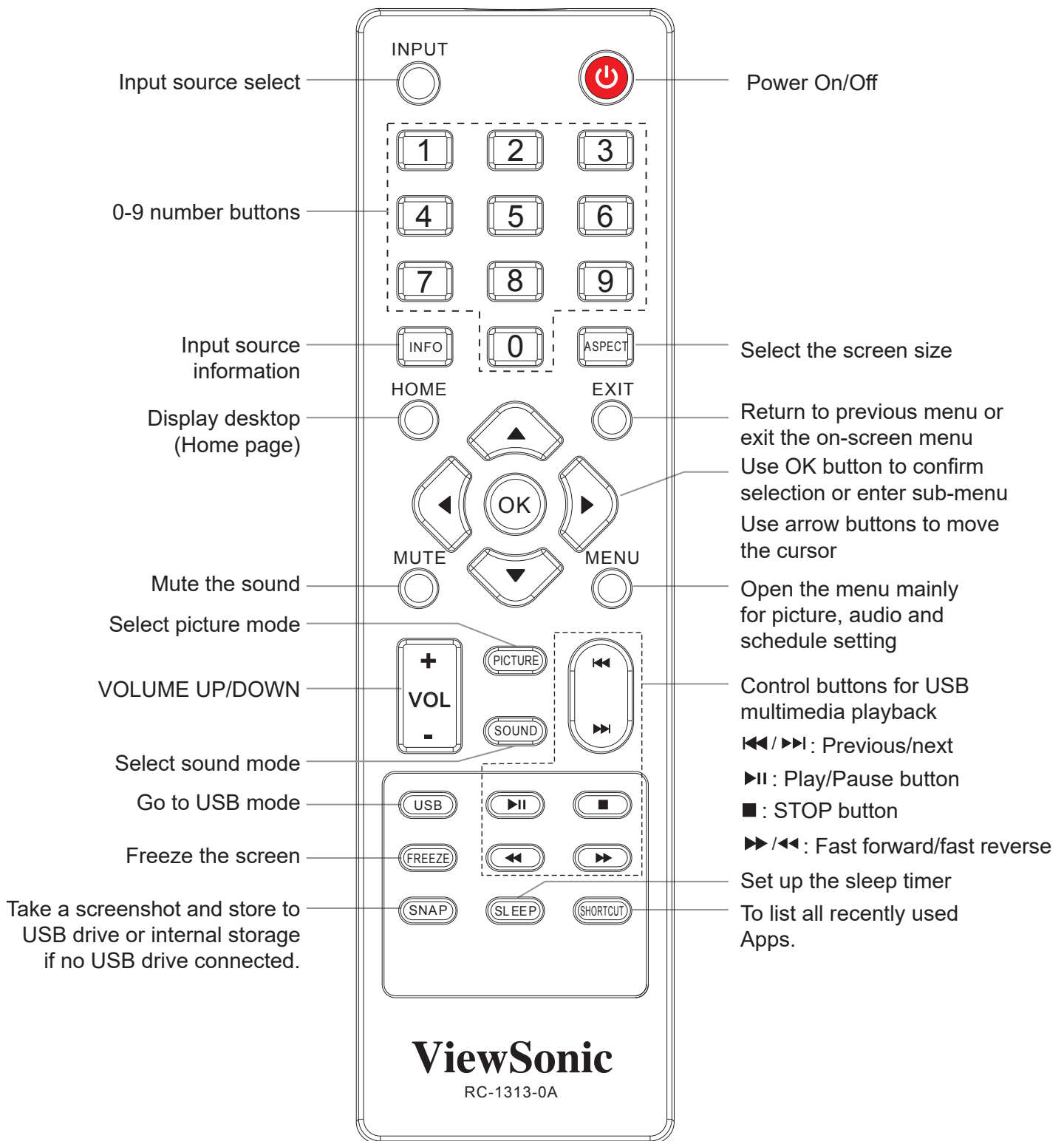

Notes:

- For touch model, some functions could be performed through touch directly instead of remote control.

2.1.1. Installing remote control Batteries

To install remote control batteries:

1. Open the battery cover.
2. Insert two AAA batteries into the battery compartment. Make sure that the + and – symbols on the batteries match the + and – symbols in the battery compartment.
3. Replace the cover.

Battery precautions:

Improper use of batteries can result in a leakage of chemicals and/or explosion. Be sure to follow the instructions below.

- Place batteries with their terminals corresponding to the (+) and (–) indications.
- Different types of batteries have different characteristics. Do not mix batteries of different types.
- Do not mix old and new batteries. Mixing old and new batteries can shorten the life of new batteries and/or cause old batteries to leak chemicals.
- Remove batteries as soon as they are non-operable. Chemicals that leak from batteries can cause a rash. If chemical leakage is found, wipe with a cloth.
- Dispose of batteries in a proper manner.
- If the remote control is not used for an extended period of time, remove the batteries.
- The batteries shall not be exposed to excessive heat such as sunshine, fire or the like.

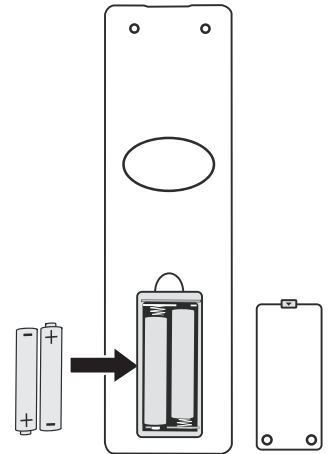

2.1.2. Aiming the remote control

Use the remote control by pointing it towards the remote sensor on the front of your display. Objects between the remote control and the remote sensor may prevent proper operation.

Cautions regarding use of remote control

- Do not expose the remote control to shock. In addition, do not expose the remote control to liquids, and do not place in an area with high humidity.
- Do not install or place the remote control under direct sunlight. The heat may cause deformation of the unit.
- The remote control may not work properly if the remote sensor window of the main unit is under direct sunlight or strong lighting. In such a case, change the angle of the lighting or the display set, or operate the remote control closer to the remote sensor window.

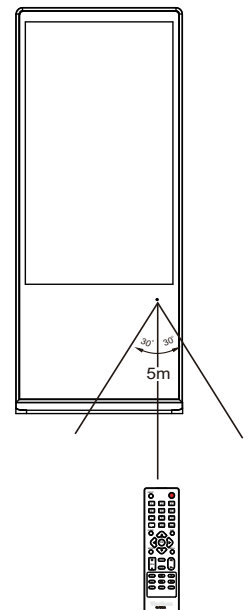

3. Connections

- Turn off the display and connected device.
- Check the plug type at the ends of cables.
- Make sure the fastened connection.

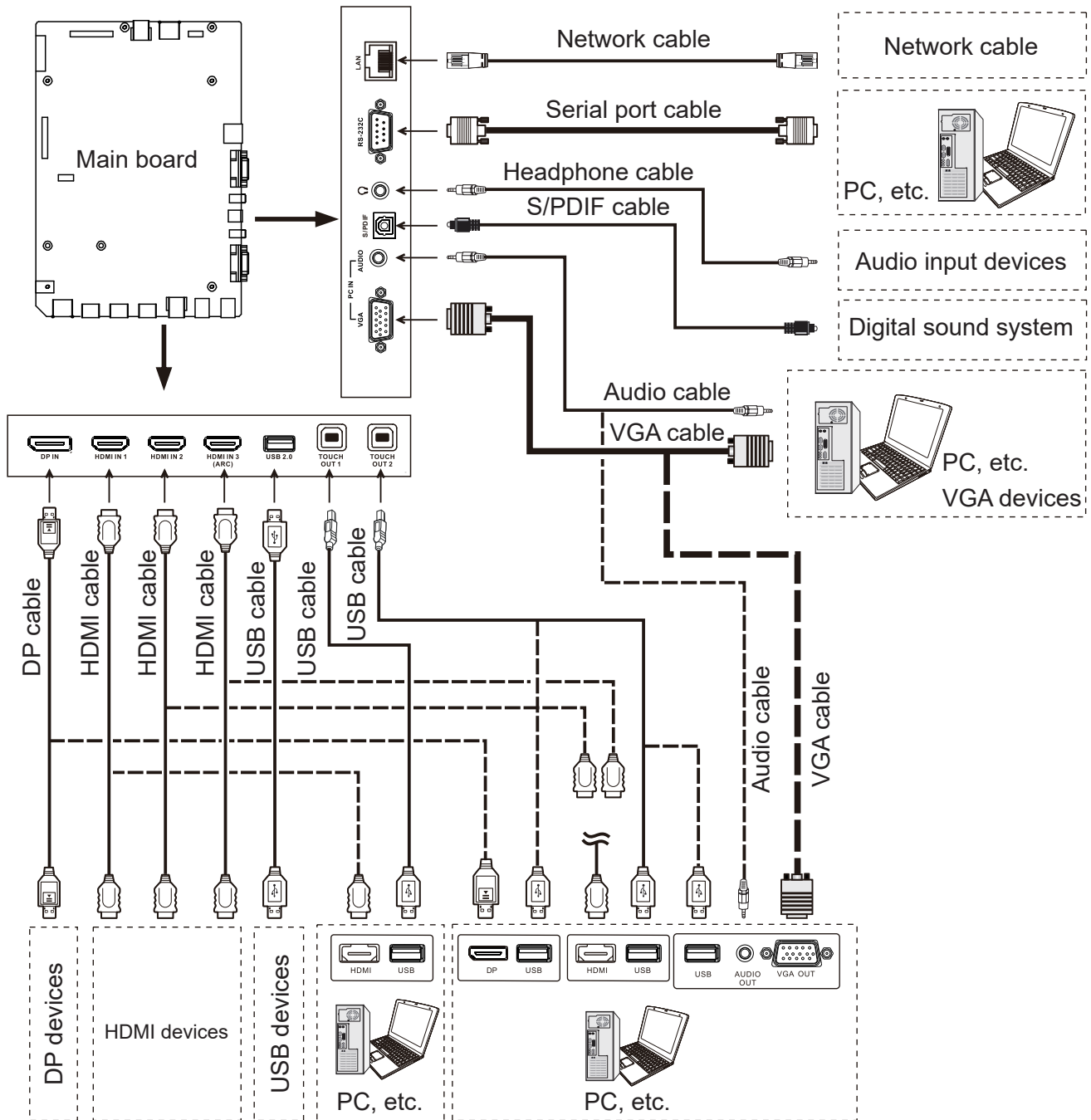

NOTE: Before using headphones, adjust the device volume so as to avoid excessive levels, as hearing damage may result.

Connect TOUCH OUT with USB cable to PC USB port.

Connect PC with VGA cable, HDMI cable or DP cable. Please choose the proper method of connection based on your device. (Only for PC, HDMI, DP signal)

Touch out 1 corresponds to the HDMI 1, Touch out 2 corresponds to the HDMI 2, HDMI3, DP or VGA.

NOTE: After installation of the driver, it can control the external computer by native touch control.

4. Basic Operations

4.1. Turn on the display

Plug the power cord and turn on the AC **Power Switch**.

4.2. First initiation

The following installation menu will pop up for first-time power on.

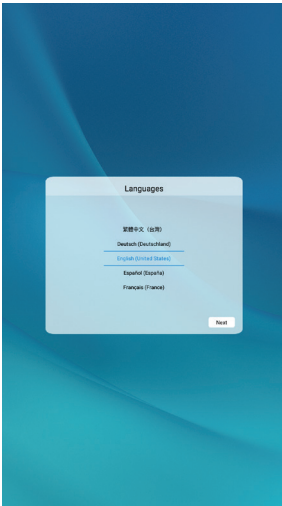

Select desired menu language.
Press **Next** to go to the next page.

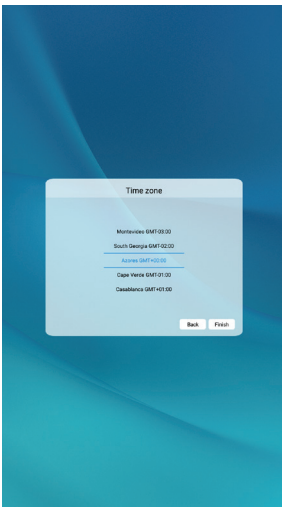

Select your Time Zone, press **Finish** to finish the installation.

4.3. Home Menu Overview

1. Press **HOME** button to show desktop menu.
2. Use arrow and **OK** button for desired selection.
3. Press **EXIT** button to leave.

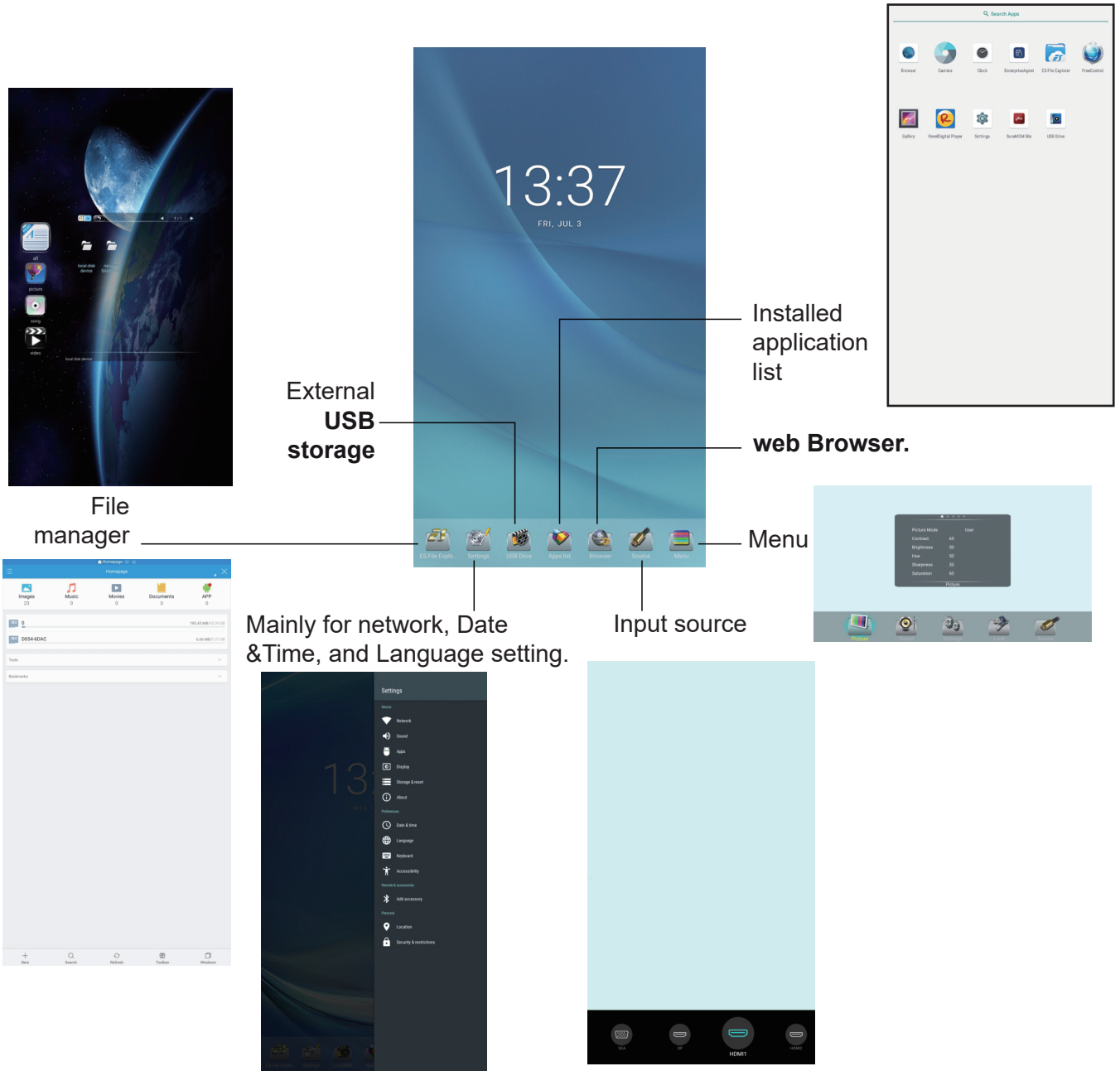

5. System Settings

1. Press ▲▼◀▶ button to select desktop menu option, press **OK** to confirm.
2. Press **EXIT** button to return to previous menu or exit the menu.

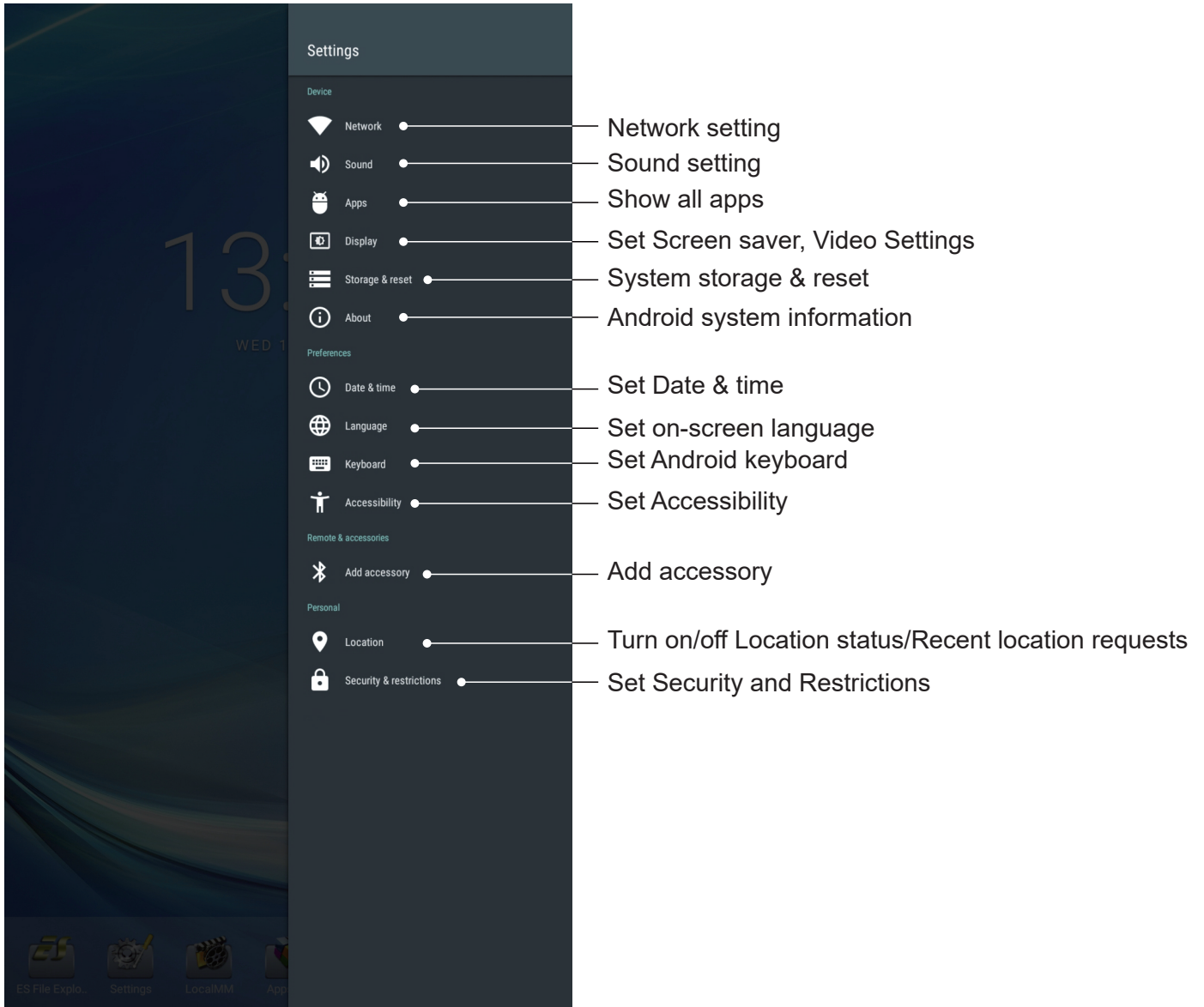
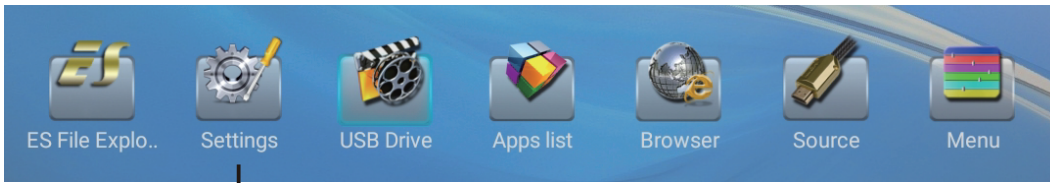

5.1. Home Menu Overview

1. Press ▲▼◀▶ button to select desktop menu option, press **OK** to confirm.
2. Press **EXIT** button to return to previous menu or exit the menu.

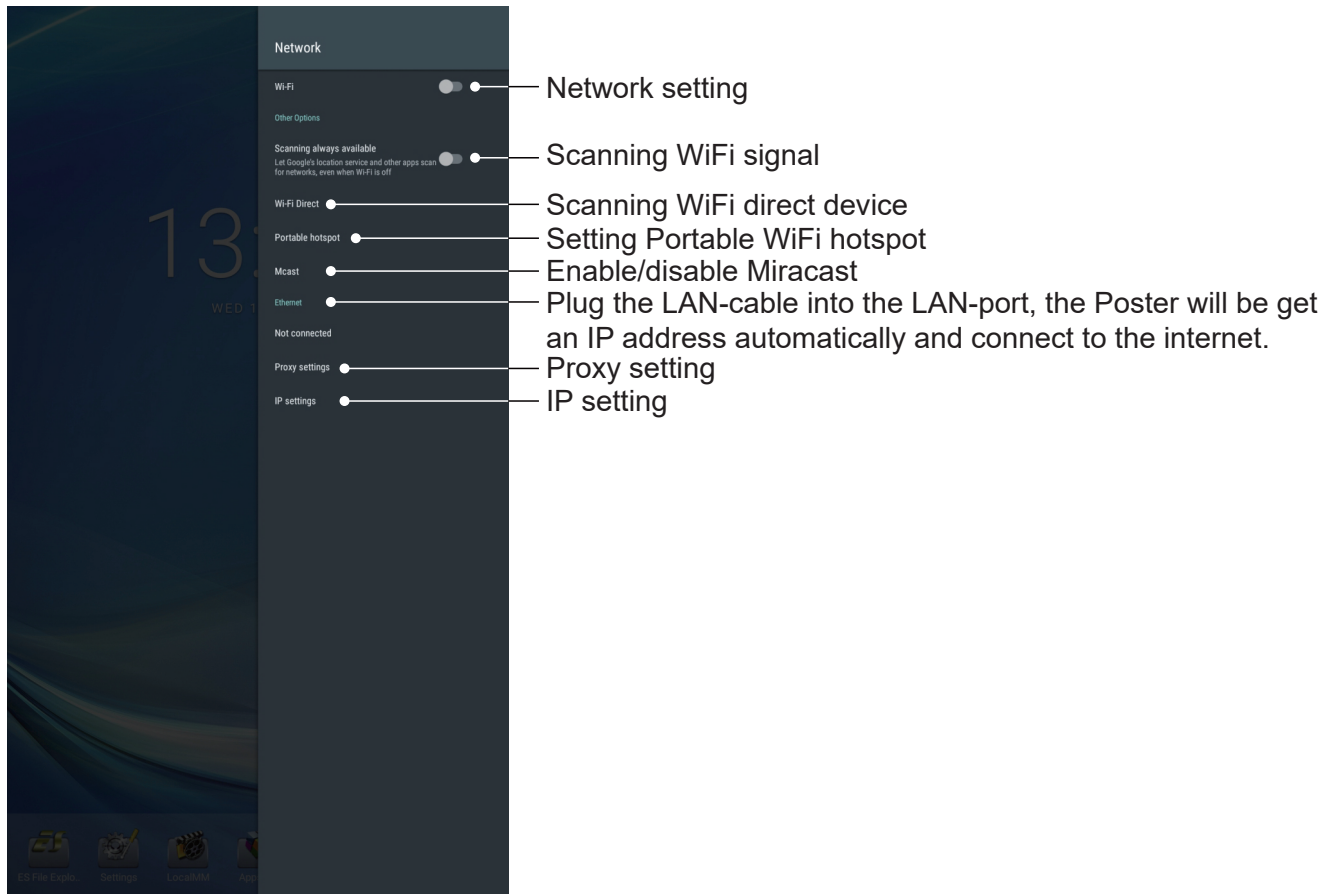

5.2. Home Menu Overview

1. Press ▲▼◀▶ button to entry About and select System net update.

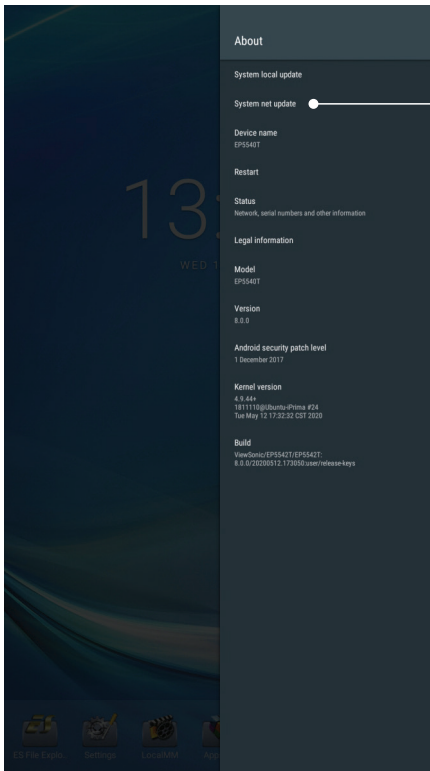

System net update

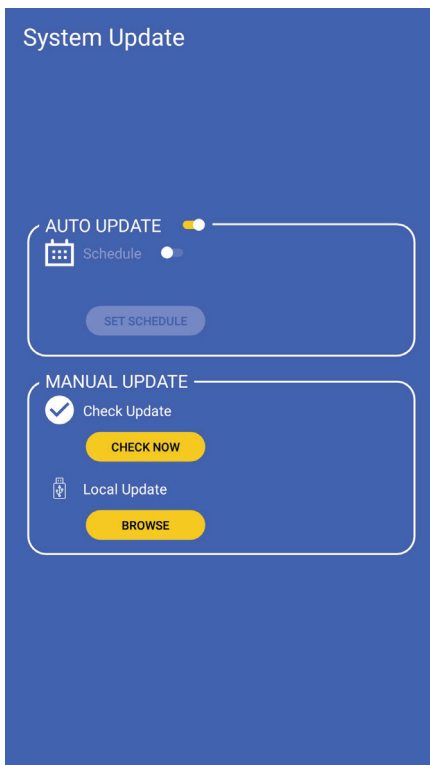

System net update can select

- (1) Auto Update: When display power off, system will auto check the new version from OTA server. If new version found, system will auto update. After update complete, system will turn off.
- (2) Set Schedule: User can set the update time.
- (3) Manual update: User can update the OTA package manually.

6. File Explorer

1. Press ▲▼◀▶ button to select desktop menu option, press **OK** to confirm.
2. Press **EXIT** button to return to previous menu or exit the menu.

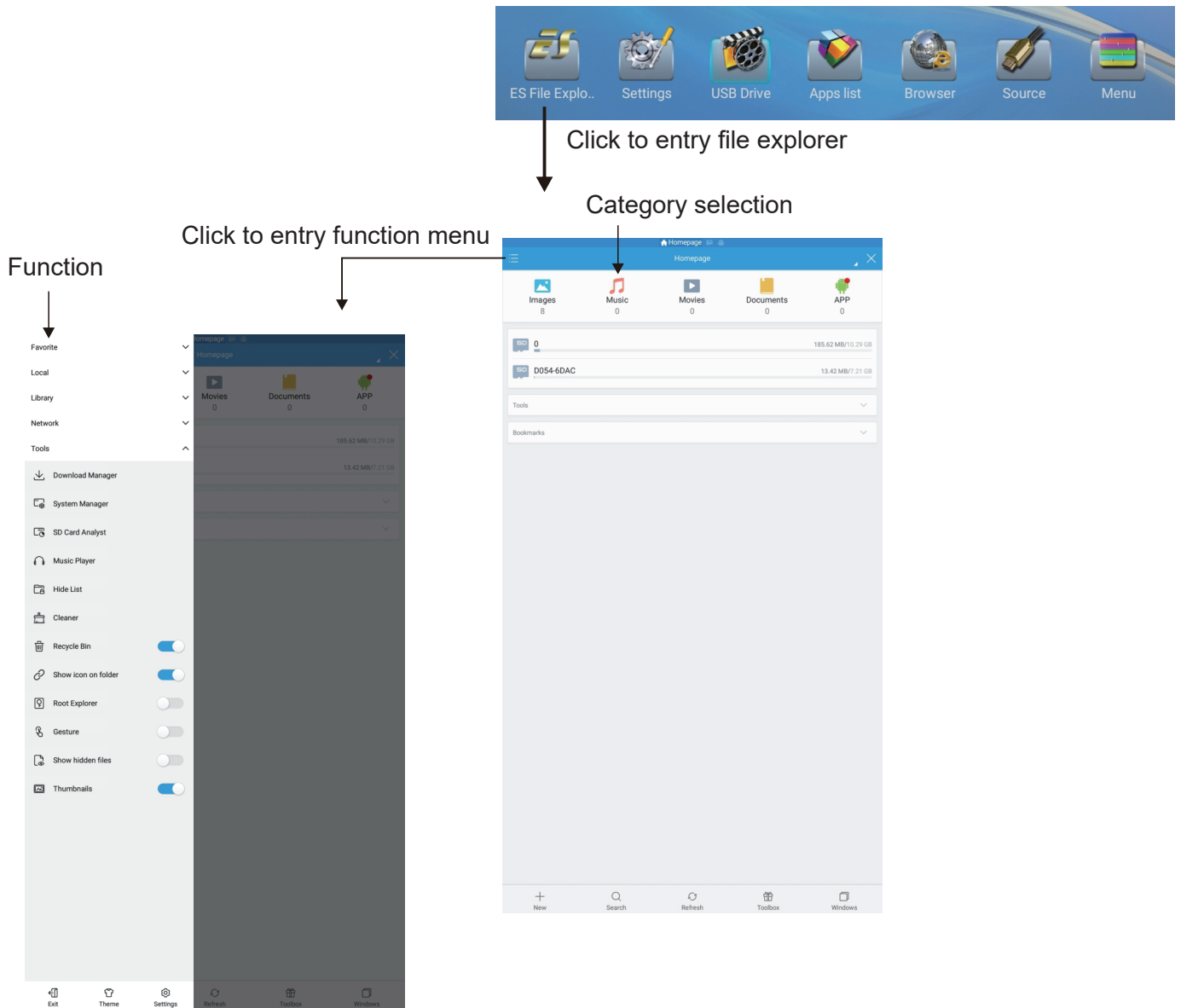

Item		Description
	Exit	Click to exit file manager.
	Theme	Click to change the theme.
	Settings	Click to entry setting menu page.

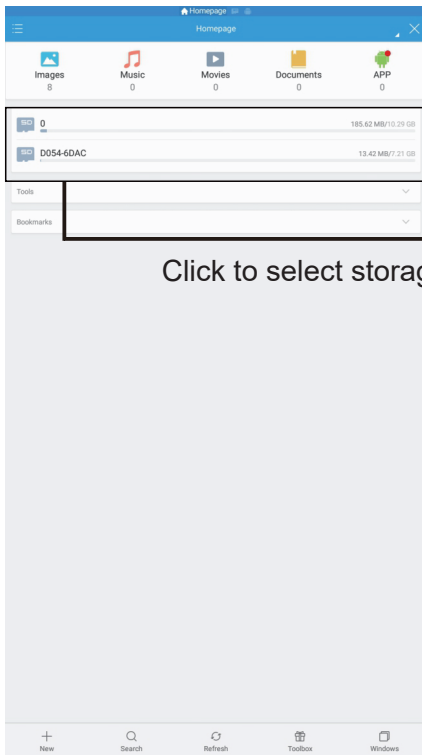

Click to select storage

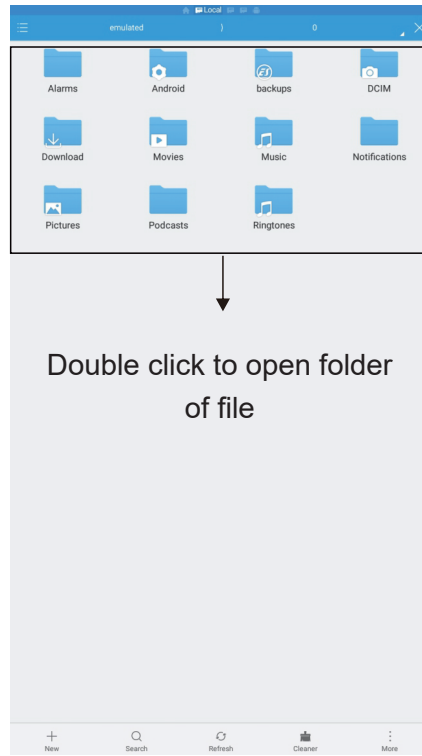

Double click to open folder of file

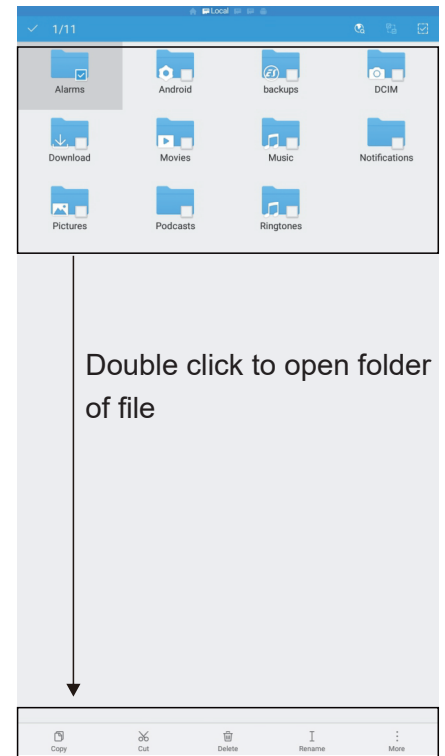

Double click to open folder of file

Item		Description
	New	Click to add file or folder.
	Search	Click to search file or folder.
	Refresh	Click to refresh file status.
	Cleaner	Click to clean not necessary file.
	More	Click to show more functions.
	Copy	Click to copy file.
	Cut	Click to cut file.
	Paste	Click to paste file.
	Delete	Click to delete file.
	Rename	Click to rename file.

7. Menu List



Picture	Picture Mode	Select your favourite picture mode for each input.	
	Contrast	Adjust the contrast.	
	Brightness	Adjust the brightness.	
	Hue	Adjust the image hue. (Only for NTSC system)	
	Sharpness	Adjust the sharpness.	
	Saturation	Adjust the color saturation.	
	Flicker Free	Turn on/off the Anti-Flicker function.	
	Backlight	Set up the overall brilliance of the screen. The Flicker Free select Off, you can set the level of the Backlight as your desired.	
	Screen	Clock	Adjust the screen size.
		Clock Phase	Adjust the focus of stable images.
		H-Position	Move the image right or left.
		V-Position	Move the image up or down.
		Auto adjust	Automatically adjust the image settings such as position and phase.
	Color temperature	Select the color temperature.	
Bluelight Filter	Reduce the bluelight disturbance to sight, protect sight health. The Color temperature select User, you can set the level of the Bluelight Filter as your desired.		
Zoom Mode	Select the aspect ratio (display proportions) according to your video signal type or personal preference [16:9] / [4:3] / [Panorama] / [Just Scan] / [Zoom1] / [Zoom2]		
OverScan	Adjust the reproduction ratio, you may activate this function to obtain a cleaner picture.		
Noise Reduction	Select the noise reduction mode to reduce picture noise.		
ECO Mode	Select energy save mode.		



Sound	Sound Mode	Select your favourite sound mode for each input.
	Bass	Adjust Bass (low sounds).
	Treble	Adjust Treble (high sounds).
	Balance	Adjust volume level of right and left speakers.
	Surround	Turn the Surround sound effect on or off.
	Alone	Press OK to turn off the picture on your display and listen to the program audio only.



Setting	Signal detection	Select On to automatically recognition source.
	OSD turn off	Select OSD menu display time.
	Data	Display the date.
	Time	Display the current time.
	Off Timer	With Off Timer function On, the display will automatically turn off at a preset time.
	On Timer	With On Timer function On, the display will automatically turn on at a preset source at a preset time. Highlight Period item, press ◀ or ▶ button to select Once, Everyday, Mon.~Fri., Mon.~Sat. or Sat.~Sun..
	Boot on source	Power on Source Setting, in MEMORY mode, when the Poster powered on, it will automatically switch to the source when it powered off last time. otherwise, it is in setting mode.
	No Signal Standby	Set the time for no signal standby time.
	HDMI EDID Version	Select HDMI EDID Ver.
	HDMI with One Wire	Turn on/off enable HDMI_CEC.
HDMI ARC	Turn on/off enable HDMI_ARC.	

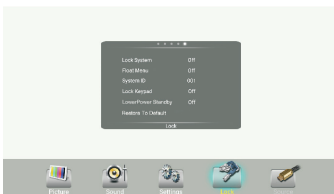
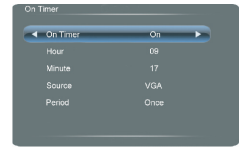

The default password is 0000. The unit provides a super password 2580.

Lock	Set Password	Password settings.
	Monitor ID	Set the ID number for controlling the display via the RS232C connection.
	Power Save	Select Power off save mode. Mode1: Press ⏻ to put the poster in off mode. Mode2: Press ⏻ to put the poster in standby mode. Mode3: Press ⏻ to turn off backlight, press ⏻ again to wake up the system.
	USB Auto Play	When the signal is back, the system will be woken up.
	Slideshow interval	Select slide show time.
	Burn-in Protection Interval	Select Pixel shift time.
	WOL	Set to ON , the Poster is in standby mode, LAN can wake up and turn on the Poster.
	Boot On Logo	Turn on/off the first Power Logo.
	Change Logo	Select Change Logo item to access and change Logo. Note: 1. Save the logo which you are about to change in the USB stick. The logo file sizes should be <512K, and rename it as boot0.jpg. 2. Insert the USB stick into the USB port on the Android board.
	Factory reset	Reset all settings to factory defaults.

8. Using Auto Play

1. Copy media content to the root directory of a USB Flash drive. USB Flash drive should be formatted as FAT32.
2. Using the Poster remote control, press the Menu button.
3. Using the arrow buttons on the remote scroll to the right and select the Lock option.
4. Press OK to enter **Lock** menu

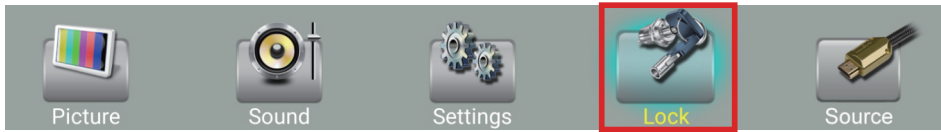

5. When prompted enter user the remote to enter the password (default standard user password is "0000" and super user is "2580")
6. Scroll down to Auto Play and change the option to On.

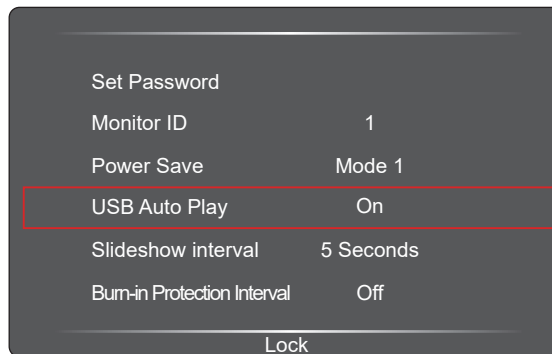

7. Press Exit to close Menu screen.
8. Plug the USB drive into the USB input of the Poster. Files will be copied to the Poster internal memory automatically.

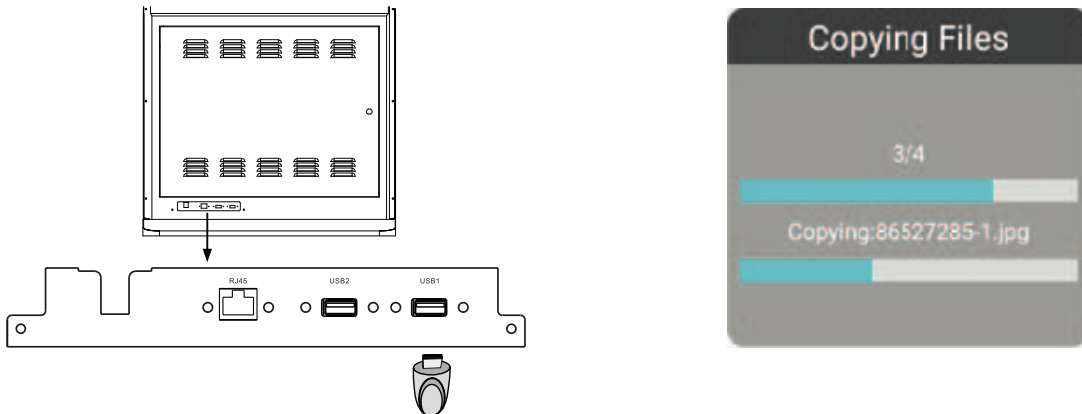

9. After the copying of files have completed, a "Please remove the USB disk" message will display. At this point, it is safe to remove the USB drive. Playback of the copied content will automatically begin.

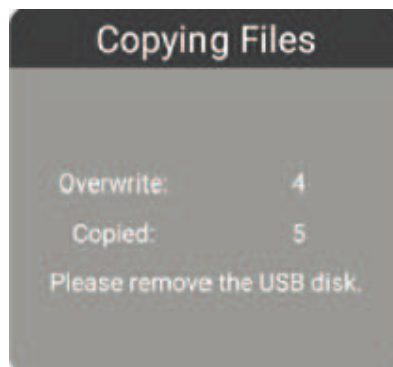

9. Using USB multi media player

- Insert the USB drive with multimedia content including photo, movie and music.
- Switch the input source to USB mode.

Notes:

- It is recommended that you back up your USB device data.
- Please name your files in English. Otherwise the file names can not be shown correctly.
- Some USB device may not be compatible with this display.

USB multi media interface introduction

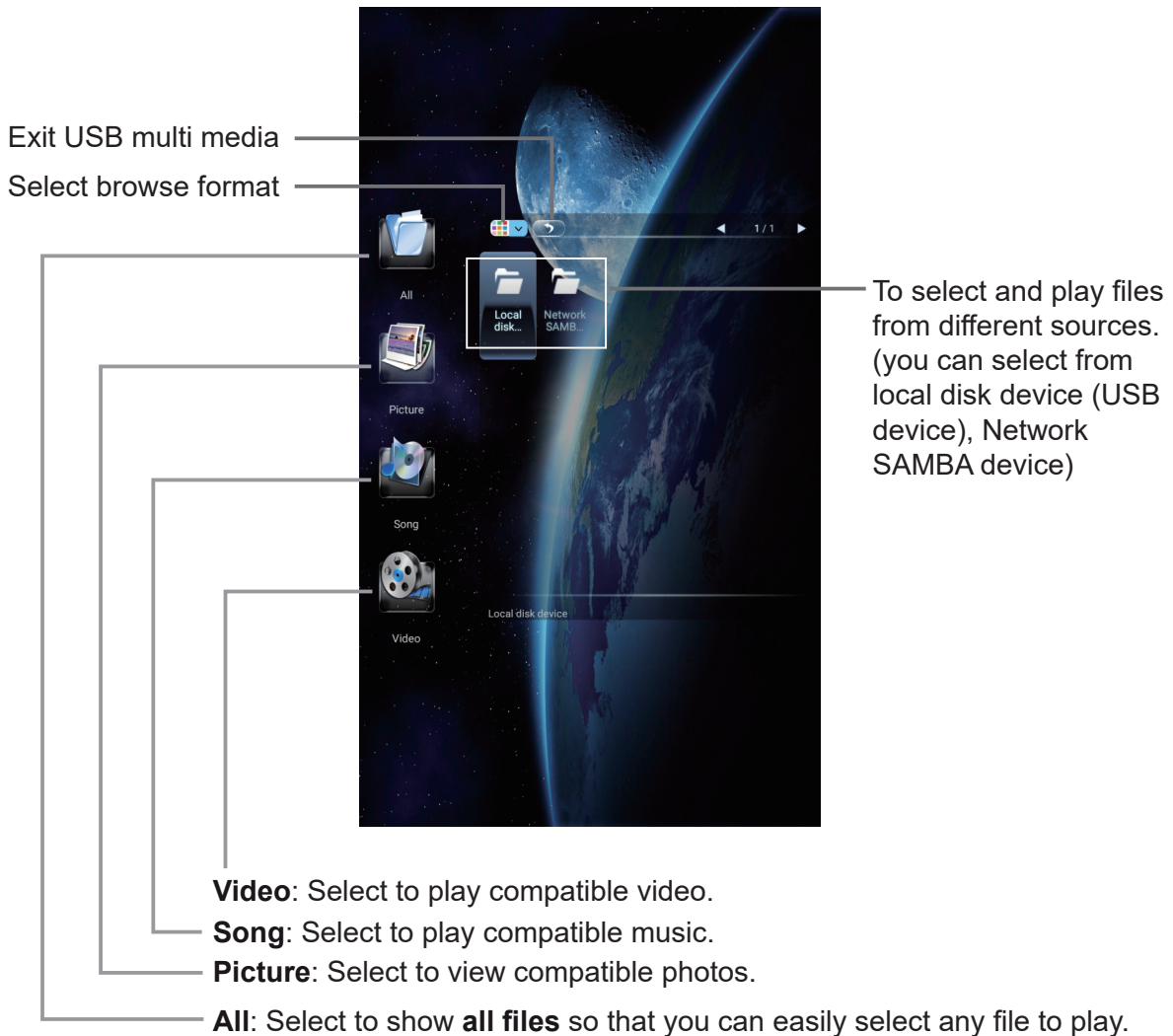

9.1. Playing Photo

Support photo (in JPG, BMP or PNG format).



Notes: You can also use $\blacktriangleright/\blacktriangleleft$ (Play/Pause), \blacksquare (STOP), \ll (Previous), \gg (Next) on the remote control to operate.



9.2. Playing Music

Support music (in MP3 or AAC format).



Previous song
Pause/Play
Next song
Repeat mode select
Show information
Show playlist

Repeat Mode

-  repeat to play single music.
-  repeat to play all music files in current folder when it plays to the end.
-  no repeat when it plays to the end.

Notes: For touch model, when the control bar disappears during playback, please touch the lower portion of the screen to show it up.

9.3. Playing Movie

Support movie in MPG, MKV, DAT, MP4, MOV or VOB format.

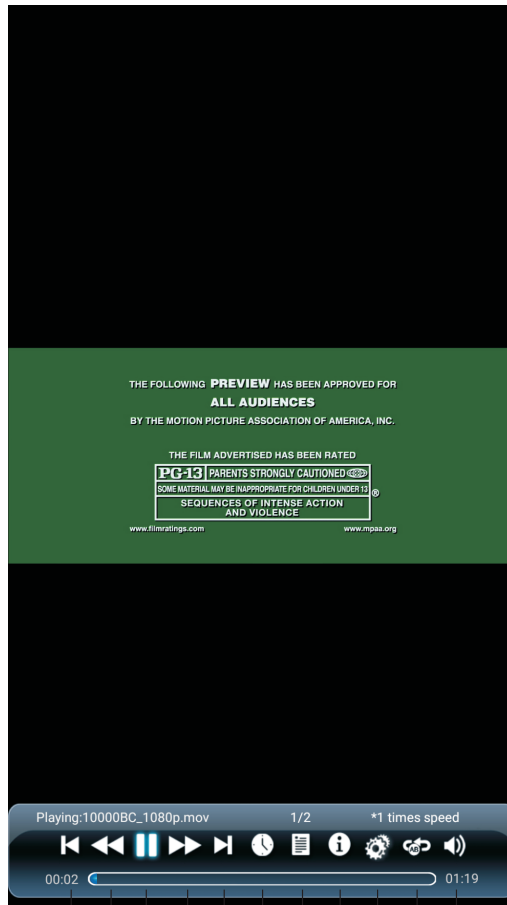

- Previous movie
- Fast reverse
- Play/pause
- Fast forward
- Next movie

Skip to specific point by input time

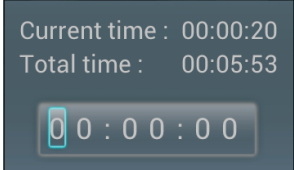

- Show playlist
- Show information

Adjust the volume

AB Section repeat

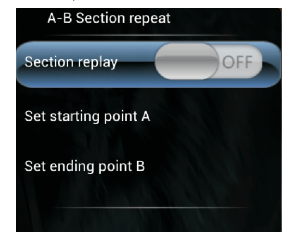
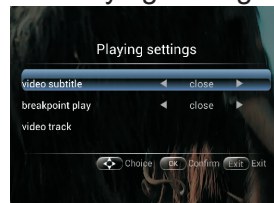

A-B repeat : Trun the **Section Replay** to On, then set starting point A and ending point B.
No repeat: Turn the **Section Replay** to Off.

10. Supported media files format

Photo:

Image	Photo	Resolution (width x height)	Remark
JPEG	Base-line	1920x1080	The limitation of max resolution depends on DRAM size (up to 15360x8640)
	Progressive	1024x768	The limitation of max resolution depends on DRAM size (up to 7000x7000)
PNG	non-interlace	1920x1080	The limitation of max resolution depends on DRAM size (up to 15360x8640)
	interlace	1920x1080	The limitation of max resolution depends on DRAM size (up to 15360x8640)
BMP		15360x8640	The limitation of max resolution depends on DRAM size (up to 15360x8640)

Video:

Video Codec	Resolution	Bit Rate	Profile	Container
HEVC/H.265	4096x2160@60fps	100Mbps	Main/Main10 Profile, High Tier @Level 5.1	MP4 (.mp4, .mov) 3GPP (.3gpp, .3gp) MPEG transport stream (.ts, .trp, .tp) MKV (.mkv)
MPEG1/2	1080P@30fps	40Mbps	MP@HL	MPEG program stream (.DAT, .VOB, .MPG, .MPEG) MPEG transport stream (.ts, .trp, .tp) MP4 (.mp4, .mov) 3GPP (.3gpp, .3gp) AVI (.avi)
MPEG4	1080P@30fps	40Mbps	<ul style="list-style-type: none"> Simple Profile Advanced Simple Profile@Level 5 GMC is not supported 	MP4 (.mp4, .mov) 3GPP (.3gpp, .3gp) AVI (.avi) MKV (.mkv)
H.264	4096x2160@60fps	135Mbps	main and high profile up to level 5.2	FLV (.flv) MP4 (.mp4, .mov) 3GPP (.3gpp, .3gp) MPEG transport stream (.ts, .trp, .tp) ASF (.asf)
AVS	1080P@60fps	50Mbps	Jizhun profile @ Level 6.0	3GPP (.3gpp, .3gp) MP4 (.mp4, .mov) MPEG transport stream (.ts, .trp, .tp)
WMV3	1080P@30fps	40Mbps		ASF (.asf) AVI (.avi) MKV (.mkv) WMV (.wmv)
VC1	2048x1024@30fps	40Mbps	<ul style="list-style-type: none"> Advanced Profile @Level 3 Simple Profile Main Profile 	MPEG transport stream (.ts, .trp, .tp) ASF (.asf) WMV (.wmv) AVI (.avi)
RV30/RV40	1080P@60fps	40Mbps		RM (.rm, .rmvb) MKV (.mkv)

Audio:

Audio Codec	Sample rate	Channel	Bit Rate	Container	Note
MPEG1/2 Layer1	16KHz ~ 48KHz	Up to 2	32Kbps ~ 448Kbps	MP3 (.mp3) AVI (.avi) ASF (.asf) DivX (.divx) Matroska (.mkv, .mka) 3GPP (.3gpp, .3gp) MP4 (.mp4, .mov, m4a) MPEG transport stream (.ts, .trp, .tp) MPEG program stream (.DAT, .VOB, .MPG, .MPEG) FLV (.flv) WAV (.wav)	
MPEG1/2 Layer2	16KHz ~ 48KHz	Up to 2	8Kbps ~ 384Kbps	MP3 (.mp3) AVI (.avi) ASF (.asf) DivX (.divx) Matroska (.mkv, .mka) 3GPP (.3gpp, .3gp) MP4 (.mp4, .mov, m4a) MPEG transport stream (.ts, .trp, .tp) MPEG program stream (.DAT, .VOB, .MPG, .MPEG) FLV (.flv) WAV (.wav)	
MPEG1/2/2.5 Layer3	8KHz ~ 48KHz	Up to 2	8Kbps ~ 320Kbps	MP3 (.mp3) AVI (.avi) ASF (.asf) DivX (.divx) Matroska (.mkv, .mka) 3GPP (.3gpp, .3gp) MP4 (.mp4, .mov, m4a) MPEG transport stream (.ts, .trp, .tp) MPEG program stream (.DAT, .VOB, .MPG, .MPEG) FLV (.flv) WAV (.wav)	
AAC, HEAAC	8KHz ~ 48KHz	Up to 5.1	AAC-LC: 12kbps~ 576kbps V1 6kbps ~ 288kbps V2: 3kbps ~ 144kbps	AAC (.aac) AVI (.avi) Matroska (.mkv, .mka) DivX (.divx) 3GPP (.3gpp, .3gp) MP4 (.mp4, .mov, m4a) MPEG transport stream (.ts, .trp, .tp) MPEG program stream (.DAT, .VOB, .MPG, .MPEG) FLV (.flv) RM (.rm, .rmvb, .ra) WAV (.wav)	

Audio Codec	Sample rate	Channel	Bit Rate	Container	Note
LPCM	8KHz ~ 48KHz	Mono, Stereo, 5.1	64Kbps ~ 1.5Mbps	WAV (.wav) AVI (.avi) Matroska (.mkv, .mka) 3GPP (.3gpp, .3gp) MP4 (.mp4, .mov, m4a) MPEG transport stream (.ts, .trp, .tp) MPEG program stream (.DAT, .VOB, .MPG, .MPEG)	

*Practically supported format will depend on the paid royalties.

11. Troubleshooting

If, after reading these operating instructions, you have additional questions related to the use of your display, please call the services center in your local area.

Before calling service, please check the symptoms and follow suggested solutions.

Remote Control

Problem	Possible Solutions
Remote control does not operate	<ul style="list-style-type: none">• The batteries could be weak. Replace the batteries.• Check the orientation of the batteries.• Make sure the power cord is plugged in.

Video and Audio

Problem	Possible Solutions
No picture (screen not lit), No sound	<ul style="list-style-type: none">• Make sure the power cord is plugged in.• Press POWER on the display or on the remote control.
Dark, poor or no picture (Screen lit), good sound	<ul style="list-style-type: none">• Select a proper picture mode.• Adjust the brightness in the video setting.
No color/dark picture/abnormal color	<ul style="list-style-type: none">• Adjust the color saturation in the video setting.
Dotted lines or stripes	<ul style="list-style-type: none">• Move the display away from noise sources such as cars, neon signs, or hair dryers.
Good picture, no sound	<ul style="list-style-type: none">• The sound may be muted. Press MUTE again to cancel.
Audio noise	<ul style="list-style-type: none">• Communication problems may occur if infrared communication equipment (e.g., infrared cordless headphones) is used near the display. Move the infrared communication equipment away from the display until the noise is eliminated.

General

Problem	Possible Solutions
Some items can't be accessed	<ul style="list-style-type: none">• If a setting option appears in gray, this indicates that the settings option is unavailable in current input mode.
Remote control command is not effect in some cases.	<ul style="list-style-type: none">• During the timing of USB device detection (i.e. when the display is turned on with USB device connected, or when you plug in USB device during display working), the display may not act by remote control buttons in such case. Wait some time, then it is OK.
Control buttons do not operate	<ul style="list-style-type: none">• Disconnect the power cord and wait for a few seconds. Then re-plug the power cord and turn on the unit again.
POWER button responds slowly after power is connected.	<ul style="list-style-type: none">• When you push POWER SWITCH to power on the display, in about 3 seconds the POWER button starts to respond after pressed.

Note: If your problem is not solved, turn your unit off and then on again.

Cautions: Never attempt to repair a defective display yourself.

12. Specifications

Display:

Model No.		EP5542	EP5542T
Power Source		AC 100-240 V, 50 / 60 Hz	
Current Max.		2.3A	2.3A
Display panel	Visible screen size	55 inches (diagonal)	55 inches (diagonal)
	Number of pixels	3,840 × 2,160	3,840 × 2,160
Dimensions (W × D × H)		768.5 x 1870 x 450 mm 30.26 x 73.63 x 17.72 in	768.5 x 1870 x 450 mm 30.26 x 73.63 x 17.72 in
Net Weight		62.7 kg 138.23 lb	62.7 kg 138.23 lb
Operating conditions		Temperature: 0°C to 40°C 32°F to 104°F Humidity: 20% ~ 80% non-condensing	
Storage conditions		Temperature: -20°C to 60°C - 4°F to 140°F Humidity: 10% ~ 90% non-condensing	
Atmospheric pressure		86kPa ~ 106kPa	
Connection terminals of the Poster	DP 1.2	1	1
	HDMI 2.0	3	3
	PC IN	1	1
	PC Audio In	1	1
	Headphone	1	1
	SPDIF	1	1
	RS232	1	1
	RJ45	1	1
	USB 2.0 (Type A)	3	3
	TOUCH OUT	0	2

Notes:

1. Design and specifications are subject to change without notice.
2. Weight and dimensions shown are approximate.
3. Specifications and external appearance may be changed for the sake of improvement.

13. Other Information

Customer Support

For technical support or product service, see the table below or contact your reseller.

NOTE: You will need the product serial number.

Country/Region	Website	T= Telephone C = CHAT ONLINE	Email
Australia/New Zealand	www.viewsonic.com.au	AUS= 1800-880-818 NZ= 0800-008-822	service@au.viewsonic.com
Canada	www.viewsonic.com	T= 1-866-463-4775	service.ca@viewsonic.com
Europe	www.viewsoniceurope.com	www.viewsoniceurope.com/eu/support/call-desk/	
Hong Kong	www.hk.viewsonic.com	T= (852)-3102-2900	service@hk.viewsonic.com
India	www.in.viewsonic.com	T= 1800-419-0959	service@in.viewsonic.com
Korea	ap.viewsonic.com/kr/	T= 080-333-2131	service@kr.viewsonic.com
Latin America	www.viewsonic.com/la/	C= http://www.viewsonic.com/la/soporte/servicio-tecnico	soporte@viewsonic.com
<p>Nexus Hightech Solutions, Cincinnati #40 Desp. 1 Col. De los Deportes Mexico D.F. Tel: 55) 6547-6454 55)6547-6484 Other places please refer to http://www.viewsonic.com/la/soporte/servicio-tecnico#mexico</p>			
Macau	www.hk.viewsonic.com	T= (853)-2833-8407	service@hk.viewsonic.com
Middle East	ap.viewsonic.com/me/	Contact your reseller	service@ap.viewsonic.com
Puerto Rico & Virgin Islands	www.viewsonic.com	T= 1-800-688-6688 (English) C= http://www.viewsonic.com/la/soporte/servicio-tecnico	"service.us@viewsonic.com soporte@viewsonic.com"
Singapore/	www.viewsonic.com/sg/	T= 65 6461 6044	service@ap.viewsonic.com
Malaysia	www.viewsonic.com/my/	T= 1800 - 88 - 8997	service@ap.viewsonic.com
Thailand	www.viewsonic.com/th/	T= 02-7214091-3	service@ap.viewsonic.com
South Africa	ap.viewsonic.com/za/	Contact your reseller	service@ap.viewsonic.com
United States	www.viewsonic.com	T= 1-800-688-6688	service.us@viewsonic.com
Indonesia	www.viewsonic.com/id/	Contact your reseller	service@ap.viewsonic.com
Japan	www.viewsonic.com/jp/	T= 050-3388-6832	service@ap.viewsonic.com
Philippines	www.viewsonic.com/ph/	Contact your reseller	service@ap.viewsonic.com
Vietnam	www.viewsonic.com/vn/	Contact your reseller	service@ap.viewsonic.com
Taiwan	www.viewsonic.com/tw/	T= 0800-899-880	service@tw.viewsonic.com

Limited Warranty

ViewSonic® LCD Commercial Display

What the warranty covers:

ViewSonic warrants its products to be free from defects in material and workmanship, under normal use, during the warranty period. If a product proves to be defective in material or workmanship during the warranty period, ViewSonic will, at its sole option, repair or replace the product with a like product. Replacement product or parts may include remanufactured or refurbished parts or components.

Who the warranty protects:

This warranty is valid only for the first consumer purchaser.

What the warranty does not cover:

1. Any product on which the serial number has been defaced, modified or removed.
2. Damage, deterioration or malfunction resulting from:
 - a. Accident, misuse, neglect, fire, water, lightning, or other acts of nature, unauthorized product modification, or failure to follow instructions supplied with the product.
 - b. Any damage of the product due to shipment.
 - c. Removal or installation of the product.
 - d. Causes external to the product, such as electrical power fluctuations or failure.
 - e. Use of supplies or parts not meeting ViewSonic's specifications.
 - f. Normal wear and tear.
 - g. Any other cause which does not relate to a product defect.
3. Any product exhibiting a condition commonly known as "image burn-in" which results when a static image is displayed on the product for an extended period of time.
4. Removal, installation, one way transportation, insurance, and set-up service charges.

How to get service:

1. For information about receiving service under warranty, contact ViewSonic Customer Support (Please refer to Customer Support page). You will need to provide your product's serial number.
2. To obtain warranty service, you will be required to provide (a) the original dated sales slip, (b) your name, (c) your address, (d) a description of the problem, and (e) the serial number of the product.
3. Take or ship the product freight prepaid in the original container to an authorized ViewSonic service center or ViewSonic.
4. For additional information or the name of the nearest ViewSonic service center, contact ViewSonic.

Limitation of implied warranties:

There are no warranties, express or implied, which extend beyond the description contained herein including the implied warranty of merchantability and fitness for a particular purpose.

Exclusion of damages:

ViewSonic's liability is limited to the cost of repair or replacement of the product. ViewSonic shall not be liable for:

1. Damage to other property caused by any defects in the product, damages based upon inconvenience, loss of use of the product, loss of time, loss of profits, loss of business opportunity, loss of goodwill, interference with business relationships, or other commercial loss, even if advised of the possibility of such damages.
2. Any other damages, whether incidental, consequential or otherwise.
3. Any claim against the customer by any other party.
4. Repair or attempted repair by anyone not authorized by ViewSonic.

Effect of state law:

This warranty gives you specific legal rights, and you may also have other rights which vary from state to state. Some states do not allow limitations on implied warranties and/or do not allow the exclusion of incidental or consequential damages, so the above limitations and exclusions may not apply to you.

Sales outside the U.S.A. and Canada:

For warranty information and service on ViewSonic products sold outside of the U.S.A. and Canada, contact ViewSonic or your local ViewSonic dealer.

The warranty period for this product in mainland China (Hong Kong, Macao and Taiwan Excluded) is subject to the terms and conditions of the Maintenance Guarantee Card.

For users in Europe and Russia, full details of warranty provided can be found in www.viewsoniceurope.com under Support/Warranty Information.

Mexico Limited Warranty

ViewSonic® LCD Commercial Display

What the warranty covers:

ViewSonic warrants its products to be free from defects in material and workmanship, under normal use, during the warranty period. If a product proves to be defective in material or workmanship during the warranty period, ViewSonic will, at its sole option, repair or replace the product with a like product. Replacement product or parts may include re-manufactured or refurbished parts or components.

Who the warranty protects:

This warranty is valid only for the first consumer purchaser.

What the warranty does not cover:

1. Any product on which the serial number has been defaced, modified or removed.
2. Damage, deterioration or malfunction resulting from:
 - a. Accident, misuse, neglect, fire, water, lightning, or other acts of nature, unauthorized product modification, or failure to follow instructions supplied with the product.
 - b. Any damage of the product due to shipment.
 - c. Removal or installation of the product.
 - d. Causes external to the product, such as electrical power fluctuations or failure.
 - e. Use of supplies or parts not meeting ViewSonic's specifications.
 - f. Normal wear and tear.
 - g. Any other cause which does not relate to a product defect.
3. Any product exhibiting a condition commonly known as "image burn-in" which results when a static image is displayed on the product for an extended period of time.
4. Removal, installation, one way transportation, insurance, and set-up service charges.

How to get service:

For information about receiving service under warranty, contact ViewSonic Customer Support (Please refer to the attached Customer Support page). You will need to provide your product's serial number, so please record the product information in the space provided below on your purchase for your future use. Please retain your receipt of proof of purchase to support your warranty claim.

For Your Records

Product Name: _____

Model Number: _____

Document Number: _____

Serial Number: _____

Purchase Date: _____

Extended Warranty Purchase? _____ (Y/N)

If so, what date does warranty expire? _____

1. To obtain warranty service, you will be required to provide (a) the original dated sales slip, (b) your name, (c) your address, (d) a description of the problem, and (e) the serial number of the product.
2. Take or ship the product in the original container packaging to an authorized ViewSonic service center.
3. Round trip transportation costs for in-warranty products will be paid by ViewSonic.

Limitation of implied warranties:

There are no warranties, express or implied, which extend beyond the description contained herein including the implied warranty of merchantability and fitness for a particular purpose.

Exclusion of damages:

ViewSonic's liability is limited to the cost of repair or replacement of the product. ViewSonic shall not be liable for:

1. Damage to other property caused by any defects in the product, damages based upon inconvenience, loss of use of the product, loss of time, loss of profits, loss of business opportunity, loss of goodwill, interference with business relationships, or other commercial loss, even if advised of the possibility of such damages.
2. Any other damages, whether incidental, consequential or otherwise.
3. Any claim against the customer by any other party.
4. Repair or attempted repair by anyone not authorized by ViewSonic.

Contact Information for Sales & Authorized Service (Centro Autorizado de Servicio) within Mexico:	
Name, address, of manufacturer and importers: México, Av. de la Palma #8 Piso 2 Despacho 203, Corporativo Interpalmas, Col. San Fernando Huixquilucan, Estado de México Tel: (55) 3605-1099 http://www.viewsonic.com/la/soporte/index.htm	
NÚMERO GRATIS DE ASISTENCIA TÉCNICA PARA TODO MÉXICO: 001.866.823.2004	
Hermosillo: Distribuciones y Servicios Computacionales SA de CV. Calle Juarez 284 local 2 Col. Bugambilias C.P: 83140 Tel: 01-66-22-14-9005 E-Mail: disc2@hmo.megared.net.mx	Villahermosa: Compumantenimientos Garantizados, S.A. de C.V. AV. GREGORIO MENDEZ #1504 COL, FLORIDA C.P. 86040 Tel: 01 (993) 3 52 00 47 / 3522074 / 3 52 20 09 E-Mail: compumantenimientos@prodigy.net.mx
Puebla, Pue. (Matriz): RENTA Y DATOS, S.A. DE C.V. Domicilio: 29 SUR 721 COL. LA PAZ 72160 PUEBLA, PUE. Tel: 01(52).222.891.55.77 CON 10 LINEAS E-Mail: datos@puebla.megared.net.mx	Veracruz, Ver.: CONEXION Y DESARROLLO, S.A DE C.V. Av. Americas # 419 ENTRE PINZÓN Y ALVARADO Fracc. Reforma C.P. 91919 Tel: 01-22-91-00-31-67 E-Mail: gacosta@qplus.com.mx
Chihuahua Soluciones Globales en Computación C. Magisterio # 3321 Col. Magisterial Chihuahua, Chih. Tel: 4136954 E-Mail: Cefeo@soluglobales.com	Cuernavaca Compusupport de Cuernavaca SA de CV Francisco Leyva # 178 Col. Miguel Hidalgo C.P. 62040, Cuernavaca Morelos Tel: 01 777 3180579 / 01 777 3124014 E-Mail: aquevedo@compusupportcva.com
Distrito Federal: QPLUS, S.A. de C.V. Av. Coyoacán 931 Col. Del Valle 03100, México, D.F. Tel: 01(52)55-50-00-27-35 E-Mail : gacosta@qplus.com.mx	Guadalajara, Jal.: SERVICRECE, S.A. de C.V. Av. Niños Héroes # 2281 Col. Arcos Sur, Sector Juárez 44170, Guadalajara, Jalisco Tel: 01(52)33-36-15-15-43 E-Mail: mmiranda@servicrece.com
Guerrero Acapulco GS Computación (Grupo Sesicomp) Progreso #6-A, Colo Centro 39300 Acapulco, Guerrero Tel: 744-48-32627	Monterrey: Global Product Services Mar Caribe # 1987, Esquina con Golfo Pérsico Fracc. Bernardo Reyes, CP 64280 Monterrey N.L. México Tel: 8129-5103 E-Mail: aydeem@gps1.com.mx
MÉRIDA: ELECTROSER Av Reforma No. 403Gx39 y 41 Mérida, Yucatán, México CP97000 Tel: (52) 999-925-1916 E-Mail: rrrb@sureste.com	Oaxaca, Oax.: CENTRO DE DISTRIBUCION Y SERVICIO, S.A. de C.V. Murguía # 708 P.A., Col. Centro, 68000, Oaxaca Tel: 01(52)95-15-15-22-22 Fax: 01(52)95-15-13-67-00 E-Mail: gpotai2001@hotmail.com
Tijuana: STD Av Ferrocarril Sonora #3780 L-C Col 20 de Noviembre Tijuana, Mexico	FOR USA SUPPORT: ViewSonic Corporation 14035 Pipeline Ave. Chino, CA 91710, USA Tel: 800-688-6688 E-Mail: http://www.viewsonic.com



ViewSonic®