

ViewSonic®



IFP5550/IFP6550/IFP7550/IFP8650 Commercial Touch Display User Guide

Touchboards

205 Westwood Ave, Long Branch, NJ 07740
Phone: 866-94 BOARDS (26273) / (732)-222-1511
Fax: (732)-222-7088 | E-mail: sales@touchboards.com

IMPORTANT: Please read this User Guide to obtain important information on installing and using your product in a safe manner, as well as registering your product for future service. Warranty information contained in this User Guide will describe your limited coverage from ViewSonic Corporation, which is also found on our web site at <http://www.viewsonic.com> in English, or in specific languages using the Regional selection box in the upper right corner of our website. "Antes de operar su equipo lea cuidadosamente las instrucciones en este manual"

Model No. VS17121/VS16954/VS16876/VS16874

Thank you for choosing ViewSonic

As a world leading provider of visual solutions, ViewSonic is dedicated to exceeding the world's expectations for technological evolution, innovation, and simplicity. At ViewSonic, we believe that our products have the potential to make a positive impact in the world, and we are confident that the ViewSonic product you have chosen will serve you well.

Once again, thank you for choosing ViewSonic !



Compliance Information

NOTE: This section addresses all connected requirements and statements regarding regulations. Confirmed corresponding applications shall refer to nameplate labels and relevant markings on unit.

FCC Compliance Statement

This device complies with part 15 of FCC Rules. Operation is subject to the following two conditions: (1) this device may not cause harmful interference, and (2) this device must accept any interference received, including interference that may cause undesired operation.

This equipment has been tested and found to comply with the limits for a Class B digital device, pursuant to part 15 of the FCC Rules. These limits are designed to provide reasonable protection against harmful interference in a residential installation. This equipment generates, uses, and can radiate radio frequency energy, and if not installed and used in accordance with the instructions, may cause harmful interference to radio communications. However, there is no guarantee that interference will not occur in a particular installation. If this equipment does cause harmful interference to radio or television reception, which can be determined by turning the equipment off and on, the user is encouraged to try to correct the interference by one or more of the following measures:

- Reorient or relocate the receiving antenna.
- Increase the separation between the equipment and receiver.
- Connect the equipment into an outlet on a circuit different from that to which the receiver is connected.
- Consult the dealer or an experienced radio/TV technician for help.

Warning: You are cautioned that changes or modifications not expressly approved by the party responsible for compliance could void your authority to operate the equipment.

Industry Canada Statement

CAN ICES-3 (B)/NMB-3(B)

Contains FCC ID: 2AFG6-RK3399

IC ID: 22166-RK3399

CE Conformity for European Countries

 The device complies with the EMC Directive 2014/30/EU and Low Voltage Directive 2014/35/EU.

Following information is only for EU-member states:

The mark shown to the right is in compliance with the Waste Electrical and Electronic Equipment Directive 2012/19/EU (WEEE). The mark indicates the requirement NOT to dispose the equipment as unsorted municipal waste, but use the return and collection systems according to local law.



Indian Restriction of Hazardous Substances

Restriction on Hazardous Substances statement (India) This product complies with the “India E-waste Rule 2011” and prohibits use of lead, mercury, hexavalent chromium, polybrominated biphenyls or polybrominated diphenyl ethers in concentrations exceeding 0.1 weight % and 0.01 weight % for cadmium, except for the exemptions set in Schedule 2 of the Rule.

Declaration of RoHS2 Compliance

This product has been designed and manufactured in compliance with Directive 2011/65/EU of the European Parliament and the Council on restriction of the use of certain hazardous substances in electrical and electronic equipment (RoHS2 Directive) and is deemed to comply with the maximum concentration values issued by the European Technical Adaptation Committee (TAC) as shown below:

Substance	Proposed Maximum Concentration	Actual Concentration
Lead (Pb)	0.1%	< 0.1%
Mercury (Hg)	0.1%	< 0.1%
Cadmium (Cd)	0.01%	< 0.01%
Hexavalent Chromium (Cr ⁶⁺)	0.1%	< 0.1%
Polybrominated biphenyls (PBB)	0.1%	< 0.1%
Polybrominated diphenyl ethers (PBDE)	0.1%	< 0.1%
Bis (2-ethylhexyl) phthalate (DEHP)	0.1%	< 0.1%
Butyl benzyl phthalate (BBP)	0.1%	< 0.1%
Dibutyl phthalate (DBP)	0.1%	< 0.1%
Diisobutyl phthalate (DIBP)	0.1%	< 0.1%

Certain components of products as stated above are exempted under the Annex III of the RoHS2 Directives as noted below:

Examples of exempted components are:

1. Mercury in cold cathode fluorescent lamps and external electrode fluorescent lamps (CCFL and EEFL) for special purposes not exceeding (per lamp):
 - (1) Short length (≤ 500 mm): maximum 3.5 mg per lamp.
 - (2) Medium length (> 500 mm and $\leq 1,500$ mm): maximum 5 mg per lamp.
 - (3) Long length ($> 1,500$ mm): maximum 13 mg per lamp.
2. Lead in glass of cathode ray tubes.
3. Lead in glass of fluorescent tubes not exceeding 0.2% by weight.
4. Lead as an alloying element in aluminium containing up to 0.4% lead by weight.
5. Copper alloy containing up to 4% lead by weight.

6. Lead in high melting temperature type solders (i.e. lead-based alloys containing 85% by weight or more lead).
7. Electrical and electronic components containing lead in a glass or ceramic other than dielectric ceramic in capacitors, e.g. piezoelectronic devices, or in a glass or ceramic matrix compound.

Cautions and Warnings

1. Read these instructions completely before using the equipment.
2. Keep these instructions in a safe place.
3. Heed all warnings and follow all instructions.
4. Always handle the LCD display with care when moving it.
5. Never remove the rear cover. This LCD display contains high-voltage parts. You may be seriously injured if you touch them.
6. Do not use this equipment near water. **Warning:** To reduce the risk of fire or electric shock, do not expose this apparatus to rain or moisture.
7. Avoid exposing the LCD display to direct sunlight or another heat source. Orient the LCD display away from direct sunlight to reduce glare.
8. Clean with a soft, dry cloth. If further cleaning is required, see the “Care and Maintenance” section in this guide for further instructions.
9. Avoid touching the screen. Skin oils are difficult to remove.
10. Do not rub or apply pressure to the LCD panel, as it may permanently damage the screen.
11. Do not block any ventilation openings. Install the equipment in accordance with the manufacturer’s instructions.
12. Do not install near any heat sources such as radiators, heat registers, stoves, or other devices (including amplifiers) that produce heat.
13. Place the LCD display in a well ventilated area. Do not place anything on the LCD display that prevents heat dissipation.
14. Do not place heavy objects on the LCD display, video cable, or power cord.
15. If smoke, an abnormal noise, or a strange odor is present, immediately switch the LCD display off and call your dealer or ViewSonic. It is dangerous to continue using the LCD display.
16. Do not attempt to circumvent the safety provisions of the polarized or grounding-type plug. A polarized plug has two blades with one wider than the other. A grounding type plug has two blades and a third grounding prong. The wide blade and the third prong are provided for your safety. If the plug does not fit into your outlet, consult an electrician for replacement of the outlet.

(Continued on next page)

17. Protect the power cord from being tread upon or pinched, particularly at the plug, and the point where it emerges from the equipment. Be sure that the power outlet is located near the equipment so that it is easily accessible.
18. Only use attachments/accessories specified by the manufacturer.
19. Use only with the cart, stand, tripod, bracket, or table specified by the manufacturer, or sold with the equipment. When a cart is used, use caution when moving the cart/equipment combination to avoid injury from tipping over.
20. Unplug this equipment when it will be unused for long periods of time.
21. Refer all servicing to qualified service personnel. Service is required when the unit has been damaged in any way, such as: if the power-supply cord or plug is damaged, if liquid is spilled onto or objects fall into the unit, if the unit is exposed to rain or moisture, or if the unit does not operate normally or has been dropped.
22. The Unit is a Monitor with LED backlight intended for general office used.



Contents

Compliance Information

FCC Compliance Statement.....	i
Industry Canada Statement.....	i
CE Conformity for European Countries.....	i
Indian Restriction of Hazardous Substances	ii
Declaration of RoHS2 Compliance.....	ii
Cautions and Warnings	iii

Copyright Information

Product Registration.....	2
For Your Records	2

1. Getting Started

1.1 Package Contents.....	3
1.2 Wall Mount Kit Specifications (VESA).....	4

2. Smart Whiteboard/LCD Display

Features

2.1 Control Panel Overview.....	5
2.2 Terminal Interface Overview	6
2.3 Remote Control Overview	7
2.4 Inserting Remote Control Batteries	8
2.5 Remote Control Receiver Range	9

3. Setting Up Your Display

3.1 Connecting an External PC.....	10
3.2 RS232 Connections	11
3.3 Connecting USB Peripherals.....	12
3.4 AV IN Connections	13
3.5 HDMI Connections	14
3.6 Coaxial Connections	14
3.7 Video Output Connection	15

4. OSD Menu Operation

4.1 General Setting	16
4.2 More OSD settings	18
4.3 Annotation Menu	21
4.4 Embedded Player Interface.....	27
4.5 Multimedia supported formats	49

5. Trouble Shooting

6. Care and Maintenance

7. Display Modes

7.1 VGA Mode.....	53
7.2 HDMI Mode	54
7.3 DP Mode	55

8. Specifications

9. RS-232 Protocol

9.1 Introduction.....	57
9.2 Description	57
9.2.1 Hardware specification	57
9.2.2 Communication Setting	58
9.2.3 Command Message Reference.....	58
9.3 Protocol	58
9.3.1 Set-Function Listing.....	58
9.3.2 Get-Function Listing	64
9.3.3 Remote Control Pass-through mode.....	71

Other Information

Customer Support	74
Limited Warranty	75
Mexico Limited Warranty.....	77

Copyright Information

Copyright © ViewSonic Corporation, 2017. All rights reserved.

Macintosh and Power Macintosh are registered trademarks of Apple Inc.

Microsoft, Windows, and the Windows logo are registered trademarks of Microsoft Corporation in the United States and other countries.

ViewSonic, the three birds logo, OnView, ViewMatch, and ViewMeter are registered trademarks of ViewSonic Corporation.

VESA is a registered trademark of the Video Electronics Standards Association. DPMS, DisplayPort, and DDC are trademarks of VESA.

 is a trademark of SRS Labs, Inc.

Premium Sound technology is incorporated under license from SRS Labs, Inc.

ENERGY STAR® is a registered trademark of the U.S. Environmental Protection Agency (EPA).

As an ENERGY STAR® partner, ViewSonic Corporation has determined that this product meets the ENERGY STAR® guidelines for energy efficiency.

Disclaimer: ViewSonic Corporation shall not be liable for technical or editorial errors or omissions contained herein; nor for incidental or consequential damages resulting from furnishing this material, or the performance or use of this product.

In the interest of continuing product improvement, ViewSonic Corporation reserves the right to change product specifications without notice. Information in this document may change without notice.

No part of this document may be copied, reproduced, or transmitted by any means, for any purpose without prior written permission from ViewSonic Corporation.

Product Registration

To fulfill possible future product needs, and to receive additional product information as it becomes available, please visit your region section on ViewSonic's website to register your product online.

The ViewSonic CD also provides an opportunity for you to print the product registration form. Upon completion, please mail or fax to a respective ViewSonic office. To find your registration form, use the directory “:\CD\Registration”. Registering your product will best prepare you for future customer service needs.

Please print this user guide and fill the information in the “For Your Records” section. Your LCD displays serial number is located on the rear side of the display.

For additional information, please see the “Customer Support” section in this guide.

For Your Records

Product Name:	IFP5550/IFP6550/IFP7550/IFP8650 ViewSonic Commercial Touch Display
Model Number:	VS17121/VS16954/VS16876/VS16874
Document Number:	IFP5550/IFP6550/IFP7550/IFP8650_UG_ENG Rev. 1B 03-14-17
Serial Number:	_____
Purchase Date:	_____

Product disposal at end of product life

ViewSonic respects the environment and is committed to working and living green. Thank you for being part of Smarter, Greener Computing.

Please visit ViewSonic website to learn more.

USA & Canada: <http://www.viewsonic.com/company/green/recycle-program/>

Europe: <http://www.viewsoniceurope.com/eu/support/call-desk/>

Taiwan: <http://recycle.epa.gov.tw/recycle/index2.aspx>

1. Getting Started

Congratulations on your purchase of a ViewSonic® LCD display.

Important! Save the original box and all packing material for future shipping needs.

Note: The word “Windows” in this user guide refers to Microsoft Windows operating system.

1.1 Package Contents

- VGA cable
- Power cable x 4
- Remote control
- AAA battery x 2
- USB cable
- Audio cable
- AV cable
- Stylus pen x 3
- User manual CD wizard
- Quick start guide
- RS232 adapter
- Clamp x 5
- Plate
- Screw x 3

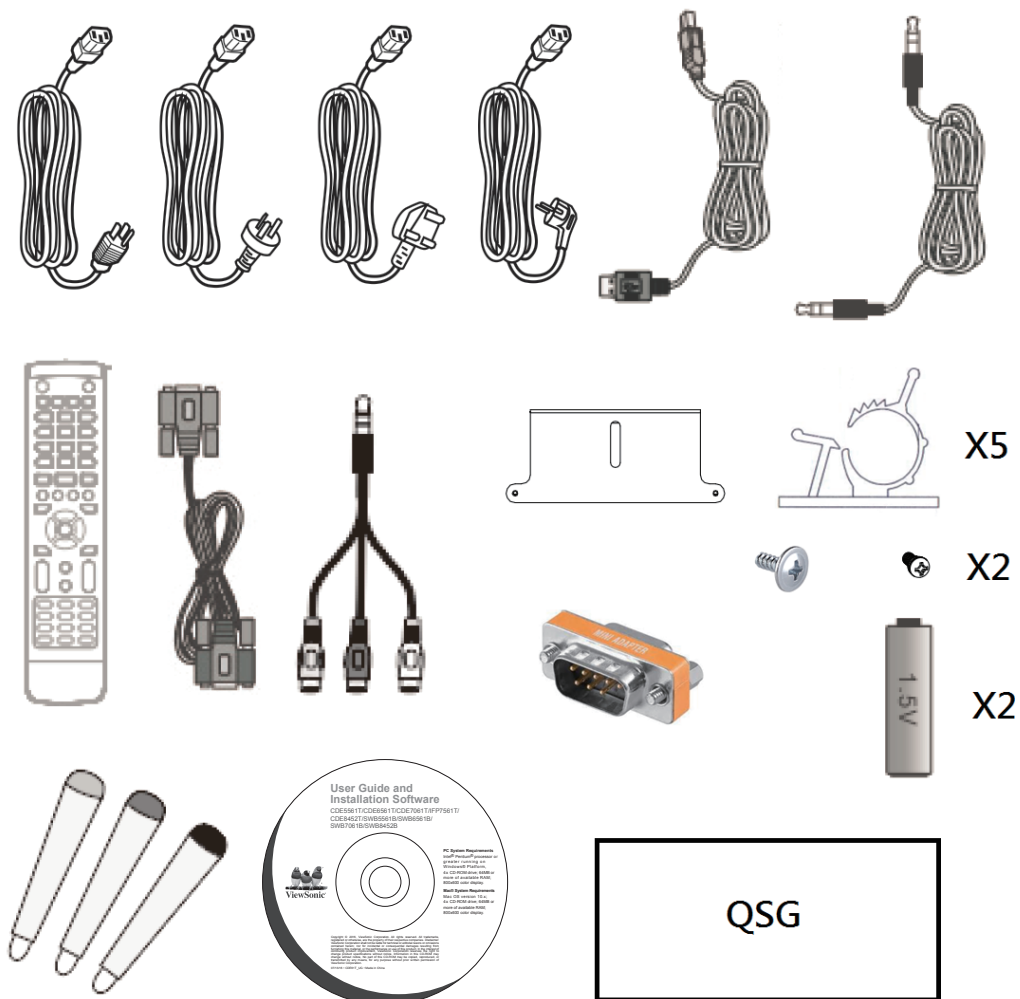

1.2 Wall Mount Kit Specifications (VESA)

Please follow the instructions in the wall mount installation guide to install your wall mount or mobile mount bracket. If attaching to other building materials, please contact your nearest dealer.

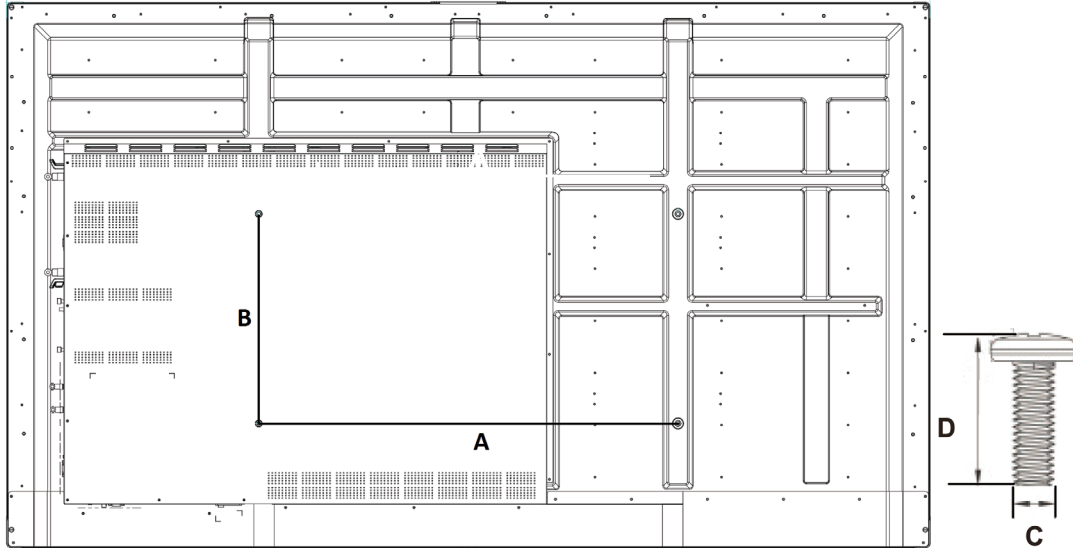

inch	VESA Spec. (A x B)	Standard Screw (C x D)	Quantity
IFP6550 - 65"	600 x 400 mm	M8 x 25 mm	4
IFP7550 - 75"	800 x 400 mm	M8 x 25 mm	4
IFP8650 - 86"	800 x 400 mm	M8 x 25 mm	4
IFP5550 - 55"	400 x 400mm	M8 x 25mm	4

- ViewSonic provides the standard dimensions for wall mount kits as shown in the table above.
- To find the perfect mount, please browse www.viewsonic.com or call our service team.
- When purchasing our wall mount kit, a detailed install manual and all parts necessary for assembly are provided.
- Do not use the screws that longer than the standard dimension, as they may cause damage to the inside of the LCD display set.

2. Smart Whiteboard/LCD Display Features

This section introduces you to the features of your LCD Display.

Note: The features or applications described in this User's manual may vary depending on the device model purchased.

2.1 Control Panel Overview

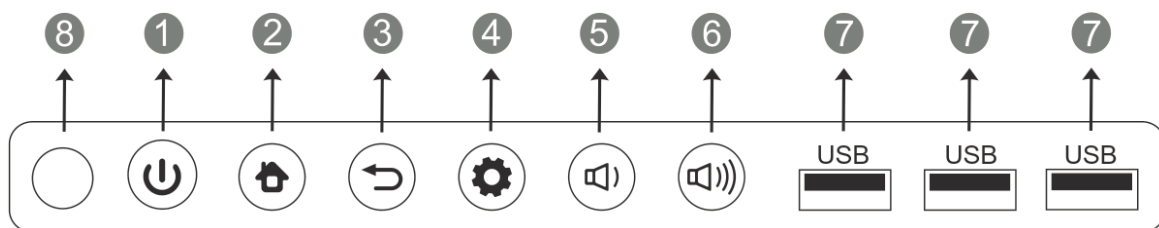

Item	Description
1	Press the key to turn on the device Press the key to turn on/off the screen Press and hold the key to turn off the device
2	Back to Embedded Player main interface
3	Return to Embedded Player previous level
4	Call up function menu
5	Decrease volume
6	Increase volume
7	USB port for Embedded Player and internal PC
8	Receives signals from the remote control

2.2 Terminal Interface Overview

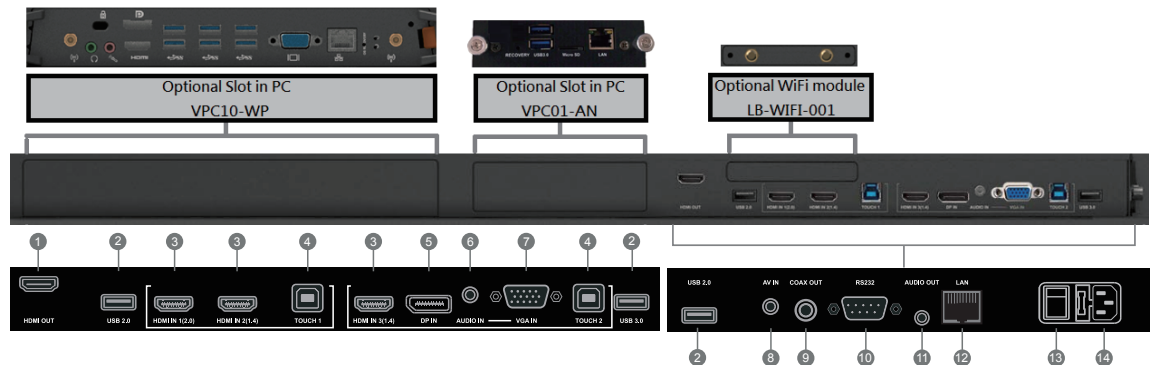

Item	Description
①	Connected to display devices with HDMI input function
②	USB port for Embedded Player
③	High-definition multimedia interface signal input, connect to PC with HDMI output, set-top box, or other video device HDMI 1 supports up to 3840x2160@60Hz HDMI 2 and 3 support up to 3840x2160@30Hz
④	Touch signal output to the external PC Touch 1 for HDMI IN 1 and 2 Touch 2 for HDMI IN 3, DP IN and VGA IN
⑤	Connected to devices with DisplayPort output function DP supports up to 3840x2160@60Hz
⑥	External computer audio input
⑦	External computer image input
⑧	Composite video and audio input
⑨	Coaxial output
⑩	Serial interface, used for mutual transfer of data between devices
⑪	Audio output to the external speaker
⑫	Standard RJ45 (10/100MHz) Internet connection interface(This network port is used for Embedded Player and Slot in PC)
⑬	Power On / Off switch
⑭	AC power input

2.3 Remote Control Overview

- ① :
Press to turn the display ON/OFF
- ② :
Mute / Unmute
- ③ DISPLAY :
Display information of the current input source
- ④ P.MODE :
Blank screen
- ⑤ S.MODE :
Freeze screen
- ⑥ Numeric button:
Numeric input button
- ⑦ -/--, ALT+TAB:
Press to switch between PC applications
- ⑧ 0:
Numeric input button
- ⑨ , ALT+F4 :
Close current PC window
- ⑩ INPUT:
Source selection button
- ⑪ MENU:
Press to display Menu
- ⑫ RED+ALT:
Screen capture
- ⑬ GREEN+TAB:
PC 'Tab' button
- ⑭ YELLOW+DESKTOP:
Switch to slot in PC desktop
- ⑮ BLUE+BACKSPACE:
PC 'Backspace' button
- ⑯ START , D. MENU:
PC 'Windows' button
- ⑰ , D. TITLE:
PC 'Menu' button
- ⑱ :
Press to scroll up
- ⑲ :
Press to scroll left
- ⑳ :
Press to scroll right
- ㉑ :
Press to scroll down
- ㉒ ENTER:
Enter button. Press it to select options.
- ㉓ , D. USB:
Writing software startup
- ㉔ ESC/EXIT, D. SETUP:
Shortcut button to exit dialog boxes
- ㉕ EPG:
Back
- ㉖ FAV, SPACE:
PC 'Space' button
- ㉗ CH. +, CH. -:
CH+ : PC previous page
CH- : PC next page
- ㉘ VOL+, VOL-:
Increase / Decrease volume
- ㉙ F1:
Windows F1 Function
- ㉚ F2:
Windows F2 Function
- ㉛ F3:
Windows F3 Function
- ㉜ F4:
Windows F4 Function
- ㉝ F5:
Windows F5 Function
- ㉞ F6:
Windows F6 Function
- ㉟ F7:
Windows F7 Function
- ㊱ F8:
Windows F8 Function
- ㊲ F9:
Windows F9 Function
- ㊳ F10:
Windows F10 Function
- ㊴ F11:
Windows F11 Function
- ㊵ F12:
Windows F12 Function

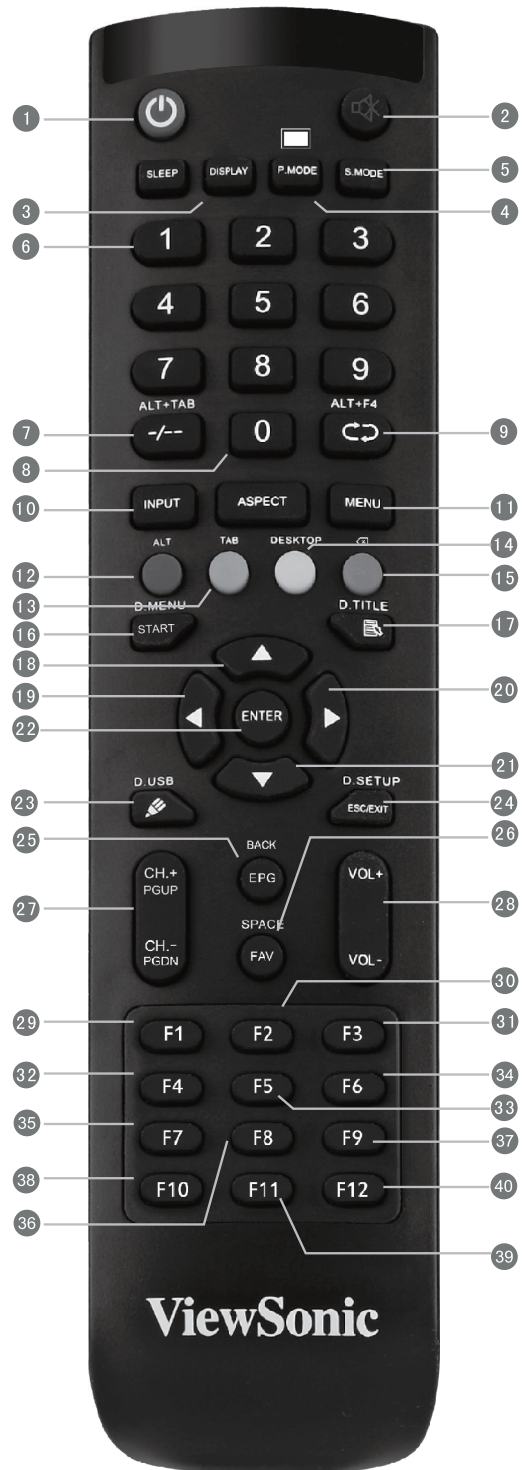

2.4 Inserting Remote Control Batteries

To insert the provided batteries into the remote control follow these instructions. We recommend that you don't mix battery types.

1. Remove the cover on the rear of the remote control.
2. Insert two "AAA" batteries, ensuring the "+" symbol on the battery matches the "+" on the battery post.
3. Replace the cover by aligning it with the slot on the remote control and snapping the latch shut.

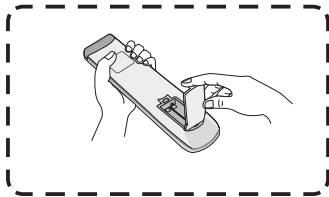

(1)

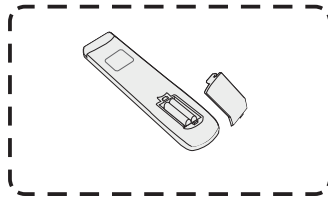

(2)

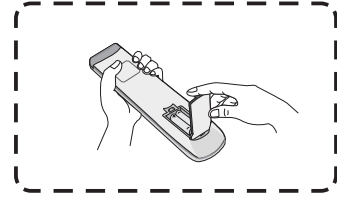

(3)

Warning: There is a risk of explosion if batteries are replaced with the incorrect type.

Note: Always dispose of old batteries in an environmentally friendly way. Contact your local government for more information on how to dispose of batteries safely.

2.5 Remote Control Receiver Range

The working range of the remote control receiver is shown here. It has an effective range of 8 meters. Make sure there is nothing obstructing the remote control's signal to the receiver.

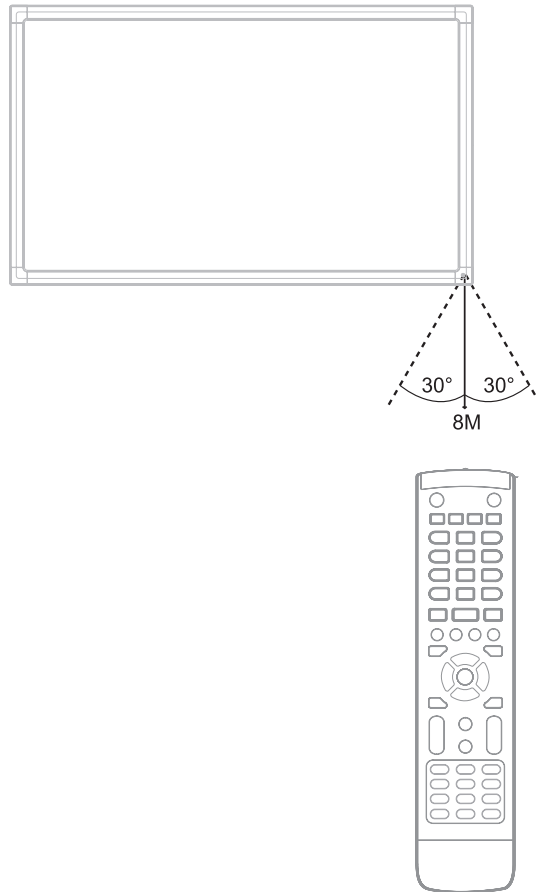

3. Setting Up Your Display

Warning: For the safety of you and your unit, please do not connect to a power supply before the external device is prepared.

3.1 Connecting an External PC

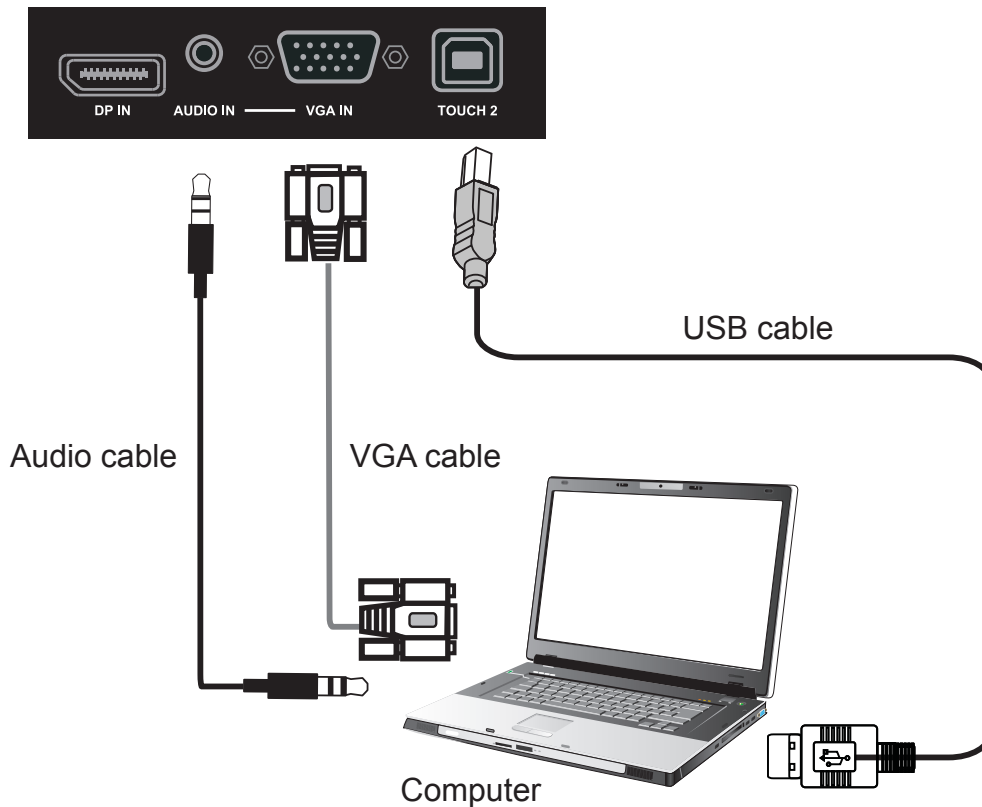

1. To display video and sound from an external PC follow the instructions below.

Note: External PCs can also be connected to the display via HDMI cable.

- Connect a VGA cable (15-pin) from your external PC to the VGA IN port on the display.
- Connect an audio cable from the AUDIO OUT port on your external PC to the AUDIO IN port on the display.

2. Connect a USB cable to the external PC from the TOUCH OUT port of the display.

Note: For optimal results, select 1920x1080p as the external computer's input resolution.

3.2 RS232 Connections

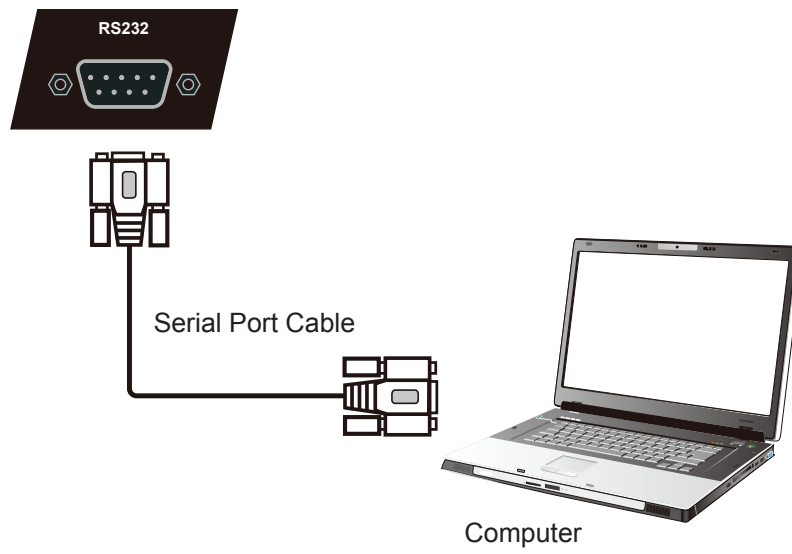

When you use a RS232 serial port cable to connect your display to an external computer, certain functions can be controlled by the PC, including power on/off, volume adjustment and more.

3.3 Connecting USB Peripherals

Just like a regular PC, it is easy to connect various USB devices and other peripherals with your smart whiteboard.

1. USB Peripherals: Plug the USB device cable into the USB IN port.
2. Networking and modem cables: Plug the router cable into the LAN IN port.
3. Microphone: Plug the microphone cable into the MIC port.

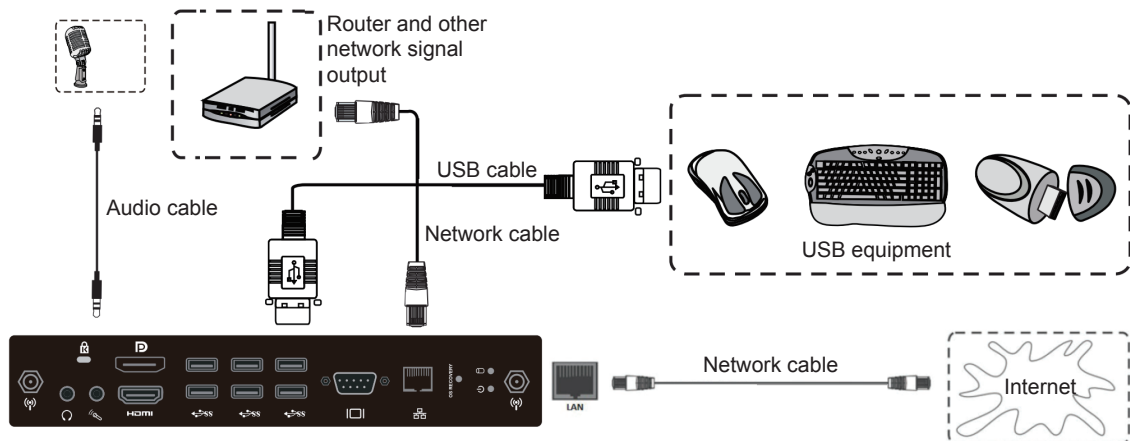

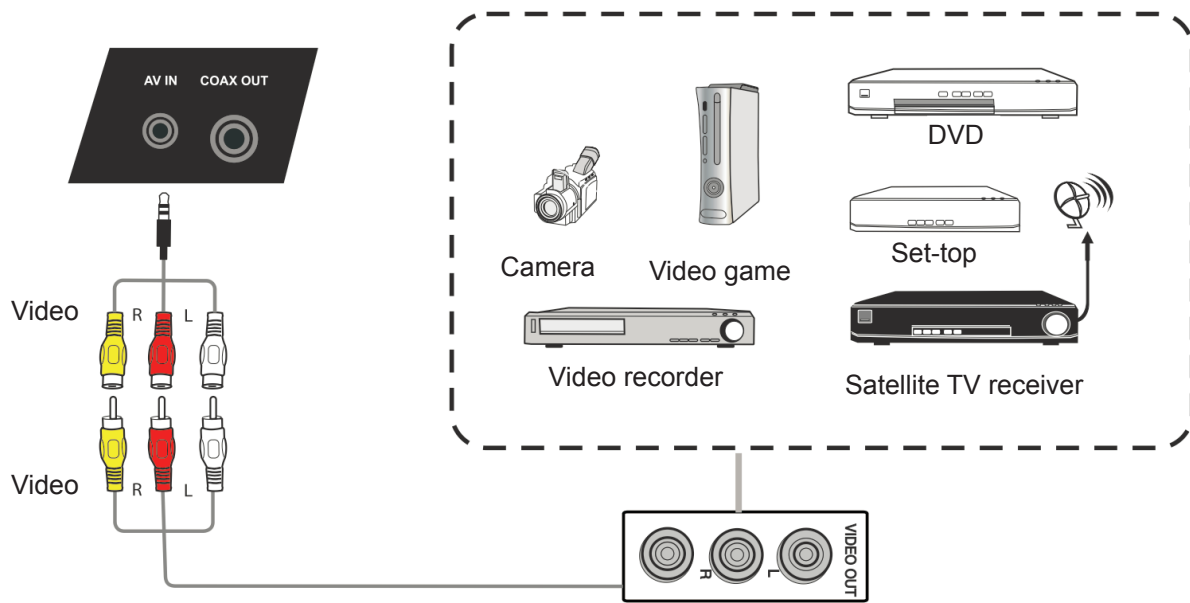

3.4 AV IN Connections

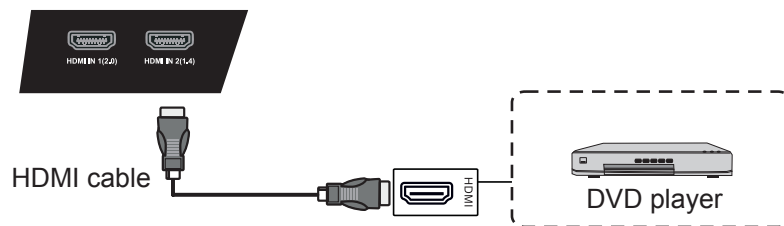

1. Connect a 3-color AV cable from the AV IN ports on your display to the AV OUT ports of a peripheral device (AV cable: Yellow is Video, Red is Audio-R, White is Audio-L).
2. Plug in the power cord, and turn on the rear-panel power supply switch.
3. Press the  button on the right-hand side of the display to turn the screen on.
4. Press the INPUT button to switch to the "AV" source.

3.5 HDMI Connections



1. Connect the HDMI cable to the HDMI ports on your display and peripheral device.
2. Plug in the power cord, and turn on the rear-panel power supply switch.
3. Press the  button on the right-hand side of the display to turn the screen on.
4. Press the INPUT button to switch to the HDMI source.

Note: HDMI 1 supports up to 3840x2160@60Hz
HDMI 2/3 supports up to 3840x2160@30Hz

3.6 Coaxial Connections

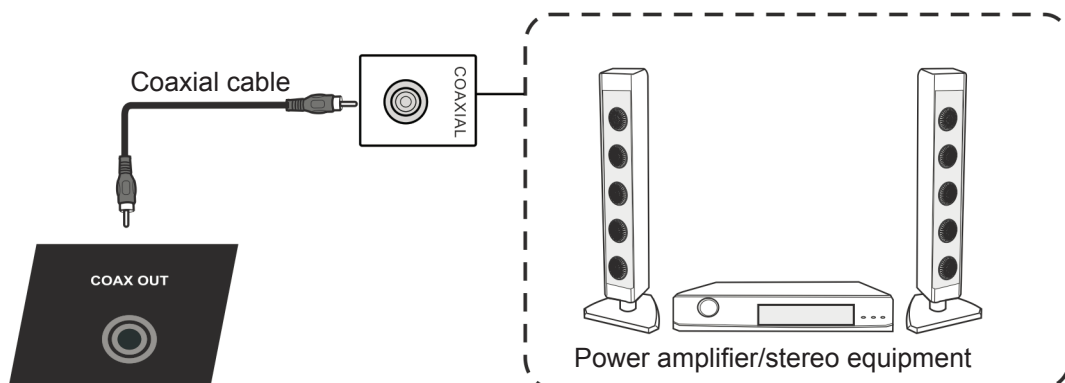

1. Connect a coaxial cable from DIGITAL OUT to your sound system's coaxial connector.
2. Plug in the power cord, and turn on the rear-panel power supply switch.
3. Press the  button on the right-hand side of the display to turn the screen on.

3.7 Video Output Connection

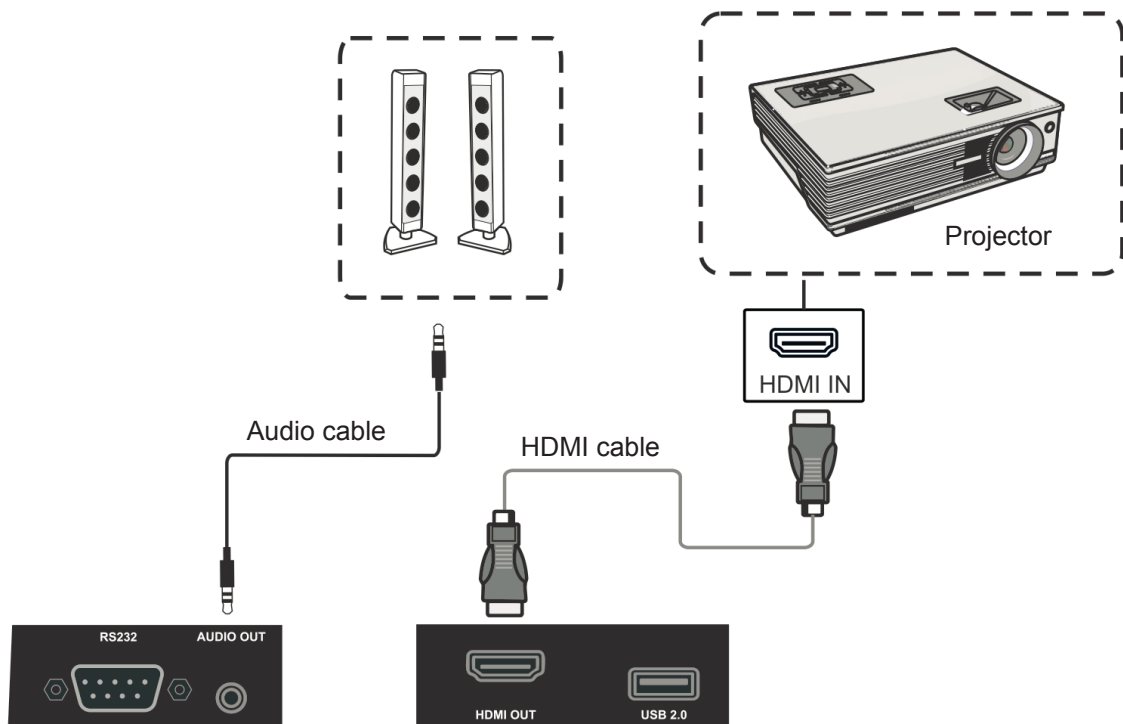

1. Use HDMI cable to connect display devices with HDMI in, and use audio cable to connect sound input.
2. Plug in the power cord, and turn on the rear-panel power supply switch.
3. Press the POEWR button on the right-hand side of the display to turn the screen on.

Note: The HDMI OUT can output any source signal, and the maximal resolution is 1080P@60Hz.

4. OSD Menu Operation

4.1 General Setting

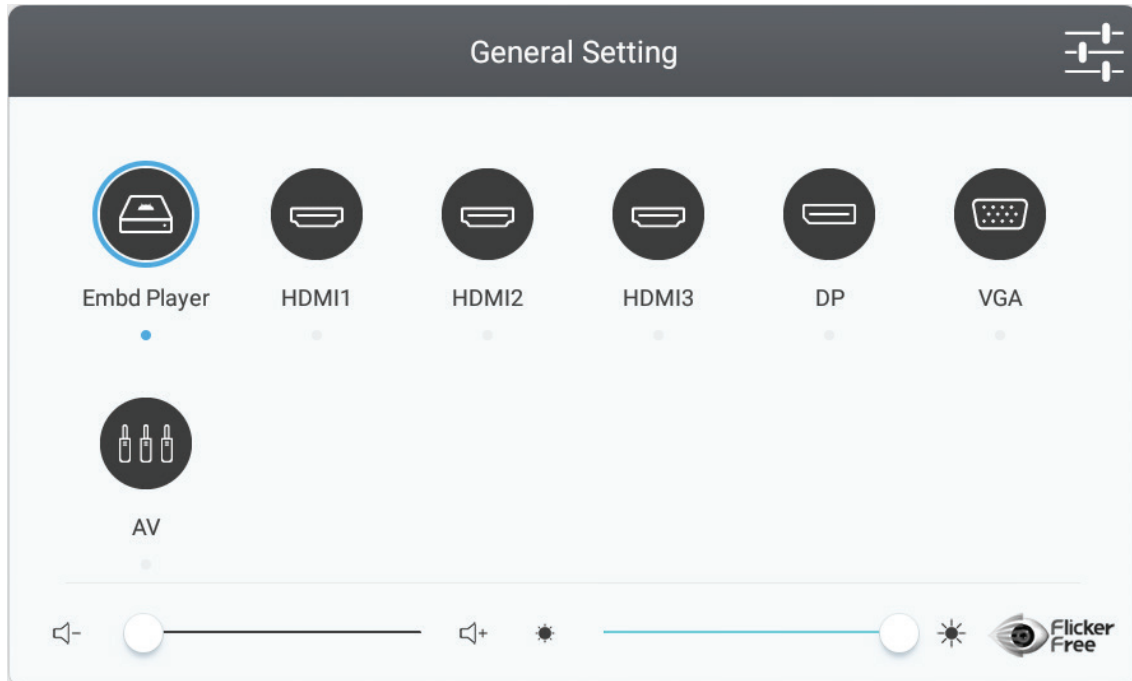

To select an input source:

1. Press INPUT button on remote control to display the general setting menu, then press DOWN to enter the input source menu..
2. Press DOWN / UP / LEFT/ RIGHT to select the input source you want.
3. Press Enter button on remote control or click with touch pen to select the input source.
4. Press BACK key on remote control or click blank area outside menu with touch pen to quit the on-screen menu.



To adjust the backlight and enable/disable Flicker Free:

1. Press INPUT button on remote control to display the general setting menu.
2. Drag icon directly with touch pen to adjust the backlight value.
3. Click Flicker Free icon to enable/disable the function.
4. Press EXIT key on remote control or click blank area outside menu with touch pen to quit the on-screen menu.



To adjust the volume:

1. Press INPUT button on remote control to display the general setting menu.
2. Drag icon directly with touch pen to adjust the value.
3. Press < Mute > button on remote control to enable or disable mute function.
4. Press EXIT key on remote control or click blank area outside menu with touch pen to quit the on-screen menu.

4.2 More OSD settings

Press MENU button (in any source but not Embedded Player source) on remote control to display general settings menu.

Audio Setting



1. Turn the volume, bass, treble and balance icons directly with touch pen to adjust value. Or press DOWN / UP / LEFT/ RIGHT to select icon then press VOL+/VOL- to adjust value.
2. Click the Standard, Standard, Meeting, Class, Custom icons directly to change the audio efficacy.
3. Click the Mute icon directly to enable/disable mute function.

Screen Setting

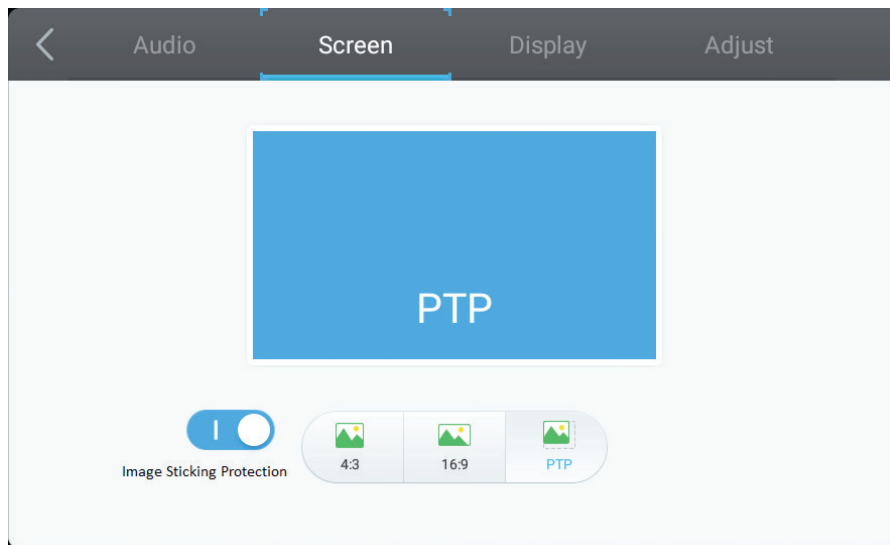

1. Click Image Sticking Protection to enable/disable the function.
2. Click the 4:3 and 16:9 icons directly to change the ratio.

Display Setting



1. Turn the Brightness, Contrast, Hue and Sharpness icons directly with touch pen to adjust value. Or press DOWN / UP / LEFT/ RIGHT to select icon then press VOL+/VOL- to adjust value.
2. Click the Standard, Bright, Soft and Customer icons to change the display efficacy.
3. Click the Standard, Cold and Warm icons to change the color temperature.
4. Drag  icon directly with touch pen to adjust the blue light value.

Adjust Setting

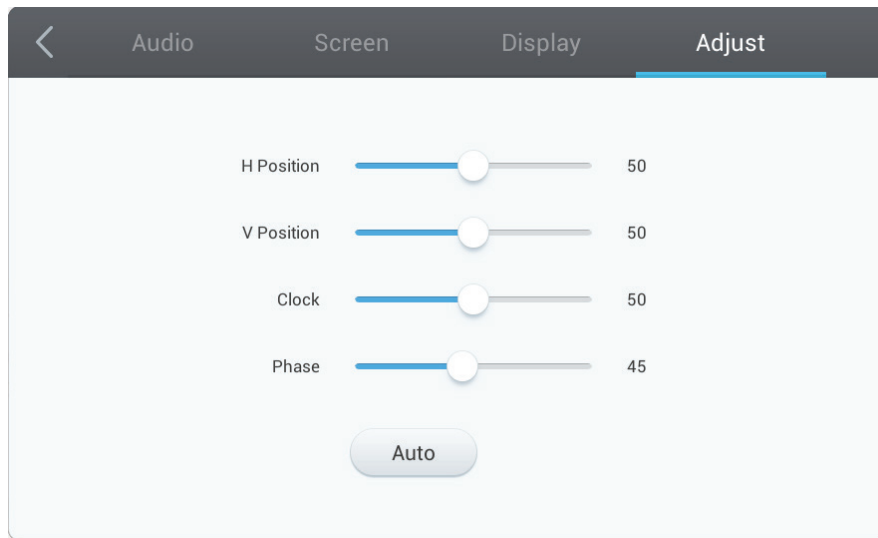

1. Drag icon directly with touch pen to adjust the value.
2. Click the Auto icon directly to do the auto adjustment.

4.3 Annotation Menu

vPen



Annotation Menu



Floating Pen Menu











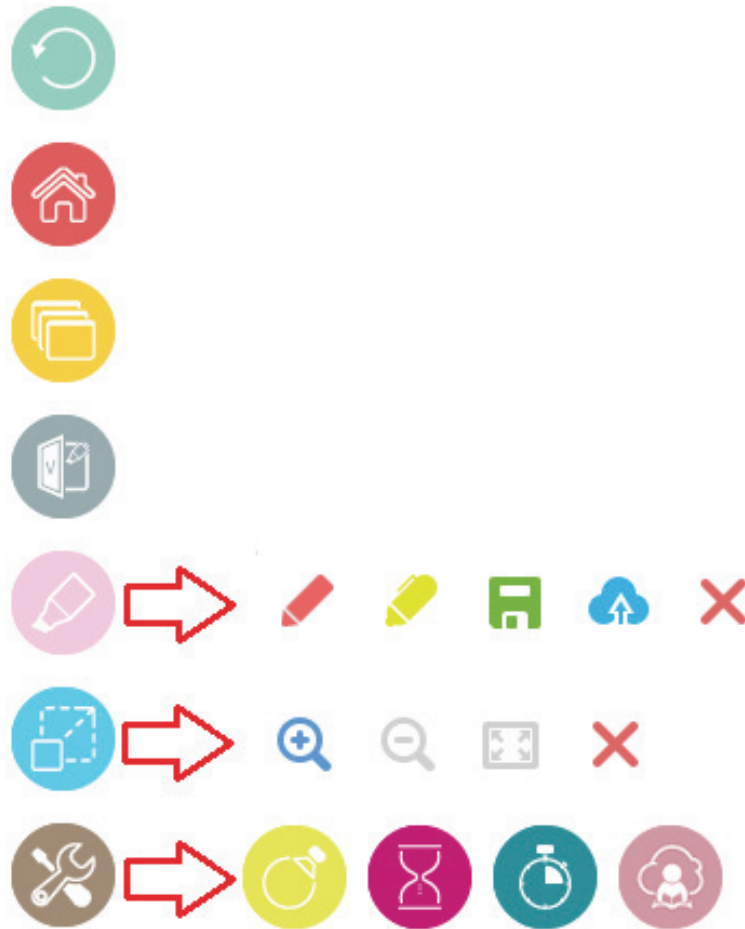

Short cut Menu









In any input source, to place two fingers on the screen (about 20~50mm spacing) and stay more than two seconds to call up annotation menu. In this mode, user can only use touch pen to operate.

Item	Description
Annotation menu	Pop up sub-menu.
Return	Click to return to previous operation interface.
Main	Click to return to main interface of Embd Player.
Pen	Pop up Pen menu. Click to make annotation in the picture, click again to change color.
Screen capture	Click and drag a rectangle on screen. It can arbitrarily adjust position and shape of the rectangular. Storage location: /Storage/vBoard
Save as	Click to save the current image. Storage location: /Storage/vBoard
Eraser	Click to erase handwriting as required.
Short cut	Pop up short cut menu.
vBoard	Click to enter vBoard software.
ViewBoard Cast	Click to enter ViewBoard Cast software.
App	Click to App interface of Embedded Player.
Close	Click to close annotation menu.

Side Tool Bar



Item	Description
 Return	Click to return to previous operation interface. (Only for Embedded Player source)
 Home	Click to return to home interface of Embedded Player.
 Short cut	Pop up Short cut menu.(Only for Embedded Player source) The Short cut menu will record currently used APP
 vBoard	Click to enter vBoard software
 Pen	Pop up Pen menu Click to make annotation in the picture Note: In pen mode, it supports up to 10 points for writing
 Color	Click to change pen color
 Save as	Click to save the current image to internal memory
 Save to cloud	Click to save the current image to cloud
 Close	Click to close menu

	Zoon in/out	Pop up Zoon in/out menu Click to adjust Zoon in/out
	Zoom in	Click to zoom in current image
	Zoom out	Click to Zoom out current image
	Original	Click to return original size
	Tools	Pop up tools menu
	Spotlight	Click to open Spotlight
	Count Down	Click to open Count Down function
	Stop Watch	Click to open Stop Watch function
	Air Class	Click to open Air Class function

Air Class

Click  to enter Air Class. After participant uses Android cellphone to scan the QR code to join Air Class, the host needs to click “ENTER THE CLASS”.

Note: Please make sure participant and host are in the same LAN with the IFP50.

Cellphone operation

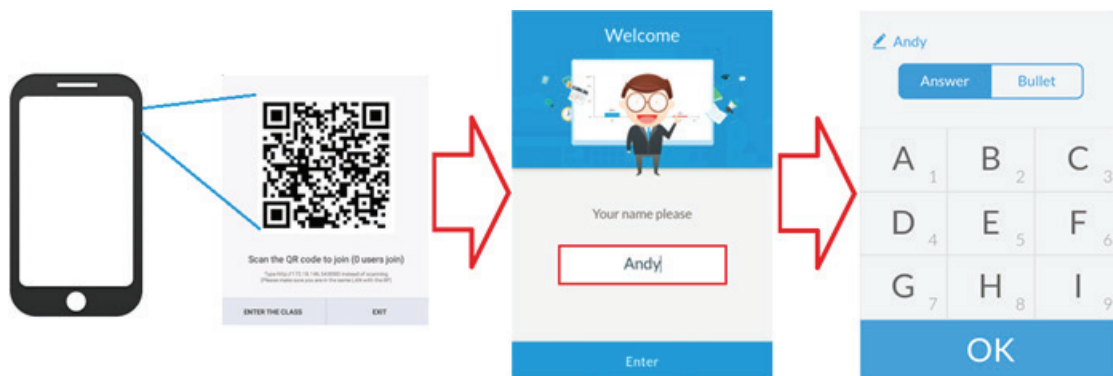

1. Scan the QR code that appears on IFP50 screen.
2. Input participant's name then click Enter icon.
3. Cellphone operational interface will appear.

IFP50 operation

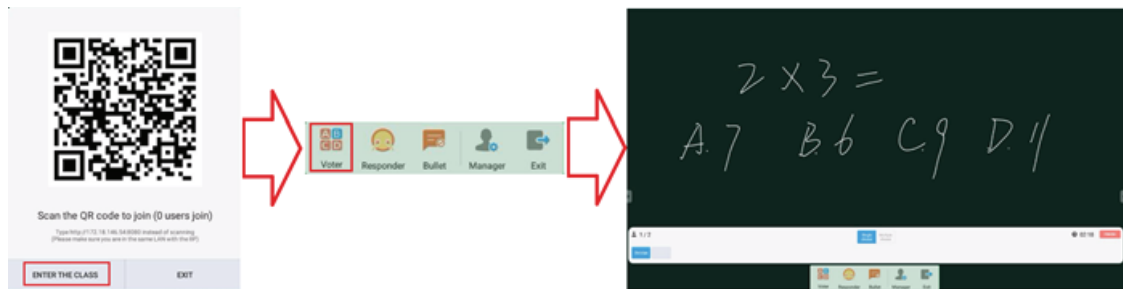

1. Click ENTER THE CLASS icon.
2. Click Voter icon.
3. IFP50 operational interface will appear.

Voter

Click  icon to enter Voter interface. Click “Single choice” or “Multiple choice” icon to define answer type.

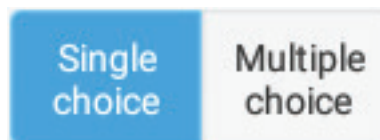

Click BEGIN icon let participant starts answer.



After participant presses OK icon to done the answer, the IFP will show the participant's name on screen.

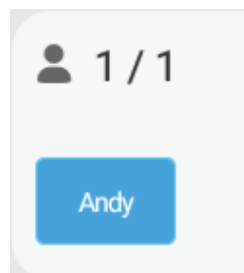

Click Finish icon to done the vote, then Answer statistics will be displayed.

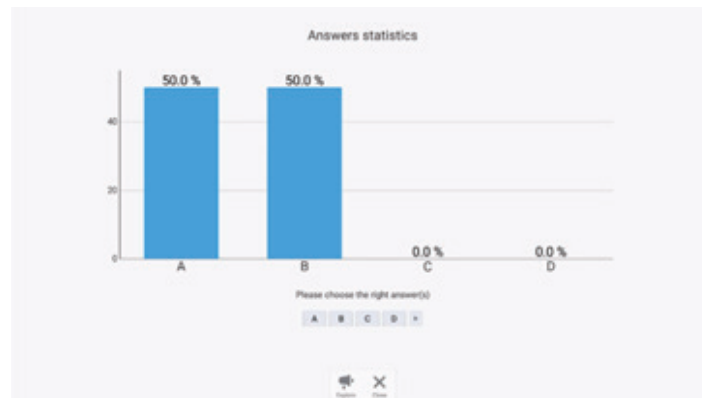

Choose the right answer to show the correct rate.

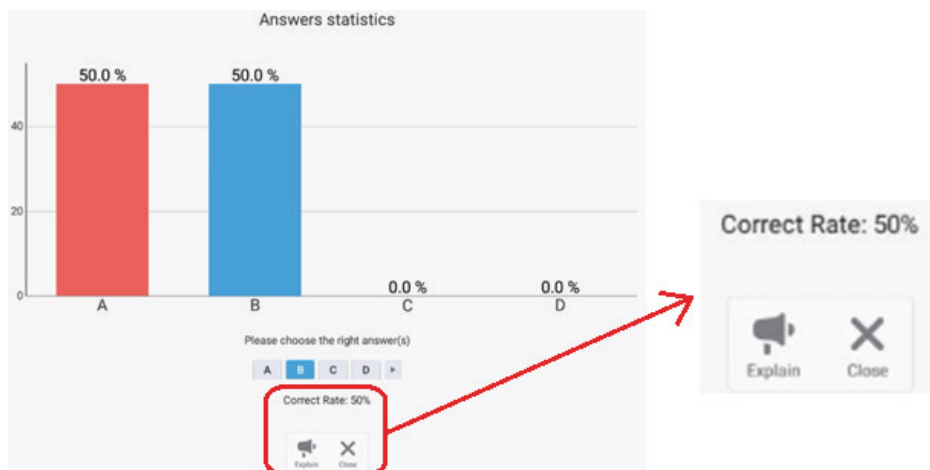

Click  icon to analyze.

$2 \times 3 =$

A. 7 B. 6 C. 9 D. 11

Answers statistics

Option	Percentage
A	50.0%
B	50.0%
C	0.0%
D	0.0%

🔊 ✕

Vote! Responder Submit Message Exit

Responder

Click 🥁 to enter Responder. Participant needs click OK icon to answer.

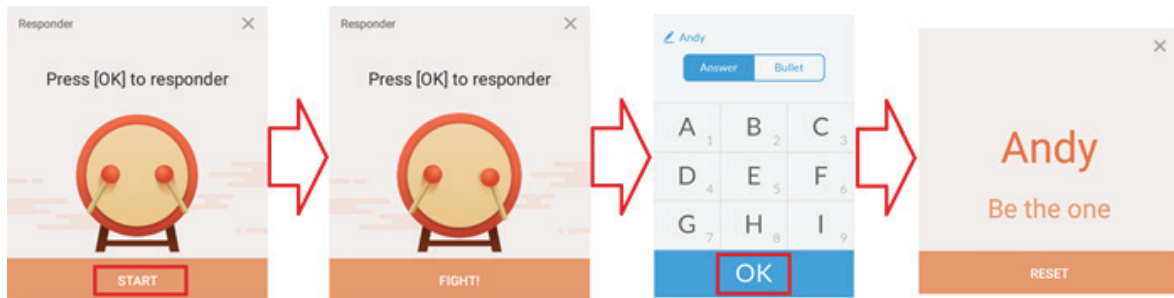

Message

Click 🗨️ to enable/disable message function.

Message operation

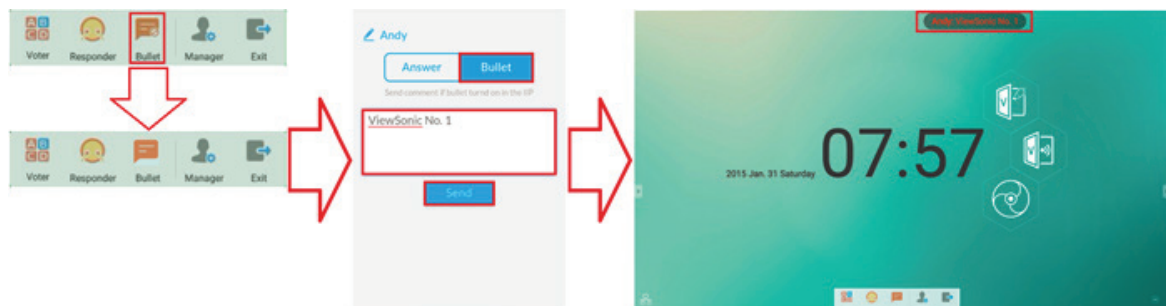

1. Click Message icon to enable the function.
2. Participant clicks Message icon the change to Message interface.
3. Participant key in message then click Send icon.
4. The message will appear on IFP50 upper side.

Manager

Click 👤 to appear QR code to let more participants join the class.



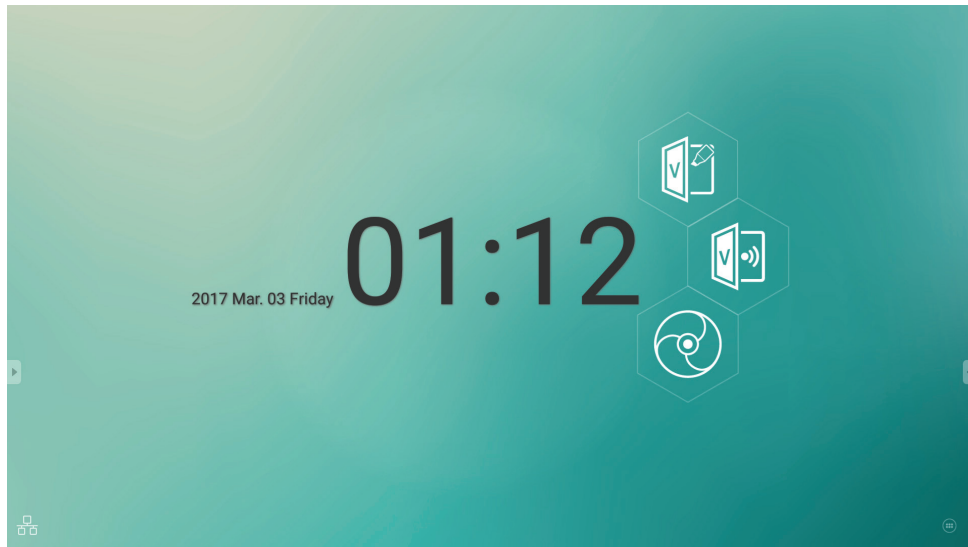

Exit

Click ➡️ to exit class interface.

4.4 Embedded Player Interface









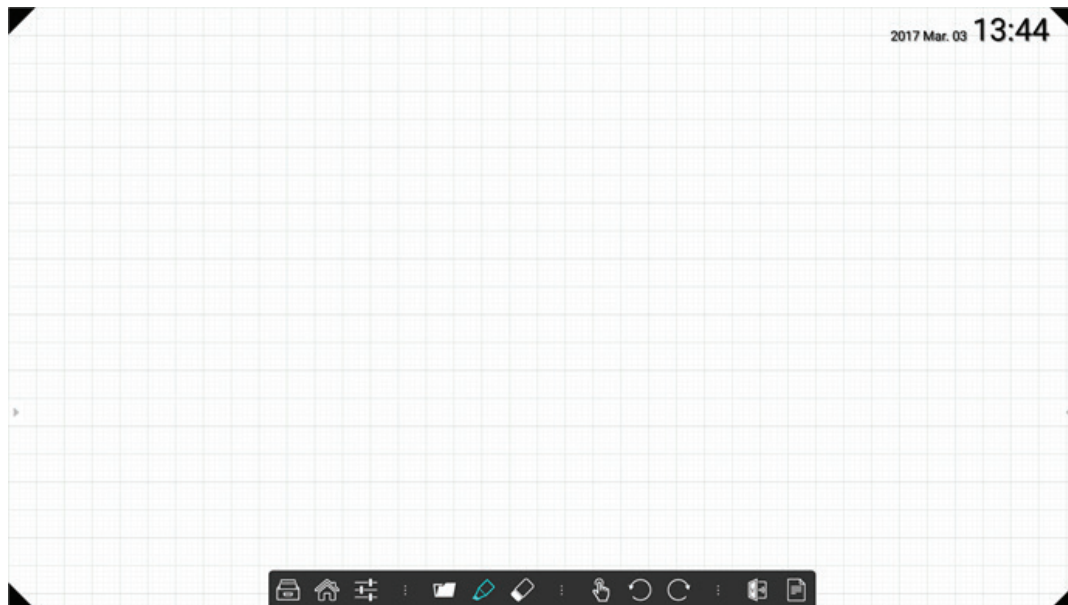









Switch to Embedded Player source to display ViewBoard Launcher interface that shown above.

Item	Description
 vBoard	Click to vBoard software
 ViewBoard Cast	Click to ViewBoard Cast software
 Browser	Click to enter internet page
 APPs	Click to enter Embedded Player application management page
 Network	Click to enter Ethernet settings

vBoard











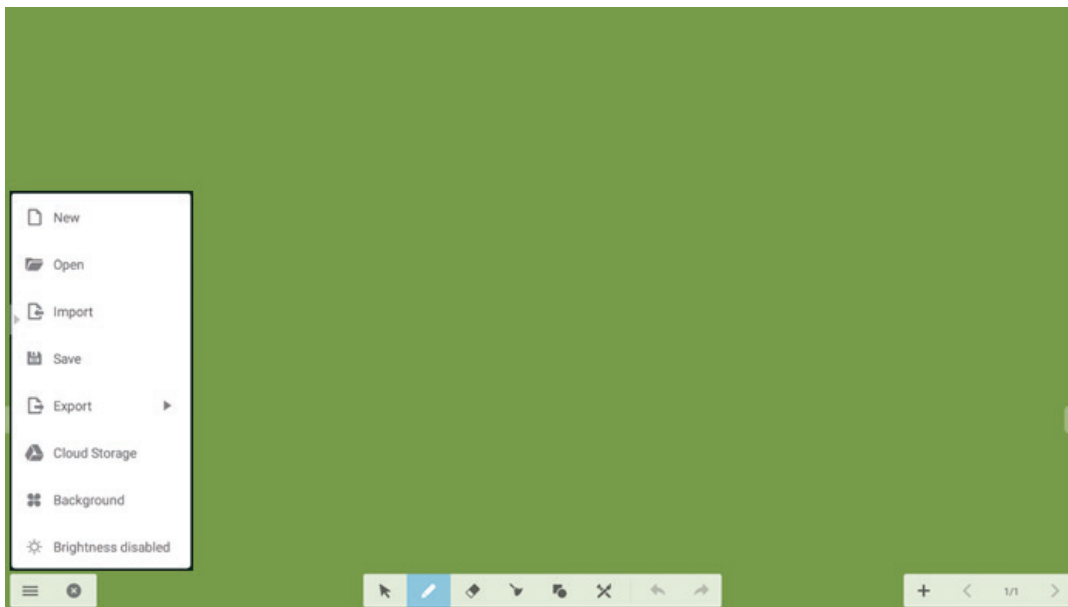



Item	Description
 File	New/Open/Save file
 Home	Return to home page
 APPs	Click to enter Embedded Player application management page
 Settings	Open settings dialog
 Open Doc	Open a media/document file via default app
 Pen	Click to pop a parameter dialog for pen drawing. Color, thickness and shape object can be selected through this dialog Then close dialog to start drawing Note: In pen mode, one point to write and three points to erase.
 Eraser	Click to use an eraser
 Select	Select any object on the board
 Undo	Cancel the last change
 Redo	Revert the effects of the undo action
 ViewBoard Cast	Click to ViewBoard Cast software











 Page	Click to show page management
	Click to show or hide the grid
	Click to show or hide the clock
	Click to reverse tool bar
	Click to reverse tool bar

Note: Two points for zoom in/out and navigate.

vBoard Lite







Item	Description
 Menu	Click to pop up sub-menu
 Exit	Click to exit vBoard Lite
 Select	Select any object on the board
 Pen	Click to write or to set type, color and thickness Note: In pen mode, it supports up to 10 points for writing
 Eraser	Click to use an eraser
 Clean	Click to clean all the elements
 Graphic	Click to create or press and hold for three seconds to set type, color and thickness
 Watercolor	Click to entry watercolor page
 Undo	Cancel the last change
 Redo	Revert the effects of the undo action
 Add page	Click to add a new page

	Previous	Click to previous page
	Page	Display page number
	Next	Click to next page
	New	Click to create new file
	Open	Click to open *.enb format file
	Import	Click to import *.jpg format file
	Save	Click to save current content to *.enb format
	Export	Click to export current content
	Cloudy	Click to upload the current image to cloud storage.
	Background	Click to change background
	Auto brightness	Click to enable/disable auto brightness

Watercolor



Item	Description
 Pen	Click to select different type Note: In pen mode, it supports up to 10 points for writing
 Thickness	Click to change thickness
 Palette	Select color then press and rotate the circle on palette to adjust color
 Dipper	Click dipper to dip up color for pen
 Color disc	Click to change pen color

ViewBoard Cast

Click  to run ViewBoard Cast application.

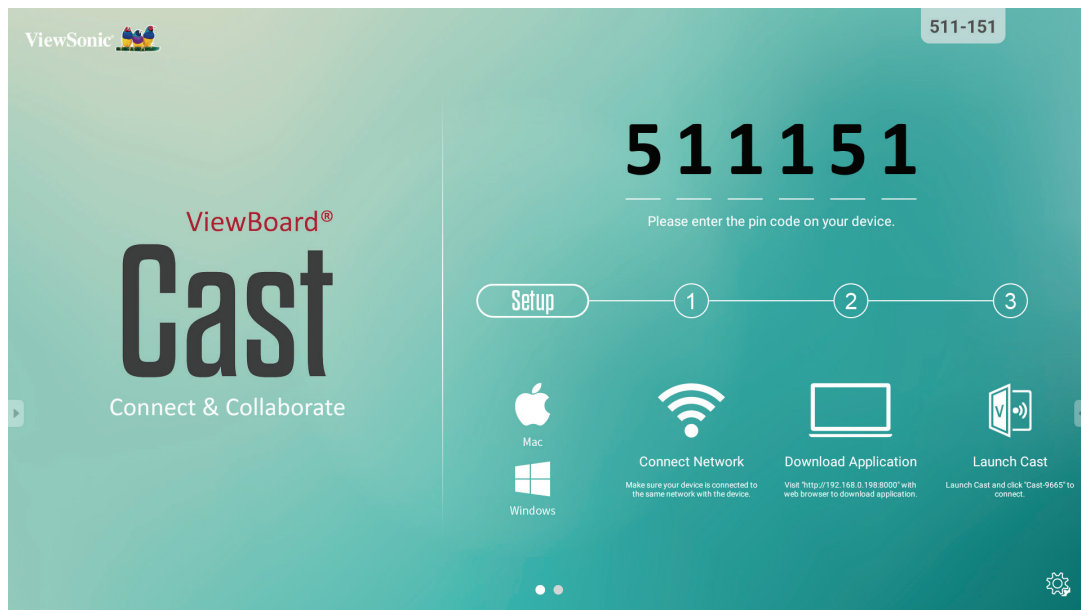

Mac and Windows device

1. Make sure your device is connected to the same network with IFP50.
2. Visit the address that shown on IFP50 to download application.
3. Launch ViewBoard Cast and click the icon number that shown on IFP50.



iOS







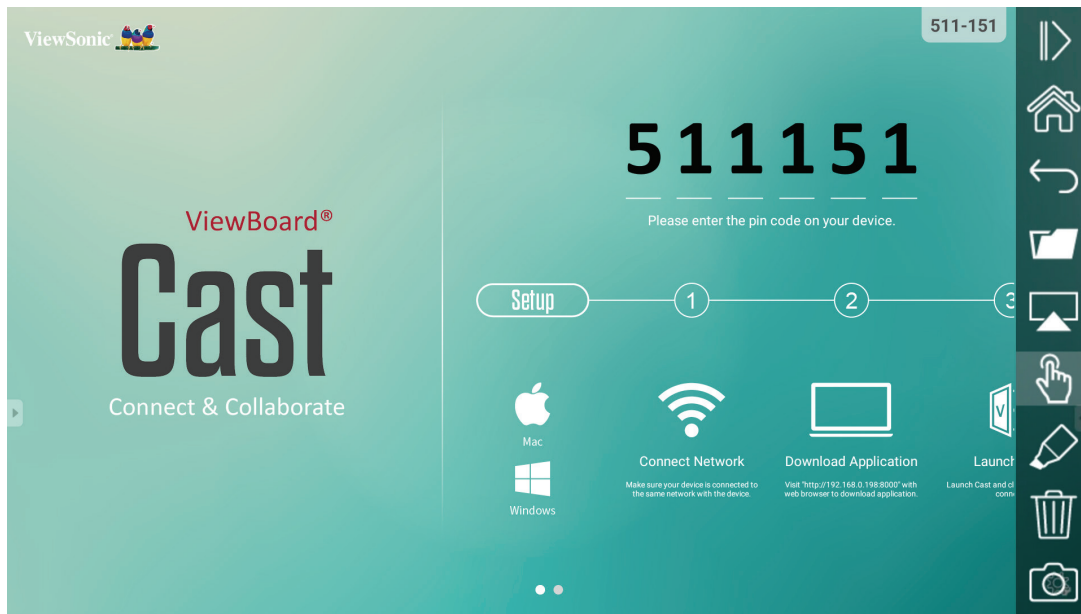

1. Make sure your device is connected to the same network with IFP50.
2. Enter password that shown on IFP50.
3. Slide up at the bottom enter the quick set Open AirPlay.
4. Select the device, then the iOS operate interface will appear.

Android

1. Make sure your device is connected to the same network with IFP50.
2. Enter password that shown on IFP50.
3. Scan the QR code that shown on IFP50 to download the client.
4. Open the ViewBoard Cast client.

Mobile device interface



Item		Description
	Toggle	Click to hide or display tool bar
	Home	Click to return to home interface
	Return	Click to return to previous operation interface
	Folder	Click to view or open mobile device internal file
	Screen sharing	Click to share screen (Android 5.0 above supported)
	Touch	Click to change to touch mode
	Pen	Click to make annotation in the picture Click to change color or thickness
	Clear	Click to clean all the elements
	Camera	Click to use camera then send the image to IFP50

Zoom

Click  to run Zoom application.

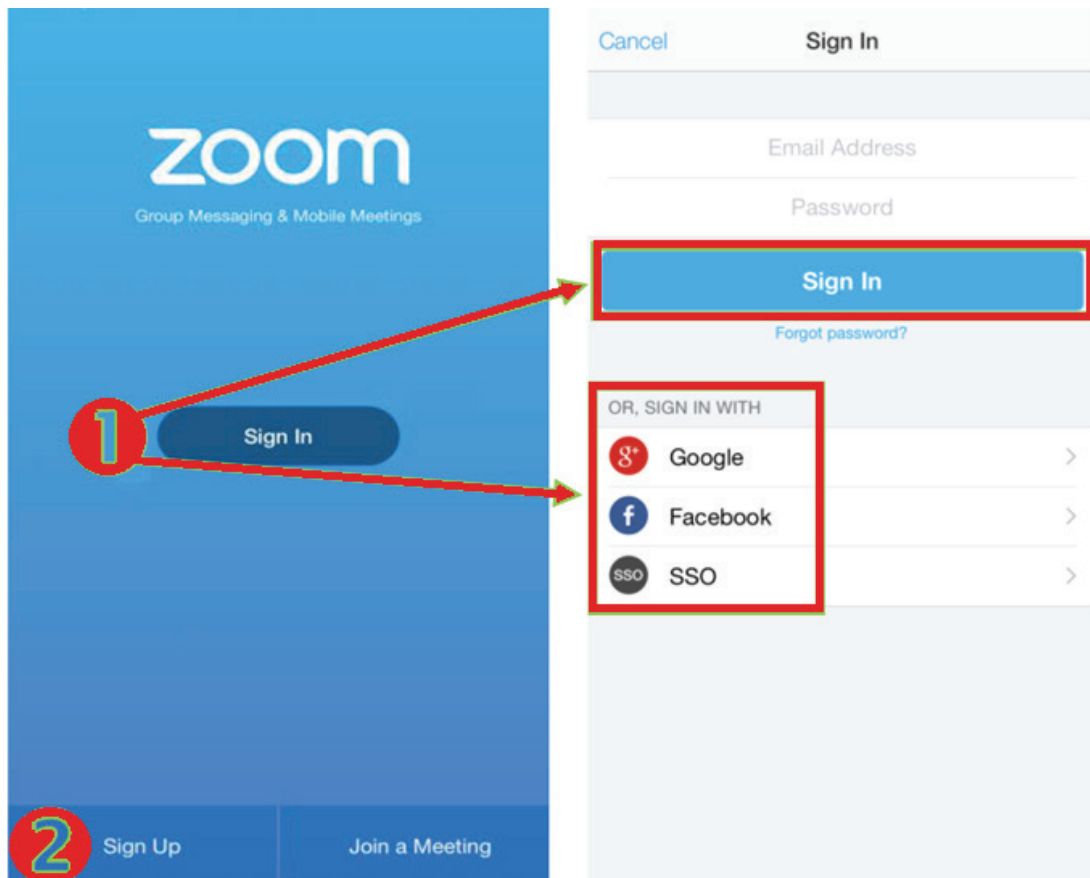

1. Click Sign In. Enter your email and password or sign in with your Google, Facebook or SSO account.
2. If you do not have a Zoom account, you should select Sign Up.

Join a Meeting

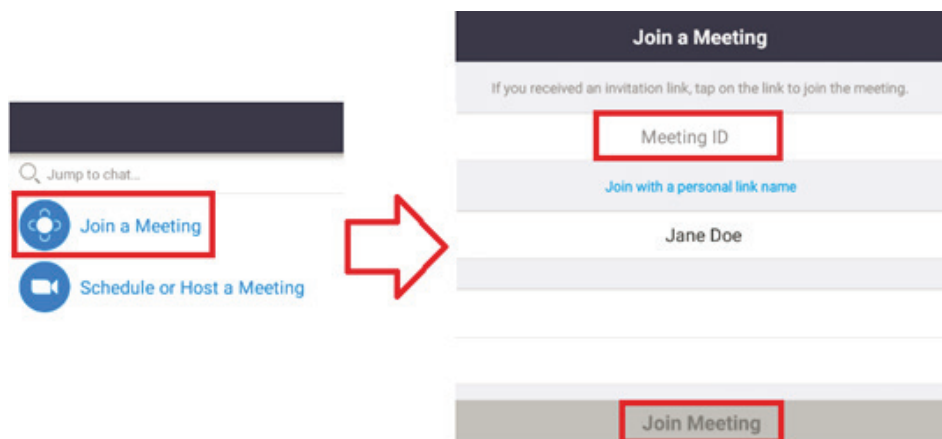

1. Select Join a Meeting.
2. Enter the Meeting ID of the meeting you want to join.
3. Click Join Meeting.

Start an Instant Meeting

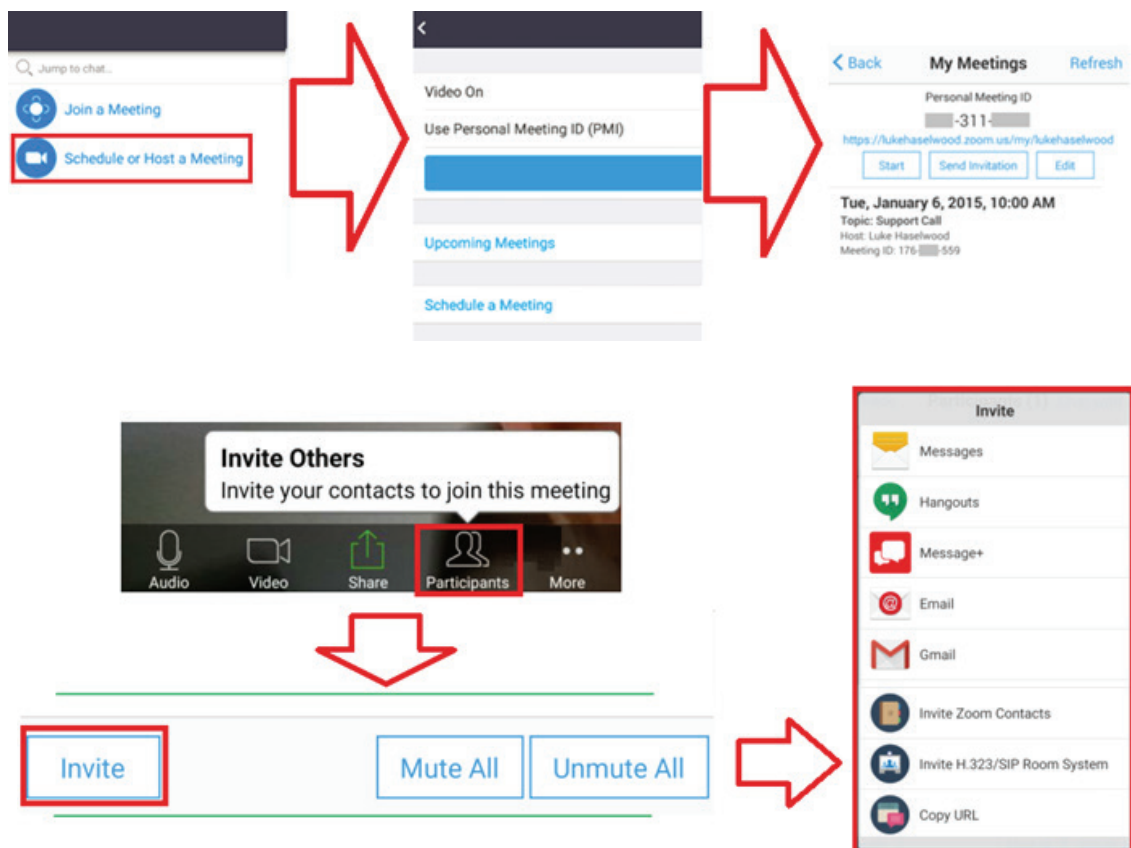





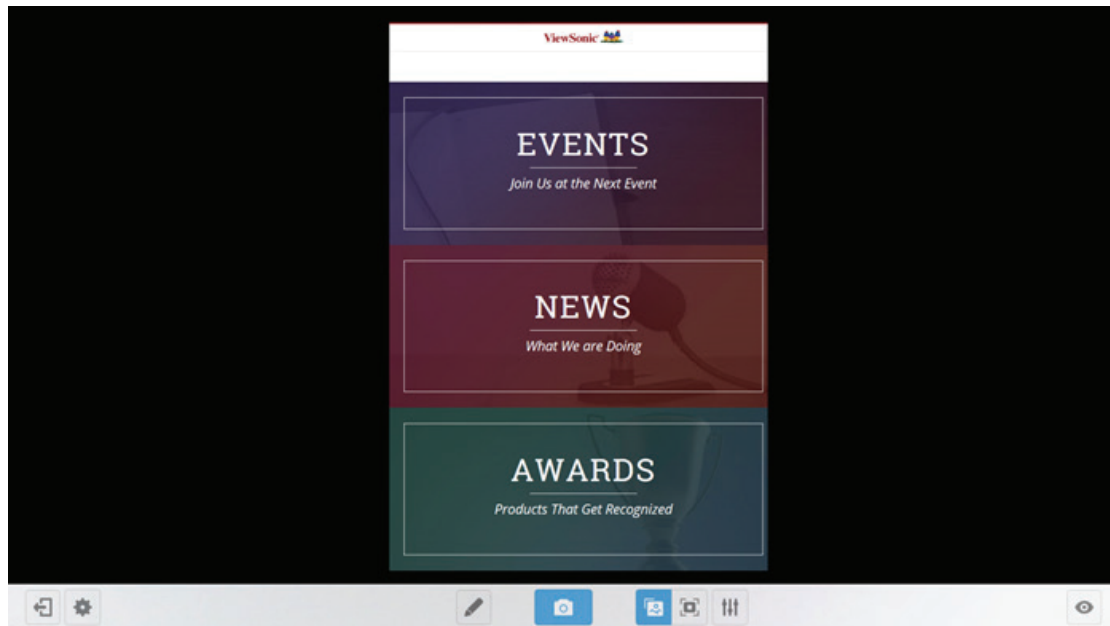

1. Select Schedule or Host a Meeting.
2. Choose the meeting options:
 - Choose to have Video On or off.
 - Choose to Use Personal Meeting ID or a unique meeting ID.
3. Click Start a Meeting.
4. Invite meeting participants by clicking the Participants icon at the bottom of the screen.
5. Click Invite at the bottom of the Participants screen.
6. Select the participants using the contact method you want to use for inviting participants.

Visualizer

Click  to run Visualizer application.





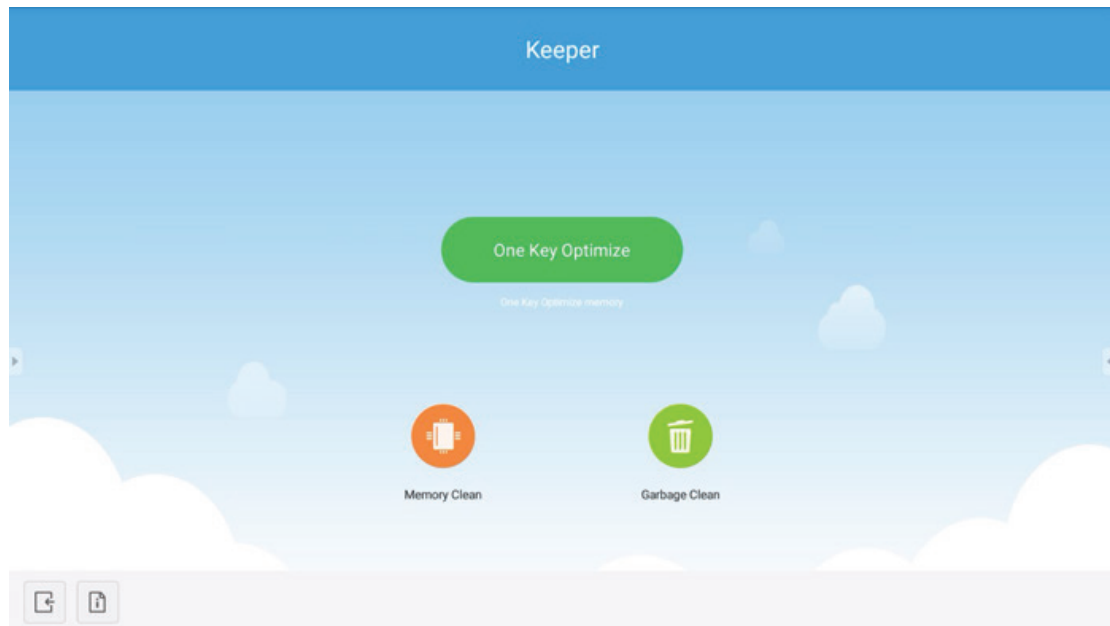

Item	Description
 Exit	Click to exit
 Resolution setting	Click to change camera resolution
 Pen	Click to make annotation in the picture
 Screen shot	Click to screen shot
 Adjustable mode	In this mode, user can use two fingers to zoon in/out and rotate the image
 Full screen	Click to show as full screen

Keeper

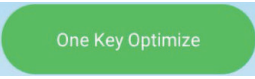
Click  to run Keeper application.



Item		Description
	One Key Optimize	Click to optimize the system, memory clean and garbage clean
	memory clean	Click to memory clean
	Garbage clean	Click to garbage clean
	Information	Click to check the system information
	Exit	Click to exit

Screen Lock

Click  to set screen lock password or enable screen lock.

Set password

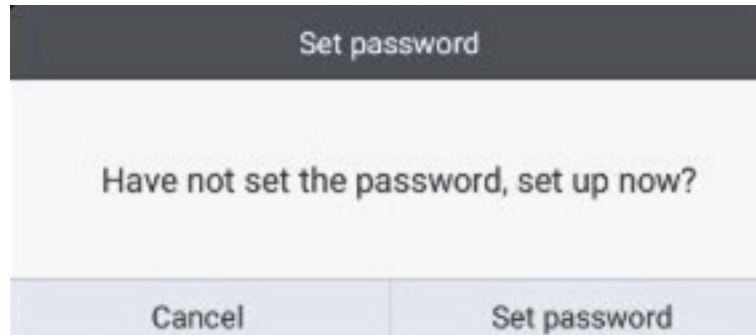

Screen lock enabled





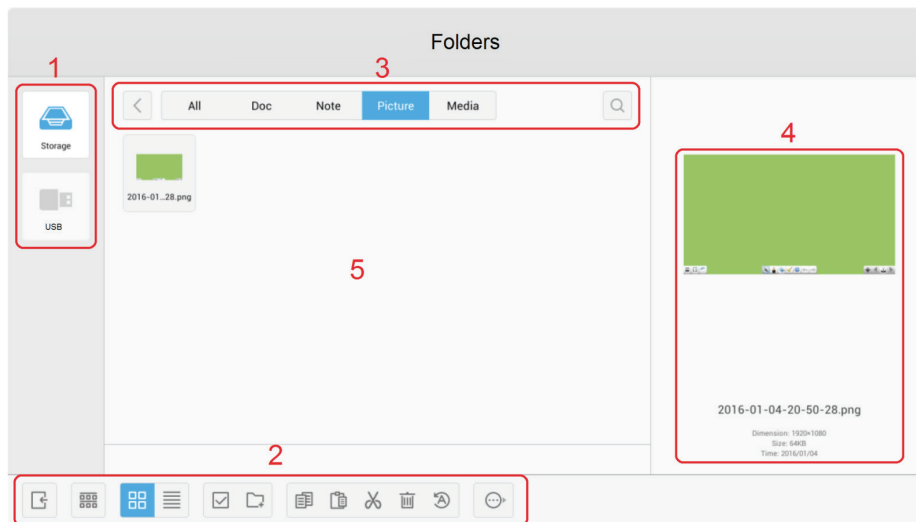









Folders



1. Storage device display: Click with touching pen to enter corresponding storage devices area.

2. Icons:

Item	Description
 Exit	Click to exit.
 Sort	Click to sort file.
 Thumbnail	Click to display file by thumbnail mode.
 List	Click to display file by list mode.
 Select	Click to select file.
 Add folder	Click to add folder.
 Copy	Click to copy file.
 Paste	Click to paste file.
 Cut	Click to cut file.
 Delete	Click to delete file.
 Rename	Click to rename file.
 More	Click to show more functions.

3. File type menu:

All: All types

Doc: OFFICE type files

Note: Image stored by vBoard Lite, Side Tool Bar and remote control Screen capture button.

Picture: Image type files

Media: Audio and video type files

4. **File information:** To preview the image, show the image's name, size, resolution and created date.

5. **Main display area:** Display files of corresponding type.

Browser

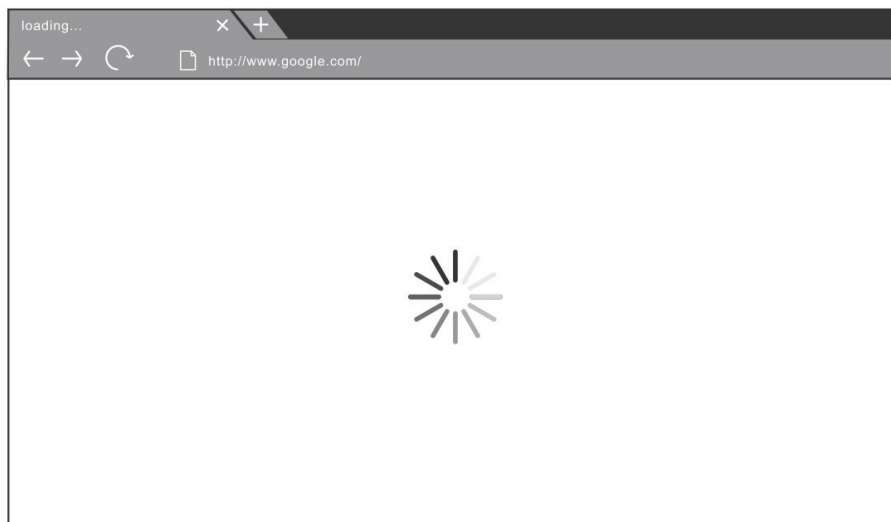

Enter web browser to surfing the internet.

Settings

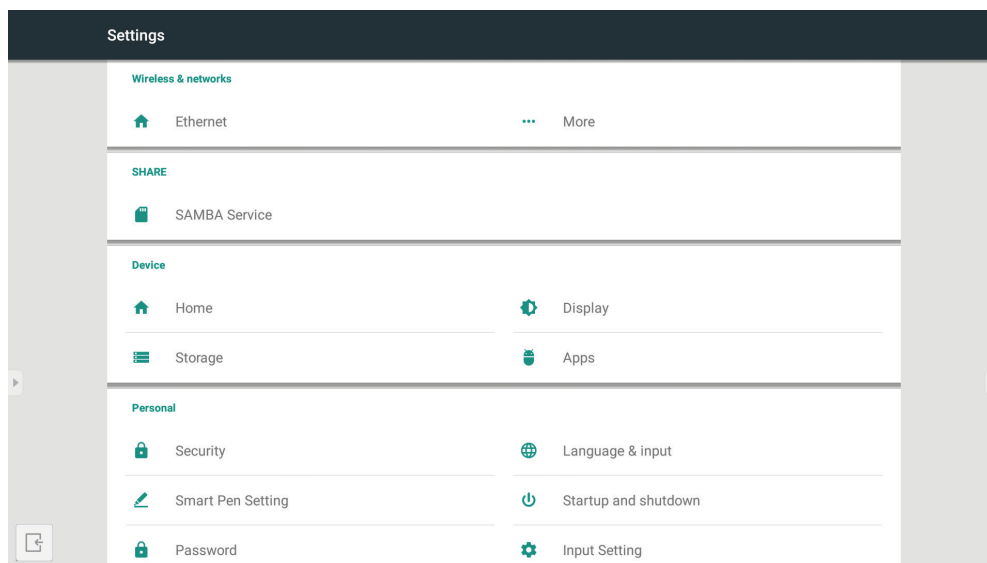

- **Network access:** Check the current network connection status and the network parameters of the device.
- **Share:** SAMBA Service for share.
- **Display:** Adjust default home page, wallpaper, HDMI out encryption, pixel shift interval.
- **Storage:** Check the internal storage size.
- **Apps:** Display all applications' information in Embedded Player.
- **Security:** To show trusted credentials. To enable/disable unknown source install.
- **Language & input:** Adjust language and input method of Embedded Player.
- **Startup and shutdown:** Set the Startup channel, Standby after startup and On/Off timer.
- **Password:** To set screen lock password.
- **Input Setting:** To enable/disable and edit input alias.
- **Other Setting:** To set vPen, Side Tool Bar channel setting, and vBoard Lite writing setting.
- **Date & time:** Set the system time and format.
- **About device:** Display Embedded Player information.

Apps

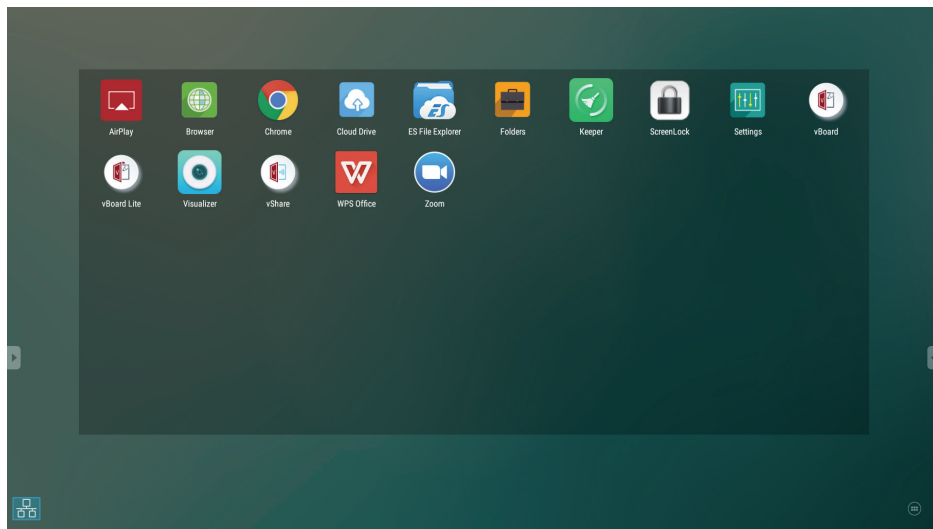

- AirPlay
- Browser
- Chrome
- Cloud Drive
- ES File Explorer
- Folders
- Keeper
- Screen Lock
- Settings
- vBoard
- vBoard Lite
- Visualizer
- ViewBoard Cast
- WPS Office
- Zoom

Cloud Drive

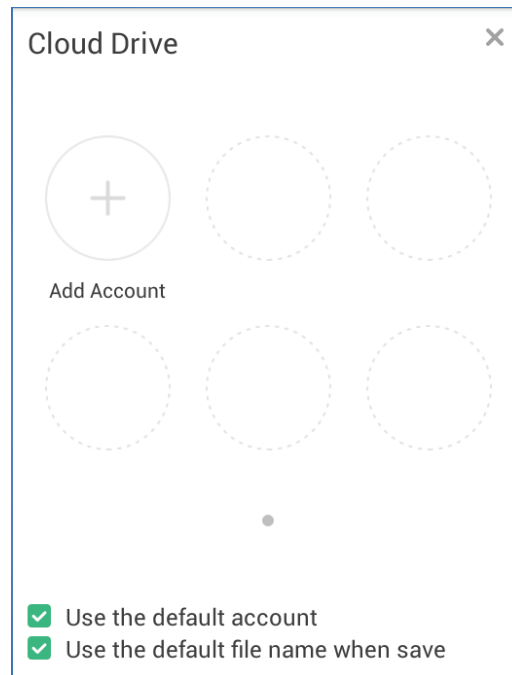

Item	Description
Add Account	Add user account.
Use the default account	The current image will be uploaded to cloud storage without confirm account again after press upload icon.
Use the default file name when save	The current image will be uploaded to cloud storage without editing file name after press upload icon.

ES File Explorer

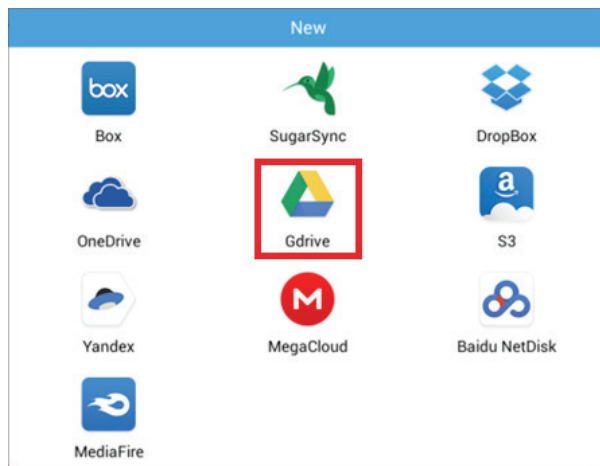
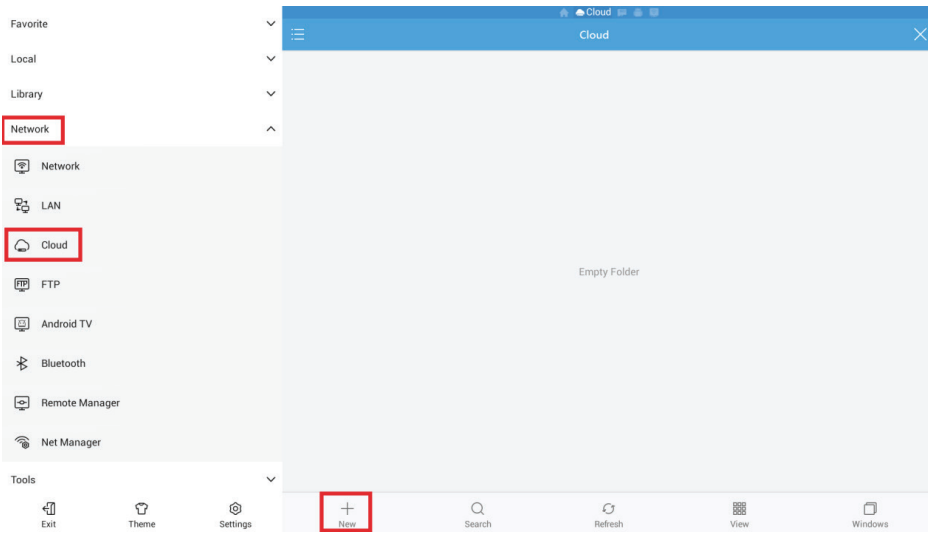

Item	Description
Network	Enter to submenu.
Cloud	Enter to operation page.
New	Click "Gdrive" icon to add cloud account.

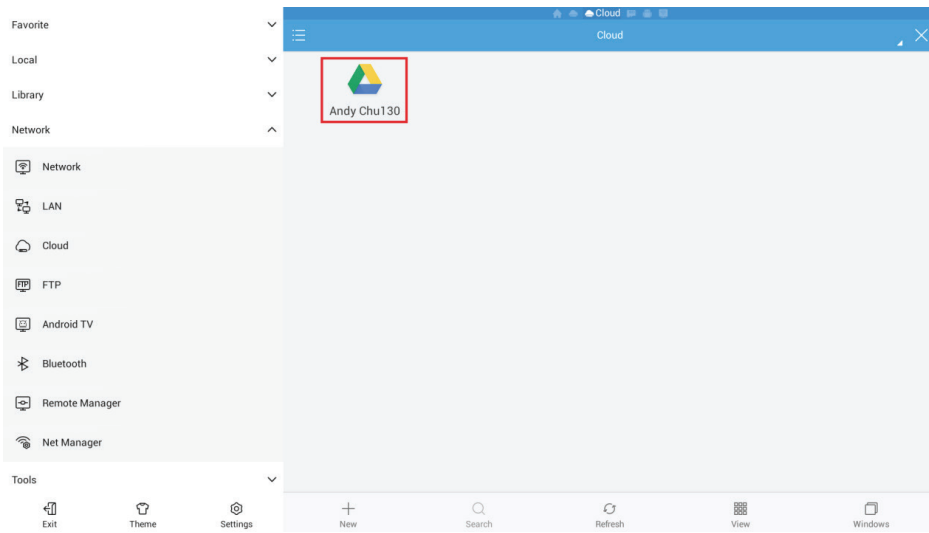

Select cloud account to access the cloud file.

4.5 Multimedia supported formats

MEDIA	CODEC	FILE EXTENSION
Picture	BMP, JPEG, PNG	.bmp, .gif, .jpg, .jpeg, .png
Movie	H.263, H.264, MJPEG, MPEG2, MPEG4, RV30/40, VP6, Xvid-ASP	.3gp, .asf, .asx, .avi, .flv, .m4v, .mkv, .mov, .mp4, .mpg, .mpeg, .rmvb, .ts
Music	AAC, ALAC, FLAC, MPEG 3, Vorbis, WAV, WMA	.aac, .ape, .flac, .m4a, .mp3, .ogg, .wav, .wma

*Practically supported formats will depend on the paid royalties.

5. Trouble Shooting

Remote control is out of order	<ol style="list-style-type: none"> 1. Check whether something is obstructing the display's remote control receiver. 2. Check whether the batteries in the remote control are installed correctly. 3. Check whether the batteries need to be replaced.
The unit turns of unexpectedly	<ol style="list-style-type: none"> 1. Check whether Sleep mode is enabled. 2. Check if there is a power outage in your area. 3. Turn on the display and see if the problem is with the signal and control system.

PC mode

No PC signal	<ol style="list-style-type: none"> 1. Check the display settings. 2. Check the display resolution. 3. Adjust the Hs & Vs (synchronization) settings using the OSD menu.
Background streaking	<ol style="list-style-type: none"> 1. Choose auto adjust. 2. Adjust clock and phase.
False color	<ol style="list-style-type: none"> 1. Check the VGA connection. 2. Adjust chroma, brightness and contrast settings.
Unsupported format	<ol style="list-style-type: none"> 1. Choose auto adjust. 2. Adjust clock and phase settings.

Touch Function

Touch function does not work	<ol style="list-style-type: none"> 1. Check that drivers are installed correctly. 2. Reinstall driver. 3. Check setup and align it. 4. Check whether the touch pen is working properly.
------------------------------	---

Video not working properly

No picture / No sound	<ol style="list-style-type: none">1. Check POWER status.2. Check the signal cable.3. Check that the internal PC is installed correctly.
Picture trembling	<ol style="list-style-type: none">1. Check the signal cable.2. Check if other electronics are interrupting the signal.
Poor picture	<ol style="list-style-type: none">1. Adjust chroma, brightness and contrast settings in the menu.2. Check the signal cable.

Audio not working properly

No sound	<ol style="list-style-type: none">1. Press the Mute/ Unmute button.2. Adjust the volume.3. Check the audio cable.
One speaker only	<ol style="list-style-type: none">1. Adjust the sound balance in the menu.2. Check the sound control panel settings of the computer.3. Check the audio cable.

6. Care and Maintenance

Please follow these cleaning guidelines to make sure your smart whiteboard display looks like new for years to come:

- Don't clean the machine if it has been turned on for a long period of time.
- Unplug the unit from the wall outlet before cleaning or polishing it.

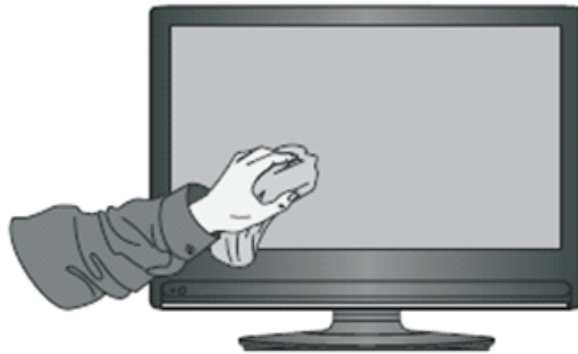

- Don't use liquid cleaners or aerosol cleaners on the screen.
- Only use a slightly dampened cloth when cleaning the exterior of the unit.
- Don't use system continuously for long periods of time.
- Remember to unplug the display when it is not in use.
- Use a power surge protector to prevent system failures and power supply surges.
- Make sure the display remains dry at all times. Be careful when handling liquids near or on the unit.

Note: If condensation appears between the glass and the panel, keep the display turned on until the moisture disappears.

7. Display Modes

7.1 VGA Mode

640x480	@60Hz/72Hz/75Hz
720x400	@70Hz
800x600	@56Hz/60Hz/72Hz/75Hz
832x624	@75Hz
1024x768	@60Hz/70Hz/75Hz
1152x864	@60Hz/75Hz
1152x870	@75Hz
1280x768	@60Hz/75Hz
1280x960	@60Hz
1280x1024	@60Hz/75Hz
1360x768	@60Hz
1366x768	@60Hz
1440x900	@60Hz/75Hz
1400x1050	@60Hz/75Hz
1600x1200	@60Hz
1680x1050	@60Hz
1920x1080	@60Hz
1920x1200	@60Hz

7.2 HDMI Mode

640x480	@60Hz/72Hz
720x400	@70Hz
800x600	@60Hz/72Hz
1024x768	@60Hz/70Hz/75Hz
1280x800	@60Hz
1280x1024	@60Hz
1360x768	@60Hz
1440x900	@60Hz
1680x1050	@60Hz
1920x1080	@60Hz
3840x2160	@30Hz (HDMI 2/3) @60Hz (HDMI 1)
480i	@60Hz
480p	@59Hz/60Hz
576i	@50Hz
720p	@50Hz/60Hz
576p	@50Hz
1080i	@50Hz/60Hz
1080p	@50Hz/60Hz

7.3 DP Mode

640x480	@60Hz/72Hz
720x400	@70Hz
800x600	@60Hz/72Hz
1024x768	@60Hz/70Hz/75Hz
1280x800	@60Hz
1280x1024	@60Hz
1360x768	@60Hz
1440x900	@60Hz
1680x1050	@60Hz
1920x1080	@60Hz
3840x2160	@60Hz
480i	@60Hz
480p	@59Hz/60Hz
576i	@50Hz
720p	@50Hz/60Hz
576p	@50Hz
1080i	@50Hz/60Hz
1080p	@50Hz/60Hz

8. Specifications

Model		IFP5550	IFP6550	IFP7550	IFP8650
Screen Size		54.6"	64.5"	74.5"	85.6"
Input Signal		3 x HDMI 1 x DP 1 x VGA 1 x PC audio 1 x CVBS			
Output Signal		1 x HDMI 1 x Earphone 1 x SPDIF(coaxial)			
Speaker Output		16W x 2			
RS232		RS232 communication			
Power	Voltage	100V-240V AC 50/60HZ			
Operation Conditions	Temperature	32°F to 104°F (0°C to 40°C)			
	Humidity	20% ~ 80% non-condensing			
	Altitude	≤2000M			
Storage Conditions	Temperature	-4°F to 140°F (-20°C to 60°C)			
	Humidity	10% ~ 90% non-condensing			
	Altitude	≤2000M			
Dimensions	Physical (mm)	1302 x 799 x 98	1521 x 922 x 99	1763 x 1042 x 99	1988 x 100 x 1186
		Weight	Physical (kg)	34	47
Power Consumption	On	129W	350W	430W	500W
	Off	<0.5W	<0.5W	<0.5W	<0.5W

Note: Product Specifications are subject to change without notice.

9. RS-232 Protocol

9.1 Introduction

This document describes the hardware interface spec and software protocols of RS232 interface communication between ViewSonic Commercial TV / Digital Signage and PC or other control unit with RS232 protocol.

The protocol contains three sections command:

- Set-Function
- Get-Function
- Remote control pass-through mode

※ In the document below, “PC” represents all the control units that can send or receive the RS232 protocol command.

9.2 Description

9.2.1 Hardware specification

Viewsonic TV communication port on the rear side:

(1) Connector type: DSUB 9-Pin Male

(2) Pin Assignment

Male DSUB 9-Pin
(outside view)



Pin #	Signal	Remark
1	NC	
2	RXD	Input to Commercial TV or DS
3	TXD	Output from Commercial TV or DS
4	NC	
5	GND	
6	NC	
7	NC	
8	NC	
9	+5V Out	Provide +5V/1A power for external specific dongle *3.0
frame	GND	

* Use of crossover (null modem) cable required for use with PC

[Special case]
3.5mm barrel connector

Pin #	Signal	Remark
Tip	TXD	Output from Commercial TV or DS
Ring	RXD	Input to Commercial TV or DS
Sleeve	GND	

9.2.2 Communication Setting

- Baud Rate Select: 9600bps (fixed)
- Data bits: 8 bits (fixed)
- Parity: None (fixed)
- Stop Bits: 1 (fixed)

9.2.3 Command Message Reference

PC sends to Monitor command packet followed by "CR". Every time PC sends control command to the Monitor, the Monitor shall respond as follows:

1. If the message is received correctly it will send "+" (02Bh) followed by "CR" (00Dh)
2. If the message is received incorrectly it will send "-" (02Dh) followed by "CR" (00Dh)

9.3 Protocol

9.3.1 Set-Function Listing

The PC can control the TV/DS for specific actions. The Set-Function command allows you to control the TV/DS behavior in a remote site through the RS232 port. The Set-Function packet format consists of 9 bytes.

Set-Function description:

Length:	Total Byte of Message excluding "CR".
TV/DS ID	Identification for each of TV/DS (01~98; default is 01) ID "99" means to apply the set command for all connected displays. Under such circumstances, only ID#1 display has to reply. The TV/DS ID can be set via the OSD menu for each TV/DS set.
Command Type	Identify command type, "s" (0x73h): Set Command "+" (0x2Bh): Valid command Reply "- " (0x2Dh): Invalid command Reply
Command:	Function command code: One byte ASCII code.
Value[1~3]:	Three bytes ASCII that defines the value.
CR	0x0D

Set-Function format

Send: (Command Type="s")

Name	Length	ID	Command Type	Command	Value1	Value2	Value3	CR
Byte Count	1 Byte	2 Byte	1 Byte	1 Byte	1 Byte	1 Byte	1 Byte	1 Byte
Bytes order	1	2~3	4	5	6	7	8	9

NOTE:

For VT2405LED-1 and VT3205LED, the set "Power on" command is the exception.

Reply: (Command Type="+" or "-")

Name	Length	ID	Command Type	CR
Byte Count	1 Byte	2 Byte	1 Byte	1 Byte
Bytes order	1	2~3	4	5

NOTE:

1. The reply for "Power on" command is the exception for VT2405LED-1 and VT3205LED. It's 0x322B0D (2+<CR>).
2. When PC applies command to all displays (ID=99), only the #1 set needs to reply by the name of ID=1.

Example1: Set Brightness as 76 for TV-02 and this command is valid

Send (Hex Format)

Name	Length	ID	Command Type	Command	Value1	Value2	Value3	CR
Hex	<u>0x38</u>	<u>0x30</u> <u>0x32</u>	<u>0x73</u>	<u>0x24</u>	<u>0x30</u>	<u>0x37</u>	<u>0x36</u>	<u>0x0D</u>

Reply (Hex Format)

Name	Length	ID	Command Type	CR
Hex	<u>0x34</u>	<u>0x30</u> <u>0x32</u>	<u>0x2B</u>	<u>0x0D</u>

Example2: Set Brightness as 176 for TV-02 and this command is NOT valid

Send (Hex Format)

Name	Length	ID	Command Type	Command	Value1	Value2	Value3	CR
Hex	<u>0x38</u>	<u>0x30</u> <u>0x32</u>	<u>0x73</u>	<u>0x24</u>	<u>0x31</u>	<u>0x37</u>	<u>0x36</u>	<u>0x0D</u>

Reply (Hex Format)

Name	Length	ID	Command Type	CR
Hex	<u>0x34</u>	<u>0x30</u> <u>0x32</u>	<u>0x2D</u>	<u>0x0D</u>

Set-function table

Set Function	Length	ID	Command Type (ASCII)	Command		Value Range (Three ASCII bytes)	Comments
				Code (ASCII)	Code (Hex)		
Power on/ off (standby)	8		s	!	21	000: STBY 001: ON	Exclude VT2405-1, and VT3205
Input Select	8		s	"	22	000: TV 001: AV 002: S-Video 003: YPbPr 004: HDMI 014: HDMI2 024: HDMI3 034: HDMI4 005: DVI 006: VGA1 016: VGA2 026: VGA3 007: OPS1/PC1/ STB1/HDBT1 *2.9.1 017: OPS2/PC2/ STB2/HDBT2 008: Internal memory 009: DP 00A: Embedded/ Main (Android) *3.0	1. No need for USB 2. For the case of two more same sources, the 2nd digital is used to indicate the extension. 3. Exclude VT2405-1, and VT3205
Contrast	8		s	#	23	000 ~ 100	
Brightness	8		s	\$	24	000 ~ 100	
Sharpness	8		s	%	25	000 ~ 100	
Color	8		s	&	26	000 ~ 100	
Tint	8		s	'	27	000 ~ 100	
Color mode	8		s)	29	000: Normal 001: Warm 002: Cold 003: Personal	
Sound	8		s	-	2D	000: SRS Off 001: SRS On	(for TV)
Bass	8		s	.	2E	000 ~ 100	(for TV)
Treble	8		s	/	2F	000 ~ 100	(for TV)
Balance	8		s	0	30	000 ~ 100	(for TV) Sets Balance position

Picture Size	8		s	1	31	000: FULL 001: NORMAL 002: CUSTOM 003: DYNAMIC 004: REAL	(for DS)
OSD language	8		s	2	32	000: English 001: French 002: Spanish	Extend the value for more supported languages
OSD timeout	8		s	3	33	005 ~120 Sec	Set OSD timeout
Power lock	8		s	4	34	000: Unlock 001: Lock	
Volume	8		s	5	35	000 ~ 100 900: Volume down (-1) 901: Volume up (+1)	
Mute	8		s	6	36	000: OFF 001: ON (mute)	
Off Timer	8		s	7	37	000: OFF 001~024 (hour)	
PIP-Mode	8		s	9	39	000: OFF 001: PIP 002: PBP	(for DS)
PIP-Sound select	8		s	:	3A	000: Main 001: PIP	(for DS)
PIP-Position	8		s	;	3B	000: Up 001: Down 002: Left 003: Right	(for DS)
PIP-Input	8		s	7	37 ^{*2.9}	000: TV 001: AV 002: S-Video 003: YPbPr 004: HDMI 014: HDMI2 024: HDMI3 005: DVI 006: PC/VGA 007: OPS	(for DS) For the case of two more same sources, the 2 nd digital is used to indicate the extension.
Button lock	8		s	8	38	000: Unlock 001: Lock	
TV channel (DTV)	8		s	<	3C	For -0: 001~999 A00~F99 (1000~1599) For -k: 1 st and 2 nd char are same as -0 3th char is CHAR [ASC (3th digi) + k x 10]	(for TV) 1. Channel OSD number but not frequency number 2. For VT3255 and VT4236 only
TV channel (ATV)	8		s	=	3D	001~999	(for TV)
Menu lock	8		s	>	3E	000: Unlock 001: Lock	
Number	8		s	@	40	000~009	(for TV)

Key Pad	8		s	A	41	000: UP 001: DOWN 002: LEFT 003: RIGHT 004: ENTER 005: INPUT 006: MENU/EXIT 007: EXIT *2.9.2	
Remote Control	8		s	B	42	000: Disable 001: Enable 002: Pass through	Disable: RCU has no effect on HDTV. Enabled: RCU controls the HDTV. This is the power up default on the HDTV. Pass through: RCU has no effect on HDTV and all RCU command codes are transmitted to FC via the RS232 port. See page 26 for more details
Setup wizard	8		s	C	43	000: Disable 001: Enable	(for TV) Disable: to skip the initial setup wizard
Tiling-Mode	8		s	P	50	000: OFF 001: ON	(for DS)
Tiling-Compensation	8		s	Q	51	000: OFF 001: ON	(for DS) Bezel width compensation
Tiling-H by V Monitors	8		s	R	52	01x~09x: H 0x1~0x9: V	(for DS) 1. 2 nd digital for H monitors 2. 3 rd digital for V monitors
Tiling-Position	8		s	S	53	001~025	(for DS) Copy the screen of Position# to identified display
Date: Year *3.0.1	8		s	V	56	Y17~Y99	Last 2 digits (20)17~(20)99
Date: Month *3.0.1	8		s	V	56	M01~M12	2 digits
Date: Day *3.0.1	8		s	V	56	D01~D31	2 digits
Time: Hour *3.0.1	8		s	W	57	H00~H23	24-hr format. 2 digits.
Time: Min *3.0.1	8		s	W	57	M00~M59	2 digits
Time: Sec *3.0.1	8		s	W	57	S00~S59	2 digits
Restore default	8		s	~	7E	000	Rests HDTV to factory setting

NOTE:

1. Behavior at lock modes

Lock Mode	Behavior
Button Lock	<ol style="list-style-type: none"> 1. Lock all buttons on the front panel and RCU, except for "Power". 2. All the SET functions should be workable via RS32, even the ones with according hot key in RCU like Mute,...etc.
MENU Lock	<ol style="list-style-type: none"> 1. Lock "MENU" key of front panel and RCU. 2. The Factory and Hospitality modes should not be blocked for the model using MENU-combined key to enter these two modes. Alternative approach will be indicated separately if any limitation by model.
POWER Lock	<ol style="list-style-type: none"> 1. Lock "POWER" key on the front and RCU. 2. The SET_POWER on/off should be workable via RS232, but does not mean the POWER lock will be released under this case. 3. Can not be unlocked by reset in OSD setting. 4. Will auto AC power-on in power-lock 5. Under power-lock, the set will not enter power saving when no PC signal and neither not turn off when no other video signals after 15min.
Remote control disable	Lock the RCU keys, but keep the front panel buttons workable.

2. Example for value setting of SET_TV channel DTV

012-0: 0x 30 31 32

012-1: 0x 30 31 42

1012-2: 0x 41 31 52

1512-3: 0x 46 31 62

3. Tiling definition of H Monitors/ V Monitors/ and Position

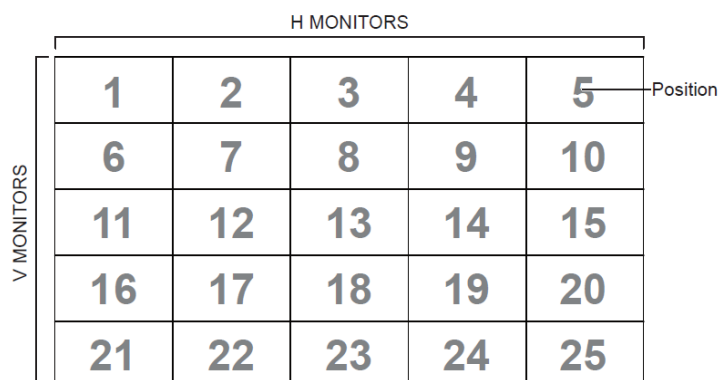

4. Set Date example

Date: 2017-3/15

Send: 0x 38 30 31 73 56 59 31 37 0D (“Y17”)

Send: 0x 38 30 31 73 56 4D 30 33 0D (“M03”)

Send: 0x 38 30 31 73 56 44 31 35 0D (“D15”)

5. Set Time example

Send: 0x 38 30 31 73 57 48 31 36 0D (“H16”)

Send: 0x 38 30 31 73 57 4D 32 37 0D (“M27”)

Send: 0x 38 30 31 73 57 53 35 39 0D (“S59”)

9.3.2 Get-Function Listing

The PC can interrogate the TV/DS for specific information. The Get-Function packet format consists of 9 bytes which is similar to the Set-Function packet structure. Note that the “Value” byte is always = 000

Get-Function description:

Length: Total Byte of Message excluding “CR”.

TV/DS ID Identification for each of TV/DS (01~98; default is 01).

Command Type Identify command type,
“g” (0x67h): Get Command
“r” (0x72h): Valid command Reply
“-“ (0x2Dh): Invalid command Reply

Command: Function command code: One byte ASCII code.

Value[1~3]: Three bytes ASCII that defines the value.

CR 0x0D

Get-Function format**Send: (Command Type="g")**

Name	Length	ID	Command Type	Command	Value1	Value2	Value3	CR
Byte Count	1 Byte	2 Byte	1 Byte	1 Byte	1 Byte	1 Byte	1 Byte	1 Byte
Bytes order	1	2~3	4	5	6	7	8	9

NOTE: Get "Power STBY status" is the exception for VT2405LED-1 and VT3205LED.

Reply: (Command Type="r" or "-")**If the Command is valid, Command Type = "r"**

Name	Length	ID	Command Type	Command	Value1	Value2	Value3	CR
Byte Count	1 Byte	2 Byte	1 Byte	1 Byte	1 Byte	1 Byte	1 Byte	1 Byte
Bytes order	1	2~3	4	5	6	7	8	9

NOTE: The reply for "Power STBY status" command is the exception for VT2405LED-1 and V3205LED. It's 0x36 72 6C 30 30 30 0D (6r1000<CR>).

If the Command is Not valid, Command Type="-"

Name	Length	ID	Command Type	CR
Byte Count	1 Byte	2 Byte	1 Byte	1 Byte
Bytes order	1	2~3	4	5

Example1: Get Brightness from TV-05 and this command is valid.**The Brightness value is 67.****Send (Hex Format)**

Name	Length	ID	Command Type	Command	Value1	Value2	Value3	CR
Hex	<u>0x38</u>	<u>0x30</u> <u>0x35</u>	<u>0x67</u>	<u>0x62</u>	<u>0x30</u>	<u>0x30</u>	<u>0x30</u>	<u>0x0D</u>

Reply (Hex Format)

Name	Length	ID	Command Type	Command	Value1	Value2	Value3	CR
Hex	<u>0x38</u>	<u>0x30</u> <u>0x35</u>	<u>0x72</u>	<u>0x62</u>	<u>0x30</u>	<u>0x36</u>	<u>0x37</u>	<u>0x0D</u>

Example2: Get Brightness from TV-05 , but the Brightness command ID is error and it is NOT in the command table.

Send (Hex Format)

Name	Length	ID	Command Type	Command	Value1	Value2	Value3	CR
Hex	<u>0x38</u>	<u>0x30</u> <u>0x35</u>	<u>0x67</u>	<u>0XD3</u>	<u>0x30</u>	<u>0x30</u>	<u>0x30</u>	<u>0x0D</u>

Reply (Hex Format)

Name	Length	ID	Command Type	CR
Hex	<u>0x34</u>	<u>0x30</u> <u>0x35</u>	<u>0x2D</u>	<u>0x0D</u>

Get-Function table

Get Function	Length	ID	Command Type (ASCII)	Command		Response Range (Three ASCII bytes)	Comments
				Code (ASCII)	Code (Hex)		
Get-Contrast	8		g	a	61	000 ~ 100	
Get-Brightness	8		g	b	62	000 ~ 100	
Get-Sharpness	8		g	c	63	000 ~ 100	
Get-Color	8		g	d	64	000 ~ 100	
Get-Tint	8		g	e	65	000 ~ 100	
Get-Volume	8		g	f	66	000 ~ 100	
Get-Mute	8		g	g	67	000: Off 001: On (muted)	
Get-Input select	8		g	j	6A	000~	See Set-function table
Get-Power status: ON/ STBY	8		g	l	6C	001: ON 000: STBY	Exclude VT2405-1, and VT3205
Get-Remote control	8		g	n	6E	000: Disable 001: Enable 002: Pass through	Gets RCU mode status
Get-Power lock	8		g	o	6F	000: Unlock 001: Lock	
Get-Button lock	8		g	p	70	000: Unlock 001: Lock	
Get-Menu lock	8		g	q	71	000: Unlock 001: Lock	
Get-Setup wizard	8		g	s	73	000: Disable 001: Enable	(for TV)
Get-PIP mode	8		g	t	74	000: OFF 001: PIP 002: PBP	(for DS)
Get-PIP input	8		g	u	75	000 ~	(for DS) See Set-function table
Get-Tiling Mode	8		g	v	76	000: OFF 001: ON	(for DS)

Get-Tiling Compensation	8		g	w	77	000: OFF 001: ON	(for DS) Bezel width compensation
Get-Tiling H by V monitors	8		g	x	78	01x~09x: H monitors 0x1~0x9: V monitors	(for DS) 1. 2 nd digital for H monitors 2. 3 rd digital for V monitors
Get-Tiling position	8		g	y	79	000: OFF 001~025	(for DS) Copy the screen of Position# to identified display
Get-ACK	8		g	z	7A	000	This command is used to test the communication link
Get-Thermal ^{*2.9}	8		g	0	30	000~100: 0~+100 deg C -01~-99: -1~-99 deg C	For specific models only
Get-Power on/off log ^{*3.0}	8		g	1	31	000 (See below note)	For specific models only
Get-Date: Year ^{*3.0.1}	8		g	2	32	Y00~Y00	Last 2 digits (20)17~(20)99
Get-Date: Month ^{*3.0.1}	8		g	2	32	M00~M00	2 digits
Get-Date: Day ^{*3.0.1}	8		g	2	32	D00~M00	2 digits
Get-Time: Hour ^{*3.0.1}	8		g	3	33	H00~H00	24-hr format. 2 digits
Get-Time: Min ^{*3.0.1}	8		g	3	33	M00~M00	2 digits
Get-Time: Sec ^{*3.0.1}	8		g	3	33	S00~S00	2 digits
Get-Device name ^{*2.9.3}	8		g	4	34	000	
Get-MAC add ^{*3.0}	8		g	5	35	000 (see below note)	For the model with LAN
Get-RS232 version ^{*3.0.1}	8		g	6	36	0 (see below note)	Version 0.0.1~9.9.9

NOTE:

1. Power on/off log data is replied as 6 sequential strings in following order.

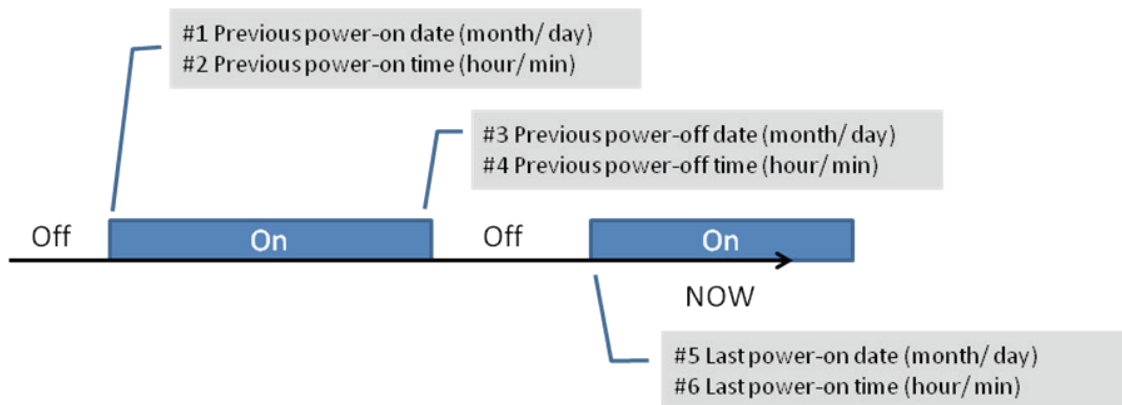

2. Time log data definition

Value 1	Value 2	Value 3
On/ Off indicator 0: Off 1: On	Month in 2 digits (00~12) 24-hr formatted Hour (00~23)	Day in two digits (00~31) Minute in 2 digits (00~59)

Hex code (in hex) = Original data (in dec) + 20

Date & Time	Code (ASCII)	Code (Hex)	Date & Time	Code (ASCII)	Code (Hex)	Date & Time	Code (ASCII)	Code (Hex)	Date & Time	Code (ASCII)	Code (Hex)
0	space	20	16	6	36	32	R	52	48	h	68
1	!	21	17	7	37	33	S	53	49	i	69
2	"	22	18	8	38	34	T	54	50	p	70
3	#	23	19	9	39	35	U	55	51	q	71
4	\$	24	20	@	40	36	V	56	52	r	72
5	%	25	21	A	41	37	W	57	53	s	73
6	&	26	22	B	42	38	X	58	54	t	74
7	'	27	23	C	43	39	Y	59	55	u	75
8	(28	24	D	44	40	`	60	56	v	76
9)	29	25	E	45	41	a	61	57	w	77
10	0	30	26	F	46	42	b	62	58	x	78
11	1	31	27	G	47	43	c	63	59	y	79
12	2	32	28	H	48	44	d	64			
13	3	33	29	I	49	45	e	65			
14	4	34	30	P	50	46	f	66			
15	5	35	31	Q	51	47	g	67			

3. Get Time log data example

Assumed the power-on/off record of display#01 as below

2014-8/31 08:00 On

2014-8/31 22:00 Off

2014-9/1 10:30 On

2014-9/1 11:00 To send "GET-Time log" command

Send: 0x 38 30 31 67 31 30 30 0D

Reply:

#1 0x 38 30 31 72 31 01 08 31 0D (On 8/31)

#2 0x 38 30 31 72 31 01 08 00 0D (On 08:00)

#3 0x 38 30 31 72 31 00 08 31 0D (Off 8/31)

#4 0x 38 30 31 72 31 00 22 00 0D (Off 22:00)

#5 0x 38 30 31 72 31 01 09 01 0D (On 9/1)

#6 0x 38 30 31 72 31 01 10 30 0D (On 10:30)

4. Get Date example

Assumed the current date of display#01 as below

Date: 2017-3/15

Send: 0x 38 30 31 67 32 59 30 30 0D (Get Date:Year)

Reply: 0x 38 30 31 72 32 59 31 37 0D ("Y17")

Send: 0x 38 30 31 67 32 4D 30 30 0D (Get Date:Month)

Reply: 0x 38 30 31 72 32 4D 30 33 0D ("M03")

Send: 0x 38 30 31 67 32 44 30 30 0D (Get Date:Day)

Reply: 0x 38 30 31 72 32 44 31 35 0D ("D15")

5. Get Time example

Assumed the current time of display#01 as below

Time: 16:27:59

Send: 0x 38 30 31 67 33 48 30 30 0D (Get Time:Hour)

Reply: 0x 38 30 31 72 33 48 31 36 0D ("H16")

Send: 0x 38 30 31 67 33 4D 30 30 0D (Get Time:Min)

Reply: 0x 38 30 31 72 33 4D 32 37 0D ("M27")

Send: 0x 38 30 31 67 33 53 30 30 0D (Get Time:Sec)

Reply: 0x 38 30 31 72 33 53 35 39 0D ("S59")

6. Get Device Name example

Assumed the device name is CDE-5500

Send: 0x 38 30 31 67 34 30 30 30 0D (Get Device Name)

Reply:

#1 0x 38 30 31 72 34 43 44 45 0D ("C" "D" "E")

#2 0x 38 30 31 72 34 2D 35 35 0D ("- "5" "5")

#3 0x 38 30 31 72 34 30 30 00 0D ("0" "0" "(NULL)")

#4 0x 38 30 31 72 34 00 00 00 0D ("(NULL)" "(NULL)" "(NULL)")

Assumed the device name is "NMP-302 #1"

Send: 0x 38 30 31 67 34 30 30 30 0D (Get Device Name)

Reply:

#1 0x 38 30 31 72 34 4E 4D 50 0D ("N" "M" "P")

#2 0x 38 30 31 72 34 2D 33 30 0D ("- "3" "0")

#3 0x 38 30 31 72 34 32 20 23 0D ("2" "(SPACE)" "#")

#4 0x 38 30 31 72 34 31 00 00 0D ("1" "(NULL)" "(NULL)")

7. Get MAC add example

Assumed the MAC address is 00:11:22:aa:bb:cc

Send: 0x 38 30 31 67 35 30 30 30 0D (Get MAC add)

Reply:

#1 0x 38 30 31 72 35 00 11 22 0D ("00" "11" "22")

#2 0x 38 30 31 72 35 aa bb cc 0D ("aa" "bb" "cc")

8. Get RS232 version example

Assumed the version is 3.0.1

Send: 0x 38 30 31 67 36 30 30 30 0D (Get RS232 version)

Reply: 0x 38 30 31 72 36 33 30 31 0D ("301")

9.3.3 Remote Control Pass-through mode

When PC sets the TV/DS to Remote Control Pass through mode, the TV/DS shall send a 7-byte packet (followed by “CR”) in response to RCU button activation. Note, that in this mode the RCU shall have no effect on the TV/DS function. For example: “Volume+” will not change the volume in the LCD but only sends “Volume+” code to PC over the RS232 port.

IR Pass Through-Function format

Reply: (Command Type=“p”)

Name	Length	ID	Command Type	RCU Code1 (MSB)	RCU Code2 (LSB)	CR
Byte Count	1 Byte	2 Byte	1 Byte	1 Byte	1 Byte	1 Byte
Bytes order	1	2~3	4	5	6	7

Example1: Remote Control pass-through when “VOL+” key is pressed for TV-05 Send (Hex Format)

Name	Length	ID	Command Type	RCU Code1 (MSB)	RCU Code2 (LSB)	CR
Hex	<u>0x36</u>	<u>0x30</u> <u>0x35</u>	<u>0x70</u>	<u>0x31</u>	<u>0x30</u>	<u>0x0D</u>

Key	Code (HEX)
1	01
2	02
3	03
4	04
5	05
6	06
7	07
8	08
9	09
0	0A
-	0B
RECALL (LAST)	0C
INFO (DISPLAY)	0D
	0E
ASPECT (ZOOM, SIZE)	0F
VOLUME UP (+)	10
VOLUME DOWN (-)	11
MUTE	12
CHANNEL/PAGE UP (+)/ BRIGHTNESS+	13
CHANNEL/PAGE DOWN (-)/ BRIGHTNESS-	14

POWER	15
SOURCES (INPUTS)	16
	17
	18
SLEEP	19
MENU	1A
UP	1B
DOWN	1C
LEFT (-)	1D
RIGHT (+)	1E
OK (ENTER, SET)	1F
EXIT	20
	21
	22
	23
	24
	25
	26
	27
	28
	29
	2A
	2B
RED ■ (F1)	2C
GREEN ■ (F2)	2D
YELLOW ■ (F3)	2E
BLUE ■ (F4)	2F

NOTE:

1. This IR-pass-through code is different from the RCU key code.
2. Special control sequence for POWER key under IR-pass through mode.
 - 2-1. When TV/DS is OFF and receives the IR POWER code: TV/DS will turn itself on, then forward the POWER code to the host via RS232.
 - 2-2. When TV/DS is ON and receives the IR POWER code: TV/DS will forward the POWER code to the host via RS232, then turn off itself.
 - 2-3. When SET-POWER LOCK is enabled, the TV/DS will not respond to POWER key pressing.
3. The VOLUME UP and VOLUME DOWN code will repeatedly output when you press and hold the keys.

Combination Keys:

Special Mode	Front Key Pressing (Interval 1 sec.)	Remark
Button Lock & Un-lock	"VOL-" → "VOL-" → "SETTING" → "HOME"	<ol style="list-style-type: none"> 1. Lock all buttons of front panel and RCU, except for "Power". 2. All the SET functions should be workable via RS32, even the ones with according hot key in RCU like Mute,...etc.
"MENU" Lock & Un-lock	"VOL+" → "VOL+" → "SETTING" → "HOME"	<ol style="list-style-type: none"> 1. Lock "MENU" key of front panel and RCU 2. The Factory and Hospitality modes should not be blocked for the model using MENU-combined key to enter these two modes. Alternative approach will be indicated separately if any limitation by model.
"POWER" Lock & Un-lock	"VOL-" → "VOL+" → "SETTING" → "HOME"	<ol style="list-style-type: none"> 1. Lock "POWER" key of front and RCU. 2. The SET_POWER on/off should be workable via RS232, but does not mean. the POWER lock will be released under this case. 3. Can not be un-locked by reset in OSD setting. 4. Will auto AC power-on in power-lock. 5. Under power-lock, the set will not enter power saving when no PC signal and neither not trun off when no other video signals after 15min.
"Touch" Lock & Un-lock	"VOL+" → "VOL+" → "VOL+" → "SETTING" → "HOME"	Lock Touch moduel

Other Information

Customer Support

For technical support or product service, see the table below or contact your reseller.

NOTE: You will need the product serial number.

Country/Region	Website	T= Telephone C = CHAT ONLINE	Email
Australia New Zealand	www.viewsonic.com.au	AUS= 1800 880 818 NZ= 0800 008 822	service@au.viewsonic.com
Canada	www.viewsonic.com	T= 1-866-463-4775	service.ca@viewsonic.com
Europe	www.viewsoniceurope.com	http://www.viewsoniceurope.com/eu/support/call-desk/	
Hong Kong	www.hk.viewsonic.com	T= 852 3102 2900	service@hk.viewsonic.com
India	www.in.viewsonic.com	T= 1800 419 0959	service@in.viewsonic.com
Korea	ap.viewsonic.com/kr/	T= 080 333 2131	service@kr.viewsonic.com
Latin America (Argentina)	www.viewsonic.com/la/	C= http://www.viewsonic.com/la/soporte/servicio-tecnico	soporte@viewsonic.com
Latin America (Chile)	www.viewsonic.com/la/	C= http://www.viewsonic.com/la/soporte/servicio-tecnico	soporte@viewsonic.com
Latin America (Columbia)	www.viewsonic.com/la/	C= http://www.viewsonic.com/la/soporte/servicio-tecnico	soporte@viewsonic.com
Latin America (Mexico)	www.viewsonic.com/la/	C= http://www.viewsonic.com/la/soporte/servicio-tecnico	soporte@viewsonic.com
Nexus Hightech Solutions, Cincinnati #40 Desp. 1 Col. De los Deportes Mexico D.F. Tel: 55) 6547-6454 55)6547-6484 Other places please refer to http://www.viewsonic.com/la/soporte/servicio-tecnico#mexico			
Latin America (Peru)	www.viewsonic.com/la/	C= http://www.viewsonic.com/la/soporte/servicio-tecnico	soporte@viewsonic.com
Macau	www.hk.viewsonic.com	T= 853 2840 3687	service@hk.viewsonic.com
Middle East	ap.viewsonic.com/me/	Contact your reseller	service@ap.viewsonic.com
Puerto Rico & Virgin Islands	www.viewsonic.com	T= 1-800-688-6688 (English) C = http://www.viewsonic.com/la/soporte/servicio-tecnico	service.us@viewsonic.com soporte@viewsonic.com
Singapore/ Malaysia/ Thailand	www.ap.viewsonic.com	T= 65 6461 6044	service@sg.viewsonic.com
South Africa	ap.viewsonic.com/za/	Contact your reseller	service@ap.viewsonic.com
United States	www.viewsonic.com	T= 1-800-688-6688	service.us@viewsonic.com

Limited Warranty

ViewSonic® Smart White Board

What the warranty covers:

ViewSonic warrants its products to be free from defects in material and workmanship, under normal use, during the warranty period. If a product proves to be defective in material or workmanship during the warranty period, ViewSonic will, at its sole option, repair or replace the product with a like product. Replacement product or parts may include remanufactured or refurbished parts or components.

Who the warranty protects:

This warranty is valid only for the first consumer purchaser.

What the warranty does not cover:

1. Any product on which the serial number has been defaced, modified or removed.
2. Damage, deterioration or malfunction resulting from:
 - a. Accident, misuse, neglect, fire, water, lightning, or other acts of nature, unauthorized product modification, or failure to follow instructions supplied with the product.
 - b. Any damage of the product due to shipment.
 - c. Removal or installation of the product.
 - d. Causes external to the product, such as electrical power fluctuations or failure.
 - e. Use of supplies or parts not meeting ViewSonic's specifications.
 - f. Normal wear and tear.
 - g. Any other cause which does not relate to a product defect.
3. Any product exhibiting a condition commonly known as "image burn-in" which results when a static image is displayed on the product for an extended period of time.
4. Removal, installation, one way transportation, insurance, and set-up service charges.

How to get service:

1. For information about receiving service under warranty, contact ViewSonic Customer Support (Please refer to Customer Support page). You will need to provide your product's serial number.
2. To obtain warranty service, you will be required to provide (a) the original dated sales slip, (b) your name, (c) your address, (d) a description of the problem, and (e) the serial number of the product.
3. Take or ship the product freight prepaid in the original container to an authorized ViewSonic service center or ViewSonic.
4. For additional information or the name of the nearest ViewSonic service center, contact ViewSonic.

Limitation of implied warranties:

There are no warranties, express or implied, which extend beyond the description contained herein including the implied warranty of merchantability and fitness for a particular purpose.

Exclusion of damages:

ViewSonic's liability is limited to the cost of repair or replacement of the product. ViewSonic shall not be liable for:

1. Damage to other property caused by any defects in the product, damages based upon inconvenience, loss of use of the product, loss of time, loss of profits, loss of business opportunity, loss of goodwill, interference with business relationships, or other commercial loss, even if advised of the possibility of such damages.
2. Any other damages, whether incidental, consequential or otherwise.
3. Any claim against the customer by any other party.
4. Repair or attempted repair by anyone not authorized by ViewSonic.

Effect of state law:

This warranty gives you specific legal rights, and you may also have other rights which vary from state to state. Some states do not allow limitations on implied warranties and/or do not allow the exclusion of incidental or consequential damages, so the above limitations and exclusions may not apply to you.

Sales outside the U.S.A. and Canada:

For warranty information and service on ViewSonic products sold outside of the U.S.A. and Canada, contact ViewSonic or your local ViewSonic dealer.

The warranty period for this product in mainland China (Hong Kong, Macao and Taiwan Excluded) is subject to the terms and conditions of the Maintenance Guarantee Card.

For users in Europe and Russia, full details of warranty provided can be found in www.viewsoniceurope.com under Support/Warranty Information.

Mexico Limited Warranty

ViewSonic® Smart White Board

What the warranty covers:

ViewSonic warrants its products to be free from defects in material and workmanship, under normal use, during the warranty period. If a product proves to be defective in material or workmanship during the warranty period, ViewSonic will, at its sole option, repair or replace the product with a like product. Replacement product or parts may include remanufactured or refurbished parts or components & accessories.

Who the warranty protects:

This warranty is valid only for the first consumer purchaser.

What the warranty does not cover:

1. Any product on which the serial number has been defaced, modified or removed.
2. Damage, deterioration or malfunction resulting from:
 - a. Accident, misuse, neglect, fire, water, lightning, or other acts of nature, unauthorized product modification, unauthorized attempted repair, or failure to follow instructions supplied with the product.
 - b. Any damage of the product due to shipment.
 - c. Causes external to the product, such as electrical power fluctuations or failure.
 - d. Use of supplies or parts not meeting ViewSonic's specifications.
 - e. Normal wear and tear.
 - f. Any other cause which does not relate to a product defect.
3. Any product exhibiting a condition commonly known as "image burn-in" which results when a static image is displayed on the product for an extended period of time.
4. Removal, installation, insurance, and set-up service charges.

How to get service:

For information about receiving service under warranty, contact ViewSonic Customer Support (Please refer to the attached Customer Support page). You will need to provide your product's serial number, so please record the product information in the space provided below on your purchase for your future use. Please retain your receipt of proof of purchase to support your warranty claim.

For Your Records

Product Name: _____ Model Number: _____
Document Number: _____ Serial Number: _____
Purchase Date: _____ Extended Warranty Purchase? _____ (Y/N)
If so, what date does warranty expire? _____

1. To obtain warranty service, you will be required to provide (a) the original dated sales slip, (b) your name, (c) your address, (d) a description of the problem, and (e) the serial number of the product.
2. Take or ship the product in the original container packaging to an authorized ViewSonic service center.
3. Round trip transportation costs for in-warranty products will be paid by ViewSonic.

Limitation of implied warranties:

There are no warranties, express or implied, which extend beyond the description contained herein including the implied warranty of merchantability and fitness for a particular purpose.

Exclusion of damages:

ViewSonic's liability is limited to the cost of repair or replacement of the product. ViewSonic shall not be liable for:

1. Damage to other property caused by any defects in the product, damages based upon inconvenience, loss of use of the product, loss of time, loss of profits, loss of business opportunity, loss of goodwill, interference with business relationships, or other commercial loss, even if advised of the possibility of such damages.
2. Any other damages, whether incidental, consequential or otherwise.
3. Any claim against the customer by any other party.
4. Repair or attempted repair by anyone not authorized by ViewSonic.

Contact Information for Sales & Authorized Service (Centro Autorizado de Servicio) within Mexico:	
Name, address, of manufacturer and importers: México, Av. de la Palma #8 Piso 2 Despacho 203, Corporativo Interpalmas, Col. San Fernando Huixquilucan, Estado de México Tel: (55) 3605-1099 http://www.viewsonic.com/la/soporte/index.htm	
NÚMERO GRATIS DE ASISTENCIA TÉCNICA PARA TODO MÉXICO: 001.866.823.2004	
Hermosillo: Distribuciones y Servicios Computacionales SA de CV. Calle Juarez 284 local 2 Col. Bugambillas C.P: 83140 Tel: 01-66-22-14-9005 E-Mail: disc2@hmo.megared.net.mx	Villahermosa: Compumantenimientos Garantizados, S.A. de C.V. AV. GREGORIO MENDEZ #1504 COL, FLORIDA C.P. 86040 Tel: 01 (993) 3 52 00 47 / 3522074 / 3 52 20 09 E-Mail: compumantenimientos@prodigy.net.mx
Puebla, Pue. (Matriz): RENTA Y DATOS, S.A. DE C.V. Domicilio: 29 SUR 721 COL. LA PAZ 72160 PUEBLA, PUE. Tel: 01(52).222.891.55.77 CON 10 LINEAS E-Mail: datos@puebla.megared.net.mx	Veracruz, Ver.: CONEXION Y DESARROLLO, S.A DE C.V. Av. Americas # 419 ENTRE PINZÓN Y ALVARADO Fracc. Reforma C.P. 91919 Tel: 01-22-91-00-31-67 E-Mail: gacosta@qplus.com.mx
Chihuahua Soluciones Globales en Computación C. Magisterio # 3321 Col. Magisterial Chihuahua, Chih. Tel: 4136954 E-Mail: Cefeo@soluglobales.com	Cuernavaca Compusupport de Cuernavaca SA de CV Francisco Leyva # 178 Col. Miguel Hidalgo C.P. 62040, Cuernavaca Morelos Tel: 01 777 3180579 / 01 777 3124014 E-Mail: aquevedo@compusupportcva.com
Distrito Federal: QPLUS, S.A. de C.V. Av. Coyoacán 931 Col. Del Valle 03100, México, D.F. Tel: 01(52)55-50-00-27-35 E-Mail: gacosta@qplus.com.mx	Guadalajara, Jal.: SERVICRECE, S.A. de C.V. Av. Niños Héroes # 2281 Col. Arcos Sur, Sector Juárez 44170, Guadalajara, Jalisco Tel: 01(52)33-36-15-15-43 E-Mail: mmiranda@servicrece.com
Guerrero Acapulco GS Computación (Grupo Sesicomp) Progreso #6-A, Colo Centro 39300 Acapulco, Guerrero Tel: 744-48-32627	Monterrey: Global Product Services Mar Caribe # 1987, Esquina con Golfo Pérsico Fracc. Bernardo Reyes, CP 64280 Monterrey N.L. México Tel: 8129-5103 E-Mail: aydeem@gps1.com.mx
MERIDA: ELECTROSER Av Reforma No. 403Gx39 y 41 Mérida, Yucatán, México CP97000 Tel: (52) 999-925-1916 E-Mail: rrb@sureste.com	Oaxaca, Oax.: CENTRO DE DISTRIBUCION Y SERVICIO, S.A. de C.V. Murguía # 708 P.A., Col. Centro, 68000, Oaxaca Tel: 01(52)95-15-15-22-22 Fax: 01(52)95-15-13-67-00 E-Mail: gpotai2001@hotmail.com
Tijuana: STD Av Ferrocarril Sonora #3780 L-C Col 20 de Noviembre Tijuana, Mexico	FOR USA SUPPORT: ViewSonic Corporation 10 Pointe Dr. Suite 200. Brea, CA. 92821, UY.S.A Tel: 800-688-6688 (English); 866-323-8056 (Spanish); E-Mail: http://www.viewsonic.com



ViewSonic®