

LS510W/LS510WH/LS510WH-2/LS560W/LS560WH/LS560HDH

**Projector
User Guide**

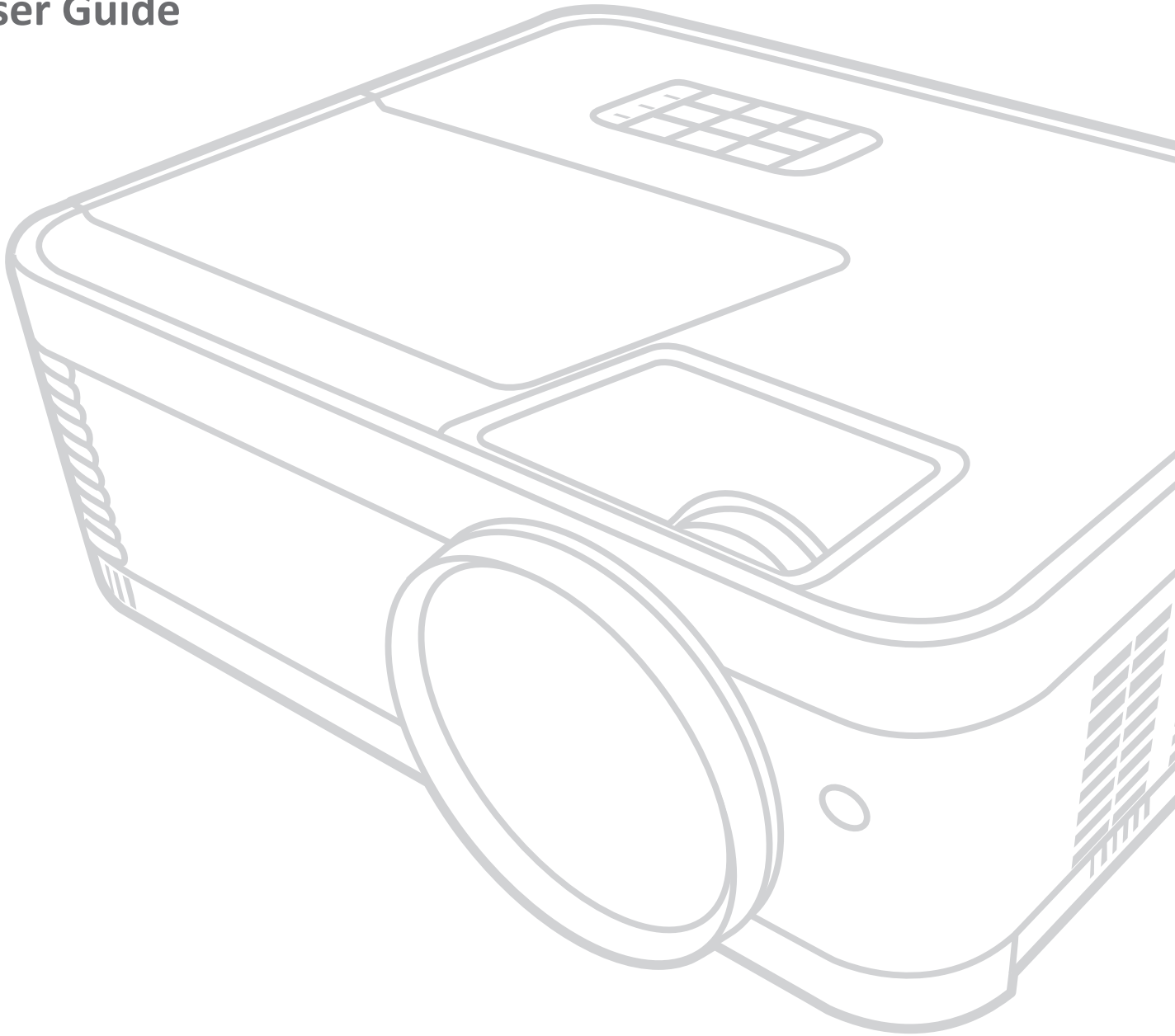

IMPORTANT: Please read this User Guide to obtain important information on installing and using your product in a safe manner, as well as registering your product for future service. Warranty information contained in this User Guide will describe your limited coverage from ViewSonic Corporation, which is also found on our web site at <http://www.viewsonic.com> in English, or in specific languages using the Regional selection box in the upper right corner of our website. "Antes de operar su equipo lea cuidadosamente las instrucciones en este manual"

Model No. VS19167/VS19170/VS19172

Model Name: LS510W/LS510WH/LS510WH-2/LS560W/LS560WH/LS560HDH

Thank you for choosing ViewSonic®

As a world-leading provider of visual solutions, ViewSonic® is dedicated to exceeding the world's expectations for technological evolution, innovation, and simplicity. At ViewSonic®, we believe that our products have the potential to make a positive impact in the world, and we are confident that the ViewSonic® product you have chosen will serve you well.

Once again, thank you for choosing ViewSonic®!

Safety Precautions - General

Please read the following **Safety Precautions** before you start using the projector.

- Keep this user guide in a safe place for later reference.
- Read all warnings and follow all instructions.
- Allow at least 20" (50 cm) clearance around the projector to ensure proper ventilation.
- Place the projector in a well-ventilated area. Do not place anything on the projector that prevents heat dissipation.
- Do not place the projector on an uneven or unstable surface. The projector may fall over, causing personal injury or projector malfunction.
- Do not use if the projector is tilted at an angle of more than 10° degrees left or right, nor at an angle of more than 15° degrees forwards or backwards.
- Do not look straight at the projector lens during operation. The intense light beam may damage your eyes.
- Always open the lens shutter or remove the lens cap when the projector lamp is on.
- Do not block the projection lens with any objects when the projector is under operation as this could cause objects to become heated and deformed or even cause a fire.
- The lamp becomes extremely hot during operation. Allow the projector to cool for approximately 45 minutes prior to removing the lamp assembly for replacement.
- Do not use lamps beyond the rated lamp life. Excessive use of lamps beyond the rated life could cause them to break on rare occasions.
- Never replace the lamp assembly or any electronic component unless the projector is unplugged.
- Do not attempt to disassemble the projector. There are dangerous high voltages inside which may cause death if you should come into contact with live parts.
- When moving the projector, be careful not to drop or bump the projector on anything.
- Do not place any heavy objects on the projector or connection cables.
- Do not stand the projector on end vertically. Doing so may cause the projector to fall over, causing personal injury or projector malfunction.
- Avoid exposing the projector to direct sunlight or other sources of sustained heat. Do not install near any heat sources such as radiators, heat registers, stoves, or other devices (including amplifiers) that may increase the temperature of the projector to dangerous levels.

- Do not place liquids near or on the projector. Liquids spilled into the projector may cause it to fail. If the projector does become wet, disconnect it from the power supply and call your local service center to have the projector serviced.
- When the projector is under operation, you may sense some heated air and odor from its ventilation grill. It is a normal operation and not a defect.
- Do not attempt to circumvent the safety provisions of the polarized or grounding-type plug. A polarized plug has two blades with one wider than the other. A grounding-type plug has two blades and a third grounding prong. The wide and third blade are provided for your safety. If the plug does not fit into your outlet, obtain an adapter and do not attempt to force the plug into the outlet.
- When connecting to a power outlet, DO NOT remove the grounding prong. Please ensure grounding prongs are NEVER REMOVED.
- Protect the power cord from being treaded upon or pinched, particularly at the plug, and at the point where it emerges from the projector.
- In some countries, the voltage is NOT stable. This projector is designed to operate safely within a voltage between 100 to 240 volts AC, but could fail if power cuts or surges of ± 10 volts occur. In areas where voltage may fluctuate or cut out, it is recommended that you connect your projector through a power stabilizer, surge protector, or uninterruptable power supply (UPS).
- If smoke, an abnormal noise, or a strange odor is present, immediately switch the projector off and call your dealer or ViewSonic®. It is dangerous to continue using the projector.
- Use only attachments/accessories specified by the manufacturer.
- Disconnect the power cord from the AC outlet if the projector is not being used for a long period of time.
- Refer all servicing to qualified service personnel.



CAUTION: Possibly hazardous optical radiation is emitted from this product. As with any bright light source, do not stare into the beam,
RG2 IEC 62471-5:2015.

Safety Precautions - Ceiling Mounting

Please read the following **Safety Precautions** before you start using the projector.

If you intend to mount the projector on the ceiling, we strongly recommend that you use a proper fitting projector ceiling mount kit and that you ensure it is securely and safely installed.

If you use an inappropriate projector ceiling mount kit, there is a safety risk that the projector may fall from the ceiling due to an improper attachment through the use of the wrong gauge or length screws.

You can purchase a projector ceiling mount kit from the place you purchased your projector. We recommend that you also purchase a separate security cable and attach it securely to both the anti-theft lock slot on the projector and the base of the ceiling mount bracket. This will perform the secondary role of restraining the projector should its attachment to the mounting bracket become loose.

Contents

Safety Precautions - General	3
Safety Precautions - Ceiling Mounting	5
Introduction	9
Package Contents	9
Product Overview	10
Projector.....	10
Controls and Functions	10
Connection Ports.....	11
Remote Control	13
Controls and Functions	13
Remote Control Effective Range	14
Replacing the Remote Control Batteries.....	15
Initial Setup.....	16
Choosing a Location.....	16
Projection Dimensions.....	17
16:10 Image on a 16:10 Screen	17
LS510W/LS510WH/LS510WH-2	17
LS560W/LS560WH	18
16:10 Image on a 4:3 Screen	18
LS510W/LS510WH/LS510WH-2	18
LS560W/LS560WH	19
LS560HDH.....	19
16:9 Image on a 16:9 Screen.....	20
16:9 Image on a 4:3 Screen.....	20
Mounting the Projector	21
Preventing Unauthorized Use.....	22
Using the Security Slot	22
Using the Password Function	23
Setting a Password.....	23
Changing the Password.....	24
Disabling the Password Function	24
Forgetting the Password	25
Password Recall Procedure.....	25
Locking the Control Keys.....	26

Making Connections	27
Connecting to Power	27
Connecting to Computer Sources.....	28
VGA Connection	28
VGA Out Connection	28
Connecting to Video/Computer Sources.....	28
HDMI Connection.....	28
Connecting to Audio.....	28
Operation.....	30
Turning the Projector On/Off	30
Starting Up the Projector	30
First Time Activation	30
Shutting Down the Projector.....	31
Selecting an Input Source	32
Adjusting the Projected Image	33
Adjusting the Projector's Height and Projection Angle.....	33
Auto-Adjusting the Image.....	33
Fine-Tuning the Image Size and Clarity	33
Correcting Keystone	34
Adjusting 4 corners	35
Hiding the Image	35
Controlling the Projector through a LAN Environment	36
Configuring the LAN Control Settings.....	36
Menu Functions	38
General On-Screen Display (OSD) Menu Operation	38
On-Screen Display (OSD) Menu Tree.....	39
DISPLAY Menu	46
IMAGE Menu	49
POWER MANAGEMENT Menu	52
BASIC Menu	55
ADVANCED Menu	58
SYSTEM Menu.....	61
INFORMATION Menu	63

Appendix.....	64
Specifications.....	64
Projector Dimensions.....	65
Timing Chart.....	66
Analog RGB.....	66
HDMI (PC).....	67
HDMI (Video).....	69
Component video.....	69
Troubleshooting.....	70
Common Problems.....	70
LED Indicators.....	71
Maintenance.....	72
General Precautions.....	72
Cleaning the Lens.....	72
Cleaning the Case.....	72
Storing the Projector.....	72
Disclaimer.....	72
Light Source Information.....	73
Light Source Hour.....	73
Extending Light Source Life.....	73
Regulatory and Service Information	74
Compliance Information.....	74
FCC Compliance Statement.....	74
Industry Canada Statement.....	74
CE Conformity for European Countries.....	74
Declaration of RoHS2 Compliance.....	75
Indian Restriction of Hazardous Substances.....	76
Product Disposal at End of Product Life.....	76
Copyright Information.....	77
Customer Service.....	78
Limited Warranty.....	79
Mexico Limited Warranty.....	82

Introduction

Package Contents

LS560W / LS560WH /
LS560HDH

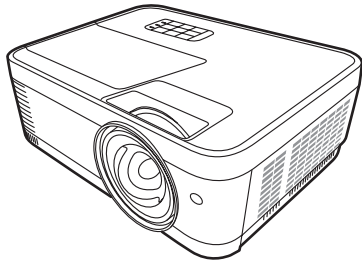

LS510W / LS510WH /
LS510WH-2

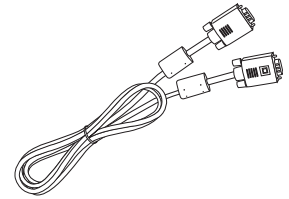
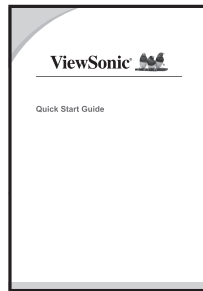
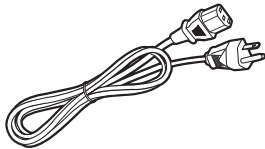
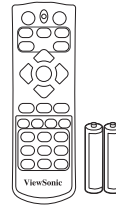
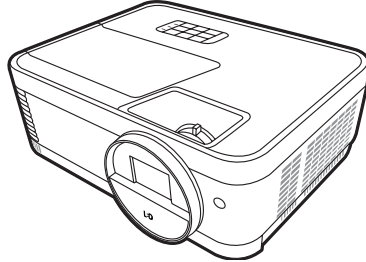

(LS510W/LS560W only)

NOTE: The power cord and video cables included in your package may vary depending on your country. Please contact your local reseller for more information.

Product Overview

Projector

Controls and Functions

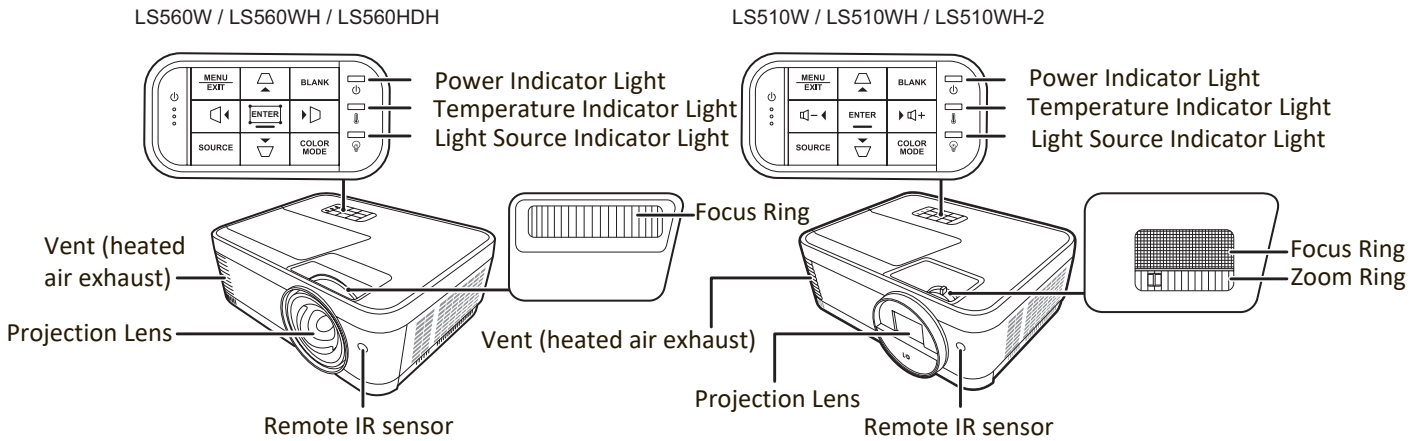

Key	Description
[] Power	Toggles the projector between standby mode and Power On.
[] Keystone Keys	Manually corrects distorted images resulting from an angled projection.
[] Volume Keys	Decreases/Increases the volume level.
[] Left/Right/Up/Down	Selects the desired menu items and makes adjustments when the On-Screen Display (OSD) Menu is activated.
Menu	<ul style="list-style-type: none"> Turns on or off the On-Screen Display (OSD) Menu. Goes back to previous OSD menu, exits and saves menu settings.
Exit	
Source	<ul style="list-style-type: none"> Displays the input source selection bar. Displays the HELP menu by a long press for 3 seconds.
Blank	Hides the screen picture.
Enter	Enacts the selected On-Screen Display (OSD) Menu item when the OSD Menu is activated.
[] Corner Adjustment	Displays the Corner Adj. menu.
Color Mode	Displays the color mode selection bar.

Connection Ports

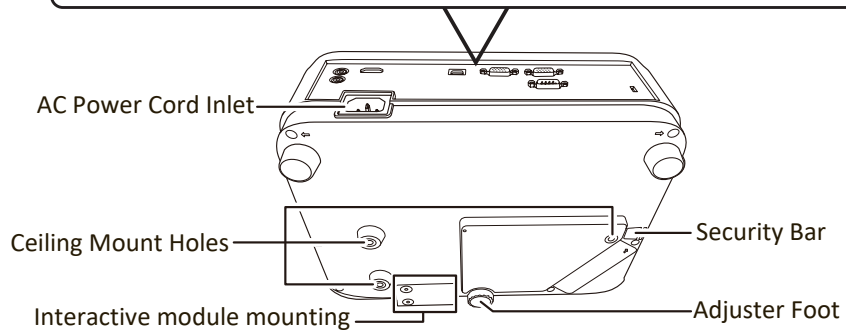
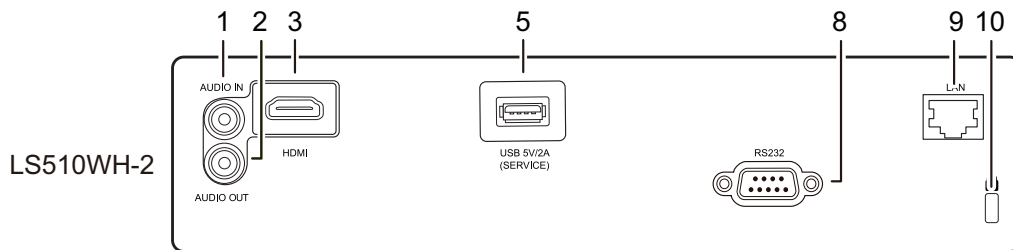
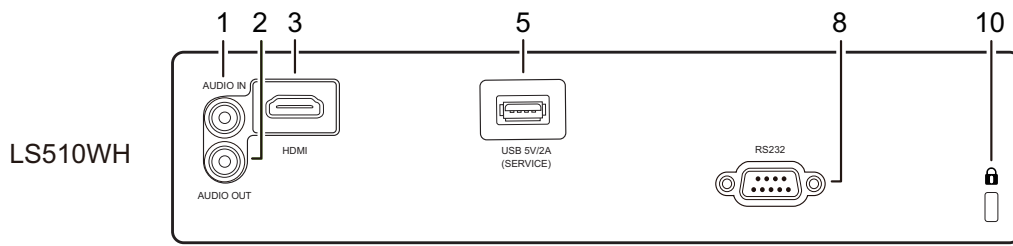
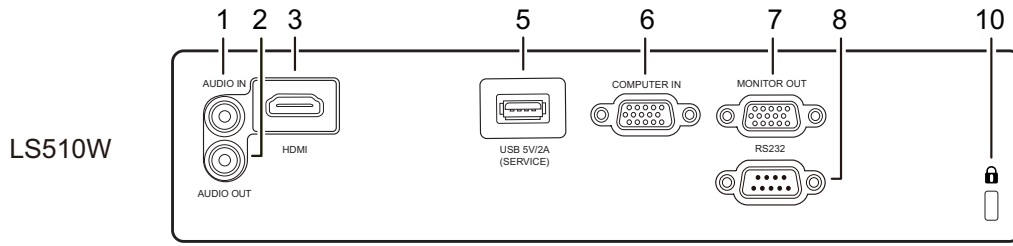
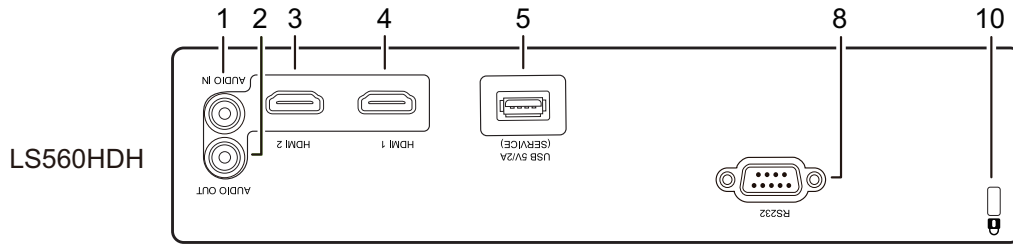
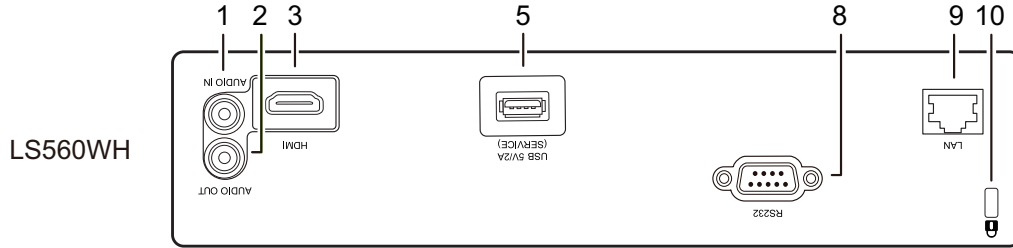
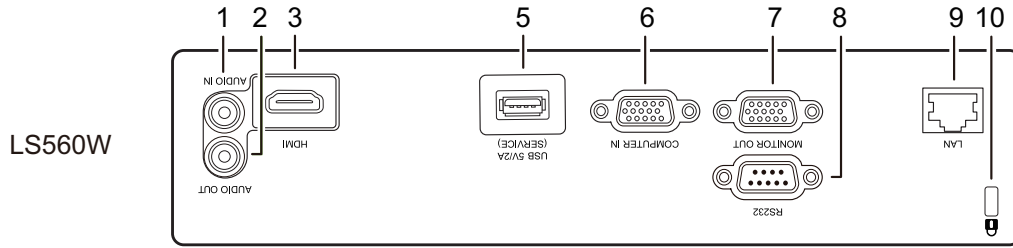

Port	Description
[1] AUDIO IN	Audio signal input socket.
[2] AUDIO OUT	Audio signal output socket.
[3] HDMI; HDMI 2	HDMI port.
[4] HDMI 1	HDMI port.
[5] USB 5V/2A (SERVICE)	USB Type A port for power supply.
[6] COMPUTER IN	RGB (PC)/Component video (YPbPr/YCbCr) signal input socket.
[7] MONITOR OUT	RGB signal output socket.
[8] RS232	RS232 control port.
[9] RJ-45	LAN port.
[10] 	Kensington anti-theft lock slot

Remote Control

Controls and Functions

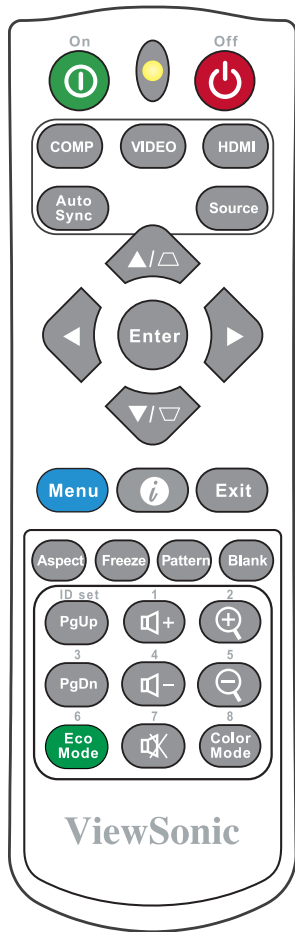

Button	Description
ⓘ On/⏻ Off	Toggles between standby mode and Power On.
COMP	Selects the source from the COMPUTER IN port for display. NOTE: Only available for LS510W/LS560W.
VIDEO	Not available.
HDMI	Selects the source from the HDMI port(s) for display. Press this button again to switch between the two (2) ports if available.

Button	Description
Auto Sync	Automatically determines the best picture timings for the displayed image.
Source	<ul style="list-style-type: none"> Displays the source selection bar. Displays the HELP menu by a long press for 3 seconds.
[⏏/⏏] Keystone Keys	Manually corrects distorted images resulting from an angled projection.
Enter	Enacts the selected OSD Menu item.
◀ Left/▶ Right ▲ Up/ ▼ Down	Selects the desired menu items and makes adjustments.
Menu	Turns on/off the On-Screen Display (OSD) Menu or goes back to previous OSD Menu.
ⓘ (INFORMATION)	<ul style="list-style-type: none"> Displays the INFORMATION menu. Displays the HELP menu by a long press for 3 seconds.
Exit	Exits and saves menu settings.
Aspect	Displays the aspect ratio selection bar.
Freeze	Freezes the projected image.
Pattern	Displays embedded test pattern.
Blank	Hides the screen picture.

NOTE: The corner adjustment (P35) and horizontal keystone (P34) functions are available on LS560W/LS560WH/LS560HDH only.

Button	Description
PgUp (Page Up)/ PgDn (Page Down)	Operates your display software program (on a connected PC) which responds to page up/down commands (like Microsoft PowerPoint). NOTE: Only available when a PC input signal is selected.
Eco Mode	Selects the Eco mode.
🔊+ (Volume Up)	Increases the volume level.
🔊- (Volume Down)	Decreases the volume level.
🔇 (Mute)	Toggles audio between on and off.
🔍+	Magnifies the projected picture size.
🔍-	Reduces the projected picture size.
Color Mode	Displays the color mode selection bar.

Remote Control Effective Range

To ensure proper function of the remote control follow the steps below:

1. The remote control must be held at an angle within 30° perpendicular to the projector's IR remote control sensor(s).
2. The distance between the remote control and the sensor(s) should not exceed 8 m (26 ft.)

NOTE: Refer to the illustration for the location of the infrared (IR) remote control sensor(s).

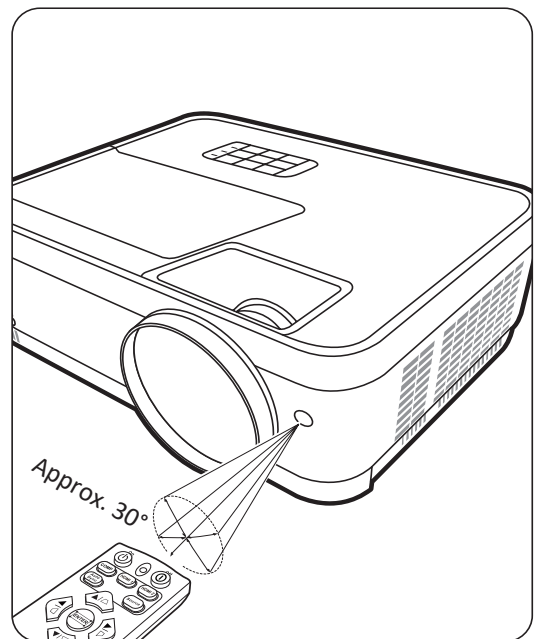

Replacing the Remote Control Batteries

1. Remove the battery cover from the rear of the remote control by pressing the finger grip and sliding it down.
2. Remove any existing batteries (if necessary) and install two AAA batteries.

NOTE: Observe the battery's polarities as indicated.

3. Replace the battery cover by aligning it with the base and pushing it back into position.

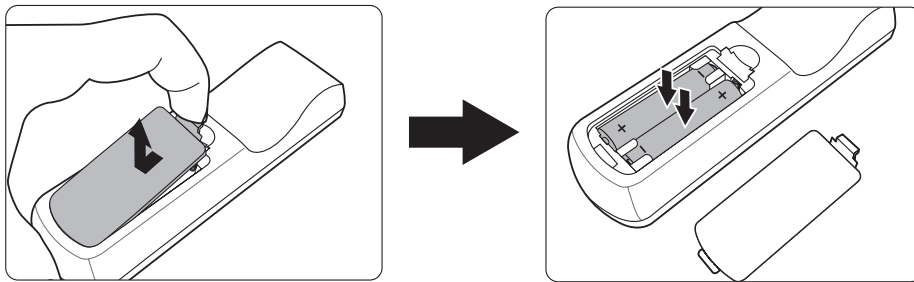

NOTE:

- Avoid leaving the remote control and batteries in excessive heat or a humid environment.
- Replace only with the same or equivalent type recommended by the battery manufacturer.
- Dispose of the used batteries according to the manufacturer's instructions and local environment regulations for your region.
- If the batteries are drained or if you will not be using the remote control for an extended period of time, remove the batteries to avoid damage to the remote control.

Initial Setup

This section provides detailed instructions for setting up your projector.

Choosing a Location

Personal preference and room layout will decide the installation location. Consider the following:

- Size and Position of your screen.
- Location of a suitable power outlet.
- Location and Distance between the projector and other equipment.

The projector is designed to be installed in one of the following locations:

1. Front Table

The projector is placed near the floor in front of the screen.

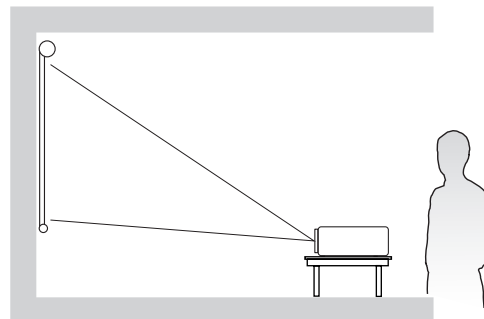

2. Rear Table

The projector is placed near the floor behind the screen.

NOTE: A special rear projection screen is required.

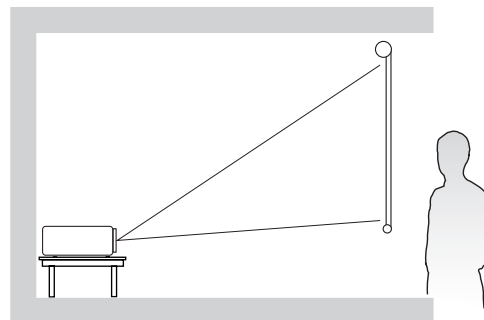

3. Rear Ceiling

The projector is suspended upside-down from the ceiling behind the screen.

NOTE: A special rear projection screen is required.

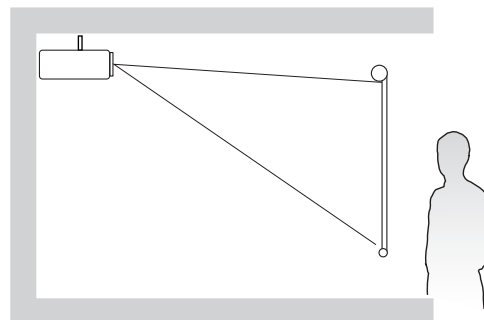

4. Front Ceiling

The projector is suspended upside-down from the ceiling in front of the screen.

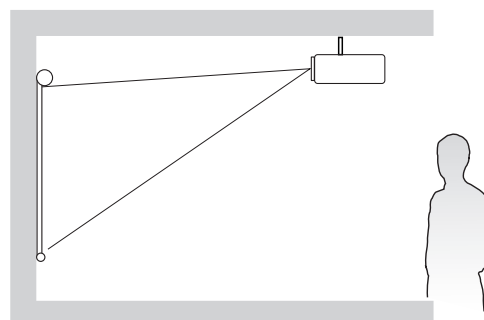

Projection Dimensions

NOTE: See “Specifications” on page 64 for the native display resolution of this projector.

- **16:10 Image on a 16:10 Screen**

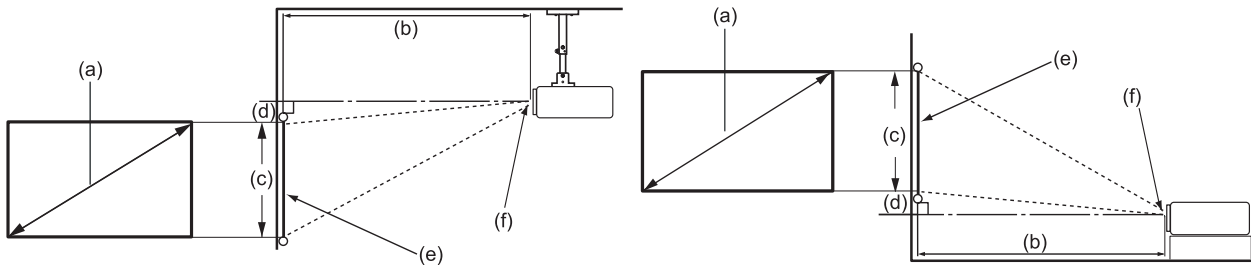

- **16:10 Image on a 4:3 Screen**

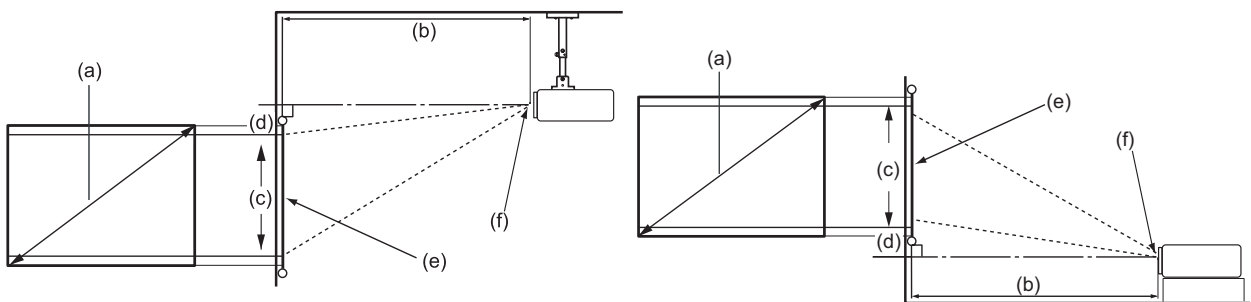

NOTE: (e) = Screen
(f) = Center of Lens

16:10 Image on a 16:10 Screen

LS510W/LS510WH/LS510WH-2

(a) Screen Size		(b) Projection Distance				(c) Image Height		(d) Vertical Offset			
		minimum		maximum				minimum		maximum	
inch	mm	inch	mm	inch	mm	inch	mm	inch	mm	inch	mm
30	762	39.37	1000	43.31	1100	15.90	404	0.00	0	0.00	0
60	1524	78.74	2000	86.61	2200	31.80	808	0.00	0	0.00	0
70	1778	91.86	2333	101.05	2567	37.10	942	0.00	0	0.00	0
80	2032	104.99	2667	115.49	2933	42.40	1077	0.00	0	0.00	0
90	2286	118.11	3000	129.92	3300	47.70	1212	0.00	0	0.00	0
100	2540	131.23	3333	144.36	3667	53.00	1346	0.00	0	0.00	0
110	2794	144.36	3667	158.79	4033	58.30	1481	0.00	0	0.00	0
120	3048	157.48	4000	173.23	4400	63.60	1615	0.00	0	0.00	0
130	3302	170.60	4333	187.66	4767	68.90	1750	0.00	0	0.00	0
140	3556	183.73	4667	202.10	5133	74.20	1885	0.00	0	0.00	0
150	3810	196.85	5000	216.54	5500	79.50	2019	0.00	0	0.00	0
200	5080	262.47	6667	288.71	7333	106.00	2692	0.00	0	0.00	0
250	6350	328.08	8333	360.89	9167	132.50	3365	0.00	0	0.00	0
300	7620	393.70	10000	433.07	11000	159.00	4039	0.00	0	0.00	0

LS560W/LS560WH

(a) Screen Size		(b) Projection Distance				(c) Image Height		(d) Vertical Offset			
		minimum		maximum				minimum		maximum	
inch	mm	inch	mm	inch	mm	inch	mm	inch	mm	inch	mm
60	1524	24.84	631	24.84	631	31.80	808	3.18	81	3.18	81
70	1778	28.98	736	28.98	736	37.10	942	3.71	94	3.71	94
80	2032	33.13	841	33.13	841	42.40	1077	4.24	108	4.24	108
90	2286	37.27	947	37.27	947	47.70	1212	4.77	121	4.77	121
100	2540	41.41	1052	41.41	1052	53.00	1346	5.30	135	5.30	135
110	2794	45.55	1157	45.55	1157	58.30	1481	5.83	148	5.83	148
120	3048	49.69	1262	49.69	1262	63.60	1615	6.36	162	6.36	162
130	3302	53.83	1367	53.83	1367	68.90	1750	6.89	175	6.89	175
140	3556	57.97	1472	57.97	1472	74.20	1885	7.42	188	7.42	188
150	3810	62.11	1578	62.11	1578	79.50	2019	7.95	202	7.95	202
200	5080	82.81	2103	82.81	2103	106.00	2692	10.60	269	10.60	269
250	6350	103.52	2629	103.52	2629	132.50	3365	13.25	337	13.25	337
300	7620	124.22	3155	124.22	3155	159.00	4039	15.90	404	15.90	404

16:10 Image on a 4:3 Screen

LS510W/LS510WH/LS510WH-2

(a) Screen Size		(b) Projection Distance				(c) Image Height		(d) Vertical Offset			
		minimum		maximum				minimum		maximum	
inch	mm	inch	mm	inch	mm	inch	mm	inch	mm	inch	mm
30	762	37.14	943	40.86	1038	15.00	381	0.00	0	0.00	0
60	1524	74.28	1887	81.71	2075	30.00	762	0.00	0	0.00	0
70	1778	86.66	2201	95.33	2421	35.00	889	0.00	0	0.00	0
80	2032	99.04	2516	108.95	2767	40.00	1016	0.00	0	0.00	0
90	2286	111.42	2830	122.57	3113	45.00	1143	0.00	0	0.00	0
100	2540	123.81	3145	136.19	3459	50.00	1270	0.00	0	0.00	0
110	2794	136.19	3459	149.80	3805	55.00	1397	0.00	0	0.00	0
120	3048	148.57	3774	163.42	4151	60.00	1524	0.00	0	0.00	0
130	3302	160.95	4088	177.04	4497	65.00	1651	0.00	0	0.00	0
140	3556	173.33	4403	190.66	4843	70.00	1778	0.00	0	0.00	0
150	3810	185.71	4717	204.28	5189	75.00	1905	0.00	0	0.00	0
200	5080	247.61	6289	272.37	6918	100.00	2540	0.00	0	0.00	0
250	6350	309.51	7862	340.47	8648	125.00	3175	0.00	0	0.00	0
300	7620	371.42	9434	408.56	10377	150.00	3810	0.00	0	0.00	0

LS560W/LS560WH

(a) Screen Size		(b) Projection Distance				(c) Image Height		(d) Vertical Offset			
		minimum		maximum				minimum		maximum	
inch	mm	inch	mm	inch	mm	inch	mm	inch	mm	inch	mm
60	1524	23.44	595	23.44	595	30.00	762	3.00	76	3.00	76
70	1778	27.34	695	27.34	695	35.00	889	3.50	89	3.50	89
80	2032	31.25	794	31.25	794	40.00	1016	4.00	102	4.00	102
90	2286	35.16	893	35.16	893	45.00	1143	4.50	114	4.50	114
100	2540	39.06	992	39.06	992	50.00	1270	5.00	127	5.00	127
110	2794	42.97	1091	42.97	1091	55.00	1397	5.50	140	5.50	140
120	3048	46.88	1191	46.88	1191	60.00	1524	6.00	152	6.00	152
130	3302	50.78	1290	50.78	1290	65.00	1651	6.50	165	6.50	165
140	3556	54.69	1389	54.69	1389	70.00	1778	7.00	178	7.00	178
150	3810	58.59	1488	58.59	1488	75.00	1905	7.50	191	7.50	191
200	5080	78.13	1984	78.13	1984	100.00	2540	10.00	254	10.00	254
250	6350	97.66	2480	97.66	2480	125.00	3175	12.50	318	12.50	318
300	7620	117.19	2977	117.19	2977	150.00	3810	15.00	381	15.00	381

NOTE: It is recommended that if you intend to permanently install the projector, please physically test the projection size and distance using the actual projector in situ before you permanently install it.

LS560HDH

• **16:9 Image on a 16:9 Screen**

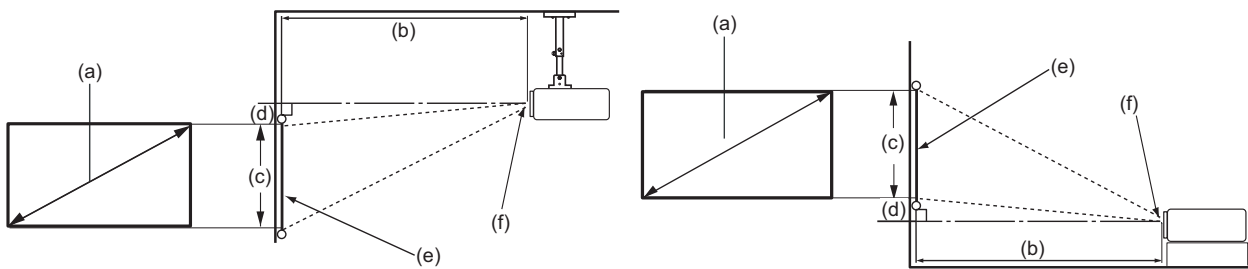

• **16:9 Image on a 4:3 Screen**

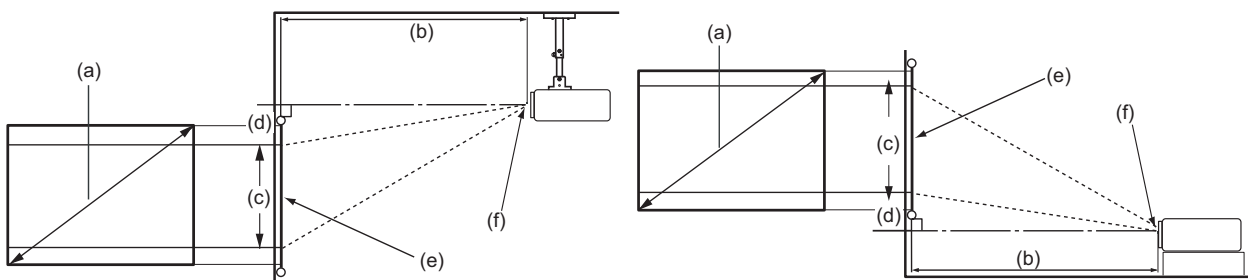

NOTE: (e) = Screen
(f) = Center of Lens

16:9 Image on a 16:9 Screen

(a) Screen Size		(b) Projection Distance				(c) Image Height		(d) Vertical Offset			
		minimum		maximum				minimum		maximum	
in.	mm	in.	mm	in.	mm	in.	mm	in.	mm	in.	mm
30	762	12.16	309	12.16	309	14.71	374	2.35	60	2.35	60
60	1524	24.32	618	24.32	618	29.42	747	4.71	120	4.71	120
70	1778	28.37	721	28.37	721	34.32	872	5.49	139	5.49	139
80	2032	32.42	824	32.42	824	39.22	996	6.28	159	6.28	159
90	2286	36.48	927	36.48	927	44.12	1121	7.06	179	7.06	179
100	2540	40.53	1029	40.53	1029	49.03	1245	7.84	199	7.84	199
110	2794	44.58	1132	44.58	1132	53.93	1370	8.63	219	8.63	219
120	3048	48.64	1235	48.64	1235	58.83	1494	9.41	239	9.41	239
130	3302	52.69	1338	52.69	1338	63.73	1619	10.20	259	10.20	259
140	3556	56.74	1441	56.74	1441	68.64	1743	10.98	279	10.98	279
150	3810	60.80	1544	60.80	1544	73.54	1868	11.77	299	11.77	299
200	5080	81.06	2059	81.06	2059	98.05	2491	15.69	398	15.69	398
250	6350	101.33	2574	101.33	2574	122.57	3113	19.61	498	19.61	498
300	7620	121.59	3088	121.59	3088	147.08	3736	23.53	598	23.53	598

16:9 Image on a 4:3 Screen

(a) Screen Size		(b) Projection Distance				(c) Image Height		(d) Vertical Offset			
		minimum		maximum				minimum		maximum	
in.	mm	in.	mm	in.	mm	in.	mm	in.	mm	in.	mm
30	762	11.16	283	11.16	283	13.50	343	2.16	55	2.16	55
60	1524	22.32	567	22.32	567	27.00	686	4.32	110	4.32	110
70	1778	26.04	661	26.04	661	31.50	800	5.04	128	5.04	128
80	2032	29.76	756	29.76	756	36.00	914	5.76	146	5.76	146
90	2286	33.48	850	33.48	850	40.50	1029	6.48	165	6.48	165
100	2540	37.20	945	37.20	945	45.00	1143	7.20	183	7.20	183
110	2794	40.92	1039	40.92	1039	49.50	1257	7.92	201	7.92	201
120	3048	44.64	1134	44.64	1134	54.00	1372	8.64	219	8.64	219
130	3302	48.36	1228	48.36	1228	58.50	1486	9.36	238	9.36	238
140	3556	52.08	1323	52.08	1323	63.00	1600	10.08	256	10.08	256
150	3810	55.80	1417	55.80	1417	67.50	1715	10.80	274	10.80	274
200	5080	74.40	1890	74.40	1890	90.00	2286	14.40	366	14.40	366
250	6350	93.01	2362	93.01	2362	112.50	2858	18.00	457	18.00	457
300	7620	111.61	2835	111.61	2835	135.00	3429	21.60	549	21.60	549

NOTE: It is recommended that if you intend to permanently install the projector, please physically test the projection size and distance using the actual projector in situ before you permanently install it.

Mounting the Projector

NOTE: If you buy a third-party mount, please use the correct screw size. Screw size can vary depending on the thickness of the mounting plate.

1. To ensure the most secure installation, please use a ViewSonic® wall or ceiling mount.
2. Ensure the screws used to attach a mount to the projector meet the following specifications:
 - Screw type: M4 x 8
 - Maximum Screw length: 8 mm

LS560W / LS560WH / LS560HDH

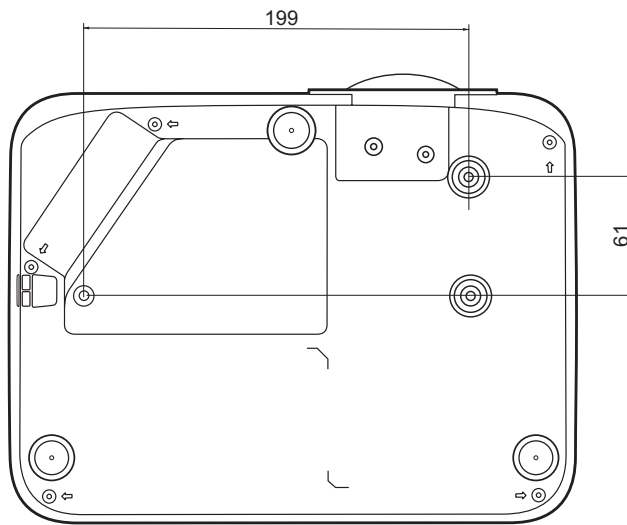

LS510W / LS510WH / LS510WH-2

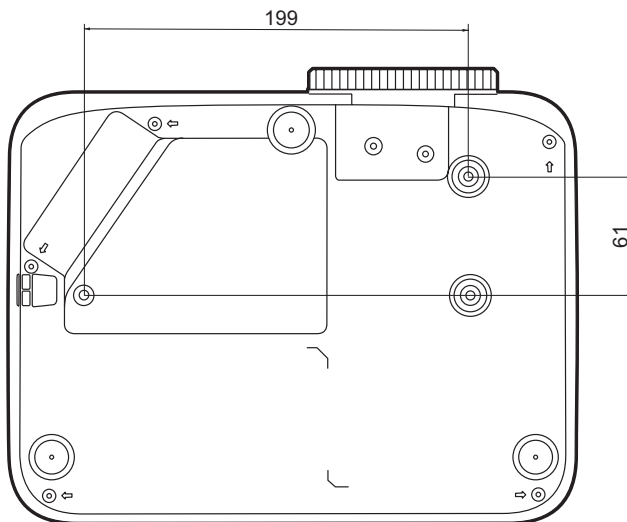

NOTE:

- Avoid installing the projector near a heat source.
- Keep at least a 10 cm gap between the ceiling and the bottom of the projector.

Preventing Unauthorized Use

The projector has several built-in security features to prevent theft, access, or accidental setting changes.

Using the Security Slot

To help prevent the projector from being stolen, use a security slot locking device to secure the projector to a fixed object.

Below is an example of setting up a security slot locking device:

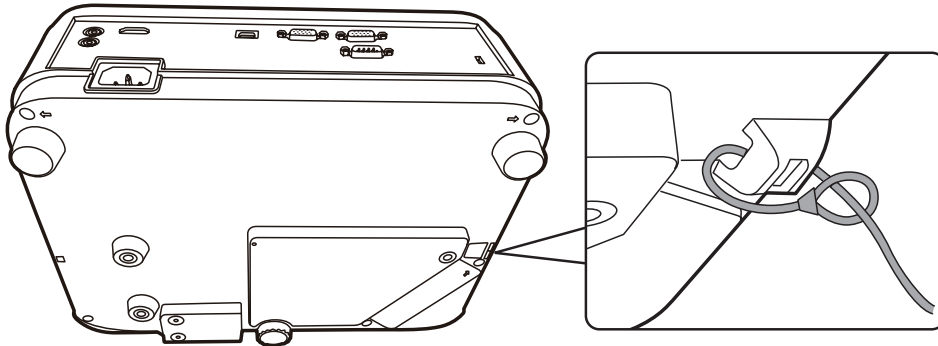

NOTE: The security slot can also be used as a safety anchor if the projector is mounted to the ceiling.

Using the Password Function

To help prevent unauthorized access or use, the projector offers a password security option. The password can be set through the On-Screen Display (OSD) Menu.

NOTE: Make note of your password, and keep it in a safe place.

Setting a Password

1. Press **Menu** to open the OSD Menu and go to: **SYSTEM > Security Settings** and press **Enter**.
2. Highlight **Power On Lock** and select **On** by pressing **◀/▶**.
3. As pictured to the right, the four arrow keys (**▲**, **▶**, **▼**, **◀**) represent 4 digits (1, 2, 3, 4). Press the arrow keys to enter a six digit password.



4. Confirm the new password by re-entering the new password. Once the password is set, the OSD Menu will return to the **Security Settings** page.
5. Press **Exit** to leave the OSD Menu.

NOTE: Once set, the correct password must be entered every time the projector is started.

Changing the Password

1. Press **Menu** to open the OSD Menu and go to: **SYSTEM > Security Settings > Change Password**.
2. Press **Enter**, the message, 'INPUT CURRENT PASSWORD' will appear.
3. Enter the old password.
 - » If the password is correct, the message, 'INPUT NEW PASSWORD' will appear.
 - » If the password is incorrect, a password error message will appear for 5 seconds followed by the message, 'INPUT CURRENT PASSWORD'. You can try again or press **Exit** to cancel.
4. Enter a new password.
5. Confirm the new password by re-entering the new password.
6. To leave the OSD Menu, press **Exit**.

NOTE: The digits being input will display as asterisks(*).

Disabling the Password Function

1. Press **Menu** to open the OSD Menu and go to: **SYSTEM > Security Settings > Power On Lock**.
2. Press **◀/▶** to select **Off**.
3. The message, "Input Password" will appear. Enter the current password.
 - » If the password is correct, the OSD Menu returns to the Password page with "**Off**" shown in the row of **Power On Lock**.
 - » If the password is incorrect, a password error message will appear for 5 seconds followed by the message, 'INPUT CURRENT PASSWORD'. You can try again or press **Exit** to cancel.

NOTE: Please keep the old password, as you will need it to reactivate the password function.

Forgetting the Password

If the password function is activated, you will be asked to enter the six-digit password every time you turn on the projector. If you enter the wrong password, the password error message, as pictured to the right, will appear for 5 seconds, and the message 'INPUT PASSWORD' follows.

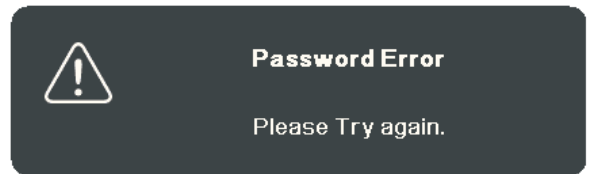

You can retry or if you do not remember, you can use the "Password Recall Procedure".

NOTE: If you enter an incorrect password 5 times in succession, the projector will automatically shut down for a short time.

Password Recall Procedure

1. When the message 'INPUT CURRENT PASSWORD' appears, press and hold **Auto Sync** for 3 seconds. The projector will display a coded number on the screen.
2. Write down the number and turn off your projector.
3. Seek help from the local service center to decode the number. You may be required to provide proof of purchase documentation to verify that you are an authorized user of the projector.

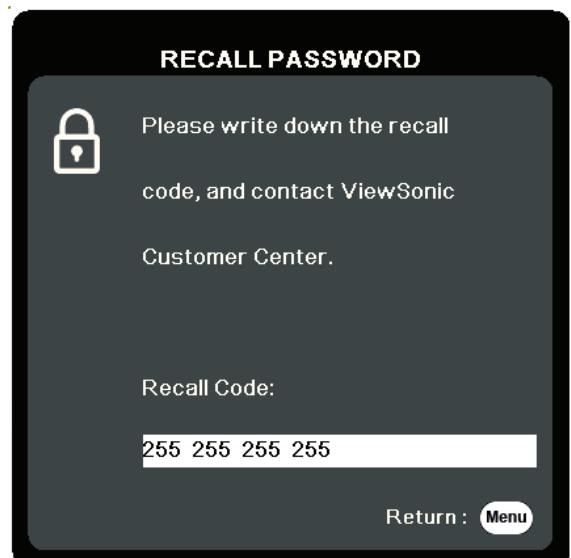

Locking the Control Keys

With the control keys on the projector locked, you can prevent your settings from being changed accidentally (by children, for example).

NOTE: When the **Panel Key Lock** is On, no control keys on the projector will operate except **Power**.

1. Press **Menu** to open the OSD Menu and go to: **SYSTEM > Panel Key Lock**.
2. Press **▲/▼** to select **On**.
3. Select **Yes** and press **Enter** to confirm.
4. To release panel key lock, press and hold **▶** on the projector for 3 seconds.

NOTE: You can also use the remote control to enter the **SYSTEM > Panel Key Lock** menu and select **Off**.

Making Connections

This section guides you on how to connect the projector with other equipment.

Connecting to Power

1. Connect the power cord to the AC IN jack at the rear of the projector.
2. Plug the power cord into a power outlet.

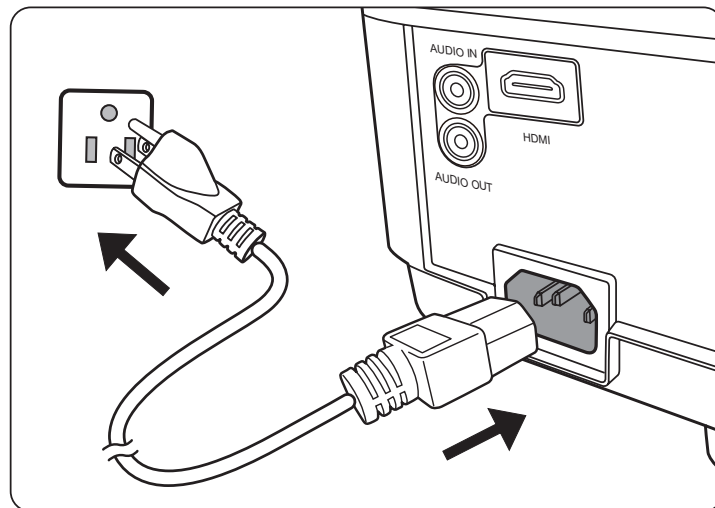

NOTE: When installing the projector, incorporate a readily accessible disconnect device in the fixed wiring, or connect the power plug to an easily accessible outlet near the unit. If a fault should occur during operation of the projector, use the disconnect device to switch off the power supply, or disconnect the power plug.

Connecting to Computer Sources

NOTE: This function is only available for LS510W/LS560W.

VGA Connection

Connect one end of a VGA cable to the VGA port of your computer. Then connect the other end of the cable to the **COMPUTER IN** port of your projector.

NOTE: Some notebooks do not turn on their external displays automatically when connected to a projector. You may have to adjust your notebook's projection settings.

VGA Out Connection

After establishing the VGA Connection, connect one end of a VGA cable to the VGA port of your monitor. Then connect the other end of the cable to the **MONITOR OUT** port of your projector.

Connecting to Video/Computer Sources

HDMI Connection

Connect one end of an HDMI cable to the HDMI port of your video/computer device. Then connect the other end of the cable to the **HDMI** port of your projector.

Connecting to Audio

The projector is equipped with speakers, however, you can also connect external speakers to the **AUDIO OUT** port of the projector.

NOTE: The audio output is controlled by the projector's **Volume** and **Mute** settings.

NOTE: For a DVI to HDMI digital signal, if the DVI signal is not standard, the **AUDIO IN** jack may not work.

The connection illustrations below are for reference only. The connecting jacks available on the projector vary with each projector model. Some cables may not be included with the projector. They are commercially available from electronics stores.

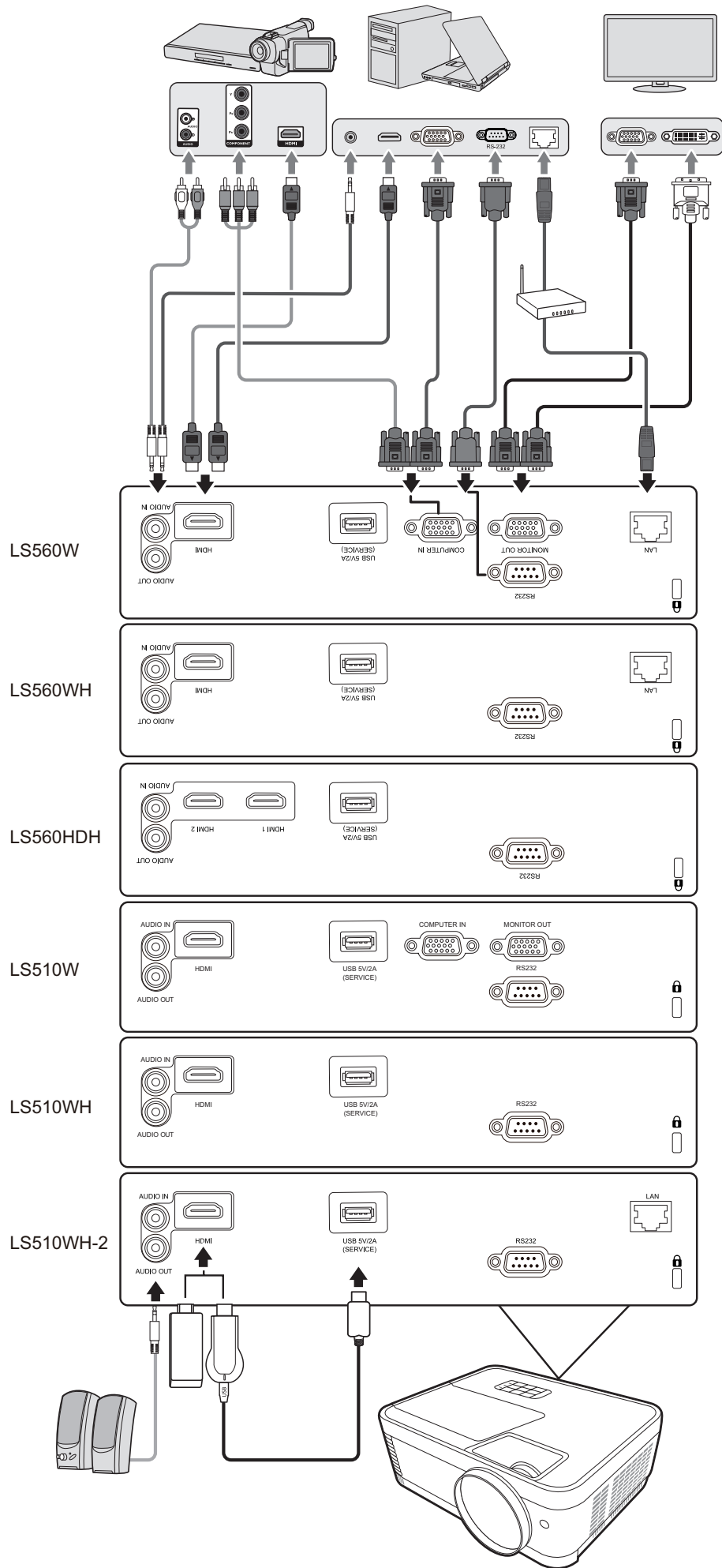

Operation

Turning the Projector On/Off

Starting Up the Projector

1. Press the **Power** button to turn on the projector.
2. The light source will light up, and a “**Power On/Off Ring Tone**” will play.
3. The Power Indicator Light stays green when the projector is On.

NOTE:

- If the projector is still hot from previous use, it will run the cooling fan for 90 seconds before activating the light source.
 - To maintain light source life, once you turn the projector On, wait at least five (5) minutes before turning it off.
4. Turn on all of the connected equipment, i.e. notebook, and the projector will start to search for an input source.

NOTE: If the projector detects an input source, the Source Selection Bar will appear. If an input source is not detected, the message, ‘No Signal’ will appear.

First Time Activation

If the projector is activated for the first time, select your OSD language following the on-screen instructions.



Shutting Down the Projector

1. Press the **Power** or **Off** button and a confirmation message will appear to prompt you to press the **Power** or **Off** button a second time. Additionally you can press any other button to cancel.

NOTE: If you do not respond in a few seconds after the first press, the message will disappear.

2. Once the cooling process finishes, a **“Power On/Off Ring Tone”** will play.
3. Disconnect the power cord from the power outlet if the projector will not be used for an extended period of time.

NOTE:

- To protect the light source, the projector will not respond to commands during the cooling process.
- Do not unplug the power cord before the projector completely shuts down.

Selecting an Input Source

The projector can be connected to multiple devices at the same time. However, it can only display one full screen at a time.

If you want the projector to automatically search for the input source, ensure the **Quick Auto Search** function in the **SYSTEM** menu is **On**. (Only for LS510W/LS560W/LS560HDH)

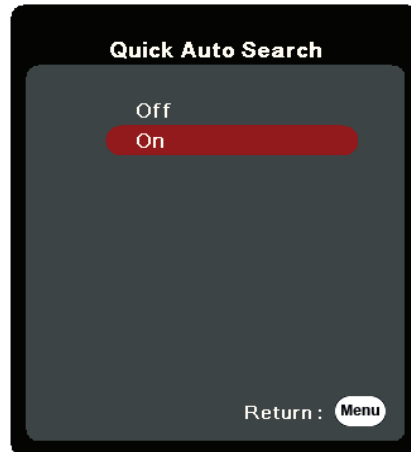

The **Input Source** can also be manually selected by pressing one of the source selection buttons on the remote control, or by cycling through the available input sources.

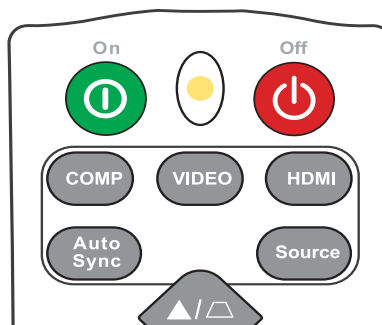

To manually select the input source do the following:

1. Press **Source**, and a source selection menu will appear.
2. Press **▲/▼** until your desired signal is selected and press **Enter**.
3. Once detected, the selected source information will be displayed on the screen for a few seconds.

NOTE: If there are multiple devices connected to the projector, repeat steps 1-2 to search for another source.

Adjusting the Projected Image

Adjusting the Projector's Height and Projection Angle

The projector is equipped with one (1) adjuster foot. Adjusting the foot will change the projector's height and the vertical projection angle. Carefully adjust the feet to fine tune the projected image's position.

Auto-Adjusting the Image

Sometimes, you may need to improve the picture quality. To do this, press **Auto Sync** on the remote control. Within five (5) seconds, the built-in Intelligent Auto Adjustment function will re-adjust the Frequency and Clock values to provide the best picture quality.

Upon completion, the current source information will appear in the upper left corner for three (3) seconds.

NOTE: This function is only available when the PC D-Sub input source (analog RGB/ COMPUTER IN) is selected.

Fine-Tuning the Image Size and Clarity

To adjust the projected image to the size that you need, rotate the Zoom Ring.

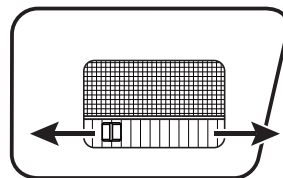
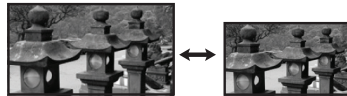

LS510W /
LS510WH /
LS510WH-2

To improve the clarity of the image, rotate the Focus Ring.

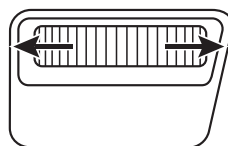
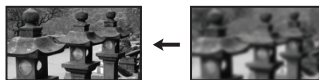

LS560W /
LS560WH /
LS560HDH

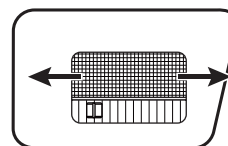





LS510W /
LS510WH /
LS510WH-2

Correcting Keystone

Keystoning refers to the situation where the projected image becomes a trapezoid due to angled projection.

To correct this, besides adjusting the height of the projector, you may also:
Perform automatic keystone correction by enabling the Auto V Keystone function.
(only available for LS560W/LS560WH/LS560HDH)

Or manually correct keystone following the below steps:

1. Use the keystone keys on the projector or remote control to display the keystone page.
2. After the keystone page is displayed, press  to correct keystone at the top of the image. Press  to correct keystone at the bottom of the image. Press  to correct keystone at the bottom of the image. Press  to correct keystone at the right side of the image. Press  to correct keystone at the left side of the image.

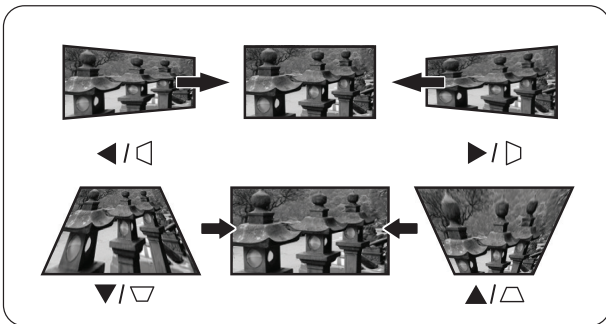

LS560W / LS560WH / LS560HDH

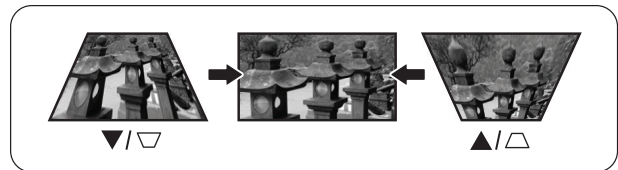

LS510W / LS510WH / LS510WH-2

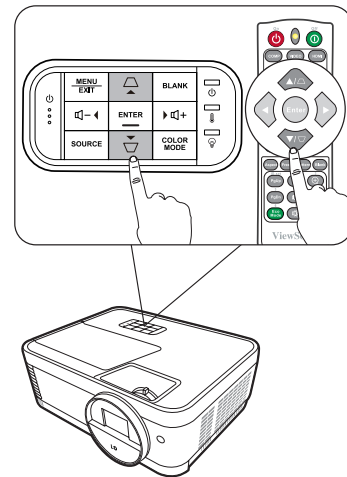
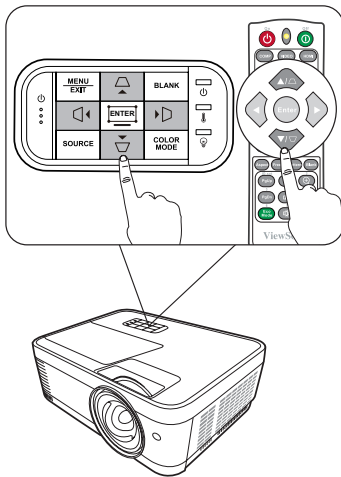





Adjusting 4 corners



NOTE: This function is only available for LS560W/LS560WH/LS560HDH.











You can manually adjust the shape and size of an image that is unevenly rectangular on all sides.

1. To display the Corner Adj. page, you can do one of the followings:

- Press .
- Open the OSD menu and go to the **DISPLAY > Corner Adj.** menu and press **Enter**. The **Corner Adj.** page is displayed.

2. Use /// to select the corner you wish to adjust and press **Enter**.

3. Use / to select an adjustment method that suits your need and press **Enter**.

4. As indicated on the screen (/ for a 45-degree angle adjustment and /// for a 90-degree angle adjustment), press /// to adjust its shape and size. You can press **Menu** or **Exit** to go back to a previous step. A long press for 2 seconds on **Enter** will reset the settings on the corner that you chose.

NOTE:

- Adjusting keystone will reset the **Corner Adj.** settings.
- After the **Corner Adj.** settings have been modified, some aspect ratios or timings are not available. When that happens, reset the settings on all 4 corners.

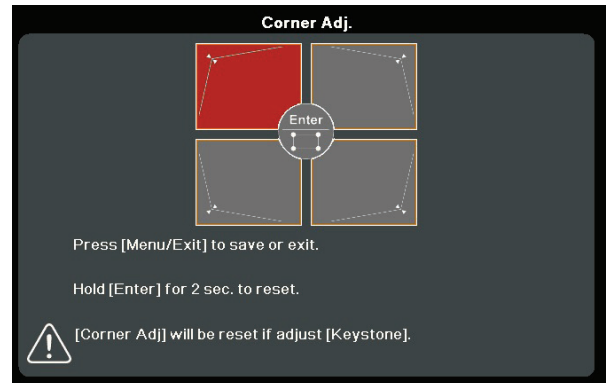

Indicates the corner you selected.

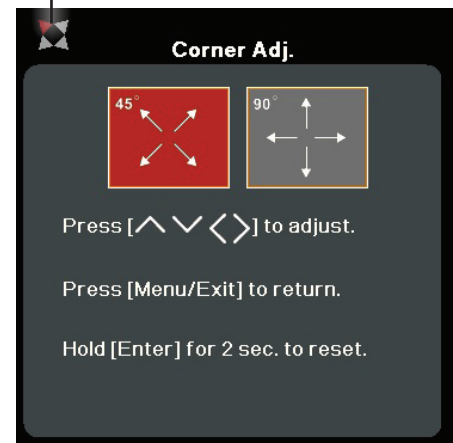

Hiding the Image

In order to draw the audience's full attention to the presenter, you can press **Blank** on the projector or remote control to hide the screen image. Press any key on the projector or remote control to restore the image.

CAUTION: Do not block the projection lens as this could cause the blocking object to become heated and deformed or even cause a fire.

Controlling the Projector through a LAN Environment

NOTE: This function is only available for LS560W/LS560WH/LS510WH-2.

The projector supports Crestron® software. With correct settings for the LAN Control Settings menu, you can manage the projector from a computer using a web browser when the computer and the projector are properly connected to the same local area network.

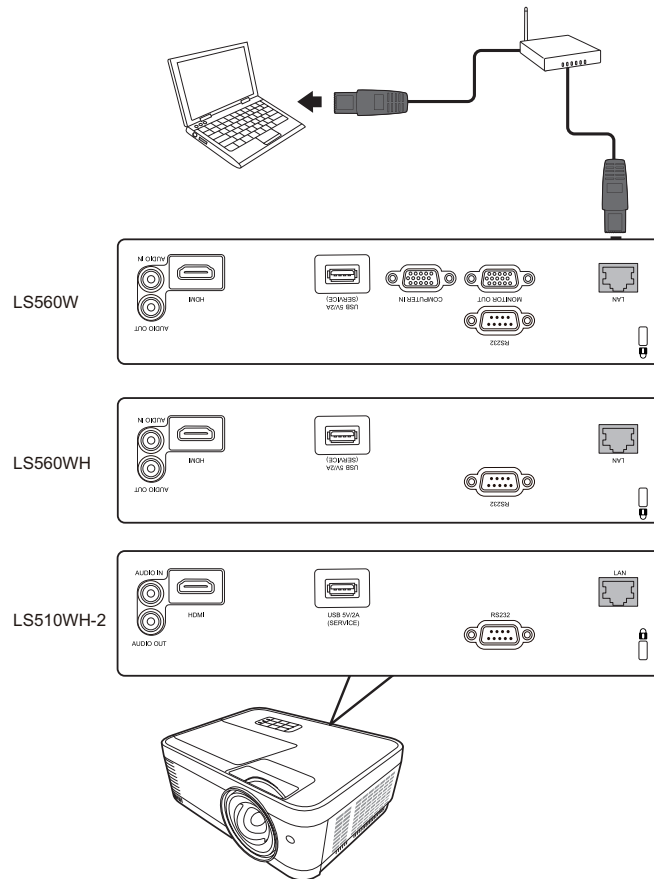

Configuring the LAN Control Settings

- If you are in a DHCP environment:
1. Take a RJ45 cable and connect one end to the RJ45 LAN input jack of the projector and the other end to the RJ45 port.
 2. Open the OSD menu and go to the **ADVANCED > LAN Control Settings** menu. Press **Enter** to display the **LAN Control Settings** page. Or you can press **Network** to open the **LAN Control Settings** menu directly.
 3. Highlight **LAN Settings** and press **◀/▶** to select **DHCP ON**.
 4. Press **▼** to highlight **Apply** and press **Enter**.
 5. Please wait for around 15 - 20 seconds, and then re-enter the **LAN Settings** page. The **Projector IP Address**, **Subnet Mask**, **Default Gateway**, **DNS Server** settings will be displayed. Make note of the IP address displayed in the **Projector IP Address** row.

NOTE:

- If the **Projector IP Address** still does not appear, contact your network administrator.
 - If the RJ45 cables are not properly connected, the **Projector IP Address, Subnet Mask, Default Gateway** and **DNS Server** settings will display 0.0.0.0. Make sure the cables are properly connected and perform the procedures above again.
 - If you need to connect to the projector in its standby mode, set **Standby LAN Control** to **On** in the **ADVANCED > LAN Control Settings** menu.
- If you are in a non-DHCP environment:
 1. Repeat steps 1-2 above.
 2. Highlight **LAN Settings** and press ◀/▶ to select **Static IP**.
 3. Contact your ITS administrator for information on the **Projector IP Address, Subnet Mask, Default Gateway, DNS Server** settings.
 4. Press to select the item you want to modify and press **Enter**.
 5. Press ◀/▶ to move the cursor and the press ▲/▼ to enter the value.
 6. To save the settings, press **Enter**. If you do not want to save the settings, press **Exit**.
 7. Press ▼ to highlight **Apply** and press **Enter**.

NOTE:

- If the RJ45 cables are not properly connected, the **Projector IP Address, Subnet Mask, Default Gateway, DNS Server** settings will display 0.0.0.0. Make sure the cables are properly connected and perform the procedures above again.
- If you wish to connect to the projector in its standby mode, be sure you have selected **Static IP** and obtained the **Projector IP Address, Subnet Mask, Default Gateway** and **DNS Server** information when the projector is on.

Menu Functions

This section will introduce the On-Screen Display (OSD) Menu and its options.

General On-Screen Display (OSD) Menu Operation

NOTE: The OSD screenshots in this manual are for reference only and may differ from the actual design. Some of the following OSD settings may not be available. Please refer to the actual OSD of your projector.

The projector is equipped with an On-Screen Display (OSD) Menu for making various adjustments. It can be accessed by pressing **Menu** on the projector or remote control.

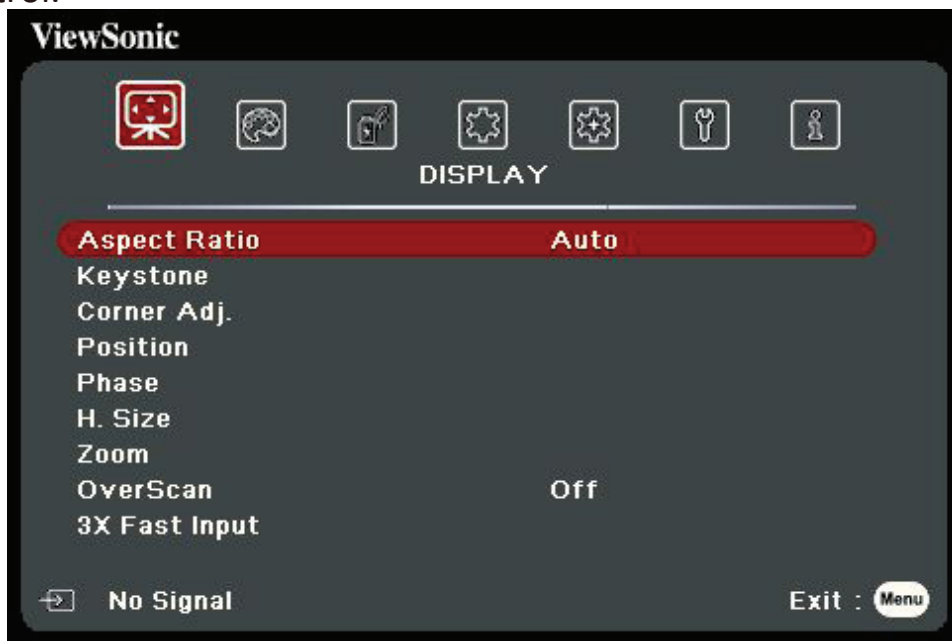





1. Press ◀/▶ to select a main menu. Then press **Enter** or use ▲/▼ to access the sub-menu list.
2. Press ▲/▼ to select the menu option. Then press **Enter** to display its sub-menu, or press ◀/▶ to adjust/select the setting.

NOTE: Some sub-menu options may have another sub-menu. To enter the respective sub-menu, press **Enter**. Use ▲/▼ or ◀/▶ to adjust/select the setting.

On-Screen Display (OSD) Menu Tree

Main Menu	Sub-menu	Menu Option	
DISPLAY	Aspect Ratio	Auto	
		4:3	
		16:9	
		16:10	
		Native	
	Keystone	Auto V Keystone <input checked="" type="checkbox"/>	Off/On
		Vertical	+40~-40
		Horizontal <input checked="" type="checkbox"/>	+40~-40
	Corner Adj. <input checked="" type="checkbox"/>	Top-Right	
		Top-Left	
		Bottom-Right	
		Bottom-Left	
	Position <input checked="" type="checkbox"/>	X: -5 ~ 5, Y: - 5 ~ 5	
	Phase <input checked="" type="checkbox"/>	0~31	
	H. Size <input checked="" type="checkbox"/>	-15~15	
	Zoom	0.8X ~2.0X	
	OverScan	Off/1/2/3/4/5	
	3X Fast Input	Inactive	
		Active	

Main Menu	Sub-menu	Menu Option	
IMAGE	Color Mode	Brightest	
		Presentation	
		Standard	
		Photo	
		Movie	
		User 1	
		User 2	
	Brightness	0~100	
	Contrast	-50~50	
	Color Temp.	9300K/7500K/6500K	
		Red Gain	0~100
		Green Gain	0~100
		Blue Gain	0~100
		Red Offset	-50~+50
		Green Offset	-50~+50
		Blue Offset	-50~+50
	Advanced	Color	-50~50
		Sharpness	0~31
		Gamma	1.8/2.0/2.2/2.35/ 2.5/Cubic/sRGB
		Noise Reduction 	0~31
		Color Management	Primary Color
			Hue
			Saturation
Gain			
Reset Color Settings	Reset		
	Cancel		

Main Menu	Sub-menu	Menu Option		
POWER MANAGEMENT	Auto Power On	Signal	Disable/VGA  /HDMI /All 	
		CEC	Disable/Enable	
		Direct Power On	Disable/Enable	
	Smart Energy	Auto Power Off	Disable/10 min/20 min/30 min	
		Sleep Timer	Disable/30 min/1 hr/2hr/3 hr/4 hr/ 8 hr/12 hr	
		Power Saving	Disable/Enable	
	Standby Settings	VGA Loop Through 	Off/On	
		Audio Pass Through	Off/On	
	USB A Power	On		
		Off		

Main Menu	Sub-menu	Menu Option		
BASIC	Audio Settings	Mute	Off/On	
		Audio Volume	0~20	
		Power On/Off Ring Tone	Off/On	
	Presentation Timer	Timer Period	1~240 m	
		Timer Display	Always/1 min/2 min/ 3 min/Never	
		Timer Position	Top-Left/Bottom-Left/ Top-Right/Bottom-Right	
		Timer Counting Direction	Count Down/Count Up	
		Sound Reminder	Off/On	
		Start Counting/Off		
		Pattern		
		Test Card		
	Blank Timer	Disable/5 min/10 min/15 min/20 min/25 min/30 min		
	Message	Off		
		On		
	Splash Screen	Black		
		Blue		
		ViewSonic		

Main Menu	Sub-menu	Menu Option	
ADVANCED	3D Settings	3D Format	Auto
			Off
			Frame Sequential
			Frame Packing
			Top-Bottom
			Side-by-Side
		3D Sync Invert	Disable/Invert
	Save 3D Settings	Yes/No	
	HDMI Settings	HDMI Format	Auto/RGB/YUV
		HDMI Range	Auto/Enhanced/Normal
	LAN Control Settings ★	LAN Settings	DHCP ON/Static IP
		Projector IP Address	
		Subnet Mask	
		Default Gateway	
		DNS Server	
		Standby LAN Control	Off/On
		Apply	
	Light Source Settings	Light Source Mode	Normal/Eco/ Dynamic Black 1/ Dynamic Black 2
		Reset Light Source Hours	Reset/Cancel
		Light Source Hours Information	Light Source Usage Time
			Normal
			Eco
			Dynamic Black 1
		Dynamic Black 2	
	Reset Settings	Reset	
		Cancel	

Main Menu	Sub-menu	Menu Option		
SYSTEM	Language	Multi-Language OSD Selection		
	Projector Position	Front Table		
		Rear Table		
		Rear Ceiling		
		Front Ceiling		
	Menu Settings	Menu Display Time	5 sec/10 sec/15 sec/20 sec/25 sec/30 sec	
		Menu Position	Center/Top-Left/Top-Right/Bottom-Left/Bottom-Right	
	High Altitude Mode	Off		
		On		
	Quick Auto Search 🌐	Off		
		On		
	Security Settings	Change Password	Off/On	
		Power On Lock		
	Panel Key Lock	Off		
		On		
	Remote Control Code	1/2/3/4/5/6/7/8		
Control Method	RS-232			
	USB			
Baud Rate	2400/4800/9600/14400/19200/38400/57600/115200			

Main Menu	Sub-menu	Menu Option
INFORMATION	Source	
	Color Mode	
	Resolution	
	Color System	
	IP address ★	
	MAC address ★	
	Firmware Version	
	3X Fast Input	
	S/N	

- NOTE:**
- ✔ The functions are available on LS560W/LS560WH/LS560HDH.
 - ★ The functions are available on LS560W/LS560WH/LS510WH-2.
 - 🔧 The functions are available on LS510W/LS560W.
 - 🔧 The functions are available on LS510W/LS560W/LS560HDH.

DISPLAY Menu

1. Press the **Menu** button to display the On-Screen Display (OSD) Menu.
2. Press ◀/▶ to select the **DISPLAY** menu. Then press **Enter** or use ▲/▼ to access the **DISPLAY** menu.

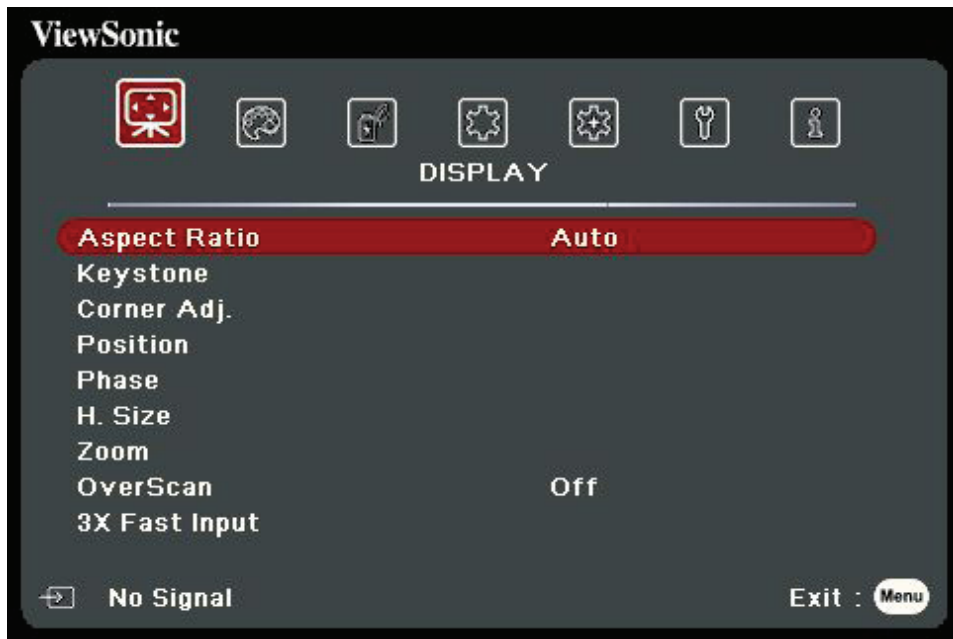

3. Press ▲/▼ to select the menu option. Then press **Enter** to display its sub-menu, or press ◀/▶ to adjust/select the setting.

NOTE: Some sub-menu options may have another sub-menu. To enter the respective sub-menu, press **Enter**. Use ▲/▼ or ◀/▶ to adjust/select the setting.

Menu Option	Description
Aspect Ratio	<p><u>Auto</u> Scales an image proportionally to fit the projector's native resolution in its horizontal width. This is suitable for the incoming image which is neither in 4:3 nor 16:9 and you want to make most use of the screen without altering the image's aspect ratio.</p> <p><u>4:3</u> Scales an image so that it is displayed in the center of the screen with a 4:3 aspect ratio. This is most suitable for 4:3 images like computer monitors, standard definition TV, and 4:3 aspect DVD movies, as it displays them without aspect alteration.</p> <p><u>16:9</u> Scales an image so that it is displayed in the center of the screen with a 16:9 aspect ratio. This is most suitable for images which are already in a 16:9 aspect, like high definition TV, as it displays them without aspect alteration.</p> <p><u>16:10</u> Scales an image so that it is displayed in the center of the screen with a 16:10 aspect ratio. This is most suitable for images which are already in a 16:10 aspect, as it displays them without aspect alteration.</p> <p><u>Native</u> Projects an image as its original resolution and resizes it to fit within the display area. For input signals with lower resolutions, the projected image will be displayed in its original size.</p>
Keystone	Adjusts the keystone situation where the projected image becomes a trapezoid due to angled projection.
Corner Adj.	Adjusts the shape and size of an image that is unevenly rectangular on all sides.
Position	<p>Adjust the position of the projected image.</p> <p>NOTE:</p> <ul style="list-style-type: none"> • This function is only available when a PC input signal is selected. • The adjustment range may vary under different timings.
Phase	<p>Adjusts the clock phase to reduce image distortion.</p> <p>NOTE: This function is only available when a PC input signal is selected.</p>

Menu Option	Description
H. Size	Adjusts the horizontal width of the image. NOTE: This function is only available when a PC input signal is selected.
Zoom	Magnifies the projected image and allows you to navigate the image.
OverScan	Adjusts the overscan rate from 0 to 5. NOTE: This function is only available when a Composite Video or HDMI input signal is selected.
3X Fast Input	This function is favorable to frame rate reducing. Quick response time in native timing can be achieved. When enabled, the following settings will return to factory preset values: Keystone, Corner Adj. (LS560W/LS560WH/LS560HDH only), Aspect Ratio, OverScan, Zoom, Position (LS510W/LS560W only). NOTE: This function is only available when a native timing input signal is selected.





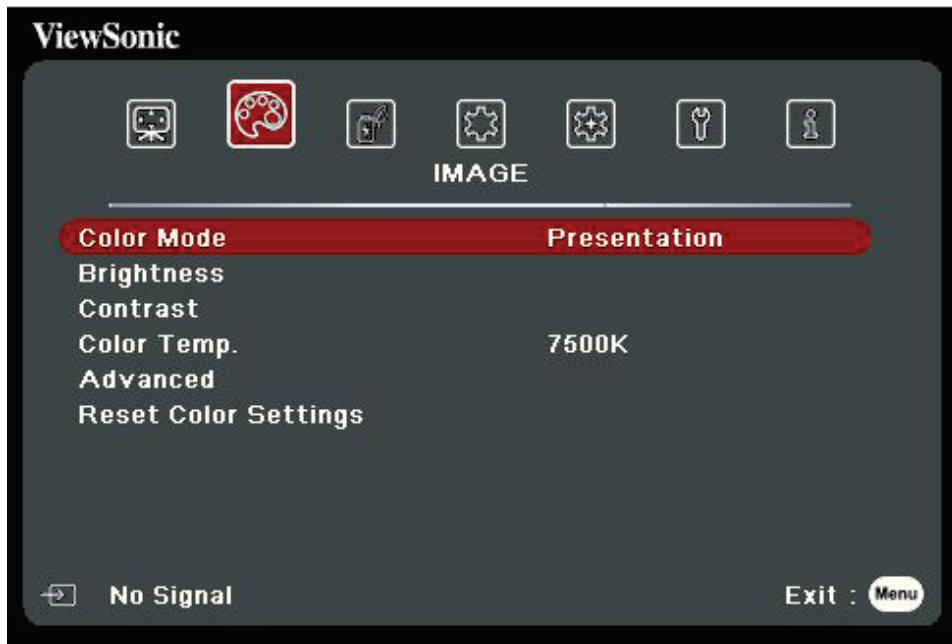

IMAGE Menu

1. Press the **Menu** button to display the On-Screen Display (OSD) Menu.
2. Press ◀/▶ to select the **IMAGE** menu. Then press **Enter** or use ▲/▼ to access the **IMAGE** menu.



3. Press ▲/▼ to select the menu option. Then press **Enter** to display its sub-menu, or press ◀/▶ to adjust/select the setting.

NOTE: Some sub-menu options may have another sub-menu. To enter the respective sub-menu, press **Enter**. Use ▲/▼ or ◀/▶ to adjust/select the setting.

Menu Option	Description
Color Mode	<p><u>Brightest</u> Maximizes the brightness of the projected image. This mode is suitable for environments where extra-high brightness is required, such as using the projector in well lit rooms.</p> <p><u>Presentation</u> Designed for presentations under daylight environment to match PC and notebook coloring.</p> <p><u>Standard</u> Designed for normal circumstances in a daylight environment.</p> <p><u>Photo</u> Designed for photo viewing.</p> <p><u>Movie</u> For playing colorful movies, video clips from digital cameras or DVs through the PC input for best viewing in a blackened (little light) environment.</p> <p><u>User 1/User 2</u> Recalls the customized settings. After User 1/User 2 is selected, some of the sub-menus under the IMAGE menu can be adjusted, according to your selected input source.</p>
Brightness	<p>The higher the value, the brighter the image. Adjust this option so the black areas of the image appear just as black and details in the dark area are more visible.</p> <div style="display: flex; justify-content: space-around; align-items: center;">    </div>
Contrast	<p>Use this to set the peak white level after you have previously adjusted the Brightness setting.</p> <div style="display: flex; justify-content: space-around; align-items: center;">    </div>
Color Temp.	<p>There are several preset color temperature settings (<u>9300K</u>, <u>7500K</u>, <u>6500K</u>) available. The available settings may vary according to the personal preferences.</p> <p>To set a custom color temperature, you can further adjust the following items:</p> <p><u>Red Gain/Green Gain/Blue Gain</u> Adjusts the Contrast levels of Red, Green, and Blue.</p> <p><u>Red Offset/Green Offset/Blue Offset</u> Adjusts the Brightness levels of Red, Green, and Blue.</p>

Menu Option	Description
Advanced	<p><u>Color</u> A lower setting produces less saturated colors. If the setting is too high, colors will be overpowering and may appear unrealistic.</p> <p><u>Sharpness</u> A higher value will sharpen the image, while a lower value will soften the image.</p> <p><u>Gamma</u> Gamma refers to the brightness level of the projector's grayscale levels.</p> <p><u>Noise Reduction</u> This function reduces electrical image noise caused by different media players. The higher the setting, the less the noise. (Not available when input signal is HDMI.)</p> <p><u>Color Management</u> Only in permanent installations with controlled lighting levels such as boardrooms, lecture theaters, or home theaters, should color management be considered. Color management provides fine color control adjustment to allow for more accurate color reproduction. Select Primary Color first and adjust its range/values in Hue, Saturation and Gain.</p>
Reset Color Settings	Returns current image settings to the factory preset values.

POWER MANAGEMENT Menu

1. Press the **Menu** button to display the On-Screen Display (OSD) Menu.
2. Press ◀/▶ to select the **POWER MANAGEMENT** menu. Then press **Enter** or use ▲/▼ to access the **POWER MANAGEMENT** menu.

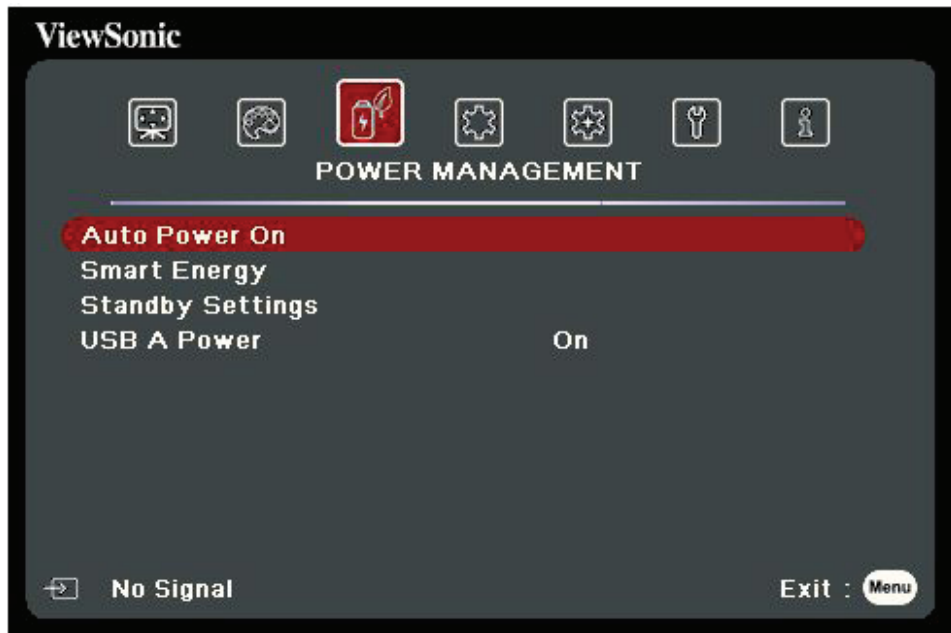

3. Press ▲/▼ to select the menu option. Then press **Enter** to display its sub-menu, or press ◀/▶ to adjust/select the setting.

NOTE: Some sub-menu options may have another sub-menu. To enter the respective sub-menu, press **Enter**. Use ▲/▼ or ◀/▶ to adjust/select the setting.

Menu Option	Description
Auto Power On	<p><u>Signal</u> Selecting VGA/HDMI allows the projector to turn on automatically once the VGA/HDMI signal is fed through the VGA/HDMI cable. You can also select All and the projector will turn on automatically upon receiving either a VGA or HDMI signal.</p> <p><u>CEC</u> This projector supports CEC (Consumer Electronics Control) function for synchronized power on/off operation via HDMI connection. That is, if a device that also supports CEC function is connected to the HDMI input of the projector, when the projector's power is turned off, the power of the connected device will also be turned off automatically. When the power of the connected device is turned on, the projector's power will be turned on automatically.</p> <p>NOTE:</p> <ul style="list-style-type: none"> • In order for the CEC function to work properly, make sure that the device is correctly connected to the HDMI input of the projector via an HDMI cable, and its CEC function is turned on. • Depending on the connected device, the CEC function may not work. <p><u>Direct Power On</u> Allows the projector to turn on automatically once power is fed through the power cord.</p>
Smart Energy	<p><u>Auto Power Off</u> Allows the projector to turn off automatically after a set period of time once no input source is detected to prevent unnecessary waste of light source life.</p> <p><u>Sleep Timer</u> Allows the projector to turn off automatically after a set period of time to prevent unnecessary waste of light source life.</p> <p><u>Power Saving</u> Lowers power consumption if no input source is detected. When Enable is selected, the projector light source mode will change to SuperEco mode after no signal is detected for five (5) minutes. This will also help prevent any unnecessary waste of light source life.</p>

Menu Option	Description
Standby Settings	<p>The functions below are available in standby mode (plugged in, but not turned on).</p> <p><u>VGA Loop Through</u> When selecting On, the projector outputs the signal received only from COMPUTER IN.</p> <p><u>Audio Pass Through</u> When selecting On, the projector outputs an audio signal when the Audio In and Audio Out sockets are correctly connected to a proper device.</p>
USB A Power	When On, the USB Type A port can supply power, and the Control Method will automatically switch to RS-232.

BASIC Menu

1. Press the **Menu** button to display the On-Screen Display (OSD) Menu.
2. Press ◀/▶ to select the **BASIC** menu. Then press **Enter** or use ▲/▼ to access the **BASIC** menu.

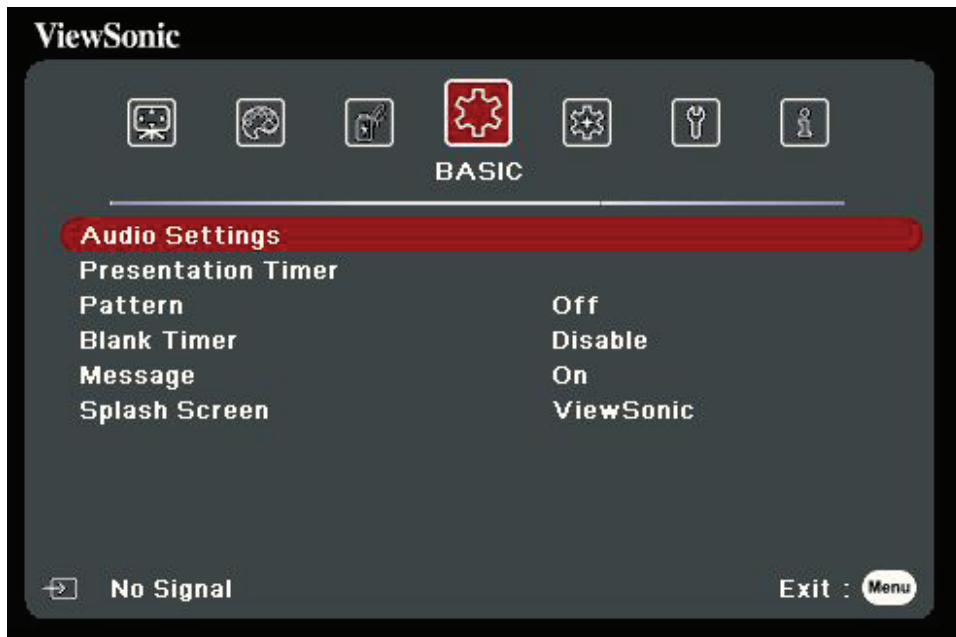

3. Press ▲/▼ to select the menu option. Then press **Enter** to display its sub-menu, or press ◀/▶ to adjust/select the setting.

NOTE: Some sub-menu options may have another sub-menu. To enter the respective sub-menu, press **Enter**. Use ▲/▼ or ◀/▶ to adjust/select the setting.

Menu Option	Description
Audio Settings	<p><u>Mute</u> Select On to temporarily turn off the projector’s internal speaker or the volume being output from the audio output jack.</p> <p><u>Audio Volume</u> Adjusts the volume level of the projector’s internal speaker or the volume being output from the audio output jack.</p> <p><u>Power On/Off Ring Tone</u> Turns on/off the ring tone during the starting up and shutting down process.</p>
Presentation Timer	<p>Presentation timer can indicate the presentation time on the screen to help you achieve better time management when giving presentations.</p> <p><u>Timer Period</u> Sets the time period. If the timer is already on, the timer will restart whenever the Timer Period is reset.</p> <p><u>Timer Display</u> Allows you to decide if you want the timer to show up on the screen for one of the following time periods:</p> <ul style="list-style-type: none"> » Always: Displays the timer on screen throughout the presentation time. » 1 min/2 min/3 min: Displays the timer on screen in the last 1/2/3 minute(s). » Never: Hides the timer throughout the presentation time. <p><u>Timer Position</u> Sets the timer position.</p> <p><u>Timer Counting Direction</u> Sets your desired counting direction between:</p> <ul style="list-style-type: none"> » Count Down: Decreases from the preset time to 0. » Count Up: Increases from 0 to the preset time. <p><u>Sound Reminder</u> Allows you to decide if you want to activate a sound reminder. Once enabled, a double beep sound will be heard at the last 30 seconds of counting down/up, and a triple beep sound will be produced when the timer is up.</p> <p><u>Start Counting/Off</u> Select Start Counting to activate the timer. Select Off to cancel it.</p>
Pattern	Helps adjust the image size and focus, and checks for distortion in the projected image.

Menu Option	Description
Blank Timer	<p>Allows the projector to return the image automatically after a period of time when there is no action taken on the blank screen. To display the blank screen, press Blank on the projector or remote control.</p> <p>NOTE: Do not block the projection lens as this could cause the blocking object to become heated and deformed or even cause a fire.</p>
Message	Sets reminder messages On or Off.
Splash Screen	Selects which logo screen will appear during projector start-up.

ADVANCED Menu

1. Press the **Menu** button to display the On-Screen Display (OSD) Menu.
2. Press ◀/▶ to select the **ADVANCED** menu. Then press **Enter** or use ▲/▼ to access the **ADVANCED** menu.

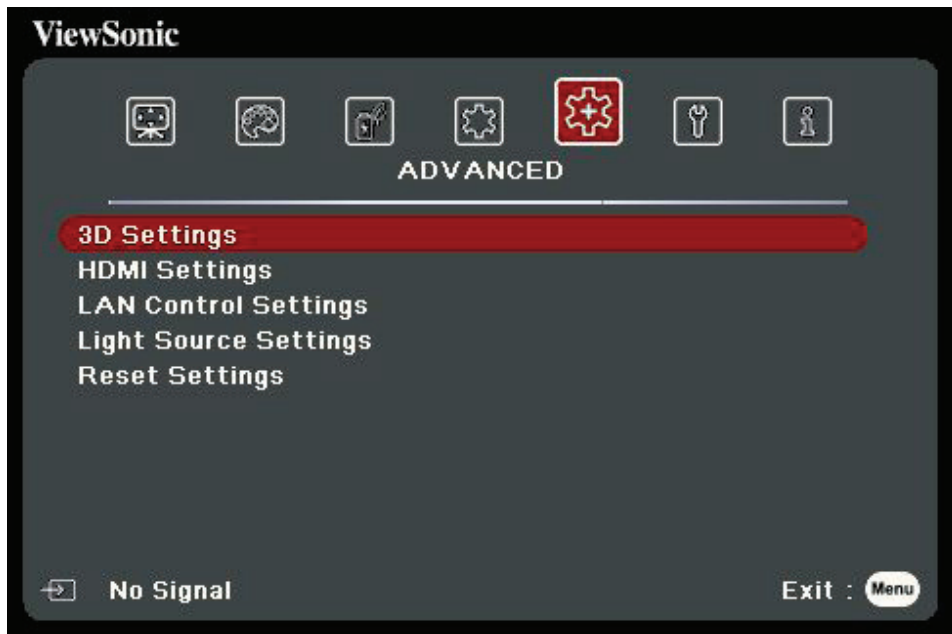

3. Press ▲/▼ to select the menu option. Then press **Enter** to display its sub-menu, or press ◀/▶ to adjust/select the setting.

NOTE: Some sub-menu options may have another sub-menu. To enter the respective sub-menu, press **Enter**. Use ▲/▼ or ◀/▶ to adjust/select the setting.

Menu Option	Description
3D Settings	<p>This projector features a 3D function which enables you to enjoy 3D movies, videos, and sporting events in a more realistic way by presenting the depth of the images. You need to wear a pair of 3D glasses to view 3D images.</p> <p><u>3D Format</u> The default setting is Auto and the projector automatically chooses an appropriate 3D format when detecting 3D contents. If the projector cannot recognize the 3D format, choose a 3D mode.</p> <p><u>3D Sync Invert</u> When you discover the inversion of the image depth, enable this function to correct the problem.</p> <p><u>Save 3D Settings</u> Saves current 3D settings. 3D settings will automatically be applied if the same resolution and input source are selected.</p> <p>NOTE: When the 3D Sync function is on:</p> <ul style="list-style-type: none"> • The brightness level of the projected image will decrease. • The Color Mode, Zoom, and OverScan cannot be adjusted.
HDMI Settings	<p><u>HDMI Format</u> Select a suitable color space according to the color space setting of the output device connected.</p> <ul style="list-style-type: none"> » Auto: Sets the projector to detect the color space setting of the input signal automatically. » RGB: Sets the color space as RGB. » YUV: Sets the color space as YUV. <p><u>HDMI Range</u> Select a suitable HDMI color range according to the color range setting of the output device connected.</p> <ul style="list-style-type: none"> » Auto: Sets the projector to detect the HDMI range of the input signal automatically. » Enhanced: Sets the HDMI color range as 0 - 255. » Normal: Sets the HDMI color range as 16 - 235.

Menu Option	Description					
LAN Control Settings	<p><u>LAN Settings</u></p> <ul style="list-style-type: none"> » DHCP ON: Select this if you are in a DHCP environment and Projector IP Address, Subnet Mask, Default Gateway, DNS Server settings will be automatically retrieved. » Static IP: Select this if you are in a non-DHCP environment and make adjustments to below settings. <table border="1" data-bbox="504 472 1469 685"> <tr> <td data-bbox="504 472 847 521"><u>Projector IP Address</u></td> <td data-bbox="847 472 1469 685" rowspan="4">Only available when <u>LAN Settings</u> is set to Static IP. Use ◀/▶ to select a column and use ▲/▼ to adjust the value.</td> </tr> <tr> <td data-bbox="504 521 847 571"><u>Subnet Mask</u></td> </tr> <tr> <td data-bbox="504 571 847 620"><u>Default Gateway</u></td> </tr> <tr> <td data-bbox="504 620 847 685"><u>DNS Server</u></td> </tr> </table> <p><u>Standby LAN Control</u> Allows the projector to provide the network function in standby mode.</p> <p><u>Apply</u> Enacts the settings.</p>	<u>Projector IP Address</u>	Only available when <u>LAN Settings</u> is set to Static IP. Use ◀/▶ to select a column and use ▲/▼ to adjust the value.	<u>Subnet Mask</u>	<u>Default Gateway</u>	<u>DNS Server</u>
<u>Projector IP Address</u>	Only available when <u>LAN Settings</u> is set to Static IP. Use ◀/▶ to select a column and use ▲/▼ to adjust the value.					
<u>Subnet Mask</u>						
<u>Default Gateway</u>						
<u>DNS Server</u>						
Light Source Settings	<p><u>Light Source Mode</u></p> <ul style="list-style-type: none"> » Normal: Provides full light source brightness. » Eco: Reduces light source power consumption by 20% and lowers brightness to extend the light source life and decreases the fan noise. » Dynamic Black 1: Reduces light source power consumption by up to 70% depending on the content brightness level. » Dynamic Black 2: Reduces light source power consumption by up to 50% depending on the content brightness level. <p><u>Reset Light Source Hours</u> Resets the light source timer after a new light source is installed. For changing the light source, please contact qualified service personnel.</p> <p><u>Light Source Hours Information</u></p> <ul style="list-style-type: none"> » Light Source Usage Time: Displays the number of hours the light source has been used. 					
Reset Settings	Returns all settings to the factory preset values. When using Reset Settings, the following settings will still remain: Zoom, Keystone, Language, Projector Position, USB A Power, High Altitude Mode, Security Settings, Remote Control Code, Control Method, Baud Rate, Corner Adj., LAN Control Settings, Light Source Hours Information.					

SYSTEM Menu

1. Press the **Menu** button to display the On-Screen Display (OSD) Menu.
2. Press ◀/▶ to select the **SYSTEM** menu. Then press **Enter** or use ▲/▼ to access the **SYSTEM** menu.

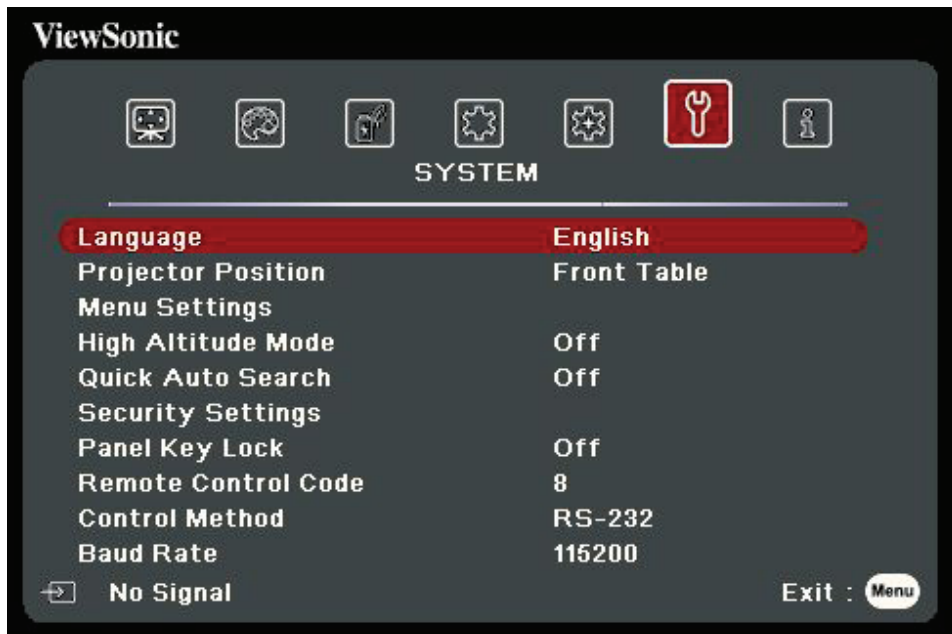

3. Press ▲/▼ to select the menu option. Then press **Enter** to display its sub-menu, or press ◀/▶ to adjust/select the setting.

NOTE: Some sub-menu options may have another sub-menu. To enter the respective sub-menu, press **Enter**. Use ▲/▼ or ◀/▶ to adjust/select the setting.

Menu Option	Description
Language	Sets the language for the On-Screen Display (OSD) Menu.
Projector Position	Selects a proper position for the projector.
Menu Settings	<p><u>Menu Display Time</u> Sets the length of time the OSD Menu will remain active after your last interaction.</p> <p><u>Menu Position</u> Sets the OSD Menu's position.</p>
High Altitude Mode	<p>We recommend you use the High Altitude Mode when your environment is between 1,500 m to 3,000 m above sea level, and ambient temperature is between 0°C–30°C.</p> <p>NOTE:</p> <ul style="list-style-type: none"> • Do not use High Altitude Mode if your environment is between 0 to 1,499 m, and the temperature is between 0°C to 35°C. If used, the projector will become over cooled. • Using “High Altitude Mode” may cause more operating noise, as the fan speed will be increased to improve cooling and performance.
Quick Auto Search	Allows the projector to automatically search for the signals.
Security Settings	See “Using the Password Function” on page 23.
Panel Key Lock	Locks the control keys on the projector.
Remote Control Code	<p>Sets the remote control code for this projector (between 1~8). When multiple adjacent projectors are in operation at the same time, switching the codes can prevent interference from other remote controls. After the remote control code is set, switch to the same ID for the remote control to control this projector. To switch the code for the remote control, press ID set and the number button corresponding to the remote control code together for 5 seconds or more. The initial code is set to 1. When the code is switched to 8, the remote control can control every projector.</p> <p>NOTE: If different codes are set on the projector and remote control, there will be no response from the remote control. When that happens, a message will display to remind you to switch the code for the remote control.</p>
Control Method	Allows you to select a preferred control port: through the RS-232 port or the USB port. When selecting USB, USB A Power will be switched to Off automatically.

Menu Option	Description
Baud Rate	Selects a baud rate that is identical with your computer's so that you can connect the projector using a suitable RS-232 cable and control the projector with RS-232 commands

INFORMATION Menu

1. Press the **Menu** button to display the On-Screen Display (OSD) Menu.
2. Press ◀/▶ to select the **INFORMATION** menu and display its contents.

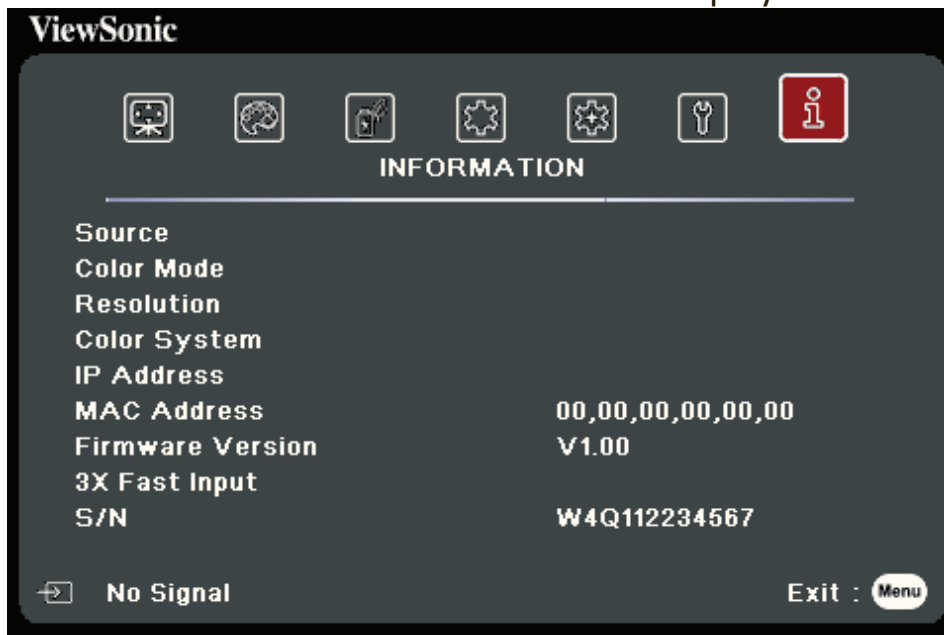

Menu Option	Description
Source	Shows the current input source.
Color Mode	Shows the selected mode in the IMAGE menu.
Resolution	Shows the native resolution of the input source.
Color System	Shows input system format.
IP address	Shows the IP address of your projector.
MAC address	Shows the MAC Address of your projector.
Firmware Version	Shows the current firmware version.
3X Fast Input	Shows whether the function is activated or not.
S/N	Shows the serial number for this projector.

Appendix

Specifications

Item	Category	Specifications		
		LS510W/LS510WH/ LS510WH-2	LS560W/ LS560WH	LS560HDH
Projector	Type	0.65" WXGA, LED		0.65" 1080P, LED
	Display Size	30"~300"	60"~300"	
	Throw Ratio	1.55~1.7 (87" @2.9m)	0.49 (87" @0.915m)	0.46 (95" @0.967m)
	Lens	F = 2.56–2.68, f = 22–24.1 mm	F = 2.6, f = 6.9 mm	
	Optical Zoom	1.1x	Fixed	
	Light Source Type	LED		
	Display System	1-CHIP DMD		
Input signal	VGA (Only for LS510W/LS560W)	f_h : 15K~129KHz, f_v :48~120Hz,		
	HDMI	f_h : 15K~129KHz, f_v :23~120Hz,		
Resolution	Native	1280 x 800	1920 x 1080	
Power adapter	Input Voltage	AC 100-240V, 50/60 Hz (auto switch)		
Operating conditions	Temperature	0°C to 40°C (32°F to 104°F)		
	Humidity	0% to 90% (non-condensing)		
	Altitude	0 to 1,499 m at 0°C to 35°C 1,500 to 3,000 m at 0°C to 30°C		
Storage conditions	Temperature	-20°C to 60°C		
	Humidity	0% to 90%		
	Altitude	0 to 12,200 m at 30°C		
Dimensions	Physical (W x H x D)	293 x 115 x 221 mm (11.5" x 4.5" x 8.7")		
Weight	Physical	2.65 kg (5.84 lb)	2.85 kg (6.28 lb)	
Power consumption	On ¹	240 W (Typical)	229 W (Typical)	245 W (Typical)
	Off	< 0.5W (Standby)		

¹ The test condition follows EEI standards.

Projector Dimensions

293 mm (W) x 115 mm (H) x 221 mm (D)

LS560W / LS560WH / LS560HDH

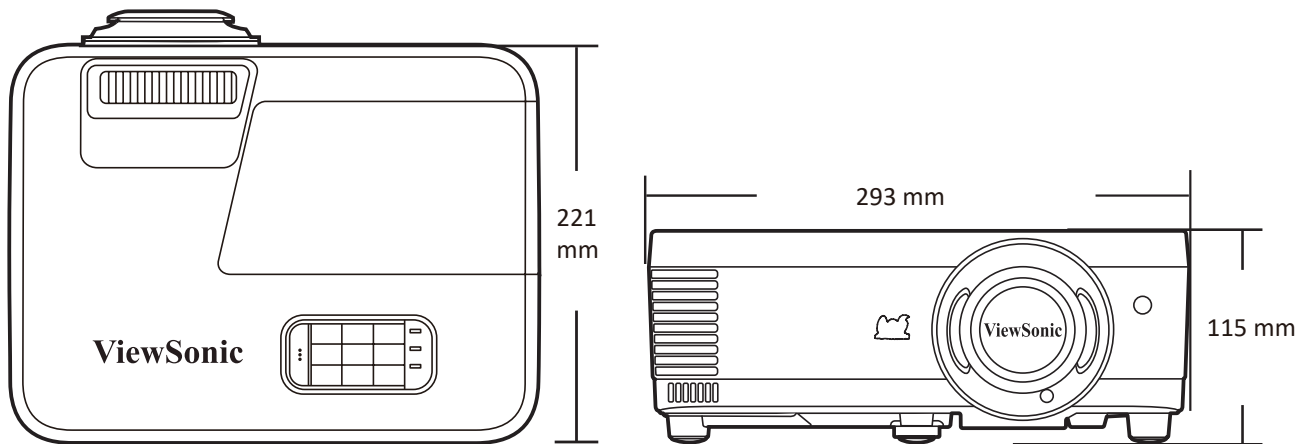

LS510W / LS510WH / LS510WH-2

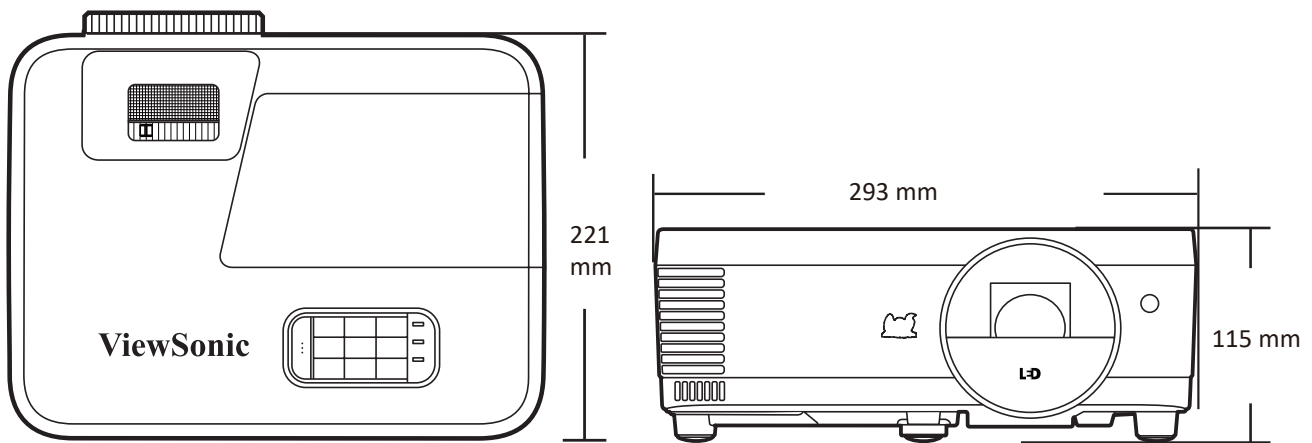

Timing Chart

Analog RGB

Resolution	Mode	Refresh rate (Hz)	H-frequency (kHz)	Clock (MHz)	3D Sync		
					Frame Sequential	Top-Bottom	Side-by-Side
720 x 400	720 x 400_70	70.087	31.469	28.3221			
640 x 480	VGA_60	59.94	31.469	25.175	Supported	Supported	Supported
	VGA_72	72.809	37.861	31.5			
	VGA_75	75	37.5	31.5			
	VGA_85	85.008	43.269	36			
800 x 600	SVGA_60	60.317	37.879	40	Supported	Supported	Supported
	SVGA_72	72.188	48.077	50			
	SVGA_75	75	46.875	49.5			
	SVGA_85	85.061	53.674	56.25			
	SVGA_120 (Reduce Blanking)	119.854	77.425	83	Supported		
1024 x 768	XGA_60	60.004	48.363	65	Supported	Supported	Supported
	XGA_70	70.069	56.476	75			
	XGA_75	75.029	60.023	78.75			
	XGA_85	84.997	68.667	94.5			
	XGA_120 (Reduce Blanking)	119.989	97.551	115.5	Supported		
1152 x 864	1152 x 864_75	75	67.5	108			
1024 x 576	NB Timing	60	35.82	46.966			
1024 x 600	NB Timing	64.995	41.467	51.419			
1280 x 720	1280 x 720_60	60	45	74.25	Supported	Supported	Supported
	1280 x 720_120	120	90	148.5	Supported		
1280 x 768	1280 x 768_60 (Reduce Blanking)	60	47.396	68.25	Supported	Supported	Supported
	1280 x 768_60	59.87	47.776	79.5	Supported	Supported	Supported
1280 x 800	WXGA_60	59.81	49.702	83.5	Supported	Supported	Supported
	WXGA_75	74.934	62.795	106.5			
	WXGA_85	84.88	71.554	122.5			
	WXGA_120 (Reduce Blanking)	119.909	101.563	146.25	Supported		
1280 x 1024	SXGA_60	60.02	63.981	108	Supported	Supported	Supported
	SXGA_75	75.025	79.976	135			
	SXGA_85	85.024	91.146	157.5			
1280 x 960	1280 x 960_60	60	60	108	Supported	Supported	Supported
	1280 x 960_85	85.002	85.938	148.5			

Resolution	Mode	Refresh rate (Hz)	H-frequency (kHz)	Clock (MHz)	3D Sync		
					Frame Sequential	Top-Bottom	Side-by-Side
1360 x 768	1360 x 768_60	60.015	47.712	85.5	Supported	Supported	Supported
1366 x 768	1366 x 768_60	59.790	47.712	85.5	Supported	Supported	Supported
1440 x 900	WXGA+_60 (Reduce Blanking)	60	55.496	88.75	Supported	Supported	Supported
	WXGA+_60	59.887	55.935	106.5	Supported	Supported	Supported
1400 x 1050	SXGA+_60	59.978	65.317	121.75	Supported	Supported	Supported
1600 x 1200	UXGA	60	75	162	Supported	Supported	Supported
1680 x 1050	1680 x 1050_60 (Reduce Blanking)	59.883	64.674	119	Supported	Supported	Supported
	1680 x 1050_60	59.954	65.29	146.25	Supported	Supported	Supported
640 x 480@67Hz	MAC13	66.667	35	30.24			
832 x 624@75Hz	MAC16	74.546	49.722	57.28			
1024 x 768@75Hz	MAC19	74.93	60.241	80			
1152 x 870@75Hz	MAC21	75.06	68.68	100			
1920 x 1080 (VESA)	1920 x 1080_60	60	67.5	148.5	Supported	Supported	Supported
1920 x 1200	1920 x 1200_60 (Reduce Blanking)	59.950	74.038	154.000	Supported	Supported	Supported

HDMI (PC)

Resolution	Mode	Refresh rate (Hz)	H-frequency (kHz)	Clock (MHz)	3D Sync		
					Frame Sequential	Top-Bottom	Side-by-Side
640 x 480	VGA_60	59.94	31.469	25.175	Supported	Supported	Supported
	VGA_72	72.809	37.861	31.5			
	VGA_75	75	37.5	31.5			
	VGA_85	85.008	43.269	36			
720 x 400	720 x 400_70	70.087	31.469	28.3221			
800 x 600	SVGA_60	60.317	37.879	40	Supported	Supported	Supported
	SVGA_72	72.188	48.077	50			
	SVGA_75	75	46.875	49.5			
	SVGA_85	85.061	53.674	56.25			
	SVGA_120 (Reduce Blanking)	119.854	77.425	83	Supported		
1024 x 768	XGA_60	60.004	48.363	65	Supported	Supported	Supported
	XGA_70	70.069	56.476	75			
	XGA_75	75.029	60.023	78.75			
	XGA_85	84.997	68.667	94.5			
	XGA_120 (Reduce Blanking)	119.989	97.551	115.5	Supported		
1152 x 864	1152 x 864_75	75	67.5	108			

Resolution	Mode	Refresh rate (Hz)	H-frequency (kHz)	Clock (MHz)	3D Sync		
					Frame Sequential	Top-Bottom	Side-by-Side
1024 x 576	NB Timing	60	35.82	46.966			
1024 x 600	NB Timing	64.995	41.467	51.419			
1280 x 720	1280 x 720_60	60	45	74.25	Supported	Supported	Supported
	1280 x 720_120	120	90	148.5	Supported		
1280 x 768	1280 x 768_60 (Reduce Blanking)	60	47.396	68.25	Supported	Supported	Supported
	1280 x 768_60	59.87	47.776	79.5	Supported	Supported	Supported
1280 x 800	WXGA_60	59.81	49.702	83.5	Supported	Supported	Supported
	WXGA_75	74.934	62.795	106.5			
	WXGA_85	84.88	71.554	122.5			
	WXGA_120 (Reduce Blanking)	119.909	101.563	146.25	Supported		
1280 x 1024	SXGA_60	60.02	63.981	108	Supported	Supported	Supported
	SXGA_75	75.025	79.976	135			
	SXGA_85	85.024	91.146	157.5			
1280 x 960	1280 x 960_60	60	60	108	Supported	Supported	Supported
	1280 x 960_85	85.002	85.938	148.5			
1360 x 768	1360 x 768_60	60.015	47.712	85.5	Supported	Supported	Supported
1366 x 768	1366 x 768_60	59.79	47.712	85.5	Supported	Supported	Supported
1440 x 900	WXGA+_60 (Reduce Blanking)	60	55.496	88.75	Supported	Supported	Supported
	WXGA+_60	59.887	55.935	106.5	Supported	Supported	Supported
1400 x 1050	SXGA+_60	59.978	65.317	121.75	Supported	Supported	Supported
1600 x 1200	UXGA	60	75	162	Supported	Supported	Supported
1680 x 1050	1680 x 1050_60 (Reduce Blanking)	59.883	64.674	119	Supported	Supported	Supported
	1680 x 1050_60	59.954	65.29	146.25	Supported	Supported	Supported
1920 x 1200	1920 x 1200_60 (Reduce Blanking)	59.95	74.038	154	Supported	Supported	Supported
640 x 480@67Hz	MAC13	66.667	35	30.24			
832 x 624@75Hz	MAC16	74.546	49.722	57.28			
1024 x 768@75Hz	MAC19	74.93	60.241	80			
1152 x 870@75Hz	MAC21	75.06	68.68	100			
1920 x 1080 (VESA)	1920 x 1080_60	60	67.5	148.5	Supported	Supported	Supported

HDMI (Video)

Video mode	Resolution	Horizontal frequency (KHz)	Vertical frequency (Hz)	Dot Clock frequency (MHz)	3D Sync			
					Frame Sequential	Frame Packing	Top-Bottom	Side-by-Side
480i	720(1440) x 480	15.73	59.94	27	Supported			
480p	720 x 480	31.47	59.94	27	Supported		Supported	Supported
576i	720(1440) x 576	15.63	50	27	Supported			
576p	720 x 576	31.25	50	27	Supported		Supported	Supported
720/50p	1280 x 720	37.5	50	74.25	Supported		Supported	Supported
720/60p	1280 x 720	45	60	74.25	Supported		Supported	Supported
1080/50i	1920 x 1080	28.13	50	74.25	Supported			Supported
1080/60i	1920 x 1080	33.75	60	74.25	Supported			Supported
1080/24P	1920 x 1080	27	24	74.25				
1080/50P	1920 x 1080	56.25	50	148.5	Supported		Supported	Supported
1080/60P	1920 x 1080	67.5	60	148.5	Supported		Supported	Supported

Component video

Video mode	Resolution	Horizontal frequency (KHz)	Vertical frequency (Hz)	Clock (MHz)	3D Sync
					Frame Sequential
480i	720 x 480	15.73	59.94	13.5	Supported
480p	720 x 480	31.47	59.94	27	Supported
576i	720 x 576	15.63	50	13.5	Supported
576p	720 x 576	31.25	50	27	Supported
720/50p	1280 x 720	37.5	50	74.25	
720/60p	1280 x 720	45	60	74.25	
1080/50i	1920 x 1080	28.13	50	74.25	
1080/60i	1920 x 1080	33.75	60	74.25	
1080/50P	1920 x 1080	56.25	50	148.5	
1080/60P	1920 x 1080	67.5	60	148.5	



Troubleshooting

Common Problems

This section describes some common problems that you may experience when using the projector.

Problem	Possible Solutions
The projector does not turn on	<ul style="list-style-type: none">• Ensure the power cord is properly attached to the projector and to the power outlet.• If the cooling process has not completed, please wait until it has finished then try to turn on the projector again.• If the above does not work, try another power outlet or another electrical device with the same power outlet.
There is no picture	<ul style="list-style-type: none">• Ensure the video source cable is connected properly, and that the video source is turned on.• If the input source is not selected automatically, select the correct source with the Source key on either the projector or the remote control.
The image is blurred	<ul style="list-style-type: none">• Adjusting the Focus Ring will help correctly focus the projection lens.• Ensure the projector and screen are aligned properly. If necessary, adjust the height of the projector as well as the projection angle and direction.
The remote control does not work	<ul style="list-style-type: none">• Ensure there are no obstacles between the remote control and projector; and that they are within 8 m (26 ft) of each other.• The batteries may be out of power, please check and replace if necessary.
The image abnormal	<ul style="list-style-type: none">• Ensure the video source cable is connected properly, and that the video source is turned on.• If the above does not work, check the air intake or exhaust not block.

LED Indicators

Light			Status and Description
			
Power			
Green Flashing	Off	Off	Stand-by mode
Green	Off	Off	Powering up
Green	Off	Off	Normal operation
Green Flashing	Off	Off	Normal power-down cooling
Red	Off	Off	Downloading
Green	Green	Green	Burn in off
Light source			
Green Flashing	Off	Red	First light source-lit error cooling
Off	Off	Red	Light source error in normal operation
Green	Off	Red	Color wheel start has failed
Heating/Cooling			
Off	Red	Off	Fan 1 error (actual fan speed is outside the desired speed).
Off	Red	Red	Fan 2 error (actual fan speed is outside the desired speed).
Off	Red	Green	Fan 3 error (actual fan speed is outside the desired speed).
Off	Red	Orange	Fan 4 error (actual fan speed is outside the desired speed).
Red Flashing	Red	Off	Fan 5 error (actual fan speed is outside the desired speed).
Red Flashing	Red Flashing	Off	Fan 6 error (actual fan speed is outside the desired speed).
Red	Red	Red	Thermal sensor 1 open error (the remote diode has an open-circuit condition).
Red	Red	Green	Thermal sensor 2 open error (the remote diode has an open-circuit condition).
Green	Red	Red	Thermal sensor 1 short error (the remote diode has an open-circuit condition).
Off	Red	Green	Thermal sensor 2 short error (the remote diode has an open-circuit condition).
Orange	Red	Red	Temperature 1 error (over limited temperature).
Orange	Red	Green	Temperature 2 error (over limited temperature).
Off	Green	Red	Fan IC #1 I2C connection error.

Maintenance

General Precautions

- Make sure the Projector is turned off and the power cable is unplugged from the power outlet.
- Never remove any parts from the Projector. Contact ViewSonic® or a reseller when any part of the Projector needs replacing.
- Never spray or pour any liquid directly onto the case.
- Handle the Projector with care, as a darker-colored projector, if scuffed, may show marks more clearly than a lighter-colored projector.

Cleaning the Lens

- Use a canister of compressed air to remove dust.
- If the lens is still not clean, use lens-cleaning paper or moisten a soft cloth with lens cleaner and gently wipe the surface.

CAUTION: Never rub the lens with abrasive materials.

Cleaning the Case

- Use a soft, lint-free, dry cloth to remove dirt or dust.
- If the case is still not clean, apply a small amount of non-ammonia, non-alcohol based, mild non-abrasive detergent onto a clean, soft, lint-free cloth, then wipe the surface.

CAUTION: Never use wax, alcohol, benzene, thinner, or other chemical detergents.

Storing the Projector

If you intend to store the Projector for an extended period of time:

- Ensure the temperature and humidity of the storage area are within the recommend range.
- Retract the adjuster foot completely.
- Remove the batteries from the Remote Control.
- Pack the Projector in its original packaging or equivalent.

Disclaimer

- ViewSonic® does not recommend the use of any ammonia or alcohol-based cleaners on the lens or case. Some chemical cleaners have been reported to damage the lens and/or case of the projector.
- ViewSonic® will not be liable for damage resulting from use of any ammonia or alcohol-based cleaners.

Light Source Information

This section will provide a better understanding of your projector's light source.

Light Source Hour

When the projector is being used, the duration (in hours) of light source usage is automatically calculated by the built-in timer.

To obtain the light source hour information:

1. Press **Menu** to open the OSD Menu and go to: **Advanced > Light Source Settings > Light Source Hours Information.**
2. Press **Enter** and the **Light Source Hours Information** page will appear.
3. Press **Exit** to leave the menu.

Extending Light Source Life

To prolong light source life, you can adjust the following settings in the OSD Menu.

Setting Light Source Mode

Setting the projector in any mode other than **Normal** reduces system noise, power consumption, and extends the light source's operational life.

Light Source Mode	Description
Normal	Provides full light source brightness.
Eco	Reduces light source power consumption by 20% and lowers brightness, and decreases fan noise.
Dynamic Black 1	Reduces light source power consumption by up to 70% depending on the content's brightness level.
Dynamic Black 2	Reduces light source power consumption by up to 50% depending on the content's brightness level.

To set the Light Source Mode, open the OSD Menu and go to: **Advanced > Light Source Settings > Light Source Mode** and press ◀/▶ to select and press **Enter**.

Setting Auto Power Off

This allows the projector to turn off automatically after a set period of time once no input source is detected.

Open the OSD Menu and go to: **POWER MANAGEMENT > Smart Energy > Auto Power Off** and press ◀/▶ to disable or adjust the time.

Regulatory and Service Information

Compliance Information

This section addresses all connected requirements and statements regarding regulations. Confirmed corresponding applications shall refer to nameplate labels and relevant markings on the unit.

FCC Compliance Statement

This device complies with part 15 of FCC Rules. Operation is subject to the following two conditions: (1) this device may not cause harmful interference, and (2) this device must accept any interference received, including interference that may cause undesired operation. This equipment has been tested and found to comply with the limits for a Class B digital device, pursuant to part 15 of the FCC Rules.

These limits are designed to provide reasonable protection against harmful interference in a residential installation. This equipment generates, uses, and can radiate radio frequency energy, and if not installed and used in accordance with the instructions, may cause harmful interference to radio communications. However, there is no guarantee that interference will not occur in a particular installation. If this equipment does cause harmful interference to radio or television reception, which can be determined by turning the equipment off and on, the user is encouraged to try to correct the interference by one or more of the following measures:

- Reorient or relocate the receiving antenna.
- Increase the separation between the equipment and receiver.
- Connect the equipment into an outlet on a circuit different from that to which the receiver is connected.
- Consult the dealer or an experienced radio/TV technician for help.

WARNING: You are cautioned that changes or modifications not expressly approved by the party responsible for compliance could void your authority to operate the equipment.

Industry Canada Statement

CAN ICES-003(B) / NMB-003(B)

CE Conformity for European Countries



The device complies with the EMC Directive 2014/30/EU and Low Voltage Directive 2014/35/EU and Ecodesign Directive 2009/125/EC.

The following information is only for EU-member states:

The mark shown to the right is in compliance with the Waste Electrical and Electronic Equipment Directive 2012/19/EU (WEEE). The mark indicates the requirement NOT to dispose of the equipment as unsorted municipal waste, but use the return and collection systems according to local law.



Declaration of RoHS2 Compliance

This product has been designed and manufactured in compliance with Directive 2011/65/EU of the European Parliament and the Council on restriction of the use of certain hazardous substances in electrical and electronic equipment (RoHS2 Directive) and is deemed to comply with the maximum concentration values issued by the European Technical Adaptation Committee (TAC) as shown below:

Substance	Proposed Maximum Concentration	Actual Concentration
Cadmium (Cd)	0.01%	< 0.01%
Lead (Pb)	0.1%	< 0.1%
Mercury (Hg)	0.1%	< 0.1%
Hexavalent Chromium (Cr6+)	0.1%	< 0.1%
Polybrominated biphenyls (PBB)	0.1%	< 0.1%
Polybrominated diphenyl esthers (PBDE)	0.1%	< 0.1%
Bis(2-Ethylhexyl) phthalate (DEHP)	0.1%	< 0.1%
Benzyl butyl phthalate (BBP)	0.1%	< 0.1%
Dibutyl phthalate (DBP)	0.1%	< 0.1%
Diisobutyl phthalate (DIBP)	0.1%	< 0.1%

Certain components of products as stated above are exempted under the Annex III of the RoHS2 Directives as noted below:

- Mercury in cold cathode fluorescent lamps and external electrode fluorescent lamps (CCFL and EEFL) for special purposes not exceeding (per lamp):
 - » Short length (500 mm): maximum 3.5 mg per lamp.
 - » Medium length (> 500 mm and 1,500 mm): maximum 5 mg per lamp.
 - » Long length (> 1,500 mm): maximum 13 mg per lamp.
- Lead in glass of cathode ray tubes.
- Lead in glass of fluorescent tubes not exceeding 0.2% by weight.
- Lead as an alloying element in aluminum containing up to 0.4% lead by weight.
- Copper alloy containing up to 4% lead by weight.
- Lead in high melting temperature type solders (i.e. lead-based alloys containing 85% by weight or more lead).
- Electrical and electronic components containing lead in a glass or ceramic other than dielectric ceramic in capacitors, e.g. piezoelectronic devices, or in a glass or ceramic matrix compound.

Indian Restriction of Hazardous Substances

Restriction on Hazardous Substances statement (India). This product complies with the “India E-waste Rule 2011” and prohibits use of lead, mercury, hexavalent chromium, polybrominated biphenyls or polybrominated diphenyl ethers in concentrations exceeding 0.1 weight % and 0.01 weight % for cadmium, except for the exemptions set in Schedule 2 of the Rule.

Product Disposal at End of Product Life

ViewSonic® respects the environment and is committed to working and living green. Thank you for being part of Smarter, Greener Computing. Please visit the ViewSonic® website to learn more.

USA & Canada:

<https://www.viewsonic.com/us/company/green/go-green-with-viewsonic/#recycle-program>

Europe:

<http://www.viewsoniceurope.com/uk/support/recycling-information/>

Copyright Information

Copyright© ViewSonic® Corporation, 2023. All rights reserved.

Microsoft, Windows, and the Windows logo are registered trademarks of Microsoft Corporation in the United States and other countries.

ViewSonic® and the three birds logo are registered trademarks of ViewSonic® Corporation.

VESA is a registered trademark of the Video Electronics Standards Association. DPMS and DDC are trademarks of VESA.

Disclaimer: ViewSonic® Corporation shall not be liable for technical or editorial errors or omissions contained herein; nor for incidental or consequential damages resulting from furnishing this material, or the performance or use of this product.

In the interest of continuing product improvement, ViewSonic® Corporation reserves the right to change product specifications without notice. Information in this document may change without notice.

No part of this document may be copied, reproduced, or transmitted by any means, for any purpose without prior written permission from ViewSonic® Corporation.

Customer Service

For technical support or product service, see the table below or contact your reseller.

NOTE: You will need the product's serial number.

Country/ Region	Website	Country/ Region	Website
Asia Pacific & Africa			
Australia	www.viewsonic.com/au/	Bangladesh	www.viewsonic.com/bd/
中国 (China)	www.viewsonic.com.cn	香港 (繁體中文)	www.viewsonic.com/hk/
Hong Kong (English)	www.viewsonic.com/hk-en/	India	www.viewsonic.com/in/
Indonesia	www.viewsonic.com/id/	Israel	www.viewsonic.com/il/
日本 (Japan)	www.viewsonic.com/jp/	Korea	www.viewsonic.com/kr/
Malaysia	www.viewsonic.com/my/	Middle East	www.viewsonic.com/me/
Myanmar	www.viewsonic.com/mm/	Nepal	www.viewsonic.com/np/
New Zealand	www.viewsonic.com/nz/	Pakistan	www.viewsonic.com/pk/
Philippines	www.viewsonic.com/ph/	Singapore	www.viewsonic.com/sg/
臺灣 (Taiwan)	www.viewsonic.com/tw/	ประเทศไทย	www.viewsonic.com/th/
Việt Nam	www.viewsonic.com/vn/	South Africa & Mauritius	www.viewsonic.com/za/
Americas			
United States	www.viewsonic.com/us	Canada	www.viewsonic.com/us
Latin America	www.viewsonic.com/la		
Europe			
Europe	www.viewsonic.com/eu/	France	www.viewsonic.com/fr/
Deutschland	www.viewsonic.com/de/	Қазақстан	www.viewsonic.com/kz/
Россия	www.viewsonic.com/ru/	España	www.viewsonic.com/es/
Türkiye	www.viewsonic.com/tr/	Україна	www.viewsonic.com/ua/
United Kingdom	www.viewsonic.com/uk/		

Limited Warranty

ViewSonic® Projector

What the warranty covers:

ViewSonic warrants its products to be free from defects in material and workmanship, under normal use, during the warranty period. If a product proves to be defective in material or workmanship during the warranty period, ViewSonic will, at its sole option, repair or replace the product with a like product. Replacement product or parts may include remanufactured or refurbished parts or components.

Limited Three (3) year General Warranty

Subject to the more limited one (1) year warranty set out below, North and South America: Three (3) years warranty for all parts excluding the lamp, three (3) years for labor, and one (1) year for the original lamp from the date of the first consumer purchase.

Other regions or countries: Please check with your local dealer or local ViewSonic office for the warranty information.

Limited One (1) year Heavy Usage Warranty:

Under heavy usage settings, where a projector's use includes more than fourteen (14) hours average daily usage, North and South America: One (1) year warranty for all parts excluding the lamp, one (1) year for labor, and ninety (90) days for the original lamp from the date of the first consumer purchase; Europe: One (1) year warranty for all parts excluding the lamp, one (1) year for labor, and ninety (90) days for the original lamp from the date of the first consumer purchase.

Other regions or countries: Please check with your local dealer or local ViewSonic office for the warranty information.

Lamp warranty subject to terms and conditions, verification and approval. Applies to manufacturer's installed lamp only. All accessory lamps purchased separately are warranted for 90 days.

Who the warranty protects:

This warranty is valid only for the first consumer purchaser.

What the warranty does not cover:

1. Any product on which the serial number has been defaced, modified or removed.
2. Damage, deterioration, failure, or malfunction resulting from:
 - a. Accident, abuse, misuse, neglect, fire, water, lightning, or other acts of nature, improper maintenance, unauthorized product modification, or failure to follow instructions supplied with the product.
 - b. Operation outside of product specifications.
 - c. Operation of the product for other than the normal intended use or not under normal conditions.
 - d. Repair or attempted repair by anyone not authorized by ViewSonic.
 - e. Any damage of the product due to shipment.
 - f. Removal or installation of the product.
 - g. Causes external to the product, such as electric power fluctuations or failure.
 - h. Use of supplies or parts not meeting ViewSonic's specifications.
 - i. Normal wear and tear.
 - j. Any other cause which does not relate to a product defect.
3. Removal, installation, and set-up service charges.

How to get service:

1. For information about receiving service under warranty, contact ViewSonic Customer Support (please refer to "Customer Support" page). You will need to provide your product's serial number.
2. To obtain warranted service, you will be required to provide (a) the original dated sales slip, (b) your name, (c) your address, (d) a description of the problem, and (e) the serial number of the product.
3. Take or ship the product freight prepaid in the original container to an authorized ViewSonic service center or ViewSonic.
4. For additional information or the name of the nearest ViewSonic service center, contact ViewSonic.

Limitation of implied warranties:

There are no warranties, express or implied, which extend beyond the description contained herein including the implied warranty of merchantability and fitness for a particular purpose.

Exclusion of damages:

ViewSonic's liability is limited to the cost of repair or replacement of the product.

ViewSonic shall not be liable for:

1. Damage to other property caused by any defects in the product, damages based upon inconvenience, loss of use of the product, loss of time, loss of profits, loss of business opportunity, loss of goodwill, interference with business relationships, or other commercial loss, even if advised of the possibility of such damages.
2. Any other damages, whether incidental, consequential or otherwise.
3. Any claim against the customer by any other party.

Effect of local law:

This warranty gives you specific legal rights, and you may also have other rights which vary from local authority. Some local governances do not allow limitations on implied warranties and/or do not allow the exclusion of incidental or consequential damages, so the above limitations and exclusions may not apply to you.

Sales outside the U.S.A. and Canada:

For warranty information and service on ViewSonic products sold outside of the U.S.A. and Canada, contact ViewSonic or your local ViewSonic dealer.

The warranty period for this product in mainland China (Hong Kong, Macao and Taiwan Excluded) is subject to the terms and conditions of the Maintenance Guarantee Card.

For users in Europe and Russia, full details of warranty provided can be found in www.viewsoniceurope.com under Support/Warranty Information.

Mexico Limited Warranty

ViewSonic® Projector

What the warranty covers:

ViewSonic warrants its products to be free from defects in material and workmanship, under normal use, during the warranty period. If a product proves to be defective in material or workmanship during the warranty period, ViewSonic will, at its sole option, repair or replace the product with a like product. Replacement product or parts may include remanufactured or refurbished parts or components & accessories.

How long the warranty is effective:

3 years for all parts excluding the lamp, 3 years for labor, 1 year for the original lamp from the date of the first consumer purchase.

Lamp warranty subject to terms and conditions, verification and approval. Applies to manufacturer's installed lamp only.

All accessory lamps purchased separately are warranted for 90 days.

Who the warranty protects:

This warranty is valid only for the first consumer purchaser.

What the warranty does not cover:

1. Any product on which the serial number has been defaced, modified or removed.
2. Damage, deterioration or malfunction resulting from:
 - a. Accident, misuse, neglect, fire, water, lightning, or other acts of nature, unauthorized product modification, unauthorized attempted repair, or failure to follow instructions supplied with the product.
 - b. Any damage of the product due to shipment.
 - c. Causes external to the product, such as electrical power fluctuations or failure.
 - d. Use of supplies or parts not meeting ViewSonic's specifications.
 - e. Normal wear and tear.
 - f. Any other cause which does not relate to a product defect.
3. Any product exhibiting a condition commonly known as "image burn-in" which results when a static image is displayed on the product for an extended period of time.
4. Removal, installation, insurance, and set-up service charges.

How to get service:

For information about receiving service under warranty, contact ViewSonic Customer Support (Please refer to the attached Customer Support page). You will need to provide your product’s serial number, so please record the product information in the space provided below on your purchase for your future use. Please retain your receipt of proof of purchase to support your warranty claim.

For Your Records

Product Name: _____ Model Number: _____
Document Number: _____ Serial Number: _____
Purchase Date: _____ Extended Warranty Purchase? _____(Y/N)
If so, what date does warranty expire? _____

1. To obtain warranty service, you will be required to provide (a) the original dated sales slip, (b) your name, (c) your address, (d) a description of the problem, and (e) the serial number of the product.
2. Take or ship the product in the original container packaging to an authorized ViewSonic service center.
3. Round trip transportation costs for in-warranty products will be paid by ViewSonic.

Limitation of implied warranties:

There are no warranties, express or implied, which extend beyond the description contained herein including the implied warranty of merchantability and fitness for a particular purpose.

Exclusion of damages:

ViewSonic’s liability is limited to the cost of repair or replacement of the product. ViewSonic shall not be liable for:

1. Damage to other property caused by any defects in the product, damages based upon inconvenience, loss of use of the product, loss of time, loss of profits, loss of business opportunity, loss of goodwill, interference with business relationships, or other commercial loss, even if advised of the possibility of such damages.
2. Any other damages, whether incidental, consequential or otherwise.
3. Any claim against the customer by any other party.
4. Repair or attempted repair by anyone not authorized by ViewSonic.

Contact Information for Sales & Authorized Service (Centro Autorizado de Servicio) within Mexico:

Name, address, of manufacturer and importers:

México, Av. de la Palma #8 Piso 2 Despacho 203, Corporativo Interpalmas,
Col. San Fernando Huixquilucan, Estado de México
Tel: (55) 3605-1099 <http://www.viewsonic.com/la/soporte/index.htm>

NÚMERO GRATIS DE ASISTENCIA TÉCNICA PARA TODO MÉXICO: 001.866.823.2004

Hermosillo:

Distribuciones y Servicios Computacionales SA de CV.
Calle Juarez 284 local 2
Col. Bugambilias C.P: 83140
Tel: 01-66-22-14-9005
E-Mail: disc2@hmo.megared.net.mx

Villahermosa:

Compumantenimientos Garantizados, S.A. de C.V.
AV. GREGORIO MENDEZ #1504
COL, FLORIDA C.P. 86040
Tel: 01 (993) 3 52 00 47 / 3522074 / 3 52 20 09
E-Mail: compumantenimientos@prodigy.net.mx

Puebla, Pue. (Matriz):

RENTA Y DATOS, S.A. DE C.V. Domicilio:
29 SUR 721 COL. LA PAZ
72160 PUEBLA, PUE.
Tel: 01(52).222.891.55.77 CON 10 LINEAS
E-Mail: datos@puebla.megared.net.mx

Veracruz, Ver.:

CONEXION Y DESARROLLO, S.A DE C.V. Av. Americas # 419
ENTRE PINZÓN Y ALVARADO
Fracc. Reforma C.P. 91919
Tel: 01-22-91-00-31-67
E-Mail: gacosta@qplus.com.mx

Chihuahua

Soluciones Globales en Computación
C. Magisterio # 3321 Col. Magisterial
Chihuahua, Chih.
Tel: 4136954
E-Mail: Cefeo@soluglobales.com

Cuernavaca

Compusupport de Cuernavaca SA de CV
Francisco Leyva # 178 Col. Miguel Hidalgo
C.P. 62040, Cuernavaca Morelos
Tel: 01 777 3180579 / 01 777 3124014
E-Mail: aquevedo@compusupportcva.com

Distrito Federal:

QPLUS, S.A. de C.V.
Av. Coyoacán 931
Col. Del Valle 03100, México, D.F.
Tel: 01(52)55-50-00-27-35
E-Mail : gacosta@qplus.com.mx

Guadalajara, Jal.:

SERVICRECE, S.A. de C.V.
Av. Niños Héroes # 2281
Col. Arcos Sur, Sector Juárez
44170, Guadalajara, Jalisco
Tel: 01(52)33-36-15-15-43
E-Mail: mmiranda@servicrece.com

Guerrero Acapulco

GS Computación (Grupo Sesicomp)
Progreso #6-A, Colo Centro
39300 Acapulco, Guerrero
Tel: 744-48-32627

Monterrey:

Global Product Services
Mar Caribe # 1987, Esquina con Golfo Pérsico
Fracc. Bernardo Reyes, CP 64280
Monterrey N.L. México
Tel: 8129-5103
E-Mail: aydeem@gps1.com.mx

MERIDA:

ELECTROSER
Av Reforma No. 403Gx39 y 41
Mérida, Yucatán, México CP97000
Tel: (52) 999-925-1916
E-Mail: rrrb@sureste.com

Oaxaca, Oax.:

CENTRO DE DISTRIBUCION Y
SERVICIO, S.A. de C.V.
Murguía # 708 P.A., Col. Centro, 68000, Oaxaca
Tel: 01(52)95-15-15-22-22
Fax: 01(52)95-15-13-67-00
E-Mail: gpotai2001@hotmail.com

Tijuana:

STD
Av Ferrocarril Sonora #3780 L-C
Col 20 de Noviembre
Tijuana, Mexico

FOR USA SUPPORT:

ViewSonic Corporation
14035 Pipeline Ave. Chino, CA 91710, USA
Tel: 800-688-6688
E-Mail: <http://www.viewsonic.com>

Projector Mexico Warranty Term Template In UG
VSC_TEMP_2006



ViewSonic®