

# ViewSonic®



---

## LS700HD DLP Projector User Guide

---

**IMPORTANT:** Please read this User Guide to obtain important information on installing and using your product in a safe manner, as well as registering your product for future service. Warranty information contained in this User Guide will describe your limited coverage from ViewSonic Corporation, which is also found on our web site at <http://www.viewsonic.com> in English, or in specific languages using the Regional selection box in the upper right corner of our website. "Antes de operar su equipo lea cuidadosamente las instrucciones en este manual"

---

Model No. VS17454

# Compliance Information

## FCC Statement

This device complies with part 15 of FCC Rules. Operation is subject to the following two conditions: (1) this device may not cause harmful interference, and (2) this device must accept any interference received, including interference that may cause undesired operation.

This equipment has been tested and found to comply with the limits for a Class B digital device, pursuant to part 15 of the FCC Rules. These limits are designed to provide reasonable protection against harmful interference in a residential installation. This equipment generates, uses, and can radiate radio frequency energy, and if not installed and used in accordance with the instructions, may cause harmful interference to radio communications. However, there is no guarantee that interference will not occur in a particular installation. If this equipment does cause harmful interference to radio or television reception, which can be determined by turning the equipment off and on, the user is encouraged to try to correct the interference by one or more of the following measures:

- Reorient or relocate the receiving antenna.
- Increase the separation between the equipment and receiver.
- Connect the equipment into an outlet on a circuit different from that to which the receiver is connected.
- Consult the dealer or an experienced radio/TV technician for help.

**Warning:** You are cautioned that changes or modifications not expressly approved by the party responsible for compliance could void your authority to operate the equipment.

## For Canada

CAN ICES-3 (B)/NMB-3(B)

## CE Conformity for European Countries

 The device complies with the EMC Directive 2014/30/EU and Low Voltage Directive 2014/35/EU.

## Following information is only for EU-member states:

The mark is in compliance with the Waste Electrical and Electronic Equipment Directive 2012/19/EU (WEEE).

The mark indicates the requirement NOT to dispose the equipment including any spent or discarded batteries or accumulators as unsorted municipal waste, but use the return and collection systems available.

If the batteries, accumulators and button cells included with this equipment, display the chemical symbol Hg, Cd, or Pb, then it means that the battery has a heavy metal content of more than 0.0005% Mercury or more than, 0.002% Cadmium, or more than 0.004% Lead.



## Important Safety Instructions

1. Read these instructions.
2. Keep these instructions.
3. Heed all warnings.
4. Follow all instructions.
5. Do not use this unit near water.
6. Clean with a soft, dry cloth.
7. Do not block any ventilation openings. Install the unit in accordance with the manufacturer's instructions.
8. Do not install near any heat sources such as radiators, heat registers, stoves, or other devices (including amplifiers) that produce heat.
9. Do not defeat the safety purpose of the polarized or grounding-type plug. A polarized plug has two blades with one wider than the other. A grounding type plug has two blades and a third grounding prong. The wide blade and the third prong are provided for your safety. If the provided plug does not fit into your outlet, consult an electrician for replacement of the obsolete outlet.
10. Protect the power cord from being walked on or pinched particularly at plugs. Convenience receptacles and the point where they exit from the unit. Be sure that the power outlet is located near the unit so that it is easily accessible.
11. Only use attachments/accessories specified by the manufacturer.
12. Use only with the cart, stand, tripod, bracket, or table specified by the manufacturer, or sold with the unit. When a cart is used, use caution when moving the cart/unit combination to avoid injury from tipping over.
13. Unplug this unit when unused for long periods of time.
14. Refer all servicing to qualified service personnel. Servicing is required when the unit has been damaged in any way, such as: if the power-supply cord or plug is damaged, if liquid is spilled onto or objects fall into the unit, if the unit is exposed to rain or moisture, or if the unit does not operate normally or has been dropped.



# Declaration of RoHS2 Compliance

This product has been designed and manufactured in compliance with Directive 2011/65/EU of the European Parliament and the Council on restriction of the use of certain hazardous substances in electrical and electronic equipment (RoHS2 Directive) and is deemed to comply with the maximum concentration values issued by the European Technical Adaptation Committee (TAC) as shown below:

Substance	Proposed Maximum Concentration	Actual Concentration
Lead (Pb)	0.1%	< 0.1%
Mercury (Hg)	0.1%	< 0.1%
Cadmium (Cd)	0.01%	< 0.01%
Hexavalent Chromium (Cr <sup>6+</sup> )	0.1%	< 0.1%
Polybrominated biphenyls (PBB)	0.1%	< 0.1%
Polybrominated diphenyl ethers (PBDE)	0.1%	< 0.1%

Certain components of products as stated above are exempted under the Annex III of the RoHS2 Directives as noted below:

Examples of exempted components are:

1. Mercury in cold cathode fluorescent lamps and external electrode fluorescent lamps (CCFL and EEFL) for special purposes not exceeding (per lamp):
  - (1) Short length ( $\leq 500$  mm): maximum 3.5 mg per lamp.
  - (2) Medium length ( $> 500$  mm and  $\leq 1,500$  mm): maximum 5 mg per lamp.
  - (3) Long length ( $> 1,500$  mm): maximum 13 mg per lamp.
2. Lead in glass of cathode ray tubes.
3. Lead in glass of fluorescent tubes not exceeding 0.2% by weight.
4. Lead as an alloying element in aluminium containing up to 0.4% lead by weight.
5. Copper alloy containing up to 4% lead by weight.
6. Lead in high melting temperature type solders (i.e. lead-based alloys containing 85% by weight or more lead).
7. Electrical and electronic components containing lead in a glass or ceramic other than dielectric ceramic in capacitors, e.g. piezoelectric devices, or in a glass or ceramic matrix compound.

## Copyright Information

Copyright © ViewSonic® Corporation, 2019. All rights reserved.  
Macintosh and Power Macintosh are registered trademarks of Apple Inc.  
Microsoft, Windows, Windows NT, and the Windows logo are registered trademarks of Microsoft Corporation in the United States and other countries.  
ViewSonic, the three birds logo, OnView, ViewMatch, and ViewMeter are registered trademarks of ViewSonic Corporation.  
VESA is a registered trademark of the Video Electronics Standards Association.  
DPMS and DDC are trademarks of VESA.  
PS/2, VGA and XGA are registered trademarks of International Business Machines Corporation.  
Disclaimer: ViewSonic Corporation shall not be liable for technical or editorial errors or omissions contained herein; nor for incidental or consequential damages resulting from furnishing this material, or the performance or use of this product.  
In the interest of continuing product improvement, ViewSonic Corporation reserves the right to change product specifications without notice. Information in this document may change without notice.  
No part of this document may be copied, reproduced, or transmitted by any means, for any purpose without prior written permission from ViewSonic Corporation.

## Product Registration

To fulfill possible future product needs, and to receive additional product information as it becomes available, please visit your region section on ViewSonic's website to register your product online.  
Registering your product will best prepare you for future customer service needs. Please print this user guide and fill the information in the "For Your Records" section. For additional information, please see the "Customer Support" section in this guide.

<b>For Your Records</b>	
<b>Product Name:</b>	LS700HD ViewSonic DLP Projector
<b>Model Number:</b>	VS17454
<b>Document Number:</b>	LS700HD_UG_ENG Rev.1A 04-17-19
<b>Serial Number:</b>	_____
<b>Purchase Date:</b>	_____

### Product disposal at end of product life

The lamp in this product contains mercury which can be dangerous to you and the environment. Please use care and dispose of in accordance with local, state or federal laws.

ViewSonic respects the environment and is committed to working and living green. Thank you for being part of Smarter, Greener Computing. Please visit ViewSonic website to learn more.

USA & Canada: <http://www.viewsonic.com/company/green/recycle-program/>

Europe: <http://www.viewsoniceurope.com/eu/support/call-desk/>

Taiwan: <http://recycle.epa.gov.tw/>

# Table of Contents

---

<b>Key safety instructions ....</b>	<b>1</b>	Perform keystone correction.....	26
<b>Introduction.....</b>	<b>3</b>	Adjust four corners .....	26
Projector features .....	3	Zoom in to see details .....	27
Shipping contents .....	4	Selecting the aspect ratio .....	27
External appearance of the projector .....	5	About the aspect ratio.....	28
Device control and functions .....	6	Optimizing the image.....	29
<b>Projector Positioning .....</b>	<b>12</b>	Fine-tuning of image quality in user modes.....	30
Choosing a location .....	12	Setting the Presentation Timer .....	33
Projection Dimension.....	13	Hiding the image.....	34
<b>Connection.....</b>	<b>14</b>	Locking control keys .....	34
Connect to the computer or monitor .....	15	Light source settings.....	34
Connecting to Video source devices .....	16	Extending light source life.....	35
Connecting to HDMI devices .....	17	Operations at high altitudes.....	36
To connect the projector to a Component Video source device:.....	17	Using the CEC function .....	36
Connecting to composite video source devices.....	17	3D functions.....	37
Audio playback with the projector.....	18	Control the projector through the local area network .....	37
<b>Operation.....</b>	<b>19</b>	Control the projector with the web browser .....	38
Activate the projector.....	19	About Crestron e-Control®.....	41
Using the menus.....	19	Using the projector under standby mode .....	43
Using the password function .....	21	Switch off the projector .....	44
Setting a password .....	21	Menu operations.....	45
If you forget your password .....	21	Description of each menu.....	48
Entering the password recall procedure .....	22	<b>Maintenance .....</b>	<b>52</b>
Change Password .....	22	Care of the projector.....	52
Disabling the password function.....	22	LED Indicator.....	53
Switching input signal .....	23	<b>Troubleshooting .....</b>	<b>54</b>
Changing HDMI input settings.....	24	<b>Specifications .....</b>	<b>55</b>
Adjusting the projected image .....	25	Projector specifications.....	55

Fuse specifications .....	55
Dimensions .....	56
Ceiling mount installation.....	56
Timing chart .....	57

## **Copyright information.... 61**

Copyright .....	61
Disclaimer.....	61

## **Appendix ..... 62**

IR control table .....	62
Address Code.....	63
RS232 command table .....	64

# Key safety instructions

---

Design and testing of your projector have been carried out in compliance with the latest safety standards for information technology (IT) devices. However, it is extremely important for you to follow the instructions provided in this manual and product labels during use to ensure user safety.

## Safety Instructions

- **Please read through this manual before using the projector.** Save it for future reference.
- **Do not look straight at the projector lens during operation.** The intense light beam may damage your eyes.
- **Refer servicing to qualified service personnel.**
- **Always open the lens shutter or remove the lens cap when the projector light source has been switched on.**
- In some areas there may be line voltage instability. This projector is designed to operate safely within a mains voltage between 100 to 240 volts AC, but could fail if power cuts or surges of  $\pm 10$  volts occur. **In areas where the mains voltage may fluctuate or cut out, it is recommended that you connect your projector through a power stabilizer, surge protector or uninterruptible power supply (UPS).**
- Do not block the projection lens with any objects when the projector is under operation as this could cause the objects to become heated and deformed or even cause a fire.
- Do not place the projector on an unstable cart, stand, or cable. The product may fall and sustain serious damage.
- Do not attempt to disassemble this projector. The projector contains high voltage parts that may cause electrocution or death when it comes in contact with the human body. Under no circumstances should you ever undo or remove any other covers. Refer servicing to qualified service personnel.
- Do not place this projector in any of the following environments.
  - Space that is poorly ventilated or confined. Allow at least 50 cm clearance from walls and ensure free flow of air around the projector.
  - Locations where temperatures may become excessively high, such as the inside of a car with all windows rolled up.
  - Locations that are too humid, dusty, or smoky may contaminate optical components, shortening the projector's life span and darkening the image.
  - Locations near fire alarms
  - Locations where temperature exceeds 40°C/104°F.
  - Locations with altitudes greater than 5,000 m (16,500 feet).



- Do not block the ventilation holes. If the ventilation holes are seriously obstructed, overheating inside the projector may result in a fire.
  - Do not place this projector on a blanket, bedding or any other soft surface.
  - Do not cover this projector with a cloth or any other item.
  - Do not place flammable items near the projector.
- Do not step on the projector or place any objects upon it. These acts may damage the projector itself as well as cause accidents or personal injury.
- Do not place liquids near or on the projector. Liquids spilled into the projector may cause damage. If the projector does become wet, please unplug the power cable from the power socket and contact your local repair center for repairs.
- This product can be mounted on a ceiling suspension mount for back projection.



**Use only ceiling suspension mounts that meet the relevant requirements and ensure that the installation is safe.**

- When the projector is under operation, you may sense some heated air and odor from its ventilation grill. It is a normal phenomenon and not a product defect.
- Do not use the safety lever during transport or installation purposes. The safety lever should only be used with the anti-theft cables sold on the market.

## Safety instructions for ceiling mounting of the projector

We hope you to have a pleasant user experience with our projector. This is why we're bringing these safety reminders to your attention to prevent possible damage to person and property.

If you intend to mount your projector on the ceiling, we strongly recommend that you use a suitable projector ceiling mount kit and ensure it is securely and safely installed.

There may be safety risks if you fail to use an appropriate projector ceiling mounting kit. Use of inappropriate connectors or screws of the wrong specifications or length may cause the projector to fall from the ceiling.

You can purchase a projector ceiling mounting kit from the projector dealer. We recommend buying a safety harness in addition to the mounting kit. The harness should be securely connected to the anti-theft locking groove on the projector as well as the base of the ceiling mounting support. This will provide additional protection in case the connectors of the mounting support becoming loose.



**Like handling any bright light sources, do not directly look at the light beam.**

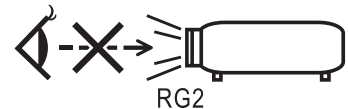

# Introduction

---

## Projector features

The projector integrates high-performance optical engine projection and a user-friendly design to deliver high reliability and ease of use. The projector offers the following features:

- The color mode provides different options designed for different projectors.
- Compatible with NTSC, PAL, SECAM and HDTV
- D-Sub 15-pin terminal can be connected to analog video
- Equipped with HDMI connection, supports HDCP (PA501S with no such features)
- Multi-language On-Screen Display (OSD) menus
- Digital keystone correction to correct distorted images
- RS-232 interface supports serial control
- The power saving mode reduces the lamp power consumption by up to 30% when no input signal is detected for a set length of time.
- Presentation timer for better control of time during presentations
- 3D Ready supported
- Color management can be used to adjust the color according to your preferences
- The screen type correction function can be projected on a variety of pre-set color surfaces
- Switching among Normal, Power Saving and CUSTOM Modes reduces power consumption.
- Quick Auto Search speeding up the signal detecting process
- Activating Power Saving mode will bring power consumption to below 0.5W
- “Network Settings” allows management on the projector state by using a remote computer.
- One-key auto-adjustment to display the best picture quality (applicable to the analog signal only)
- Provides Color Management adjustments for digital / video displays

# Shipping contents

Carefully unpack the product and check that you have all of the items shown below. If any of these items are missing, please contact your place of purchase.

## Standard accessories

 The supplied accessories will be suitable for your region, and may differ from those illustrated.

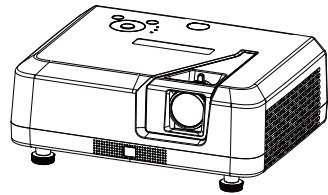

Projector

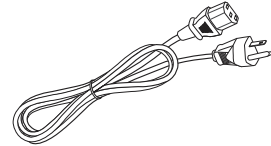

Power cord

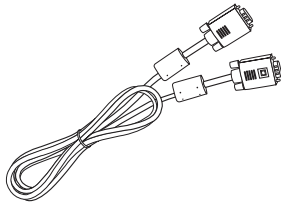

VGA cable



Remote Control and Batteries



Quick Start Guide

# External appearance of the projector

Front/Rear

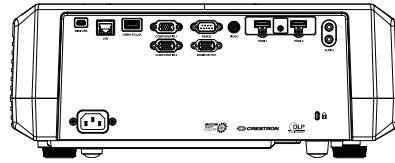
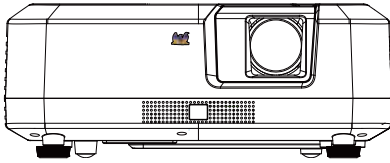

Side

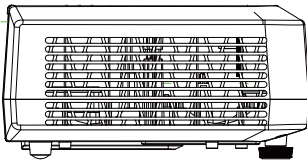

Top/Bottom

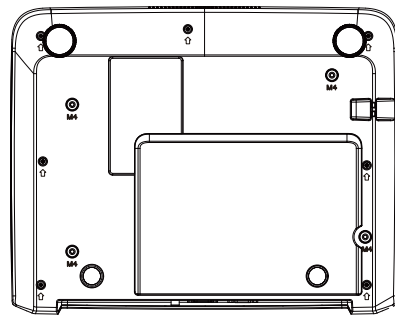
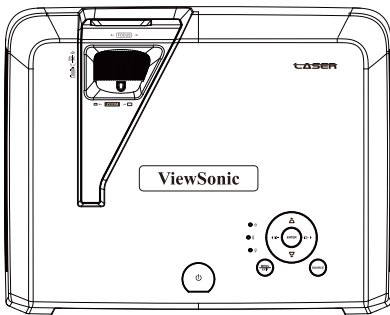

## **Warning**

- This equipment must be grounded.
- You may add power interruption devices in the fixed wiring or plug in the power cable to a nearby socket for convenience. If failures or errors occur during equipment operations, use the power interruption device to cut the power or unplug the power cable from the socket.

# Device control and functions

## Projector

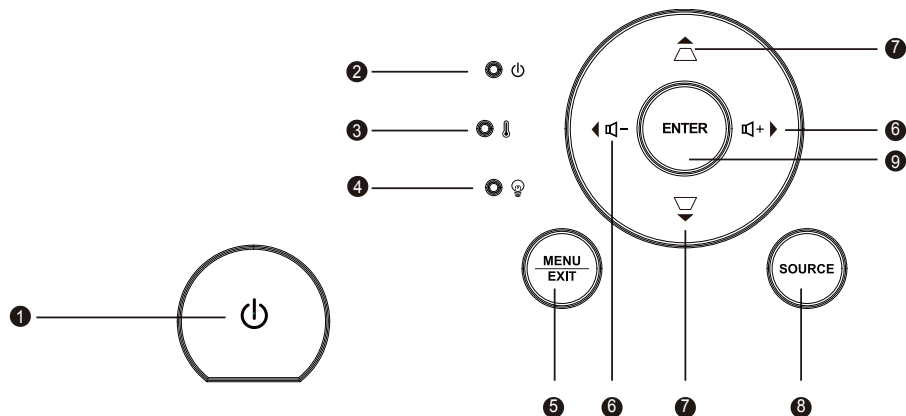

- 1. ⏻**  
Turn the projector power on or off.
- 2. ⏻ (Power LED indicator)**  
Please refer to “LED indicator message”.
- 3. 🔔 (TEMP LED indicator)**  
Please refer to “LED indicator message”.
- 4. 💡 (LAMP LED indicator)**  
Please refer to “LED indicator message”.
- 5. Menu/Exit**  
Menu: Displays or exits the on-screen display menu.  
Exit: Returns to the previous OSD menu, exits and saves the menu settings.
- 6. ◀ 🔊- / 🔊+ ▶**  
◀ Left/▶ Right (direction buttons): Selects the required menu item to make adjustments.  
🔊- 🔊+: Adjusts the projector’s sound level.
- 7. ▲ ▢ / ▼ ▢**  
▲ Up/▼ Down (direction buttons): Selects the required menu item to make adjustments.  
▢/▢ (Keystone button): Manually corrects distorted images resulting from an angled projection.
- 8. Source**  
A source selection bar displays.
- 9. Enter**  
Enter the selected on-screen display (OSD) menu item.

# Remote control

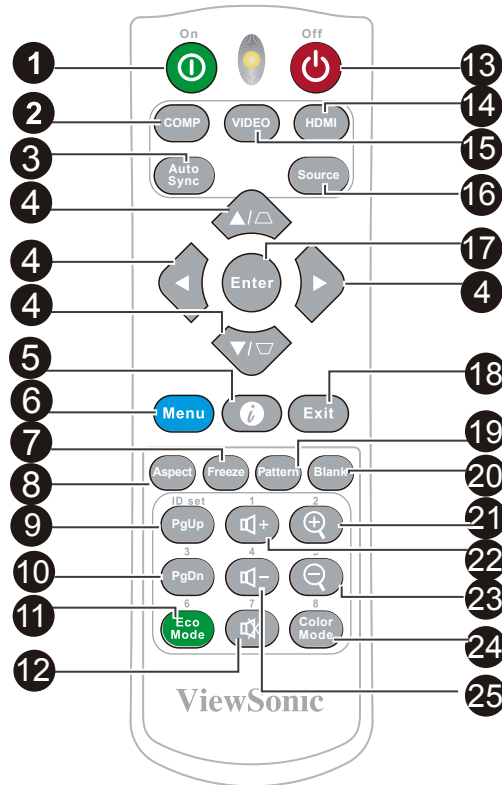

1. **Ⓢ On**  
Turn the projector on.
2. **COMP**  
Select the D-Sub / component display.
3. **Auto Sync**  
Automatically verify the best picture quality for the displayed image.
4. **Keystone button and direction button**  
△ / ▽ / ◀ / ▶  
Manually corrects distorted images resulting from an angled projection.  
**◀Left/▶Right/▲Up/▼Down**  
Selects the required menu item to make adjustments.
5. **i**  
Displays the projector's internal information.
6. **Menu**  
Open the OSD menu.
7. **Freeze**  
Freezes the projected image.
8. **Aspect**  
Selects the display aspect ratio.
9. **10. PgUp/PgDn**  
Connect the projector to a computer with a Mini USB cable to operate the display software (Microsoft PowerPoint) running on a connected computer. When the cursor mode is activated, these buttons will reference the previous and next functions.
11. **Eco Mode**  
Displays the Lamp Mode option list.
12. **🔇 (Mute)**  
Toggles the projector audio between on and off.
13. **Ⓢ Off**  
Turn the projector off.
14. **HDMI**  
Select the source of the displayed HDMI.
15. **VIDEO**  
Select the source of the displayed video.
16. **Source**  
A source selection bar displays.

- 17. Enter**  
Enter the selected screen to display (OSD) menu item.
- 18. Exit**  
Return to the previous OSD menu to exit and save the menu settings.
- 19. Pattern**  
Shows the inbuilt testing screens.
- 20. Blank**  
Hide screen image.
- 21. ⊕ (Zoom out)**  
The displayed zoom lever can be used to zoom out the projected image
- 22. 🔊+ (Volume+)**  
Increase the volume.
- 23. 🔍 (Zoom in)**  
The displayed zoom lever can be used to zoom in on the projected image
- 24. Color Mode**  
Select Color Mode.
- 25. 🔊- (Volume)**  
Decrease the volume.

## Remote control code

The projector is capable of having 8 different remote control codes (1 to 8). When using multiple projectors close to each other at the same time, switching the remote control codes will prevent projector disruption by other remote controls. First, set the projector's remote control code then switch the code of the remote control itself.

If you want to switch the code at the projector end, please go to **System: Remote Control Code** menu and select 1 to 8.

If you want to switch the code at the remote control end, please press and hold both the [ID set] and number key corresponding to the remote control code for at least 5 seconds. 1 is the initial code by default. Setting the code to 8 allows the remote control to control every projector.

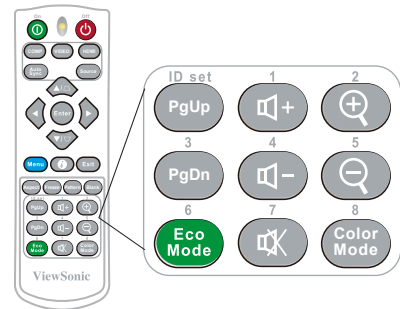

 **The projector will not respond to commands issued by the remote control commands if the projector and remote control codes are not the same. When this happens, a message will appear to remind you to switch the remote control code.**

Remote control setting	1
Remote control code	1



## Using the remote control cursor

Use the remote control to operate your computer during presentations for greater flexibility.

1. Before using the remote control to replace your cursor, fix one end of the USB cable to the projector Mini USB port and the other end to the PC or notebook computer. See “[Connect to the computer](#)” for details.
2. Change the input signal to D-Sub or HDMI via PC source.
3. To use the software displayed on the connected computer (such as Microsoft PowerPoint), go to the previous or next page by pressing the previous page/next page button.

## Remote control effective range

There are infra-red (IR) remote control sensors located at the front and back of the projector. Hold the remote control and maintain a perpendicular angle within 30 degrees with the IR remote control sensor to achieve normal remote control functions. The distance between the remote control and the sensor should not exceed 8 meters (about 26 feet).

Do not place any obstruction in front of the IR sensor on the projector as this may block the IR beam.

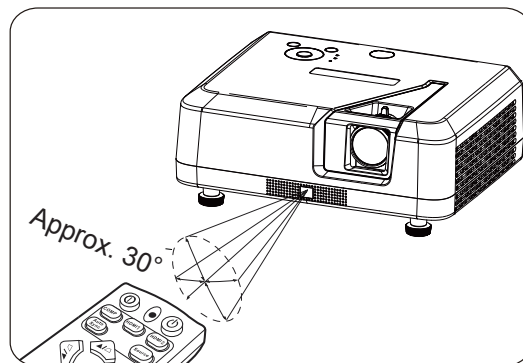

### **Note**

- *When an intense light source such as sunlight or fluorescent light is used to illuminate the remote sensor, the remote control may not work.*
- *Operate the remote control where you can see the remote sensor.*
- *Do not shake or drop the remote control.*
- *Store the remote control in a cool, dry place.*
- *Do not spill water on the remote control or place moist objects on it.*
- *Do not disassemble the remote control.*

## Replacing the remote control battery

1. To open the battery cover, place the remote control with the backside facing upwards. Press down at the indicated area and then pull the battery lid upwards along the indicated direction.
2. Take out the old batteries (if required) and then place 2 AAA batteries according to the indicated orientation. The positive pole of the battery should be directed at the (+) direction while the negative pole should be directed at the direction.
3. Align the battery cover with the bottom of the remote control and return the cover to its original position to complete the process.

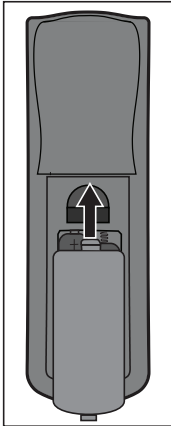

Open the battery cover as shown in the illustration.

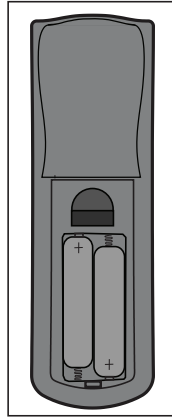

Install the battery as shown in the illustration.

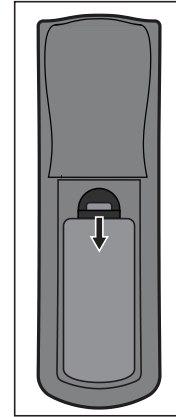

Cover the battery cover.

### **Warning**

- Avoid keeping the remote control and battery in moist or hot places, such as the kitchen, bathroom, sauna, solarium or car.
- Replace only with the same or equivalent type recommended by the battery manufacturer.
- Refer to the manufacturer's instructions and local environmental regulations to dispose of old batteries.
- Do not throw batteries into fires. There may be danger of an explosion.
- If the battery is flat or if you will not be using the remote control for a while, remove the battery to prevent battery leaks from damaging the remote control.

# Projector Positioning

---

## Choosing a location

You may refer to the room layout or personal preference to determine the location of installation. Considerations include size and position of the screen, location of a suitable power outlet, as well as the location and distance between the projector and other equipment.

There are 4 potential installation locations for the projector:

### 1. Front Table

For this location, the projector is placed right in front of the screen. This is the most commonly employed means for placing the projector. It is quick to setup and highly mobile.

After turning on the projector, go to **System: Projector Position** menu and select **Front Table**.

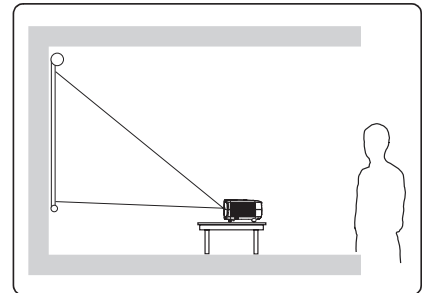

### 2. Front Ceiling

For this location, the projector is suspended upside-down from the ceiling in front of the screen.

Purchase a Projector Ceiling Mounting Kit from your dealer to mount your projector on the ceiling.

After turning on the projector, go to **System: Projector Position** menu and select **Front Ceiling**.

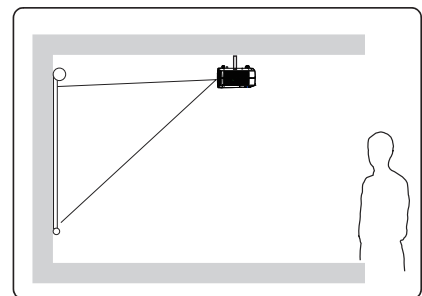

### 3. Rear Ceiling

For this location, the projector is suspended upside-down from the ceiling behind the screen.

Note: A special rear projection screen and Projector Ceiling Mounting Kit are required for this installation location.

After turning on the projector, go to **System: Projector Position** menu and select **Rear Ceiling**.

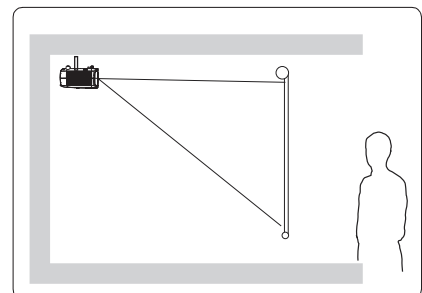

### 4. Rear Table

For this location, the projector is placed right behind the screen.

Note: A special rear projection screen is required.

After turning on the projector, go to **System: Projector Position** menu and select **Rear Table**.

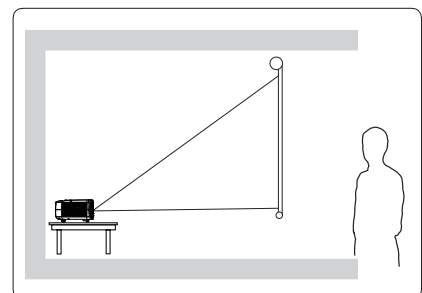

# Projection Dimension

Refer to the chart below to determine the screen size and projection distance.

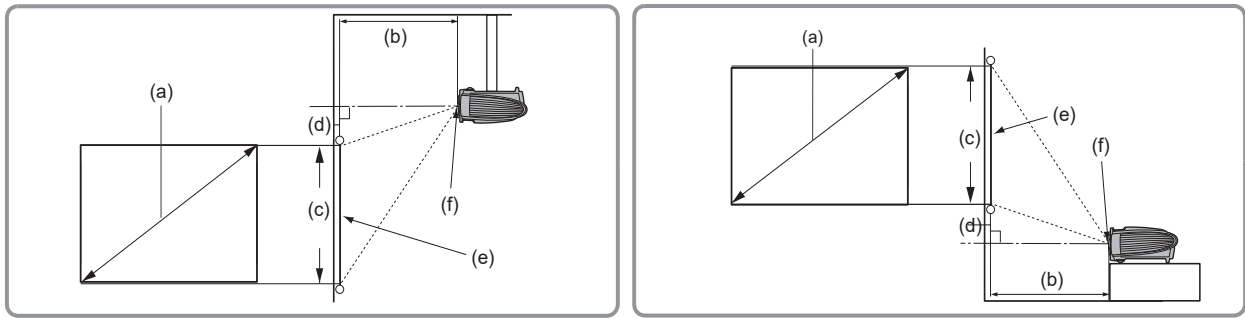

(E): Screen (f): lens center

(a) Screen size		Displays an image in 16:9 size on the 16:9 screen									
		(b) Projection distance				(c) Image height		(d) Vertical offset			
		Minimum distance		Maximum distance				Minimum offset		Maximum offset	
Inch	mm	Inch	mm	Inch	mm	Inch	mm	Inch	mm	Inch	mm
60	1524	58	1483	77	1948	29	747	1.6	41	1.6	41
70	1778	68	1738	90	2281	34	872	1.9	48	1.9	48
80	2032	78	1993	103	2613	39	996	2.2	55	2.2	55
90	2286	88	2248	116	2945	44	1121	2.4	62	2.4	62
100	2540	99	2503	129	3278	49	1245	2.7	69	2.7	69
120	3048	119	3012	155	3942	59	1494	3.3	83	3.3	83
150	3810	149	3777	194	4939	74	1868	4.1	104	4.1	104
200	5080	199	5051	260	6601	98	2491	5.4	138	5.4	138
250	6350	249	6325	325	8262	123	3113	6.8	173	6.8	173
300	7620	299	7599	391	9924	147	3736	8.2	207	8.2	207

(a) Screen size		Displays an image in 4:3 size on the 16:9 screen									
		(b) Projection distance				(c) Image height		(d) Vertical offset			
		Minimum distance		Maximum distance				Minimum offset		Maximum offset	
Inch	mm	Inch	mm	Inch	mm	Inch	mm	Inch	mm	Inch	mm
60	1524	53	1358	70	1785	27	686	1.5	38	1.5	38
70	1778	63	1592	82	2090	31	800	1.7	44	1.7	44
80	2032	72	1826	94	2395	36	914	2.0	51	2.0	51
90	2286	81	2059	106	2699	40	1029	2.2	57	2.2	57
100	2540	90	2293	118	3004	45	1143	2.5	63	2.5	63
120	3048	109	2761	142	3615	54	1372	3.0	76	3.0	76
150	3810	136	3463	178	4530	67	1714	3.7	95	3.7	95
200	5080	182	4632	238	6055	90	2286	5.0	127	5.0	127
250	6350	228	5801	298	7580	113	2858	6.2	159	6.2	159
300	7620	274	6971	358	9105	135	3429	7.5	190	7.5	190

☞ There is 3% tolerance among these numbers due to optical component variations. It is recommended that if you intend to permanently install the projector, you should physically test the projection size and distance using the actual projector before you permanently install it, so as to make allowance for this projector's optical characteristics. This will help you determine the exact mounting position so that it best suits your installation location.

# Connection

When connecting a signal source to the projector, be sure to:

1. Turn all devices off before making any connections.
2. Use the correct signal cables for each source.
3. Ensure the cables are firmly inserted.

 In the connections shown below, some cables may not be included within the projector packaging (please refer to “Shipping contents”). You may purchase the required signal cables from an electronics store.

 The following links and icons are for references only. Connection jacks at the back of the projectors may differ according to the projector model.

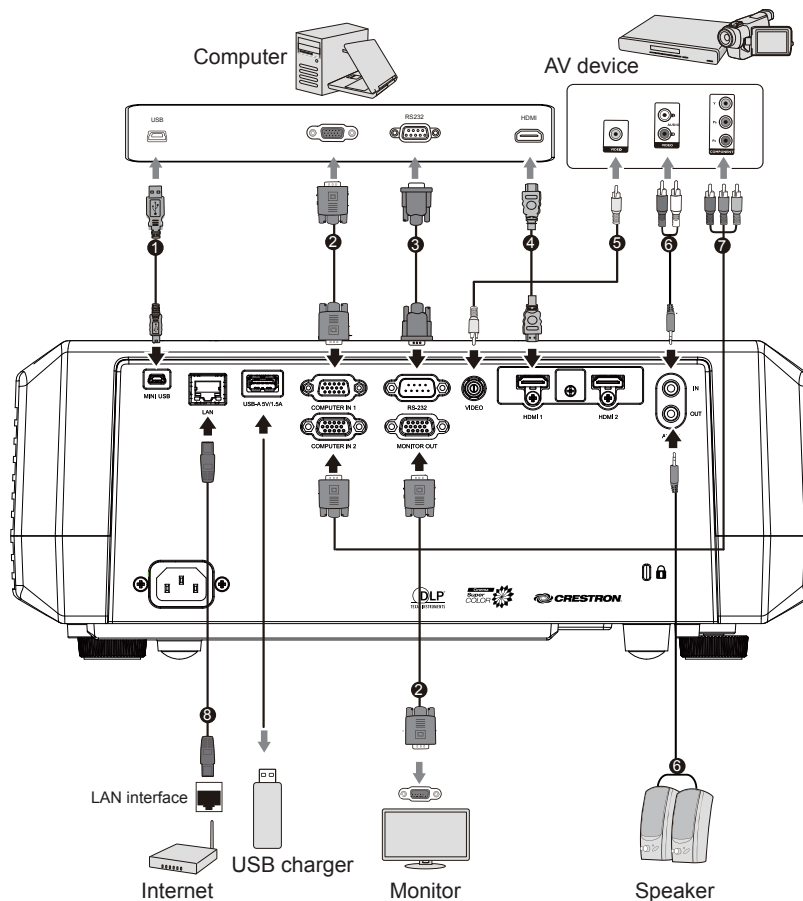

1. USB cable (mini-B to type A)	5. Composite video line
2. VGA cable (D-Sub to D-Sub)	6. Audio Cable
3. RS-232 cable	7. VGA (D-Sub) to HDTV (RCA) line
4. HDMI cable	8. RJ45 cable

# Connect to the computer or monitor

## Connect to the computer

1. Use the VGA cable provided. Plug one end into the D-Sub output jack at the computer end.
2. Connect the other end of the VGA cable to the COMPUTER signal input jack on the projector.

 Many notebooks have not activated their monitor jack after being connected to the monitor. The user can often press FN + F3 or CRT/LCD button to switch ON/OFF the externally connected monitor. Find the function key labeled with the CRT/LCD or monitor icon on the notebook. Press the FN key and the labeled function key. Please refer to the instruction manual provided with the notebook computer for the combination keys and their functions.

## Connect to the monitor

If you want the display to be shown both on the computer monitor as well as the screen, refer to the following instructions. Connect the VGA cable to the COMPUTER OUT signal output jack on the projector as well as the external display.

1. Connect the projector to the computer as described in the “Connect to the computer” section. Use a suitable VGA cable (only 1 such cable is provided) and connect one end of the cable to the D-Sub input jack on the video display.
2. If the display is provided with a DVI input jack, then connect the DVI end of the VGA-DVI-A cable to the DVI input jack on the video display.
3. Connect the other end of the cable to the COMPUTER OUT jack on the projector.

 The MONITOR OUT output is only available when the COMPUTER 1 is connected to the projector in the standby mode. To use this connection mode, open the Power Management > Active VGA Out function in the Standby Settings menu.

## Connecting to Video source devices

You can connect the projector to any of the following video source device with an output jack:

- HDMI (PA501S does not have this interface)
- Component Video
- S-Video
- Video (composite video)

Only one of the aforementioned connection methods is required to connect the projector to the video source device. However, different connection methods would provide a different video quality. The connection method selected would be determined by the presence of matching jacks on the projector and Video source device:

### Best video quality

HDMI is the best video connection method available. If the source device comes with HDMI jacks, you will be able to acquire uncompressed digital video quality.

Please refer to [“Connecting to HDMI devices”](#) for details on how to connect the projector to HDMI devices.

If you don't have any usable HDMI source, the next best video signal would be Component Video (not to be confused with Composite Video). Digital TV tuners and DVD players are provided with Component Video output sockets. If your device includes Component Video, then this would be your primary choice of connection to the (composite) video.

Please refer to [“To connect the projector to a Component Video source device:”](#) for details on how to connect your projector to Component Video devices.

### Least video quality

Composite Video is an analog video and will result in a perfectly acceptable, but less than optimal result from your projector, being the least video quality of the available methods described here.

Please refer to [“Connecting to composite video source devices”](#) for details on how to connect your projector to composite video devices.

## Connecting audio

You can use the speakers of the projector in the presentation or connect other individual speakers to the audio output jack of the projector. Audio output is controlled by the volume and mute setup of the projector.

## Connecting to HDMI devices

Use an HDMI cable to establish a connection between the projector and HDMI device.

1. Connect one end of the HDMI cable to the HDMI output jack on the video device.
2. Connect the other end of the cable to the HDMI signal input jack on the projector.

 In the unlikely event that the projector is connected to a DVD player via the projector's HDMI input and the projected picture displays wrong colors, please change the color space to YUV. See ["Changing HDMI input settings"](#) for details.

## To connect the projector to a Component Video source device:

Examine your Video source device to determine if a set of unused Component Video output sockets are available:

- If so, you can continue with this procedure.
  - If not, you will need to reassess which method to use to connect to the device.
1. Take a VGA (D-Sub) Component adapter cable and connect the end with 3 RCA type connectors to the Component Video output sockets of the Video source device. Match the color of the plugs to the color of the sockets; green to green, blue to blue, and red to red.
  2. Connect the end of the VGA (D-Sub) Component adapter cable (with the D-Sub type connector) to the COMPUTER 1 or COMPUTER 2 jack on the projector.

 If the selected video image is not displayed after the projector is turned on and the correct video source has been selected, check that the Video source device is turned on and operating correctly. You must also check that the signal cables have been connected correctly.

## Connecting to composite video source devices

Examine your Video source device to determine if an unused composite output jack is available:

- If so, you can continue with this procedure.
  - If not, you will need to reassess which method to use to connect to the device.
1. Take a Video cable and connect one end to the composite Video output socket of the Video source device.
  2. Connect the other end of the video cable to the VIDEO socket on the projector.

 If the selected video image is not displayed after the projector is turned on and the correct video source has been selected, check that the Video source device is turned on and operating correctly. You must also check that the signal cables have been connected correctly.

 When the component video is not available, use the composite video connection method to connect to this device. See ["Connecting to Video source devices"](#) for details.



## **Audio playback with the projector**

You can use the speaker of the projector in the presentation or connect other individual speakers to the AUDIO OUT jack of the projector.

# Operation

## Activate the projector

1. Plug the power cord into the projector and into a wall socket. Turn on the switch on the wall socket (if available).
2. Press  Power to switch on the projector.
3. If this is the first time that you've switched on the projector, please refer to on-screen instructions and select your OSD language.
4. Switch on all connected equipment.

The projector will then begin a search of the input signals. The lower right corner of the screen will display the current input signal being scanned. If the projector fails to detect a valid signal, the screen will display a **[NO SIGNAL]** message until an input signal is found.

You can press "Source" to select the input signal required. See ["Switching input signal"](#) for details.

 If the input signal frequency / resolution is outside the operating range of the projector, the blank screen will display the [Out of Range] message. Please change to an input signal which is compatible with the projector's resolution or set the input signal to a lower setting. For more details, please refer to the [Resolution Table].

## Using the menus

This projector has an on-screen display (OSD) menu function that allows you to change different settings.

 The following OSD screenshot is for reference only. Actual OSD design may differ.

The following is an overview of the OSD menu.

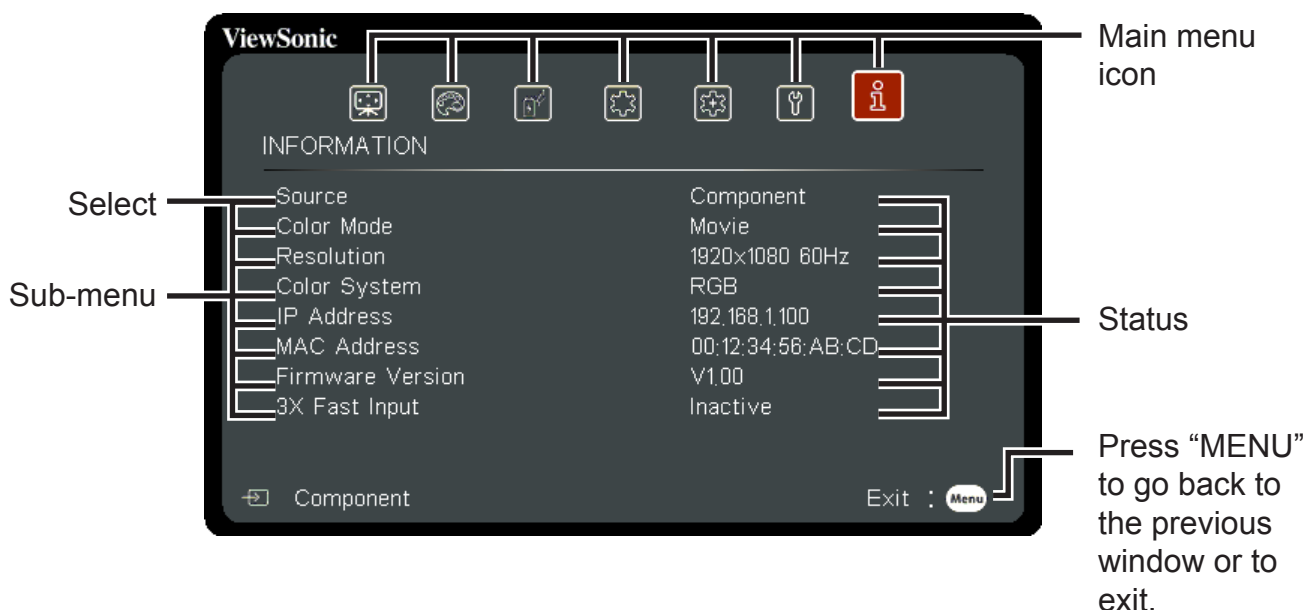

- Press Menu and then press the remote control ◀/▶ to select the **Display** and press ▼ to select Aspect Ratio.

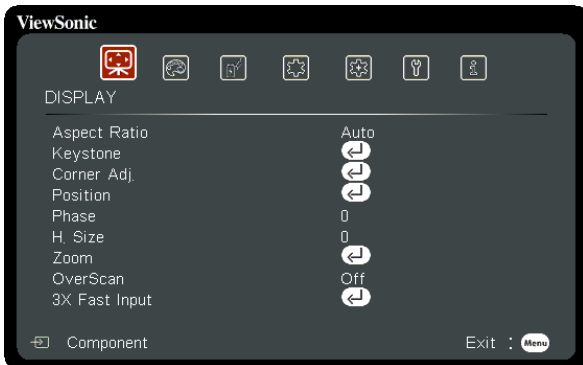

- Press Menu and then press the remote control ◀/▶ to select **Image** and press ▼ to select Color Mode.

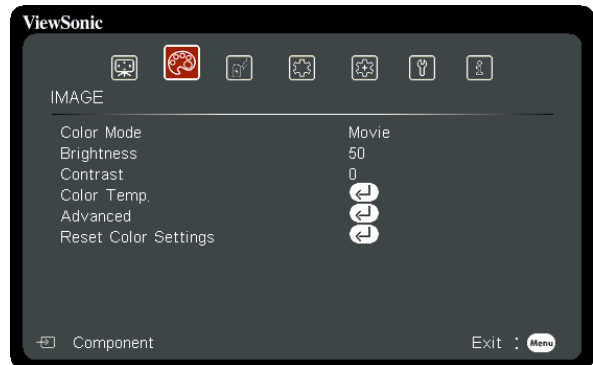

- Press Menu and then press the remote control ◀/▶ to select **Power Management** and press ▼ to select Auto Power On.

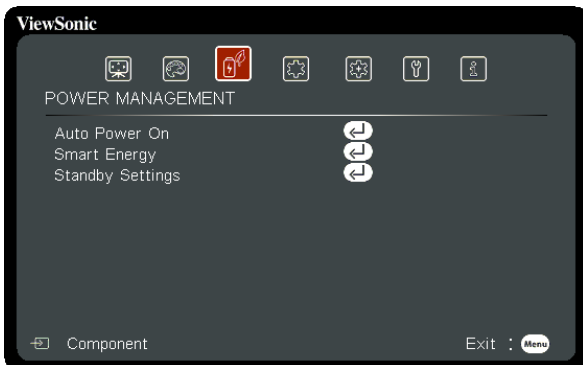

- Press Menu and then press the remote control ◀/▶ to select **Basic** and press ▼ to select Audio Settings.

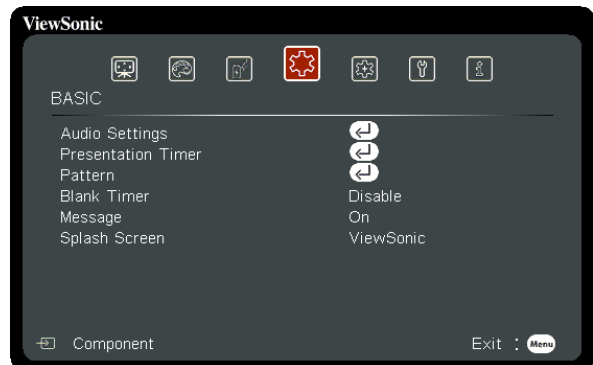

- Press Menu and then press the remote control ◀/▶ to select **Advanced** and press ▼ to select 3D Settings.

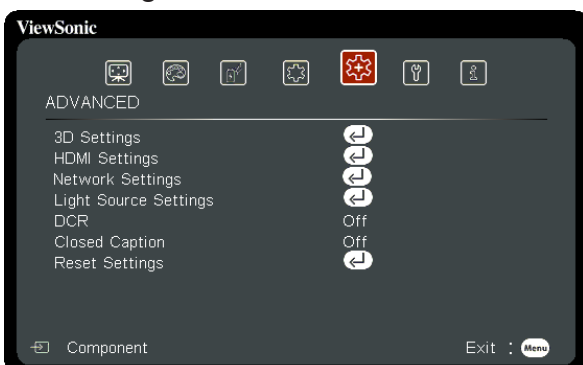

- Press Menu and then press the remote control ◀/▶ to select **System** and press ▼ to select Language.

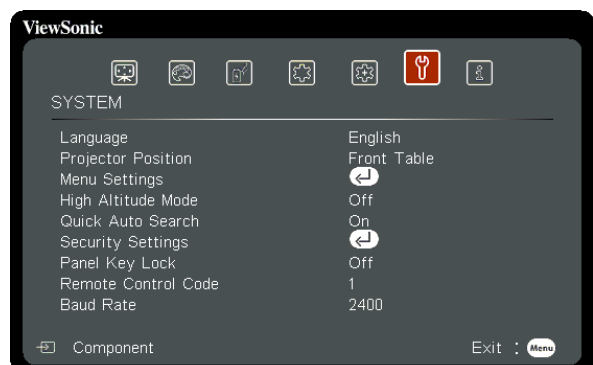

## Using the password function

For security purposes and to help prevent unauthorized use, the projector includes an option for setting up password security. Passwords may be set using the On-Screen Display (OSD) menu. Please refer to the [Using the menus] section for details on OSD menu operations.

 It is troublesome if you keep forgetting the password after setting up password protection. We recommend writing down the password and placing it somewhere safe for future reference in case you forget.

## Setting a password

 Once a password has been set, the user must provide the correct password after starting the projector. Otherwise, the projector cannot be used.

1. Open the OSD Menu and enter **System > Security Settings** menu.
2. Press [Enter]. The **Security Settings** page will be displayed.
3. Select **Power On Lock**, then press ◀/▶ and select **ON**.
4. The picture on the right shows 4 arrow keys (◀, ▲, ▼, ▶) which each represent 4 numbers (1, 2, 3, 4) respectively. According to the password you desire to set, press the arrow keys to enter six digits for the password.
5. Enter the password and confirm that password. After completing password settings, the OSD menu will return to the **Security Settings** page.
6. Press [Exit] to leave the OSD menu.

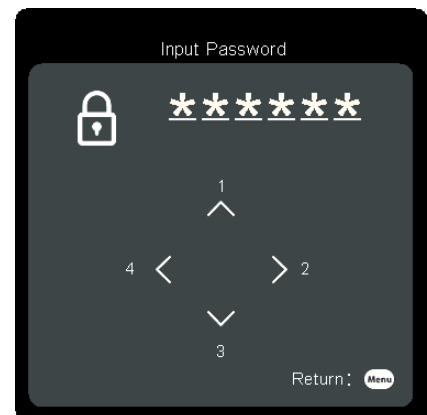

## If you forget your password

If the password function is activated, you will be asked to enter the six-digit password every time you turn on the projector. If you enter the wrong password, the password error message will be displayed for 3 seconds before the message [INPUT PASSWORD] is shown. You can enter another 6-digit password. You may use the password recall procedure if you forgot your password and did not record it in this manual. See [“Entering the password recall procedure”](#) for details.

If you enter an incorrect password 5 times in succession, the projector will automatically shut down for a short time.

## Entering the password recall procedure

1. Press and hold the [Auto Sync] button on the remote control for 3 seconds.
2. Write down the number and turn off your projector.
3. Seek help from the local service center to decode the number. You may be required to provide proof of purchase to verify that you are an authorized user of the projector.

 The [XXX] number in the screenshot shown above is determined by the projector model number.

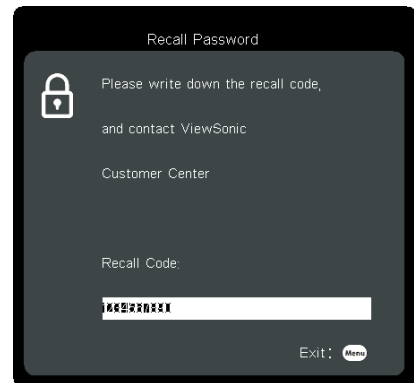

 This function can only be used on the screen after turning on the projector. It cannot be used on the current OSD menu.

## Change Password

1. Open the OSD and enter **System > Security Settings > Change Password** menu.
2. Press [Enter]. The message **[INPUT CURRENT PASSWORD]** will be shown.
3. Enter the old password.
  - If the password entered is correct, another message **[INPUT NEW PASSWORD]** will be shown.
  - If the password entered is incorrect, then the password error message will be displayed for 3 seconds before the screen shows the **[INPUT CURRENT PASSWORD]**. You will then need to re-enter the password. You can either press [Exit] to cancel the process or try other passwords.
4. Enter a new password.
5. You have successfully assigned a new password to the projector. Remember to enter the new password next time the projector is started.
6. Press [Exit] to leave the OSD menu.

 Any digit entered will be displayed as asterisks [\*] on-screen. We recommend writing down the password and placing it somewhere safe for future reference in case you forget.

## Disabling the password function

1. Open the OSD menu and enter **System > Security Settings > Power On Lock** menu.
2. Press ◀/▶ and select **OFF**.

 Though the password function is disabled, you need to keep the old password in hand should you ever need to re-activate the password function by entering the old password.

## Switching input signal

The projector can be connected to multiple devices at the same time. However, it can only display one full screen at a time.

If you want the projector to automatically search for various signals, please confirm that the **Quick Auto Search** function in the **SYSTEM** menu is switched **ON**.

You may also press the source selection button on the remote control or search for available input signals to manually select the desired signals.

1. Press [Source] to display the source selection column.
2. Keep pressing the ▲/▼ until you arrive at the desired signal, then press [Enter].

Once detected, the selected source information will display on the screen for seconds. If there are multiple devices connected to the projector, repeat steps 1 to 2 to search for another signal.

 For display resolutions of this projector, please refer to **“Projector specifications”**. To achieve the best image display effects, you should select and use an input signal that outputs at this resolution. Any other resolutions will be scaled by the projector depending upon the aspect ratio setting, which may cause some image distortion or loss of picture clarity. See **“Selecting the aspect ratio”** for details.

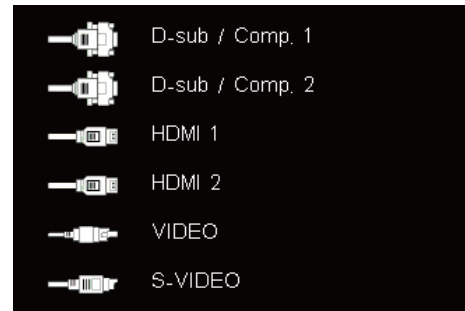

## Changing HDMI input settings

In the unlikely event that you connect the projector to a device (such as DVD or Bluray player) via the projector's HDMI input jack, and the projected picture displays the wrong colors, please change the color space settings to one that complies with the color space settings of the output device.

To perform this operation:

1. Open the OSD menu and enter **ADVANCED > HDMI settings** menu.
2. Press [Enter].
3. Select **HDMI format**, then press ◀/▶ to select a suitable color space according to the color space settings of the output device.
  - **RGB**: Changes the color space to RGB.
  - **YUV**: Changes the color space to YUV.
  - **Auto**: Sets the projector to automatically detect the color space settings of the color space.
4. Select **HDMI Range**, then press ◀/▶ to select a suitable color range according to the color range settings of the output device.
  - **Enhanced**: Changes HDMI color range to 0-255.
  - **Normal**: Changes HDMI color range to 16-235.
  - **Auto**: Sets the projector to automatically detect the HDMI range of the input signal.

 This function is only available when the HDMI input jack is being used.

 Please refer to equipment documentation to gain more details on color space and HDMI range settings.

# Adjusting the projected image

## Adjusting the projection angle

The projector is furnished with an adjustment support peg. The adjustment support peg may be used to adjust projection height and projection angle along the vertical axis. The user may turn the adjustment support peg to make fine adjustments to projection angle and position of the projected image until it reaches the desired location.

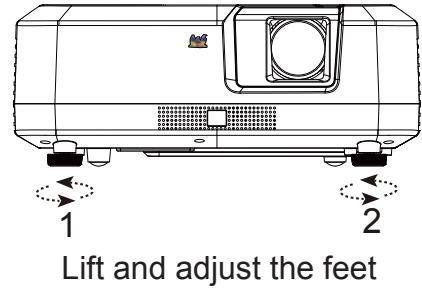

If the projector is placed on an uneven surface or where the screen and projector are not perpendicular to each other, the projected image may be subject to keystone (trapezoidal) distortion. For more details on projection calibration, please refer to [“Perform keystone correction”](#).

## Auto-adjustments to the image

The focus ring can be used to adjust the image clarity.

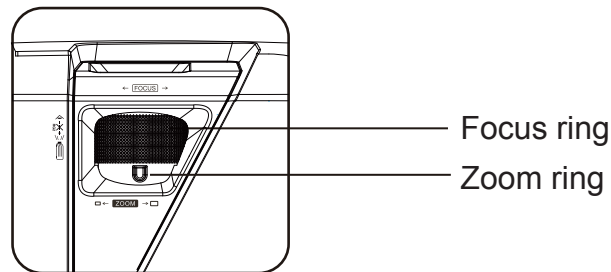

1. Turn the zoom ring to adjust the image size.
2. Sharpen the image by rotating the focus ring. It is recommended to use still images for focusing.



## Perform keystone correction

Keystone distortion is a problem where the projected image becomes trapezoidal in shape (keystone distortion) as a result of poor projection angle.

To correct this situation, you should adjust projector height and use the following steps to correct the issue manually.

- Using the remote control

1. Press  $\triangle/\nabla$  to display the Keystone Correction page.
2. Press  $\triangle$  to initiate Keystone Correction at the top of the image. Press  $\nabla$  to initiate Keystone Correction at the bottom of the image.

- Using the OSD menu

1. Open the OSD menu and open **Display > Keystone** menu.
2. Press [Enter]. This will bring up the **Keystone** page.
3. Press  $\triangle$  to initiate Keystone Correction at the top of the image. Press  $\nabla$  to initiate Keystone Correction at the bottom of the image.
4. Press  $\square$  to initiate Keystone Correction at the bottom of the image. Press  $\triangleright$  to initiate Keystone Correction at the right of the image.

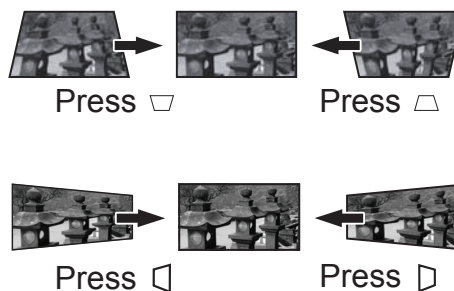

## Adjust four corners

Using the OSD menu

Open the OSD menu and go to the **Display > Corner Adj.**







1. Display four corner adjustment OSD on the screen.
2. Select the corner to be adjusted, and then the selected area will become red.
3. Two corners can be adjusted.
4. Save the settings and then close the OSD menu.

How to reset the corner adjustment:

- Press [Enter] for 2 seconds to reset the adjustments. “Resetting statement: Do you want to reset? Reset/Cancel” will display on the screen.
- The corner adjustment will be reset if you adjust the **Keystone**.

## Zoom in to see details



You may need to expand the image to inspect details in the projected image. Use the arrow keys to move the images.

- Using the remote control
  1. Press the  on the remote to bring up the Zoom Bar.
  2. Press  repeatedly to expand the image to the desired dimension.
  3. To browse the image, press [Enter] to switch to displacement mode and use the arrow keys (, , , ) to move the image for browsing.
  4. To zoom out of the image, press the zoom out key to zoom out of the image. You can also press the [Auto Sync] button on the remote control to restore the image to its original size.
- This function is suitable for remote control operations.

 You can check the image only after zooming in. You can further zoom in to check the details. Adjustable range depends on different aspect ratios.

## Selecting the aspect ratio

The 'aspect ratio' is the ratio of the image width to the image height. Most analog TV and computers have a 4:3 aspect ratio, while digital TV and DVDs have 16:9 aspect ratios. With the advent of digital signal processing, digital display devices like this projector can dynamically stretch and scale the image output to a different aspect than that of the image input signal. To change the projected image ratio (no matter what aspect the source is):

1. Open the OSD Menu and enter **Display > Aspect ratio** menu.
2. Press / to select an aspect ratio that suits the format of the video signal and your display requirements.

# About the aspect ratio

☞ Choose how to make the screen suitable for the screen:

1. **Auto:** Proportional scaling of an image to fit the projector's natural resolution in its horizontal width. This is suitable where the incoming image is neither in 4:3 nor 16:9 aspect ratios but where you want to make most use of the screen without altering the image's aspect ratio.

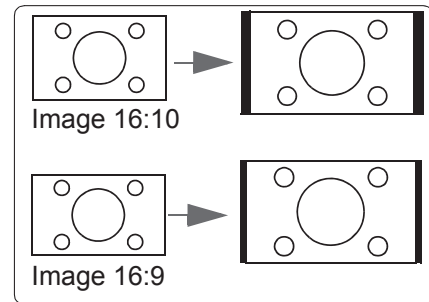

2. **4:3:** Scales a picture so that it is displayed in the center of the screen with a 4:3 aspect ratio. This is most suitable for 4:3 pictures such as those for computer monitors, standard definition TV, and 4:3 aspect DVD movies as these can be displayed without aspect alteration.

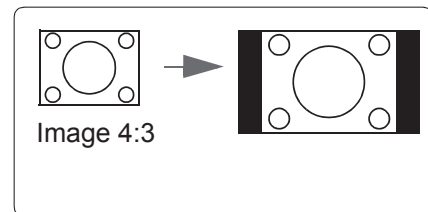

3. **16:9:** Scales a picture so that it is displayed in the center of the screen with a 16:9 aspect ratio. This is most suitable for images which are already in a 16:9 aspect such as high definition TV because as these can be displayed without aspect alteration.

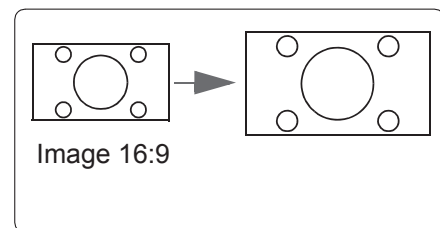

4. **16:10:** Scales an image in ratio so that it is displayed in the center of the screen with a 16:10 aspect ratio. This is most suitable for images which are already in a 16:10 aspect as it displays them with out aspect alteration.

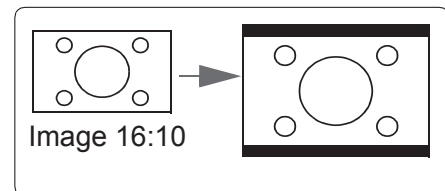

5. **Native:** The image is projected as its original resolution, and resized to fit within the display area. For input signals with lower resolutions, the projected image will display smaller than if resized to full screen.

# Optimizing the image

## Selecting a picture mode

The projector is preset with several predefined picture modes. You may choose one of these modes that best fits your operating environment and input signal picture type.

To select an operation mode that suits your need, please follow the steps described below.

- Press [Color Mode] repeatedly until you arrive at the mode you desire.
- Enter **Image > Color mode** menu and press ◀/▶ to select the required mode.

## Picture modes for different types of signals

The following lists the Picture modes that can be used for different signal types.

1. **Standard mode:** Suitable for normal conditions during the daytime.
2. **Game:** Tint suitable for gaming.
3. **Movie Mode:** Applicable for playing colored movies, video clips from digital cameras, or DVs from a PC input in darker (dim) environments to achieve the best viewing effects.
4. **Brightest:** Maximizes the brightness of the projected image. This mode is suitable when using projectors in environments such as well-lit rooms where extra-high brightness is required.
5. **Sports mode:** Tint suitable for watching sporting events.
6. **User1/User2:** Users can adjust the color according to their preferences.

 **Switch to Movie Mode will trigger notch filter glass and bring slight operating sound.**

## Fine-tuning of image quality in user modes

You may use several user-defined functions if the projector detects certain signal types. You can make adjustments to these functions based on your needs.

### Adjusting Brightness

Enter **Image > Brightness** menu and then press ◀/▶.

The higher the value, the brighter the image. And lower the setting, darker the image.



Adjusting this control allows the black area of the image to appear just as black to reveal details within.

### Adjusting Contrast

Enter **Image > Contrast** menu and then press ◀/▶.

The higher the value, the greater the contrast. After adjusting **Contrast**, this function may be used to set the peak-white level that matches the input signal and observed environment of your choice.



### Adjusting Color

Enter **Image > Advanced > Color** menu and press ◀/▶.

Lower settings produce less color saturation. If the setting is too high, colors on the image will be overpowering, which makes the image unrealistic.

☞ This function is only available when the input signals are Video, YPbPr or YCbCr.

### Adjusting Tint

Enter **Image > Advanced > Tint** menu and press ◀/▶.

The higher the value, the more reddish the picture becomes. The lower the value, the more greenish the picture becomes.

☞ This function is only available when the input signal is Video.

### Adjusting Sharpness

Enter **Image > Advanced > Sharpness** menu and then press ◀/▶.

Higher settings produce sharper images. The lower the value, the softer the picture becomes.

☞ This function is only available when the input signals are Video, YPbPr or YCbCr.

## Adjusting Brilliant Color

Enter **Image > Advanced > Brilliant Color** menu and press ◀/▶.

This feature utilizes a new color-processing algorithm and system level enhancements to enable higher brightness while providing truer, more vibrant colors of the projected image. Brightness levels of mid-tone areas commonly seen in videos and natural landscapes are increased by more than 50%, allowing the projector to generate images in realistic and true colors. To acquire this quality of images, please select the level you desire. If not required, set this option to **OFF**.

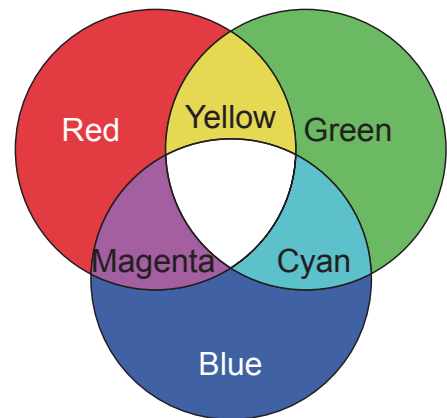

## Reducing image noise

Enter **Image > Advanced > Noise Reduction** menu, and then press ◀/▶.

This function is capable of reducing image noise generated electrically by different media players. Higher settings will provide lower image noise.

☞ This function is only available when **PC, Video** input signals are selected.

## Selecting a Color Temperature

Enter **Image > Color Temperature** menu, and then press [Enter].

Options available to Color Temperature settings will depend on the choice of the signal type.

1. **5500K**: White colors in the image will be provided with a light red undertone.
2. **6500K**: Maintains a normal white color tone.
3. **8000K**: Provides the highest color temperature. **8000K** colors allow the image to display white colors with the more blue undertones compared to other temperatures.

## Setting a preferred color temperature

1. Enter **Image > Color Temperature** menu, and then press [Enter].
2. Press ◀/▶ to select **5500K, 6500K** or **8000K**.
3. Press ▲/▼ to select the item you wish to change, then press ◀/▶ to adjust its value.
  - **Red Gain/Green Gain/Blue Gain**: Adjusts the contrasts of the red, green, and blue colors.
  - **Red Offset/Green Offset/Blue Offset**: Adjusts the brightness of red, green, and blue colors.

## Select a gamma setting

Gamma refers to the relationship between input source and image brightness.

1. Enter **Image > Advanced** menu and then press [Enter].
2. Press ▲/▼ to select **Gamma** and then press ◀/▶ to select the required settings.

## Color Management

Only in permanent installations with controlled lighting levels such as boardrooms, lecture theaters, or home theaters, should color management be considered. Color management provides fine color control adjustment to allow for more accurate color reproduction, should you require it.

If you have purchased a test disc that contains various color test patterns that can be used to test the color presentation of monitors, TVs, and projectors, any image from the disc can be projected on screen and adjusted using the **Color Management** menu.

### To adjust the settings:

1. Open the OSD menu, go to **Image > Advanced > Color Management** menu.
2. Press [Enter] to bring up the **Color Management** page.
3. Select **Primary Color** and press ◀/▶ to select any one of the colors from red, yellow, green, cyan, blue, or magenta.
4. Press ▼ to select the **Hue**, then press ◀/▶ to select the range. Enlarging the range will include colors composed of higher proportions of 2 similar colors. Please refer to the illustration to the right for how the colors relate to each other.

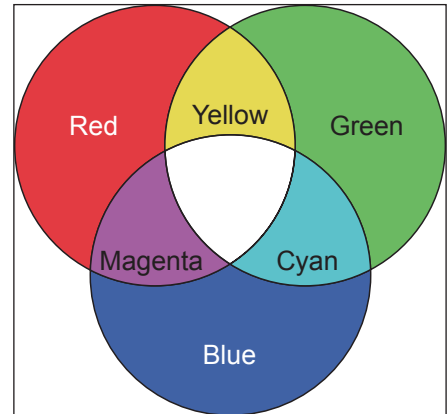

For example, if you select red and set the range to 0, you will only select pure red areas of the projected image. Increasing the range will include shades of red closer to yellow and magenta.

5. Press ▼ to select **Saturation**, then press ◀/▶ to adjust its values according to your preferences. The effect of each adjustment will be immediately reflected upon the image.  
For example, if you select Red and set its value at 0, only the saturation of pure red will be affected.

 **Saturation is the amount of that color in a video picture. Lower settings produce less saturated colors. A setting of 0 will remove that color from the image entirely. If the saturation is too high, that color will be overpowering and unrealistic.**

6. Press ▼ and select **Gain**, then press ◀/▶ to adjust its values according to your preferences. This affects the contrast level of the primary color selected. The effect of each adjustment will be immediately reflected upon the image.
7. Repeat steps 3 to 6 to carry out other color adjustments.
8. Make sure you have made all of the desired adjustments.
9. Press [Exit] to save the settings and exit.

# Setting the Presentation Timer

The presentation timer can indicate the presentation time on-screen to help you achieve better time management when giving presentations. Follow these steps to utilize this function:

1. Enter **Basic > Presentation Timer** menu.
2. Press [Enter] to show the **Presentation Timer** page.
3. Select **Timer Period** and press ◀/▶ to confirm the duration. Duration can be set to 1 to 5 minutes, with 1 minute increments, or 5 to 240 minutes. The options are 5, 10, 15, 20, 60, 120, 240 minutes.

☞ **Once the timer has been activated, resetting the timer interval will re-activate the timer.**

4. Press ▼ and select the **Timer Display**. Then press ◀/▶ to select whether to display or hide the on-screen timer.

Selection	Description
Always	Displays the timer on screen throughout the presentation time.
1 min/2 min/3 min	Display timer on-screen in the last 1 / 2 / 3 minutes.
Never	Hides the timer throughout the presentation time.

5. Press ▼ and select **Timer Position**, and then press ◀/▶ to set timer location.

**Top-Left → Bottom-Left → Top-Right → Bottom-Right**

6. Press ▼ to select **Timer Counting Direction**, then press ◀/▶ to select the required timer method.

Selection	Description
<b>Count Up</b>	Increases from 0 to the preset time.
<b>Count Down</b>	Decrease from the preset time to 0.

7. To activate Presentation Timer, press ▼ and select **Start Counting**, then press ◀/▶ to select **Yes**. The timer will start counting after exiting the OSD menu.

## To cancel the timer, perform the following steps:

1. Enter **Basic > Presentation Timer** menu.
2. Press ▼ and select **Start Counting**.
3. Select **No**. The timer will stop counting after exiting the OSD menu.

## To activate the sound reminder, perform the following steps:

1. Enter **Basic > Presentation Timer** menu.
2. Press ▼ and select **Sound Reminder**.
3. Press ◀/▶ to select **On** and exit the OSD menu. When the time comes up to the set time of timer, it will make a sound.



## Hiding the image

In order to draw the audience's attention to the presenter, you may press Blank to hide the screen image. Press any key on the projector or remote to restore the image. After hiding the image, the lower right corner of the screen will display the text **[Blank]**.

You can go to **Basic > Blank Timer** menu to set blank screen duration. Once the blank screen countdown is complete, the image will be automatically re-displayed.

 After pressing **[Blank]**, the projector will automatically enter **Power Saving** mode.



### Caution

Do not block the projector lens. The blocking item may be heated to the point of deformation or may even cause a fire.

## Locking control keys

Locking the control buttons of the projector allows you to prevent projector settings from being changed accidentally (by children, for example). Once **Panel Key Lock** has been activated, with the exception of the  Power button, none of the buttons on the projector could be used.

1. Go to **System > Panel Key Lock** menu.
2. Press **▲/▼** and select **ON**.

To switch off the Panel Key Lock, press **▶** and hold the button on the Projector for 3 seconds.

You may also use the remote to enter **System > Panel Key Lock** menu, press **▲/▼** and select **OFF**.

 Buttons on the remote control can still be used even if the Panel Key Lock function has been switched on.

 If you press the  Power button to switch off the projector without switching off the Panel Key Lock function, the projector buttons will remain locked when you switch it on the next time.

## Light source settings

Light Source Mode

Setting light source mode.

- Normal: 100% light source power
- Power Saving: 80% light source power
- Custom: 20%/40%/ 60%/ 80%/ 100% light source power for selection by user.

Light Source Hours

Displays the time (hours) that the light source has been running.

## Extending light source life

To keep the light source life as long as possible, you can do the following settings via the OSD menu.

Use the **Power Saving** mode to reduce system noise and power by 20%. If you select **Power Saving** mode, the light intensity will decrease and the projection pattern will be darker.

Switching the projector setting to **Power Saving** mode also extends the light source. To set **Power Saving** mode, go to **Advanced > Light Source Settings > Light Source Mode**, press ◀/▶ to select **Power Saving**, or press [Eco Mode] on the remote control to make the choice.

### Setting Auto Power Off

This function allows the projector to enter Sleep mode automatically after the set time, to avoid unnecessary wastage of the light source.

1. Open the OSD menu and go to the **Power Management > Smart Energy** menu.
2. Press [Enter] to display the **Smart Energy** page.
3. Select **Auto Power Off** and press ◀/▶ to select the time.
4. If the pre-set time length is not suitable for your needs, select **Disable**. The projector will not automatically shut down in a certain time period.

### Setting the Sleep Timer

This function allows the projector to enter sleep mode automatically after the set time, to avoid unnecessary wastage of the life of the light source.

1. Open the OSD menu and go to the **Power Management > Smart Energy** menu.
2. Press [Enter] to display the **Smart Energy** page.
3. Select **Sleep Timer** and press ◀/▶ to select the time.
4. If the length of the pre-set time does not apply to your presentation, select **Disable**. The projector will not automatically shut down in a certain time period.

### Set power saving

If no input source is detected after 5 minutes. The projector will reduce power consumption to avoid unnecessary wastage of the life of the light source. You can further decide whether to let the projector turn off after the set time.

1. Open the OSD menu and go to the **Power Management > Smart Energy** menu.
2. Press [Enter] to display the **Smart Energy** page.
3. Select **Power Saving** Press ◀/▶ and select **Enable**.
4. When **Enable** is selected, the light source of the projector will be changed to **Eco** mode 5 minutes after no signal is detected. If the projector has not detected the signal after 20 minutes, its light source power will be changed to SuperEco mode.

## Operations at high altitudes

We recommend using the **High Altitude Mode** when the environment is at 1,500 to 3,000 meters above sea level and the temperature is between 5°C to 25°C.



### Note

**Do not activate High Altitude Mode if the environment is at 0 to 1,500 meters above sea level and the temperature is between 5°C to 35°C. Activating High Altitude Mode under such circumstances will lead to excessive cooling of the projector.**

Activating **High Altitude Mode**:

1. Open the OSD menu and enter **System > High Altitude Mode** menu.
2. The confirmation message will be shown, then press ◀/▶ to select **Yes**.
3. Press [Enter].

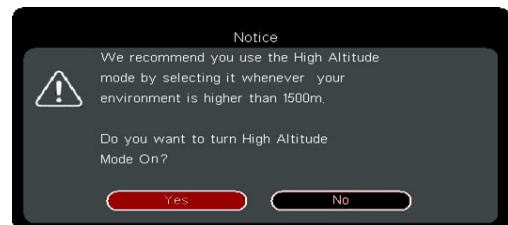

There is a chance that louder operational noises will be generated when using the projector in **High Altitude Mode**. The reason for this is the increased fan speed necessary to improve overall system cooling and performance.

Using this projector under extreme environments that exceed the aforementioned limits may lead to auto-shutdown designed to prevent overheating of the projector. Under such circumstances, you should switch to **High Altitude Mode** to solve these issues. However, this does not mean that this projector is able to operate under any and all harsh or extreme conditions.

## Using the CEC function

This projector supports the Consumer Electronics Control (CEC), allowing you to connect to HDMI and achieve synchronized power ON/OFF operations. This means that when a device that also supports CEC is connected to the HDMI input jack of the projector, switching off the power of the projector will also automatically switch off the power of the connected device. Switching on the power of the connected device will also automatically switch on the projector.

Activating the CEC function:

1. Open the OSD menu and enter **Power Management > Auto Power On > CEC menu**.
2. Press ◀/▶ and select **Enable**.



To ensure proper operations of the CEC function, please verify that the target device has been connected to the HDMI input jack via an HDMI cable and that the CEC function has been activated.



CEC function may not be usable according to the connected equipment.

## 3D functions

This projector also comes with 3D functions that offer greater depth and immersion when viewing 3D movies, videos, sports, and games. You will need a pair of 3D glasses when viewing 3D images and videos.

If the 3D signal comes from an HDMI 1.4a compatible device, this projector will look for a 3D Sync data signal. Once detected, the projector will automatically switch to 3D projection. Under other circumstances, you may need to manually select the 3D Sync format to ensure the proper projection of 3D images.

Selecting 3D Sync formats:

1. Use the remote control or control panel to open the OSD menu, select **Advanced > 3D Settings** menu.
2. Press [Enter] to bring up the **3D Settings** page.



Once 3D Sync function has been activated:

- Brightness of the projected image will be reduced.
- Color modes cannot be adjusted.
- Zoom functions can only enlarge the image to a limited degree.

If the 3D image has been severely inverted, you may set the 3D Sync Invert function to [Invert] to correct this problem.

## Control the projector through the local area network

This projector supports Crestron® software. After correct settings in the wired local area network menu are finished, the projector can be managed on the computer with the browser when the computer and the projector are correctly connected to the same local area network.

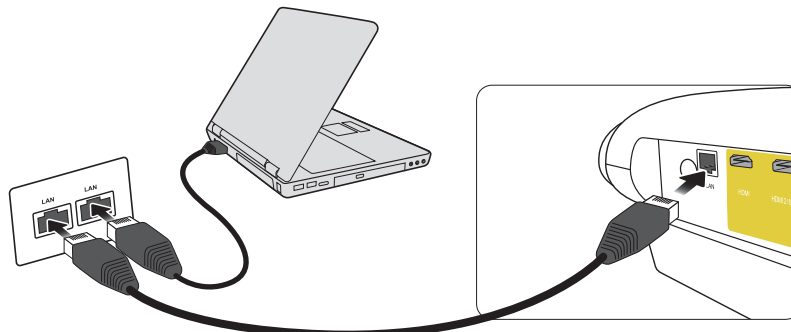

(Example of connection)

Configure the wired local area network

If you are in a DHCP environment:

1. Connect one end of the RJ45 cable to the RJ45 local area network input jack of the projector, and connect the other end to the RJ45 port.
2. Open the OSD menu and enter the **Advanced > Network Settings**.
3. Select DHCP and then press ◀/▶ to select On.
4. Press ▼ to select the Apply and then press [Enter].
5. Please wait for about 15-20 seconds and then re-enter the page of the wired local area network. The IP address, subnet mask, default gateway and DNS server settings will be displayed. Please remember the IP address displayed in the IP address.



If the IP address still does not display, contact the network administrator.

- ☞ If the RJ45 cable is not correctly connected, the IP address, subnet mask, default gateway and DNS server settings will be displayed as 0.0.0.0. Make sure the cable has been correctly connected and re-execute the above steps.
- ☞ To connect to the projector when the projector is in the standby mode, set the Advanced > Network Settings > Standby LAN control to On.

## If you are in a non-DHCP environment:

1. Repeat the above steps 1-2.
  2. Select DHCP and then press ◀/▶ to select **Off**.
  3. Contact your ITS administrator for the setting information about IP address, subnet mask, default gateway and DNS server.
  4. Press ▼ to select the item you want to modify and then press [Enter].
  5. Press ◀/▶ to move the cursor and then press ▲/▼ to input the value.
  6. To save the settings, press [Enter]. If you do not want to save the settings, press [Exit].
  7. Press ▼ to select Apply and then press [Enter].
- ☞ If the RJ45 cable is not correctly connected, the IP address, subnet mask, default gateway and DNS server settings will be displayed as 0.0.0.0. Make sure the cable has been correctly connected and re-execute the above steps.
  - ☞ To connect to the projector when the projector is in the standby mode, make sure the DHCP has been set to Off and the IP address, subnet mask, default gateway and DNS server information have been acquired after the projector is powered on.

## Control the projector with the web browser

If the correct IP address of the projector is acquired, and the projector is powered on or in standby mode, any computer in the same local area network can be used to control the projector.

- ☞ If Microsoft Internet Explorer is used, make sure the version is 7.0 or higher.
- ☞ The screenshots in this manual are for reference only. Actual OSD design may differ.

1. Enter the address of the projector in the address bar of your browser and press [Enter].

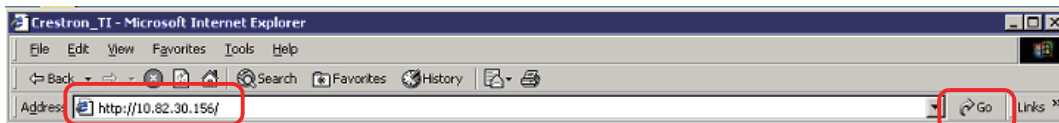

2. The homepage of “Network Control” is displayed.

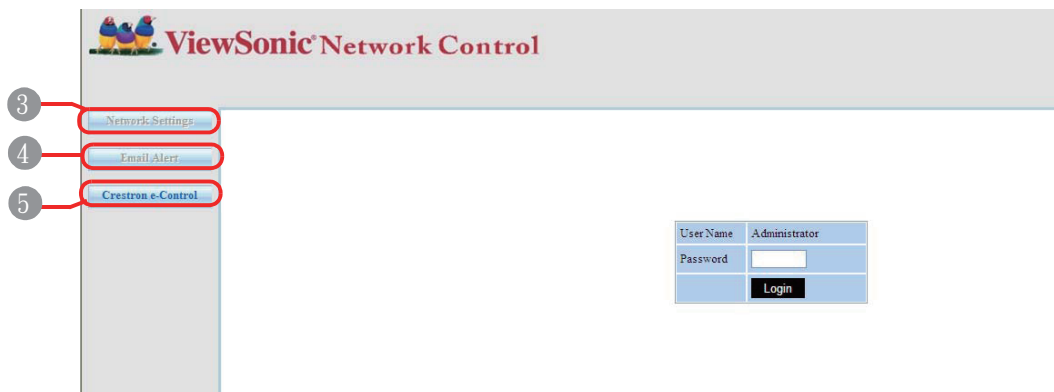

- ☞ Access to the Network Settings or Email Alert web page needs the administrator password. The default password is “0000”.

3. You can adjust AMX and SNMP settings on this page. On the AMX device discovery, the controller connected to the AMX of the same network will find the projector when ON is selected. For details of the AMX Device Discovery, please access the AMX website: <http://www.amx.com/>.

The screenshot shows the 'ViewSonic Network Control' web interface. The 'Network Settings' tab is selected and highlighted with a red circle. The interface is divided into three main sections: Network, Password, and SNMP. The Network section includes radio buttons for DHCP (selected) and Manual, and input fields for IP Address (10.82.30.49), Subnet Mask (255.255.255.0), Gateway (10.82.30.254), and DNS Server (10.82.15.15). The Password section has input fields for Administrator, New Password, and Confirm Password. The SNMP section has input fields for SysLocation, SysName, and SysContact. At the bottom, there is a section for 'AMX device discover' with radio buttons for ON (selected) and OFF, and a 'Submit' button.

4. If the projector is connected to the network which supports the SMTP (Simple Mail Transfer Protocol), you can configure it to send alarms via emails when important events occur.

The screenshot shows the 'ViewSonic Network Control' web interface. The 'Alert Setting' tab is selected and highlighted with a red circle. The interface is divided into three main sections: Email Setting, SMTP Setting, and Alert Condition. The Email Setting section has input fields for To, Cc, Subject, and From. The SMTP Setting section has input fields for Server, User Name, and Password. The Alert Condition section has checkboxes for Fan Error, Lamp Error, Over Temperature, and Lamp Time Alert. At the bottom, there are 'Submit' and 'Issue Test Mail' buttons.

5. Crestron (e-Control) page displays the Crestron e-Control user interface. For details, please refer to [“About Crestron e-Control®”](#).

Please note the input length limits in the following table (including space and other punctuation marks):

Type item		Input length	Maximum character
Network Settings	Network	DHCP/Manual	(None)
		IP Address	XXX.XXX.XXX.XXX
		Subnet Mask	XXX.XXX.XXX.XXX
		Gateway	XXX.XXX.XXX.XXX
		DNS Server	XXX.XXX.XXX.XXX
		AMX device discovery	(None)
	Password	Administrator	(None)
		New Password	4
		Confirm Password	4
SNMP	SysLocation	22	
	SysName	22	
	SysContact	22	
Email Alert	Email Setting	To	40
		Cc	40
		Subject	40
		From	40
	SMTP Setting	Server	30
		User Name	21
		Password	14
	Alert Condition	Fan Error	(None)
		Light source Error	(None)
		Over Temperature	(None)
		Light source Time Alert	(None)
		Submit	(None)
Issue Test Mail		(None)	

☞ / > < \$ % + \ ' " are forbidden.

# About Crestron e-Control®

1. The Crestron e-Control® page provides various virtual buttons to control the projector or adjust the projected image.

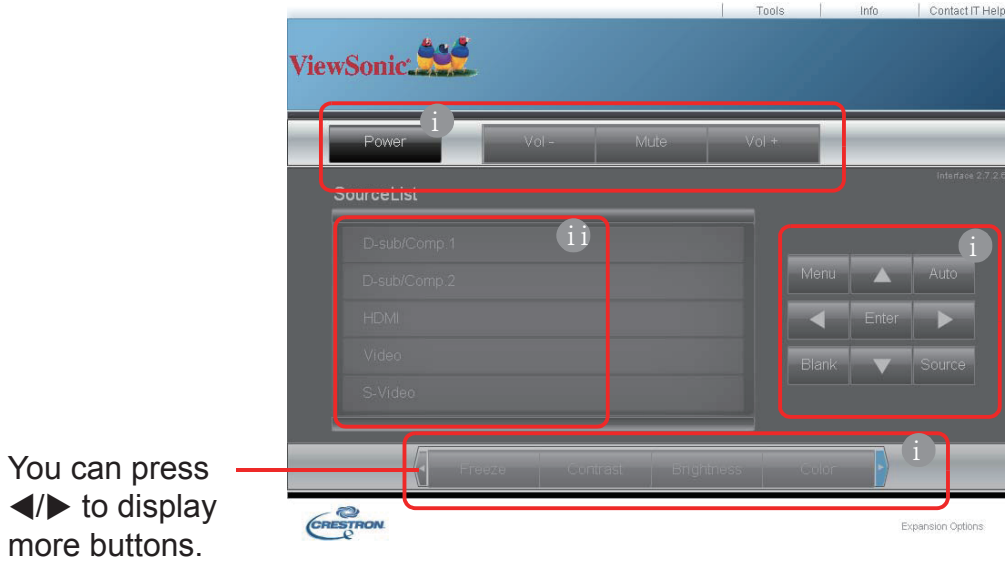

You can press ◀/▶ to display more buttons.

- i. The functions of those buttons are identical with those on the OSD menu or remote control.
- ii. To switch the input signal source, please click the required signal.

- ☞ The Menu button can be used to return to the previous OSD menu, exit and save menu settings.
- ☞ The signal source list may differ from the available interfaces on the projector.
- ☞ The web browser needs some time to perform change synchronization with the projector when the projector control panel or remote control is used to change the OSD menu settings.

2. The Tools page can be used to manage the projector, configure the LAN control settings, and perform remote network operation security access to the projector.



- i. This part can be used only in the case that the Crestron control system is used. Please contact Creston or refer to its user guide to get a knowledge of the installation information.
- ii. You can name the projector, and record its position and responsible person.



- iii. You can adjust the wired local area network.
- iv. After setup has finished, the remote network operation access to the projector is protected with a password.
- v. After setup has finished, access to the Tools page is protected with a password.

☞ To avoid mistakes, please input the English letters and digits in the Tools page.

☞ After adjustment, press the Send button and the data will be saved in the projector.

- vi. Press Exit and then you can return to the remote network operation page.

Please note the input length limits in the following table (including space and other punctuation marks):

Type item	Input length	Maximum character
Crestron Control	IP Address	16
	IP ID	4
	Port	5
Projector	Projector Name	32
	Location	32
	Assigned To	32
Network Configuration	DHCP (Enabled)	(None)
	IP Address	16
	Subnet Mask	16
	Default Gateway	16
	DNS Server	16
User Password	Enabled	(None)
	New Password	26
	Confirm	26
Admin Password	Enabled	(None)
	New Password	26
	Confirm	26

3. The Info page displays the information and status of this projector.



Press Exit and then you can return to the remote network operation page.

4. Press “Contact IT Help” button, and then a HELP DESK window will be displayed in the upper right corner of the screen. You can send information to the RoomView™ software administrator / user connected to the same local area network.

For details, please access <http://www.crestron.com> and <http://www.crestron.com/getroomview>.

#### \*\*Crestron RoomView

On the “Edit Room” page, input the IP address (or the host name) as the content displayed in the screen display menu of the projector, and input “02” as the IPID, and input “41794” as the reserved Crestron control port.

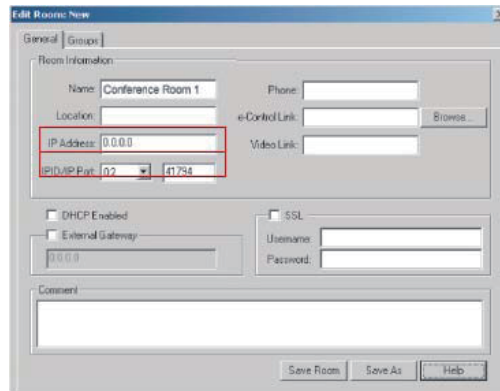

Regarding the Crestron RoomView™ settings and command method, please access the following website to obtain the RoomView™ User Guide and more information: [http://www.crestron.com/products/roomview\\_connected\\_embedded\\_projectors\\_devices/resources.asp](http://www.crestron.com/products/roomview_connected_embedded_projectors_devices/resources.asp)

#### Support PJLink™, SNMP, AMX and Xpanel formats

This projector is compatible with PJLink™, SNMP V.1, AMX or Xpanel V1.10. For details, please respectively refer to the User Guide or access the website to control and manage the projector.

## Using the projector under standby mode

A number of projector functions can be used under Standby Mode (plugged in to power but not switched on). To use those functions, please confirm the cables and wires have been correctly connected. Refer to the chapter on cable connections for more information on cable connections.



#### Active VGA Out

After the COMPUTER 1 and COMPUTER OUT jacks are correctly connected to the equipment, select Power Management > Standby Settings > Active VGA Out > On to output the VGA signal. The projector only outputs the signal received by COMPUTER 1.

#### LAN control

The setting in the Advanced > Network Settings > Standby LAN control menu drives the projector to provide network functions in the standby mode. For details, please refer to “Control the projector through the local area network”.

## Switch off the projector

1. Press the  Power button. A confirmation message will be displayed on screen. The message will disappear if you do not respond within a few seconds.
2. Press the  Power Button again, and the projector will be turned off. Wait until the fan is completely stopped and unplug the power cord.
3. Disconnect the power cord from the wall socket if the projector will not be used for an extended period of time.

# Menu operations

## Menu system

Please note that the on-screen display (OSD) menu may vary according to the type of signal received.





The projector must detect at least one valid signal in order to use the menu items. If no device has been connected to the projector or if no signal has been detected, only a few menu items will be accessible.

Main menu	Sub-menu	Options	
1. Display	Aspect Ratio	Auto/4:3/16:9/16:10/Native	
	Keystone	Up/Down: -40~40	
		Left/Right: -40~40	
	Corner Adj.		
	Position	Horizontal: -5~5	
		Vertical: -5~5	
	Phase	0~31	
	H. Size	-15~15	
Digital Zoom	0.8X~2.0X		
OverScan	Off/1/2/3/4/5		
3X Fast Input	Yes/No		
2. Image	Color mode	Brightest, Standard, Movie, Sports, Gaming, User 1/User 2	
	Brightness	0~100	
	Contrast	-50~50	
	Color Temperature	5500K	Red gain/Green gain/Blue gain/Red offset/Green offset/Blue offset
		6500K	
		8000K	
	Advanced	Color	-50~50
		Tint	-50~50
		Sharpness	0~31
		Gamma	1.8/2.0/2.2/2.35/2.5/Cubic/sRGB
		Brilliant Color	Off/1/2/3/4/5/6/7/8/9/10
		Noise Reduction	0~31
	Color Management	Primary color	Red/Green/Blue/Cyan/Magenta/Yellow
		Tint	-99~99
		Saturation	0~199
		Gain	5~195
Reset color settings		Reset/Cancel	

Main menu	Sub-menu	Options	
3. Power Management	Auto Power On	Signal	Disable/VGA 1/ HDMI 1/ All
		CEC	Disable/Enable
		Direct Power On	Off/On
	Smart Energy	Auto Power Off	Disable/10 min/20 min/30 min
		Sleep Timer	Disable/30 min/1 hr/2 hr/3 hr/4 hr/8 hr/12 hr
		Power Saving	Disable/Enable
	Standby Settings	Active VGA Out	Off/On
		Active Audio Out	Off/On
4. Basic	Audio Settings	Mute	Off/On
		Volume	0~20
		Power On/Off Ring Tone	Off/On
	Presentation Timer	Timer Period	1/2/3/4/5/10/15/20/60/120/240
		Timer Display	Always/3 min/2 min/1 min/ Never
		Timer Position	Top-Left/Bottom-Left/Top-Right//Bottom-Right
		Timer Counting Direction	Count down/count up
		Sound reminder	Off/On
		Start Counting	Yes/No
	Pattern	Off/Test Card	
	Blank Timer	Disable/5 min/10 min/15 min/20 min/25 min/30 min	
	Message	On/Off	
	Splash Screen	Blue/ViewSonic/Off	
5. Advanced	3D Settings	3D Sync	Off/Frame sequence/Frame Packing/Top-Bottom/Side-By-Side
		Save 3D Settings	Yes/No
		3D Sync Invert	Disable/Enable
	HDMI Settings	HDMI Format	Auto/RGB/YUV
		HDMI Range	Auto/Enhanced/Normal
	Network Settings	DHCP	On/Off
		IP Address	
		Subnet Mask	
		Gateway	
		DNS Server	
		Standby LAN control	On/Off
Apply		Apply	



Main menu	Sub-menu	Options	
5. Advanced	Light source setting	Light Source Mode	Normal/Power Saving/ Custom
		Light Source Power	20%/40%/60%/80%/100%
		Light Source Hours	
	Closed Caption	Closed Caption Enable	On/Off
		Caption Version	Off/CC1/CC2/CC3/CC4
Reset settings		Reset/Cancel	
6. System	Language	Multi-language OSD option	
	Projector Position	Front Table/Rear Table/Rear Ceiling/Front Ceiling	
	Menu Settings	Menu Display Time	5 sec/10 sec/15 sec/20 sec/25 sec/30 sec
		Menu Position	Center/Top-Left/Top-Right/ Bottom-Left/Bottom-Right
	High Altitude Mode	On/Off	
	Quick Auto Search	On/Off	
	Security Settings	Change Password	Input Current Password/Input New Password
		Power On Lock	On/Off
	Panel Key Lock	On/Off	
	Remote control code	1/2/3/4/5/6/7/8	
RS232 Baud Rate	2400/4800/9600/14400/19200/ 38400/57600/115200		
7. Information	<ul style="list-style-type: none"> <li>• Source</li> <li>• Color Mode</li> <li>• Resolution</li> <li>• Color System</li> <li>• IP Address</li> <li>• MAC Address</li> <li>• Firmware Version</li> <li>• 3X Fast Input</li> </ul>		

## Description of each menu

	Function	Description
1. Display menu	Aspect Ratio	See <a href="#">“Selecting the aspect ratio”</a> for details.
	Keystone	See <a href="#">“Perform keystone correction”</a> for details.
	Corner Adj.	See <a href="#">“Adjust four corners”</a> for details.
	Position	Displays the position adjustment page. To move the projected image, use the directional arrow keys. The values shown on the lower position of the page change with every key press you made until they reach their maximum or minimum.  <b>This function is only available when a PC and component input signal is selected.</b>  <b>The adjustment range may vary under different timings.</b>
	Phase	Adjusts the clock phase to reduce image distortion.   <b>This function is only available when a PC and component input signal is selected.</b>
	H. Size	Adjusts the horizontal width of the image.  <b>This function is only available when a PC and component input signal is selected.</b>
	Zoom	Zoom in or out from the picture.
	OverScan	To avoid the appearance of the distorted image at the edge of the screen, use over-scanning technology to expand the image by 5% or even 10%, and the distorted image extends to the place outside the screen; only the middle part with better linearity is shown.
2. Image menu	3X Fast Input	Selecting <b>On</b> enables the function. This feature helps reduce the frame rate. Enabling quick response in local timing. The following settings will return to factory defaults when enabled: aspect ratio, keystone correction, position, zoom, over scan. This function is only available if the optimum resolution input signal is selected.
	Color mode	See <a href="#">“Selecting a picture mode”</a> for details.
	Brightness	See <a href="#">“Adjusting Brightness”</a> for details.
	Contrast	See <a href="#">“Adjusting Contrast”</a> for details.
	Color Temp.	For more details, please refer to <a href="#">“Selecting a Color Temperature”</a> and <a href="#">“Setting a preferred color temperature”</a> .

	Function	Description
2. Image menu	Advanced	<p><b>Color</b> See “Adjusting Color” for details.</p> <p><b>Tint</b> See “Adjusting Tint” for details.</p> <p><b>Sharpness</b> See “Adjusting Sharpness” for details.</p> <p><b>Gamma</b> See “Selecting a Color Temperature” for details.</p> <p><b>Brilliant Color</b> See “Adjusting Brilliant Color” for details.</p> <p><b>Noise Reduction</b> See “Reducing image noise” for details.</p> <p><b>Color Management</b> See “Color Management” for details.</p>
	Reset color settings	Returns all color settings to the factory preset values.
3. Power Management menu	Auto Power On	<p><b>Signal</b> Set whether or not to automatically turn on when the projector is in the standby mode or the VGA or HDMI signal of 5V power is detected.</p> <p><b>CEC</b> See “Using the CEC function” for details.</p> <p><b>Direct Power On</b> Selecting <b>On</b> allows the projector to turn on automatically once the power is fed through the power cord.</p>
	Smart Energy	<p><b>Auto Power Off</b> See “Setting Auto Power Off” for details.</p> <p><b>Sleep Timer</b> See “Setting the Sleep Timer” for details.</p> <p><b>Power Saving</b> See “Set power saving” for details.</p>
	Standby Settings	See “Standby settings” for details.



	Function	Description
4. Basic menu	Audio Settings	<p><b>Mute</b></p> <p><b>Volume</b></p> <p><b>Power On/Off Ring Tone</b></p> <p>When turning on or off the projector, it will make a sound.</p>
	Presentation Timer	See “ <a href="#">Setting the Presentation Timer</a> ” for details.
	Pattern	The projector can display a test pattern. It helps you adjust the image size and focus and check that the projected image is free from distortion.
	Blank Timer	See “ <a href="#">Hiding the image</a> ” for details.
	Message	Selecting <b>On</b> displays the current information on the screen when the projector is detecting or searching for a signal.
	Splash Screen	Allows you to select which logo screen will be displayed during projector start-up.
5. Advanced menu	3D settings	See “ <a href="#">3D functions</a> ” for details.
	HDMI settings	See “ <a href="#">Changing HDMI input settings</a> ” for details.
	Network Settings	See “ <a href="#">Network settings</a> ” for details.
	Light Source Settings	See “ <a href="#">Light source settings</a> ” for details.
	Closed Caption	<p>Selects a preferred closed captioning mode when the selected input signal carries closed captions.</p> <ul style="list-style-type: none"> <li>• Captions: An on-screen display of the dialogue, narration, and sound effects of TV programs and videos that are closed captioned (usually marked as “CC” in TV listings).</li> </ul> <p> This function is only available when a Composite video input signal is selected and its system format is NTSC.</p> <p><b>Caption Version</b></p> <p>To view captions, select CC1, CC2, CC3, or CC4 (CC1 displays subtitles in the primary language of the region you are located in).</p>
Reset Settings	<p>Returns all settings to the factory preset values.</p> <p> The following settings will still remain: Keystone, Language, Projector Position, High Altitude Mode, Security Settings, 3D Sync Invert, Network Settings, Image Settings, Presentation Timer, Quick Auto Search and Remote control code.</p>	

	Function	Description
6. System menu	Language	Sets the language for the On-Screen Display (OSD) menus. See <a href="#">“Using the menus”</a> for details.
	Projector Position	See <a href="#">“Choosing a location”</a> for details.
	Menu Settings	<p><b>Menu Display Time</b> Sets the length of time the OSD will remain active after your last key press. The range is from 5 to 30 seconds in 5-second increments.</p> <p><b>Menu Position</b> Sets the On-Screen Display (OSD) menu position.</p>
	High Altitude Mode	A mode for operation in high altitude areas. See <a href="#">“Operations at high altitudes”</a> for details.
	Quick Auto Search	See <a href="#">“Switching input signal”</a> for details.
	Security Settings	See <a href="#">“Using the password function”</a> for details.
	Panel Key Lock	See <a href="#">“Locking control keys”</a> for details.
	Remote control code	See <a href="#">“Remote control code”</a> for details.
	RS232 Baud Rate	See <a href="#">“RS232 command table”</a> for details.
7. Information menu	Current System Status	<p><b>Source</b> Shows the current signal source.</p> <p><b>Color mode</b> Shows the selected mode in the <b>Image</b> menu.</p> <p><b>Resolution</b> Shows the native resolution of the input signal.</p> <p><b>Color System</b> Shows the input system format.</p> <p><b>IP Address</b> Displays the IP address of the projector.</p> <p><b>MAC Address</b> Displays the MAC address of the projector.</p> <p><b>Firmware Version</b> Shows the current firmware version.</p> <p><b>3X Fast Input</b></p>

# Maintenance

---

## Care of the projector

Do not attempt to disassemble any part of the projector. Contact your dealer if you need to replace any parts.

## Cleaning the lens

You can clean the dust-free glass lens if you notice any dirt or dust on its surface.

- Use a canister of compressed air to remove dust.
- Use a lens cleaning wipe, or a moist cloth with some detergent to clean away any dust or dirt on the dust-free glass.



**Note**

Do not apply any granule material on the dust-free glass.

## Cleaning the projector case

Before cleaning the case, please refer to the proper shutdown procedure described in “Switch off the projector” to shutdown the projector and unplug the power cable.

- To remove dirt or dust, wipe the case with a soft, lint-free cloth.
- To remove stubborn dirt or stains, moisten a piece of soft cloth with water and a neutral pH detergent. Then wipe the case.



**Note**

Never use wax, alcohol, benzene, thinners, or other chemical-based detergents. These can damage the case.

## Storing the projector

Follow the instructions below to store the projector for an extended time:

- Make sure the temperature and humidity of the storage area are within the recommended range for the projector. Please refer to “Specifications” or inquire your dealer for details of the recommended range.
- Retract the projector support pegs.
- Remove the battery from the remote control.
- Pack the projector in its original packaging or equivalent material.

## Transporting the projector

It is recommended that you ship the projector within its original packaging or equivalent material.

## LED Indicator

Projector status	Power indicator	Temp indicator	Lamp indicator
Stand-by mode	Green Flashing	Off	Off
Normally on	Green	Off	Off
Normal Operations	Green	Off	Off
Temperature Error 1	Green	Red Flashing	Orange
Temperature Error 2	Green	Red Flashing	Off
Fan Error 1	Green	Red Flashing	Green
Fan Error 2	Green	Red Flashing	Green Flashing
Fan Error 3 or 4	Green	Red Flashing	Orange Flashing
Color Wheel Error	Green	Off	Orange
Light bulb abnormal	Green	Off	Red
Heat dissipation state	Green	Green Flashing	Off

# Troubleshooting

---

## ② Projector is not shutting down

Cause	Remedy
There is no power from the power cable.	Plug one end of the power cable at the AC inlet of the projector and the other end in the power outlet. If the power outlet has a switch, make sure that it is switched on.
Attempting to turn the projector on again during the cooling process.	Wait until the cooling down process has completed.

## ② No picture

Cause	Remedy
Video source is not turned on or is not connected correctly.	Switch the video source on and check that the signal cable is connected correctly.
The projector is not correctly connected to the input signal device.	Check the connection.
The input signal has not been correctly selected.	Select the correct input signal by using the [Source] key on the projector or remote control.

## ② Blurred image

Cause	Remedy
The projection lens is not correctly focused.	Use the focus function to adjust lens focus.
The projector and the screen are not aligned properly.	Adjust projection angle and direction as well as the height of the projector where necessary.

## ② Remote control does not work

Cause	Remedy
The battery is out of power.	Replace the batteries.
There is an obstacle between the remote control and the projector.	Remove the obstacle.
You are too far away from the projector.	Stand within 8 meters (26 feet) of the projector.
The remote control does not match the remote control code of the projector.	Adjust the remote control code.

# Specifications

---

## Projector specifications



- All specifications are subject to change without notice.
- Not all projector models are available at your location.

Input Terminals		
1	VGA input (DB 15 pin)	x2
2	HDMI (v1.4 with audio )	x2
3	Video (RCA)	x1
4	Audio input (3.5mm mini jack)	x1
Output Terminals		
1	Audio output (3.5mm mini jack)	x1
2	USB-A 5V/1.5A	x1
3	Speaker	x1
4	VGA output	x1
Control Terminals		
1	RS232 (9 pin 1 type)	x1
2	USB cable (mini B type)	x1
3	LAN	x1

## Fuse specifications

The fuse number used on the power PCB board is: F1, and the specifications are: 250V, T6.3AH

## Dimensions

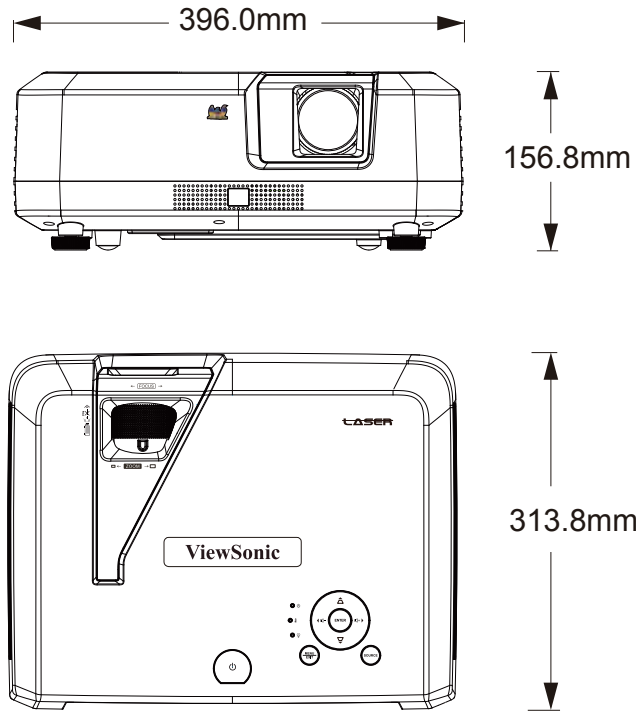

## Ceiling mount installation

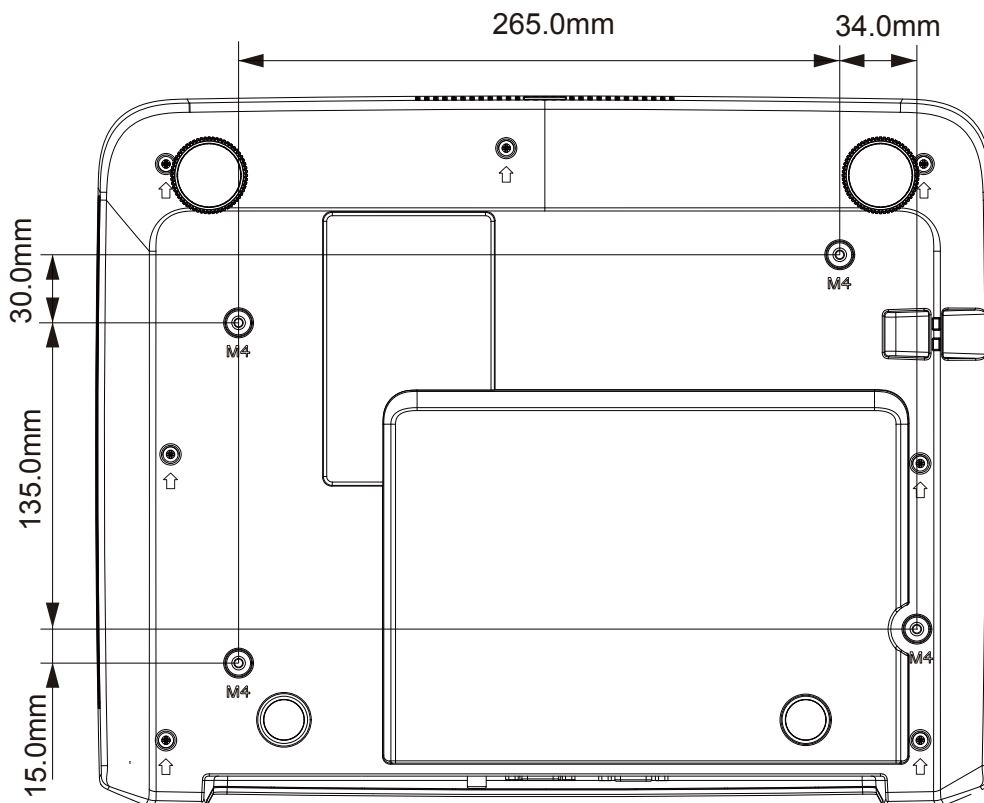

**Note:** It is recommended to use the M4L8 screw for fixing the projector using the M4 screw hole. (M4/ L8 x 4)

## Timing chart

Analog RGB			
Signal	Resolution (pixels)	Aspect Ratio	Refresh rate (Hz)
VGA	640x480	4:3	60/72/75/85
SVGA	800x600	4:3	60/72/75/85
XGA	1024x768	4:3	60/70/75/85
	1152x864	4:3	75
WXGA	1280x768	15:9	60
	1280x800	16:10	60/75/85
	1360x768	16:9	60
	1366x768	16:9	60
Quad-VGA	1280x960	4:3	60/85
SXGA	1280x1024	5:4	60
SXGA+	1400x1050	4:3	60
WXGA+	1440x900	16:10	60
UXGA	1600x1200	4:3	60
WSXGA+	1680x1050	16:10	60
HD	1280x720	16:9	60
MAC 13"	640x480	4:3	67
MAC 16"	832x624	4:3	75
MAC 19"	1024x768	4:3	75
MAC 21"	1152x870	4:3	75
HDTV (1080p)	1920x1080	16:9	60



HDMI			
Signal	Resolution (pixels)	Aspect Ratio	Refresh rate (Hz)
VGA	640x480	4:3	60
SVGA	800x600	4:3	60
XGA	1024x768	4:3	60
WXGA	1280x768	15:9	60
	1280x800	16:10	60
	1360x768	16:9	60
	1366x768	16:9	60
Quad-VGA	1280x960	4:3	60
SXGA	1280x1024	5:4	60
SXGA+	1400x1050	4:3	60
WXGA+	1440x900	16:10	60
WSXGA+	1680x1050	16:10	60
HDTV (1080p)	1920x1080	16:9	50/60
HDTV (1080i)	1920x1080	16:9	50/60
HDTV (720p)	1280x720	16:9	50/60
SDTV(480p)	720x480	4:3/16:9	60
SDTV(576p)	720x576	4:3/16:9	50
SDTV (480i)	720x480	4:3/16:9	60
SDTV (576i)	720x576	4:3/16:9	50

<b>3D (including HDMI signal)</b>			
Signal	Resolution (pixels)	Aspect Ratio	Refresh rate (Hz)
SVGA	800x600	4:3	60*/120
XGA	1024x768	4:3	60*/120
HD	1280x720	16:9	50*60*
WXGA	1280x800	16:9	60*
For Video Signal			
Signal	Resolution (pixels)	Aspect Ratio	Refresh rate (Hz)
SDTV (480i)**	720x480	4:3/16:9	60
 * 50 Hz and 60 Hz signals are supported for side by side, Top and Bottom, and Frame Sequential formats. ** The video signal (SDTV 480i) supports only the frame Sequential format.			

<b>HDMI 3D</b>			
Within frame packing formats			
Signal	Resolution (pixels)	Aspect Ratio	Refresh rate (Hz)
1080p	1920x1080	16:9	23.98/24
720p	1280x720	16:9	50/59.94/60
Within side by side formats			
Signal	Resolution (pixels)	Aspect Ratio	Refresh rate (Hz)
1080i	1920x1080	16:9	50/59.94/60
720p	1280x720	16:9	50/60
Within Top and Bottom formats			
Signal	Resolution (pixels)	Aspect Ratio	Refresh rate (Hz)
1080p	1920x1080	16:9	23.98/24
720p	1280x720	16:9	50/59.94/60

<b>Component video</b>			
Signal	Resolution (pixels)	Aspect Ratio	Refresh rate (Hz)
HDTV (1080p)	1920x1080	16:9	50/60
HDTV (1080i)	1920x1080	16:9	50/60
HDTV (720p)	1280x720	16:9	50/60
SDTV(480p)	720x480	4:3/16:9	60
SDTV(576p)	720x576	4:3/16:9	50
SDTV (480i)	720x480	4:3/16:9	60
SDTV (576i)	720x576	4:3/16:9	50

<b>Composite video</b>		
Signal	Aspect Ratio	Refresh rate (Hz)
NTSC	4:3	60
PAL	4:3	50
PAL60	4:3	60
SECAM	4:3	50

# ***Copyright information***

---

## **Copyright**

Copyright 2018 All rights reserved. No part of this publication may be reproduced, transmitted, transcribed, stored in a retrieval system or translated into any language or computer language, in any form or by any means, electronic, mechanical, magnetic, optical, chemical, manual or otherwise, without the prior written permission of ViewSonic.

## **Disclaimer**

ViewSonic does not make any statement or warranty, expressed or implied, for the merchantability and fitness for a particular purpose with respect to any contents within this manual. Additionally, ViewSonic reserves the right to revise and update the contents of this manual without notice.

\*DLP and Digital Micromirror Device (DMD) are trademarks of Texas Instruments. Other names would be the copyrights of the respective companies or organizations.

# Appendix

---

## IR control table

Button	Format	Byte 1	Byte 2	Byte 3	Byte 4
PgDn	NEC	X3	F4	05	FA
PgUp	NEC	X3	F4	06	F9
Blank	NEC	X3	F4	07	F8
Auto Sync	NEC	X3	F4	08	F7
Up	NEC	X3	F4	0B	F4
Down	NEC	X3	F4	0C	F3
Left	NEC	X3	F4	0E	F1
Right	NEC	X3	F4	0F	F0
Color Mode	NEC	X3	F4	10	EF
Mute	NEC	X3	F4	14	EB
Input	NEC	X3	F4	15	EA
Powering up	NEC	X3	F4	4F	A0
Power Off	NEC	X3	F4	4E	A1
Exit	NEC	X3	F4	28	D7
Eco mode	NEC	X3	F4	2B	D4
Menu	NEC	X3	F4	30	CF
Source	NEC	X3	F4	40	BF
Pattern	NEC	X3	F4	55	AA
Video	NEC	X3	F4	52	ad
HDMI	NEC	X3	F4	58	A7
Volume+	NEC	X3	F4	82	7D
Volume-	NEC	X3	F4	83	7C
Zoom+	NEC	X3	F4	67	98
Zoom-	NEC	X3	F4	68	97
Freeze	NEC	X3	F4	03	FC
Aspect	NEC	X3	F4	13	EC
COMP	NEC	X3	F4	41	BC
Information	NEC	X3	F4	97	68

# Address Code

Code 1	83F4
Code 2	93F4
Code 3	A3F4
Code 4	B3F4
Code 5	C3F4
Code 6	D3F4
Code 7	E3F4
Code 8	F3F4

## RS232 command table

<Pin assignment for this two end>

Pin	Description	Pin	Description
1	NC	2	RX
3	TX	4	NC
5	GND	6	NC
7	RTSZ	8	CTSZ
9	NC		

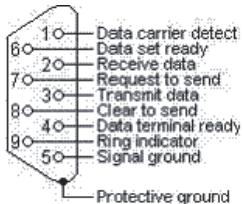

## <Interface>

RS-232 protocol	
Baud Rate	115200bps (default)
Data Length	8 bit
Parity check	None
Stop bit	1 bit
flow control	None

## <RS232 Command List>

The below table lists all RS232 commands frequently used:

No.	Function	Type	Action	Command	Response	The response of Query Read command
1	Power	Write	ON	0x06 0x14 0x00 0x04 0x00 0x34 0x11 0x00 0x00 0x5D	0x03 0x14 0x00 0x00 0x00 0x14	0x05 0x14 0x00 0x03 0x00 0x00 0x00 0x01 0x18
2	Power	Write	OFF	0x06 0x14 0x00 0x04 0x00 0x34 0x11 0x01 0x00 0x5E	0x03 0x14 0x00 0x00 0x00 0x14	0x05 0x14 0x00 0x03 0x00 0x00 0x00 0x00 0x17
3	Power	Read	Status	0x07 0x14 0x00 0x05 0x00 0x34 0x00 0x00 0x11 0x00 0x5E	0x05 0x14 0x00 0x03 0x00 0x00 0x00 0x01 0x18	
4	Projector Status	Read	Status  (Note 7)	0x07 0x14 0x00 0x05 0x00 0x34 0x00 0x00 0x11 0x26 0x84	Warm up :0x05 0x14 0x00 0x03 0x00 0x00 0x00 0x01 0x18 Cool down :0x05 0x14 0x00 0x03 0x00 0x00 0x00 0x03 0x1A Power On :0x05 0x14 0x00 0x03 0x00 0x00 0x00 0x02 0x19 Power Down :0x05 0x14 0x00 0x03 0x00 0x00 0x00 0x00 0x17	
5	Reset All Settings	Write	Reset All Settings	0x06 0x14 0x00 0x04 0x00 0x34 0x11 0x02 0x00 0x5F	0x03 0x14 0x00 0x00 0x00 0x14	
6	Reset Color Settings	Write	Reset Color Settings	0x06 0x14 0x00 0x04 0x00 0x34 0x11 0x2A 0x00 0x87	0x03 0x14 0x00 0x00 0x00 0x14	
7	Splash Screen	Write	Blue	0x06 0x14 0x00 0x04 0x00 0x34 0x11 0x0A 0x01 0x68	0x03 0x14 0x00 0x00 0x00 0x14	0x05 0x14 0x00 0x03 0x00 0x00 0x00 0x01 0x18
8	Splash Screen	Write	ViewSonic	0x06 0x14 0x00 0x04 0x00 0x34 0x11 0x0A 0x02 0x69	0x03 0x14 0x00 0x00 0x00 0x14	0x05 0x14 0x00 0x03 0x00 0x00 0x00 0x02 0x19
9	Splash Screen	Write	OFF	0x06 0x14 0x00 0x04 0x00 0x34 0x11 0x0A 0x04 0x6B	0x03 0x14 0x00 0x00 0x00 0x14	0x05 0x14 0x00 0x03 0x00 0x00 0x00 0x04 0x1B
10	Splash Screen	Read	Status	0x07 0x14 0x00 0x05 0x00 0x34 0x00 0x00 0x11 0x0A 0x68	0x05 0x14 0x00 0x03 0x00 0x00 0x00 0x02 0x19	
11	High Altitude Mode	Write	OFF	0x06 0x14 0x00 0x04 0x00 0x34 0x11 0x0C 0x00 0x69	0x03 0x14 0x00 0x00 0x00 0x14	0x05 0x14 0x00 0x03 0x00 0x00 0x00 0x00 0x17
12	High Altitude Mode	Write	ON	0x06 0x14 0x00 0x04 0x00 0x34 0x11 0x0C 0x01 0x6A	0x03 0x14 0x00 0x00 0x00 0x14	0x05 0x14 0x00 0x03 0x00 0x00 0x00 0x01 0x18
13	High Altitude Mode	Read	Status	0x07 0x14 0x00 0x05 0x00 0x34 0x00 0x00 0x11 0x0C 0x6A	0x05 0x14 0x00 0x03 0x00 0x00 0x00 0x00 0x17	
14	Light source Mode	Write	Normal	0x06 0x14 0x00 0x04 0x00 0x34 0x11 0x10 0x00 0x6D	0x03 0x14 0x00 0x00 0x00 0x14	0x05 0x14 0x00 0x03 0x00 0x00 0x00 0x00 0x17
15	Light source Mode	Write	Eco	0x06 0x14 0x00 0x04 0x00 0x34 0x11 0x10 0x01 0x6E	0x03 0x14 0x00 0x00 0x00 0x14	0x05 0x14 0x00 0x03 0x00 0x00 0x00 0x01 0x18
16	Light source Mode	Write	Custom 20	0x06 0x14 0x00 0x04 0x00 0x34 0x11 0x10 0x04 0x71	0x03 0x14 0x00 0x00 0x00 0x14	0x05 0x14 0x00 0x03 0x00 0x00 0x00 0x04 0x1B
17	Light source Mode	Write	Custom 40	0x06 0x14 0x00 0x04 0x00 0x34 0x11 0x10 0x05 0x72	0x03 0x14 0x00 0x00 0x00 0x14	0x05 0x14 0x00 0x03 0x00 0x00 0x00 0x05 0x1C
18	Light source Mode	Write	Custom 60	0x06 0x14 0x00 0x04 0x00 0x34 0x11 0x10 0x06 0x73	0x03 0x14 0x00 0x00 0x00 0x14	0x05 0x14 0x00 0x03 0x00 0x00 0x00 0x06 0x1D
19	Light source Mode	Write	Custom 80	0x06 0x14 0x00 0x04 0x00 0x34 0x11 0x10 0x07 0x74	0x03 0x14 0x00 0x00 0x00 0x14	0x05 0x14 0x00 0x03 0x00 0x00 0x00 0x07 0x1E
20	Light source Mode	Write	Custom 100	0x06 0x14 0x00 0x04 0x00 0x34 0x11 0x10 0x08 0x75	0x03 0x14 0x00 0x00 0x00 0x14	0x05 0x14 0x00 0x03 0x00 0x00 0x00 0x08 0x1F
21	Light source Mode	Read	Status	0x07 0x14 0x00 0x05 0x00 0x34 0x00 0x00 0x11 0x10 0x6E	0x05 0x14 0x00 0x03 0x00 0x00 0x00 0x00 0x17	
22	Message	Write	OFF	0x06 0x14 0x00 0x04 0x00 0x34 0x11 0x27 0x00 0x84	0x03 0x14 0x00 0x00 0x00 0x14	0x05 0x14 0x00 0x03 0x00 0x00 0x00 0x00 0x17
23	Message	Write	ON	0x06 0x14 0x00 0x04 0x00 0x34 0x11 0x27 0x01 0x85	0x03 0x14 0x00 0x00 0x00 0x14	0x05 0x14 0x00 0x03 0x00 0x00 0x00 0x01 0x18
24	Message	Read	Status	0x07 0x14 0x00 0x05 0x00 0x34 0x00 0x00 0x11 0x27 0x85	0x05 0x14 0x00 0x03 0x00 0x00 0x00 0x01 0x18	

No.	Function	Type	Action	Command	Response	The response of Query Read command
25	Projector Position	Write	Front Table	0x06 0x14 0x00 0x04 0x00 0x34 0x12 0x00 0x00 0x5E	0x03 0x14 0x00 0x00 0x00 0x14	0x05 0x14 0x00 0x03 0x00 0x00 0x00 0x00 0x17
26	Projector Position	Write	Rear Table	0x06 0x14 0x00 0x04 0x00 0x34 0x12 0x00 0x01 0x5F	0x03 0x14 0x00 0x00 0x00 0x14	0x05 0x14 0x00 0x03 0x00 0x00 0x00 0x01 0x18
27	Projector Position	Write	Rear Ceiling	0x06 0x14 0x00 0x04 0x00 0x34 0x12 0x00 0x02 0x60	0x03 0x14 0x00 0x00 0x00 0x14	0x05 0x14 0x00 0x03 0x00 0x00 0x00 0x02 0x19
28	Projector Position	Write	Front Ceiling	0x06 0x14 0x00 0x04 0x00 0x34 0x12 0x00 0x03 0x61	0x03 0x14 0x00 0x00 0x00 0x14	0x05 0x14 0x00 0x03 0x00 0x00 0x00 0x03 0x1A
29	Projector Position	Read	Status	0x07 0x14 0x00 0x05 0x00 0x34 0x00 0x00 0x12 0x00 0x5F	0x05 0x14 0x00 0x03 0x00 0x00 0x00 0x00 0x17	
30	3D Sync	Write	OFF	0x06 0x14 0x00 0x04 0x00 0x34 0x12 0x20 0x00 0x7E	0x03 0x14 0x00 0x00 0x00 0x14	0x05 0x14 0x00 0x03 0x00 0x00 0x00 0x00 0x17
31	3D Sync	Write	Auto	0x06 0x14 0x00 0x04 0x00 0x34 0x12 0x20 0x01 0x7F	0x03 0x14 0x00 0x00 0x00 0x14	0x05 0x14 0x00 0x03 0x00 0x00 0x00 0x01 0x18
32	3D Sync	Write	Frame Sequential	0x06 0x14 0x00 0x04 0x00 0x34 0x12 0x20 0x02 0x80	0x03 0x14 0x00 0x00 0x00 0x14	0x05 0x14 0x00 0x03 0x00 0x00 0x00 0x02 0x19
33	3D Sync	Write	Frame Packing	0x06 0x14 0x00 0x04 0x00 0x34 0x12 0x20 0x03 0x81	0x03 0x14 0x00 0x00 0x00 0x14	0x05 0x14 0x00 0x03 0x00 0x00 0x00 0x03 0x1A
34	3D Sync	Write	Top Bottom	0x06 0x14 0x00 0x04 0x00 0x34 0x12 0x20 0x04 0x82	0x03 0x14 0x00 0x00 0x00 0x14	0x05 0x14 0x00 0x03 0x00 0x00 0x00 0x04 0x1B
35	3D Sync	Write	Side by Side	0x06 0x14 0x00 0x04 0x00 0x34 0x12 0x20 0x05 0x83	0x03 0x14 0x00 0x00 0x00 0x14	0x05 0x14 0x00 0x03 0x00 0x00 0x00 0x05 0x1C
36	3D Sync	Read	Status	0x07 0x14 0x00 0x05 0x00 0x34 0x00 0x00 0x12 0x20 0x7F	0x05 0x14 0x00 0x03 0x00 0x00 0x00 0x00 0x17	
37	3D Sync nvert	Write	OFF	0x06 0x14 0x00 0x04 0x00 0x34 0x12 0x21 0x00 0x7F	0x03 0x14 0x00 0x00 0x00 0x14	0x05 0x14 0x00 0x03 0x00 0x00 0x00 0x00 0x17
38	3D Sync nvert	Write	ON	0x06 0x14 0x00 0x04 0x00 0x34 0x12 0x21 0x01 0x80	0x03 0x14 0x00 0x00 0x00 0x14	0x05 0x14 0x00 0x03 0x00 0x00 0x00 0x01 0x18
39	3D Sync nvert	Read	Status	0x07 0x14 0x00 0x05 0x00 0x34 0x00 0x00 0x12 0x21 0x80	0x05 0x14 0x00 0x03 0x00 0x00 0x00 0x00 0x17	
40	Contrast	Write	Decrease	0x06 0x14 0x00 0x04 0x00 0x34 0x12 0x02 0x00 0x60	0x03 0x14 0x00 0x00 0x00 0x14	
41	Contrast	Write	Increase	0x06 0x14 0x00 0x04 0x00 0x34 0x12 0x02 0x01 0x61	0x03 0x14 0x00 0x00 0x00 0x14	
42	Contrast I	Read	Get Value	0x07 0x14 0x00 0x05 0x00 0x34 0x00 0x00 0x12 0x02 0x61	0x05 0x14 0x00 0x04 0x00 0x00 0x00 0x00 0x18	Refer to value mapping table 3.2.2 (2 byte)
43	Brightness I	Write	Decrease	0x06 0x14 0x00 0x04 0x00 0x34 0x12 0x03 0x00 0x61	0x03 0x14 0x00 0x00 0x00 0x14	
44	Brightness I	Write	Increase	0x06 0x14 0x00 0x04 0x00 0x34 0x12 0x03 0x01 0x62	0x03 0x14 0x00 0x00 0x00 0x14	
45	Brightness	Read	Get Value	0x07 0x14 0x00 0x05 0x00 0x34 0x00 0x00 0x12 0x03 0x62	0x05 0x14 0x00 0x04 0x00 0x00 0x00 0x32 0x00 0x4A	Refer to value mapping table 3.2.2 (2 byte)
46	Aspect ratio	Write	Auto	0x06 0x14 0x00 0x04 0x00 0x34 0x12 0x04 0x00 0x62	0x03 0x14 0x00 0x00 0x00 0x14	0x05 0x14 0x00 0x03 0x00 0x00 0x00 0x00 0x17
47	Aspect ratio	Write	4:3	0x06 0x14 0x00 0x04 0x00 0x34 0x12 0x04 0x02 0x64	0x03 0x14 0x00 0x00 0x00 0x14	0x05 0x14 0x00 0x03 0x00 0x00 0x00 0x02 0x19
48	Aspect ratio	Write	16:9	0x06 0x14 0x00 0x04 0x00 0x34 0x12 0x04 0x03 0x65	0x03 0x14 0x00 0x00 0x00 0x14	0x05 0x14 0x00 0x03 0x00 0x00 0x00 0x03 0x1A
49	Aspect ratio	Write	16:10	0x06 0x14 0x00 0x04 0x00 0x34 0x12 0x04 0x04 0x66	0x03 0x14 0x00 0x00 0x00 0x14	0x05 0x14 0x00 0x03 0x00 0x00 0x00 0x04 0x1B
50	Aspect ratio	Write	Native	0x06 0x14 0x00 0x04 0x00 0x34 0x12 0x04 0x09 0x6B	0x03 0x14 0x00 0x00 0x00 0x14	0x05 0x14 0x00 0x03 0x00 0x00 0x00 0x09 0x20
51	Aspect ratio	Write	Cycle	0x06 0x14 0x00 0x04 0x00 0x34 0x13 0x31 0x00 0x90	0x03 0x14 0x00 0x00 0x00 0x14	
52	Aspect ratio	Read	Get Value	0x07 0x14 0x00 0x05 0x00 0x34 0x00 0x00 0x12 0x04 0x63	0x05 0x14 0x00 0x03 0x00 0x00 0x00 0x00 0x17	
53	Auto Adjust	Write	Execute	0x06 0x14 0x00 0x04 0x00 0x34 0x12 0x05 0x00 0x63	0x03 0x14 0x00 0x00 0x00 0x14	Note 6.
54	Horizontal position	Write	Shift Right	0x06 0x14 0x00 0x04 0x00 0x34 0x12 0x06 0x01 0x65	0x03 0x14 0x00 0x00 0x00 0x14	



No.	Function	Type	Action	Command	Response	The response of Query Read command
55	Horizontal position	Write	Shift Left	0x06 0x14 0x00 0x04 0x00 0x34 0x12 0x06 0x00 0x64	0x03 0x14 0x00 0x00 0x00 0x14	
56	Horizontal position	Read	Get Value	0x07 0x14 0x00 0x05 0x00 0x34 0x00 0x00 0x12 0x06 0x65	0x05 0x14 0x00 0x03 0x00 0x00 0x00 0x00 0x17	Refer to value mapping table 3.2.1 (1byte)
57	Vertical position	Write	Shift Up	0x06 0x14 0x00 0x04 0x00 0x34 0x12 0x07 0x00 0x65	0x03 0x14 0x00 0x00 0x00 0x14	
58	Vertical position	Write	Shift Down	0x06 0x14 0x00 0x04 0x00 0x34 0x12 0x07 0x01 0x66	0x03 0x14 0x00 0x00 0x00 0x14	
59	Vertical position	Read	Get Value	0x07 0x14 0x00 0x05 0x00 0x34 0x00 0x00 0x12 0x07 0x66	0x05 0x14 0x00 0x03 0x00 0x00 0x00 0x00 0x17	Refer to value mapping table 3.2.1 (1byte)
60	Color emperature	Write	Warm	0x06 0x14 0x00 0x04 0x00 0x34 0x12 0x08 0x00 0x66	0x03 0x14 0x00 0x00 0x00 0x14	0x05 0x14 0x00 0x03 0x00 0x00 0x00 0x00 0x17
61	Color emperature	Write	Normal	0x06 0x14 0x00 0x04 0x00 0x34 0x12 0x08 0x01 0x67	0x03 0x14 0x00 0x00 0x00 0x14	0x05 0x14 0x00 0x03 0x00 0x00 0x00 0x01 0x18
62	Color emperature	Write	Cool	0x06 0x14 0x00 0x04 0x00 0x34 0x12 0x08 0x03 0x69	0x03 0x14 0x00 0x00 0x00 0x14	0x05 0x14 0x00 0x03 0x00 0x00 0x00 0x03 0x1A
63	Color emperature	Read	Get Value	0x07 0x14 0x00 0x05 0x00 0x34 0x00 0x00 0x12 0x08 0x67	0x05 0x14 0x00 0x03 0x00 0x00 0x00 0x00 0x17	
64	Blank	Write	ON	0x06 0x14 0x00 0x04 0x00 0x34 0x12 0x09 0x01 0x68	0x03 0x14 0x00 0x00 0x00 0x14	0x05 0x14 0x00 0x03 0x00 0x00 0x00 0x01 0x18
65	Blank t	Write	OFF	0x06 0x14 0x00 0x04 0x00 0x34 0x12 0x09 0x00 0x67	0x03 0x14 0x00 0x00 0x00 0x14	0x05 0x14 0x00 0x03 0x00 0x00 0x00 0x00 0x17
66	Blank t	Read	Status	0x07 0x14 0x00 0x05 0x00 0x34 0x00 0x00 0x12 0x09 0x68	0x05 0x14 0x00 0x03 0x00 0x00 0x00 0x00 0x17	
67	Keystone-V ertical	Write	Decrease	0x06 0x14 0x00 0x04 0x00 0x34 0x12 0x0A 0x00 0x68	0x03 0x14 0x00 0x00 0x00 0x14	
68	Keystone-V ertical	Write	Increase	0x06 0x14 0x00 0x04 0x00 0x34 0x12 0x0A 0x01 0x69	0x03 0x14 0x00 0x00 0x00 0x14	
69	Keystone-V ertical	Read	Get value	0x07 0x14 0x00 0x05 0x00 0x34 0x00 0x00 0x12 0x0A 0x69	0x05 0x14 0x00 0x03 0x00 0x00 0x00 0x00 0x17	Refer to value mapping table 3.2.1 (1byte)
70	Keystone-H orizontal	Write	Decrease	0x06 0x14 0x00 0x04 0x00 0x34 0x11 0x31 0x00 0x8E	0x03 0x14 0x00 0x00 0x00 0x14	
71	Keystone-H orizontal	Write	Increase	0x06 0x14 0x00 0x04 0x00 0x34 0x11 0x31 0x01 0x8F	0x03 0x14 0x00 0x00 0x00 0x14	
72	Keystone-H orizontal	Read	Get value	0x07 0x14 0x00 0x05 0x00 0x34 0x00 0x00 0x11 0x31 0x8F	0x05 0x14 0x00 0x03 0x00 0x00 0x00 0x00 0x17	Refer to value mapping table 3.2.1 (1byte)
73	Color mode	Write	Brightest	0x06 0x14 0x00 0x04 0x00 0x34 0x12 0x0B 0x00 0x69	0x03 0x14 0x00 0x00 0x00 0x14	0x05 0x14 0x00 0x03 0x00 0x00 0x00 0x00 0x17
74	Color mode	Write	Movie	0x06 0x14 0x00 0x04 0x00 0x34 0x12 0x0B 0x01 0x6A	0x03 0x14 0x00 0x00 0x00 0x14	0x05 0x14 0x00 0x03 0x00 0x00 0x00 0x08 0x1F
75	Color mode	Write	Sports	0x06 0x14 0x00 0x04 0x00 0x34 0x12 0x0B 0x11 0x7A	0x03 0x14 0x00 0x00 0x00 0x14	0x05 0x14 0x00 0x03 0x00 0x00 0x00 0x11 0x28
76	Color mode	Write	Gaming	0x06 0x14 0x00 0x04 0x00 0x34 0x12 0x0B 0x12 0x7B	0x03 0x14 0x00 0x00 0x00 0x14	0x05 0x14 0x00 0x03 0x00 0x00 0x00 0x12 0x29
77	Color mode	Write	Presentation	0x06 0x14 0x00 0x04 0x00 0x34 0x12 0x0B 0x14 0x7D	0x03 0x14 0x00 0x00 0x00 0x14	0x05 0x14 0x00 0x03 0x00 0x00 0x00 0x14 0x2B
78	Color mode	Read	Status	0x07 0x14 0x00 0x05 0x00 0x34 0x00 0x00 0x12 0x0B 0x6A	0x05 0x14 0x00 0x03 0x00 0x00 0x00 0x00 0x17	
79	Reset current color settings	Write	Reset	0x06 0x14 0x00 0x04 0x00 0x34 0x11 0x2A 0x00 0x87	0x03 0x14 0x00 0x00 0x00 0x14	
80	Primary Color	Write	R	0x06 0x14 0x00 0x04 0x00 0x34 0x12 0x10 0x00 0x6E	0x03 0x14 0x00 0x00 0x00 0x14	0x05 0x14 0x00 0x03 0x00 0x00 0x00 0x00 0x17
81	Primary Color	Write	G	0x06 0x14 0x00 0x04 0x00 0x34 0x12 0x10 0x01 0x6F	0x03 0x14 0x00 0x00 0x00 0x14	0x05 0x14 0x00 0x03 0x00 0x00 0x00 0x01 0x18
82	Primary Color	Write	B	0x06 0x14 0x00 0x04 0x00 0x34 0x12 0x10 0x02 0x70	0x03 0x14 0x00 0x00 0x00 0x14	0x05 0x14 0x00 0x03 0x00 0x00 0x00 0x02 0x19
83	Primary Color	Write	C	0x06 0x14 0x00 0x04 0x00 0x34 0x12 0x10 0x03 0x71	0x03 0x14 0x00 0x00 0x00 0x14	0x05 0x14 0x00 0x03 0x00 0x00 0x00 0x03 0x1A
84	Primary Color	Write	M	0x06 0x14 0x00 0x04 0x00 0x34 0x12 0x10 0x04 0x72	0x03 0x14 0x00 0x00 0x00 0x14	0x05 0x14 0x00 0x03 0x00 0x00 0x00 0x04 0x1B

No.	Function	Type	Action	Command	Response	The response of Query Read command
85	Primary Color	Write	Y	0x06 0x14 0x00 0x04 0x00 0x34 0x12 0x10 0x05 0x73	0x03 0x14 0x00 0x00 0x00 0x14	0x05 0x14 0x00 0x03 0x00 0x00 0x00 0x05 0x1C
86	Primary Color	Read	Status	0x07 0x14 0x00 0x05 0x00 0x34 0x00 0x00 0x12 0x10 0x6F	0x05 0x14 0x00 0x04 0x00 0x00 0x00 0x00 0x00 0x18	
87	Hue / Tint	Write	Decrease	0x06 0x14 0x00 0x04 0x00 0x34 0x12 0x11 0x00 0x6F	0x03 0x14 0x00 0x00 0x00 0x14	
88	Hue / Tint	Write	Increase	0x06 0x14 0x00 0x04 0x00 0x34 0x12 0x11 0x01 0x70	0x03 0x14 0x00 0x00 0x00 0x14	
89	Hue / Tint	Read	Get value	0x07 0x14 0x00 0x05 0x00 0x34 0x00 0x00 0x12 0x11 0x70	0x05 0x14 0x00 0x04 0x00 0x00 0x00 0x00 0x00 0x18	Refer to value mapping table 3.2.2 (2 byte)
90	Saturation	Write	Decrease	0x06 0x14 0x00 0x04 0x00 0x34 0x12 0x12 0x00 0x70	0x03 0x14 0x00 0x00 0x00 0x14	
91	Saturation	Write	Increase	0x06 0x14 0x00 0x04 0x00 0x34 0x12 0x12 0x01 0x71	0x03 0x14 0x00 0x00 0x00 0x14	
92	Saturation	Read	Get value	0x07 0x14 0x00 0x05 0x00 0x34 0x00 0x00 0x12 0x12 0x71	0x05 0x14 0x00 0x04 0x00 0x00 0x00 0x00 0x00 0x18	Refer to value mapping table 3.2.2 (2 byte)
93	Gain	Write	Decrease	0x06 0x14 0x00 0x04 0x00 0x34 0x12 0x13 0x00 0x71	0x03 0x14 0x00 0x00 0x00 0x14	
94	Gain	Write	Increase	0x06 0x14 0x00 0x04 0x00 0x34 0x12 0x13 0x01 0x72	0x03 0x14 0x00 0x00 0x00 0x14	
95	Gain	Read	Get value	0x07 0x14 0x00 0x05 0x00 0x34 0x00 0x00 0x12 0x13 0x72	0x05 0x14 0x00 0x04 0x00 0x00 0x00 0x00 0x00 0x18	Refer to value mapping table 3.2.2 (2 byte)
96	Sharpness	Write	Decrease	0x06 0x14 0x00 0x04 0x00 0x34 0x12 0x0E 0x00 0x6C	0x03 0x14 0x00 0x00 0x00 0x14	
97	Sharpness	Write	Increase	0x06 0x14 0x00 0x04 0x00 0x34 0x12 0x0E 0x01 0x6D	0x03 0x14 0x00 0x00 0x00 0x14	
98	Sharpness	Read	Get value	0x07 0x14 0x00 0x05 0x00 0x34 0x00 0x00 0x12 0x0E 0x6D	0x05 0x14 0x00 0x04 0x00 0x00 0x00 0x00 0x00 0x18	Refer to value mapping table 3.2.2 (2 byte)
99	Freeze	Write	ON	0x06 0x14 0x00 0x04 0x00 0x34 0x13 0x00 0x01 0x60	0x03 0x14 0x00 0x00 0x00 0x14	0x05 0x14 0x00 0x03 0x00 0x00 0x00 0x01 0x18
100	Freeze	Write	OFF	0x06 0x14 0x00 0x04 0x00 0x34 0x13 0x00 0x00 0x5F	0x03 0x14 0x00 0x00 0x00 0x14	0x05 0x14 0x00 0x03 0x00 0x00 0x00 0x00 0x00 0x17
101	Freeze	Read	Status	0x07 0x14 0x00 0x05 0x00 0x34 0x00 0x00 0x13 0x00 0x60	0x05 0x14 0x00 0x03 0x00 0x00 0x00 0x00 0x00 0x17	Refer to value mapping table 3.2.1 (1byte)
102	Source input	Write	D-Sub / Comp. 1	0x06 0x14 0x00 0x04 0x00 0x34 0x13 0x01 0x00 0x60	0x03 0x14 0x00 0x00 0x00 0x14	0x05 0x14 0x00 0x03 0x00 0x00 0x00 0x00 0x00 0x17
103	Source input	Write	D-Sub / Comp. 2	0x06 0x14 0x00 0x04 0x00 0x34 0x13 0x01 0x08 0x68	0x03 0x14 0x00 0x00 0x00 0x14	0x05 0x14 0x00 0x03 0x00 0x00 0x00 0x08 0x1F
104	Source input	Write	HDMI 1	0x06 0x14 0x00 0x04 0x00 0x34 0x13 0x01 0x03 0x63	0x03 0x14 0x00 0x00 0x00 0x14	0x05 0x14 0x00 0x03 0x00 0x00 0x00 0x03 0x1A
105	Source input	Write	HDMI 2	0x06 0x14 0x00 0x04 0x00 0x34 0x13 0x01 0x07 0x67	0x03 0x14 0x00 0x00 0x00 0x14	0x05 0x14 0x00 0x03 0x00 0x00 0x00 0x07 0x1E
106	Source input	Write	Composite Video	0x06 0x14 0x00 0x04 0x00 0x34 0x13 0x01 0x05 0x65	0x03 0x14 0x00 0x00 0x00 0x14	0x05 0x14 0x00 0x03 0x00 0x00 0x00 0x05 0x1C
107	Source input	Write	S-Video	0x06 0x14 0x00 0x04 0x00 0x34 0x13 0x01 0x06 0x66	0x03 0x14 0x00 0x00 0x00 0x14	0x05 0x14 0x00 0x03 0x00 0x00 0x00 0x06 0x1D
108	Source input	Read	Status	0x07 0x14 0x00 0x05 0x00 0x34 0x00 0x00 0x13 0x01 0x61	0x05 0x14 0x00 0x03 0x00 0x00 0x00 0x00 0x00 0x17	
109	Quick Auto Search	Write	ON	0x06 0x14 0x00 0x04 0x00 0x34 0x13 0x02 0x01 0x62	0x03 0x14 0x00 0x00 0x00 0x14	0x05 0x14 0x00 0x03 0x00 0x00 0x00 0x01 0x18
110	Quick Auto Search	Write	OFF	0x06 0x14 0x00 0x04 0x00 0x34 0x13 0x02 0x00 0x61	0x03 0x14 0x00 0x00 0x00 0x14	0x05 0x14 0x00 0x03 0x00 0x00 0x00 0x00 0x00 0x17
111	Quick Auto Search	Read	Status	0x07 0x14 0x00 0x05 0x00 0x34 0x00 0x00 0x13 0x02 0x62	0x05 0x14 0x00 0x03 0x00 0x00 0x00 0x00 0x01 0x18	
112	Mute	Write	ON	0x06 0x14 0x00 0x04 0x00 0x34 0x14 0x00 0x01 0x61	0x03 0x14 0x00 0x00 0x00 0x14	0x05 0x14 0x00 0x03 0x00 0x00 0x00 0x01 0x18
113	Mute	Write	OFF	0x06 0x14 0x00 0x04 0x00 0x34 0x14 0x00 0x00 0x60	0x03 0x14 0x00 0x00 0x00 0x14	0x05 0x14 0x00 0x03 0x00 0x00 0x00 0x00 0x00 0x17
114	Mute	Read	Status	0x07 0x14 0x00 0x05 0x00 0x34 0x00 0x00 0x14 0x00 0x61	0x05 0x14 0x00 0x03 0x00 0x00 0x00 0x00 0x00 0x17	Note 6.

No.	Function	Type	Action	Command	Response	The response of Query Read command
115	Volume	Write	Increase	0x06 0x14 0x00 0x04 0x00 0x34 0x14 0x01 0x00 0x61	0x03 0x14 0x00 0x00 0x00 0x14	
116	Volume	Write	Decrease	0x06 0x14 0x00 0x04 0x00 0x34 0x14 0x02 0x00 0x62	0x03 0x14 0x00 0x00 0x00 0x14	
117	Volume	Write	Write Value	0x06 0x14 0x00 0x04 0x00 0x34 0x13 0x2A 0x11 0x9A	0x03 0x14 0x00 0x00 0x00 0x14	
118	Volume	Read	Get Value	0x07 0x14 0x00 0x05 0x00 0x34 0x00 0x00 0x14 0x03 0x64	0x05 0x14 0x00 0x03 0x00 0x00 0x00 0x01 0x18	Refer to value mapping table 3.2.1 (1byte)
119	Language	Write	English	0x06 0x14 0x00 0x04 0x00 0x34 0x15 0x00 0x00 0x61	0x03 0x14 0x00 0x00 0x00 0x14	0x05 0x14 0x00 0x03 0x00 0x00 0x00 0x00 0x17
120	Language	Write	Français	0x06 0x14 0x00 0x04 0x00 0x34 0x15 0x00 0x01 0x62	0x03 0x14 0x00 0x00 0x00 0x14	0x05 0x14 0x00 0x03 0x00 0x00 0x00 0x01 0x18
121	Language	Write	Deutsch	0x06 0x14 0x00 0x04 0x00 0x34 0x15 0x00 0x02 0x63	0x03 0x14 0x00 0x00 0x00 0x14	0x05 0x14 0x00 0x03 0x00 0x00 0x00 0x02 0x19
122	Language	Write	Italiano	0x06 0x14 0x00 0x04 0x00 0x34 0x15 0x00 0x03 0x64	0x03 0x14 0x00 0x00 0x00 0x14	0x05 0x14 0x00 0x03 0x00 0x00 0x00 0x03 0x1A
123	Language	Write	Español	0x06 0x14 0x00 0x04 0x00 0x34 0x15 0x00 0x04 0x65	0x03 0x14 0x00 0x00 0x00 0x14	0x05 0x14 0x00 0x03 0x00 0x00 0x00 0x04 0x1B
124	Language	Write	РУССКИЙ	0x06 0x14 0x00 0x04 0x00 0x34 0x15 0x00 0x05 0x66	0x03 0x14 0x00 0x00 0x00 0x14	0x05 0x14 0x00 0x03 0x00 0x00 0x00 0x05 0x1C
125	Language	Write	繁體中文	0x06 0x14 0x00 0x04 0x00 0x34 0x15 0x00 0x06 0x67	0x03 0x14 0x00 0x00 0x00 0x14	0x05 0x14 0x00 0x03 0x00 0x00 0x00 0x06 0x1D
126	Language	Write	简体中文	0x06 0x14 0x00 0x04 0x00 0x34 0x15 0x00 0x07 0x68	0x03 0x14 0x00 0x00 0x00 0x14	0x05 0x14 0x00 0x03 0x00 0x00 0x00 0x07 0x1E
127	Language	Write	日本語	0x06 0x14 0x00 0x04 0x00 0x34 0x15 0x00 0x08 0x69	0x03 0x14 0x00 0x00 0x00 0x14	0x05 0x14 0x00 0x03 0x00 0x00 0x00 0x08 0x1F
128	Language	Write	한국어	0x06 0x14 0x00 0x04 0x00 0x34 0x15 0x00 0x09 0x6A	0x03 0x14 0x00 0x00 0x00 0x14	0x05 0x14 0x00 0x03 0x00 0x00 0x00 0x09 0x20
129	Language	Write	Swedish	0x06 0x14 0x00 0x04 0x00 0x34 0x15 0x00 0x0a 0x6B	0x03 0x14 0x00 0x00 0x00 0x14	0x05 0x14 0x00 0x03 0x00 0x00 0x00 0x0a 0x21
130	Language	Write	Dutch	0x06 0x14 0x00 0x04 0x00 0x34 0x15 0x00 0x0b 0x6C	0x03 0x14 0x00 0x00 0x00 0x14	0x05 0x14 0x00 0x03 0x00 0x00 0x00 0x0b 0x22
131	Language	Write	Turkish	0x06 0x14 0x00 0x04 0x00 0x34 0x15 0x00 0x0c 0x6D	0x03 0x14 0x00 0x00 0x00 0x14	0x05 0x14 0x00 0x03 0x00 0x00 0x00 0x0c 0x23
132	Language	Write	Czech	0x06 0x14 0x00 0x04 0x00 0x34 0x15 0x00 0x0d 0x6E	0x03 0x14 0x00 0x00 0x00 0x14	0x05 0x14 0x00 0x03 0x00 0x00 0x00 0x0d 0x24
133	Language	Write	Portugese	0x06 0x14 0x00 0x04 0x00 0x34 0x15 0x00 0x0e 0x6F	0x03 0x14 0x00 0x00 0x00 0x14	0x05 0x14 0x00 0x03 0x00 0x00 0x00 0x0e 0x25
134	Language	Write	Thai	0x06 0x14 0x00 0x04 0x00 0x34 0x15 0x00 0x0f 0x70	0x03 0x14 0x00 0x00 0x00 0x14	0x05 0x14 0x00 0x03 0x00 0x00 0x00 0x0f 0x26
135	Language	Write	Polish	0x06 0x14 0x00 0x04 0x00 0x34 0x15 0x00 0x10 0x71	0x03 0x14 0x00 0x00 0x00 0x14	0x05 0x14 0x00 0x03 0x00 0x00 0x00 0x10 0x27
136	Language	Write	Finnish	0x06 0x14 0x00 0x04 0x00 0x34 0x15 0x00 0x11 0x72	0x03 0x14 0x00 0x00 0x00 0x14	0x05 0x14 0x00 0x03 0x00 0x00 0x00 0x11 0x28
137	Language	Write	Arabic	0x06 0x14 0x00 0x04 0x00 0x34 0x15 0x00 0x12 0x73	0x03 0x14 0x00 0x00 0x00 0x14	0x05 0x14 0x00 0x03 0x00 0x00 0x00 0x12 0x29
138	Language	Write	Indonesia	0x06 0x14 0x00 0x04 0x00 0x34 0x15 0x00 0x13 0x74	0x03 0x14 0x00 0x00 0x00 0x14	0x05 0x14 0x00 0x03 0x00 0x00 0x00 0x13 0x2A
139	Language	Write	Hindi	0x06 0x14 0x00 0x04 0x00 0x34 0x15 0x00 0x14 0x75	0x03 0x14 0x00 0x00 0x00 0x14	0x05 0x14 0x00 0x03 0x00 0x00 0x00 0x14 0x2B
140	Language	Write	Vie	0x06 0x14 0x00 0x04 0x00 0x34 0x15 0x00 0x15 0x76	0x03 0x14 0x00 0x00 0x00 0x14	0x05 0x14 0x00 0x03 0x00 0x00 0x00 0x15 0x2C
141	Language	Read	Status	0x07 0x14 0x00 0x05 0x00 0x34 0x00 0x00 0x15 0x00 0x62	0x05 0x14 0x00 0x03 0x00 0x00 0x00 0x00 0x00 0x17	
142	HDMI Format	Write	RGB	0x06 0x14 0x00 0x04 0x00 0x34 0x11 0x28 0x00 0x85	0x03 0x14 0x00 0x00 0x00 0x14	0x05 0x14 0x00 0x03 0x00 0x00 0x00 0x00 0x17
143	HDMI Format	Write	YUV	0x06 0x14 0x00 0x04 0x00 0x34 0x11 0x28 0x01 0x86	0x03 0x14 0x00 0x00 0x00 0x14	0x05 0x14 0x00 0x03 0x00 0x00 0x00 0x01 0x18
144	HDMI Format	Write	Auto	0x06 0x14 0x00 0x04 0x00 0x34 0x11 0x28 0x02 0x87	0x03 0x14 0x00 0x00 0x00 0x14	0x05 0x14 0x00 0x03 0x00 0x00 0x00 0x02 0x19

No.	Function	Type	Action	Command	Response	The response of Query Read command
145	HDMI Format	Read	Status	0x07 0x14 0x00 0x05 0x00 0x34 0x00 0x00 0x11 0x28 0x86	0x05 0x14 0x00 0x03 0x00 0x00 0x00 0x00 0x17	
146	HDMI Range	Write	Enhanced	0x06 0x14 0x00 0x04 0x00 0x34 0x11 0x29 0x00 0x86	0x03 0x14 0x00 0x00 0x00 0x14	0x05 0x14 0x00 0x03 0x00 0x00 0x00 0x00 0x17 See note 4
147	HDMI Range	Write	Normal	0x06 0x14 0x00 0x04 0x00 0x34 0x11 0x29 0x01 0x87	0x03 0x14 0x00 0x00 0x00 0x14	0x05 0x14 0x00 0x03 0x00 0x00 0x00 0x01 0x18 See note 4
148	HDMI Range	Write	Auto	0x06 0x14 0x00 0x04 0x00 0x34 0x11 0x29 0x02 0x88	0x03 0x14 0x00 0x00 0x00 0x14	0x05 0x14 0x00 0x03 0x00 0x00 0x00 0x02 0x19
149	HDMI Range	Read	Status	0x07 0x14 0x00 0x05 0x00 0x34 0x00 0x00 0x11 0x29 0x87	0x05 0x14 0x00 0x03 0x00 0x00 0x00 0x00 0x17	
150	CEC	Write	OFF	0x06 0x14 0x00 0x04 0x00 0x34 0x11 0x2B 0x00 0x88	0x03 0x14 0x00 0x00 0x00 0x14	0x05 0x14 0x00 0x03 0x00 0x00 0x00 0x00 0x17
151	CEC	Write	ON	0x06 0x14 0x00 0x04 0x00 0x34 0x11 0x2B 0x01 0x89	0x03 0x14 0x00 0x00 0x00 0x14	0x05 0x14 0x00 0x03 0x00 0x00 0x00 0x01 0x18
152	CEC	Read	Status	0x07 0x14 0x00 0x05 0x00 0x34 0x00 0x00 0x11 0x2B 0x89	0x05 0x14 0x00 0x03 0x00 0x00 0x00 0x00 0x17	
153	Error status	Read	Status	0x07 0x14 0x00 0x05 0x00 0x34 0x00 0x00 0x0C 0x0D 0x66	0x05 0x14 0x00 0x16 0x00 0x00 0x00 0x01 0x02 0x03 0x04 0x05 0x06 0x07 0x08 0x09 0x0A 0x0B 0x0C 0x0D 0x0E 0x0F 0x10 0x11 0x01 0x02 0x03 0x04 0x01 0x01 0x02 0xFF	See note 2
154	Brilliant Color	Write	OFF	0x06 0x14 0x00 0x04 0x00 0x34 0x12 0x0F 0x00 0x6D	0x03 0x14 0x00 0x00 0x00 0x14	0x05 0x14 0x00 0x03 0x00 0x00 0x00 0x00 0x17
155	Brilliant Color	Write	Color 1	0x06 0x14 0x00 0x04 0x00 0x34 0x12 0x0F 0x01 0x6E	0x03 0x14 0x00 0x00 0x00 0x14	0x05 0x14 0x00 0x03 0x00 0x00 0x00 0x01 0x18
156	Brilliant Color	Write	Color 2	0x06 0x14 0x00 0x04 0x00 0x34 0x12 0x0F 0x02 0x6F	0x03 0x14 0x00 0x00 0x00 0x14	0x05 0x14 0x00 0x03 0x00 0x00 0x00 0x02 0x19
157	Brilliant Color	Write	Color 3	0x06 0x14 0x00 0x04 0x00 0x34 0x12 0x0F 0x03 0x70	0x03 0x14 0x00 0x00 0x00 0x14	0x05 0x14 0x00 0x03 0x00 0x00 0x00 0x03 0x1A
158	Brilliant Color	Write	Color 4	0x06 0x14 0x00 0x04 0x00 0x34 0x12 0x0F 0x04 0x71	0x03 0x14 0x00 0x00 0x00 0x14	0x05 0x14 0x00 0x03 0x00 0x00 0x00 0x04 0x1B
159	Brilliant Color	Write	Color 5	0x06 0x14 0x00 0x04 0x00 0x34 0x12 0x0F 0x05 0x72	0x03 0x14 0x00 0x00 0x00 0x14	0x05 0x14 0x00 0x03 0x00 0x00 0x00 0x05 0x1C
160	Brilliant Color	Write	Color 6	0x06 0x14 0x00 0x04 0x00 0x34 0x12 0x0F 0x06 0x73	0x03 0x14 0x00 0x00 0x00 0x14	0x05 0x14 0x00 0x03 0x00 0x00 0x00 0x06 0x1D
161	Brilliant Color	Write	Color 7	0x06 0x14 0x00 0x04 0x00 0x34 0x12 0x0F 0x07 0x74	0x03 0x14 0x00 0x00 0x00 0x14	0x05 0x14 0x00 0x03 0x00 0x00 0x00 0x07 0x1E
162	Brilliant Color	Write	Color 8	0x06 0x14 0x00 0x04 0x00 0x34 0x12 0x0F 0x08 0x75	0x03 0x14 0x00 0x00 0x00 0x14	0x05 0x14 0x00 0x03 0x00 0x00 0x00 0x08 0x1F
163	Brilliant Color	Write	Color 9	0x06 0x14 0x00 0x04 0x00 0x34 0x12 0x0F 0x09 0x76	0x03 0x14 0x00 0x00 0x00 0x14	0x05 0x14 0x00 0x03 0x00 0x00 0x00 0x09 0x20
164	Brilliant Color	Write	Color 10	0x06 0x14 0x00 0x04 0x00 0x34 0x12 0x0F 0x0A 0x77	0x03 0x14 0x00 0x00 0x00 0x14	0x05 0x14 0x00 0x03 0x00 0x00 0x00 0x0A 0x21
165	Brilliant Color	Read	Status	0x07 0x14 0x00 0x05 0x00 0x34 0x00 0x00 0x12 0x0F 0x6E	0x05 0x14 0x00 0x03 0x00 0x00 0x00 0x00 0x17	
166	Remote Control Code	Write	code 1	0x06 0x14 0x00 0x04 0x00 0x34 0x0C 0x48 0x00 0xA0	0x03 0x14 0x00 0x00 0x00 0x14	0x05 0x14 0x00 0x03 0x00 0x00 0x00 0x00 0x17
167	Remote Control Code	Write	code 2	0x06 0x14 0x00 0x04 0x00 0x34 0x0C 0x48 0x01 0xA1	0x03 0x14 0x00 0x00 0x00 0x14	0x05 0x14 0x00 0x03 0x00 0x00 0x00 0x01 0x18
168	Remote Control Code	Write	code 3	0x06 0x14 0x00 0x04 0x00 0x34 0x0C 0x48 0x02 0xA2	0x03 0x14 0x00 0x00 0x00 0x14	0x05 0x14 0x00 0x03 0x00 0x00 0x00 0x02 0x19
169	Remote Control Code	Write	code 4	0x06 0x14 0x00 0x04 0x00 0x34 0x0C 0x48 0x03 0xA3	0x03 0x14 0x00 0x00 0x00 0x14	0x05 0x14 0x00 0x03 0x00 0x00 0x00 0x03 0x1A
170	Remote Control Code	Write	code 5	0x06 0x14 0x00 0x04 0x00 0x34 0x0C 0x48 0x04 0xA4	0x03 0x14 0x00 0x00 0x00 0x14	0x05 0x14 0x00 0x03 0x00 0x00 0x00 0x04 0x1B
171	Remote Control Code	Write	code 6	0x06 0x14 0x00 0x04 0x00 0x34 0x0C 0x48 0x05 0xA5	0x03 0x14 0x00 0x00 0x00 0x14	0x05 0x14 0x00 0x03 0x00 0x00 0x00 0x05 0x1C
172	Remote Control Code	Write	code 7	0x06 0x14 0x00 0x04 0x00 0x34 0x0C 0x48 0x06 0xA6	0x03 0x14 0x00 0x00 0x00 0x14	0x05 0x14 0x00 0x03 0x00 0x00 0x00 0x06 0x1D

No.	Function	Type	Action	Command	Response	The response of Query Read command
173	Remote Control Code	Write	code 8	0x06 0x14 0x00 0x04 0x00 0x34 0x0C 0x48 0x07 0xA7	0x03 0x14 0x00 0x00 0x00 0x14	0x05 0x14 0x00 0x03 0x00 0x00 0x00 0x07 0x1E
174	Remote Control	Read	Status	0x07 0x14 0x00 0x05 0x00 0x34 0x00 0x00 0x0C 0x48 0xA1	0x05 0x14 0x00 0x03 0x00 0x00 0x00 0x00 0x17	
175	Over Scan	Write	OFF	0x06 0x14 0x00 0x04 0x00 0x34 0x11 0x33 0x00 0x90	0x03 0x14 0x00 0x00 0x00 0x14	0x05 0x14 0x00 0x03 0x00 0x00 0x00 0x00 0x17
176	Over Scan	Write	Value 1	0x06 0x14 0x00 0x04 0x00 0x34 0x11 0x33 0x01 0x91	0x03 0x14 0x00 0x00 0x00 0x14	0x05 0x14 0x00 0x03 0x00 0x00 0x00 0x01 0x18
177	Over Scan	Write	Value 2	0x06 0x14 0x00 0x04 0x00 0x34 0x11 0x33 0x02 0x92	0x03 0x14 0x00 0x00 0x00 0x14	0x05 0x14 0x00 0x03 0x00 0x00 0x00 0x02 0x19
178	Over Scan	Write	Value 3	0x06 0x14 0x00 0x04 0x00 0x34 0x11 0x33 0x03 0x93	0x03 0x14 0x00 0x00 0x00 0x14	0x05 0x14 0x00 0x03 0x00 0x00 0x00 0x03 0x1A
179	Over Scan	Write	Value 4	0x06 0x14 0x00 0x04 0x00 0x34 0x11 0x33 0x04 0x94	0x03 0x14 0x00 0x00 0x00 0x14	0x05 0x14 0x00 0x03 0x00 0x00 0x00 0x04 0x1B
180	Over Scan	Write	Value 5	0x06 0x14 0x00 0x04 0x00 0x34 0x11 0x33 0x05 0x95	0x03 0x14 0x00 0x00 0x00 0x14	0x05 0x14 0x00 0x03 0x00 0x00 0x00 0x05 0x1C
181	Over Scan	Read	Get Value	0x07 0x14 0x00 0x05 0x00 0x34 0x00 0x00 0x11 0x33 0x91	0x05 0x14 0x00 0x03 0x00 0x00 0x00 0x00 0x17	
182	Remote Key	Write	Menu	0x02 0x14 0x00 0x04 0x00 0x34 0x02 0x04 0x0F 0x61	0x03 0x14 0x00 0x00 0x00 0x14	
183	Remote Key	Write	Exit	0x02 0x14 0x00 0x04 0x00 0x34 0x02 0x04 0x13 0x65	0x03 0x14 0x00 0x00 0x00 0x14	
184	Remote Key	Write	Top	0x02 0x14 0x00 0x04 0x00 0x34 0x02 0x04 0x0B 0x5D	0x03 0x14 0x00 0x00 0x00 0x14	
185	Remote Key	Write	Bottom	0x02 0x14 0x00 0x04 0x00 0x34 0x02 0x04 0x0C 0x5E	0x03 0x14 0x00 0x00 0x00 0x14	
186	Remote Key	Write	Left	0x02 0x14 0x00 0x04 0x00 0x34 0x02 0x04 0x0D 0x5F	0x03 0x14 0x00 0x00 0x00 0x14	
187	Remote Key	Write	Right	0x02 0x14 0x00 0x04 0x00 0x34 0x02 0x04 0x0E 0x60	0x03 0x14 0x00 0x00 0x00 0x14	
188	Remote Key	Write	Source	0x02 0x14 0x00 0x04 0x00 0x34 0x02 0x04 0x04 0x56	0x03 0x14 0x00 0x00 0x00 0x14	
189	Remote Key	Write	Enter	0x02 0x14 0x00 0x04 0x00 0x34 0x02 0x04 0x15 0x67	0x03 0x14 0x00 0x00 0x00 0x14	
190	Remote Key	Write	Auto	0x02 0x14 0x00 0x04 0x00 0x34 0x02 0x04 0x08 0x5A	0x03 0x14 0x00 0x00 0x00 0x14	
191	Remote Key	Write	My Button	0x02 0x14 0x00 0x04 0x00 0x34 0x02 0x04 0x11 0x63	0x03 0x14 0x00 0x00 0x00 0x14	
192	AMX	Write	AMX response	AMX	AMXB<-SDKClass=VideoProjector><-Make=ViewSonic><-Model=PX800HD>	
193	Operating emperature	Read	Get Value	0x07 0x14 0x00 0x05 0x00 0x34 0x00 0x00 0x15 0x03 0x65	0x05 0x14 0x00 0x0A 0x00 0x00 0x00 0x29 0x01 0x00 0x00 0x00 0x00 0x48	See note 1
194	Lamp mode cycle	Write	Lamp mode cycle	0x06 0x14 0x00 0x04 0x00 0x34 0x13 0x36 0x00 0x95	0x03 0x14 0x00 0x00 0x00 0x14	

**Note:**

1. Operating temperature value format:

Response : 0x05 0x14 0x00 0x0A 0x00 0x00 0x00 0x29 0x01 0x00 0x00 0x00 0x00 0x00 0x48(checksum)

Value : Byte7~Byte10

0xaa 0xbb 0xcc 0xdd -> HEX2DEC(ddccbbaa)/10 -> real temperature degree

Ex. "0x29 0x01 0x00 0x00" -> 0x00000129 =297 -> 29.7° C .

2. Error response status : (Only for service debug) :  
 Response : 0x05 0x14 0x00 0x16 0x00 0x00 0x00 ErrorStatus(20 Items) checksum
  - 1 · Item 0 ~17: 1 byte.
  - 2 · Item 18 : First burn In error minutes , 4 Bytes.
  - 3 · Item 19: Lamp Status , 1 Byte.
  - 4 · Item 20: Lamp error status , 2 Bytes.
 Total : 32 Bytes .
  
3. When the projector response the code “0x00 0x14 0x00 0x00 0x00 0x14” at the first byte “0x00” , it indicate that function is disable (grey out).  
 For example when there are no source inputs to projector, the function “Aspect Ratio” is greyed out and can’t be controled by user via OSD menu or RC.
  
4. HDMI Range:
  - Enhanced = 0 – 255 steps
  - Normal = 16 -235 steps
  
5. This function is only applied some models due to LAN solution.  
Status explanation:  
 Power On: System is finished all HW/FW settings and ready to work.  
 Warm Up: System is at initial stage to set and check HW/FW environment. Please do not perform other commands.  
 Cool Down: System is at final stage to close HW/FW environment. Please do not perform other commands.  
 Power Off: System is turned off all HW/FW except MCU or LAN functions with LAN standby setting.
 

\*This command is only applied to particular models, please refer to User Guide.
  
6. The “Mute” function is only active when there is an input source applied.  
 The “Auto Adjust” function is only active when there is an input source of non-digital type applied, such as VGA/Computer1/D-sub.

## Customer Support

For technical support or product service, see the table below or contact your reseller.

**Note :** You will need the product serial number.

Country/Region	Website	T= Telephone C = CHAT ONLINE	Email
Australia New Zealand	www.viewsonic.com.au	AUS= 1800 880 818 NZ= 0800 008 822	service@au.viewsonic.com
Canada	www.viewsonic.com	T= 1-866-463-4775	service.ca@viewsonic.com
Europe	www.viewsoniceurope.com	http://www.viewsoniceurope.com/eu/support/call-desk/	
Hong Kong	www.hk.viewsonic.com	T= 852 3102 2900	service@hk.viewsonic.com
India	www.in.viewsonic.com	T= 1800 419 0959	service@in.viewsonic.com
Korea	ap.viewsonic.com/kr/	T= 080 333 2131	service@kr.viewsonic.com
Latin America (Argentina)	www.viewsonic.com/la/	C= http://www.viewsonic.com/ la/soporte/servicio-tecnico	soporte@viewsonic.com
Latin America (Chile)	www.viewsonic.com/la/	C= http://www.viewsonic.com/ la/soporte/servicio-tecnico	soporte@viewsonic.com
Latin America (Columbia)	www.viewsonic.com/la/	C= http://www.viewsonic.com/ la/soporte/servicio-tecnico	soporte@viewsonic.com
Latin America (Mexico)	www.viewsonic.com/la/	C= http://www.viewsonic.com/ la/soporte/servicio-tecnico	soporte@viewsonic.com
Nexus Hightech Solutions, Cincinnati #40 Desp. 1 Col. De los Deportes Mexico D.F. Tel: 55) 6547-6454 55)6547-6484 Other places please refer to <a href="http://www.viewsonic.com/la/soporte/servicio-tecnico#mexico">http://www.viewsonic.com/la/soporte/servicio-tecnico#mexico</a>			
Latin America (Peru)	www.viewsonic.com/la/	C= http://www.viewsonic.com/ la/soporte/servicio-tecnico	soporte@viewsonic.com
Macau	www.hk.viewsonic.com	T= 853-2840-3687	service@hk.viewsonic.com
Middle East	ap.viewsonic.com/me/	Contact your reseller	service@ap.viewsonic.com
Puerto Rico & Virgin Islands	www.viewsonic.com	T= 1-800-688-6688 (English) C= http://www.viewsonic.com/ la/soporte/servicio-tecnico	service.us@viewsonic.com soporte@viewsonic.com
Singapore/ Malaysia/Thailand	www.ap.viewsonic.com	T= 65 6461 6044	service@sg.viewsonic.com
South Africa	ap.viewsonic.com/za/	Contact your reseller	service@ap.viewsonic.com
United States	www.viewsonic.com	T= 1-800-688-6688	service.us@viewsonic.com

# Limited Warranty

## ViewSonic® Projector

### What the warranty covers:

ViewSonic warrants its products to be free from defects in material and workmanship, under normal use, during the warranty period. If a product proves to be defective in material or workmanship during the warranty period, ViewSonic will, at its sole option, repair or replace the product with a like product. Replacement product or parts may include remanufactured or refurbished parts or components.

### Limited One (1) year General Warranty

ViewSonic's standard warranty period is one (1) year for any product model in any country, unless a longer warranty period is specified and provided by ViewSonic. Please refer to the ViewSonic website in your country to check the local terms and model variants, and see if the product model in your country is eligible for a longer warranty period.

### Limited One (1) year Heavy Usage Warranty:

Under heavy usage settings, where a projector's use includes more than fourteen (14) hours average daily usage, North and South America: One (1) year warranty for all parts excluding the lamp, one (1) year for labor, and ninety (90) days for the original lamp from the date of the first consumer purchase; Europe: One (1) year warranty for all parts excluding the lamp, one (1) year for labor, and ninety (90) days for the original lamp from the date of the first consumer purchase.

Other regions or countries: Please check with your local dealer or local ViewSonic office for the warranty information.

Lamp warranty subject to terms and conditions, verification and approval. Applies to manufacturer's installed lamp only. All accessory lamps purchased separately are warranted for 90 days.

### Who the warranty protects:

This warranty is valid only for the first consumer purchaser.

### What the warranty does not cover:

1. Any product on which the serial number has been defaced, modified or removed.
2. Damage, deterioration, failure, or malfunction resulting from:
  - a. Accident, abuse, misuse, neglect, fire, water, lightning, or other acts of nature, improper maintenance, unauthorized product modification, or failure to follow instructions supplied with the product.
  - b. Operation outside of product specifications.
  - c. Operation of the product for other than the normal intended use or not under normal conditions.
  - d. Repair or attempted repair by anyone not authorized by ViewSonic.
  - e. Any damage of the product due to shipment.
  - f. Removal or installation of the product.
  - g. Causes external to the product, such as electric power fluctuations or failure.
  - h. Use of supplies or parts not meeting ViewSonic's specifications.
  - i. Normal wear and tear.
  - j. Any other cause which does not relate to a product defect.
3. Removal, installation, and set-up service charges.



**How to get service:**

1. For information about receiving service under warranty, contact ViewSonic Customer Support (please refer to “Customer Support” page). You will need to provide your product’s serial number.
2. To obtain warranted service, you will be required to provide (a) the original dated sales slip, (b) your name, (c) your address, (d) a description of the problem, and (e) the serial number of the product.
3. Take or ship the product freight prepaid in the original container to an authorized ViewSonic service center or ViewSonic.
4. For additional information or the name of the nearest ViewSonic service center, contact ViewSonic.

**Limitation of implied warranties:**

There are no warranties, express or implied, which extend beyond the description contained herein including the implied warranty of merchantability and fitness for a particular purpose.

**Exclusion of damages:**

ViewSonic’s liability is limited to the cost of repair or replacement of the product.

ViewSonic shall not be liable for:

1. Damage to other property caused by any defects in the product, damages based upon inconvenience, loss of use of the product, loss of time, loss of profits, loss of business opportunity, loss of goodwill, interference with business relationships, or other commercial loss, even if advised of the possibility of such damages.
2. Any other damages, whether incidental, consequential or otherwise.
3. Any claim against the customer by any other party.

**Effect of local law:**

This warranty gives you specific legal rights, and you may also have other rights which vary from local authority. Some local governances do not allow limitations on implied warranties and/or do not allow the exclusion of incidental or consequential damages, so the above limitations and exclusions may not apply to you.

**Sales outside the U.S.A. and Canada:**

For warranty information and service on ViewSonic products sold outside of the U.S.A. and Canada, contact ViewSonic or your local ViewSonic dealer.

The warranty period for this product in mainland China (Hong Kong, Macao and Taiwan Excluded) is subject to the terms and conditions of the Maintenance Guarantee Card.

For users in Europe and Russia, full details of warranty provided can be found in [www.viewsoniceurope.com](http://www.viewsoniceurope.com) under Support/Warranty Information.

# Mexico Limited Warranty

## ViewSonic® Projector

### What the warranty covers:

ViewSonic warrants its products to be free from defects in material and workmanship, under normal use, during the warranty period. If a product proves to be defective in material or workmanship during the warranty period, ViewSonic will, at its sole option, repair or replace the product with a like product. Replacement product or parts may include remanufactured or refurbished parts or components & accessories.

### How long the warranty is effective:

ViewSonic's standard warranty period is one (1) year for any product model in any country, unless a longer warranty period is specified and provided by ViewSonic. Please refer to the ViewSonic website in your country to check the local terms and model variants, and see if the product model in your country is eligible for a longer warranty period.

### Who the warranty protects:

This warranty is valid only for the first consumer purchaser.

### What the warranty does not cover:

1. Any product on which the serial number has been defaced, modified or removed.
2. Damage, deterioration or malfunction resulting from:
  - a. Accident, misuse, neglect, fire, water, lightning, or other acts of nature, unauthorized product modification, unauthorized attempted repair, or failure to follow instructions supplied with the product.
  - b. Any damage of the product due to shipment.
  - c. Causes external to the product, such as electrical power fluctuations or failure.
  - d. Use of supplies or parts not meeting ViewSonic's specifications.
  - e. Normal wear and tear.
  - f. Any other cause which does not relate to a product defect.
3. Any product exhibiting a condition commonly known as "image burn-in" which results when a static image is displayed on the product for an extended period of time.
4. Removal, installation, insurance, and set-up service charges.

### How to get service:

For information about receiving service under warranty, contact ViewSonic Customer Support (Please refer to the attached Customer Support page). You will need to provide your product's serial number, so please record the product information in the space provided below on your purchase for your future use. Please retain your receipt of proof of purchase to support your warranty claim.

For Your Records

Product Name: \_\_\_\_\_ Model Number: \_\_\_\_\_  
Document Number: \_\_\_\_\_ Serial Number: \_\_\_\_\_  
Purchase Date: \_\_\_\_\_ Extended Warranty Purchase? \_\_\_\_\_ (Y/N)  
If so, what date does warranty expire? \_\_\_\_\_

1. To obtain warranty service, you will be required to provide (a) the original dated sales slip, (b) your name, (c) your address, (d) a description of the problem, and (e) the serial number of the product.
2. Take or ship the product in the original container packaging to an authorized ViewSonic service center.
3. Round trip transportation costs for in-warranty products will be paid by ViewSonic.

### Limitation of implied warranties:

There are no warranties, express or implied, which extend beyond the description contained herein including the implied warranty of merchantability and fitness for a particular purpose.

### Exclusion of damages:

ViewSonic's liability is limited to the cost of repair or replacement of the product. ViewSonic shall not be liable for:

1. Damage to other property caused by any defects in the product, damages based upon inconvenience, loss of use of the product, loss of time, loss of profits, loss of business opportunity, loss of goodwill, interference with business relationships, or other commercial loss, even if advised of the possibility of such damages.
2. Any other damages, whether incidental, consequential or otherwise.
3. Any claim against the customer by any other party.
4. Repair or attempted repair by anyone not authorized by ViewSonic.

<b>Contact Information for Sales &amp; Authorized Service (Centro Autorizado de Servicio) within Mexico:</b>	
<b>Name, address, of manufacturer and importers:</b> México, Av. de la Palma #8 Piso 2 Despacho 203, Corporativo Interpalmas, Col. San Fernando Huixquilucan, Estado de México Tel: (55) 3605-1099 <a href="http://www.viewsonic.com/la/soporte/index.htm">http://www.viewsonic.com/la/soporte/index.htm</a>	
<b>NÚMERO GRATIS DE ASISTENCIA TÉCNICA PARA TODO MÉXICO: 001.866.823.2004</b>	
<b>Hermosillo:</b> Distribuciones y Servicios Computacionales SA de CV. Calle Juárez 284 local 2 Col. Bugambilias C.P: 83140 Tel: 01-66-22-14-9005 E-Mail: <a href="mailto:disc2@hmo.megared.net.mx">disc2@hmo.megared.net.mx</a>	<b>Villahermosa:</b> Compumantenimientos Garantizados, S.A. de C.V. AV. GREGORIO MENDEZ #1504 COL, FLORIDA C.P. 86040 Tel: 01 (993) 3 52 00 47 / 3522074 / 3 52 20 09 E-Mail: <a href="mailto:compumantenimientos@prodigy.net.mx">compumantenimientos@prodigy.net.mx</a>
<b>Puebla, Pue. (Matriz):</b> RENTA Y DATOS, S.A. DE C.V. Domicilio: 29 SUR 721 COL. LA PAZ 72160 PUEBLA, PUE. Tel: 01(52).222.891.55.77 CON 10 LINEAS E-Mail: <a href="mailto:datos@puebla.megared.net.mx">datos@puebla.megared.net.mx</a>	<b>Veracruz, Ver.:</b> CONEXION Y DESARROLLO, S.A DE C.V. Av. Americas # 419 ENTRE PINZÓN Y ALVARADO Fracc. Reforma C.P. 91919 Tel: 01-22-91-00-31-67 E-Mail: <a href="mailto:gacosta@qplus.com.mx">gacosta@qplus.com.mx</a>
<b>Chihuahua</b> Soluciones Globales en Computación C. Magisterio # 3321 Col. Magisterial Chihuahua, Chih. Tel: 4136954 E-Mail: <a href="mailto:Cefeo@soluglobales.com">Cefeo@soluglobales.com</a>	<b>Cuernavaca</b> Compusupport de Cuernavaca SA de CV Francisco Leyva # 178 Col. Miguel Hidalgo C.P. 62040, Cuernavaca Morelos Tel: 01 777 3180579 / 01 777 3124014 E-Mail: <a href="mailto:aquevedo@compusupportcva.com">aquevedo@compusupportcva.com</a>
<b>Distrito Federal:</b> QPLUS, S.A. de C.V. Av. Coyoacán 931 Col. Del Valle 03100, México, D.F. Tel: 01(52)55-50-00-27-35 E-Mail : <a href="mailto:gacosta@qplus.com.mx">gacosta@qplus.com.mx</a>	<b>Guadalajara, Jal.:</b> SERVICRECE, S.A. de C.V. Av. Niños Héroes # 2281 Col. Arcos Sur, Sector Juárez 44170, Guadalajara, Jalisco Tel: 01(52)33-36-15-15-43 E-Mail: <a href="mailto:mmiranda@servicrece.com">mmiranda@servicrece.com</a>
<b>Guerrero Acapulco</b> GS Computación (Grupo Sesicomp) Progreso #6-A, Colo Centro 39300 Acapulco, Guerrero Tel: 744-48-32627	<b>Monterrey:</b> Global Product Services Mar Caribe # 1987, Esquina con Golfo Pérsico Fracc. Bernardo Reyes, CP 64280 Monterrey N.L. México Tel: 8129-5103 E-Mail: <a href="mailto:aydeem@gps1.com.mx">aydeem@gps1.com.mx</a>
<b>MERIDA:</b> ELECTROSER Av Reforma No. 403Gx39 y 41 Mérida, Yucatán, México CP97000 Tel: (52) 999-925-1916 E-Mail: <a href="mailto:rrrb@sureste.com">rrrb@sureste.com</a>	<b>Oaxaca, Oax.:</b> CENTRO DE DISTRIBUCION Y SERVICIO, S.A. de C.V. Murguía # 708 P.A., Col. Centro, 68000, Oaxaca Tel: 01(52)95-15-15-22-22 Fax: 01(52)95-15-13-67-00 E-Mail: <a href="mailto:gpotai2001@hotmail.com">gpotai2001@hotmail.com</a>
<b>Tijuana:</b> STD Av Ferrocarril Sonora #3780 L-C Col 20 de Noviembre Tijuana, Mexico	<b>FOR USA SUPPORT:</b> ViewSonic Corporation 14035 Pipeline Ave. Chino, CA 91710, USA Tel: 800-688-6688 (English); 866-323-8056 (Spanish); E-Mail: <a href="http://www.viewsonic.com">http://www.viewsonic.com</a>



**ViewSonic®**