

VPC-A31-O1
VS19699
 Slot in PC module

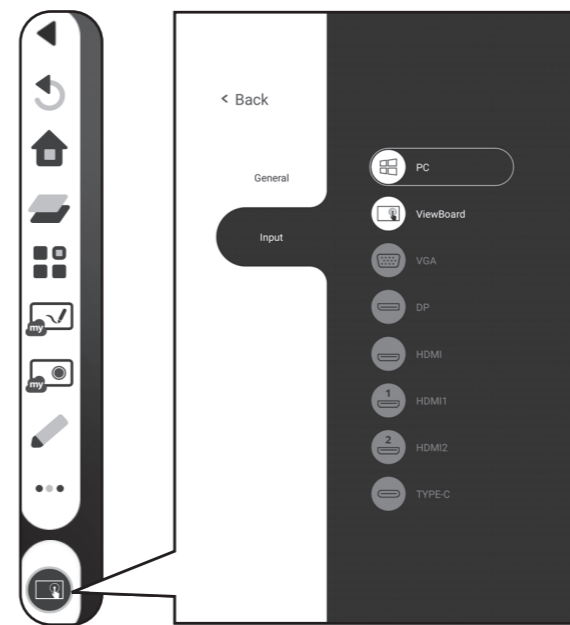

IFP Series

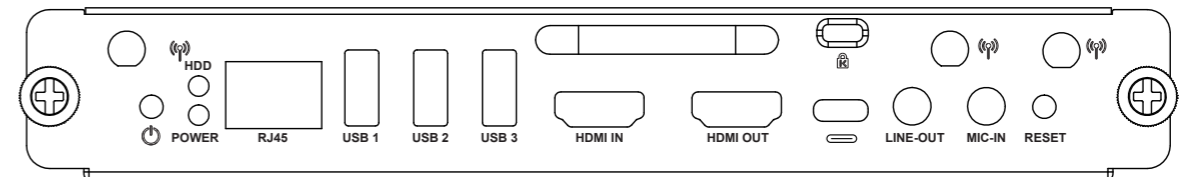
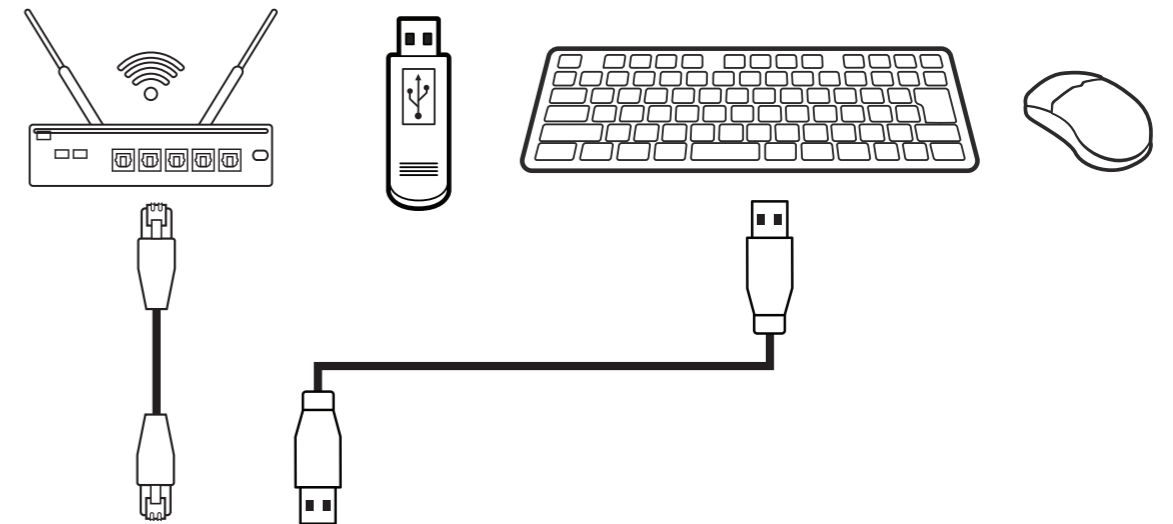
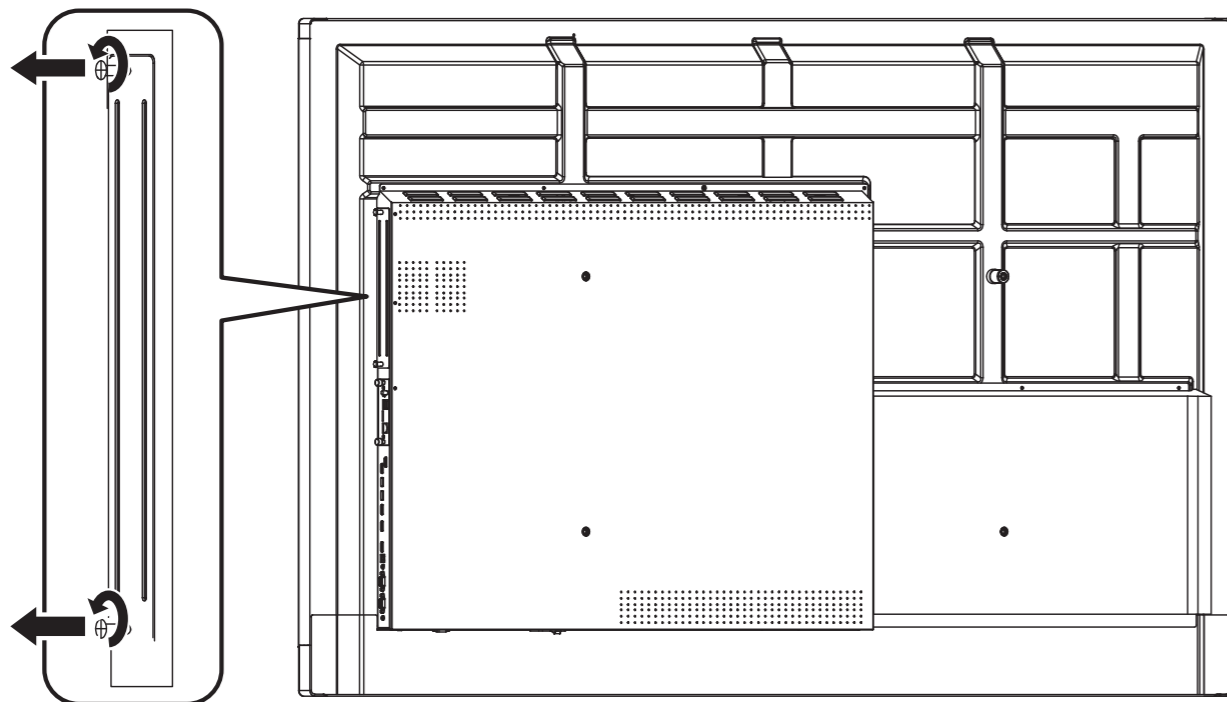
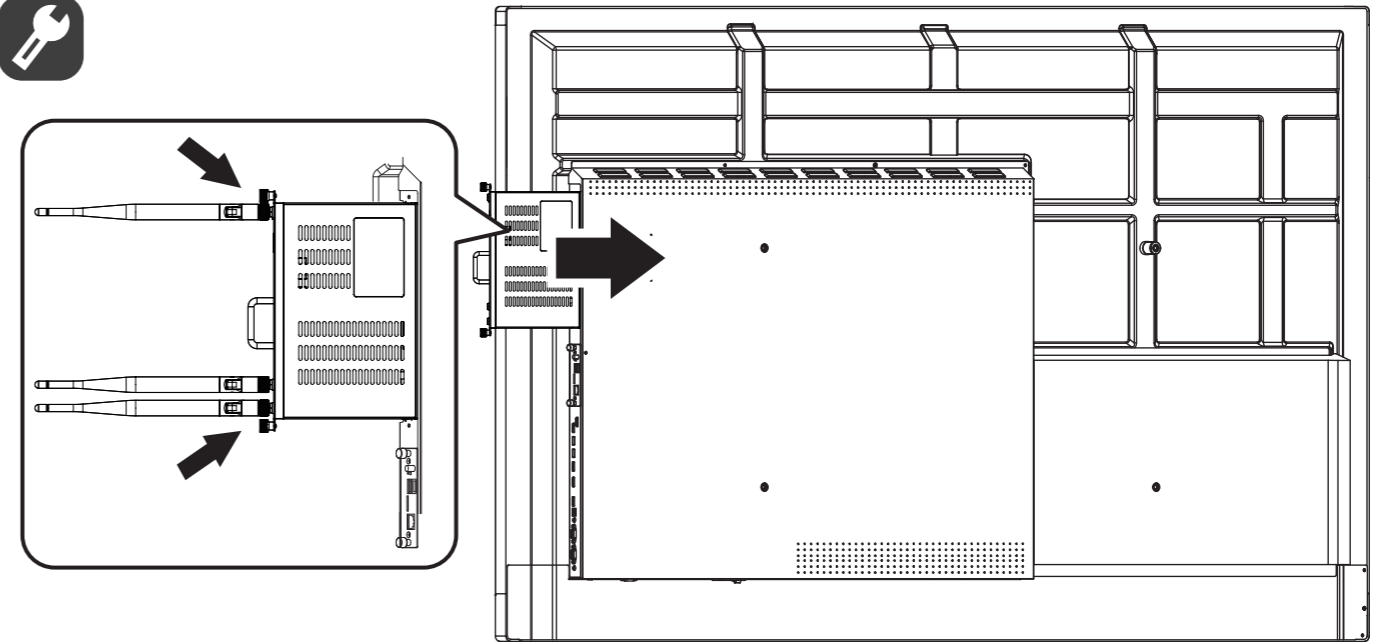
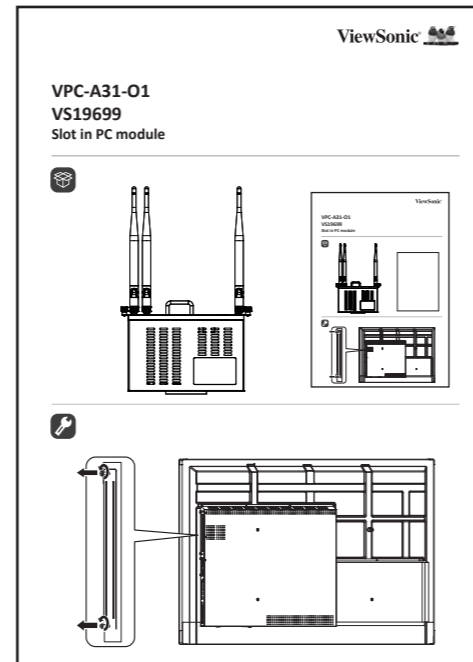
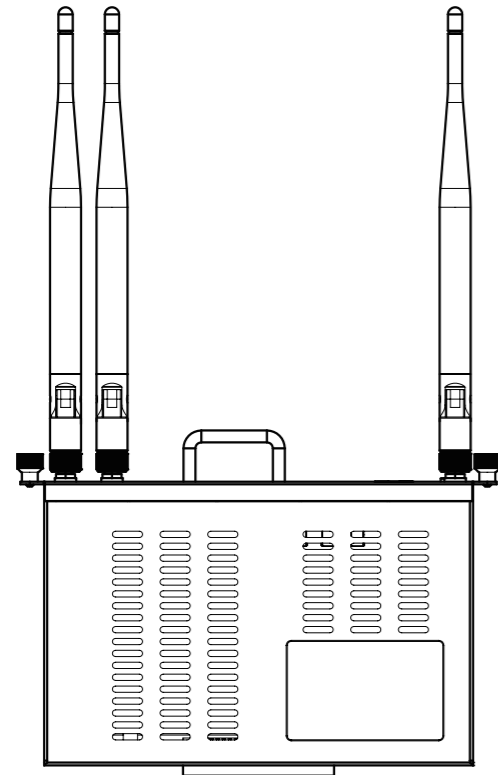
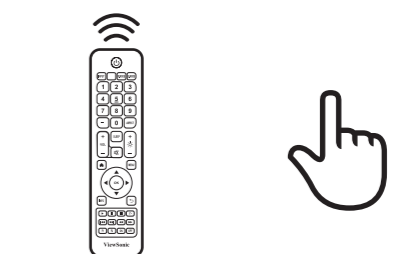
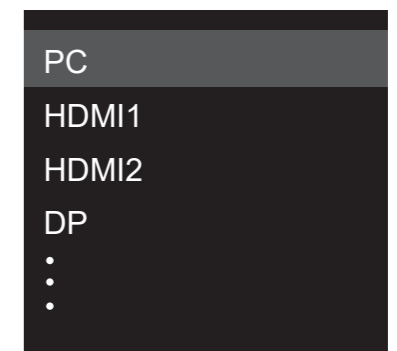

CDE Series IFPG1 Series



FCC Compliance Statement

This device complies with part 15 of FCC Rules. Operation is subject to the following two conditions: (1) this device may not cause harmful interference, and (2) this device must accept any interference received, including interference that may cause undesired operation.

Industry Canada Statement

CAN ICES-003(B) / NMB-003(B)

CE Conformity for European Countries

The device complies with the EMC Directive 2014/30/EU and Low Voltage Directive 2014/35/EU and Radio Equipment Directive (RED) 2014/53/EU.

https://www.viewsonicglobal.com/public/products_download/safety_compliance/acc/VS19699_CE_DOC.pdf

FCC-Hinweise

Dieses Gerät erfüllt alle Anforderungen des Teils 15 der FCC-Bestimmungen. Der Betrieb muss die folgenden zwei Bedingungen erfüllen: (1) Das Gerät darf keine schädlichen Interferenzen verursachen, und (2) das Gerät muss alle empfangenen Interferenzen inklusive der Interferenzen, die eventuell einen unerwünschten Betrieb verursachen, annehmen.

Industry Canada-Hinweis

CAN ICES-003(B) / NMB-003(B)

CE-Konformität für europäische Länder

Das Gerät erfüllt die Anforderungen der EMV-Richtlinie 2014/30/EU und der Niederspannungsrichtlinie 2014/35/EU und Funkgeräte-Richtlinie 2014/53/EU.

https://www.viewsonicglobal.com/public/products_download/safety_compliance/acc/VS19699_CE_DOC.pdf

Overensstemmelseerklæring fra FCC

Denne enhed overholder stk. 15 i FCC-reglerne. Driften er underlagt følgende to betingelser: (1) Denne enhed må ikke forårsage skadelig interferens, og (2) denne enhed skal acceptere enhver modtaget interferens, herunder interferens, der kan forårsage uønsket drift.

Erklæring fra Industry Canada

CAN ICES-003(B) / NMB-003(B)

CE-overensstemmelse for europæiske lande

Enheden er i overensstemmelse med EMC-direktivet 2014/30/EU og lavspændingsdirektivet 2014/35/EU og direktivet om radioustyret (RED) 2014/53/EU.

https://www.viewsonicglobal.com/public/products_download/safety_compliance/acc/VS19699_CE_DOC.pdf

FCC-nalevingsverklaring

Dit apparaat voldoet aan Deel 15 van de FCC-voorschriften. Gebruik is onderworpen aan de volgende twee voorwaarden: (1) dit apparaat mag geen schadelijke ruis veroorzaken en (2) dit apparaat dient ontvangen ruis te accepteren, inclusief ruis die ongewenste werking kan veroorzaken.

Verklaring voor Canadese bedrijven

CAN ICES-003(B) / NMB-003(B)

CE-verklaring van conformiteit voor Europese landen

Het apparaat voldoet aan de EMC-richtlijn 2014/30/EU en Laagspanningsrichtlijn 2014/35/EU en Richtlijn betreffende radio-apparatuur (RED) 2014/53/EU.

https://www.viewsonicglobal.com/public/products_download/safety_compliance/acc/VS19699_CE_DOC.pdf

Declaración de conformidad de la FCC (Comisión Federal de Comunicaciones)

Este dispositivo cumple con el Apartado 15 de las normas FCC. El funcionamiento está sujeto a las dos condiciones siguientes: (1) Este dispositivo no debe causar interferencias perjudiciales, y (2) Este dispositivo debe aceptar cualquier interferencia recibida, incluidas aquellas que provoquen un funcionamiento no deseado.

Declaración del Departamento de Industria de Canadá

CAN ICES-003(B) / NMB-003(B)

Certificación CE para países europeos

Este dispositivo cumple con la Directiva EMC (Compatibilidad Electromagnética) 2014/30/EU y la Directiva de Baja Tensión 2014/35/ EU y Directiva para equipos de radio 2014/53/UE.

https://www.viewsonicglobal.com/public/products_download/safety_compliance/acc/VS19699_CE_DOC.pdf

FCC-yhdenmukaisuusilmoitus

Laitte on FCC-sääntöjen osan 15 mukainen. Laitteen käyttöä koskevat seuraavat kaksi ehtoa: (1) tämä laite saattaa aiheuttaa haitallista häiriötä, ja (2) tämän laitteen tulee vastaanottaa siihen tuleva häiriö, mukaan lukien häiriöt, joka voivat aiheuttaa ei-toivottuja toimintoja.

Industry Canada -ilmoitus

CAN ICES-003(B) / NMB-003(B)

CE-yhdenmukaisuus Euroopan maissa

Tämä laite on EMC-direktiivin 2014/30/EU ja matalajännitedirektiivin 2014/35/EU ja radiolaitedirektiivin (RED) 2014/53/EU vaatimusten mukainen.

https://www.viewsonicglobal.com/public/products_download/safety_compliance/acc/VS19699_CE_DOC.pdf

Declaration de conformite FCC

Cet appareil est conforme à l'article 15 des Règlements FCC. Son fonctionnement est sujet aux deux conditions suivantes: (1) Cet appareil ne doit pas provoquer d'interférences néfastes, et (2) cet appareil doit accepter toutes les interférences reçues, y compris celles pouvant provoquer un fonctionnement indésirable.

Declaration de l'Industrie canadienn

CAN ICES-003(B) / NMB-003(B)

Conformité CE pour les pays européens

L'appareil est conforme la norme EMC 2014/30/EU et à la norme sur la basse tension 2014/35/EU et directive Équipements radioélectriques 2014/53/UE.

https://www.viewsonicglobal.com/public/products_download/safety_compliance/acc/VS19699_CE_DOC.pdf

Δήλωση συμμόρφωσης με την FCC

Η παρούσα συσκευή συμμορφώνεται με το Μέρος 15 των κανόνων της Επιτροπής FCC. Η λειτουργία υπόκειται στους εξής δύο όρους: (1) αυτή η συσκευή δεν μπορεί να προκαλέσει επιβλαβή παρεμβολή, και (2) αυτή η συσκευή πρέπει να αποδέχεται οποιαδήποτε παρεμβολή, συμπεριλαμβανομένης παρεμβολής που μπορεί να προκαλέσει ανεπιθύμητη λειτουργία.

Δήλωση Industry Canada

CAN ICES-003(B) / NMB-003(B)

Συμμόρφωση CE για τις Ευρωπαϊκές χώρες

Η συσκευή συμμορφώνεται με την Οδηγία EMC 2014/30/EE, την Οδηγία περί χαμηλής τάσης 2014/35/EE και την Οδηγία για τον ραδιοεξοπλισμό (RED) 2014/53/EE.

https://www.viewsonicglobal.com/public/products_download/safety_compliance/acc/VS19699_CE_DOC.pdf

FCC-samsvarserklæring

Denne enheten samsvarer med del 15 i FCC-reglene. Bruk er underlagt følgende to betingelser: (1) Denne enheten skal ikke forårsake skadelig interferens, og (2) denne enheten må godta all mottatt interferens, inkludert interferens som kan forårsake uønsket drift.

Industry Canada-erklæring

CAN ICES-003(B) / NMB-003(B)

CE-samsvar for europeiske land

Enheten samsvarer med EMC-direktivet 2014/30/EU, Lavspenningsdirektivet 2014/35/EU og Radioustyrsdirektivet (RED) 2014/53/EU.

https://www.viewsonicglobal.com/public/products_download/safety_compliance/acc/VS19699_CE_DOC.pdf

Declaração de conformidade da FCC

Este dispositivo está em conformidade com o Artigo 15º das Normas da FCC. O seu funcionamento está sujeito às duas condições seguintes: (1) este dispositivo não poderá causar interferências prejudiciais, e (2) este dispositivo deve aceitar quaisquer interferências recebidas, incluindo interferências que possam causar um funcionamento indesejado.

Declaração do Departamento de indústria do Canadá

CAN ICES-003(B) / NMB-003(B)

Conformidade CE para países europeus

O dispositivo cumpre a Diretiva CEM 2014/30/UE e a Diretiva de Baixa Tensão 2014/35/UE e a Diretiva de Equipamentos de Rádio (RED) 2014/53/UE.

https://www.viewsonicglobal.com/public/products_download/safety_compliance/acc/VS19699_CE_DOC.pdf

Соответствие требованиям Федеральной комиссии по связи США (FCC)

Данное устройство соответствует требованиям Части 15 Правил FCC. Работа должна соответствовать следующим двум условиям: (1) данные устройства не могут являться источниками вредных помех, и (2) данные устройства должны работать в условиях помех, включая те, которые могут вызывать сбои в работе.

Соответствие требованиям Министерства промышленности Канады

CAN ICES-003(B) / NMB-003(B)

Соответствие стандартам ЕС для европейских стран

Данное устройство соответствует требованиям Директивы 2014/30/ЕС на электромагнитную совместимость и Директиве 2014/35/ЕС на низковольтное оборудование и Директива о радиоборудовании 2014/53/ЕУ.

https://www.viewsonicglobal.com/public/products_download/safety_compliance/acc/VS19699_CE_DOC.pdf

Uttalande gällande FCC-efterlevnad

Denna enhet överensstämmer med avsnitt 15 i FCC-reglerna. Användningen är underställd följande två villkor: (1) Enheten får inte orsaka skadliga störningar och (2) Denna enhet måste acceptera alla mottagna störningar, inklusive störningar som kan orsaka oönskad funktion.

Uttalande från Industry Canada

CAN ICES-003(B) / NMB-003(B)

CE-överensstämmelse för europeiska länder

Enheten överensstämmer med EMC-direktivet 2014/30/EU, lågspänningsdirektivet 2014/35/EU och direktivet om radioutrustning (RED) 2014/53/EU.

https://www.viewsonicglobal.com/public/products_download/safety_compliance/acc/VS19699_CE_DOC.pdf

FCC Uyumluluk Bildirimi

Bu aygıt, FCC Kuralları kısım 15'e uygundur. Kullanım aşağıdaki koşula bağlıdır: (1) Bu aygıt zararlı girişime neden olamaz ve (2) bu aygıt istenmeyen çalışmaya neden olabilen girişim dahil olmak üzere alınan her türlü girişimi kabul etmelidir.

Industry Canada Bildirimi

CAN ICES-003(B) / NMB-003(B)

Avrupa Ülkeleri İçin CE Uyumluluğu

Aygıt, EMC Yönergesi 2014/30/EU ve Düşük Voltaj Yönergesi 2014/35/EU'ya uygundur ve Radyo Ekipman Direktifi 2014/53/AB.

https://www.viewsonicglobal.com/public/products_download/safety_compliance/acc/VS19699_CE_DOC.pdf

FCC 符合性聲明

本設備符合 FCC 規則第 15 部分的規定。操作時有以下兩種情況：(1) 本裝置不會造成有害的干擾，以及 (2) 本裝置必須接受任何接收到的干擾，包括造成操作不良的干擾。

加拿大工業部聲明

CAN ICES-003(B) / NMB-003(B)

CE 歐洲國家聲明

本裝置符合 EMC 指令 2014/30/EU、低電壓指令 2014/35/EU 及無線電設備指令 (RED) 2014/53/EU。

https://www.viewsonicglobal.com/public/products_download/safety_compliance/acc/VS19699_CE_DOC.pdf

台灣RoHS符合性聲明

台灣RoHS/限用物質含有情況標示資訊請參考下列網址:

https://www.viewsonicglobal.com/public/products_download/safety_compliance/acc/VS19699_BSMI_RoHS.pdf

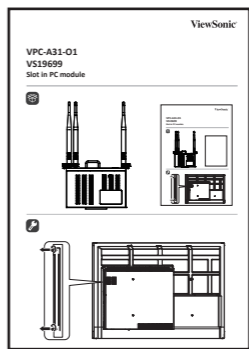

<http://www.viewsonic.com/support/>



www.viewsonic.com