

PIXO



Mantis PIXO stereo microscope with dynamic perspective optics, a choice of up to 3 fixed magnification objectives and built in camera to capture, review and share digital images.

ERGO



Mantis ERGO stereo microscope with dynamic perspective optics and a choice of up to 3 fixed magnification objectives.

MANTIS USER GUIDE

www.visioneng.com

IOTA



Mantis IOTA compact stereo microscope with dynamic perspective optics.

CONTENTS

COPYRIGHT	3
INTRODUCTION	4
GENERAL	
Safety	5
Servicing	5
Cleaning	5
Symbols	5
HEALTH & SAFETY	
Electrical Safety	6
Illumination	6
Environmental Considerations	6
Operator Wellbeing	7
Compliance Statements	7
PIXO & ERGO	
Unpacking	8
Controls	9
Dimmer Controls	10
Fitting Lenses	11
Turret Operation	12
PIXO - Camera Operation	13
IOTA	
Unpacking	14
Controls	15
Dimmer Controls	15
Fitting Lenses	16
VERSO ARM	
Unpacking	17
Assembly	18
Adjustments	19
STABILA STAND	
Unpacking	22
Assembly	23
Interfaces	24
Adjustments	25
MANTIS HEADS	
Mounting to a Stand	26
User Comfort	27
PILOT STAGE	
Unpacking	28
Assembly to Stand	29
Operation	30
GENERAL CARE	31
TROUBLESHOOTING	32
SERVICE RECORD	33
WARRANTY	34
TECHNICAL SPECIFICATIONS HEADS	35
TECHNICAL SPECIFICATIONS STANDS	36
SERIAL NUMBER LOCATOR	37
SYSTEM OPTIONS	
PIXO	38
ERGO	39
IOTA	40
HOW TO VIDEOS	41

COPYRIGHT

Copyright© 2023 Vision Engineering Ltd., Galileo Drive, Send, Woking, Surrey, GU23 7ER, UK

All Rights Reserved.

Copyright in this document is owned by Vision Engineering Ltd. Any person is hereby authorised to view, copy, print and distribute this document subject to the following conditions:

The document may be used for informational purposes only.

The document may be used for non-commercial purposes only.

Any copy of this document or portion thereof must include this copyright notice.

Revision 1.0, published June 2023

DISCLAIMER

This document is provided “as is” without any warranty of any kind, either express or implied, statutory or otherwise; without limiting the foregoing, the warranties of satisfactory quality, fitness for a particular purpose or non-infringement are expressly excluded and under no circumstances will Vision Engineering Ltd. be liable for direct or indirect loss or damage of any kind, including loss of profit, revenue, goodwill or anticipated savings. All such warranties are hereby excluded to the fullest extent permitted by law.

We have compiled the texts and illustrations as accurately as possible. However, Vision Engineering Ltd. will not be responsible for the accuracy of the information contained in this document, which is used at your own risk and should not be relied upon. The information included in this manual may be changed without prior notice.

INTRODUCTION

Congratulations on your selection of a Mantis product from Vision Engineering.

Vision Engineering Ltd. prides itself in designing and manufacturing products that make a real difference to your work.

Mantis PIXO, Mantis ERGO and Mantis IOTA are the next additions to a line of groundbreaking products. They offer a wide field of view, small footprint, and ease-of-use to maximise your productivity.

In order to fully benefit from the significant ergonomic advantages afforded by your system, it is also important to properly set-up and optimize your working environment.

For more information, visit: www.visioneng.com/ergonomics



GENERAL



SAFETY

Before using your system for the first time, please read the Health & Safety section of the user guide. Ensure that:

- Your system and accessories are operated, maintained and repaired by authorized and trained personnel only.
- All operators have read, understood and observe the user manual, in particular the safety regulations.

SERVICING

Repairs may only be carried out by Vision Engineering-trained service personnel. Only original Vision Engineering spare parts may be used.

CLEANING

- Disconnect your system from the electrical source before cleaning.
- To clean the external surfaces use a mild detergent with a lint free soft cloth.
- Never use harsh chemicals to clean coloured surfaces or accessories with rubberized parts.
- Use a specialist lens cloth to clean optical surfaces.

SYMBOLS

 Warning!

A potential risk of danger exists. Failure to comply can cause

- i) a hazard to personnel;
- ii) instrument malfunction and damage.

Please consult the operating instructions provided with the product.

Important information.

 This symbol indicates important information. Please carefully follow the instructions or guidelines.

 This symbol indicates a video link to demonstrate the instructions.

HEALTH & SAFETY



Unauthorized alterations to the instrument or non-compliant use shall invalidate all rights to any warranty claims.

ELECTRICAL SAFETY

- Disconnect your system from the electrical source before undertaking any maintenance.
- Avoid using any form of liquid near the system.
- Do not operate your system with wet hands.
- Only use with the power supply unit provided, in case of a lost or damaged power supply, the correct replacement must be obtained from Vision Engineering.
- Electrical input to heads and stands - 12V, 3Amp.
- Electrical input from mains to power supply - 100 -240V ~50/60Hz, 1.2A Max.



ILLUMINATION

- Do not look directly into the illumination source. This may cause damage to eyesight.
- When using the UV illumination options the following mitigations are required;
 - Always wear supplied eye protection when using the UV LED.
 - Turn off UV LEDs when not in use.
 - Cover exposed skin when using UV for prolonged periods of time.
 - User to perform own risk assessment for their working environment.

ENVIRONMENTAL CONSIDERATIONS

- Avoid large temperature fluctuations, direct sunlight and vibrations.
- Ensure electrical components are at least 10cm from walls and combustible materials.
- Position the system on a firm, rigid and level table.
- The equipment should be positioned so that access to the electrical input connector is always available.
- Avoid positioning your system where bright reflections may affect the image.
- Indoor use only.
- Standard operating Temperature: +10°C to +35°C (50°F to 95°F)
- Storage Temperature: 0°C to +50°C (32°F to 122°F) or 3 months without any adverse effects.
- Maximum relative humidity 80% for temperatures up to +31°C (88°F) decreasing linearly to 50% relative humidity at 40°C (104°F).

HEALTH & SAFETY

OPERATOR WELLBEING

The advanced ergonomic design and construction of Vision Engineering products are intended to deliver superior ergonomic performance, reducing the exertion of the user to a minimum. Depending on the duration of uninterrupted work, appropriate measures should be taken to sustain optimal operator performance. This could include: Optimal arrangement of workplace; Variation in task activity; Training of personnel on workplace ergonomics and general health and safety principles.

It is important to set-up and optimize your working environment correctly in order to obtain maximum benefit from the advanced ergonomic design of your system. For more information visit: www.visioneng.com/ergonomics.

COMPLIANCE STATEMENTS

Vision Engineering and its products conforms to the requirements of the EC Directives on Waste Electrical and Electronic Equipment (WEEE) and Restriction of Hazardous Substances (RoHS).

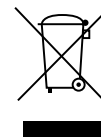

This product conforms to the UKCA and CE marks, demonstrating that it meets the requirements of the applicable directives.

UNPACKING PIXO & ERGO



- 1 Mantis PIXO or ERGO Head
- 2 Power Supply
- 3 Objective Lenses (3x, 4x, 6x, 8x, 10x, 15x, 6x SLWD, 8x SLWD as ordered)
- 4 Glare Hood
- 5 USB-C to USB-A Cable (PIXO only)
- 6 USB Stick with Software (PIXO only)

CONTROLS

PIXO & ERGO



Lens Turret Interface

IPD (interpupillary distance) Adjustment



Mounting Cover

Mounting Lock Point

Right Dimmer Control

Left Dimmer Control

On/Off Switch

5V USB-A Power Only Output

12V Power Input

Mounting Point

USC-C Camera Output (PIXO Only)

DIMMER CONTROLS

PIXO & ERGO

PIXO
ERGO

Left
Dimmer
Control



Right
Dimmer
Control

Use the On/Off switch on the rear right of the unit to switch the lighting off. This will turn on again with the same lighting settings as when it was turned off.

PIXO & ERGO HEADS WITH STANDARD LEDs HAVE 2 MODES OF OPERATION

Joint Lighting

- Left and Right LED arrays dim together.
- Control from either dimmer control.

Individual Control

- Left and Right LED arrays are dimmed individually.
- Right dimmer controls right LED array.
- Left dimmer controls left LED array.

Push in either dimmer control to alternate between individual & joint control.

WHITE - UV LIGHTING OPTION

- If you have the White-UV Lighting option fitting, press in both Left & Right Dimmer controls at the same time to toggle between White & UV LEDs.
- Controls for light intensity remain the same.



FITTING LENSES

PIXO & ERGO



THE PIXO & ERGO HEADS HAVE A 3 POSITION TURRET TO ALLOW THE USER TO EASILY SWITCH BETWEEN MULTIPLE LENSES.

Fitting the lens

Fitting can be done at any of the 3 lens positions, but the back right position offers the clearest access to the thumbscrew.

1. Make sure the thumbscrew is wound out enough to allow the lens to fit.
2. Insert top lip of lens into one of the 3 turret positions.
3. Push the lens up so it is as far in as it can go and flat.
4. Tighten up the thumbscrew to secure the lens.

To remove the lens, undo the thumbscrew while supporting the lens from below.

Fitting Super Long Working Distance Lenses

When fitting the Super Long Working Distance (SLWD) lenses, they can only be fitted in the front turret position & the turret will not be able to rotate when they are in place.

When in use the Super Long Working Distance Lenses require illumination deflectors to be fitted below the lighting. These deflectors focus the light in the correct place for optimum performance with the SLWD lenses.

To fit the illumination deflectors, place the left and right versions on the appropriate sides of the unit so it matches up with the mounting holes and covers the existing LEDs.

Use the fittings provided to screw the deflectors into place.

TURRET OPERATION

PIXO & ERGO



To switch between turret positions, gently rotate the turret clockwise or anti-clockwise to the desired position. There is a determined position where each lens lines up properly and will lock into position.

NOTE: All of the objectives are designed to be parfocal. When rotating the turret, the objective will remain in focus (excluding SLWD objectives).

CAMERA OPERATION

PIXO



USB-A end connects to PC



Connect USB-C cable to the rear of the PIXO head and connect the other end to your PC.
Follow the documents supplied with the software of choice for installation & viewing instructions.



Ensure that the USB-C to USB-A cable is USB3.0 or better.

UNPACKING

IOTA



1 Mantis IOTA Head

2 Power Supply

3 Objective Lenses (3x, 4x, 6x, 8x as ordered)

CONTROLS

IOTA



Lens Interface



DIMMER CONTROL OPERATION

The IOTA system has a single dimmer control on the right hand side of the unit which controls both the left and right LED arrays together.

Increase Brightness - Turn away from user



Decrease Brightness - Turn towards user



Turn off lighting - Press Dimmer In



FITTING LENSES

IOTA



REMOVE PROTECTOR CAP ON BOTTOM OF UNIT (IF FITTED) AND RETAIN FOR FUTURE USE

To fit the lens

1. Locate 3 tabs of the objective lens into the slots on base of the unit and push upwards.
2. Rotate to the right to lock the lens in place.

To remove lens

1. Rotate to the left to unlock the lens.
2. Pull downwards to remove.

UNPACKING VERSO ARM

VERSO ARM

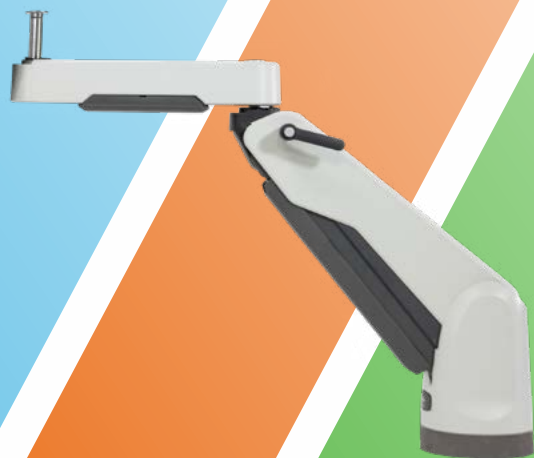

- 1** Verso Arm
- 2** Verso Base Mount
- 3** Verso Bench Clamp
- 4** Clamp Fixing Screws (4)
- 5** Dust Cover
- 6** Retaining and pivot washers
- 7** Verso Forearm Pack (Option)
 - A** Verso Forearm
 - B** Extension Power Cable
 - C** Pivot washer and screw

- 7** Verso Forearm Pack (Option)

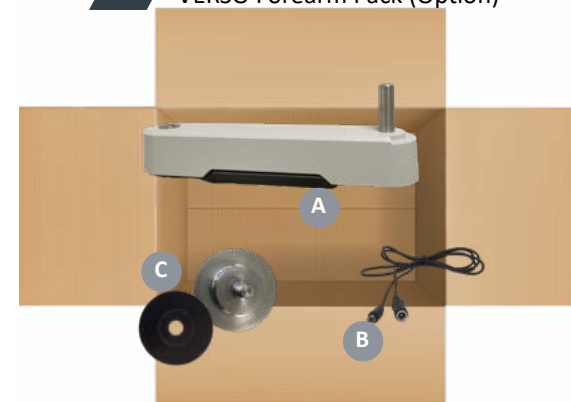

ASSEMBLY

VERSO ARM

VERSO ARM



VERSO base mount mounting options

B Bench Clamp

D Direct Mount

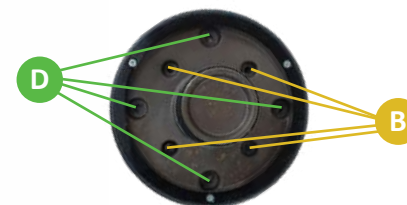

The VERSO arm can be mounted to a work-surface using either the Bench Clamp or by screwing directly onto a surface of sufficient strength.

If using the Bench Clamp, connect this to the Base Mount using the 4 fixings provided.

If mounting directly onto the work surface, use 4x M5 bolts and nuts (not provided) through the outer 4 holes of the Base Mount.

When Base Mount is secured to the work surface carefully lower the Verso arm onto the Base Mount until they are flush with no gap between them.

When located properly the VERSO arm should rotate easily.

FOREARM SETUP (OPTIONAL)

Place the washer on the pin then lower the Forearm onto the mounting pin on the end of the VERSO Arm.

Secure the Forearm with the Forearm screw provided.

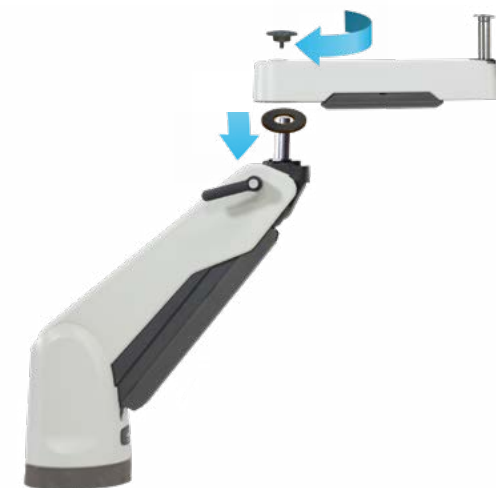

ADJUSTMENTS

VERSO ARM

VERSO ARM



Cable Tidy Cover

The VERSO arm counterbalance should be adjusted depending on the weight of the head mounted on it.

The weight varies between PIXO, ERGO, IOTA with objectives fitted and if the Forearm is used.

TO ADJUST THE COUNTERBALANCE

Remove the Cable Tidy Cover to expose the Thumbwheel adjuster.

- 1 Rotate the thumbwheel to the left (towards +) to increase the counterbalance for heavier loads (PIXO/ERGO).
- 2 Rotate the thumbwheel to the right (towards -) to decrease the counterbalance for lighter loads (IOTA).

Adjust the control until the arm balances unaided when placed in the middle of its travel.



Always make sure that the system is fully supported when adjusting the counterbalance.



ADJUSTMENTS

VERSO ARM



FRICTION BRAKE

Use the Friction Brake handle on the right hand side of the VERSO Arm to apply friction and/or lock the vertical movement of the arm in place.

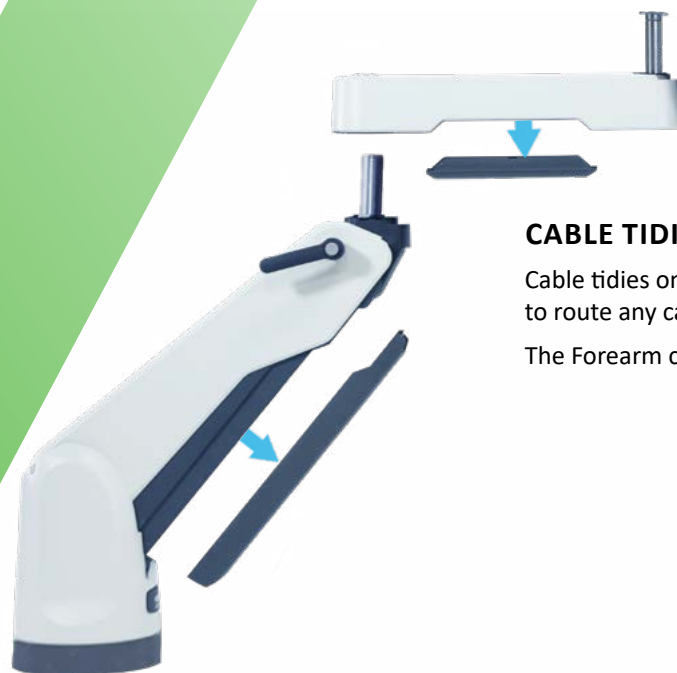

CABLE TIDIES

Cable ties on the VERSO Arm and the Forearm can be detached in order to route any cables down the arm.

The Forearm comes with a power extension cable.

ADJUSTMENTS

VERSO ARM



VERSO ARM MOVEMENT RESTRICTOR

This part is supplied with the x10 and x15 PIXO/ERGO objective lenses. This is recommended to be used when the x10 or x15 objectives are in use on an PIXO or ERGO head use mounted on the VERSO arm without the forearm extension.

The movement restrictor will prevent the x10 or x15 lenses from being able to impact the work surface when fitted.

TO FIT

Push the U end of the clip onto the pin between the Friction Brake and the top mounting point (1).

The clip should sit inside the moulding (2).

To remove pull out towards user (3).



Warning!

Always adjust head position with the “wings” on the head.

Be aware of potential finger traps from moving joints of the VERSO Arm.

UNPACKING STABILA STAND

- 1 STABILA Column
- 2 Cable Tidy Clip
- 3 Tools
- 4 Fixing Screw (2)
- 5 Dust Cover
- 6 Retaining washer and screw

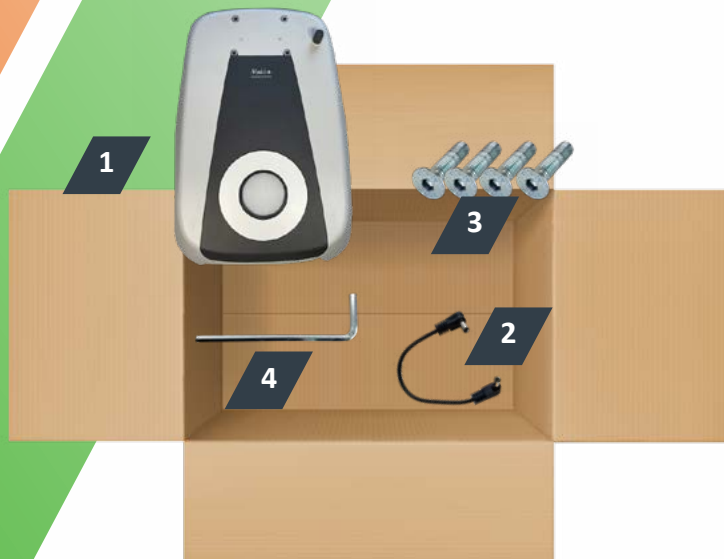

- 1 STABILA Stand Base
(with or without substage option)
- 2 Power Interface Cable (substage base only)
- 3 Fixing Screws (4)
- 4 Tools

ASSEMBLY STABILA STAND

STABILA STAND

ATTACHING COLUMN TO BASE

Lay the column horizontally on its back. Make sure this is on a flat surface and use some of the packaging foam to protect the back of the column.

Line up the column with the 4 holes in a square pattern.

Use the 4 screws and tool provided to secure the column to the base.

Make sure the column is properly aligned before fully tightening the screws.



CONNECTING POWER INTERFACE

STABILA STAND WITH A SUBSTAGE FITTED

Place the main input power into connector (3) with the supplied power interface cable connected between (1) & (2).

STABILA STAND WITHOUT A SUBSTAGE FITTED

Connectors (2) & (3) will not be present.

Place input power into connector (1).



Once connected to the main input power, the power connector at the front of the STABILA stand can then provide power to the head.

ATTACHING CABLE RETAINING CLIP

There is an optional Cable Retaining Clip supplied with the STABILA stand. This is designed to retain and tidy cables running to the head (Such as USB when using the PIXO head).

To fit this use the screws provided to secure the clip to the pre-drilled holes on the left hand side of the column (see page 24).

INTERFACES

STABILA STAND

STABILA STAND



ADJUSTMENTS

STABILA STAND

STABILA STAND



ADJUSTING THE FRICTION IN THE FOCUS MECHANISM

The friction in the focus mechanism can be adjusted for two reasons:

- Improves the operation of the stand for different head weights.
- Adjusts the tension to the user's preference.

Rotate the two focus adjustment knobs at the same time in opposite directions to adjust the friction.

- Rotating the right knob towards the user and left knob away from the user will decrease the friction.
- Rotating the right knob away from the user and left knob towards the user will increase the friction.

MOUNTING MANTIS HEAD

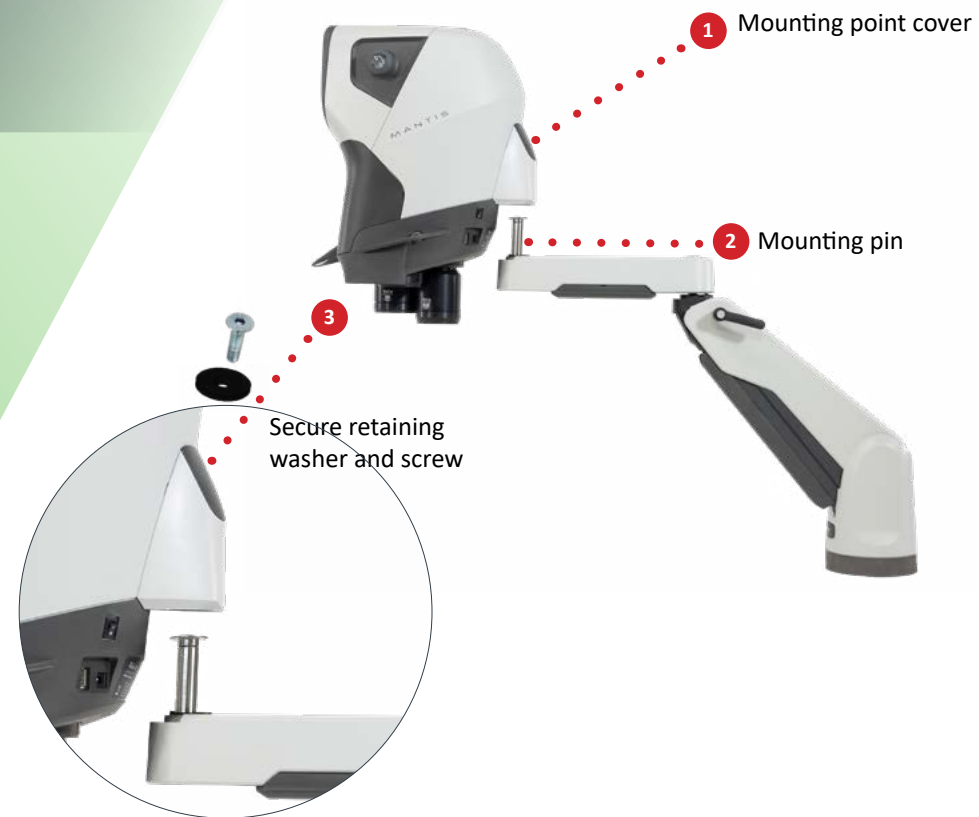

TO MOUNT ANY MANTIS HEAD TO A COMPATIBLE STAND FOLLOW THESE INSTRUCTIONS

1. Remove mounting point cover on head.
2. Place the pivot washer on the mounting pin and lower the head onto the mounting pin and make sure the head is mounted straight and the pin is all the way through the mounting hole.
3. Secure the head to the stand with the retaining washer and screw provided. Replace the mounting point cover on the head.

USER COMFORT

MANTIS



ADJUSTING THE MANTIS HEAD EYE SPACING

Adjust the IPD (Interpupillary distance) knob on the side of the Mantis head to obtain a comfortable stereo view. **Slowly** turn the knob until the subject being viewed can be seen comfortably in both eyes.

Adjusting the eye spacing is very important for viewing comfort and must be adjusted for each Mantis user.

ERGONOMIC VIEWING

An ergonomic posture will ensure that users fully benefit from the advantages provided by the Mantis optical technology.

When setting up your Mantis, firstly arrange your workspace, paying attention to the heights of the seat and worktop.

Adjust the height of the system so that you can look directly into it with a straight back and shoulders.

REDUCING GLARE WITHIN THE SYSTEM

For optimal performance, position the Mantis system so there are no bright lights behind the user. These can cause reflections which reduces image quality.

Reflections can be further reduced by using the Glare Hood accessory.

1. Fit the Glare Hood by pushing it into the viewing aperture until it clicks in and is secure.
2. Remove it by pressing on opposite sides of the outside of the Glare Hood to disengage the clips and pull off of the system.

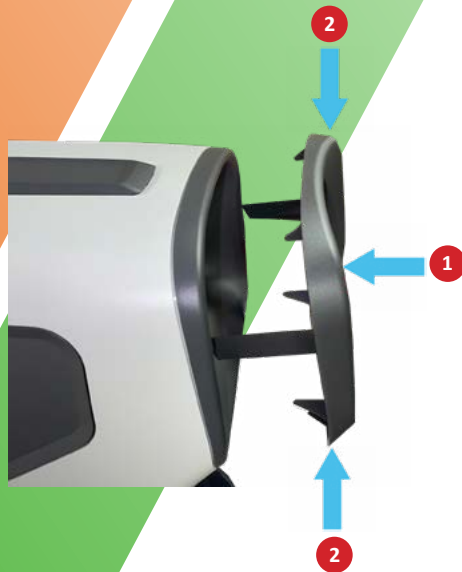

UNPACKING PILOT STAGE



- 1 Pilot Stage
- 2 Stage Pillars (4)
- 3 Fitting Screws (4)
- 4 Tools

ASSEMBLY

PILOT STAGE

PILOT STAGE

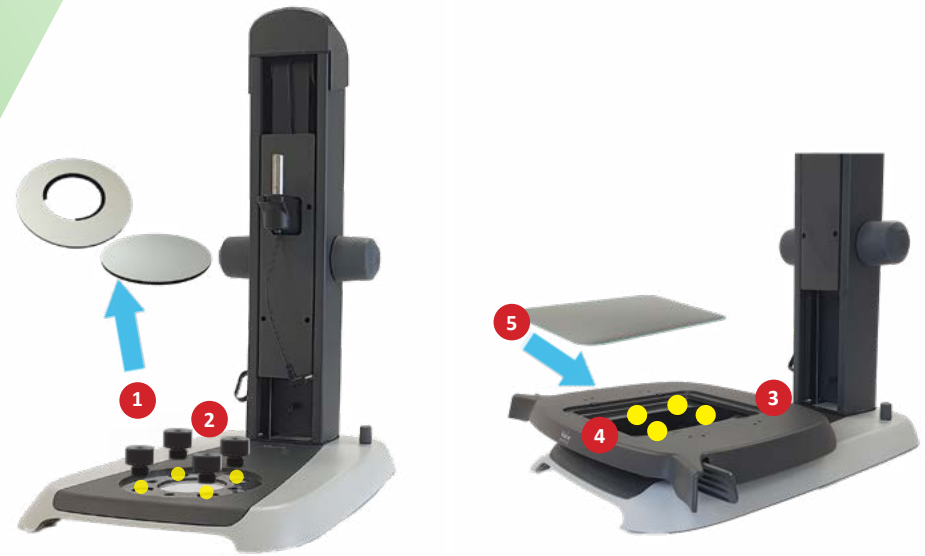

1. Remove the object plate or glass holder from your stand.
2. Fit 4x Stage Pillars to the holes in the stand.
3. Align the Pilot Stage (without stage glass) so the mounting holes line up with the stage pillars.
4. Fit the 4x screws with the provided tool to secure the stage in place.
5. Place the stage glass onto the top of the stage so it is flush with the top surface.

OPERATION

PILOT STAGE

PILOT STAGE



Press in the handles on either side of the Pilot Stage to release the brake mechanism.

Move the stage to the desired position and release the handle to apply the brake.

The handles can be used individually for one handed operation or together for greater precision.

NOTE: The brake mechanism is to provide a way of holding the stage in position. It does not lock the stage completely.

GENERAL CARE

CARING FOR YOUR MANTIS

CLEANING

- When not in use, cover your Mantis with the dust cover provided.
- Remove dust with a soft brush or cleaning cloth.
- The Mantis lenses should be cleaned with a lens cleaning cloth.
- Keep accessories in a dust-free environment when not in use.

SERVICE

Service and repair work must only be carried out by service engineers authorised by Vision Engineering.

ROUTINE MAINTENANCE

DESICCANT REPLACEMENT

The desiccant removes excess moisture from the optical head.

- Disconnect the power supply from the bottom of the head.
- Remove the desiccant cover.
- Insert the new desiccant and replace the desiccant cover.

Desiccant cover



LED REPLACEMENT

- Ensure that the Mantis head is disconnected from power.
- Remove the 2 retaining screw (front and back, the middle two should not be removed) (1).
- A T7 Torx head screwdriver is required for this .
- Pull down the LED module along with the connecting cable (2).
- Carefully disconnect LED Cable from module to be replaced (3).
- Attach new module to LED Cable.
- Replace the black LED blind if this has fallen out during this process (4).
- Feed any excess cable into the head and refit the LED module .
- Secure with the 2 retaining screws previously removed .
- Repeat on other side if required.



TROUBLESHOOTING

NO POWER

- Check that jack plug is fully home in the socket.

IMAGE LOOKS BLURRED

- The lens could be dirty. The lens can be cleaned gently with a soft, dry cloth. A damp or course cloth can damage the coating and polished surface on the lens.
- Ensure the objective lens is properly housed in the head.

IMAGE CAN ONLY BE SEEN IN ONE EYE

- Adjust your head so you are looking directly into the viewing area of the unit .
- Use the IPD adjuster on the side of the unit to optimize for the user's eye spacing.

ONLY ONE SIDE OF THE LIGHTING IS WORKING

- On a PIXO or ERGO head press in either dimmer control to synchronise the left and right lighting and allow them to be controlled together.

REFLECTIONS CAN BE SEEN WITHIN THE HEAD

- Position the system to reduce strong sources of light from behind the user.
- Fit the glare hood accessory (provided with PIXO & ERGO heads, optional accessory with IOTA).

ADDITIONAL SUPPORT CAN BE FOUND AT: www.visioneng.com/support

SERVICE RECORD

SERVICE	COMMENTS	DATE OF SERVICE	NEXT SERVICE DATE	COMPANY	SIGNATURE

WARRANTY

This product is warranted to be free from defects in material and workmanship for a period of two years from the date of invoice to the original purchaser.

If during the warranty period the product is found to be defective, it will be repaired or replaced at facilities of Vision Engineering or elsewhere, all at the option of Vision Engineering. However, Vision Engineering reserves the right to refund the purchase price if it is unable to provide replacement, and repair is not commercially practicable or cannot be timely made. Parts not of Vision Engineering manufacture carry only the warranty of their manufacturer. Expendable components such as fuses carry no warranty.

This warranty does not cover damage in transit, damage caused by misuse, neglect, or carelessness, or damage resulting from either improper servicing or modification by other than Vision Engineering approved service personnel. Further, this warranty does not cover any routine maintenance work on the product described in the user guide or any minor maintenance work which is reasonably expected to be performed by the purchaser.

No responsibility is assumed for unsatisfactory operating performance due to environmental conditions such as humidity, dust, corrosive chemicals, deposition of oil or other foreign matter, spillage, or other conditions beyond the control of Vision Engineering.

Except as stated herein, Vision Engineering makes no other warranties, express or implied by law, whether for resale, fitness for a particular purpose or otherwise. Further, Vision Engineering shall not under any circumstances be liable for incidental, consequential or other damages.

	PIXO				ERGO				IOTA			
Optical												
Compatible Objective	3X	4X	6X	8X	10X	15X	6X SLWD	8X SLWD	3X	4X	6X	8X
Max. Working Distance (mm)	100	100	68	60	54	40	114	113	104	108	74	61
Measured Max FoV (mm)	44.1	35.7	24.2	18	14.2	9.1	22.5	17.9	37.0	29.0	20.1	15.0
Pupil Diameter (mm)	23.5	23.6	22.4	19.4	17.0	12.3	17.0	14.4	22.8	23.6	22.0	18.0
Illumination												
Incident options												
Brightness	~21 k lux max								~26 k lux max			
Colour Temp	5500K at max brightness								5500K			
Control	25 steps								25 steps			
Transmitted (STABILIA Stand Illuminated Base)												
Brightness	36 k lux											
Colour Temp	~4800K											
Control	25 steps											
White and UV Illumination												
Intensity	White: 11k lux UV: 0.47 k lux, 53µW/cm² max								-			
Peak Wave Length	~385nm								-			
Control	25 steps								-			
Size (Head Only)												
Depth x Width x Height	275mm x 218mm x 371mm								271mm x 196mm x 324mm			
Weight	PIXO				ERGO				IOTA			
Max. Operating (kg)	6.5				6.4				3.5			
Head Only (kg)	4.5				4.4				3.2			
Stands												
	VERSO ARM	VERSO FOREARM	STABILIA BASE	PILOT STAGE								
Focus Travel	230mm	-	150mm	100mm x 100mm travel stage with auto lock to prevent unwanted movement								
Throat Depth	502mm	+253mm	218mm									
Max. Subject	166mm	+10mm	146mm									

PIXO	
Camera (PIXO Only)	
Camera Resolution	5.04 Mp
Best Capture Resolution	2592 x 1944
Frame Refresh Rate (max)	48 frames per second
Sensor Type	Rear-illuminated CMOS
Colour Depth	12-bit
Interface	SuperSpeed USB3
Output Connection	USC-C to PC
Image Capture Formats (supplied software)	PNG, BMP, JPG
Saved Image Sizes at Full Resolution (supplied software)	PNG - ~19MB BMP - ~19MB JPG - ~400KB
Supplied Software	ViCapture iDS UEye Peak Software
Optional Software	ViFox EVO DimensionOne DimensionTwo ViPlus

PIXO ERGO IOTA

STABILA Stand		
A (Workbench to top of the head)	513–663mm	449–559mm
B (throat, optical axis to column)	218mm	218mm
C (length)	422mm	422mm
D (width)	290mm	290mm
E (Top of STABILA to bottom head/objective)	246mm max	239mm max
STABILA Stand with pilot stage		
A (Workbench to top of the head)	513–663mm	449–559mm
B (throat, optical axis to column)	218mm	218mm
C (length incl. movement)	475mm max	475mm max
D (width incl. movement)	520mm max	520mm max
E (Top of STABILA to bottom head/objective)	212mm max	205mm max
VERSO Arm		
A (Workbench to top of the head)	429–652mm	360–590mm
B (throat, optical axis to column)	380–505mm	375–503mm
C (length)	575–695mm	590–710mm
D (Work surface to bottom head/objective)	40–285mm	39–263mm
VERSO Arm with forearm		
A (Workbench to top of the head)	482–710mm	416–639mm
B (throat, optical axis to column)	630–755mm	630–750mm
C (length)	825–945mm	840–960mm
D (Work surface to bottom head/objective)	106–337mm	94–316mm

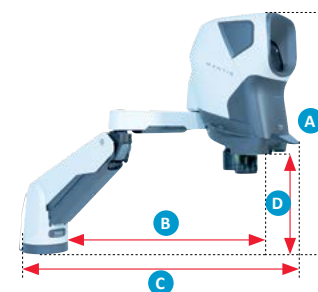
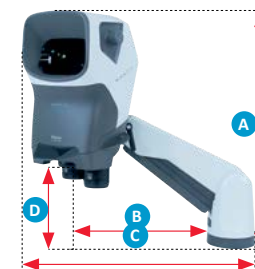
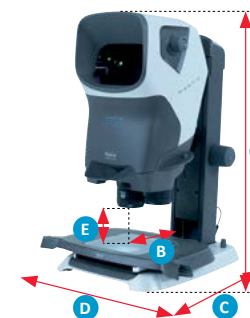

SERIAL NUMBER

The images below indicate where you can find the serial number on each Mantis head and stand.



Mantis PIXO/ERGO/IOTA HEAD



VERSO ARM



STABILA STAND



ITEM	PART NUMBER
MANTIS PIXO HEAD OPTIONS	
MANTIS PIXO 5MP	MPH001
MANTIS PIXO white/UV 5MP	MPH003
MANTIS PIXO LENS OPTIONS	
3X	MTO003
4X	MTO004
6X	MTO006
8X	MTO008
10X	MTO0010
15X	MTO0015
6X SLWD	MTO007
8X SLWD	MTO009
MANTIS PIXO STAND OPTIONS	
STABILA COLUMN	MTB210
STABILA PLAIN BASE (USED WITH STABILA COLUMN)	MTB211
STABILA ILLUMINATED BASE (USED WITH STABILA COLUMN)	MTB212
VERSO ARM	MTB200
VERSO FOREARM (USED WITH VERSO ARM)	MTB201
MANTIS PIXO SOFTWARE OPTIONS	
DIMENSIONONE	VIS003
DIMENSIONTWO	VIS004
ViPLUS	VIS001
ViFOX EVO	VIS005

ITEM	PART NUMBER
ACCESSORIES	
DUST COVER	MTA360
PILOT STAGE	MTB220
CONTRAST ENHANCING BASE	TMB001
PLAIN TILTING STAGE	TSG001
THREADED TILTING STAGE	TSG002
LENS PROTECTION CAPS FOR 3X, 4X, 6X, 8X AND 10X LENSES	MTA310
LENS PROTECTION CAPS FOR SLWD LENSES	MTA312
EPI ILLUMINATOR	MTS350
24" MONITOR, HDMI	MHM140
REPLACEMENT PARTS	
REPLACEMENT VERSO MAIN CABLE TIDY	MTB202
REPLACEMENT VERSO FOREARM CABLE TIDY	MTB203
REPLACEMENT WHITE LED	MTA401
REPLACEMENT WHITE/UV LED	MTA404
REPLACEMENT GLARE SHIELD	MTA402
REPLACEMENT GLARE HOOD	MTA403
REPLACEMENT ILLUMINATION DEFLECTORS	MTA320
REPLACEMENT PSU	MTA330
DESICCANT	HDW5784



ITEM	PART NUMBER
MANTIS ERGO HEAD OPTIONS	
MANTIS ERGO	MRH001
MANTIS ERGO white/UV	MRH002
MANTIS ERGO LENS OPTIONS	
3X	MTO003
4X	MTO004
6X	MTO006
8X	MTO008
10X	MTO0010
15X	MTO0015
6X SLWD	MTO007
8X SLWD	MTO009
MANTIS ERGO STAND OPTIONS	
STABILA COLUMN	MTB210
STABILA PLAIN BASE (USED WITH STABILA COLUMN)	MTB211
STABILA ILLUMINATED BASE (USED WITH STABILA COLUMN)	MTB212
VERSO ARM	MTB200
VERSO FOREARM (USED WITH VERSO ARM)	MTB201

ITEM	PART NUMBER
ACCESSORIES	
DUST COVER	MTA360
PILOT STAGE	MTB220
CONTRAST ENHANCING BASE FOR USE WITH BOOM STAND	TMB001
PLAIN TILTING STAGE	TSG001
THREADED TILTING STAGE	TSG002
LENS PROTECTION CAPS FOR 3X, 4X, 6X, 8X AND 10X LENSES	MTA310
LENS PROTECTION CAPS FOR SLWD LENSES	MTA312
EPI ILLUMINATOR	MTS350
REPLACEMENT PARTS	
REPLACEMENT VERSO MAIN CABLE TIDY	MTB202
REPLACEMENT VERSO FOREARM CABLE TIDY	MTB203
REPLACEMENT WHITE LED	MTA401
REPLACEMENT WHITE/UV LED	MTA404
REPLACEMENT GLARE SHIELD	MTA402
REPLACEMENT GLARE HOOD	MTA403
REPLACEMENT ILLUMINATION DEFLECTORS	MTA320
REPLACEMENT PSU	MTA330
DESICCANT	HDW5784



ITEM	PART NUMBER
MANTIS IOTA HEAD OPTIONS	
MANTIS IOTA	MIH001
MANTIS IOTA LENS OPTIONS	
3X	MTO103
4X	MTO104
6X	MTO106
8X	MTO108
MANTIS IOTA STAND OPTIONS	
STABILA COLUMN	MTB210
STABILA PLAIN BASE (USED WITH STABILA COLUMN)	MTB211
STABILA ILLUMINATED BASE (USED WITH STABILA COLUMN)	MTB212
VERSO ARM	MTB200
VERSO FOREARM (USED WITH VERSO ARM)	MTB201

ITEM	PART NUMBER
ACCESSORIES	
DUST COVER	MTA360
PILOT STAGE	MTB220
CONTRAST ENHANCING BASE FOR USE WITH BOOM STAND	TMB001
PLAIN TILTING STAGE	TSG001
THREADED TILTING STAGE	TSG002
IOTA LENS PROTECTION CAPS FOR 3X, 6X, 8X LENSES	MTA311
IOTA LENS PROTECTION CAPS FOR 4X LENS	MTA313
REPLACEMENT PARTS	
REPLACEMENT VERSO MAIN CABLE TIDY	MTB202
REPLACEMENT VERSO FOREARM CABLE TIDY	MTB203
REPLACEMENT WHITE LED	MTA411
REPLACEMENT GLARE SHIELD	MTA412
REPLACEMENT GLARE HOOD	MTA413
REPLACEMENT PSU	MTA330
DESICCANT	HDW5784

HOW TO VIDEOS

Unpacking

Mantis PIXO or ERGO Head

Mantis IOTA head

Assembly & Operation

Assemble Mantis on Stabila Stand

Assemble Mantis on Verso Arm

Assemble Mantis on Verso Arm with extension

Basic operation of Mantis PIXO

Basic operation of Mantis ERGO

Basic operation of Mantis IOTA

Fixing Pilot stage to Stabila stand

Vision Engineering Ltd. has been designing and manufacturing high quality ergonomic microscopes, digital instruments, inspection and non-contact measuring systems for over 60 years.

Vision Engineering has a network of offices and technical distributors around the world. For more information, please contact your Vision Engineering branch, local authorised distributor, or visit our website.

www.visioneng.com

Regional Support Websites

www.visioneng.com/support
www.visioneng.us/support
www.visioneng.de/support
www.visioneng.fr/support
www.visioneng.it/support
www.visioneng.com.mx/soporte
www.visioneng.com.br/suporte
www.visioneng.jp/support
kr.visioneng.com/support
www.visioneng.es/soporte
www.visioneng.com.cn



Vision Engineering Ltd. (UK Manufacturing & Commercial)
The Freeman Building, Galileo Drive
Send, Surrey, GU23 7ER, UK
T +44 (0) 1483 248300
E generalinfo@visioneng.co.uk

Vision Engineering Inc. (NA Manufacturing & Commercial)
570 Danbury Road,
New Milford, CT 06776, USA
T +1 (860) 355 3776
E info@visioneng.com

Vision Engineering Inc. (Commercial)
16 Technology Drive
Suite 148
Irvine, CA 92618, USA
T +1 (860) 355 3776
E info@visioneng.com

Vision Engineering Ltd. (Italia)
Via G. Paisiello 106
20092 Cinisello Balsamo MI, Italia
T +39 02 6129 3518
E info@visioneng.it

Vision Engineering (South East Asia)
P-03A-20, Impian Meridian,
Jalan Subang 1, USJ 1,
47600 Subang Jaya,
Selangor Darul Ehsan, Malaysia
T +604-619 2622
E info@visioneng.asia

Vision Engineering (Mexico)
BIT Center
Blvd. Díaz Ordaz No. 12415
Local M2-6, Fracc. El Paraíso
22106, Tijuana, B.C. Mexico
T 800 099 5325
E infomx@visioneng.com

Vision Engineering Ltd. (France)
ZAC de la Tremblaie,
Av. de la Tremblaie
91220 Le Plessis Paté, France
T +33 (0) 160 76 60 00
E info@visioneng.fr

Vision Engineering (China)
Room 904B, Building B, No.970
Nanning Road, Xuhui Vanke Center
Shanghai, 200235, P.R. China
T +86 (0) 21 5036 7556
E info@visioneng.com.cn

Vision Engineering (Brazil)
E info@visioneng.com.br

Vision Engineering (Latin America)
Centro Coyol Innovación y Servicios
50 mts Sur de Riteve, Coyol
Alajuela, Costa Rica
T 0 8000 320059
E info@visioneng.com

Vision Engineering Ltd. (Central Europe)
Anton-Pendele-Str. 3,
82275 Emmerring, Deutschland
T +49 (0) 8141 40167-0
E info@visioneng.de

Nippon Vision Engineering (Japan)
272-2 Saedo-cho, Tsuduki-ku,
Yokohama-shi, Kanagawa
224-0054, Japan
T +81 (45) 935 1117
E info@visioneng.jp

Vision Engineering (India)
T + 91 (0) 80-5555-33-60
E info@visioneng.co.in



FM 557119

Vision Engineering Ltd.
has been certified for the
quality management
system ISO 9001:2015