

# PA900

## PRECISION MULTI-CHANNEL HARMONIC POWER ANALYZER

### OPERATING MANUAL



<b>1</b>	<b>ABOUT THIS MANUAL</b> .....	<b>7</b>
<b>2</b>	<b>WARRANTY INFORMATION</b> .....	<b>8</b>
<b>3</b>	<b>PRODUCT FEATURES</b> .....	<b>9</b>
<b>4</b>	<b>SAFETY</b> .....	<b>11</b>
4.1	SAFETY SPECIFICATIONS .....	11
4.2	POWER AND GROUNDING.....	11
4.3	TERMINALS AND WIRING.....	11
4.4	ENVIRONMENT.....	11
<b>5</b>	<b>INSPECTION</b> .....	<b>12</b>
<b>6</b>	<b>FRONT AND REAR PANEL LAYOUT</b> .....	<b>13</b>
6.1	FRONT PANEL LAYOUT .....	13
6.2	REAR PANEL LAYOUT.....	13
<b>7</b>	<b>GETTING STARTED</b> .....	<b>14</b>
<b>8</b>	<b>APPLICATIONS</b> .....	<b>16</b>
8.1	CHANNELS.....	16
8.1.1	<i>Electrical Channels</i> .....	16
8.1.2	<i>Mechanical Channel</i> .....	16
8.2	VIRTUAL POWER ANALYZERS (OR VPA).....	16
8.3	TYPICAL SINGLE VPA APPLICATIONS.....	17
8.4	TYPICAL DUAL VPA APPLICATIONS .....	18
8.5	TYPICAL TRIPLE VPA APPLICATIONS .....	19
8.6	MECHANICAL (MOTOR/GENERATOR) APPLICATIONS.....	19
<b>9</b>	<b>WIRING TO CHANNELS</b> .....	<b>20</b>
9.1	1 $\emptyset$ WIRING USING INTERNAL CURRENT MEASUREMENT.....	20
9.2	1 $\emptyset$ WIRING USING EXTERNAL CURRENT MEASUREMENT .....	21
9.3	1 $\emptyset$ WIRING USING LPA-1 ADAPTOR.....	22
9.4	2 $\emptyset$ 3W OR 3 $\emptyset$ 3W(2CH) WIRING USING INTERNAL CURRENT MEASUREMENT.....	23
9.5	2 $\emptyset$ 3W OR 3 $\emptyset$ 3W(2CH) WIRING USING EXTERNAL CURRENT MEASUREMENT .....	24
9.6	3 $\emptyset$ 3W(3CH) OR 3 $\emptyset$ 4W WIRING USING INTERNAL CURRENT MEASUREMENT.....	25
9.7	3 $\emptyset$ 3W(3CH) OR 3 $\emptyset$ 4W WIRING USING EXTERNAL CURRENT MEASUREMENT .....	26
9.8	MECHANICAL (MOTOR) MEASUREMENT WIRING .....	26
9.8.1	<i>Mechanical Speed and Direction Inputs</i> .....	27
9.8.2	<i>Mechanical Torque Inputs</i> .....	27
<b>10</b>	<b>POWERING THE PA900</b> .....	<b>28</b>
10.1	TURNING POWER ON.....	28
10.2	TURNING POWER OFF .....	28
<b>11</b>	<b>MEASUREMENT RESULT TERMINOLOGY</b> .....	<b>29</b>
11.1	WIRING PHASE INDICATIONS.....	29
11.2	LEADING/LAGGING DETERMINATION .....	29
11.3	PEAK AND VALLEY RESULTS .....	29
11.4	INDIVIDUAL CHANNEL RESULTS .....	29
11.5	INDIVIDUAL VPA TOTAL RESULTS .....	30
11.5.1	<i>Voltage Results</i> .....	30
11.5.2	<i>Wye Voltage Result</i> .....	30
11.5.3	<i>Delta Voltage Result</i> .....	30
11.5.4	<i>Current Results</i> .....	30
11.5.5	<i>Watts Results</i> .....	30
11.5.6	<i>VAR and VA Results</i> .....	30
11.5.7	<i>Power Factor Results</i> .....	30
11.6	INRUSH RESULTS .....	30
11.7	PHASE RESULTS.....	30
11.7.1	<i>Non-Harmonic Phase Results</i> .....	31
11.7.2	<i>Harmonic Phase Results</i> .....	31
11.8	RELATIVE INDIVIDUAL HARMONICS RESULTS.....	31
11.9	PERCENTAGE DISTORTION RESULTS .....	31
11.10	THC, POHC AND PWHC RESULTS.....	31
11.11	MECHANICAL (MOTOR) RESULTS .....	31
<b>12</b>	<b>OPERATING FROM THE FRONT PANEL</b> .....	<b>32</b>
12.1	TOUCH PANEL.....	32
12.1.1	<i>Buttons</i> .....	32

12.2	MAIN SCREEN LAYOUT .....	32
12.2.1	Main Screen Select Buttons .....	32
12.2.2	Remote Button .....	33
12.2.3	Power Button .....	33
12.2.4	Data Area .....	33
12.2.5	Error Info Area .....	33
12.2.6	Holding or Releasing Measurements .....	33
12.2.7	Integration Info Area .....	34
12.2.8	USB Drive Info Area .....	34
12.2.9	Interface Info Area .....	34
12.2.10	Time and Date Info Area .....	34
12.3	SYSTEM CONFIGURATION AND VIEWING BUILD INFORMATION – THE SYS CONFIG SCREEN .....	34
12.3.1	Saving and Recalling Configuration Settings .....	35
12.3.2	Setting Power and Measurement User Preferences .....	35
12.3.3	Configuring the Interface .....	38
12.3.4	Setting the Clock and Time/Date Formats .....	39
12.3.5	Upgrading the PA900 Option Content .....	39
12.4	CONFIGURING MEASUREMENTS – THE MEAS CONFIG SCREEN .....	39
12.4.1	Selecting the Overall Measurement Mode .....	40
12.4.2	Configuring a VPA .....	40
12.4.3	Configuring Mechanical Measurements (Motor or Generator) .....	45
12.4.4	Importing, Exporting or Recording the Measurement Configuration .....	46
12.5	VIEWING NUMERICAL MEASUREMENTS – THE POWER DATA SCREEN .....	47
12.5.1	Viewing Measurement Results for an Individual Channel .....	47
12.5.2	Viewing Measurement Results for a VPA .....	50
12.5.3	Viewing Efficiency and Power Loss Measurement Results .....	52
	Viewing Mechanical Measurement Results .....	52
	Exporting or Recording Measurements .....	53
12.6	VIEWING CUSTOM NUMERICAL MEASUREMENTS – THE CUSTOM DATA SCREEN .....	53
12.7	VIEWING HARMONICS MEASUREMENTS – THE HARMONICS SCREEN .....	54
12.7.1	Using the Numerical Listing .....	55
12.7.2	Comparing Harmonics Against Limits .....	55
12.7.3	Exporting or Recording Harmonics .....	56
12.8	VIEWING FUNDAMENTAL SIGNAL VECTORS - THE VECTORS SCREEN .....	56
12.8.1	Recording Vectors .....	57
12.9	GRAPHICALLY VIEWING PAST MEASUREMENTS – THE HISTORY SCREEN .....	57
12.9.1	Selecting and Configuring the Traces to Show .....	58
12.9.2	Changing the way in which time is displayed on the Chart .....	58
12.9.3	Starting, Stopping, and Restarting the Chart .....	59
12.9.4	Prohibiting Data Collection Temporarily .....	59
12.9.5	Using the Cursor and Zooming the Chart .....	59
12.9.6	Rescaling the Chart Traces .....	59
12.9.7	Exporting or Recording History .....	59
12.9.8	Historical Data Availability .....	60
12.10	USING THE PA900 AS AN OSCILLOSCOPE – THE SCOPE SCREENS .....	62
12.10.1	Viewing Periodic Waveforms – the CYCLE VIEW Screen .....	62
12.10.2	An Oscilloscope – the SCOPE VIEW Screen .....	64
12.11	PERFORMING EN50564 LOW POWER MEASUREMENTS – THE STBY POWER SCREEN .....	68
12.12	PERFORMING EN61000-3-2 OR -12 ASSESSMENTS – THE ASSESS EUT SCREEN .....	68
12.13	PERFORMING AND VIEWING A SPECTRUM ANALYSIS – THE SPECTRUM SCREEN .....	68
12.13.1	Configuring Spectrum Analysis .....	68
12.13.2	Optimising Configuration for Spectrum Measurements .....	68
12.13.3	Holding Measurements While Performing Spectrum Analysis .....	69
12.13.4	Viewing Spectrum Analysis Results .....	69
12.13.5	Exporting or Recording SPECTRUM Data .....	69
<b>13</b>	<b>OPTIMIZING LOW-LEVEL DC PERFORMANCE .....</b>	<b>71</b>
13.1	INTERNAL DC ZERO ADJUSTMENT .....	71
13.2	EXTERNAL DC ZERO ADJUSTMENT .....	71
13.3	USING AN X CURRENT OPTION INPUT AT LOW LEVELS .....	71
<b>14</b>	<b>PERFORMING STARTUP OR INRUSH MEASUREMENTS .....</b>	<b>72</b>
14.1	OBTAINING A GRAPHICAL AND NUMERICAL INRUSH CURRENT MEASUREMENT .....	72
14.2	OBTAINING A NUMERICAL INRUSH CURRENT MEASUREMENT .....	74
14.3	RECORDING INRUSH DATA .....	75
<b>15</b>	<b>INTEGRATING DATA .....</b>	<b>76</b>
15.1	CONFIGURING INTEGRATION .....	76
15.1.1	Selecting to Perform Manually Timed Integration .....	76
15.1.2	Selecting to Perform an Automatically Timed Integration .....	76

15.2	STARTING AND STOPPING INTEGRATION .....	77
15.3	EXPORTING OR RECORDING INTEGRATED MEASUREMENTS .....	77
<b>16</b>	<b>PERFORMING MEASUREMENTS OF PWM GENERATED SIGNALS.....</b>	<b>79</b>
16.1	CHOICE OF CHANNELS .....	79
16.2	WIRING RECOMMENDATIONS .....	79
16.2.1	<i>Recommended 3-phase, 3-wire Wiring Method Selection.....</i>	79
16.3	CONFIGURATION RECOMMENDATIONS .....	80
16.3.1	<i>Recommended FREQ SPEED System Preference.....</i>	80
16.3.2	<i>Recommended MEAS CONFIG Settings.....</i>	80
16.3.3	<i>PWM Generator Efficiency Measurements .....</i>	81
<b>17</b>	<b>PERFORMING EN50564 LOW POWER MEASUREMENTS .....</b>	<b>83</b>
17.1.1	<i>VPA Measurement Configuration for EN50564:2011 Measurements .....</i>	83
17.1.2	<i>Low Power Measurement Configuration.....</i>	84
17.1.3	<i>Performing a Low Power Measurement and Viewing the Results.....</i>	86
17.1.4	<i>Recording STBY POWER Data.....</i>	87
<b>18</b>	<b>TESTING COMPLIANCE TO HARMONICS EMISSIONS STANDARDS.....</b>	<b>88</b>
18.1	STANDARDS COMPLIANCE .....	88
18.1.1	<i>Relevant Standards.....</i>	88
18.1.2	<i>Supply, PA900 and EUT Wiring .....</i>	89
18.1.3	<i>Repeatability Requirements.....</i>	90
18.1.4	<i>EUT Classifications and Limits Selection .....</i>	90
18.1.5	<i>Range of PA900 Measurements for Compliance .....</i>	91
18.1.6	<i>Compliance Tests Performed by the PA900 During Assessment .....</i>	93
18.2	CONFIGURING THE PA900 FOR EN61000-3-2 OR -12 MEASUREMENTS .....	94
18.3	USING THE OTHER RESULTS SCREENS .....	95
18.3.1	<i>Using the HARMONICS Screen.....</i>	95
18.4	PERFORMING AN ASSESSMENT OF A EUT .....	95
18.4.1	<i>Selecting the Channel to View Results.....</i>	95
18.4.2	<i>Selecting How the Limits Reference(s) are Obtained.....</i>	96
18.4.3	<i>Configuring and Starting an Assessment .....</i>	96
18.4.4	<i>Viewing the Results of an Assessment.....</i>	98
18.4.5	<i>Changing the Configuration and Reassessing the EUT .....</i>	101
18.4.6	<i>Continuing a Paused Assessment.....</i>	101
18.4.7	<i>Stopping an Assessment.....</i>	101
18.4.8	<i>Recording the Results of an Assessment .....</i>	101
<b>19</b>	<b>MEASURING ELECTRICAL POWER TO EN60034-2-1 REQUIREMENTS .....</b>	<b>104</b>
<b>20</b>	<b>MEASURING ELECTRICAL POWER TO AVIONICS REQUIREMENTS .....</b>	<b>106</b>
20.1	CONNECTING THE PA900.....	106
20.2	CONFIGURING THE MEASUREMENTS MADE BY THE PA900 .....	106
20.2.1	<i>AC 3-phase Supplies.....</i>	106
20.2.2	<i>AC 1-phase Supplies.....</i>	107
20.2.3	<i>DC Supplies.....</i>	108
20.3	USING THE PA900 TO MONITOR THE SUPPLY .....	108
20.3.1	<i>Confirming the Voltage and Frequency of the Supply.....</i>	108
20.3.2	<i>Confirming the Voltage Modulation Depth of the Supply.....</i>	108
20.3.3	<i>Confirming the DC Voltage Content of the Supply.....</i>	109
20.3.4	<i>Confirming the Voltage Distortion of the Supply.....</i>	109
20.3.5	<i>Confirming the Voltage Ripple Content of the Supply.....</i>	109
20.4	USING THE PA900 TO TEST COMPLIANCE TO LOADING REQUIREMENTS.....	109
20.4.1	<i>Testing the Load Current Distortion Meets Requirements .....</i>	110
20.4.2	<i>Testing the Load Phase Imbalance Meets Requirements .....</i>	110
20.4.3	<i>Testing the Load DC Current Content Meets Requirements.....</i>	110
20.4.4	<i>Testing the Load Inrush Current Meets Requirements.....</i>	110
20.4.5	<i>Testing the Load Current Modulation Meets Requirements .....</i>	111
20.4.6	<i>Testing the Load Power Factor Meets Requirements .....</i>	111
<b>21</b>	<b>SHARING MEASUREMENTS AND ACTIVITIES WITHIN MULTIPLE INSTRUMENTS.....</b>	<b>112</b>
21.1	INTERCONNECTING MULTIPLE PA900s.....	112
21.1.1	<i>Interconnecting Not Using the LAN Interface with a Computer .....</i>	112
21.1.2	<i>Interconnecting While Also Using the LAN Interfaces with a Computer .....</i>	112
21.1.3	<i>Having Several Groups of PA900s Within a Single Network.....</i>	112
21.2	CONFIGURING MULTI-UNIT CAPABILITY .....	112
21.3	SYNCHRONIZING MEASUREMENTS WITHIN A GROUP OF UNITS .....	113
21.4	HOLDING AND RELEASING MEASUREMENTS IN A GROUP OF UNITS .....	113
21.5	STARTING, STOPPING AND CONFIGURING INTEGRATION IN A GROUP OF UNITS .....	113

21.6	STARTING AND STOPPING HISTORICAL DATA COLLECTION IN A GROUP OF UNITS .....	113
21.7	IN, MID AND OUT TOTAL POWER AND EFFICIENCY DATA IN A GROUP OF UNITS .....	114
<b>22</b>	<b>SYNCHRONIZING MEASUREMENTS BETWEEN VPAS .....</b>	<b>115</b>
<b>23</b>	<b>USING A USB DRIVE .....</b>	<b>117</b>
23.1	DRIVE COMPATIBILITY .....	117
23.2	CHECKING DRIVE COMPATIBILITY.....	117
23.3	FILES .....	118
23.4	CHECKING THE DRIVE FILE STRUCTURE .....	118
23.5	EXPORTING FILES TO A DRIVE .....	118
23.5.1	Screen Image File (.BMP Extension).....	119
23.5.2	Binary (.CFG Extension) Files.....	119
23.5.3	Comma Separated Value (.CSV Extension) Files.....	119
23.6	IMPORTING FILES FROM A DRIVE .....	122
23.6.1	Importing Binary Configuration, Custom Screen and Harmonic Limits Files.....	122
23.6.2	Creating and Importing an ASCII Harmonics Limits File.....	123
23.6.3	Creating and Importing an ASCII Custom Screen Definition File .....	123
23.6.4	Updating the Firmware or the FPGA.....	125
23.6.5	Changing the Welcoming Screen .....	125
23.7	DATA LOGGING.....	125
23.7.1	Configuring the Data Log .....	126
23.7.2	Configuring Data Logging Timing .....	127
23.7.3	Configuring Data Logging Record Contents .....	127
23.7.4	Starting and Stopping Data Logging .....	128
23.7.5	Clearing the Data From a Completed Unsaved Data Log.....	128
23.7.6	Viewing Data Logging Status.....	128
23.7.7	Exporting a Data Log from the Internal Memory.....	129
23.7.8	Internal Buffer Usage.....	129
23.7.9	Optimizing and Testing File Write Speed.....	129
<b>24</b>	<b>USING THE PA900 FROM AN INTERFACE .....</b>	<b>131</b>
24.1	COMPUTER CONTROL OF THE PA900.....	131
24.1.1	RS232 (Serial) Interface .....	131
24.1.2	LAN (Ethernet) Interface.....	132
24.1.3	USB Interface.....	134
24.1.4	GPIB Interface .....	137
24.2	COMMAND SYNTAX .....	138
24.2.1	Special Characters.....	138
24.2.2	Fields within a Command.....	139
24.3	RESPONSES TO COMMANDS .....	140
24.3.1	Response Fields .....	140
24.4	COMMAND KEYWORDS AND FIELDS.....	141
24.4.1	Interface Clear Commands .....	141
24.4.2	Local/Remote State Control Commands.....	141
24.4.3	Unit and Channel Identification Query Commands.....	141
24.4.4	Error Register Query Commands.....	141
24.4.5	GPIB Specific Commands.....	142
24.4.6	Date and Time Control and Query Commands.....	143
24.4.7	System Preferences Set and Query Commands .....	143
24.4.8	Measurement State Control and Query Commands.....	143
24.4.9	Configuration Store and Recall Commands.....	144
24.4.10	Measurement Configuration Edit Commands .....	144
24.4.11	Measurement Configuration Query Commands .....	148
24.4.12	Configuration Temporary Save and Load Commands.....	151
24.4.13	Harmonics Limits Configuration and Configuration Query Commands.....	151
24.4.14	DC Zero Control and Query Commands.....	152
24.4.15	Custom Screen Configuration and Configuration Query Commands .....	152
24.4.16	Measurement Results Query Commands.....	153
24.5	RDEF MEASUREMENT DEFINITION FIELD SUB-FIELDS.....	154
24.6	DDEF MEASUREMENT DEFINITION FIELD SUB-FIELDS.....	157
<b>25</b>	<b>INSIDE THE PA900 .....</b>	<b>160</b>
25.1	GENERAL MEASUREMENT METHODS .....	160
25.2	CHANNEL CIRCUITRY .....	161
25.3	SAMPLING CONTROL.....	161
25.4	CHANNEL MEASUREMENTS .....	161
25.5	VPA MEASUREMENTS.....	162
25.5.1	VPA Fundamental Frequency.....	162
25.5.2	VPA Amplitude Measurements.....	162
25.6	DATA COLLECTION.....	162

25.7	INTEGRATED DATA .....	163
25.8	DATA LOGGING .....	163
<b>26</b>	<b>OPTIONS AND ACCESSORIES .....</b>	<b>164</b>
26.1	ACCESSORY RM-7 .....	164
26.2	ACCESSORY LPA-1 .....	164
<b>27</b>	<b>DIMENSIONAL, ENVIRONMENTAL AND POWER SUPPLY SPECIFICATIONS .....</b>	<b>165</b>
27.1	DIMENSIONAL .....	165
27.2	ENVIRONMENTAL .....	165
27.3	POWER SUPPLY .....	165
<b>28</b>	<b>ELECTRICAL CHANNEL INPUT AND ACCURACY SPECIFICATIONS .....</b>	<b>166</b>
28.1	INPUT ISOLATION SPECIFICATIONS .....	166
28.2	VOLTAGE MEASUREMENT SPECIFICATIONS .....	166
28.2.1	<i>Voltage Input Capability and Characteristics</i> .....	166
28.2.2	<i>Voltage Measurement Accuracy</i> .....	167
28.3	CURRENT MEASUREMENT SPECIFICATIONS .....	169
28.3.1	<i>Current Input Capability and Characteristics</i> .....	169
28.3.2	<i>Current Measurement Accuracy</i> .....	170
28.4	WATTS, VAR AND VA MEASUREMENT SPECIFICATIONS .....	174
28.4.1	<i>Watts, VAR and VA Measurement Specifications</i> .....	176
28.5	POWER FACTOR MEASUREMENT SPECIFICATIONS .....	178
28.5.1	<i>PF Measurement Accuracy Table</i> .....	178
28.6	FREQUENCY MEASUREMENT SPECIFICATIONS .....	179
<b>29</b>	<b>MECHANICAL CHANNEL INPUT AND ACCURACY SPECIFICATIONS (MT TYPE) .....</b>	<b>180</b>
29.1	INPUT CAPABILITIES AND CHARACTERISTICS .....	180
29.2	DIGITAL INPUT MEASUREMENT SPECIFICATIONS .....	180
29.3	ANALOG INPUT MEASUREMENT SPECIFICATIONS .....	180
<b>30</b>	<b>ANALYSIS SPECIFICATIONS .....</b>	<b>181</b>
30.1	INTEGRATION SPECIFICATIONS .....	181
30.2	HARMONIC ANALYSIS SPECIFICATIONS .....	181
30.3	SPECTRUM ANALYSIS SPECIFICATIONS .....	181
30.4	CYCLE VIEW SPECIFICATIONS .....	182
30.5	SCOPE SPECIFICATIONS .....	182
30.6	HISTORICAL DATA COLLECTION SPECIFICATIONS .....	182
30.7	DATA LOGGING SPECIFICATIONS .....	182
<b>31</b>	<b>CALIBRATION ADJUSTMENT .....</b>	<b>183</b>
31.1	EQUIPMENT REQUIRED .....	183
31.2	ADJUSTMENT PROCEDURE .....	184
31.2.1	<i>Starting the Interface to the PA900</i> .....	184
31.2.2	<i>Adjusting Each Channel in the PA900</i> .....	184
31.2.3	<i>Finishing the Procedure</i> .....	186
<b>32</b>	<b>CALIBRATION VERIFICATION .....</b>	<b>187</b>

# 1 ABOUT THIS MANUAL

This document is formatted to be best viewed on a computer using a suitable reader application rather than being printed on paper and then read. If printed, then it should be printed using color.

The typical user does not need to read the entire manual, it is recommended that you look through the table of contents and read those sections which are applicable to your intended application.

The table of contents is “clickable”. You may click on any of the entries to go to that section. The table of contents is also made available as Bookmarks for Adobe Reader or Acrobat, allowing you to permanently display the table of contents alongside the document and navigate by clicking on each section as needed.

This document applies to the PA900 having a main firmware revision of 1.2.15, there may be differences if the PA900 has a different main firmware version.

Throughout this document where there is no specific reference made to option V then any text associated with option X also applies to option V.

Throughout this document images of actual PA900 screens are shown. The actual screen displayed may be slightly different from that shown in this document because of the number of channels installed, changes to firmware, differences in PA900 option content or configuration settings in the PA900.

Throughout this document there are paragraphs labelled as “Recommendations” or “Notes”. These contain additional information which you may find helpful.

Document number MO-PA900-GOM.

Copyright© 2015-2018 Vitrek.

All rights reserved. No part of this publication may be reproduced, transmitted, transcribed, stored in a retrieval system, or translated into any language in any form without prior written consent from Vitrek. This document is copyrighted and contains proprietary information, which is subject to change without notice. The product displays and instructional text may be used or copied only in accordance with the terms of the license agreement.

In the interest of continued product development, Vitrek reserves the right to make changes in this document and the product it describes at any time, without notice or obligation.

Vitrek  
12169 Kirkham Road,  
Poway, CA 92064 USA  
Telephone: 858-689-2755  
Fax : 858-689-2760  
Web : [www.Vitrek.com](http://www.Vitrek.com)  
Email : [sales@Vitrek.com](mailto:sales@Vitrek.com)



## 2 WARRANTY INFORMATION

This Vitrek instrument is warranted against defects in material and workmanship for a period of 2 years after the date of purchase. Vitrek agrees to repair or replace any assembly or component (except batteries) found to be defective, under normal use, during the warranty period. Vitreks obligation under this warranty is limited solely to repairing any such instrument, which in Vitreks sole opinion proves to be defective within the scope of the warranty, when returned to the factory or to an authorized service center. Transportation to the factory or service center is to be prepaid by the purchaser. Shipment should not be made without prior authorization by Vitrek.

This warranty does not apply to any products repaired or altered by persons not authorized by Vitrek or not in accordance with instructions provided by Vitrek. If the instrument is defective as a result of misuse, improper repair, improper shipment, or abnormal conditions or operations, repairs will be billed at cost.

Vitrek assumes no responsibility for its products being used in a hazardous or dangerous manner, either alone or in conjunction with other equipment. Special disclaimers apply to this instrument. Vitrek assumes no liability for secondary charges or consequential damages, and, in any event, Vitreks liability for breach of warranty under any contract or otherwise, shall not exceed the original purchase price of the specific instrument shipped and against which a claim is made.

Any recommendations made by Vitrek or its representatives for uses of its products are based on tests believed to be reliable, but Vitrek makes no warranties of the results to be obtained. This warranty is in lieu of all other warranties, expressed or implied and no representative or person is authorized to represent or assume for Vitrek any liability in connection with the sale of our products other than set forth herein.



### 3 PRODUCT FEATURES

- Low cost of ownership with 2 year parts and labor warranty; 2 year accuracy specs and recommended calibration cycle. Reliable state of the art fully solid-state design with 2.9GIPs RISC processing and FPGA based sampling control
- Large, high-resolution color display shows all the data you want with an easy-to-use touchscreen user interface to get you up and testing in no time
- Highest precision measurements with industry-leading noise floor and linearity and up to 100 readings per second with no reduction in accuracy (up to 500/sec with reduced accuracy with W type channels).
- Extremely wide dynamic range allows signals with crest factors to over 100:1 to be measured with full accuracy without having to reconfigure, and allows range-less operation (within each shunt) providing truly gapless measurements with varying signals and is one less thing for you to configure and worry about
- All configured measurements are always performed, no need to reconfigure for specific results
- Measurements of low power meeting the requirements of EN50564:2011 are built into the PA900 as standard. A computer is not needed
- Harmonic and Spectrum Analysis of voltage, current and power on all four channels for frequencies up to 435kHz (W type channels) or 115kHz (S, L or A type channels). Harmonic analysis of up to 500 harmonics as standard.
- Regulatory harmonics assessment of EUTs as standard to the applicable requirements of EN61000-3-2, EN61000-3-12 and EN61000-4-7. The EUT assessment is built-in to the PA900 and no computer is required. Each set of measurements made during an assessment can be reassessed to any additional classifications required without repeating the measurements.
- Front Panel USB Drive Interface for portable flash drives or hard disc drives –
  - Data log to a file in CSV or binary formats at up to 500 per second
  - Export a tabulation of historically saved data – needs no prior knowledge of the data to be recorded
  - Save an image of the screen – great for engineering record keeping
  - Import and export configurations – great for sharing a configuration between units or having your own configuration
  - Import and export harmonics limits – makes it easy to switch between different harmonics requirements
  - Export CSV format tabulations of measurement results, harmonics, spectrum, scope waveforms, or EN61000-3-2 and -12 assessments – makes generating your own reports easy without mistakes
- Internal non-volatile memory of over 2Gbyte size for high speed data logging at rates up to 500 per second.
- Not a “one size fits all” with the extra purchase cost, operating cost, and reduction in performance that entails – you only have to pay for of the capabilities and performance you want -
  - Up to four power measurement channel cards each of four different channel card types in any combination in a single PA900 -
    - S - Provides total 0.1% accuracy, 1MHz class bandwidth and 22bit sampling
    - A - Provides world class 0.03% total accuracy, 1MHz class bandwidth and 24bit sampling
    - L – Same as the A type but optimized for lower voltage applications such as AC:DC and DC:DC power supplies
    - W - Provides total 0.1% accuracy, 5MHz class bandwidth and 22bit sampling
  - Each channel card type is available with one of three current input options in any combination in a single PA900 -
    - D – Dual Shunt (up to 20Arms continuous and 150Apk inrush measurable, 250Apk withstand) in a single input terminal pair with resolution down to 0.1μA – no need to change terminals
    - H - High Current (up to 30Arms continuous and 200Apk inrush measurable, 300Apk withstand) with resolution down to 10μA
    - X – External Current Transducer or Shunt Input (up to 15Vrms) with resolution down to 0.1μV
  - Optional MT type motor channel provides analog or digital speed, direction and torque inputs for mechanical measurements.
- Up to three different Virtual Power Analyzers™ (VPAs) may be independently configured in the one unit for input/mid-point/output power and efficiency tests - there is no need to interconnect separate units to make synchronous or non-synchronous group power measurements.
- Measurements in each VPA are fully configured in a single screen at the touch of the screen without having to search for the configuration setting you need. Each may be configured as Nx1ø (1 to 4ch), 2ø3w (2ch), 3ø3w (2ch), 3ø3w (3ch) or 3ø4w (3ch) and each VPA has totally independent measurement configuration.
- Up to 1000 units can be simply interconnected and configured in a single multi-unit group to provide total efficiency and power loss measurements in the most complex of system requirements.
- A choice of screens to view the measurements, just one touch to change between screens -
  - Power Data Screen - displays V, A, W, VA, VAR and PF data for any single channel or for a group of channels, or displays loading (impedance, resistance and capacitance/inductance), or displays mechanical speed, torque, power and motor slip percentage, or displays power loss and efficiency.
  - Custom Power Data Screen - lets you choose the data you want displayed in a color, font size and location you want, along with any text you define
  - Harmonic Bar Chart Screen - displays harmonics with flexibly scaled bar charts and a scrollable textual listing of both amplitude and phase results, and harmonics can be checked against user supplied limits for each harmonic with individual harmonic and overall pass/fail indications
  - Spectrum Analysis Screen - displays signal spectral content with a user cursor for obtaining numerical levels
  - Vector Screen - displays fundamental voltage and current vectors with user defined coloring

- History Screen – the unit automatically maintains a continuous historical recording of measurement data – no configuration needed. Any data from this record may be viewed with user defined scaling, offset and color, with a user cursor for zooming and obtaining numerical levels
- Scope View Screen - an extreme resolution digital scope to capture events such as in-rush current without interfering with other measurements, with a user cursor for zooming and obtaining numerical levels
- Cycle View Screen - displays a single cycle of the voltage and current periodic waveforms, jitter sampled over multiple cycles within each measurement period giving time resolution down to 2.6ns – no configuration needed
- Standby Power Screen – allows EN50564 compliant low power measurements without the need for a computer.
- Assess EUT Screen – allows EN61000-3-2 and -12 assessments of compliance without the need for a computer.
- Connectivity - Ethernet, High Speed Serial and USB (client), or (optional) GPIB control interfaces
- Safety - CE mark certified to EN61010 with certified conformance to CAT I, II, III and IV mains measurement applications

## 4 SAFETY

### 4.1 SAFETY SPECIFICATIONS

General Safety	Conforms to the requirements of EN61010-1
Measurement Safety	EN61010-1 CAT I 1000V; CAT II 1000V; CAT III 600V; CAT IV 300V (electrical channel inputs)

**The user should be aware of these safety warnings at all times while using the PA900.**

THE PA900 MEASURES VOLTAGES AND CURRENTS WHICH MAY BE LETHAL; UNSAFE OPERATION MAY RESULT IN SEVERE INJURY OR DEATH.

IF THE PA900 IS USED IN A MANNER NOT SPECIFIED BY VITREK THE PROTECTION PROVIDED BY THE EQUIPMENT MAY BE IMPAIRED AND SAFETY MAY BE COMPROMISED.

### 4.2 POWER AND GROUNDING

THE PA900 IS INTENDED TO BE POWERED FROM A POWER CORD HAVING A PROTECTIVE GROUND WIRE WHICH MUST BE INSERTED INTO A POWER OUTLET HAVING A PROTECTIVE GROUND TERMINAL. IF THE PA900 IS NOT POWERED FROM A SUITABLE POWER SOURCE, OR IT IS LIKELY THAT THE POWER CORD MAY BE REMOVED FROM THE PA900 WHEN MAINS SIGNALS ARE APPLIED TO THE MEASUREMENT TERMINALS, THEN THE CHASSIS GROUND TERMINAL LOCATED NEAR THE POWER ENTRY CONNECTOR ON THE REAR PANEL MUST BE PROTECTIVE GROUNDED.

DO NOT REMOVE THE POWER CORD FROM THE PA900 OR FROM THE SOURCE OF POWER WHILE IT IS MEASURING HIGH VOLTAGES. THIS WILL REMOVE THE PROTECTIVE GROUND FROM THE CHASSIS OF THE PA900 WHICH MAY RESULT IN HAZARDOUS VOLTAGES BEING ACCESSIBLE TO THE USER.

### 4.3 TERMINALS AND WIRING

THE PA900 MEASURES VOLTAGES AND CURRENTS WHICH MAY BE LETHAL, ENSURE NO VOLTAGE OR CURRENT IS PRESENT WHEN CONNECTING TO OR DISCONNECTING FROM THE TERMINALS.

THE USER MUST USE WIRE WHICH IS RATED FOR THE HIGHEST EXPECTED VOLTAGE AND CURRENT FOR ALL CONNECTIONS TO THE PA900.

### 4.4 ENVIRONMENT

THE PA900 SHOULD NOT BE USED IN AN ENVIRONMENT WHERE CONDUCTIVE POLLUTION CAN OCCUR, E.G. IN AN OUTDOOR ENVIRONMENT.

IF THE PA900 IS TRANSPORTED BETWEEN DIFFERING ENVIRONMENTS AND CONDENSATION IS SUSPECTED, THE UNIT SHOULD REMAIN UNPOWERED FOR SUFFICIENT TIME FOR CONDENSATION TO HAVE DISSIPATED. IF THERE IS ANY DOUBT THEN CONTACT VITREK FOR ADVICE.

IF FLUIDS OR OTHER CONDUCTIVE MATERIALS ARE ALLOWED TO ENTER THE PA900 ENCLOSURE, EVEN IF NOT POWERED, THEN THE PA900 SHOULD BE IMMEDIATELY TAKEN OUT OF OPERATION AND SERVICED AS SAFETY MAY HAVE BEEN COMPROMISED.

## 5 INSPECTION

After the PA900 has been shipped or otherwise handled in an unknown manner, you should visually inspect the PA900 for damage before attempting to operate it. Particular attention should be taken to ensure that there are no significant dents or cracks in any outer surfaces, there are no marks or scratches on the front panel LCD touchscreen, and that all terminals are securely mounted to the unit and are not cracked or significantly dirty. If any abnormality is noted then it is recommended that the PA900 be serviced prior to being placed into use, as safety may have been compromised.

## 6 FRONT AND REAR PANEL LAYOUT

### 6.1 FRONT PANEL LAYOUT

LCD SCREEN AND TOUCH PANEL



USB DRIVE CONNECTOR

POWER INDICATOR  
OFF: No Power Applied  
RED: Power Applied, PA900 Off  
GREEN: PA900 On

### 6.2 REAR PANEL LAYOUT

CHANNELS (1 TO 4 MAY BE FITTED)

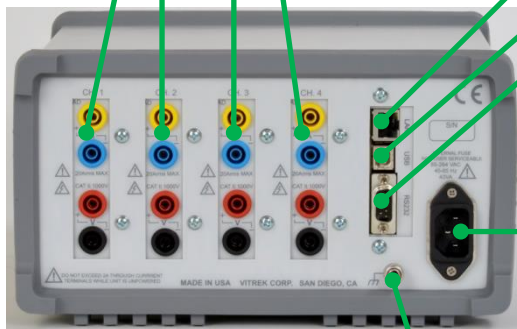

LAN INTERFACE

USB INTERFACE

RS232 INTERFACE

PA900 POWER ENTRY

CHASSIS GROUNDING

## 7 GETTING STARTED

### 1) Apply power to the PA900.

- a) Attach a three wire power cord to the power entry connector on the rear panel of the PA900 and attach the other end to a suitable source of mains.

### 2) Turn ON the PA900 (depending on how the PA900 has previously been configured this step might not be needed).

- a) Press and continuously hold anywhere on the front panel screen for at least ½ a second. Use your finger tip or a stylus; do not use a pen or pencil.

### 3) Decide what you need to measure.

- a) See section 8 for details. For now, just look at the single VPA applications and tackle the more complex applications later. A VPA is a Virtual Power Analyzer; the PA900 has three of them allowing for up to three different sets of power measurements in the same unit, for now we'll just use one.

### 4) Wire your application to the PA900 (ensure there are no voltages present while performing this)

- a) See section 9 for details.

### 5) Configure the PA900.

- a) Press the MEAS CONFIG button on the PA900 screen. If needed, see section 12.1 for full details regarding using the touch panel and section 12.4 for full details regarding configuration.

Initially we'll start with settings which are usable for just about any application; you can always come back and change these later if you want to optimize them for your specific application. Everything is visible on the one screen which is shown by pressing one button, so it's easy to remember how to change settings later but what you are now seeing is all you'll ever need to configure for many applications.

The present setting is shown in each button in a smaller text size, if you see anything which needs changing then press that button to change it.

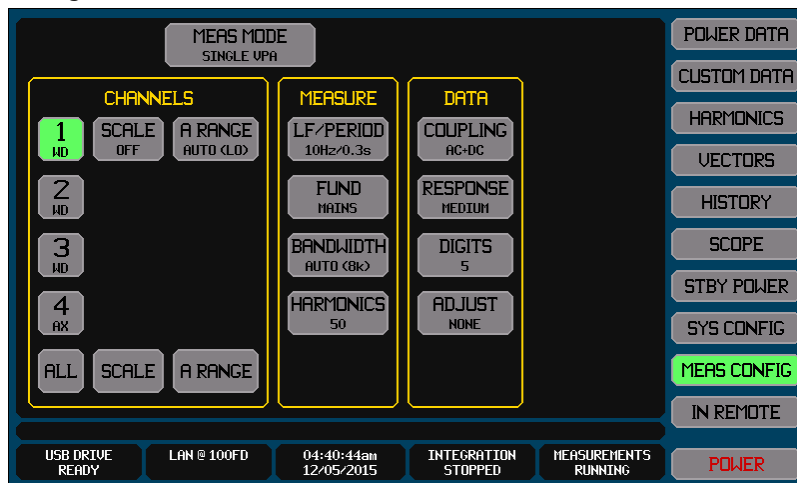

- b) MEAS MODE: Set to SINGLE VPA.

- c) In the CHANNELS area of this screen (this area configures the channels you'll use) -

Select the channels you are using and deselect those you are not. Press each numeric channel button as needed to toggle the selection.

SCALE: If you are using PTs or CTs then setup the scaling for each channel, or turn off scaling if not using them.

A RANGE: Not all channels have this button. Set to AUTO if available.

- d) In the MEASURE area of this screen (this area configures how measurements are made) -

LF/PERIOD: Set to 10Hz/0.3s.

FUND: Set as follows -

For 50/60Hz applications set this to MAINS.

For 400Hz applications set this to AVIONICS.

For other applications set this to VOLTAGE with a maximum frequency above what you're expecting (you can set this to a very high frequency if you're not sure).

BANDWIDTH: Set to AUTO-TRACK to allow the PA900 to automatically configure itself for filtering.

HARMONICS: Set to 50 unless you know you need other than this.

- e) In the DATA area of this screen (this area configures how data is displayed) -

COUPLING: Set to AC+DC. If you know that you only want the DC values then set to DC ONLY.

RESPONSE: Set to MEDIUM.

DIGITS: Set to 5.

ADJUST: Set to NONE.

- f) In the COMBINE area of this screen (this area configures how multi-channel measurements are combined) -

WIRING: Set to the wiring configuration which you used to wire to the PA900.

g) That's it for configuration. Press the POWER DATA button to save the configuration and to start seeing the measurements.

6) **You can apply voltage to your application now.**

7) **Select what results to look at.**

Viewing results is just a single press on one of the upper 7 buttons down the right side of the screen to view that screen. On each of these screens you can select several different ways of looking at the measurements. In all cases the buttons across the top of each screen allows you to select what you're looking at. A brief summary of each screen is as follows –

**POWER DATA:** enables you to view numerical results for –

All voltage, current, and power (W, VA, VAR and PF) measurements; in peak, RMS, fundamental only, or rectified forms.

Inrush.

Resistive, inductive and capacitive loading.

Integrated and long-term average measurements (e.g. Watt-Hours).

Efficiency and power loss.

**CUSTOM DATA:** enables you to view just about any numerical data you wish, along with descriptive text. You can configure a wide variety of formats for this screen.

**HARMONICS:** enables you to view voltage, current, power, and inter-phase voltage harmonics in both graphical and numerical formats.

**VECTORS:** enables you to view single or multi-channel voltage and current graphically as vectors on a polar chart.

**HISTORY:** enables you to see what's happened in the past without needing configuration beforehand. Gives a graphical chart of most measurement results with powerful zooming capabilities.

**SCOPE:** enables you to view the voltage, current, power and inter-phase voltage waveforms without needing configuration (CYCLE VIEW), or to use the PA900 as a powerful oscilloscope (SCOPE VIEW).

**STBY POWER:** enables you to configure, run and view the results of EN50564 low power measurements in both numerical and graphical formats.

**ASSESS EUT:** enables you to configure, perform and view the results of EN61000-3-2 or -12 assessments of a EUT (if measurements have been configured to do so).

The PA900 remembers what you have configured, which results screen you are looking at, and how you have setup that screen. If you turn off the PA900, when you turn it back on it is configured just like you left it. But it's best to remove power from your application when turning off the PA900.

The PA900 always measures everything configured to be measured; measurements are not dependent on which screen you're looking at. So, for example, you can configure an oscilloscope capture on the SCOPE screen, change to another screen and then come back to the SCOPE screen later to see what's been captured.

If your signals have instability then the results displayed by the PA900 will respond to that instability possibly making results difficult to read. In those situations you should go back to the MEAS CONFIG for that VPA and adjust one or more of the following settings–

Set the RESPONSE setting to a slower response. This averages all results over a number of measurement periods.

Set the LF/PERIOD setting to a longer measurement period. This slows down the changes in the results.

Set the DIGITS setting to less displayed digits. This reduces the resolution on most numerical results.

Simply exporting a screen image to a USB drive file enables you to document your results for any screen. You can also export and import configurations to/from files on a USB drive, giving you the freedom to experiment with configuration settings without worrying about being able to return to a prior known configuration. See section 13 for details regarding this.



## 8 APPLICATIONS

This section discusses in general terms the use of PA900 channels and virtual power analyzers (VPAs) in typical applications and should be used to decide which channels and VPAs will be used and what purpose each VPA performs in a user application. Details regarding connecting the signals to the channels are given in section 9 and configuring the channels and VPAs are given in section 12.4.

### 8.1 CHANNELS

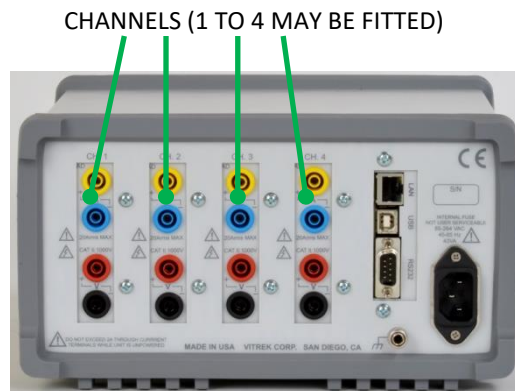

Channels are numbered CH1, CH2, CH3 and CH4 from left to right when looking at the PA900 rear panel.

#### 8.1.1 ELECTRICAL CHANNELS

Each electrical channel provides the PA900 with one voltage and one current measurement which are always simultaneously sampled to provide the best power accuracy. The PA900 can have one to four electrical channels installed.

Each electrical channel can be one of four types and each with one of three current input options. Which channel type and current input option is installed in each position is indicated by a two letter code labelled in the upper left corner of each channel sub-panel.

The channel type is denoted by the first letter of the two letter code –

**S** - Provides total 0.1% accuracy, 1MHz class bandwidth, 22bit sampling and a 1000Vrms maximum continuous voltage input

**A** - Provides total 0.03% accuracy, 1MHz class bandwidth, 24bit sampling and a 1000Vrms maximum continuous voltage input

**L** – Same as the A type but optimized for <150V voltage applications such as AC:DC and DC:DC power supplies

**W** - Provides total 0.1% accuracy, 5MHz class bandwidth, 22bit sampling and a 600Vrms maximum continuous voltage input

The current input option is denoted by the second letter of the two letter code –

**D** – Dual Shunt (up to 20Arms continuous and 150Apk inrush) in a single input terminal pair with resolution down to 0.1μA, also capable of being used with a current output CT.

**H** - High Current (up to 30Arms continuous and 200Apk inrush) with resolution down to 10μA, also capable of being used with a current output CT.

**X** – For use with an external shunt or low impedance voltage output CT (20μV to 15Vrms) with resolution down to 0.1μV

**V** – For use with an external voltage output CT (20μV to 15Vrms) with resolution down to 0.1μV

Each channel can be independently configured for voltage scaling (when using an external PT) and/or current offset and scaling (when using an external CT or shunt).

#### 8.1.2 MECHANICAL CHANNEL

Optionally CH4 can be a mechanical MT type channel. This provides analog (DC voltage) or digital speed, direction and torque inputs for the measurement of mechanical motor or generator data.

### 8.2 VIRTUAL POWER ANALYZERS (OR VPA)

The PA900 is three power analyzers in a single chassis with a single user interface. These are called Virtual Power Analyzers (or VPA) and are numbered VPA1, VPA2 and VPA3. The numbers are solely descriptive and otherwise serve no function. You may use any one, any two, or all three of the VPAs depending on the specific application.

Each installed electrical channel may be configured in any one (or none) of the VPAs. Each VPA may be configured for up to all channels installed (however W type channels may not be mixed with other types in the same VPA). The channels do not have to be physically adjacent when configuring them in a VPA, for example it is OK to configure CH1 and CH4 in one VPA and CH2 and CH3 in another.

Each VPA can be independently configured for measurement period, LF and HF filtering, harmonic analysis, signal filtering, default measurement coupling, results smoothing and displayed significant digits, multi-channel wiring configuration, and efficiency grouping. VPAs may optionally be configured to be synchronized to each other.

See sections 8.3, 8.4 and 8.5 for some typical uses of VPAs and section 12.4 for configuring the VPAs.

## 8.3 TYPICAL SINGLE VPA APPLICATIONS

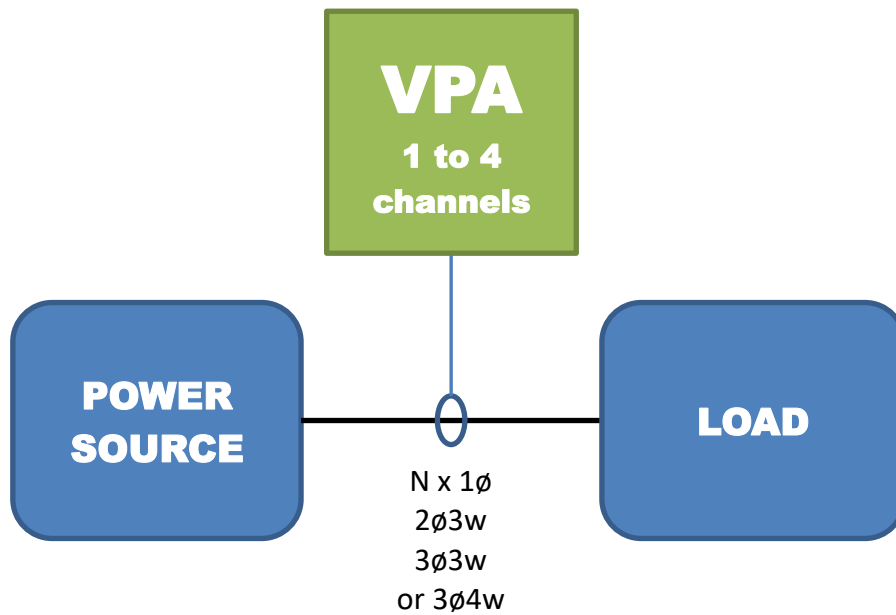

- DC and 0.01Hz to over 1MHz (W channels) or 100kHz (L, A or S channels) supply frequencies
- N x 1Ø can be up to 4 AC or DC supplies
- 2Ø3w and 3Ø4w measures neutral current from phase currents
- 3Ø3w can use either 2 or 3-wattmeter methods
- 2Ø3w, 3Ø3w (3ch) and 3Ø4w measures phase-to-phase voltages in addition to the individual phase voltages
- Wye (3Ø4w) and Delta (3Ø3w) voltage conversions for 3Ø3w and 3Ø4w resp.
- Power can flow in either direction, separately integrates power in each direction (per phase and total) as well as the total
- Total power (W, VA, VAR and PF) measured in addition to the individual phases
- Max. hold maintained for voltage, current and power measurements
- Harmonic analysis of every signal up to the 500<sup>th</sup> harmonic, <435kHz (W channels) or <115kHz (L, A or S channels)
- Built-in oscilloscope capturing every signal, triggering on any selected signal for waveform or transient analysis without interfering with the power or harmonic measurements
- Each channel individually configurable for PT and/or CT use

## 8.4 TYPICAL DUAL VPA APPLICATIONS

Examples of dual VPA applications as shown in the diagram below include –

- AC to DC Power Supplies (single or multiple outputs)
- DC to DC Power Supplies (single or multiple outputs)
- DC or fixed frequency AC supplied variable or fixed speed motor drives
- Power Transformers (single or multi-phase)
- Lighting Ballasts (most types)
- Standby or Backup Power Supplies (AC or DC)
- Photovoltaic Power Generators (DC in; DC or AC out)

There are also other dual VPA configurations which are not shown here. As examples –

If the neutral current is to be actually measured rather than computed from the other phases for a 2 $\phi$ 3w or 3 $\phi$ 4w supply or load then that is accomplished by using a second VPA for just the neutral current measuring channel and setting that VPA to be fully synchronous with the main VPA.

If a load has both AC and DC supply inputs (or vice versa), or two different frequency AC supplies, then each supply can be measured in separate VPAs and an efficiency group used to produce the total input (or output) power from both VPAs.

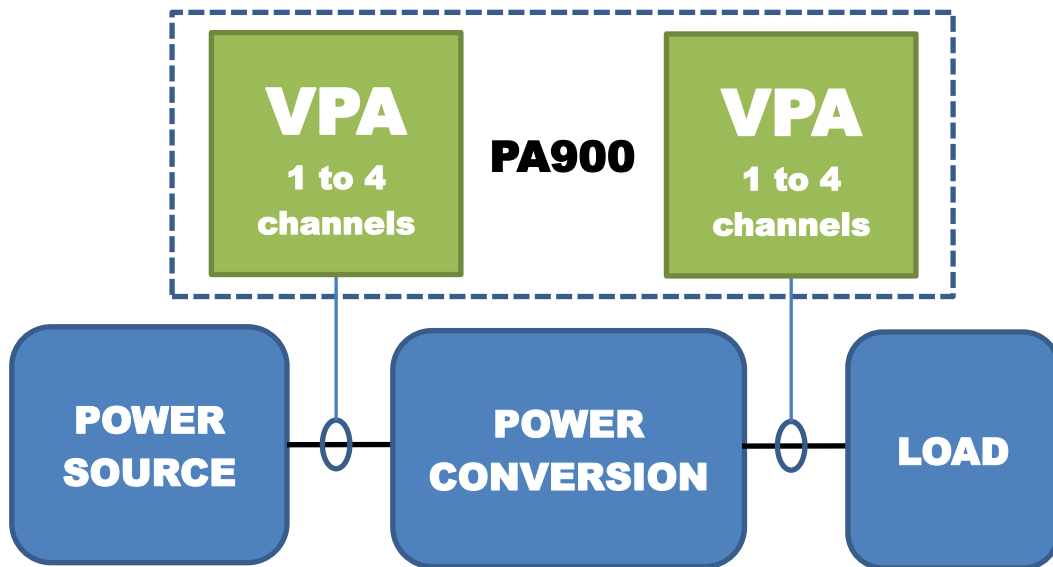

- Each VPA is independently configured and has the same capabilities as previously described for single VPA applications (except only a single oscilloscope in one VPA is allowed).
- Each VPA can be configured as N x 1 $\phi$ , 2 $\phi$ 3w, 3 $\phi$ 3w(2ch), 3 $\phi$ 3w(3ch) or 3 $\phi$ 4w limited by the total number of channels installed.
- Overall efficiency and power loss can be measured.
- The two VPAs may be configured as either –
  - Totally independent and having totally different frequency content signals to each other.
  - Or, have totally different frequency content signals but make measurements over times which are synchronized to each other.
  - Or, have the same frequency content signals and make measurements over exactly the same periods of time (the oscilloscope captures the signals in both VPAs in this case).

## 8.5 TYPICAL TRIPLE VPA APPLICATIONS

Examples of triple VPA applications as shown in the diagram below include –

Emergency Lighting Ballasts (most types)

Standby or Backup Power Supplies (AC or DC)

There are also other triple VPA configurations which are not shown here. As example –

If a facility has a backup or PV source of power, an internal power distribution, and also access to a network supply then three VPAs can be used, one measuring each of these. In this case you should note that the PA900 can also separately integrate the bought and sold power for the network power source.

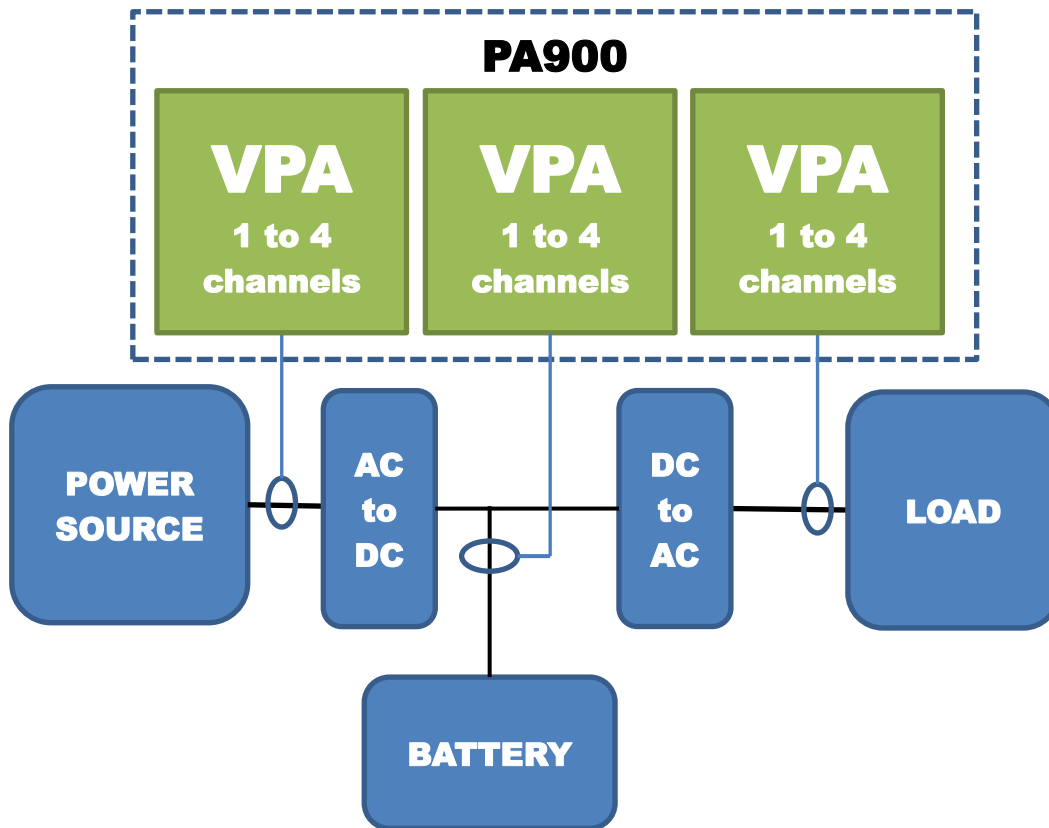

- Each VPA has the same capabilities and are independently configured as for single VPA applications (except only a single oscilloscope in one VPA is allowed).
- Each VPA can be configured as N x 1 $\phi$ , 2 $\phi$ 3w, 3 $\phi$ 3w(2ch), 3 $\phi$ 3w(3ch) or 3 $\phi$ 4w limited by the total number of channels installed.
- Efficiency and power loss can be measured, overall and for each intermediate stage.
- For the example shown above, the total charge and discharge AHr for the battery can be measured.
- The VPAs may be configured as either –
  - Totally independent and having totally different frequency content signals to each other.
  - Or, have totally different frequency content signals but make measurements over times which are synchronized to each other.
  - Or, have the same frequency content signals and make measurements over exactly the same periods of time (the oscilloscope captures the signals in both VPAs in this case).

## 8.6 MECHANICAL (MOTOR/GENERATOR) APPLICATIONS

If a MT type channel is installed and configured in the CH4 location then it can be used for mechanical measurements in addition to the previously described electrical measurements performed in VPA1 to VPA3. The measurement of mechanical data can be made independently of electrical measurements, or synchronized to a VPA, or all VPAs and the motor/generator measurements may all be synchronized together.

See section 12.4.3 for configuring the PA900 for motor/generator measurements.

## 9 WIRING TO CHANNELS

This section shows typical wiring to each channel in each VPA matching the configuration WIRING setting for that VPA in the PA900 MEAS CONFIG menu.

### 9.1 1Ø WIRING USING INTERNAL CURRENT MEASUREMENT

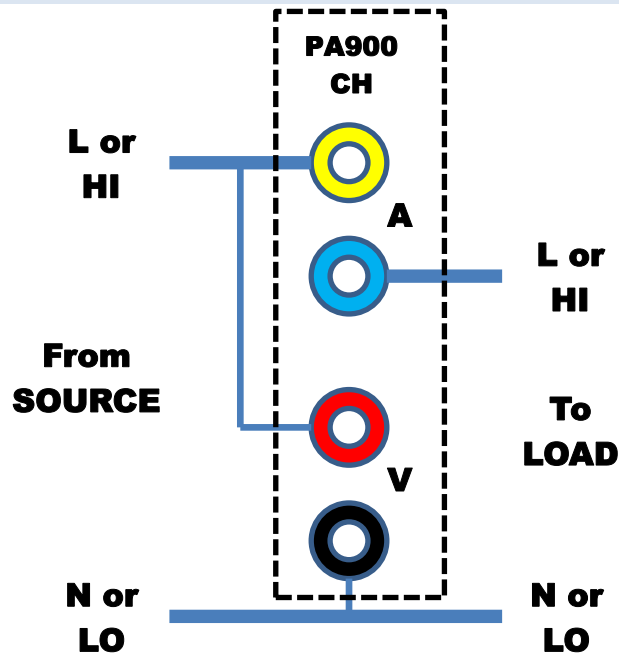

#### CAUTION:

- FOR USE WITH SH, SD, AH, AD, LH, LD, WH OR WD CHANNELS ONLY
- DO NOT CONNECT WIRING WHILE VOLTAGE PRESENT.
- ENSURE WIRING IS CORRECT BEFORE APPLYING VOLTAGE.
- DO NOT PASS LOAD CURRENT >2Arms WITH THE PA900 TURNED OFF.

#### WIRING:

- Thicker connections are current carrying. Ensure wire used is rated for the maximum voltage and current to be encountered.
- Thinner connections are not current carrying. Ensure wire used is rated for the maximum voltage to be encountered.
- The wiring connections shown above ensure the best overall system accuracy in most circumstances, measuring the voltage at the source and the load current. For applications requiring accurate measurements of the power to the load when using low voltages (<50V) and high currents (>1A) change the RED V+ terminal connection to that of the BLUE A-terminal instead of the YELLOW A+ terminal shown above, this ensures that the voltage drop across the A terminal does not affect the V measurement, at the expense of the current and power measurements including the current and power drawn by the V input (which may be adjusted for by using the ADJUST setting in the MEAS CONFIG screen).

#### PA900 CONFIGURATION:

- In the PA900 MEAS CONFIG menu you should set SCALE for the channel to OFF.
- For either connection method you may use the ADJUST setting in the MEAS CONFIG menu to set the PA900 to adjust the signals for the connection method and whether source or load results are required.

## 9.2 1Ø WIRING USING EXTERNAL CURRENT MEASUREMENT

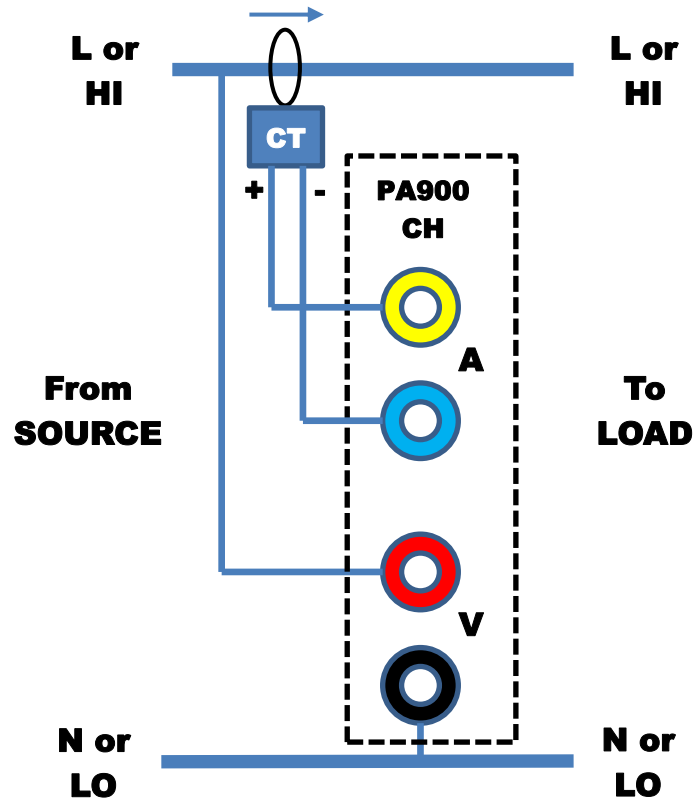

### CAUTION:

- FOR AN A:A TYPE CT : USE WITH SH, SD, AH, AD, LH, LD, WH OR WD CHANNELS ONLY
- FOR AN A:V TYPE CT OR A SHUNT : USE WITH SX, AX, LX, WX, SV, AV, LV or WV CHANNELS ONLY
- DO NOT CONNECT WIRING WHILE VOLTAGE PRESENT.
- ENSURE WIRING IS CORRECT BEFORE APPLYING VOLTAGE.

### WIRING:

- Thicker connections are current carrying. Ensure wire used is rated for the maximum voltage and current to be encountered.
- Thinner connections are not current carrying. Ensure wire used is rated for the maximum voltage to be encountered.
- Many CT devices are isolating, in those cases you should ground the A- (BLUE) terminal of the channel if the CT does not ground it.

### PA900 CONFIGURATION:

- In the PA900 MEAS CONFIG menu you should appropriately set SCALE for the channel to suit the CT or shunt being used (both a scale factor and an offset are available).

### 9.3 1Ø WIRING USING LPA-1 ADAPTOR

This is the recommended wiring method when performing EN50564:2011 compliant measurements with a single phase supply and load.

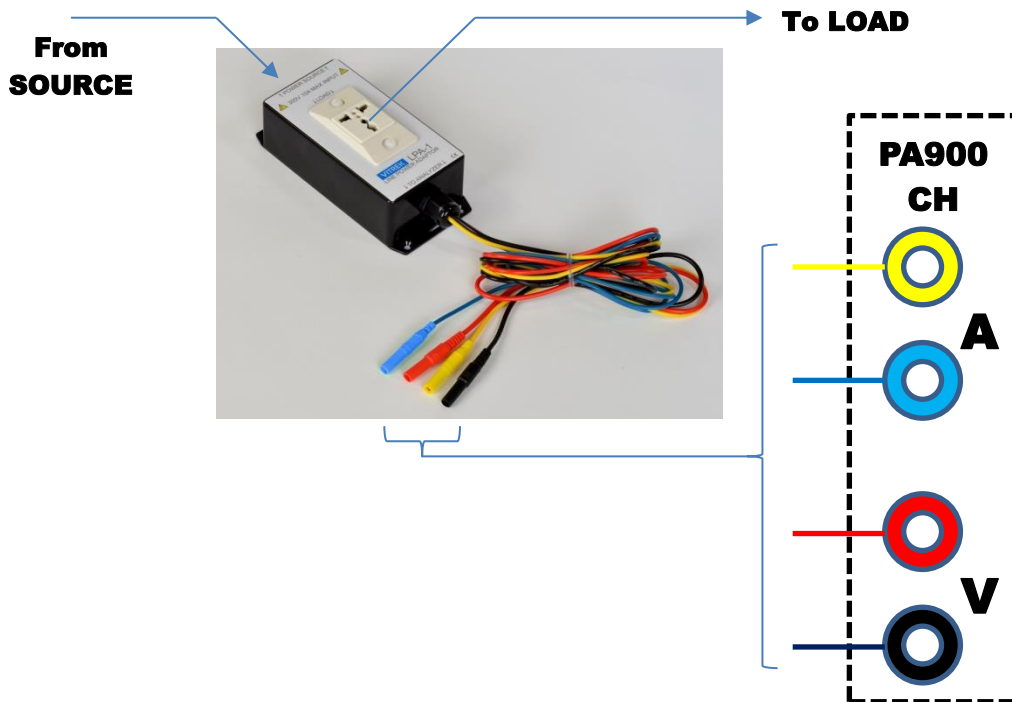

#### CAUTION:

- FOR USE WITH SH, SD, AH, AD, LH, LD, WH OR WD CHANNELS ONLY
- DO NOT CONNECT WIRING WHILE VOLTAGE PRESENT.
- ENSURE THAT EACH PA900 TERMINAL COLOR MATCHES THE WIRE CONNECTOR COLOR BEFORE APPLYING THE SOURCE VOLTAGE.
- DO NOT PASS LOAD CURRENT >2Arms WITH THE PA900 TURNED OFF.

#### PA900 CONFIGURATION:

- In the PA900 MEAS CONFIG menu you should set SCALE for the channel to OFF.
- In the PA900 MEAS CONFIG menu you should set ADJUST for the VPA to NONE, SRCE(V@SRCE) or LOAD(V@SRCE) according to your specific requirement.



## 9.4 2Ø3W OR 3Ø3W(2CH) WIRING USING INTERNAL CURRENT MEASUREMENT

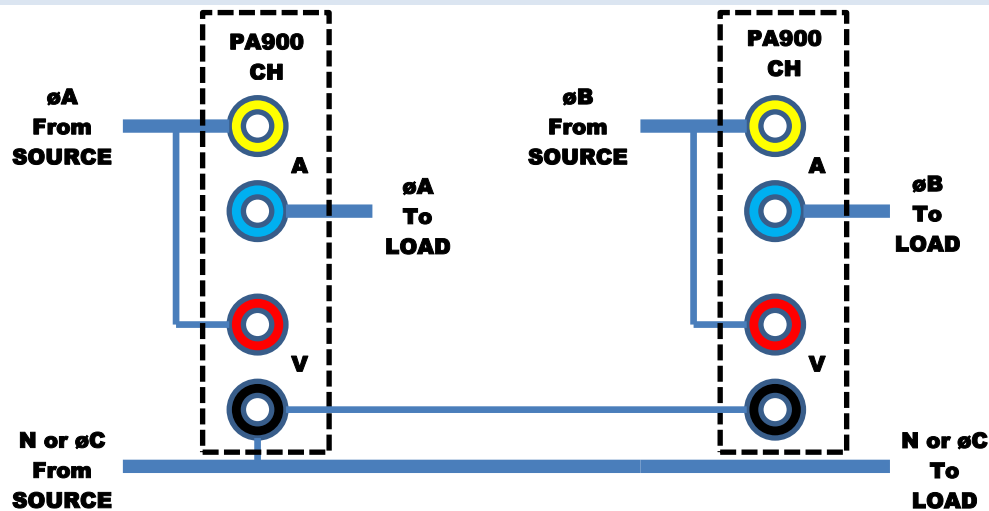

### CAUTION:

- FOR USE WITH SH, SD, AH, AD, LH, LD, WH OR WD CHANNELS ONLY
- DO NOT CONNECT WIRING WHILE VOLTAGE PRESENT.
- ENSURE WIRING IS CORRECT BEFORE APPLYING VOLTAGE.
- DO NOT PASS LOAD CURRENT  $>2I_{Arms}$  WITH THE PA900 TURNED OFF.

### WIRING:

- Thicker connections are current carrying. Ensure wire used is rated for the maximum voltage and current to be encountered.
- Thinner connections are not current carrying. Ensure wire used is rated for the maximum voltage to be encountered.
- Phases are shown for descriptive purposes, the PA900 places no reliance on the actual phasing however using those shown ensures that the PA900 display matches the actual phasing if the channels have increasing channel numbers from left to right in the diagram above.
- The wiring connections shown above ensure the best overall system accuracy in most circumstances, measuring the voltage at the source and the load current. For applications requiring accurate measurements of the power to the load and using low voltages ( $<50V$ ) and high currents ( $>1A$ ) change the RED V+ terminal connections to that of the respective BLUE A- terminal instead of the YELLOW A+ terminal shown above, this ensures that the voltage drop across the A terminals does not affect the V measurement, at the expense of the current and power measurements including the current and power drawn by the V input (which may be adjusted for by using the ADJUST setting in the MEAS CONFIG screen).

### PA900 CONFIGURATION:

- In the PA900 MEAS CONFIG menu you should set SCALE for the channels to OFF.
- For either connection method you may use the ADJUST setting in the MEAS CONFIG menu to set the PA900 to adjust the signals for the connection method and whether source or load results are required.

## 9.5 2Ø3W OR 3Ø3W(2CH) WIRING USING EXTERNAL CURRENT MEASUREMENT

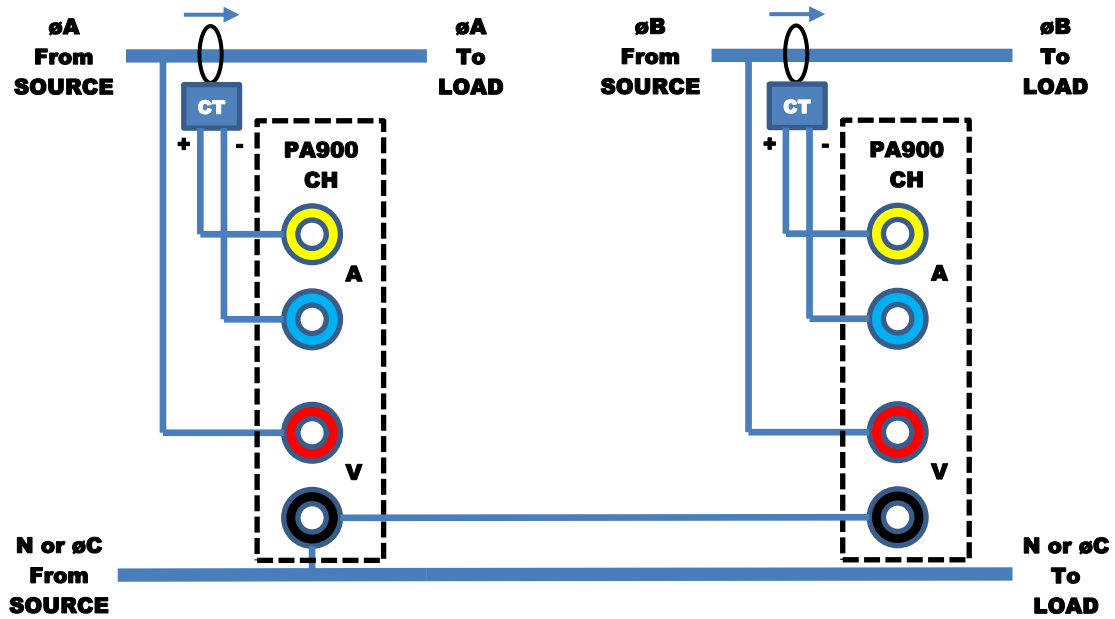

### CAUTION:

- FOR AN A:A TYPE CT : USE WITH SH, SD, AH, AD, LH, LD, WH OR WD CHANNELS ONLY
- FOR AN A:V TYPE CT OR A SHUNT : USE WITH SX, AX, LX, WX, SV, AV, LV or WV CHANNELS ONLY
- DO NOT CONNECT WIRING WHILE VOLTAGE PRESENT.
- ENSURE WIRING IS CORRECT BEFORE APPLYING VOLTAGE.

### WIRING:

- Thicker connections are current carrying. Ensure wire used is rated for the maximum voltage and current to be encountered.
- Thinner connections are not current carrying. Ensure wire used is rated for the maximum voltage to be encountered.
- Phases are shown for descriptive purposes, the PA900 places no reliance on the actual phasing however using those shown ensures that the PA900 display matches the actual phasing if the channels have increasing channel numbers from left to right in the diagram above.
- Many CT devices are isolating, in those cases you should ground the A- (BLUE) terminal of the channel if the CT does not ground it.

### PA900 CONFIGURATION:

- In the PA900 MEAS CONFIG menu you should appropriately set SCALE for each channel to suit the CT or shunt being used (both a scale factor and an offset are available).

## 9.6 3Ø3W(3CH) OR 3Ø4W WIRING USING INTERNAL CURRENT MEASUREMENT

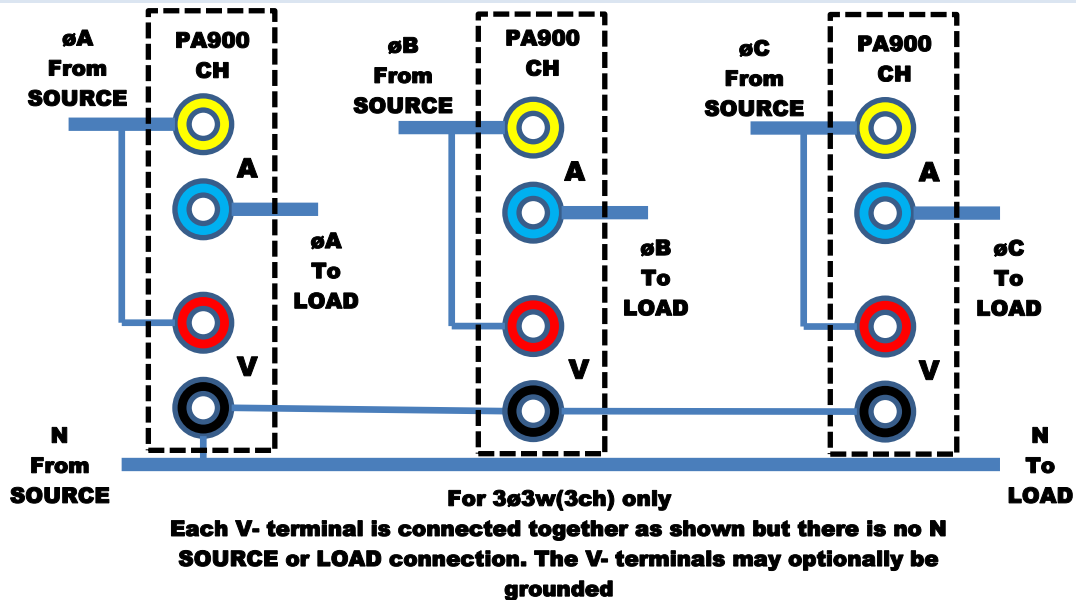

### CAUTION:

- FOR USE WITH SH, SD, AH, AD, LH, LD, WH OR WD CHANNELS ONLY
- DO NOT CONNECT WIRING WHILE VOLTAGE PRESENT.
- ENSURE WIRING IS CORRECT BEFORE APPLYING VOLTAGE.
- DO NOT PASS LOAD CURRENT >2Arms WITH THE PA900 TURNED OFF.

### WIRING:

- Thicker connections are current carrying. Ensure wire used is rated for the maximum voltage and current to be encountered.
- Thinner connections are not current carrying. Ensure wire used is rated for the maximum voltage to be encountered.
- Phases are shown for descriptive purposes, the PA900 places no reliance on the actual phasing however using those shown ensures that the PA900 display matches the actual phasing if the channels have increasing channel numbers from left to right in the diagram above.
- The wiring connections shown above ensure the best overall system accuracy in most circumstances, measuring the voltage at the source and the load current. For applications requiring accurate measurements of the power to the load and using low voltages (<50V) and high currents (>1A) change the RED V+ terminal connections to that of the respective BLUE A- terminal instead of the YELLOW A+ terminal shown above, this ensures that the voltage drop across the A terminals does not affect the V measurement, at the expense of the current and power measurements including the current and power drawn by the V input (which may be adjusted for by using the ADJUST setting in the MEAS CONFIG screen).

### PA900 CONFIGURATION:

- In the PA900 MEAS CONFIG menu you should set SCALE for the channels to OFF.
- For either connection method you may use the ADJUST setting in the MEAS CONFIG menu to set the PA900 to adjust the signals for the connection method and whether source or load results are required.

## 9.7 3Ø3W(3CH) OR 3Ø4W WIRING USING EXTERNAL CURRENT MEASUREMENT

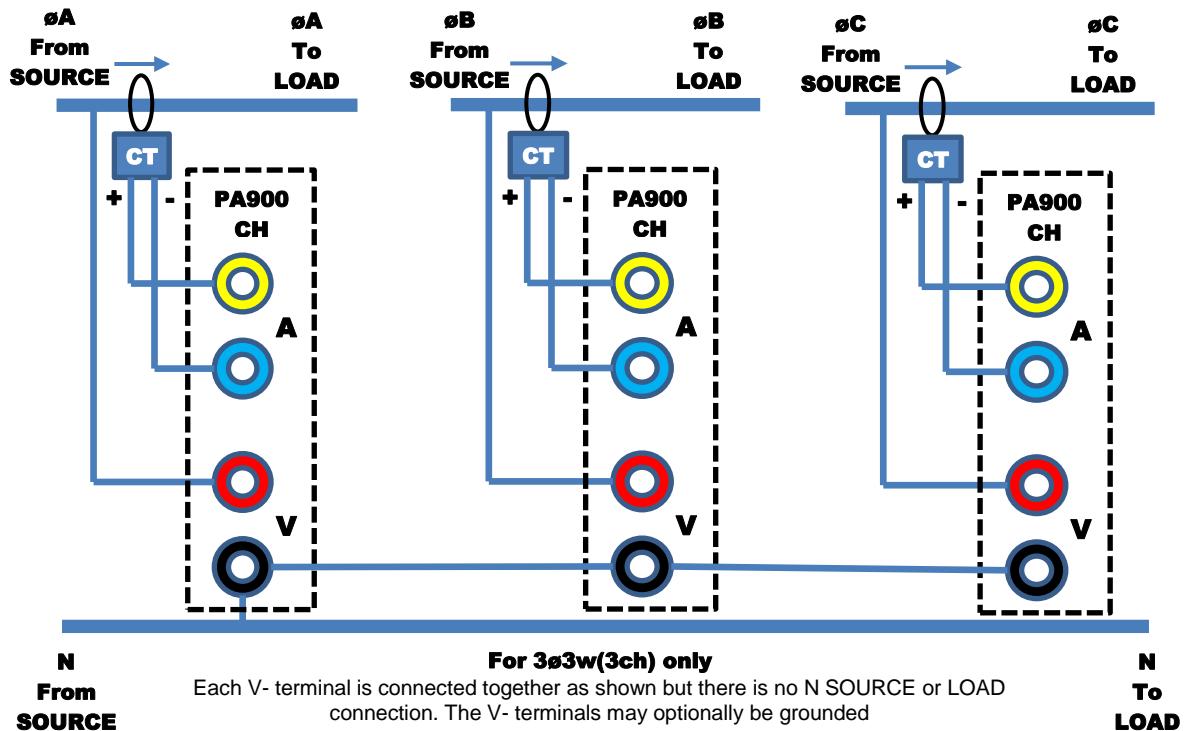

### CAUTION:

- FOR AN A:A TYPE CT : USE WITH SH, SD, AH, AD, LH, LD, WH OR WD CHANNELS ONLY
- FOR AN A:V TYPE CT OR A SHUNT : USE WITH SX, AX, LX, WX, SV, AV, LV or WV CHANNELS ONLY
- DO NOT CONNECT WIRING WHILE VOLTAGE PRESENT.
- ENSURE WIRING IS CORRECT BEFORE APPLYING VOLTAGE.

### WIRING:

- Thicker connections are current carrying. Ensure wire used is rated for the maximum voltage and current to be encountered.
- Thinner connections are not current carrying. Ensure wire used is rated for the maximum voltage to be encountered.
- Phases are shown for descriptive purposes, the PA900 places no reliance on the actual phasing however using those shown ensures that the PA900 display matches the actual phasing if the channels have increasing channel numbers from left to right in the diagram above.
- Many CT devices are isolating, in those cases you should ground the A- (BLUE) terminal of the channel if the CT does not ground it.

### PA900 CONFIGURATION:

- In the PA900 MEAS CONFIG menu you should appropriately set SCALE for each channel to suit the CT or shunt being used (both a scale factor and an offset are available).

## 9.8 MECHANICAL (MOTOR) MEASUREMENT WIRING

Mechanical measurement results are based on one, two or three signals provided to the MT type channel installed in the CH4 location. These can be measurements of either a motor or a generator.

In all cases the BNC connectors provided on the MT channel are assumed to be at a voltage close to ground on their outer shield, voltages of up to 13Vpk from the PA900 chassis are accommodated.

### Note:

If only one of speed and torque are available then mechanical power cannot be computed and is not available, however the one signal configured will be available.

If the speed of the motor is fixed and is exactly known and is not measured, then this can be accommodated by setting the SPD input as analog and configuring it with zero scaling and setting the offset to the actual, known, speed of the motor. In this manner the mechanical power will be available from the PA900 even though speed is not actually measured, however the mechanical power indicated will be affected by the accuracy of the known speed of the motor.

Similarly, if the speed of the motor is known to be a multiple of the electrical drive frequency (or generated electrical frequency) then this can also be used instead of an actual motor speed input by configuring the PA900 to compute mechanical speed from the electrical frequency of a VPA, however the accuracy of the mechanical speed, and thus the mechanical power, may be affected by errors such as motor slip.

Recommendation:

In most cases both speed and torque will be measured, allowing an accurate computation of mechanical power to be made available by the PA900.

The best method for determining speed (and direction) is to use a shaft encoder with quadrature digital outputs. This enables speed and direction to be obtained very accurately. Unless the motor or generator is known to have no mechanical chatter when stopped or running at low revolution speeds, then the use of both the digital SPD and DIR inputs is recommended as this will automatically correctly measure the mechanical speed when such chatter is present, otherwise the indicated speed may be seriously affected by chatter if only a single digital signal for speed is used.

---

### 9.8.1 MECHANICAL SPEED AND DIRECTION INPUTS

If required, mechanical speed and direction can be input to the PA900 using a DC analog voltage, or by using one (speed only) or two (speed and direction) digital inputs.

#### 9.8.1.1 DC ANALOG VOLTAGE SPEED

If using a speed transducer with a DC voltage output then this output is connected to the SPD input BNC connector of the PA900 MT channel. The polarity of this signal implies the direction of rotation of the motor or generator. You will need to configure the SPD input as ANALOG and set the scaling and offset settings accordingly for the specific transducer being used. The signal range is +/- 12Vpk.

#### 9.8.1.2 DIGITAL SPEED AND (OPTIONALLY) DIRECTION

If using a digital speed (optionally with direction) transducer such as a shaft encoder then the digital signals should be connected to the SPD BNC connector and the DIR BNC connector as applicable. You will need to configure the number of pulses of the SPD signal per revolution of the motor or generator, and the digital polarity of the DIR signal. The digital signals are CMOS/TTL compatible and either rising or falling edge of the SPD signal can be configured to be used.

---

### 9.8.2 MECHANICAL TORQUE INPUTS

If required, mechanical torque can be input to the PA900 using a DC analog voltage, or by using a digital pulse frequency input.

#### 9.8.2.1 DC ANALOG VOLTAGE TORQUE

If using a torque transducer with a DC voltage output then this output is connected to the TRQ input BNC connector of the PA900 MT channel. You will need to configure the TRQ input as ANALOG and set the scaling and offset settings accordingly for the specific transducer being used. The signal range is +/-12Vpk.

#### 9.8.2.2 DIGITAL TORQUE

If using a digital torque transducer then the digital signal should be connected to the TRQ BNC connector. You will need to configure the TRQ input as DIGITAL and set the scaling and offset settings accordingly for the specific transducer being used. The digital signal is CMOS/TTL compatible.

## 10 POWERING THE PA900

### 10.1 TURNING POWER ON

The PA900 is configurable regarding when it powers on; when initially shipped from Vitrek the PA900 is configured for power on/off to be solely controlled by the touch panel. If this configuration setting has been changed then the PA900 may power on almost immediately when mains is initially applied without any other user action.

1. Connect the power entry connector on the rear panel of the PA900 to a suitable source of AC mains power within the specifications of the PA900 (see section 25.3).

**SAFETY WARNING: The PA900 must be connected using a power cable with a continuous ground connection and must be plugged into a source of power which provides a safety ground. If a safety ground is not present then the PA900 chassis must be safety grounded by you prior to applying mains or signals to the PA900 using the rear panel chassis ground terminal.**

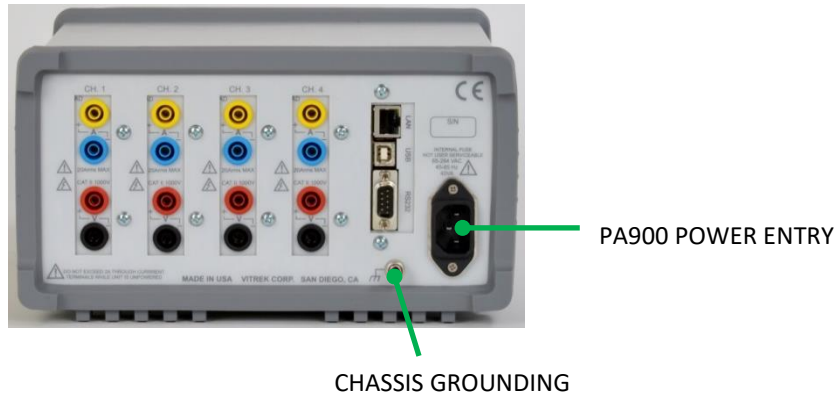

2. When initially powered the front panel POWER indicator LED will be illuminated RED.
3. Either using the tip of a finger, or using a stylus designed for use with a touch panel, press and hold anywhere on the touch panel for at least  $\frac{1}{2}$  second. Do not use excessive force, the POWER indicator LED brightens when the panel is detected as being touched. DO NOT USE A PEN OR A SCREWDRIVER OR A SIMILAR IMPLEMENT WITH SHARP CORNERS AS IT MAY DAMAGE THE TOUCH PANEL.



4. The PA900 will now power on and you may release the touch panel –  
The front panel POWER indicator LED will change to GREEN and the LCD screen will show an initial welcoming graphic for about 2 seconds and then the PA900 will start normal operation.

### 10.2 TURNING POWER OFF

Unless it is unavoidable, do not power down the PA900 by removing the source of mains power to it.

It is recommended that all signals be removed from the PA900 prior to powering down.

Press and hold the POWER button in the lower right corner of the PA900 screen. This button must be pressed for at least  $\frac{3}{4}$  second to power down the unit. If any channel has current flowing which is over its capability to withstand when powered down then the PA900 will not power down and the POWER button will be colored red while it is pressed.

The PA900 may delay powering down if it still has unsaved data, during this delay a message is displayed on the screen, this typically is less than a second.

If the PA900 has been configured to be always powered then the PA900 will almost immediately power back on.

## 11 MEASUREMENT RESULT TERMINOLOGY

### 11.1 WIRING PHASE INDICATIONS

For convenience, measurement results for individual wiring phases are denoted by the use of phase letter labels in the PA900. The use of these labels depends on the WIRING configuration setting.

All measurement results given for an individual wiring phase are denoted as follows-

$\varnothing A$ , $\varnothing B$ , $\varnothing C$ , or $\varnothing D$	Data obtained from the 1st, 2nd, 3rd or 4th channels in a VPA respectively; for 3 $\varnothing$ 3w(2ch) WIRING this is only used for current results and the $\varnothing C$ data is that obtained from the combination of the $\varnothing A$ and $\varnothing B$ data.
A, B, C, or D	Data obtained from the 1st, 2nd, 3rd or 4th channels in a VPA respectively (only when a VPA is configured for N x 1 $\varnothing$ WIRING).
$\varnothing AC$	Data obtained for voltage or power results between $\varnothing A$ and $\varnothing C$ ; for 3 $\varnothing$ 3w(2ch) WIRING this is the data from the 1st channel in the VPA, otherwise between the 1st and 3rd channels in a VPA (voltage only).
$\varnothing BC$	Data obtained for voltage or power results between $\varnothing B$ and $\varnothing C$ ; for 3 $\varnothing$ 3w(2ch) WIRING this is the data from the 2nd channel in the VPA, otherwise between the 2nd and 3rd channels in a VPA (voltage only).
$\varnothing AB$	Data obtained for voltage results between $\varnothing A$ and $\varnothing B$ (i.e. the 1st and 2nd channels in a VPA, not used when a VPA is configured for N x 1 $\varnothing$ WIRING).
N	Data obtained for Neutral current as measured from the combination of the channels in a VPA (only when a VPA is configured for 2 $\varnothing$ 3w or 3 $\varnothing$ 4w WIRING).

### 11.2 LEADING/LAGGING DETERMINATION

Whether the current is leading or lagging the voltage is denoted by the direction of an arrow shown immediately after most PF data. If the arrow is pointing upwards then it is leading, if downwards then it is lagging.

For an individual channel, lead/lag is determined from the phase of the fundamental current (if available) or by analysis of the signals by computing the power result obtained by using a delayed current signal (if no fundamental is available).

For a VPA total this is determined from the polarity of the sum of the channel VAR results.

Note:

There are no minimum signal levels for leading/lagging detection. The indication is valid at all signal levels.

### 11.3 PEAK AND VALLEY RESULTS

There are several types of peak measurement results available from the PA900 –

Highest Peak	This is denoted on the PA900 screens by Pk followed by an up arrow and is the highest sampled signal during each measurement period.
Lowest Peak	This is denoted on the PA900 screens by Pk followed by a down arrow and is the lowest sampled signal during each measurement period.
Peak	This is denoted on the PA900 screens by Pk and is the largest (i.e. without regard to the polarity) sampled signal during each measurement period.
Peak-to-Peak	This is denoted on the PA900 screens by PkPk and is the result of subtracting the lowest peak result from the respective highest peak result.
Valley Peak	This is denoted on the PA900 screens by Vly and is established as follows – The largest (i.e. without regard to the polarity) of all samples obtained for each signal within every half-cycle of the fundamental period is recorded; the smallest (i.e. without regard to the polarity) of these recorded half-cycle samples within each measurement period is recorded as the signal valley measurement results. This measurement result is only available if the fundamental frequency is known and the measurement period contains at least two fundamental cycles.
Peak-Valley	This is denoted on the PA900 screens by Pk-Vly and is the result of subtracting the valley result from the respective peak result and so is a measurement of the peak-to-peak modulation of each signal as determined over each measurement period. This measurement result is only available if the fundamental frequency is known and the measurement period contains at least two fundamental cycles.

### 11.4 INDIVIDUAL CHANNEL RESULTS

All measurement results given for an individual channel are the results for that channel without regard to the WIRING configuration of the VPA in which the channel is configured.



## 11.5 INDIVIDUAL VPA TOTAL RESULTS

### 11.5.1 VOLTAGE RESULTS

VPA total measurement results given for voltage is the average phase voltage for the VPA depending on the WIRING setting for the VPA-

3 $\phi$ 3w(2ch) or 3 $\phi$ 3w(3ch) The mean of the  $\phi$ AC,  $\phi$ BC and  $\phi$ AB voltages.  
Otherwise The mean of all channel voltages in the VPA

### 11.5.2 WYE VOLTAGE RESULT

This is only available for a VPA configured as 3 $\phi$ 3w(2ch) or 3 $\phi$ 3w(3ch) and is (mean of the  $\phi$ AC,  $\phi$ BC and  $\phi$ AB voltages)/ $\sqrt{3}$ .

### 11.5.3 DELTA VOLTAGE RESULT

This is only available for a VPA configured as 3 $\phi$ 4w and is the mean of the measured  $\phi$ AC,  $\phi$ BC and  $\phi$ AB voltages.

### 11.5.4 CURRENT RESULTS

VPA total measurement results given for current is the average phase current for the VPA depending on the WIRING setting for the VPA-

3 $\phi$ 3w(2ch) The mean of the  $\phi$ A,  $\phi$ B and  $\phi$ C currents.  
Otherwise The mean of all channel currents in the VPA

### 11.5.5 WATTS RESULTS

VPA total measurement results given for Watts are the total power computed for the entire VPA. This is always the sum of the Watts for each channel in the VPA.

### 11.5.6 VAR AND VA RESULTS

VPA total measurement results given for VAR and VA are the total power computed for the entire VPA. Depending on the VA/VAR preference configuration setting for the VPA this is one of the following-

$\Sigma$ (VAR) setting VAR is the sum of the VAR for the channels in the VPA  
VA is computed directly from the W and VAR using  $(\text{total VA})^2 = (\Sigma(W))^2 + (\Sigma(\text{VAR}))^2$

$\Sigma$ (VA) setting VA is dependent on the WIRING setting-  
3 $\phi$ 3w(2ch) setting: total VA =  $(\Sigma(\text{VA})) * (\sqrt{3}) / 2$  or for other settings: total VA =  $\Sigma(\text{VA})$   
VAR is computed directly from the W and VA using  $(\text{total VAR})^2 = (\Sigma(\text{VA}))^2 - (\Sigma(W))^2$  with polarity taken from the sum of the VAR for the channels in the VPA

### 11.5.7 POWER FACTOR RESULTS

VPA total measurement results given for PF are always computed from the total Watts and VA for the VPA.

## 11.6 INRUSH RESULTS

In most cases measurement results denoted as Inrush in the PA900 are the highest recorded respective measurement result since inrush measurement collection was last reset. The exceptions to this are -

Valley Inrush The lowest recorded valley measurement result.

VPA Voltage Inrush The highest recorded voltage of any phase in the VPA depending on the WIRING setting for the VPA  
3 $\phi$ 3w(2ch) or 3 $\phi$ 3w(3ch)  $\phi$ AC,  $\phi$ BC and  $\phi$ AB voltages  
Otherwise Each phase voltage

VPA Current Inrush The highest recorded current of any phase in the VPA depending on the WIRING setting for the VPA  
3 $\phi$ 3w(2ch)  $\phi$ A,  $\phi$ B and  $\phi$ C currents  
Otherwise Each phase current

## 11.7 PHASE RESULTS

All phase measurement results are given in degrees using either a -180° to +180° or a 0° to 360° range as defined by the preferences menu setting (see 12.3.1.6).

In many situations the mathematical definition of phase is used, i.e. if a phase  $\phi_{21}$  is returned for signal  $S_2$  with respect to signal  $S_1$ , then signal  $S_2$  is mathematically  $S_2.\sin(\omega t + \phi_{21})$  and  $S_1$  is  $S_1.\sin(\omega t)$ . However it is not uncommon in some industry segments to use a "delay" based definition of phase as illustrated by the drawing shown below-

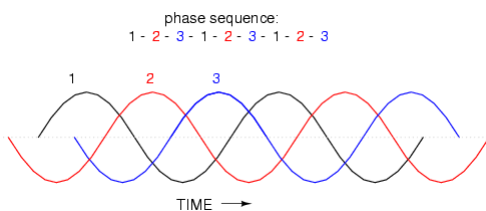

In this drawing the signal '2' may be referred to as having a 120° phase relationship to signal '1' and signal '3' as having a 240° relationship to signal '1', whereas mathematically they are  $\sin(\omega t + 240^\circ)$  ( $=\sin(\omega t - 120^\circ)$ ) and  $\sin(\omega t + 120^\circ)$  ( $=\sin(\omega t - 240^\circ)$ ) respectively. In the PA900 this is described as a "Delay" based phase rather than the "Math" based phase.

The PA900 supports several methods of showing phase results as selected by a preference setting (see 12.3.1.6) which affects ALL phase results. There are 3 parts to this preference setting, as follows-

- Numeric Range. You can select that phase results are shown with a -180 to +180° range or a 0 to 360° range. Note that these are mathematically equivalent, e.g.  $\sin(\omega t - 120^\circ)$  is the same as  $\sin(\omega t + 240^\circ)$ .
- Math or Delay Basis. You can select whether a mathematical basis or a delay basis is used for phase results as described above. This affects the mathematical use of results and it affects all phase results, e.g.  $\sin(\omega t - 120^\circ)$  is NOT the same as  $\sin(\omega t + 120^\circ)$  so if the Delay preference for phase is selected then you must include the polarity reversal in any mathematics which you might perform on the results.
  - Using a Math setting - if a phase of  $\phi$  is shown then mathematically the signal is  $S.\sin(\omega t + \phi)$ .
  - Using a Delay setting - if a phase of  $\phi$  is shown then mathematically the signal is  $S.\sin(\omega t - \phi)$ .
- CW or CCW vectors. You can select whether the VECTORS polar chart (see 12.8) is shown in a clockwise (CW) or counter-clockwise (CCW) direction for positively increasing phase after incorporating the basis above. Note, only the way in which phase is graphically shown is altered by this.

### 11.7.1 NON-HARMONIC PHASE RESULTS

Non-harmonic phase for a channel or for a VPA is the inverse cosine of the respective PF using the lead/lag determination to determine the polarity of the result. In some industry segments this is named effective or apparent phase.

### 11.7.2 HARMONIC PHASE RESULTS

Fundamental Voltage	Phase is relative to the V fundamental in the lowest numbered channel of the VPA
Non-fundamental Voltage	Phase is relative to the V fundamental in the selected channel
Fundamental Current	Phase is relative to the V fundamental in the selected channel
Non-fundamental Current	Phase is relative to the A fundamental in the selected channel

## 11.8 RELATIVE INDIVIDUAL HARMONICS RESULTS

Individual harmonics given as a percentage are the percentage relative to the fundamental of that signal unless otherwise stated.

## 11.9 PERCENTAGE DISTORTION RESULTS

Percentage harmonic distortion is given relative to fundamental denoted as THDf, or relative to total AC+DC signal denoted as THDsig, or relative to the AC signal denoted as THDac.

## 11.10 THC, POHC AND PWHC RESULTS

These are the RMS current amplitude measurements which would result if only certain harmonics were included the current signal.

THC	Includes all harmonics except the fundamental
POHC	Includes all odd harmonics at and above the 21 <sup>st</sup>
PWHC	Includes all harmonics above the 14 <sup>th</sup> , with each harmonic amplitude weighted by multiplying by the square root of its' harmonic number

These are not relative measurements; the results are in the units of Amps.

## 11.11 MECHANICAL (MOTOR) RESULTS

Motor Speed is provided (if configured) in the units of rpm (revolutions per minute).

If Motor Speed is not configured to be measured, but instead is configured to be derived from the drive frequency then it is computed as  $\text{Motor Speed} = 60 * \text{Drive Frequency} / \text{Number of poles}$

Motor Torque is provided (if configured) in the units of Nm (Newton.Metres).

Mechanical Power is computed as  $\text{Motor Power} = \text{Motor Speed} * \text{Motor Torque} * (2 * \pi / 60)$  and is in the units of Watts.

Motor Slip is computed as  $\text{Percentage Slip} = 100 * (\text{Drive Frequency} - (\text{Motor Speed} * \text{Number of poles} / 60)) / \text{Drive Frequency}$

## 12 OPERATING FROM THE FRONT PANEL

Note:

All measurements are performed by the PA900 without regard to which screen is being viewed. Although some measurements can only be started or stopped on a specific screen, you do not have to remain viewing that screen for those measurements to be performed.

### 12.1 TOUCH PANEL

Throughout this section it is assumed that you have read this sub-section.

You interact with the PA900 entirely using the touch panel, either using the tip of a finger or a stylus designed for use with a pressure type touch panel. **DO NOT USE A PEN OR A SCREWDRIVER OR SIMILAR IMPLEMENT WITH SHARP CORNERS AS IT MAY DAMAGE THE TOUCH PANEL.** Do not apply excessive force to the touch panel, typically only a gentle touch is required. While any touch is detected the POWER LED is intensified.

#### 12.1.1 BUTTONS

The PA900 has buttons on its' screens which allow you to interact and configure the unit.

Pressing a button other than the POWER button almost immediately causes the desired action for that button. The POWER button must be maintained pressed for approx.  $\frac{3}{4}$  second for the action to be taken.

If a button colors red while pressed then that button is disabled, typically because there is only one choice regarding the selectable data, or the PA900 is in the remote state and preventing that configuration setting from being altered. Otherwise a button colors green while it is pressed.

In many cases the color of a button is used to indicate whether the labelled condition is active or not. In these cases the button is colored with a light green color to indicate that the labelled condition is active, otherwise it is a silver color.

In many cases a button has two lines of text shown within it and the upper line is of a larger font size than the lower one. In these cases the lower line of text shows the present setting associated with the button, which can be changed by pressing this button. In some cases this shows an associated entered value which may be shown with less resolution than for the entry of that data, in all cases the full resolution of the entered data is used.

In a few cases pressing a button initiates a series of entries, the combination of which configures the setting or action associated with the button.

If the button initiates the entry of data or selection of a choice then that is performed on a new screen.

Pressing the RETURN button on the data entry/choice screen either returns to the screen from which the entry was initiated or initiates a screen for the next associated entry if further entries are required.

Pressing the CANCEL button on the data entry/choice screen discards the entry and any associated entries made and returns to the screen from which the entry was initiated.

### 12.2 MAIN SCREEN LAYOUT

There are nine main screens, of which the POWER DATA screen shown below is an example. All the main screens have the same basic layout.

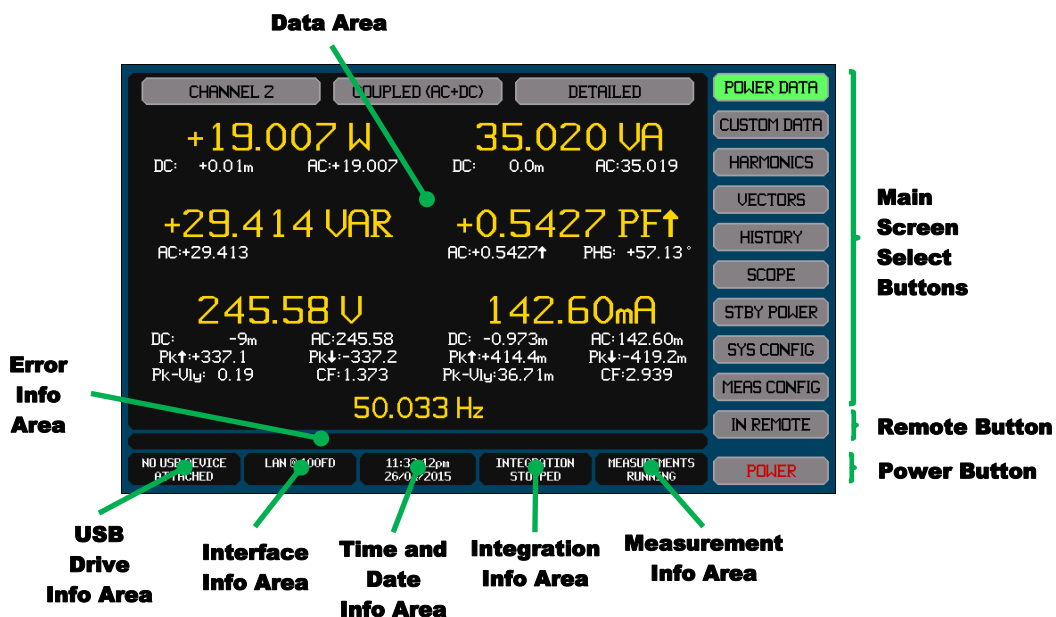

#### 12.2.1 MAIN SCREEN SELECT BUTTONS

These nine buttons allow you to choose which main screen is being shown. The upper seven select one of the measurement data viewing screens and the PA900 will always power on displaying the last one of these selected. Which main screen is presently selected is shown by the respective button being highlighted.

---

### 12.2.2 REMOTE BUTTON

This button is only present if you have placed the PA900 into the remote state via an interface. If you press this button it returns the PA900 to the local state if it is able (the interface can also set the remote with lockout state which disables this button).

Note:

Many screens have this button, all similarly labelled and positioned.

---

### 12.2.3 POWER BUTTON

If you press this button it will turn off the PA900.

Note:

This button is present on all screens and must be pressed continuously for at least  $\frac{3}{4}$  second for it to take effect.

If configured for the PA900 to be continuously powered then the PA900 will immediately power back on again, so performing a reboot action.

If this button is colored red when pressed then this indicates that there is too much current flowing through the PA900 and the user should remove this current prior to turning off the PA900.

---

### 12.2.4 DATA AREA

The selected main screen data is shown in this area. The content of this area depends on which main screen is presently selected.

---

### 12.2.5 ERROR INFO AREA

An applicable error message may be shown in this area, if any text being shown in this area is colored red then it is of high importance, if orange then it is of medium importance, and if white then it is for informative purposes only.

The following messages may be shown –

CHx OVERLOAD	(x may be 1, 2, 3 or 4) This indicates that the RMS voltage or current in the respective channel is beyond the capability of the channel.
INTERFACE ERROR - COMMAND NOT POSSIBLE AT THIS TIME	An interface command was attempted which could not be executed at the time received.
INTERFACE ERROR - COMMAND INCOMPATIBLE WITH THIS INSTRUMENT	An interface command was received with valid syntax but cannot be executed because it is not compatible with the option content, channel content or with other configuration commands.
INTERFACE ERROR - COMMAND DATA NOT WITHIN ALLOWED RANGE	An interface command was received with a data field which was not within the allowable range of values.
INTERFACE ERROR - COMMAND DATA FIELD SYNTAX ERROR	An interface command was received with a data field which did not have a valid syntax.
INTERFACE ERROR - COMMAND DATA FIELD MISSING	An interface command was received with a data field missing.
INTERFACE ERROR - COMMAND HAS TOO MANY DATA FIELDS	An interface command was received with too many data fields.
INTERFACE ERROR - UNKNOWN COMMAND	An unknown interface command was received.
INTERFACE ERROR - RESPONSE DATA TOO LONG	The responses defined by the received set of interface commands was too long to transmit.
INTERFACE ERROR - PREVIOUS RESPONSE NOT READ	An interface command was received which would cause a response, but a previous response has not yet been read.
INTERFACE ERROR - COMMAND TOO LONG	Too many characters were received via an interface without a valid command set terminator character.
INTERNAL DATALOG CORRUPTED - DATA LOST	The internal data log memory is corrupted, any data which was saved to it has been lost.
CONFIGURATION DAMAGED	The internal configuration data of the PA900 has been damaged, the unit needs reconfiguring.
CHANNEL IS UNINITIALISED	A channel is installed which has corrupted build data so cannot be used.
CONFIGURATION INCOMPATIBLE WITH HARDWARE	The measurement configuration is not compatible with the installed channels or options. It was imported from a file generated by a PA900 with different capabilities.
CHANNEL REQUIRES CALIBRATION	A channel is installed which has corrupted calibration data. External adjustment calibration is required.

---

### 12.2.6 HOLDING OR RELEASING MEASUREMENTS

The Measurement Info Area shows the present status of measurements. If you press this area it toggles between holding and releasing all except STBY POWER measurements.

Note:

If operating the PA900 as a unit in a multi-unit group then this holds or releases measurements in all PA900s within that group.

---

### 12.2.7 INTEGRATION INFO AREA

The Integration Info Area shows the present status of integration. See section 15 for details regarding this. If you press this area it either-

If not presently integrating - initiates the Integration Screen which allows you to configure and/or start integration.

If presently integrating - stops integration

Note:

If operating the PA900 as a unit in a multi-unit group then this starts or stops integration in all PA900s within that group. When starting integration the configuration of this PA900 is used in all PA900s within the group.

---

### 12.2.8 USB DRIVE INFO AREA

See section 23 for details regarding this.

While not data logging -

This area shows the connection and error status of the drive attached to the front panel USB port.

If an error is being shown then you should re-attempt connection to the drive, if the error persists then the drive is either faulty or is not compatible with the PA900.

If you press this area when a compatible USB drive is attached it initiates the File Import/Export Screen otherwise it initiates the Data Logging Screen.

While data logging -

The area shows the present status of data logging.

While performing the delay prior to starting the actual data logging, the area shows a progress bar which grows from the left as the delay progresses, reaching the right end when the delay expires.

While actually data logging the area shows a buffer status bar which indicates the amount of the PA900 drive buffer which is being used, 0% at the left end, 100% at the right end. The highest used is indicated by a vertical line within the bar area. If this indicates that a significant amount of the buffer has been used then you should consider using a faster drive, logging less data, or using a longer data logging interval.

If you press this area it initiates the Data Logging Screen.

---

### 12.2.9 INTERFACE INFO AREA

In this area the upper portion shows the presently configured interface and the connection status of it. The lower area shows if any transmit or receive data activity is occurring. If you press this area it initiates the Interface Configuration Screen. See section 12.3.2 for details regarding this.

For the LAN interface:

If the text in this area is colored red then it indicates that the PA900 does not have a valid IP address, if colored orange then it indicates that the PA900 is in the process of obtaining a valid IP address.

Note:

The NOT CONNECTED message might not only indicate that a cable is not connected but may also indicate that there is no active device at the other end of the cable. In some circumstances, for example for some RS232 or GPIB controllers, the controller in a computer does not actually activate unless user software in that computer activates that interface within it (typically by opening that interface port within the computer).

---

### 12.2.10 TIME AND DATE INFO AREA

This area shows the present time and date. If you press this area it initiates the Adjust Time and Date Screen. See section 12.3.3 for details regarding this.

---

## 12.3 SYSTEM CONFIGURATION AND VIEWING BUILD INFORMATION – THE SYS CONFIG SCREEN

Pressing the SYS CONFIG button initiates the SYS CONFIG Screen, an example of which is shown below.

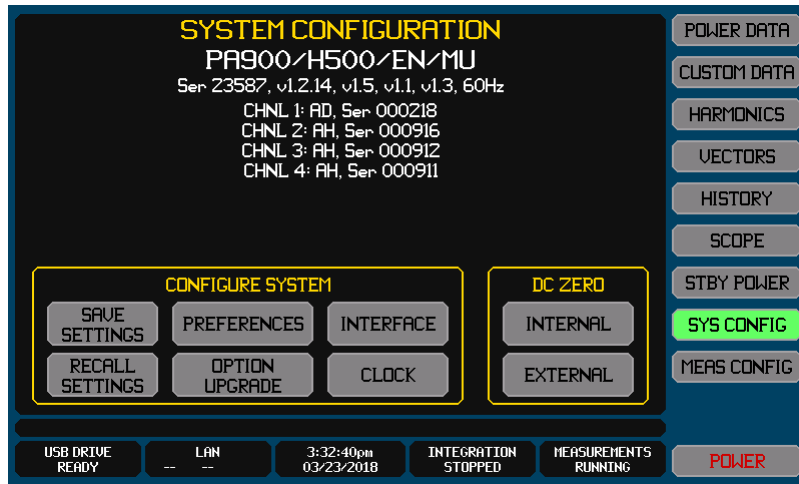

The uppermost information line shows–

Model number and option content

The second information line shows (in order from left to right) –

Unit serial number

Main Firmware version

FPGA Version

Boot Firmware version

Power Management MCU Firmware version

The present nominal mains supply frequency to the PA900.

Under the second information line the screen lists the type and current option installed and the channel serial number for each channel.

The buttons in the CONFIGURE SYSTEM area allows you to set system configuration settings, set user preferences, or to save or recall all configuration settings to/from internal memory (see below for details).

The buttons in the DC ZERO area allows you to ensure that the circuitry DC zeroes are set properly (INTERNAL) or that any external CT has its DC zero set correctly. See section 13 for details.

### 12.3.1 SAVING AND RECALLING CONFIGURATION SETTINGS

The PA900 contains 10 internal configuration storage areas into which you may save all configuration settings other than the power preference setting, the interface configuration and the time and date format configuration settings.

There is also a FACTORY configuration storage allowing you to set the configuration settings to the factory defaults (this storage cannot be overwritten).

Pressing the SAVE SETTINGS button initiates a screen which allows you to select which of the 10 available stores to save the present settings into. If a store has not previously been used then the choice has “Empty” next to it, otherwise it has “Defined” next to it and, if selected, the PA900 initiates a screen requiring you to confirm overwriting the existing contents.

Pressing the RECALL SETTINGS button initiates a screen which allows you to select either the FACTORY settings or one of the available stores which are not empty to recall the settings from.

Note:

Settings cannot be either saved or recalled while in remote.

### 12.3.2 SETTING POWER AND MEASUREMENT USER PREFERENCES

Pressing the PREFERENCES button on the SYS CONFIG screen initiates the PREFERENCES screen, an example of which is shown below.

Using this screen you can set your preference for how turning on/off the PA900 is controlled and your overall measurement preferences.

Note:

Preferences other than POWER CTRL cannot be changed while in remote.

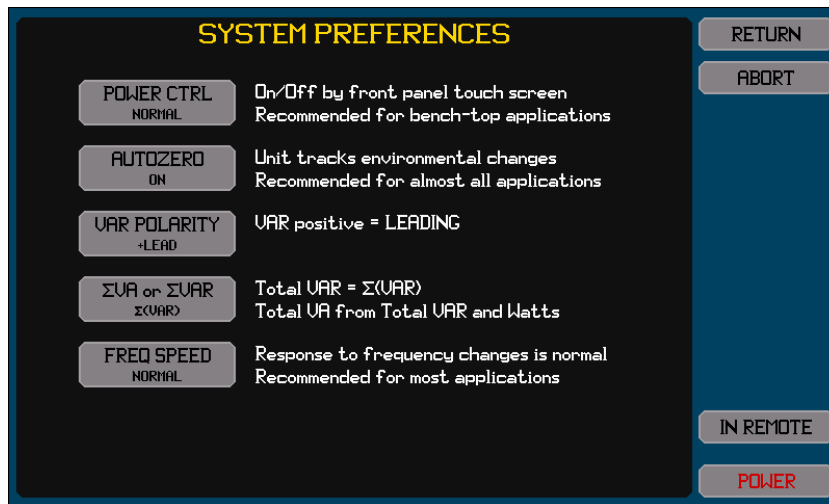

To change any of these settings press the respective button. The screen then changes to a screen enabling you to select your preference for that setting.

Press the RETURN button to save your preferences and return to the SYS CONFIG screen. Pressing CANCEL returns to the SYS CONFIG screen without saving any changes you have made.

### 12.3.2.1 SELECTING A POWER CTRL PREFERENCE

The POWER CTRL button allows you to select how the PA900 is turned on and off.

If NORMAL is selected then the touch panel is used for turning the PA900 on and off. After a power interruption the PA900 will remain off until manually turned on.

If AUTO-ON is selected then the touch panel can be used to turn the PA900 on and off, but the PA900 will also power on when power is first applied. After a power interruption the PA900 will turn on.

If ALWAYS ON is selected then the PA900 is always turned on if power is applied.

Recommendations:

For bench-top use NORMAL is recommended

For use in a fixed system (e.g. a rack) then either AUTO-ON or ALWAYS ON is recommended

### 12.3.2.2 SELECTING AN AUTOZERO PREFERENCE

The AUTOZERO button allows you to select if the PA900 occasionally checks if the DC zeroes require adjusting for changes in the operating environment.

If ON is selected then the PA900 will occasionally (every few minutes in a typical environment) adjust its' DC zeroes to track any changes to the environment. This incurs a 20ms gap between measurements once every few minutes in a typical environment (a 99.99% signal capture probability for non-recurring transients lasting <20ms). Note that this setting cannot effect SCOPE actions (e.g. inrush current detection); once a SCOPE trigger detection is initiated then DC zero adjustments are automatically disabled until completed.

If OFF is selected then the DC zeroes will slightly change if the environment changes, however the transient signal capture probability is 100%.

Recommendations:

In almost all applications this will be set to ON. Only select OFF if you are concerned about a nominally 0.01% probability of not capturing non-recurring transient signal events lasting less than 20ms.

### 12.3.2.3 SELECTING A VAR POLARITY PREFERENCE

The VAR POLARITY button allows you to select the meaning of the polarity of all VAR results.

If +LEAD is selected then a positive VAR result indicates that current is leading the voltage.

If +LAG is selected then a positive VAR result indicates that current is lagging the voltage.

Recommendations:

For most applications the use of the +LEAD setting is recommended.

Note:

Mathematically VAR has usually been described as the 'sine' relationship to the phase shift of the current relative to the voltage so resulting in a positive VAR indicating a leading current, but in certain industries the opposite convention is used where a positive VAR indicates a lagging current.

By definition lead/lag is indicated by the polarity of VAR and not by any other measurement result. Showing lead/lag by the polarity of PF is incorrect but has historically been done as a result of limitations in simpler VAW meters. The PA900 does not follow this historical use of the polarity of PF but instead uses the mathematical polarity for PF (note that  $PF = W / VA$ , so PF has the polarity of Watts).

### 12.3.2.4 SELECTING A ΣVA OR ΣVAR PREFERENCE

The ΣVA or ΣVAR button allows you to select the method by which total VA and total VAR results (i.e. the results for an entire VPA) are computed.



If  $\Sigma(\text{VAR})$  is selected then –

Total VAR =  $\Sigma(\text{VAR})$ .

Total VA is computed using  $(\text{total VA})^2 = (\Sigma(W))^2 + (\Sigma(\text{VAR}))^2$

If  $\Sigma(\text{VA})$  is selected then –

Total VAR is computed using  $(\text{total VAR})^2 = (\text{total VA})^2 - (\Sigma(W))^2$ .

Total VA for each VPA depends on the WIRING selection for each VPA:-

3 $\phi$ 3w(2ch): total VA =  $(\Sigma(\text{VA})) * (\sqrt{3}) / 2$

Otherwise: total VA =  $\Sigma(\text{VA})$

#### Recommendations:

If you have previously used the  $\Sigma(\text{VA})$  method (which is used by some other manufacturers of Power Analyzers) then it is recommended to use that setting. Otherwise the  $\Sigma(\text{VAR})$  should be selected as it matches the mathematical approach.

#### Note:

Since this selection affects the total VA results, this selection also affects the total PF results.

Only for pure sinewave voltages and currents with the expected phase shift between the voltages and a perfectly balanced load is there no difference in the results between these selections.

### 12.3.2.5 SELECTING A FREQ SPEED PREFERENCE

The FREQ SPEED button allows you to select how quickly the PA900 measures and responds to changes in the fundamental frequency.

If FAST is selected then the PA900 measures the fundamental frequency using the fastest possible measurement period (and the least resolution) and will respond as quickly as possible to changes detected. If configured for LF or VLF operation by the LF/PERIOD setting in the MEAS CONFIG screen for a VPA and if a change in fundamental frequency of >1% occurs then any amplitude measurements in progress are terminated and new measurements are started using this new frequency.

If NORMAL is selected then the PA900 measures the fundamental frequency using a measurement period optimized for both speed and resolution. Changes in the fundamental frequency are not applied until the next amplitude measurement is started.

If SLOW is selected then the PA900 measures the fundamental frequency using a long measurement period which has the best resolution. Changes in the fundamental frequency are not applied until the next amplitude measurement is started.

#### Note:

When configured for EN61000-3-2 or -12 measurements this preference setting is ignored.

#### Recommendations:

For most applications the NORMAL setting should be used.

For applications where it is desirable to track changes in the fundamental frequency as closely as possible (e.g. a variable speed motor) or when using the PA900 at frequencies below 1Hz then the FAST setting should be considered.

For applications where the fundamental frequency is considerably affected by modulation or other effects then the SLOW setting should be considered.

### 12.3.2.6 SELECTING A PHASE PREFERENCE

The PHASE button allows you to select how phase information is displayed and returned via an interface. The PA900 supports several methods of showing phase results as selected by this preference setting which affects all phase results.

If **Math,+/-180°,CW** is selected then the PA900 returns all phase results as mathematical phases in the range from -180° to +180° and the chart on the VECTORS screen (see 12.8) is displayed with increasing phase as a clockwise rotation of the chart.

If **Math,+/-180°,CCW** is selected then the PA900 returns all phase results as mathematical phases in the range from -180° to +180° and the chart on the VECTORS screen (see 12.8) is displayed with increasing phase as a counter-clockwise rotation of the chart.

If **Math,360°,CW** is selected then the PA900 returns all phase results as mathematical phases in the range from 0° to 360° (no polarity is displayed) and the chart on the VECTORS screen (see 12.8) is displayed with increasing phase as a clockwise rotation of the chart.

If **Math, 360°,CCW** is selected then the PA900 returns all phase results as mathematical phases in the range from 0° to 360° (no polarity is displayed) and the chart on the VECTORS screen (see 12.8) is displayed with increasing phase as a counter-clockwise rotation of the chart.

If **Delay,+/-180°,CW** is selected then the PA900 returns all phase results as phase delays in the range from -180° to +180° and the chart on the VECTORS screen (see 12.8) is displayed with increasing phase as a clockwise rotation of the chart.

If **Delay,+/-180°,CCW** is selected then the PA900 returns all phase results as phase delays in the range from -180° to +180° and the chart on the VECTORS screen (see 12.8) is displayed with increasing phase as a counter-clockwise rotation of the chart.

If **Delay,360°,CW** is selected then the PA900 returns all phase results as phase delays in the range from 0° to 360° (no polarity is displayed) and the chart on the VECTORS screen (see 12.8) is displayed with increasing phase as a clockwise rotation of the chart.

If **Delay, 360°,CCW** is selected then the PA900 returns all phase results as phase delays in the range from 0° to 360° (no polarity is displayed) and the chart on the VECTORS screen (see 12.8) is displayed with increasing phase as a counter-clockwise rotation of the chart.

Note:

If a Math preference for phase is selected then if a phase of  $\emptyset$  is shown then mathematically the signal is  $S.\sin(\omega t + \emptyset)$ .

If a Delay preference for phase is selected then if a phase of  $\emptyset$  is shown then mathematically the signal is  $S.\sin(\omega t - \emptyset)$ .

The selection of the numeric range for phase results does not affect the results themselves. Phase results in the range 0° to +180° are unaffected; results in the range +180 to +360° (for a 0 to 360° selection) are exactly equivalent to the range -180 to 0° resp. (for a +/-180° selection) and vice versa.

The CW or CCW portion of the selection only affects how the vectors chart is displayed on the VECTORS screen, no other data or results are affected by this selection.

### 12.3.3 CONFIGURING THE INTERFACE

You may initiate the Interface Configure Screen by either pressing the Interface Info Area while on any main screen, or pressing the SYS CONFIG button and then pressing the INTERFACE button on that screen.

Note:

Changes to the interfaces can only be made while not in remote.

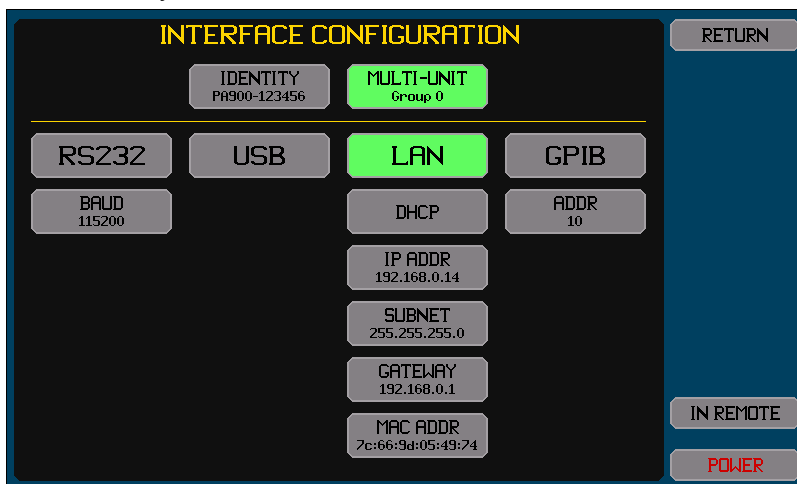

There are two areas shown on this screen. The upper area allows you to set a name (identity) for the PA900 or to use the factory default name, and select whether the PA900 participates in a multi-unit group and which group number to participate in.

The lower area allows you to select which interface is to be used to interface to a computer and the configuration to use for that interface.

The presently selected interface (if any) is shown highlighted in green. Pressing any of the upper interface buttons toggles the selection active or inactive (only one interface can be active at any time).

Below each interface button are the buttons allowing that interface to be configured, it is not necessary to enable an interface to be able to configure it. Any changes made have an immediate effect.

Note:

The settings for the LAN interface are always used and the LAN interface is always enabled to operate. Whether the LAN interface is selected (or not) only selects whether the LAN interface can be used to control the PA900 from a computer.

#### 12.3.3.1 USING AN INTERFACE IDENTITY

The PA900 can be configured to have a name as an identity associated with this specific instrument as follows –

**NONE.** This selects that this PA900 will not have an associated identity and the mDNS protocol will not be used via the LAN interface.

**FACTORY.** This selects that this PA900 will have a name formed from the model number, a dash character and the serial number. The PA900 will use the mDNS protocol to establish the uniqueness of this name via the LAN interface.

**USER SET.** This selects that this PA900 will have a name which is defined by you. The PA900 will use the mDNS protocol to establish the uniqueness of this name via the LAN interface.

#### 12.3.3.2 CONFIGURING THE RS232 INTERFACE

For the RS232 interface you must set the baud rate.

#### 12.3.3.3 CONFIGURING THE USB INTERFACE

There are no configuration settings for the USB interface.

### 12.3.3.4 CONFIGURING THE LAN INTERFACE

#### 12.3.3.4.1 Using DHCP to obtain the LAN Configuration

In this case you press the AUTO-IP/DHCP/STATIC IP button and select DHCP. There is no other configuration required and if the LAN interface is enabled the remaining buttons show the configuration obtained (while obtaining the configuration the text in the buttons is colored orange).

#### 12.3.3.4.2 Using Manually set IP Information

In this case you press the AUTO-IP/DHCP/STATIC IP button and select STATIC IP, and then manually enter the IP ADDR, SUBNET and GATEWAY addresses. You should consult your IT department to obtain the correct settings for these.

If the configured IP address is colored red, then this indicates that the PA900 has detected another device on the network which is using that IP address.

#### 12.3.3.4.3 Peer-to-Peer LAN Connection to a Computer

In this case you press the AUTO-IP/DHCP/STATIC IP button and select AUTO-IP. There is no other configuration required and if the LAN interface is enabled the remaining buttons show the configuration obtained (while obtaining an IP address in this manner the text in the buttons is colored orange). This obtains an IP address using the Link-Local method (defined by RFC3927) and often called Link-Local, Zeroconf, IPv4LL, or APIPA. The address selected will be in the range from 169.254.1.0 to 169.254.254.255 and it will change each time the interface is linked. For a Windows™ computer it should be configured for DHCP even if one is not present (in practice it does not affect operation if one is present as the computer will be able to access the PA900 at its local address). Since traffic using this range of IP addresses should not pass through a router, the PA900 must be local to the computer.

### 12.3.3.5 CONFIGURING THE GPIB INTERFACE

For the GPIB interface you must set the GPIB address of the PA900.

## 12.3.4 SETTING THE CLOCK AND TIME/DATE FORMATS

You may initiate the Time and Date Configure Screen by either pressing the Time and Date Info Area while on any main screen, or pressing the SYS CONFIG button and then pressing the CLOCK button on that screen.

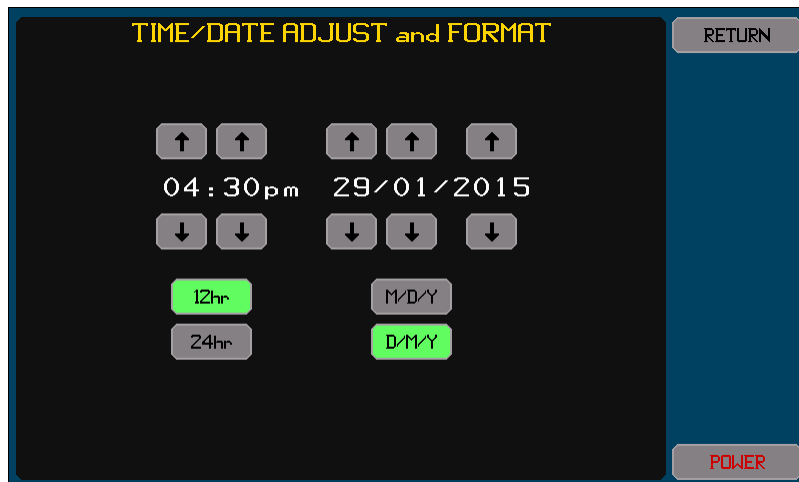

You may adjust the time and/or date by using the respective up and down arrow buttons (these buttons auto-repeat if maintained pressed).

Note:

When changing the time, the seconds data is always set to zero.

## 12.3.5 UPGRADING THE PA900 OPTION CONTENT

Certain PA900 options are field upgradable by the purchase of an upgrade code and entry of that code into the PA900. The upgrade is accomplished by pressing the OPTION UPGRADE button and entering the factory supplied code.

## 12.4 CONFIGURING MEASUREMENTS – THE MEAS CONFIG SCREEN

All measurement configuration of the PA900 is performed in the MEAS CONFIG Screen accessed by pressing the MEAS CONFIG button, an example of this screen is shown below.

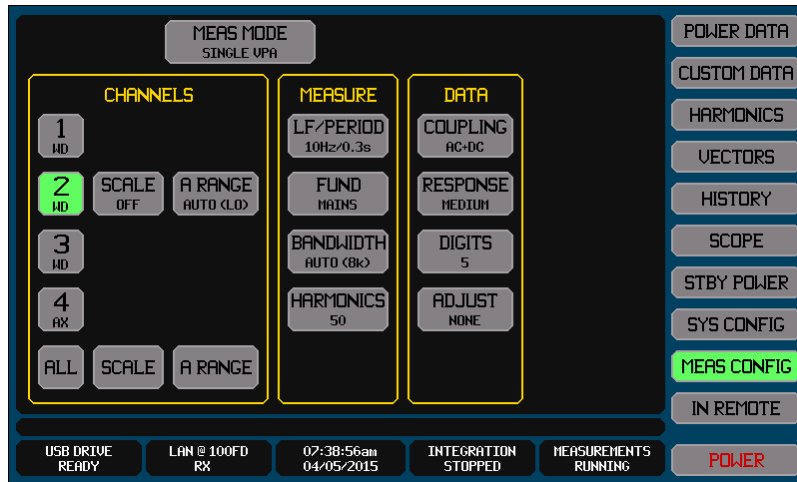

Changes made to the configuration do not become active until this screen is navigated away from, i.e. one of the other Main Screen Select Buttons is pressed.

Note:

Settings cannot be changed while in remote.

If you press the MEAS CONFIG button while showing the MEAS CONFIG screen then any changes which have been made will be discarded and the screen will return to showing the presently used configuration.

## 12.4.1 SELECTING THE OVERALL MEASUREMENT MODE

If you press the MEAS MODE button it starts a screen which allows you to select the measurement mode the PA900 is to operate in.

If you select SINGLE VPA then only a single VPA may be used (VPA1) and many other choice selections are simplified.

If you select MULTI VPA then up to 3 VPAs may be used (VPA1, 2 and 3). Each of these will make their measurement asynchronously to each other (unless synchronized using their LF/PERIOD setting).

If you select SYNC VPA then up to 3 VPAs may be used (VPA1, 2 and 3). Each of these will always start their measurements synchronously with all other VPAs. If mechanical measurements are also being performed then those will also be similarly synchronized. If the PA900 is part of a multi-unit group then the measurements will also be synchronized with any other PA900s which are also configured with the SYNC VPA mode within that multi-unit group.

If you select SPECTRUM then only a single VPA may be used (VPA1) as for the SINGLE VPA selection, but spectrum analysis is performed instead of a full harmonic analysis.

If you select EN61000-3-2 then only a single VPA may be used (VPA1) as for the SINGLE VPA selection, but EUT measurements are in accordance with EN61000-4-7 and assessments in accordance with EN61000-3-2 are available.

If you select EN61000-3-12 then only a single VPA may be used (VPA1) as for the SINGLE VPA selection, but EUT measurements are in accordance with EN61000-4-7 and assessments in accordance with EN61000-3-12 are available.

Caution:

Do not alter the measurement mode while performing an assessment to EN50564, EN61000-3-2 or EN61000-3-12.

Recommendations:

Unless you specifically need one of the other modes, select the SINGLE VPA mode.

The use of the SYNC VPA mode is only recommended when long or widely different measurement periods are being used and the signals are changing rapidly. In most multiple VPA applications it is recommended to use the MULTI VPA mode with the same measurement period configured in each and if necessary because of changing signal levels use shorter measurement periods for better synchronization of timing between VPAs and then include response averaging as needed to stabilize the readings, this is particularly recommended if the signals in the VPAs have widely differing frequency content.

## 12.4.2 CONFIGURING A VPA

The configuration shown on the screen shows the configuration for a selected VPA. The CONFIG VPA button (not shown if only a single VPA is available and no MT (Motor) channel is installed) allows you to select which VPA configuration is being displayed.

Note:

The settings on this screen only affect the selected VPA except as denoted below.

### 12.4.2.1 SELECTING AND CONFIGURING THE CHANNELS IN A VPA

This is performed by using the buttons in the CHANNELS area.

#### 12.4.2.1.1 Selecting the Channels

If you press any of the available channel number buttons, then that channel is toggled between selected (button highlighted green) or unselected (not highlighted and colored grey).

Pressing the ALL button selects that all available channels will be used in the selected VPA.

Note:

Only channels which are fitted are displayed.

As an aide, the channel type and current option for each channel is shown in the lower portion of each of the channel number buttons as the two letter code.

Deselecting all channels from the selected VPA disables the selected VPA.

A channel can only be selected in a single VPA; selecting a channel in the selected VPA deselects it in other VPAs automatically.

W type channels cannot be selected along with other type channels in the same VPA, but any other types of channels can be intermixed in the same VPA. If you need to change to selecting a W type channel then you must first deselect all of the other types of channels before you can select a W channel in that VPA. Conversely, if any W type channels are selected in a VPA and you need to change to selecting another type of channel in that VPA then you must first deselect all the W type channels before you can select a different type of channel in that VPA.

Caution:

Do not alter the channel content of a VPA while performing an assessment to EN50564, EN61000-3-2 or EN61000-3-12.

#### 12.4.2.1.2 Scaling Channels

Pressing any of the channel SCALE buttons allows you to configure that channel for voltage scaling, current scaling and/or current offset.

Pressing the SCALE button next to the ALL button sets all selected channels to the same scaling and offset settings.

If any scaling is configured to be applied to a channel then ON is shown in the SCALE button for that channel and the button is highlighted, otherwise OFF is shown and the button is not highlighted.

An example of the screen used to setup channel scaling is shown below.

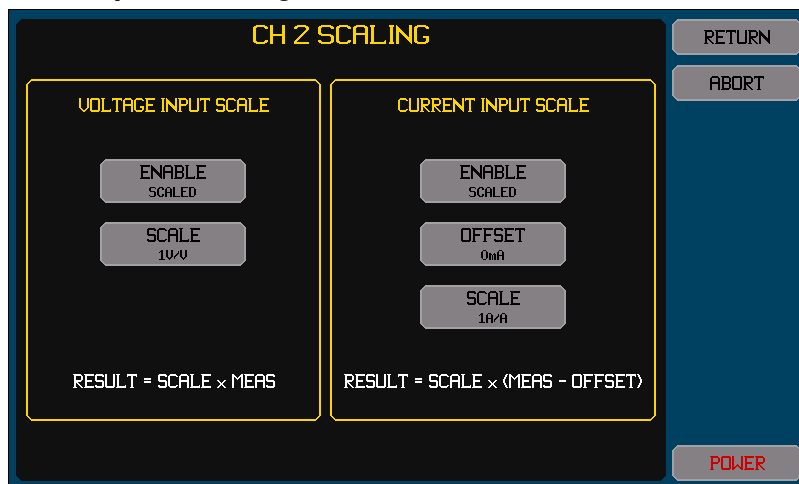

Changes made in this screen are not used for measurements until the underlying MEAS CONFIG screen is navigated away from.

Note:

If scaling is disabled for voltage and/or current, the scale factors and offset remain saved in the PA900 for later reuse.

If the channel is subsequently selected in another VPA (or disabled by not selecting it in any VPA) then the channel scaling and offset settings stay with the channel.

Voltage scale factors between 0.001 and 1000000 may be entered.

Current scale factors between 0.000001 and 1000000 may be entered.

Current offsets may be entered up to the maximum measurable for the current input option and are the offset at the output of the transducer (as shown on the screen).

The current offset is applied as a DC offset to current measurements. You should not attempt to use it as a method to offset an unwanted AC signal content.

#### 12.4.2.1.3 Setting the Current Range for Channels

Pressing any of the channel A RANGE buttons allows you to configure that channel for the desired current range selection.

Pressing the A RANGE button next to the ALL button sets all selected channels to the same current range selection.

Settings of HI, LO and AUTO may be available depending on the current option in each channel.

Note:

If set for AUTO then the text in the A RANGE button also indicates the present range being used (LO or HI).

Channels having the H current input option have no A RANGE button.

Channels having the X current input option do not allow an AUTO range selection.

Recommendations:

In most applications you should select the same current range for all channels in a VPA.

When configuring a channel with the D current input option the use of the AUTO setting is recommended for most applications, however if the load has rapidly and widely changing current or if the user is going to trigger on an inrush current, then the HI range should be selected.

When configuring a channel with the X current input option you should choose the range giving the best compatibility with the type of transducer being used. Generally, for A:V type transducers this will be the HI range and for external shunts this will be the LO range.

#### 12.4.2.2 CONFIGURING THE MEASUREMENTS MADE IN THE SELECTED VPA

This is performed by using the buttons in the MEASURE area. Some of the settings in this area are interdependent, you should start with the uppermost setting and work downwards on the screen (all lower settings are forced to be consistent with higher settings as needed).

Note:

Depending on configuration and the installed channels some buttons may not be present or may not allow modification of the setting.

##### 12.4.2.2.1 Setting the Low Frequency Limit and Measurement Period

The LF/PERIOD button allows you to select the low frequency limit and measurement period for the selected VPA if MEAS MODE is not EN61000-3-2 or EN61000-3-12.

Settings of VLF, LF, 10Hz/0.3s, 20Hz/0.1s, 45Hz/20ms, 150Hz/10ms and 500Hz/2ms are available. Additionally, settings selecting a lower numbered VPA are available when MEAS MODE is set for MULTI VPA or SYNC VPA and you are configuring VPA2 or VPA3.

Note:

The 500Hz/2ms setting is only available when the VPA is configured with W type channels.

This setting sets the nominal measurement period; the actual measurement period will be automatically adjusted during operation to be the nearest integer number of fundamental signal cycles as needed.

For the LF setting the measurement period is widely variable; 1 second for frequencies above 1Hz and 1 cycle for frequencies below 1Hz.

For the VLF setting the measurement period is widely variable; 5 seconds for frequencies above 0.2Hz and 1 cycle for frequencies below 0.2Hz.

Setting this to a lower numbered VPA forces all measurements in both VPAs to be exactly synchronous (this is only available for VPA2 or 3). This configures the VPA being configured to use the same LF/PERIOD setting of that VPA and also use the fundamental frequency of that VPA. Note that if the VPA being configured contains W type channels then the lower numbered VPA selected here must also contain W type channels, and similarly if the VPA being configured does not contain W type channels then the lower numbered VPA selected here must also not contain W type channels. If configured in this way then each VPA can still have independent WIRING, BANDWIDTH and HARMONICS settings but otherwise behave as if configured in a single VPA.

Recommendations:

For typical applications, the 10Hz/0.3s or 20Hz/0.1s setting is recommended.

For low power measurements to EN50564 and with a rapidly changing load the 45Hz/20ms setting should be considered. See section 17 for full details regarding EN50564 measurements.

##### 12.4.2.2.2 Setting the Source of the Fundamental Frequency

The FUND button allows you to select the source of fundamental frequency for the selected VPA if MEAS MODE is not EN61000-3-2 or EN61000-3-12.

If you select NONE then no fundamental frequency is used and harmonic analysis will not be available.

If you select FIXED then a further screen allows you to enter the frequency to use.

If you select VOLTAGE or CURRENT then the fundamental frequency will be measured using the selected signals in this VPA. With either of these selections a further screen allows you to enter the maximum frequency to measure.

If you select MAINS then the fundamental frequency will be measured using the voltage signals in this VPA. The measured frequency must be in the range 45 to 65Hz, if the signal frequency cannot be measured (or is outside of this range) then the PA900 mains supply frequency is used.

If you select AVIONICS then the fundamental frequency will be measured using the voltage signals in this VPA. The measured frequency must be in the range 300 to 900Hz.

If you select another VPA then the fundamental frequency used for this VPA is automatically obtained from that VPA in real time.

If you select a GFUND (1, 2 or 3) then the fundamental frequency used for this VPA is automatically obtained from the PA900 VPA which has been programmed to provide that GFUND measurement for this multi-unit group.

Recommendations:

For 50/60Hz applications the MAINS setting should be used.

For 400Hz applications the AVIONICS setting should be used.

When it is required to measure signals with a fundamental frequency close to or above the maximum measurable frequency of the channels in this VPA then select NONE.

If mainly the DC amplitude is needed, or no suitable fundamental can be established from any signal and the AC content is primarily over a few kHz, the NONE setting should be used.

When it is required to measure ripple on a DC supply at a specific frequency or harmonics of it then either the FIXED or MAINS setting should be used. For example, if mains ripple is to be measured then set this to MAINS and set the HARMONICS setting to at least 1 (typically 10 or more), harmonic analysis will then show the magnitude of the ripple at each harmonic of mains.



If the VPA being configured is making DC measurements but the signals have significant ripple at a frequency related to that being measured by another VPA, then setting that other VPA as the source of the fundamental for this VPA may be used to reduce the effects of that ripple and also enables you to use harmonic analysis in the VPA being configured to measure the ripple content of the DC signal.

In most other applications the VOLTAGE setting should be selected, however if the signals are a pulse width modulated waveform (e.g. a motor drive) then the CURRENT setting should be selected as this typically has significantly less carrier frequency content. The maximum frequency should be set as low as possible but high enough to allow the full range of expected signal frequencies. See section 16 for full details regarding configuring measurements on PWM generated signals.

Note:

Lead/lag and all non-harmonic measurements are still available when no fundamental can be measured; however the measurement period cannot be automatically adjusted to be an integer number of cycles of the signal AC content (this has minimal effect if the signal frequency is primarily over a few kHz).

#### 12.4.2.2.3 Setting a High Frequency Bandwidth Limit

The BANDWIDTH button allows you to select any bandwidth limiting to use within the VPA being configured if MEAS MODE is not EN61000-3-2 or EN61000-3-12.

If you select AUTO-TRACK then the PA900 will automatically provide just enough bandwidth limitation to have an insignificant effect on the measurements, as determined in real time from the fundamental frequency and the HARMONICS settings.

If you select UNFILTERED there is no bandwidth limitation and the full capability of the channels is available.

If you select USER you are also prompted to enter the desired -3dB bandwidth limitation.

Recommendations:

The AUTO-TRACK selection is recommended for most applications unless a set bandwidth or no limit at all is specifically required by the application or if measuring frequencies close to or above the maximum measurable frequency of the channels.

Note:

If the bandwidth restriction is beyond the capabilities of a channel then no bandwidth limitation is applied.

If you select AUTO-TRACK then you can return to this screen and see the actually applied limit, which is displayed in the lower half of this button, e.g. AUTO (6k).

If you select AUTO-TRACK and you also select NONE as the FUND setting, then a fixed 500Hz bandwidth limitation is used.

See section 16 for full details regarding configuring this for measurements on PWM generated signals.

#### 12.4.2.2.4 Configuring Harmonic Analysis

The HARMONICS button allows you to select the maximum number of harmonics to analyze within the VPA being configured if MEAS MODE is not EN61000-3-2 or EN61000-3-12. This is not available when MEAS MODE is set to SPECTRUM or if FUND is set to NONE.

Recommendations:

For most applications this should be set to 50 unless harmonic analysis is not required in which case it should be set to 0. Only if the specific application requires more harmonics is it recommended to set this higher.

In modulated signal applications (such as motor drives) this should be a low value and often a figure of 5 or less is used.

Notes:

If this is set to 0 then no harmonics will be analyzed in the VPA being configured.

Lead/lag and all non-harmonic measurements are still available when not performing harmonic analysis.

In order to accurately measure very high-order harmonics the cycle-to-cycle jitter of the signal frequency is of importance. To accurately measure 500 harmonics this requires that the source have <0.025% frequency jitter. Mains supplies rarely achieve this. If it is desired to measure high-order harmonics of an unstable frequency source then it is recommended that you consider using spectrum analysis instead.

The actual number of available harmonics is limited to half the bandwidth limitation, and may be further limited by other settings and/or by the measured fundamental frequency.

See section 16 for full details regarding configuring this for measurements on PWM generated signals.

#### 12.4.2.2.5 Configuring Spectrum Analysis

The SPECTRUM button (not shown in the example screen above) allows you to enter the desired frequency resolution (in Hz) and maximum desired frequency (in Hz) for the spectrum analysis. This is only available when MEAS MODE is set to SPECTRUM.

Note:

These settings have a major effect on the speed at which spectrum measurements can be made, for best speed use the largest possible frequency resolution and the smallest possible ratio between the resolution and maximum frequencies.

The frequency resolution entry is limited to be within 0.01Hz to 1kHz

The maximum frequency entry is limited to between 100 and 16384 times the frequency resolution.

#### 12.4.2.3 CONFIGURING HOW MEASUREMENT RESULTS ARE DISPLAYED

This is performed by using the buttons in the DATA area. Depending on configuration and the installed channels some buttons may not be present or may not allow modification of the setting.

#### 12.4.2.3.1 Setting the Default Coupling for Data

The COUPLING button allows you to select whether DC ONLY, AC ONLY or AC+DC results will be shown as the primary data on the POWER DATA screens, and used for the calculation of integrated data, and used for obtaining total values for the selected VPA.

Recommendation:

Unless it is known that only the DC results are required then the AC+DC setting is recommended.

Note:

DC ONLY is not available if MEAS MODE is EN61000-3-2 or EN61000-3-12.

This does not restrict channel measurement data to the selected coupling; the measurement results within a channel are generally available for all couplings.

#### 12.4.2.3.2 Setting for Result Averaging

The RESPONSE button allows you to select that measurement results will be averaged over time if MEAS MODE is not EN61000-3-2 or EN61000-3-12.

Settings of FASTEST, MEDIUM, SLOW and SLOWEST are available.

Recommendation:

The performance and specifications of the PA900 are not reliant on the use of this capability; it should only be used when needed and otherwise set to FASTEST.

When using results which are dependent on results from multiple VPAs or from motor results then these results may not all be using the same response averaging, which may result in inappropriate results while the signals are changing. In these cases it is recommended to use FASTEST for all response averaging settings.

Note:

This setting can be used in combination with the DIGITS setting (see below) to reduce the jitter in readings from unstable signals.

#### 12.4.2.3.3 Setting the Maximum Number of Displayed Digits

The DIGITS button allows you to select that all available measurement results will be displayed with limited resolution if desired.

Settings of 3, 4, 5 and 6 are available.

Recommendation:

In most applications this should be set to 5 or 6, if there is significant instability in the signals this should be set to 3 or 4.

Note:

This only affects displayed numerical results; it does not affect any measurements obtained via an interface or via a historically saved record or via data logging.

#### 12.4.2.3.4 Adjusting Measurements for V or A Terminal Burden

The ADJUST button allows you to select that results of each channel are adjusted to compensate for either the current drawn by the V terminals or for the voltage between the A terminals.

The labelling of each selection shows whether you need results at the source or at the load, followed (in braces) by whether the V terminals of each channel are connected at the source or the load.

If you select NONE then no adjustments are performed, the results use the unadjusted voltage and current signals.

If you select SRCE(V@SRCE) then the V terminal current burden is added to the A signal. This should be used when the V terminals are directly connected across the source voltage (so the A terminals are measuring the load current) and you wish to obtain the source results.

If you select SRCE(V@LOAD) then A terminal voltage burden is added to the V signal. This should be used when the V terminals are directly connected across the load voltage (so the A terminals are measuring the source current) and you wish to obtain the source results.

If you select LOAD(V@SRCE) then the A terminal voltage burden is subtracted from the V signal. This should be used when the V terminals are directly connected across the source voltage (so the A terminals are measuring the load current) and you wish to obtain the load results.

If you select LOAD(V@LOAD) then the V terminal current burden is subtracted from the A signal. This should be used when the V terminals are directly connected across the load voltage (so the A terminals are measuring the source current) and you wish to obtain the load results.

Recommendation:

In most applications this should be set to NONE; only if not using external current transducers and either operating at low voltages and high currents or at high voltages and low currents should this be set for an adjustment to be applied.

See section 18 for full details regarding configuring this for EN61000-3-2 and -12 measurements.

Note:

Channels which have scaling applied ignore the ADJUST setting and their signals are not adjusted.

#### 12.4.2.4 CONFIGURING HOW RESULTS ARE COMBINED

This is performed by using the buttons in the COMBINE area.

Depending on configuration and the installed channels not all buttons may be present and the COMBINE area itself may not present.

##### 12.4.2.4.1 Setting How the Channels are Wired

The WIRING button allows you to select how measurements are combined and labelled when producing total results for this VPA.



The selection made must match the method used to wire the application to the PA900 channels in this VPA (see section 9).

Note:

The available selections are determined from the number of channels selected in this VPA. If the number of channels is altered then this setting will be reset to the  $N \times 1\emptyset$  setting (which is valid for any number of channels).

#### 12.4.2.4.2 Setting How Power will be Included in Efficiency and Power Loss

The EFF/LOSS button allows you to select how the total power of this VPA is included in efficiency and power loss data.

This button is not available if MEAS MODE is set to SINGLE VPA or SPECTRUM.

The PA900 allows the total watts of a VPA to be included in one of three available data; IN, MIDDLE and OUT power. Alternately the total power of this VPA can be excluded from all three of these.

Note:

If the PA900 is configured as part of a multi-unit group then the resulting IN, MID, OUT power totals, power loss and efficiency results will include the total IN, MID and OUT power measurements from all PA900s within that multi-unit group.

### 12.4.3 CONFIGURING MECHANICAL MEASUREMENTS (MOTOR OR GENERATOR)

If a MT type channel is installed in the CH4 location then the CONFIG VPA button is always shown and allows you to select whether a VPA or the MOTOR measurements are to be configured.

The example screen shown below is an example of the MOTOR configuration screen.

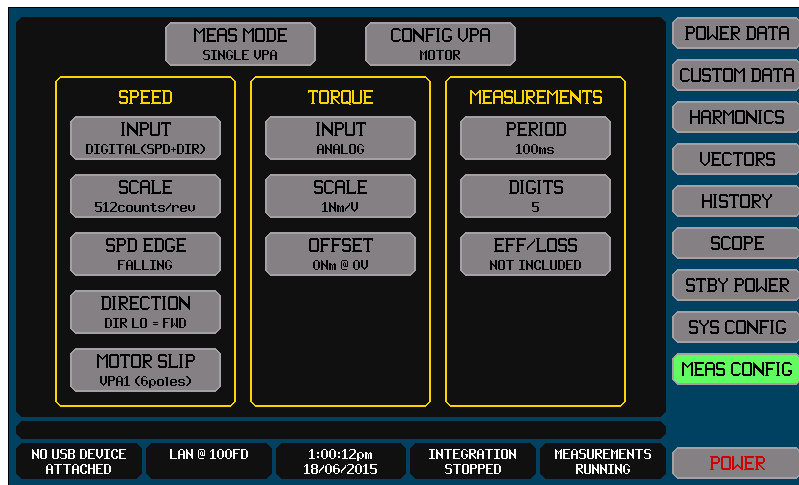

#### 12.4.3.1 CONFIGURING MECHANICAL SPEED MEASUREMENTS

The measurement of mechanical speed is configured using the buttons in the SPEED area shown on the screen.

The INPUT button allows you to select the source of mechanical speed.

If you select NONE then no mechanical speed or mechanical power results will be available from the PA900.

If you select ANALOG (SPD) then mechanical speed will be computed from the measured DC voltage on the SPD input using the SCALE (in units of rpm/V) and OFFSET (in units of rpm) settings.

If you select DIGITAL (SPD) then mechanical speed is computed from the measured frequency of the digital signal on the SPD input using the SCALE (in pulses per rev) and SPD EDGE settings. The direction is always considered as 'forward' in this configuration.

If you select DIGITAL (SPD+DIR) then mechanical speed is computed from the measured frequency of the digital signal on the SPD input using the SCALE (in pulses per rev) and SPD EDGE settings and the direction is determined by the polarity of the DIR signal at each edge of the SPD signal with the meaning selected by the DIRECTION button selection.

If you select an electrical VPA (i.e. VPA1, VPA2 or VPA3) then the mechanical speed is computed from the measured frequency of that VPA using the MOTOR POLES setting. The direction is always considered as 'forward' in this configuration.

The SCALE button (if shown) allows you set the scaling to apply to the measurement of the selected source of the speed measurement.

The MOTOR POLES button (if shown) allows you to set the number of poles in the motor, which is used to scale the electrical frequency selected into an equivalent mechanical rotation speed.

The OFFSET button (if shown) allows you set the offset to apply to the measurement of the selected source of the speed measurement.

The SPD EDGE button (if shown) allows you to select which edge of the digital SPD signal is used for frequency and direction detection purposes (if enabled).

The DIRECTION button (if shown) allows you to select if a LO logic level or a HI logic level on the DIR input at the selected edge of the SPD signal is taken as indicating a 'forward' or 'reverse' direction (i.e. a positive or a negative speed respectively).

The MOTOR SLIP button (if shown) allows you to select the source of the electrical drive frequency (i.e. which VPA to obtain the frequency from). You may also select NONE to turn off the computation of motor slip. If a VPA is selected then you are also

prompted to enter the number of motor poles which is used to scale the mechanical speed before comparison with the electrical drive frequency.

Note:

For simplicity, the descriptions above assume that a motor is being measured. Measurement of a generator is identical with the respective similar meanings for each button.

Although usually an integer number, entry of the number of SPD input pulses per revolution of the motor is not restricted to integer numbers but must be  $\geq 1.0$ .

Although usually an integer number, entry of the number of motor poles is not restricted to integer numbers but must be  $>0.0$  and  $\leq 100$ .

The SCALE and OFFSET buttons allow entries of any value with either polarity.

### 12.4.3.2 CONFIGURING MECHANICAL TORQUE MEASUREMENTS

The measurement of mechanical torque is configured using the buttons in the TORQUE area shown on the screen.

The INPUT button allows you to select the source of mechanical torque.

If you select NONE then no mechanical torque or mechanical power results will be available from the PA900.

If you select ANALOG then mechanical torque will be computed from the measured DC voltage on the TRQ input using the SCALE (in units of Nm/V) and OFFSET (in units of Nm) settings shown below the INPUT button on the screen.

If you select DIGITAL then mechanical torque is computed from the measured frequency of the digital signal on the TRQ input using the SCALE (in Nm per Hz) and OFFSET (in Nm) settings shown below the INPUT button on the screen.

The SCALE button (if shown) allows you set the scaling to apply to the measurement of the selected source of the torque measurement.

The OFFSET button (if shown) allows you set the offset to apply to the measurement of the selected source of the torque measurement.

Note:

For simplicity, the descriptions above assume that a motor is being measured. Measurement of a generator is identical with the respective similar meanings for each button.

The SCALE and OFFSET buttons allow entries of any value with either polarity.

### 12.4.3.3 OVERALL CONFIGURATION OF MECHANICAL MEASUREMENTS

The overall configuration of mechanical measurements is configured using the buttons in the OVERALL area shown on the screen.

The PERIOD button allows you to select the measurement period for speed and torque measurements.

Settings of 10ms, 30ms, 100ms, 300ms, 1s, 3s, 10s, 30s, 100s, VPA1 SYNC, VPA2 SYNC, and VPA3 SYNC are available.

If you select a time period of less than 1 second then the measurement period will be a minimum of the selected time. If either (or both) digital inputs of speed and torque have a period of longer than this but less than 1 second then the measurement period (for both speed and torque) is automatically extended to allow measurement of that frequency.

If you select a time period of greater than 1 second then this sets both the measurement period and also the minimum measurable frequency (i.e. the maximum period) for digital inputs of speed and/or torque.

If you select an electrical VPA then the measurement is selected to be synchronous with the selected VPA.

Note:

If you select to synchronize mechanical measurements to a VPA which has no channels selected then there will be no measurements of mechanical speed or torque.

Recommendation:

Where the electrical power of the drive (for a motor) or the generated energy (for a generator) is being measured in a VPA in the PA900 then that VPA is usually selected for the PERIOD setting. This ensures that the related electrical and mechanical power measurements are made over the same periods of time.

The DIGITS button allows you to select that all mechanical measurement results will be displayed with limited resolution if desired.

Settings of 3, 4, 5 and 6 are available.

Note:

This only affects displayed numerical results; it does not affect any measurements obtained via an interface or via a historically saved record or via data logging.

Recommendation:

In most applications this should be set to 5 or 6, if there is significant instability in the signals this should be set to 3 or 4.

The EFF/LOSS button allows you to select how the mechanical power (if available) is included in efficiency and power loss data.

The PA900 allows mechanical power to be included in one of three available data; IN, MIDDLE and OUT power. Alternately it can be excluded from all three of these.

---

## 12.4.4 IMPORTING, EXPORTING OR RECORDING THE MEASUREMENT CONFIGURATION

The methods for performing this are fully described in section 23.

The measurement configuration can be imported from or exported to a binary file on an external USB drive attached to the front panel USB port.

Notes:

This file contains almost the entire configuration of the PA900 (measurements, screens, harmonics limits, custom screen definition, and preferences). It does not include the interface configuration or the POWER CTRL preference setting.

You can have an almost unlimited number of configurations available to you by creating, exporting and importing them using a USB Drive in this manner.

Briefly, this is performed by –

1. Insert the drive into the front panel USB port and wait for it to be READY.
2. Press the DRIVE INFO area of the screen, the screen shows the file export/import screen.
3. To export (save) a binary configuration file –
  - a. Press the CONFIGURATION button. The screen changes to allowing you to enter a file name.
  - b. Enter the desired file name (the extension is automatically provided).
  - c. If the file already exists then you are prompted to respond if you wish to overwrite it or not.
  - d. The file is then written.
4. To import (load) a previously exported binary configuration file –
  - a. Press the IMPORT button in the right side of this screen, the screen shows the file import screen.
  - b. Press the CONFIGURATION button. The right area of the screen shows a list of the available configuration files.
  - c. Press the desired file button. The file is then imported and the new configuration is immediately active.

Alternatively, you can make a record of a measurement configuration by saving an image of the MEAS CONFIG screen to a graphic file on an external USB drive attached to the front panel USB port.

Briefly, this is performed by –

1. Insert the drive into the front panel USB port and wait for it to be READY.
2. Display the MEAS CONFIG screen showing the VPA which you wish to make a record of.
3. Press the DRIVE INFO area of the screen, the screen shows the file export/import screen.
4. Press the SCREEN IMAGE button. The screen changes to allowing you to enter a file name.
5. Enter the desired file name (the extension is automatically provided).
6. If the file already exists then you are prompted to respond if you wish to overwrite it or not.
7. The file is then written.

## 12.5 VIEWING NUMERICAL MEASUREMENTS – THE POWER DATA SCREEN

The POWER DATA Screen can be selected for view from any of the Main Data Screens by pressing the POWER DATA button.

The POWER DATA Screen gives you access to pre-formatted numeric measurement results for individual channels or VPAs, or to overall power loss and efficiency results.

There are several formats available as described in the following sections.

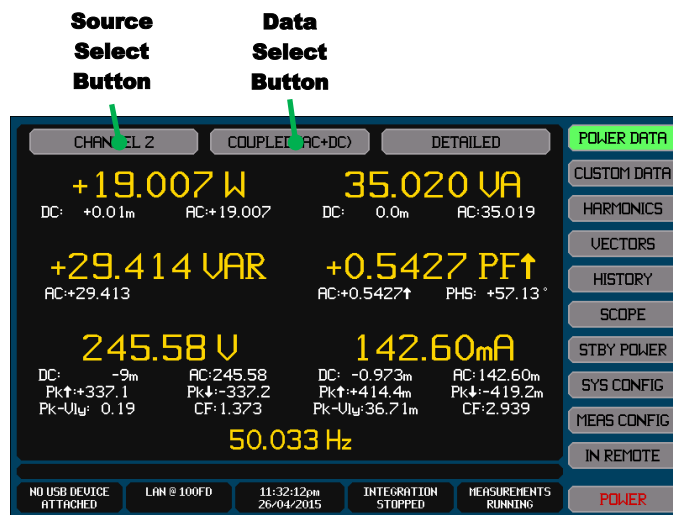

### 12.5.1 VIEWING MEASUREMENT RESULTS FOR AN INDIVIDUAL CHANNEL

The results for an individual channel can be selected on the POWER DATA screen by pressing the Source Select Button and selecting the desired channel. Only channels configured for measurement, i.e. selected in a VPA, can be selected.

For an individual channel, the Data Select Button allows the selection of a variety of data, each having a slightly different layout.

#### 12.5.1.1 COUPLED, RECTIFIED AND FUNDAMENTAL DATA

This is viewed by selecting the COUPLED, RECTIFIED or FUNDAMENTAL selection in the Data Select Button. If the COUPLED selection is chosen then the button also shows the configured COUPLING setting for this channel (i.e. DC, AC or AC+DC).

This screen shows the Volts, Amps, Watts, VA, VAR, PF and Frequency measurements for the selected Channel.

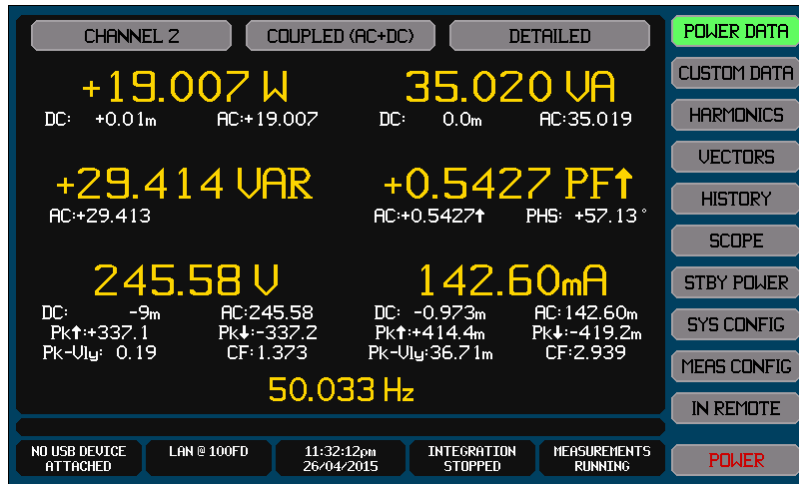

The primary measurement results are shown using a large font and colored yellow-gold.

CAUTION: If V and/or A signals have RMS values which are beyond the measurement capability of the channel then the respective primary data is colored red. You should ensure that the signals are within the capabilities of the channel and should reduce the signal levels as soon as possible otherwise the channel may be damaged.

Whether the current is leading or lagging the voltage can be determined by the direction of an arrow shown immediately after any PF data shown. If the arrow is pointing upwards then the current is leading, if downwards then it is lagging.

The Watts, VA, VAR, PF, Volts and Amps results are grouped with their respective secondary results.

The secondary results are shown in a smaller font and are colored white and these may be disabled or enabled by pressing the DETAILED/BASIC Button. These include the results for couplings other than that configured (for the example above, AC+DC is configured as the COUPLING so the secondary results show the DC and AC data). DC PF is never shown.

For COUPLED or RECTIFIED data the voltage and current group secondary data also shows the most positive and most negative peak excursions, the difference between the highest and lowest half-cycle peaks, and the crest factors (for COUPLED) or form factors (for RECTIFIED).

If the signals have peaks which are beyond the measurement capability of the channel then the respective peak data is colored red. This should not necessarily be taken as a cause for concern, particularly if only temporary; it merely indicates that the displayed results may not be fully accurate as they include 'clipped' signals.

Half-cycle peak data is not shown if the fundamental frequency cannot be established or there are 2 or less cycles of the signal in a measurement period.

For FUNDAMENTAL data the voltage and current group secondary data also shows the distortion including all configured harmonics as a percentage relative to the fundamental.

The PHS data in the PF group secondary data is the inverse cosine of the PF data with the polarity set from the lead/lag determination.

The frequency shown (if any) is the fundamental frequency obtained for this channel, from the source configured by the FUND setting in the MEAS CONFIG screen for this channel.

If MEASURING is shown for frequency with no other measurement results, then this indicates that the first measurement is being made with a new configuration. This is temporary (unless measurements are held); as soon as the first measurement results are available they will be shown.

If NO FUNDAMENTAL is shown for frequency, then this indicates that the signal providing the fundamental frequency measurement (the FUND setting in the MEAS CONFIG screen for this channel) is either not present or has not been measured yet following a change to the measurement configuration.

If configured for LF or VLF measurements (by the LF/PERIOD setting in the MEAS CONFIG screen for this channel) then a measurement progress bar is included in the lower right corner of the data window.

### 12.5.1.2 INRUSH DATA

This is viewed by selecting the INRUSH selection in the Data Select Button.

This screen shows the highest ACDC Watts, highest ACDC Volts, highest Peak Volts (largest excursion from zero), lowest valley peak Volts (the lowest excursion from zero of the peak in any half cycle), highest ACDC Amps, highest Peak Amps (largest excursion from zero) and the lowest valley peak Amps (the lowest excursion from zero of the peak in any half cycle).

Note:

The measurements obtained for inrush are not affected by the RESPONSE setting for the VPA.

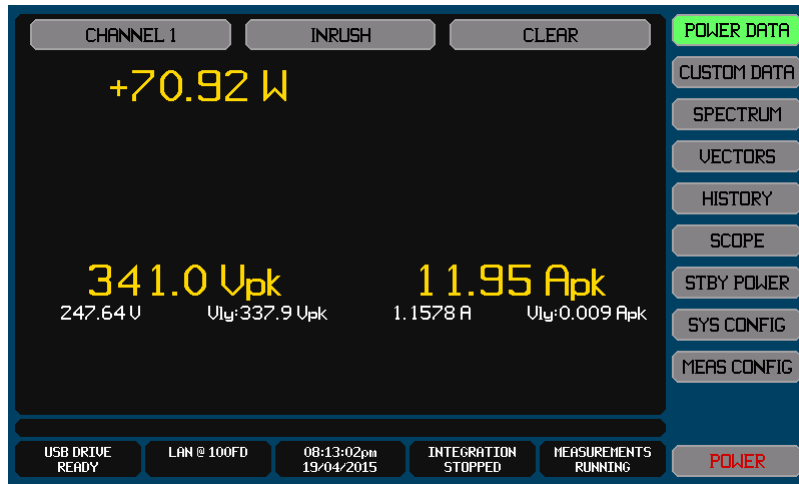

The data shown on this screen may be reset by pressing the CLEAR button.  
See section 14 for full details regarding using this screen to make Inrush measurements.

### 12.5.1.3 LOAD DATA

This is viewed by selecting the LOAD, LOAD (LR) or LOAD (CR) selections in the Data Select Button. If the COUPLING configuration setting for the VPA containing this channel is set to DC then only the LOAD selection is available, otherwise only the LOAD (CR) and LOAD (LR) selections are available.

This screen shows the load impedance for LOAD, the best fit series resistance/inductance for LOAD (LR), or the best fit parallel resistance/capacitance for LOAD (CR).

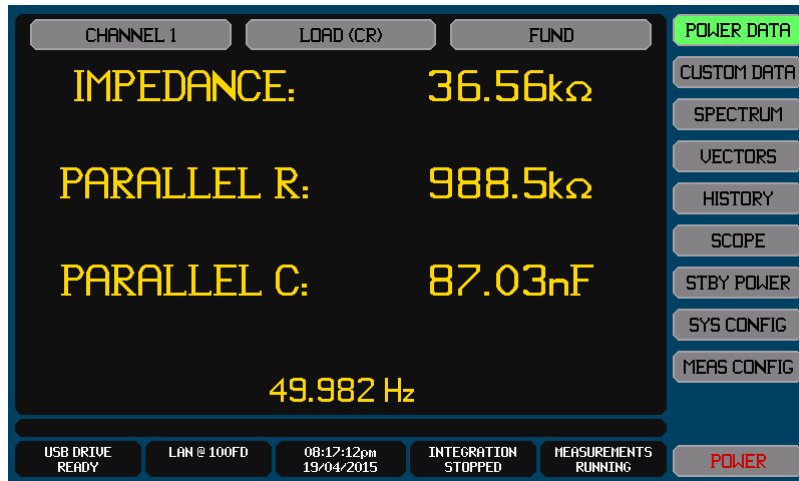

If LOAD is selected –

Only the IMPEDANCE data is shown

If LOAD (CR) or LOAD (LR) is selected –

If harmonic data is available then pressing the AC/FUND button toggles between showing the AC coupled or fundamental data respectively.

If a fit could not be obtained for the selected load then the parallel C or series L data is blank (you typically should select the other type of loading indication) but the IMPEDANCE data is always shown (and is the same data in either screen).

### 12.5.1.4 INTEGRATED DATA

This is viewed by selecting the INTEGRATED, INTEG AVG, BOUGHT POWER, SOLD POWER, CHARGE or DISCHARGE selections in the Data Select Button.

INTEG AVG is the INTEGRATED data divided by the integration time, so yields the average data over the entire integration period.

BOUGHT POWER is data integrated only while the Watts reading is positive.

SOLD POWER is data integrated only while the Watts reading is negative.

CHARGE is data integrated only while the DC Amps reading is positive.

DISCHARGE is data integrated only while the DC Amps reading is negative.

This screen shows the integrated measured (or integrated average measured) Volts, Amps, Watts, VA, VAR (and PF for integrated average) and the integration time.

If harmonic data is available then pressing the COUPLED/FUND button toggles between showing the coupled (DC, AC or AC+DC as configured) or fundamental data for INTEGRATED or INTEG AVG data.

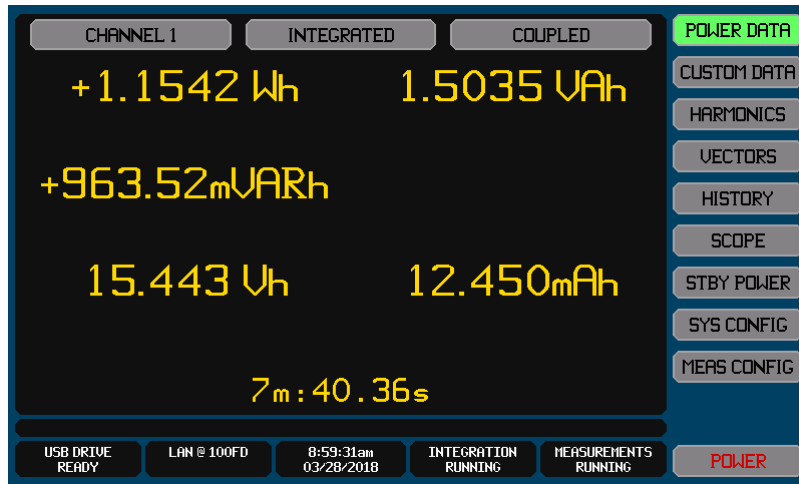

If no integration has been performed then NO DATA is displayed. Integration can be configured, started or stopped by pressing the Integrate Info area in the bottom of any main data screen. See section 15 for full details. Integration results are always cleared when integration is started.

## 12.5.2 VIEWING MEASUREMENT RESULTS FOR A VPA

The results for a VPA can be selected on the POWER DATA screen by pressing the Source Select Button and then selecting the desired VPA. Only VPAs configured for measurement, i.e. containing at least one channel, can be selected.

For a VPA the Data Select Button allows the selection of a variety of data, each having a slightly different layout. The layout also slightly varies with the WIRING configuration setting for the VPA.

### 12.5.2.1 COUPLED, RECTIFIED AND FUNDAMENTAL DATA

This is viewed by selecting the COUPLED, RECTIFIED or FUNDAMENTAL selection in the Data Select Button. If the COUPLED selection is chosen then the button also shows the configured COUPLING setting for this VPA (i.e. DC, AC or AC+DC).

This screen shows the mean Volts, mean Amps, total Watts, total VA, total VAR, total PF and Frequency measurements for the selected VPA.

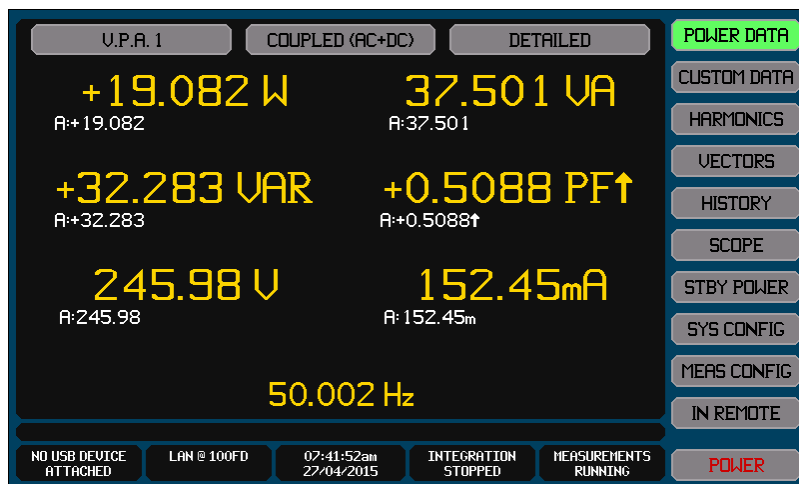

The primary measurement results are shown using a large font and colored yellow-gold.

**CAUTION:** If V and/or A signals have RMS values which are beyond the measurement capability of the channel then the respective primary data is colored red. You should ensure that the signals are within the capabilities of the channel and should reduce the signal levels as soon as possible otherwise the channel may be damaged.

The primary Watts, VA, VAR and PF data is the total data for the VPA.

The primary Volts and Amps data is the average for all phases/channels in the VPA.

Whether the current is leading or lagging the voltage can be determined by the direction of an arrow shown immediately after any PF data shown. If the arrow is pointing upwards then the current is leading, if downwards then it is lagging.

The Watts, VA, VAR, PF, Volts and Amps results are grouped with their respective secondary results.

The secondary results are shown in a smaller font and are colored white and these may be disabled or enabled by pressing the DETAILED/BASIC Button.

For all data the secondary results show the individual channel results for each channel in the VPA.

For 3 $\phi$ 3w(2ch) and 3 $\phi$ 3w(3ch) WIRING settings the secondary voltages are the phase-to-phase voltages and the primary voltage is the average of the three phase-to-phase voltages.

For 3 $\phi$ 3w(2ch) and 3 $\phi$ 3w(3ch) WIRING settings the Wye voltage conversion is also shown.

For 3 $\phi$ 4w WIRING setting the Delta voltage conversion is also shown.

Whether the current is leading or lagging the voltage can be determined by the direction of an arrow shown immediately after any PF data shown. If the arrow is pointing upwards then the current is leading, if downwards then it is lagging.

The PHS data in the PF group secondary data is the inverse cosine of the PF data with the polarity set from the lead/lag determination.

The frequency shown (if any) is the fundamental frequency obtained for this channel, from the source configured by the FUND setting in the MEAS CONFIG screen for this channel.

If MEASURING is shown for frequency with no other measurement results, then this indicates that the first measurement is being made with a new configuration. This is temporary (unless measurements are held); as soon as the first measurement results are available they will be shown.

If NO FUNDAMENTAL is shown for frequency, then this indicates that the signal providing the fundamental frequency measurement (the FUND setting in the MEAS CONFIG screen for this channel) is either not present or has not been measured yet following a change to the measurement configuration.

If configured for LF or VLF measurements (by the LF/PERIOD setting in the MEAS CONFIG screen for this channel) then a measurement progress bar is included in the lower right corner of the data window.

### 12.5.2.2 INRUSH DATA

This is viewed by selecting the INRUSH selection in the Data Select Button.

This screen shows the highest total ACDC Watts, highest phase ACDC Volts, highest phase Peak Volts (largest excursion from zero), highest phase ACDC Amps, and the highest phase Peak Amps (largest excursion from zero) for the selected VPA. The data shown on this screen may be reset by pressing the CLEAR button.

Note:

The measurements obtained for inrush are not affected by the RESPONSE setting for the VPA.



See section 14 for full details regarding using this screen to make Inrush measurements.

### 12.5.2.3 INTEGRATED DATA

This is viewed by selecting the INTEGRATED, INTEG AVG, BOUGHT POWER, SOLD POWER, CHARGE or DISCHARGE selections in the Data Select Button.

INTEG AVG is the INTEGRATED data divided by the integration time, so yields the average data over the entire integration period.

BOUGHT POWER is data integrated only while the Watts reading is positive.

SOLD POWER is data integrated only while the Watts reading is negative.

CHARGE is data integrated only while the DC Amps reading is positive.

DISCHARGE is data integrated only while the DC Amps reading is negative.

This screen shows the integrated measured (or integrated average measured) mean Volts, mean Amps, total Watts, total VA, total VAR (and total PF for integrated average) and the integration time.

If harmonic data is available then pressing the COUPLED/FUND button toggles between showing the coupled (DC, AC or AC+DC as configured) or fundamental data for INTEGRATED or INTEG AVG data.



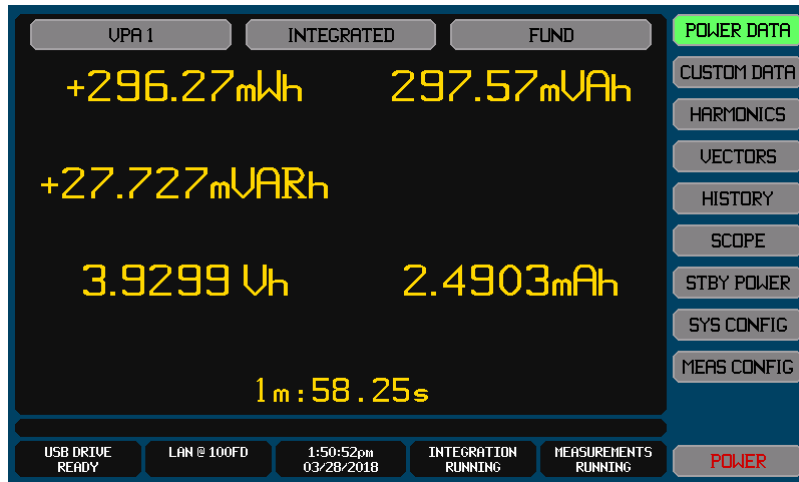

If no integration has been performed then NO DATA is displayed. Integration can be configured, started or stopped by pressing the Integrate Info area in the bottom of any main data screen. See section 15 for full details. Integration results are always cleared when integration is started.

### 12.5.3 VIEWING EFFICIENCY AND POWER LOSS MEASUREMENT RESULTS

The results for efficiency and power loss can be selected on the POWER DATA screen by pressing the Source Select Button and then selecting EFFICIENCY. This selection is only available if at least one VPA is configured to be included in the IN, MIDDLE or OUT groups.

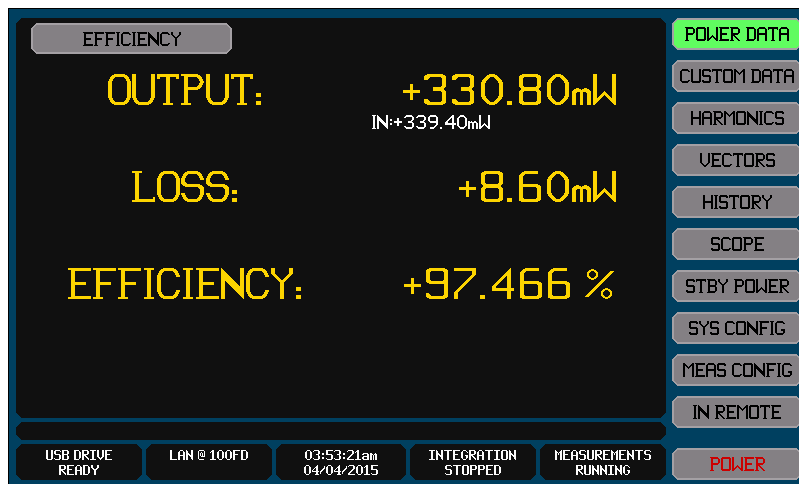

The Watts for the OUT group is shown as the primary data for the OUTPUT Power result.  
 The Watts for the IN and MIDDLE groups are shown as secondary data under the OUTPUT Power result.  
 The IN:OUT power loss is shown as the primary data for the LOSS result.  
 The IN:MIDDLE and MIDDLE:OUT power loss is shown as secondary data under the LOSS result.  
 The IN:OUT efficiency is shown as the primary data for the EFFICIENCY result.  
 The IN:MIDDLE and MIDDLE:OUT efficiency is shown as secondary data under the EFFICIENCY result.  
 Each data is only shown if VPAs are configured in the relevant groups for that data.

Note:

If the PA900 is configured as part of a multi-unit group then the resulting IN, MID, OUT power totals, power loss and efficiency results will include the total IN, MID and OUT power measurements from all PA900s within that multi-unit group.

### VIEWING MECHANICAL MEASUREMENT RESULTS

The results for mechanical power, torque, speed and motor slip can be selected on the POWER DATA screen by pressing the Source Select button and then selecting MOTOR. This selection is only available if an MT channel is installed in the CH4 position and at least torque or speed is configured to be measured.



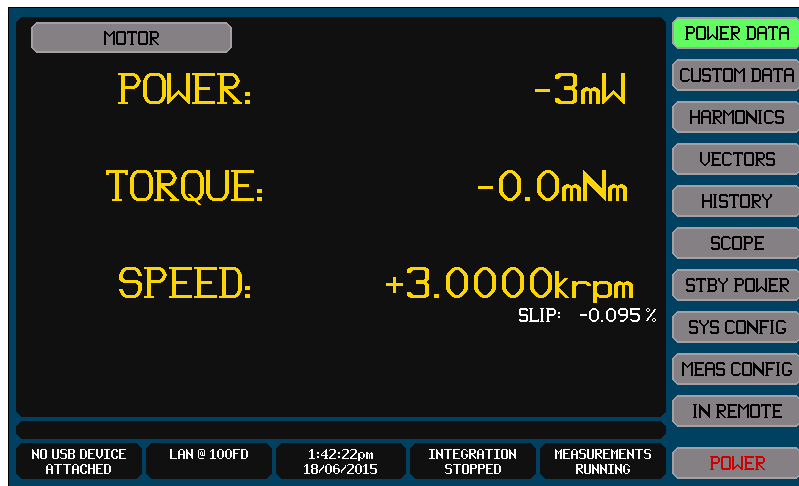

## EXPORTING OR RECORDING MEASUREMENTS

The methods for performing this are fully described in section 21.

Measurements can be exported to a .CSV format textual file on an external USB drive attached to the front panel USB port. This file contains all measurements (including harmonics) for all channels and all VPAs.

Briefly, this is performed by –

1. Insert the drive into the front panel USB port and wait for it to be READY.
2. Press the DRIVE INFO area of the screen, the screen shows the file export/import screen.
3. Press the MEASUREMENTS button. The screen changes to allowing you to enter a file name.
4. Enter the desired file name (the extension is automatically provided).
5. If the file already exists then you are prompted to respond if you wish to overwrite it or not.
6. The file is then written.

Alternatively you can make a record of any measurement screen by saving an image of it to a graphic file on an external USB drive attached to the front panel USB port

Briefly, this is performed by –

1. Insert the drive into the front panel USB port and wait for it to be READY.
2. Display the screen to be recorded.
3. Press the DRIVE INFO area of the screen, the screen shows the file export/import screen.
4. Press the SCREEN IMAGE button. The screen changes to allowing you to enter a file name.
5. Enter the desired file name (the extension is automatically provided).
6. If the file already exists then you are prompted to respond if you wish to overwrite it or not.
7. The file is then written.

## 12.6 VIEWING CUSTOM NUMERICAL MEASUREMENTS – THE CUSTOM DATA SCREEN

The CUSTOM DATA Screen gives you access to user-formatted numeric measurement results which are entirely selected and defined by you.

Any numeric measurement result obtainable within the PA900 can be displayed in a variety of screen positions with a variety of font sizes and colors and optionally with text associated with it.

The CUSTOM DATA Screen can be selected for view from any of the Main Data Screens by pressing the CUSTOM DATA button. A simple example custom data screen is shown below.

Defining the CUSTOM DATA screen requires one of the following –

Using the supplied application to create the desired screen and then sending the created custom screen definition to the PA900 via an interface.

Or, exporting the binary custom screen definition from a PA900 which already has the desired custom screen definition and then importing this file into another PA900 using a USB drive.

Or, importing an ASCII file on a USB drive which has been generated by you using a text editor (or Excel). See section 23.6.3 for details regarding this.

Note:

A CUSTOM DATA screen only needs to be defined once. It is stored internally in a non-volatile manner.

You can have many binary custom screen definitions on a single USB drive and you can switch between custom screens by importing the desired custom screen.

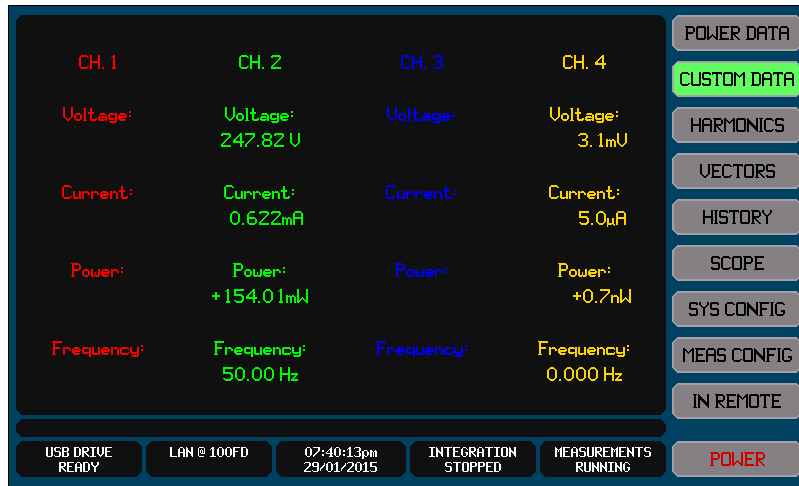

## 12.7 VIEWING HARMONICS MEASUREMENTS – THE HARMONICS SCREEN

The HARMONICS Screen gives you access to graphically formatted bar charts of channel voltage, current, power and inter-phase voltage harmonics and a scrollable numerical listing of that data.

The HARMONICS Screen can be selected for view from any of the Main Data Screens by pressing the HARMONICS button.

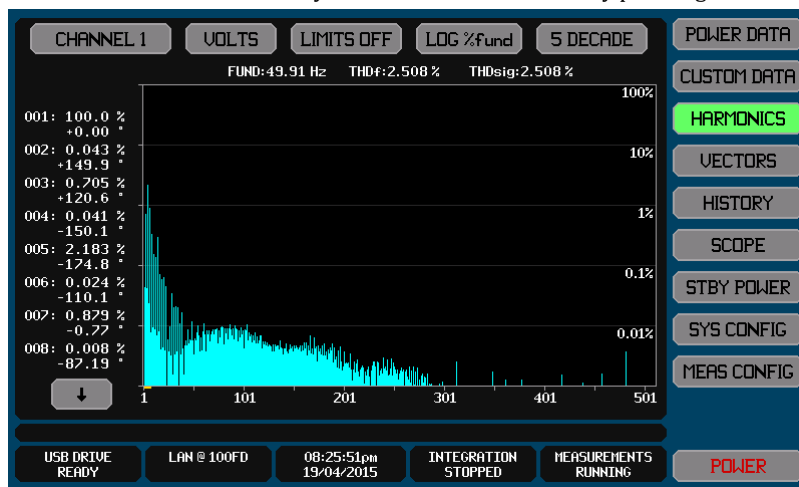

The displayed data is controlled by the buttons across the top of the screen (in order from left to right) -

1. Select which channel is shown by using the leftmost button. If this button colors RED when pressed then this indicates that the presently selected channel is the only channel configured.
2. Select whether voltage, current, watts or inter-phase voltage harmonics are shown by using the VOLTS/AMPS/WATTS button. This button has a Vph-ph selection for inter-phase voltage harmonics available if the selected channel is configured for 3p3w(3ch) or 3p4w measurements. The Vph-ph selection selects that the voltage harmonics of the inter-phase voltage between the selected channel and the next higher channel in the VPA will be shown (the voltage between the last and the first channel is shown if the last channel is selected).
3. Select whether the selected voltage or current harmonics are to be compared against limits by the LIMITS button. See below for details regarding applying harmonics limits.
4. Select the format of the bar chart by using the fourth button. You may select linearly or logarithmically scaled bar charts, either showing absolute data, or relative to the fundamental, or relative to the total signal.
5. If a logarithmic format bar chart is selected then the fifth button allows you to select how many decades are shown (1 through 5).

Note:

If no harmonics are available to be shown then the bar chart is blank, there are no numerical listings on the left side, and NO HARMONICS AVAILABLE is shown in the chart. Typically this indicates that the signal providing the fundamental frequency measurement (the FUND setting in the MEAS CONFIG screen for this VPA) is not present, or that the selected channel is not configured for harmonics measurements (see the FUND and HARMONICS settings in the MEAS CONFIG screen for this VPA), or you have selected a relative chart and only the fundamental is available.

If the frequency is shown colored orange then the harmonics are not locked closely enough to allow accurate measurement of all configured harmonics.

The actual number of harmonic bars shown may be lower than the configured setting due to the maximum harmonic frequency constraints for the selected channel (dependent on the channel type, the actual fundamental frequency, and the HARMONICS and BANDWIDTH settings on the MEAS CONFIG screen for the selected VPA).

When showing watts harmonics the height of the bar is independent of the polarity, the polarity is shown in the numeric harmonics listing to the left of the chart.

When showing inter-phase voltage harmonics, phase data is not available in the numeric harmonics listing to the left of the chart.

## 12.7.1 USING THE NUMERICAL LISTING

The numerical listing down the left side shows the amplitude and phase (phase is not available for all results) for up to 8 selected harmonics.

Each harmonic is listed with the harmonic number, and also there is a gold colored bar under the horizontal axis of the bar chart showing where the listed harmonics are located on the bar chart.

There are two methods which can be used to scroll the numerical listing –

Using the scroll up/down buttons above and below the listing (these buttons repeat if held pressed).

Or, pressing anywhere in the bar chart. This positions the listing in the harmonics shown at that position on the bar chart. You may also drag the listing in this manner.

Note:

The amplitude data is in Volts or Amps or Watts or % units as set by the type of bar chart selected.

The phase data is in degree units with  $\pm 180^\circ$  range as follows –

Fundamental Voltage : relative to the V fundamental in the lowest numbered channel of the VPA

Non-fundamental Voltage : relative to the V fundamental in this channel

Fundamental Current : relative to the V fundamental in this channel

Non-fundamental Current : relative to the A fundamental in this channel, except when configured for EN61000-3-12 measurements, when the 5<sup>th</sup> harmonic is the phase relative to the V fundamental in this channel

## 12.7.2 COMPARING HARMONICS AGAINST LIMITS

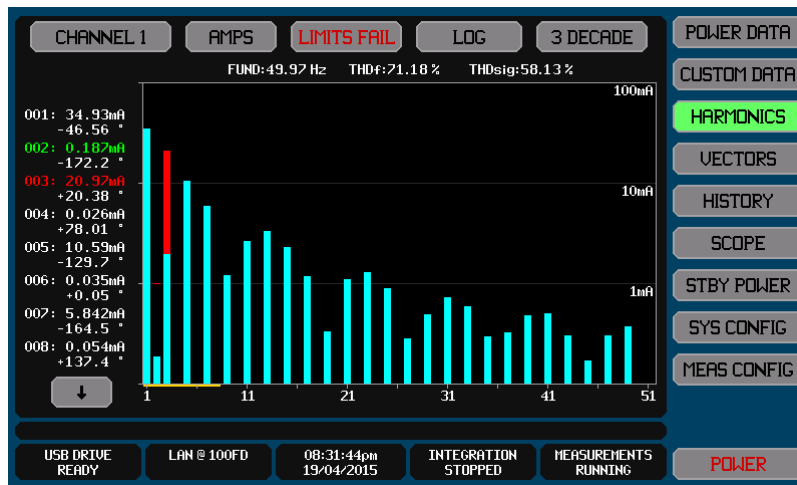

The PA900 has the ability to compare voltage and current harmonics against limits set for each harmonic independently for voltage and current.

If limits are enabled to be shown then-

The bar chart includes a red line indicating the limit for each checked harmonic

Colors the portion of any failing harmonic bar as red above the limit (the example above shows this)

Colors the numerical listing for each compared harmonic as either green (pass) or red (fail) or white (not checked)

Shows the overall pass/fail status in the LIMIT button (colored red or green)

In the example shown above only the 2<sup>nd</sup> and 3<sup>rd</sup> harmonics have limits defined and the 3<sup>rd</sup> harmonic is failing.

Note:

When configured for EN61000-3-2 measurements then you can select any of the classifications of EUT specified in the standard. The limits employed are, if needed, calculated from the actual current, power and/or power factor measurements. This is not a regulatory assessment, but may be used for informative purposes

When configured for EN61000-3-12 measurements then you can select any of the limits tables specified in the standard. The limits employed are calculated from the actual current measurements. This is not a regulatory assessment, but may be used for informative purposes

### 12.7.2.1 COMPARING AGAINST USER LIMITS

In order to compare harmonics against user limits (i.e. not regulatory limits) you must define those limits as follows–

1. Create the harmonic limit for each required harmonic.
  - a. This can be achieved by using the interface to command the limits directly into the PA900,
  - b. Or, they can be exported from a PA900 which already has the harmonics limits defined and then importing that file into this PA900 using a USB drive.
  - c. Or, they can be imported from an ASCII file on a USB drive which has been generated by you. See section 23.6.2 for details regarding this.

- d. Note that this only needs to be performed once if the same set of limits is to be used repeatedly. The PA900 internally saves the presently defined sets of harmonic limits.
2. Once limits have been defined the PA900 always compares the measured harmonics against these limits, you may select whether the bar chart and numeric listing in the HARMONICS screen includes the results of those comparisons or not by pressing the LIMIT button on the HARMONICS screen.

### 12.7.3 EXPORTING OR RECORDING HARMONICS

The methods for performing this are fully described in section 23.

Harmonics measurements can be exported to a .CSV format textual file on an external USB drive attached to the front panel USB port. This file contains a tabular listing of all measured harmonics in a specified VPA.

Briefly, this is performed by –

1. Insert the drive into the front panel USB port and wait for it to be READY.
2. Press the DRIVE INFO area of the screen, the screen shows the file export/import screen.
3. Press the HARMONICS button. The screen changes to allowing you to enter a file name.
4. Enter the desired file name (the extension is automatically provided).
5. If the file already exists then you are prompted to respond if you wish to overwrite it or not.
6. If configured for more than a single VPA then you are prompted to select the VPA for which to export the harmonics.
7. The file is then written.

Alternatively you can make a record of any measurement screen by saving an image of it to a graphic file on an external USB drive attached to the front panel USB port.

Briefly, this is performed by –

1. Insert the drive into the front panel USB port and wait for it to be READY.
2. Display the screen to be recorded.
3. Press the DRIVE INFO area of the screen, the screen shows the file export/import screen.
4. Press the SCREEN IMAGE button. The screen changes to allowing you to enter a file name.
5. Enter the desired file name (the extension is automatically provided).
6. If the file already exists then you are prompted to respond if you wish to overwrite it or not.
7. The file is then written.

## 12.8 VIEWING FUNDAMENTAL SIGNAL VECTORS - THE VECTORS SCREEN

The VECTORS Screen gives you access to polar charts of voltage and current fundamental vectors and a numerical listing of that data (which includes sequence data if showing a VPA which is configured for 3 $\phi$ 4w WIRING).

The VECTORS Screen can be selected for view from any of the Main Data Screens by pressing the VECTORS button.

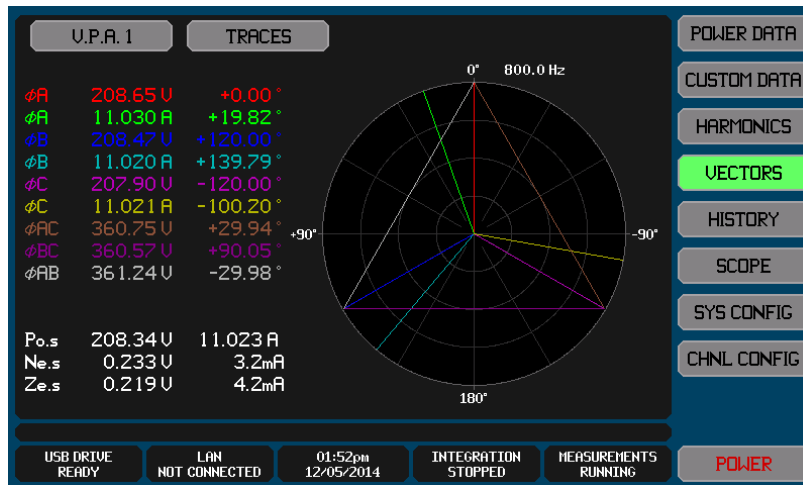

The displayed vectors and the corresponding numerical data are controlled by the 2 buttons across the top of the screen (in order from left to right) –

1. Selection of the channel or VPA for which to display the vectors.
2. Selection of the vector traces to show. The available selections are dependent on whether a channel or a VPA is selected and if a VPA is selected then also the WIRING configuration of that VPA. For each available trace-

A trace is enabled if the SHOW button is highlighted colored green. Pressing the SHOW button toggles whether the trace is selected or not.

Pressing the COLOR button changes the color of that trace to the next available color, the name of the trace being changed shows which color will be used for that trace and the numerical data for it.

Note:

If no fundamental harmonic data is available for the selected channel or VPA then the vector chart is blank, there are no numerical results on the left side, and NO FUNDAMENTAL is displayed centered in the chart.

If no traces have been enabled to be shown then the vector chart is blank, there are no numerical results on the left side, and NO TRACES SELECTED is displayed centered in the chart.

If the frequency is shown colored orange then the harmonics are not locked closely enough to allow accurate phase measurements.

The length of all voltage vectors are scaled such the longest vector just touches the outer boundary of the chart and the other voltage vectors are scaled relative to this.

The length of all current vectors are scaled such the longest vector just touches the outer boundary of the chart and the other current vectors are scaled relative to this.

For other than 3 $\phi$ 3w(2ch) WIRING, 0° is the phase of the voltage in the lowest numbered channel in the VPA (if a VPA is selected) or the voltage signal of the selected channel (if a channel is selected).

In the numerical listing on the left side, the angles shown are the angles of each corresponding vector as shown on the chart.

For the sequence data (if any) to have the normal significance, the wiring phasing must be phase A to the lowest numbered channel in the VPA, phase B to the middle, and phase C to the highest. If the wiring is not as described then the three sequence data will have different meanings to those shown.

## 12.8.1 RECORDING VECTORS

The method for performing this is fully described in section 23.

You can make a record of the VECTORS screen by saving an image of it to a graphic file on an external USB drive attached to the front panel USB port.

Briefly, this is performed by –

1. Insert the drive into the front panel USB port and wait for it to be READY.
2. Display the screen to be recorded.
3. Press the DRIVE INFO area of the screen, the screen shows the file export/import screen.
4. Press the SCREEN IMAGE button. The screen changes to allowing you to enter a file name.
5. Enter the desired file name (the extension is automatically provided).
6. If the file already exists then you are prompted to respond if you wish to overwrite it or not.
7. The file is then written.

## 12.9 GRAPHICALLY VIEWING PAST MEASUREMENTS – THE HISTORY SCREEN

The HISTORY Screen gives you access to charts of up to four measured results vs elapsed time. All available data are always recorded without you having to make configuration settings. The only configuration needed is that needed to select the data to display and to format the display of those selected data, this has no effect on the recorded data. You may select to display the same data on more than one trace, each with different scaling and offset as desired.

The HISTORY Screen can be selected for view from any of the Main Data Screens by pressing the HISTORY button.



Each trace is drawn showing the average and the extents of the data within each pixel. The average is drawn with full brightness, while the extents are shown using a lower brightness between the lowest and highest extents. The minimum and maximum measurements from every individual measurement period is maintained, and for individual sample based data such as peak this gives you continuous coverage of down to 1 $\mu$ s resolution data for millions of years without data loss.

To the left of the chart there is textual information indicating the data selection, color, scaling and offset settings for each enabled trace in a brief format.

Unless you have zoomed or stopped the chart, the right end of the chart is 'now' and the left end is when the chart was started.

Note:

If no traces are enabled to be shown on the chart then NO TRACES SELECTED is shown in the chart.

You do not have to be viewing the HISTORY screen for data to be collected.

You do not have to start RUNNING unless you specifically stopped it.

Since all available historical data are always saved while RUNNING, you are free to change traces at will without needing to retake data, you can also reconfigure measurements at any time.

Traces are drawn in numerical order, trace 1 first, and then trace 2, and so on. So the highest numbered enabled trace is the uppermost trace if traces overlap.

### 12.9.1 SELECTING AND CONFIGURING THE TRACES TO SHOW

The HISTORY screen traces are selected and configured by using the TRACES button at the top of the screen. The example below shows the screen which is used to configure the traces to be shown.

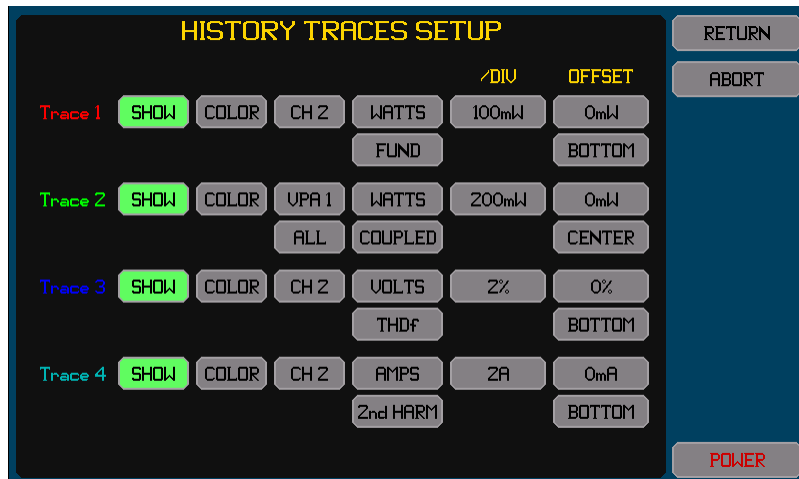

Pressing the SHOW button toggles the trace on/off. The button is highlighted colored green when enabled.

Change the color by repeatedly pressing the COLOR button until the adjacent trace number shows the desired color.

There are two, three or four buttons to the right of the COLOR button which allow you to set the desired measurement data to trace. The measurement data selected is the combination of these settings.

The button in the /DIV column allows you to set the scaling in the units of the selected measurement data. Note that this is entered per division and there are a total of six vertical divisions in the chart. This can also be set to the best 1/2/5 values to show all traces within the extents of the chart when the AUTOSCALE button is pressed on the HISTORY screen.

The buttons in the OFFSET column allows you to set the measurement data value and the place on the chart to position that value.

For example if a voltage trace was set for a 0.5A offset value and the offset set to CENTER, then the resulting trace will be in the center of the chart vertically when it has the 0.5A value, if higher than 0.5A then it will be higher (by an amount set by the scaling required) and will be lower if below 0.5A.

Usually if you are plotting data that can be positive or negative and it is wished to set the chart to cover the entire range of possible values, then you should set an offset of 0 at the CENTER, and set the scaling to ensure the trace stays within the 3 divisions on either side of the center.

Usually if you are plotting data which is always positive (such as THD or CF for example) and it is wished to set the chart to cover the entire range of possible values, then you should set an offset of 0 at the BOTTOM, and set the scaling to ensure the trace stays within the 6 divisions of the chart.

Usually if you wish to plot the deviation of data from some nominal expected value then you should set that expected nominal value as the offset and set for the offset CENTER location, and set the scaling as desired to make any deviations easily visible.

### 12.9.2 CHANGING THE WAY IN WHICH TIME IS DISPLAYED ON THE CHART

The TIME button (second from the left across the top of the screen) allows you to select how times are shown on this screen.

If TIME<- is selected then time is shown below the horizontal axis of the chart with 0 at the right (corresponding to 'now') and the time at which the chart was last started at the left with a negative time shown which indicates the time before now.

If TIME-> is selected then time is shown below the horizontal axis of the chart with 0 at the left (corresponding to when the chart was last started) and 'now' at the right with a positive time shown which indicates the time since the chart was last started.

If TIME is selected then the actual time of day is shown.

If TIME/DATE is selected then the actual time of day and date are shown.

Note:

The internal clock used to determine all history times relative to when it was started is not the same clock as used to determine the displayed time of day and date. There can be up to a few seconds per day difference between these.

### 12.9.3 STARTING, STOPPING, AND RESTARTING THE CHART

Normally the chart is always collecting measurement results. You may stop result collection by pressing the RUNNING button, and then may start the chart from the beginning by pressing it again (now labelled STOPPED). When starting, all previous historical data is erased from memory. This button is highlighted colored green while the chart is running.

### 12.9.4 PROHIBITING DATA COLLECTION TEMPORARILY

While running a chart you can temporarily disable data collection by holding measurements, see section 12.2.6. While measurements are held, the historical record still runs, but the traces are blanked during this time.

### 12.9.5 USING THE CURSOR AND ZOOMING THE CHART

A vertically drawn cursor may be placed on to the chart by you. There are two ways of achieving this –

Press the CURSOR button at the top of the screen, this places a cursor at the last used position of the cursor, or at the left end of the screen if the cursor has not been used before.

Or, press anywhere on the chart, this places a cursor at the horizontal position pressed. You may drag the cursor in this manner and if dragged off the left or right edges of the chart then it will also scroll the displayed timespan, or you may simply reposition the cursor by pressing somewhere else on the chart.

The screen below shows an example of a HISTORY data screen with the cursor shown and zoomed in.

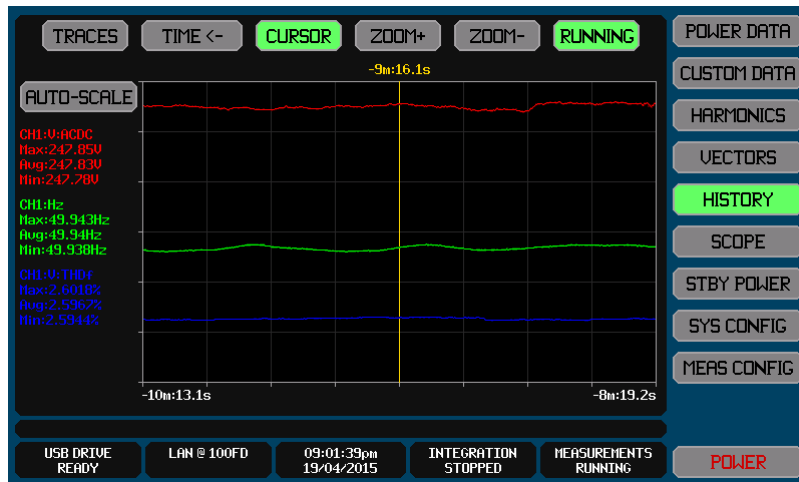

When the cursor is shown –

The CURSOR button is highlighted colored green

The time position of the cursor is shown above the cursor line

The cursor remains at the same position in time relative to the start of the data collection.

The textual data in the left side of the screen changes to show the maximum, average and minimum data recorded for each trace in the time increment corresponding to the width of one pixel at the present cursor position.

You may zoom the chart horizontally by pressing the ZOOM+ button (next to the CURSOR button). While zoomed –

You may zoom in further by pressing the ZOOM+ again, or may zoom back by pressing the ZOOM- button.

The cursor remains set to the same time as it was prior to zooming, but it may still be moved within the timespan of the zoomed chart by pressing at the desired location within the chart.

The cursor may be moved beyond the left and right ends of the timespan being viewed by dragging it beyond those edges, in that case the cursor remains at the edge and the chart timespan being shown is changed. This enables you to 'drag' the timespan being viewed without having to zoom back out.

Each ZOOM+ press changes the horizontal timing by a nominal factor of 2:1 and a maximum of 10 zoom levels are allowed (i.e. the maximum zoom is 1000:1).

When the chart is zoomed by the maximum factor the span of the zoom changes to reflect that it is constrained to be a minimum of 1/1000<sup>th</sup> of the overall history timespan however the cursor position remains the same.

Any zoom can be cancelled and the screen returned to the non-zoomed state without a cursor at any time by pressing the CURSOR button while it is highlighted.

### 12.9.6 RESCALING THE CHART TRACES

You can press the AUTOSCALE button to rescale all traces to the most optimum 1/2/5 scales (per division) to maintain all traces just within the vertical extents of the chart. This action changes the scaling for each enabled trace entered in the TRACES configuration but does not alter the offset settings.

### 12.9.7 EXPORTING OR RECORDING HISTORY

The method for performing this is fully described in section 23.

Historically saved measurements can be exported to a .CSV format textual file on an external USB drive attached to the front panel USB port. This file contains all captured measurements as configured for the traces on the HISTORY screen (without regard to the



scaling or offset configuration). The tabulated data covers 8192 equally spaced time increments from the start of the history capture to the end of it and contains the maximum, average and minimum of all measurements during each time increment.

Briefly, this is performed by –

7. Insert the drive into the front panel USB port and wait for it to be READY.
8. Press the DRIVE INFO area of the screen, the screen shows the file export/import screen.
9. Press the HISTORY button. The screen changes to allowing you to enter a file name.
10. Enter the desired file name (the extension is automatically provided).
11. If the file already exists then you are prompted to respond if you wish to overwrite it or not.
12. The file is then written.

Alternatively, you can make a record of the HISTORY screen by saving an image of it to a graphic file on an external USB drive attached to the front panel USB port.

Briefly, this is performed by –

1. Insert the drive into the front panel USB port and wait for it to be READY.
2. Display the screen to be recorded.
3. Press the DRIVE INFO area of the screen, the screen shows the file export/import screen.
4. Press the SCREEN IMAGE button. The screen changes to allowing you to enter a file name.
5. Enter the desired file name (the extension is automatically provided).
6. If the file already exists then you are prompted to respond if you wish to overwrite it or not.
7. The file is then written.

---

### 12.9.8 HISTORICAL DATA AVAILABILITY

Not all measured data are available, the available data are shown in the list provided below which has been shortened by the use of the following–

CHn	Any of CH1, CH2, CH3 or CH4
An	Any of VPA1, VPA2 or VPA3
pX	Any of øA, øB, øC or øD
Hn	Any of H1 ... 3



FREQ:CHn	AMPS:An:pX:CF	VA:An:pX
FREQ:An	AMPS:An:pX:PK	VA:An:pX:H1
VOLTS:CHn:DC	AMPS:An:pX:HIPK	VA:An:∅AC:DC
VOLTS:CHn:AC	AMPS:An:pX:LOPK	VA:An:∅AC:AC
VOLTS:CHn:ACDC	AMPS:An:pX:Hn	VA:An:∅AC:ACDC
VOLTS:CHn	AMPS:An:pX:P1	VA:An:∅AC
VOLTS:CHn:CF	AMPS:An:pX:THDf	VA:An:∅AC:H1
VOLTS:CHn:PK	AMPS:An:pX:THDsig	VA:An:∅BC:DC
VOLTS:CHn:HIPK	AMPS:An:N:DC	VA:An:∅BC:AC
VOLTS:CHn:LOPK	AMPS:An:N:AC	VA:An:∅BC:ACDC
VOLTS:CHn:Hn	AMPS:An:N:ACDC	VA:An:∅BC
VOLTS:CHn:P1	AMPS:An:N	VA:An:∅BC:H1
VOLTS:CHn:THDf	AMPS:An:N:CF	VA:An:DC
VOLTS:CHn:THDsig	AMPS:An:N:PK	VA:An:AC
VOLTS:CHn:VALLEY	AMPS:An:N:H1	VA:An:ACDC
VOLTS:CHn:PK-VLY	AMPS:An	VA:An
VOLTS:An:pX:DC	AMPS:An:PK	VA:An:H1
VOLTS:An:pX:AC	AMPS:An:H1	PF:CHn:AC
VOLTS:An:pX:ACDC	WATTS:CHn:DC	PF:CHn:ACDC
VOLTS:An:pX	WATTS:CHn:AC	PF:CHn
VOLTS:An:pX:CF	WATTS:CHn:ACDC	PF:CHn:H1
VOLTS:An:pX:PK	WATTS:CHn	PF:An:pX:AC
VOLTS:An:pX:HIPK	WATTS:CHn:H1	PF:An:pX:ACDC
VOLTS:An:pX:LOPK	WATTS:An:pX:DC	PF:An:pX
VOLTS:An:pX:Hn	WATTS:An:pX:AC	PF:An:pX:H1
VOLTS:An:pX:P1	WATTS:An:pX:ACDC	PF:An:∅AC:AC
VOLTS:An:pX:THDf	WATTS:An:pX	PF:An:∅AC:ACDC
VOLTS:An:pX:THDsig	WATTS:An:pX:H1	PF:An:∅AC
VOLTS:An:∅AC:AC	WATTS:An:∅AC:DC	PF:An:∅AC:H1
VOLTS:An:∅AC:ACDC	WATTS:An:∅AC:AC	PF:An:∅BC:AC
VOLTS:An:∅AC	WATTS:An:∅AC:ACDC	PF:An:∅BC:ACDC
VOLTS:An:∅AC:CF	WATTS:An:∅AC	PF:An:∅BC
VOLTS:An:∅AC:PK	WATTS:An:∅AC:H1	PF:An:∅BC:H1
VOLTS:An:∅AC:HIPK	WATTS:An:∅BC:DC	PF:An:AC
VOLTS:An:∅AC:LOPK	WATTS:An:∅BC:AC	PF:An:ACDC
VOLTS:An:∅AC:Hn	WATTS:An:∅BC:ACDC	PF:An
VOLTS:An:∅AC:P1	WATTS:An:∅BC	PF:An:H1
VOLTS:An:∅AC:THDf	WATTS:An:∅BC:H1	LOADZ:CHn:DC
VOLTS:An:∅AC:THDsig	WATTS:An:DC	LOADZ:CHn:AC
VOLTS:An:∅BC:AC	WATTS:An:AC	LOADZ:CHn:ACDC
VOLTS:An:∅BC:ACDC	WATTS:An:ACDC	LOADZ:CHn
VOLTS:An:∅BC	WATTS:An	LOADZ:CHn:H1
VOLTS:An:∅BC:CF	WATTS:An:H1	MOTOR:WATTS
VOLTS:An:∅BC:PK	WATTS:IN	MOTOR:SPEED
VOLTS:An:∅BC:HIPK	WATTS:MIDDLE	MOTOR:TORQUE
VOLTS:An:∅BC:LOPK	WATTS:OUT	MOTOR:SLIP
VOLTS:An:∅BC:Hn	LOSS:IN-MID	
VOLTS:An:∅BC:P1	LOSS:IN-OUT	
VOLTS:An:∅BC:THDf	LOSS:MID-OUT	
VOLTS:An:∅BC:THDsig	EFFICIENCY:IN-MID	
VOLTS:An:∅AB:AC	EFFICIENCY:IN-OUT	
VOLTS:An:∅AB:ACDC	EFFICIENCY:MID-OUT	
VOLTS:An:∅AB	VAR:CHn:AC	
VOLTS:An:∅AB:CF	VAR:CHn:ACDC	
VOLTS:An:∅AB:PK	VAR:CHn	
VOLTS:An:∅AB:Hn	VAR:CHn:H1	
VOLTS:An:∅AB:P1	VAR:An:pX:AC	
VOLTS:An:∅AB:THDf	VAR:An:pX:ACDC	
VOLTS:An:∅AB:THDsig	VAR:An:pX	
VOLTS:An	VAR:An:pX:H1	
VOLTS:An:PK	VAR:An:∅AC:AC	
VOLTS:An:H1	VAR:An:∅AC:ACDC	
AMPS:CHn:DC	VAR:An:∅AC	
AMPS:CHn:AC	VAR:An:∅AC:H1	
AMPS:CHn:ACDC	VAR:An:∅BC:AC	
AMPS:CHn	VAR:An:∅BC:ACDC	
AMPS:CHn:CF	VAR:An:∅BC	
AMPS:CHn:PK	VAR:An:∅BC:H1	
AMPS:CHn:HIPK	VAR:An:AC	
AMPS:CHn:LOPK	VAR:An:ACDC	
AMPS:CHn:Hn	VAR:An	
AMPS:CHn:P1	VAR:An:H1	
AMPS:CHn:THDf	VA:CHn:DC	
AMPS:CHn:THDsig	VA:CHn:AC	
AMPS:CHn:VALLEY	VA:CHn:ACDC	
AMPS:CHn:PK-VLY	VA:CHn	
AMPS:An:pX:DC	VA:CHn:H1	
AMPS:An:pX:AC	VA:An:pX:DC	
AMPS:An:pX:ACDC	VA:An:pX:AC	
AMPS:An:pX	VA:An:pX:ACDC	

## 12.10 USING THE PA900 AS AN OSCILLOSCOPE – THE SCOPE SCREENS

The SCOPE Screen can be selected for view from any of the Main Data Screens by pressing the SCOPE button. There are actually two totally independent SCOPE screens providing the ability to use the PA900 as an oscilloscope–

### CYCLE VIEW –

- Always shows a single fundamental cycle of the waveforms.
- Requires no specific configuration.
- Time resolution of the greater of 2.6ns or 1/512<sup>th</sup> of a cycle.
- You can view the volts, amps and/or watts signals for any channel and/or inter-phase voltage signals.
- You can view the same signal in multiple traces, each with different vertical scaling and offsets.
- You can auto-scale the traces to ensure they fit on the chart.
- Allows up to 6 traces to be simultaneously viewed.
- Perfect for the inspection of periodic waveforms with extreme amplitude and time detail available.

### SCOPE VIEW –

- A multi-channel digital oscilloscope with many enhancements.
- Up to 12 channels (volts, amps and/or watts signals in each channel) and/or inter-phase voltage signals, up to six viewable at a time.
- You can change traces and/or trace scaling without having to retrigger.
- All data captured with full 22/24 bit resolution so you can change traces and/or trace scaling without having to retrigger.
- You can auto-scale the traces to ensure they fit on the chart.
- You can show the same signal in multiple traces, each with different vertical scaling and offsets.
- User configurable trigger and timebase.
- Cursor with timebase zoom capability.
- Can automatically remove any configured HF filtering and select the HI current range during the scope capture and then replace the original settings after completion of the capture, perfect for current inrush measurements.
- Continuous or single trigger.
- Perfect for capturing non-periodic waveforms and transients (such as inrush current for example).

Which screen is viewed is selected by the upper left button of the SCOPE screen. The presently selected screen view name is displayed in the button, which toggles every time it is pressed.

Note:

You do not have to be viewing a SCOPE screen for signals to be captured.

### 12.10.1 VIEWING PERIODIC WAVEFORMS – THE CYCLE VIEW SCREEN

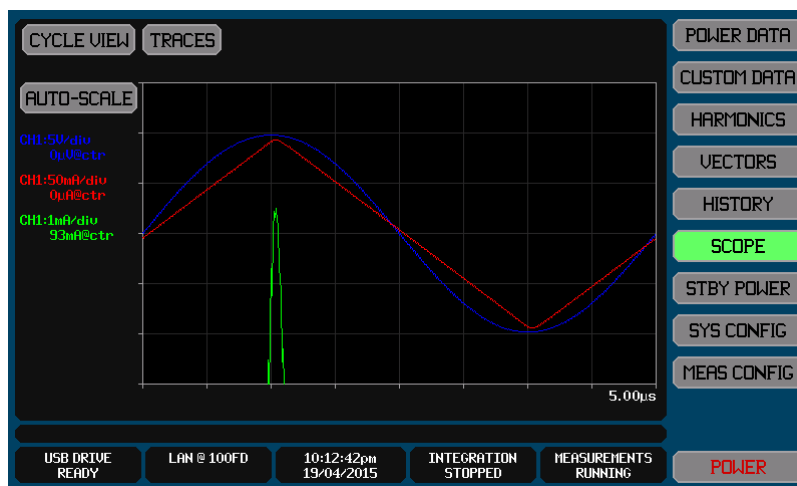

The above example shows a 200kHz sinewave voltage (in blue) and an almost in-phase triangle wave current (in red) and includes a third trace (in green) which is also of the current waveform, but scaled and offset for close inspection of the peak of the triangle wave. Note that this chart provides <10ns time resolution (there are 512 pixels across the chart) and also note how the use of vertical scaling and offset can be used to show very fine amplitude details. This is an actual screen image obtained from a PA900 measuring actual signals, it has not been altered except to scale it to fit on this page. This was obtained using a W type channel card which nominally samples at just under 1MSPS so this image shows the impact of the advanced sampling method provided by the PA900 and also demonstrates how inaccurate it is to state that the sampling rate affects the bandwidth.

If no fundamental harmonic is available then the chart is blank and NO FUNDAMENTAL is displayed in the chart. Cycle view places every sample in a measurement period at the correct phase in the displayed chart to build a single cycle formed from all cycles present during the measurement period. To do this it needs the results of the harmonic analysis to position the samples correctly

and it needs to know the fundamental frequency. Since the PA900 always ensures that every cycle of the signals are sampled at different phases within them, a complete high resolution image of a single cycle is obtained using the actual samples of the actual signals.

If no traces are enabled to be shown on the chart then NO TRACES SELECTED is displayed on the chart and the chart is blank.

If the period is shown colored orange then the PA900 is not locked closely enough to allow an accurate representation of the signals. You can press the AUTOSCALE button to rescale all traces to the most optimum 1/2/5 scales (per division) to maintain all traces just within the vertical extents of the chart. This action changes the scaling for each enabled trace entered in the TRACES configuration.

### 12.10.1.1 CONFIGURING TRACES

The only configuration needed is to select the traces and to set the trace color, scaling and offset for each. This is performed by pressing the TRACES button. An example of the screen which allows configuration of the traces is shown below.

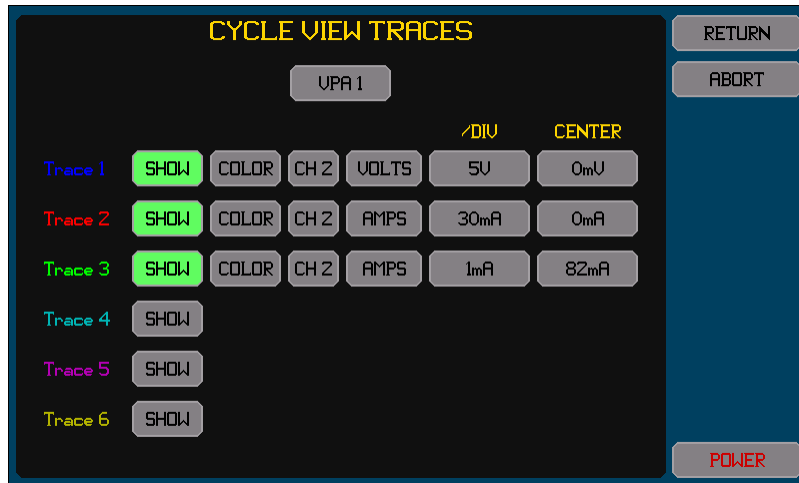

All traces must be from the same VPA, so the required VPA must be selected prior to selecting any traces.

For each trace–

Pressing the SHOW button toggles the trace on/off. The button is highlighted colored green when enabled.

Change the color by pressing the COLOR button until the adjacent trace number shows the desired color.

There are two buttons to the right of the COLOR button which allows you to select the channel and signal to trace. Either the voltage or current or watts signals or the inter-phase voltage signals may be traced. The watts signal is the result of multiplying the voltage and current signals.

The button in the /DIV column allows you to set the scaling in the units of the selected signal. Note that this is entered per division and there are a total of 6 vertical divisions in the chart (3 above and 3 below the centerline). This can also be set to the best 1/2/5 values to show all traces within the extents of the chart when the AUTOSCALE button is pressed on the CYCLE VIEW screen.

The button in the OFFSET column allows you to set the signal level which will correspond to the centerline of the chart.

Note:

Traces are drawn in numerical order, trace 1 first, and then trace 2, and so on. So the highest numbered enabled trace is the uppermost trace if traces overlap.

If a VPA is configured to a LF/PERIOD setting of another VPA then selecting either VPA will allow the signals in either VPA to be selected.

### 12.10.1.2 EXPORTING OR RECORDING CYCLE VIEW DATA

The methods for performing this are fully described in section 23.

The CYCLE VIEW data can be exported to a .CSV format textual file on an external USB drive attached to the front panel USB port. This file contains a tabulation of the points in each CYCLE VIEW waveform for all channels in a selected VPA.

Briefly, this is performed by –

1. Insert the drive into the front panel USB port and wait for it to be READY.
2. Press the DRIVE INFO area of the screen, the screen shows the file export/import screen.
3. Press the CYCLE DATA button. The screen changes to allowing you to enter a file name.
4. Enter the desired file name (the extension is automatically provided).
5. If the file already exists then you are prompted to respond if you wish to overwrite it or not.
6. If configured for more than a single VPA then you are prompted to select the VPA for which to export the cycle view data.
7. The file is then written.

Alternatively you can make a record of the CYCLE VIEW screen by saving an image of it to a graphic file on an external USB drive attached to the front panel USB port.

Briefly, this is performed by –

1. Insert the drive into the front panel USB port and wait for it to be READY.
2. Display the screen to be recorded.

3. Press the DRIVE INFO area of the screen, the screen shows the file export/import screen.
4. Press the SCREEN IMAGE button. The screen changes to allowing you to enter a file name.
5. Enter the desired file name (the extension is automatically provided).
6. If the file already exists then you are prompted to respond to whether you wish to overwrite it or not.
7. The file is then written.

### 12.10.2 AN OSCILLOSCOPE – THE SCOPE VIEW SCREEN

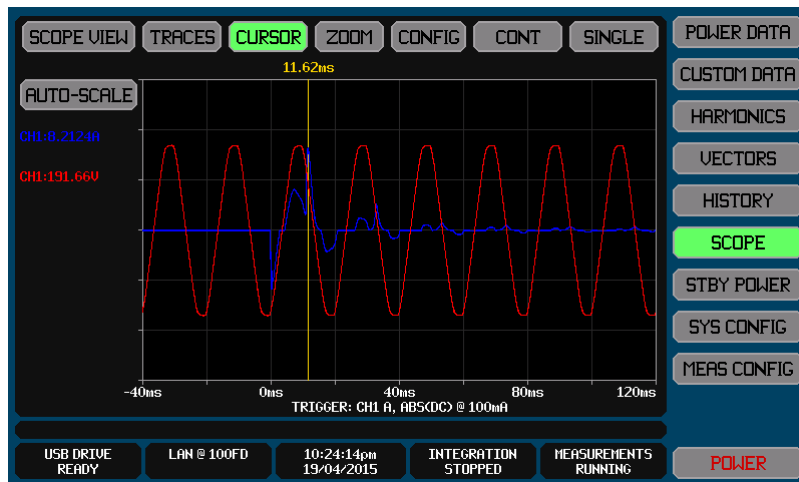

The above example shows the voltage (in blue) and current (in red) waveforms of an inrush current with the cursor positioned at the maximal current.

#### 12.10.2.1 CONFIGURING THE TRIGGER AND TIMEBASE

The CONFIG button allows you to configure the trigger and timebase. While in remote you can only view the trigger and timebase settings but cannot change them. When changes are made any previously captured traces are cleared.

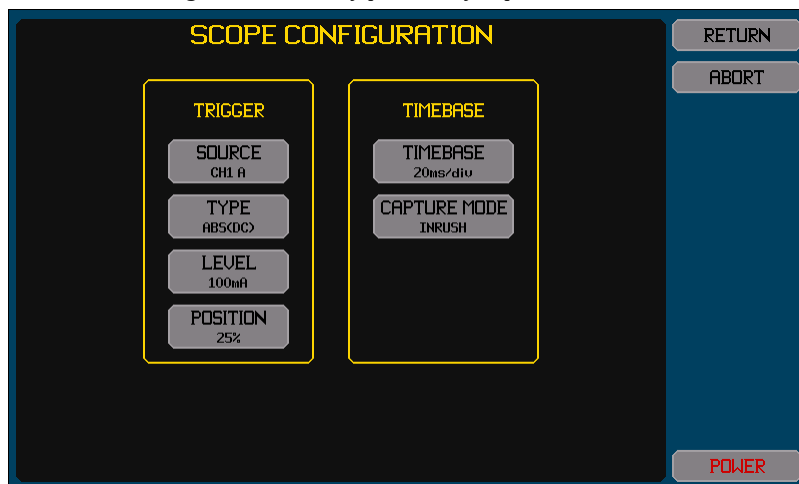

Pressing the SOURCE button allows you to select the trigger source from the available signals.

Note that the scope always captures all signals in the channels which are configured in the same VPA as that of the trigger source. If a VPA is configured with its LF/PERIOD setting selecting as another VPA and the trigger source channel is in either of these VPAs, then channels may be in either of these two VPAs.

Pressing the TYPE button allows you to select the trigger detection type.

If you select DC (rising edge) the scope is triggered when the selected signal changes from below the trigger level to above the trigger level. Automatic HF filtering is provided to reduce the possibility of small glitches causing a trigger.

If you select DC (falling edge) the scope is triggered when the selected signal changes from above the trigger level to below the trigger level. Automatic HF filtering is provided to reduce the possibility of small glitches causing a trigger.

If you select ABS(DC) the scope is triggered when the selected signal is above the trigger level or below the negative of the trigger level. This setting is particularly useful when triggering on inrush currents or voltage transients because you do not know which polarity the transient will be. Automatic HF filtering is provided to reduce the possibility of small glitches causing a trigger. Note that setting this trigger type and a trigger level of zero (or close to zero) will cause the scope capture to always trigger as the signal is always either above or below zero.

If you select HF the scope is triggered when the result of HP filtering the selected signal is above the trigger level or below the negative of the trigger level. This setting is useful when it is required to trigger on fast glitches. The HP filter employed corresponds to a time of nominally 10% of the timebase setting. Note that setting this trigger type and a trigger level of zero (or close to zero) will cause the scope capture to always trigger as the signal always has greater than zero HF content.

Recommendations:

For viewing repetitive signals. Either the DC (rising edge) or DC (falling edge) selections should be made.

For viewing a current inrush or startup event. The ABS(DC) selection should be made.

For viewing fast transients. The HF selection should be made.

Pressing the LEVEL button allows you to select the trigger detection level in the units of the signal.

For the ABS(DC) or HF trigger types only positive values can be used and you should not enter a trigger level of zero, as the signal will always trigger.

Pressing the POSITION button allows you to set where the trigger position is located on the unzoomed chart.

You may select 0%, 25%, 50% or 75%.

Pressing the TIMEBASE button allows you to select the timebase in units of time per division similarly to an oscilloscope.

Timebase settings between 5us and 20s per division are available.

Pressing the CAPTURE MODE button allows you to choose whether the scope capture will be performed normally (NORMAL setting) or optimized for inrush capture (INRUSH setting). When configured for the INRUSH setting the following changes are made -

While a capture is being performed all D current option channels which are unscaled have the HI current range forced. After capture of the scope trace this is released back to the configured current range.

While a capture is being performed any BANDWIDTH setting in the MEAS CONFIG screen is ignored and the captured signal will not be bandwidth limited by that setting. After capture of the scope trace this is released back to the configured setting.

After a capture is obtained the cursor is automatically turned on and positioned at the maximum signal of trace 1. This enables direct readout of the maximum inrush current (for example).

Recommendation:

The INRUSH capture mode is recommended for performing inrush current measurements. This enables the use of the optimal MEAS CONFIG settings for normal power measurements while still allowing accurate measurement of inrush currents. Although this can be used with continuous triggering, this is primarily intended for use with single triggered captures. The example configuration shown above shows a typical configuration for inrush current capture, with trace 1 configured as showing the current signal. See also section 14 for full details regarding inrush measurement and capture.

### 12.10.2.2 CONFIGURING TRACES

This is performed by pressing the TRACES button. An example of the screen which allows configuration of the traces is shown below. Changing traces does not clear any previously made scope capture; it only affects how it is displayed.

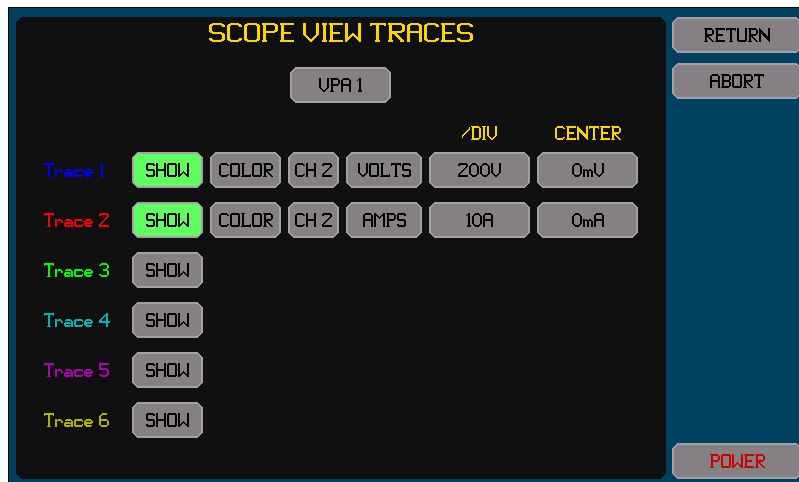

All traces must be in channels configured in the same VPA as that in which the trigger source channel is configured. If a VPA is configured to a LF/PERIOD setting of another VPA then selecting either VPA will allow the signals in either VPA to be selected.

For each trace-

Pressing the SHOW button toggles the trace on/off. The button is highlighted colored green when enabled.

Change the color by pressing the COLOR button until the adjacent trace number shows the desired color.

There are two buttons to the right of the COLOR button which allows you to select the channel and signal to trace. Either the voltage or current or watts signals or the inter-phase voltage signals may be traced. The watts signal is the result of multiplying the voltage and current signals.

The button in the /DIV column allows you to set the scaling in the units of the selected signal. Note that this is entered per division and there are a total of 6 vertical divisions in the chart (3 above and 3 below the centerline). This can also be automatically set to the best 1/2/5 values to show all traces within the extents of the chart when the AUTOSCALE button is pressed on the CYCLE VIEW screen.

The button in the OFFSET column allows you to set the signal level which will correspond to the centerline of the chart.

Traces are drawn in numerical order, trace 1 first, and then trace 2, and so on. So the highest numbered enabled trace is the uppermost trace if traces overlap.

### 12.10.2.3 RUNNING A SCOPE CAPTURE

The oscilloscope may be run in either SINGLE or CONT modes similarly to a normal oscilloscope.

Pressing the CONT button starts continuous oscilloscope captures.

While capturing in CONT mode the button is colored green and is labelled RUNNING. Shortly after triggering and capturing all signals, the scope will wait for another trigger event. While capturing in CONT mode you may press the CONT button to stop capturing signals, or may press the button to its right to make a SINGLE mode capture instead.

Pressing the SINGLE button starts a single oscilloscope capture.

While capturing in SINGLE mode the button is colored green. After triggering and capturing all signals, the scope will stop. While capturing in SINGLE mode you may press the SINGLE button to abort the capture, or may press the CONT button to initiate CONT mode instead.

While capturing, the SINGLE button is labelled with the status of the scope signal capture-

PRETRIG. Indicates that the scope is collecting sufficient signal to accommodate the configured trigger position.

WAITING. Indicates that the scope is waiting for a trigger event.

TRIG'D. Indicates that the scope is collecting the signals after a trigger event has been detected but there is not enough signal captured to fill the screen yet.

Recommendations:

The BANDWIDTH setting for the VPA also bandwidth limits all signals for the scope. This can limit your ability to use the HF trigger type if set for a fast timebase. If you intend to use the HF trigger type to detect very fast glitches on a much lower frequency signal then it is recommended to configure the VPA measurements for an BANDWIDTH setting of UNFILTERED. If using the INRUSH capture mode then the BANDWIDTH is ignored during the scope capture. The actual -3dB bandwidth of the captured signals is displayed below the chart.

If the intention is to trigger on an inrush event, then the use of the ABS(DC) trigger type is recommended, using the current signal as the trigger source and setting the trigger level to a suitable current level which you expect the inrush current to exceed. Typically SINGLE captures are used for inrush capture.

If the intention is to trigger on a mains supply surge then the ABS(DC) trigger type is recommended, using the voltage signal as the trigger source and setting the trigger level to a suitable voltage level just above the peak level of the highest expected normal mains voltage. Typically CONT mode is used for mains supply surge capture as this enables the PA900 to detect another surge without user intervention.

If the intention is to trigger on mains supply 'glitches' then the HF trigger type is recommended, using the voltage signal as the trigger source and setting the trigger level to a voltage level just high enough to not trigger on whatever glitches are normally present. Typically CONT mode is used for mains supply glitch capture as this enables the PA900 to detect another glitch without user intervention.

For capturing repetitive signals then the use of the DC(rising) or DC(falling) trigger types is recommended, however you should also consider using CYCLE VIEW as this provides better trace resolution in time and requires no configuration.

Just as for all digital sampling oscilloscopes, setting the timebase to a very long value and attempting to capture a higher frequency signal will cause aliasing in the captured data making the captured signal look like it has a much lower frequency than it actually has. The PA900 has an internal scope capture depth of 32768 samples. You should always set an appropriate timebase considering the frequency of the signal expected.

Note:

Since the scope view capture is intended for the capture of non-repetitive signals it gains no advantage from the advanced sampling system in the PA900 and scope view data has the time resolution of individual samples of the signals. For W channel types this is just over 1µs, otherwise it is just over 4µs.

### 12.10.2.4 VIEWING A SCOPE CAPTURE

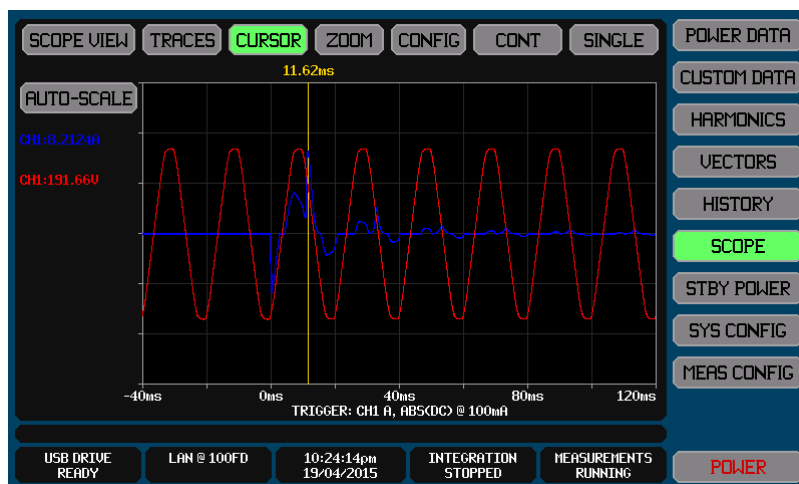

The last taken scope capture is shown with the traces selected and configured as described above. To the left of the chart is a listing of the configured traces. Below the chart is a textual description of the trigger configuration.

Note:

If no signals have been captured then NO DATA CAPTURED is displayed on the chart and the chart is blank.



If no traces are enabled to be shown on the chart then NO TRACES SELECTED is displayed on the chart and the chart is blank.

You may change the trace selections as required without having to capture further data. All signals within the VPA are always captured with full resolution, allowing the trace colors, the trace signals, or the trace scaling and offset to be altered at will after the capture.

The scaling for the traces may be altered to ensure the best fit on the chart by pressing the AUTOSCALE button on the SCOPE VIEW screen. When pressed, the PA900 changes the configured scaling to the optimum 1/2/5 scaling to just maintain each trace within the extents of the chart.

#### 12.10.2.4.1 Using the Cursor and Zooming the View

A vertically drawn cursor may be placed on to the chart by you. There are three ways of achieving this –

Pressing the CURSOR button at the top of the screen, this action places a cursor at the last used position of the cursor or at the trigger position if the cursor has not been used before.

Or, pressing anywhere on the chart, this action places a cursor at the position pressed. You may drag the cursor in this manner, or may reposition the cursor by pressing somewhere else on the chart.

Or, using the INRUSH capture mode. This automatically places a cursor at the maximum signal of trace 1.

The screen below shows the capture of an inrush current zoomed in on the initial inrush peak.



When the cursor is shown –

The CURSOR button is highlighted colored green

The time position of the cursor is shown above the cursor line

The textual data in the left side of the screen changes to show the signal level captured for each trace at the time of the present cursor position.

You may zoom the chart horizontally by pressing the ZOOM button; when pressed you are prompted to select the zoom timebase. While zoomed –

When the ZOOM button is pressed the cursor position is centered in the screen.

The ZOOM button is highlighted colored green.

The cursor remains set to the same time as it was prior to zooming, but it may still be moved within the timespan of the zoomed chart by pressing at the desired location within the chart.

The cursor may be moved beyond the left and right ends of the timespan being viewed by dragging it beyond those edges, in that case the cursor remains at the edge and the chart timespan being shown is changed. This enables you to 'drag' the timespan being viewed without having to zoom back out.

Any zoom can be cancelled and the screen returned to the non-zoomed state without a cursor at any time by pressing the CURSOR button while it is highlighted.

#### 12.10.2.5 EXPORTING OR RECORDING SCOPE VIEW DATA

The methods for performing this are fully described in section 23.

The SCOPE VIEW data can be exported to a .CSV format textual file on an external USB drive attached to the front panel USB port. This file contains a tabulation of the points in each SCOPE VIEW waveform for all channels.

Briefly, this is performed by –

1. Insert the drive into the front panel USB port and wait for it to be READY.
2. Press the DRIVE INFO area of the screen, the screen shows the file export/import screen.
3. Press the SCOPE DATA button. The screen changes to allowing you to enter a file name.
4. Enter the desired file name (the extension is automatically provided).
5. If the file already exists then you are prompted to respond if you wish to overwrite it or not.
6. The file is then written.

Alternatively you can make a record of the SCOPE VIEW screen by saving an image of it to a graphic file on an external USB drive attached to the front panel USB port. Note that the trigger configuration and any bandwidth limitation are included on the screen, enabling these to be included in the recorded image.

Briefly, this is performed by –

1. Insert the drive into the front panel USB port and wait for it to be READY.
2. Display the screen to be recorded.
3. Press the DRIVE INFO area of the screen, the screen shows the file export/import screen.
4. Press the SCREEN IMAGE button. The screen changes to allowing you to enter a file name.
5. Enter the desired file name (the extension is automatically provided).
6. If the file already exists then you are prompted to respond if you wish to overwrite it or not.
7. The file is then written.

## 12.11 PERFORMING EN50564 LOW POWER MEASUREMENTS – THE STBY POWER SCREEN

The STBY POWER Screen gives you the ability to configure, start/stop, and view the results of low power measurements in accordance with EN50564:2011. The use of this screen is detailed in section 17.

## 12.12 PERFORMING EN61000-3-2 OR -12 ASSESSMENTS – THE ASSESS EUT SCREEN

The ASSESS EUT Screen gives you the ability to configure and perform EUT assessments compliant with EN61000-3-2 or -12. The use of this screen is detailed in section 18.

## 12.13 PERFORMING AND VIEWING A SPECTRUM ANALYSIS – THE SPECTRUM SCREEN

Normally the PA900 is used for general power analysis and harmonic analysis purposes, but in some situations it may be desirable to perform spectrum analysis on the signals instead of harmonic analysis.

This is only available if the PA900 is configured for spectrum analysis by the MEAS MODE setting on the MEAS CONFIG screen.

An example of this is for measuring distortion in accordance with some avionics specifications which require a spectral analysis to be performed with 20Hz resolution for frequencies up to 150kHz (note that this maximum frequency requires W channel types as it is above the 115kHz upper limit for L, S or A channel types). The PA900 can be configured to measure the spectrum of all signals at the same time to this requirement.

Note:

SPECTRUM mode is a single VPA mode; only one VPA can be used in spectrum analysis mode.

You do not have to be viewing the SPECTRUM screen for spectrum data to be measured.

When configured for spectrum analysis, the PA900 still performs normal power analysis (unchanged) and also harmonic analysis (but limited to the fundamental component).

The PA900 is a single measurement DFT based spectrum analyzer not a 'scanning' type spectrum analyzer. There are two phases to a spectrum analysis –

**MEASURING.** During this phase all signals are sampled and these samples are collected. This phase is one period of the user set resolution frequency in length (for example if the frequency resolution is set for 1Hz then this phase takes 1 second).

**PROCESSING.** After collecting the samples during the MEASURING phase the PA900 then processes these samples by DFT analysis to produce the desired spectrum. There is no measurement being performed for spectrum analysis during this phase. Once this phase is completed the results are available for display (or exporting to a file) and a new MEASURING phase is started.

There is only a single MEASURING sample collection phase and only a single PROCESSING phase per spectrum analysis update cycle. The analysis of every spectral point analyzed is performed on the same set of samples in its entirety so there are no discontinuities in the analyzed results.

### 12.13.1 CONFIGURING SPECTRUM ANALYSIS

Spectrum Analysis is configured by you making the following changes to the normal configuration on the MEAS CONFIG screen –

Set the OPERATING MODE to SPECTRUM

Set the desired SPECTRUM frequency resolution and maximum frequency.

All other settings on that screen are as previously described.

### 12.13.2 OPTIMISING CONFIGURATION FOR SPECTRUM MEASUREMENTS

The PA900 performs both the power analysis and spectral analysis at the same time. In most cases you do not need to consider the compromises involved in this, but if you wish to perform spectrum analysis with a frequency resolution less than the inverse of the power analysis measurement period then it should be considered whether to optimize for the spectrum analysis rather than for the power analysis. An example of this would be performing power analysis with a 0.1 second measurement period and spectrum analysis with a 1Hz frequency resolution (so having a 1 second MEASURING period).



This is because when the frequency resolution is set to a low value the MEASURING period for the spectrum analysis spans several power analysis measurement periods, so any changes required due to measurements made in power analysis will interfere slightly with the spectrum analysis being performed. If the MEASURING period is less than that of the power analysis measurement period then these recommendations do not need to be considered typically. There are two points which may need to be considered –

Range changes could occur because of power analysis measurements if using D current option channels and they are configured with A RANGE set for AUTO. If it is possible that a range change could occur while performing low frequency resolution spectrum analysis then it is recommended that the AUTO A RANGE setting is not used.

To ensure that the sampling frequency of the signals is not an exact multiple of the fundamental or any harmonics of the actual signals during power analysis, the actual sampling frequency is slightly modified in ‘real-time’ to prevent this. These slight changes in the sampling frequency slightly broaden the effective bandwidth of the spectrum analysis results. If you wish to have the best performance for spectrum analysis when using a low frequency resolution and also using a high ratio between the resolution and maximum frequencies then it is recommended to use a FIXED FUND setting for power analysis (or a NO FUND setting) which prevents this from occurring.

### 12.13.3 HOLDING MEASUREMENTS WHILE PERFORMING SPECTRUM ANALYSIS

Measurements can be held and released as described in section 12.2.6.

If a measurement hold is imposed during the MEASURING phase of spectrum analysis then the measurement being collected is abandoned and the displayed spectrum remains at that last shown.

If a measurement hold is imposed during the PROCESSING phase of spectrum analysis then the processing continues and the results of this processing will subsequently be displayed when this phase completes, but any further measurements will not be performed until the measurement hold is released.

### 12.13.4 VIEWING SPECTRUM ANALYSIS RESULTS

When operating in SPECTRUM mode, the HARMONICS screen button shown on the right side of most screens is replaced by a SPECTRUM button. Pressing this button enables the results of the spectrum analysis to be viewed on the SPECTRUM screen.

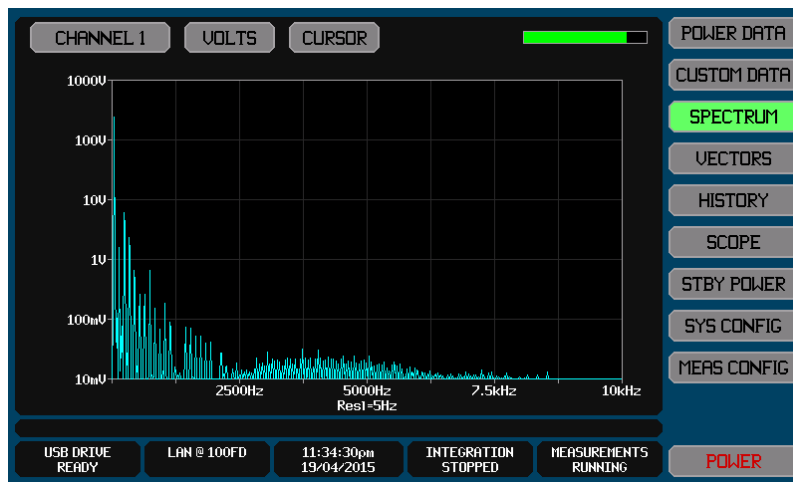

If the spectrum takes more than nominally ½ second to perform either phase of the analysis then a status bar is displayed (as shown on the example screen above) which indicates the percentage completion of the MEASURING phase and the PROCESSING phase as appropriate.

The CHANNEL button allows you to select which channel you are viewing the spectrum of.

The VOLTS/AMPS/WATTS button allows you to select which signal in the selected channel you are viewing the spectrum of.

The CURSOR button allows you to turn on/off a moveable cursor which allows you to obtain a numerical reading of the spectrum content at a specific frequency. If shown, the cursor may be moved one pixel to the left or right by using the <- and -> buttons, or you may drag the cursor on the screen by pressing within the chart area.

Note:

The settings on this screen only affect which spectrum is displayed; all spectra are obtained independently of the settings on this screen.

When a cursor is shown, the PA900 automatically detects the highest signal content within the range of frequencies covered by the single pixel at which the cursor is positioned, displaying the frequency and amplitude of that maximum signal. If no measured frequency falls within the cursor position pixel then it finds the largest spectral content at the adjacent frequencies which have been measured.

When displaying a WATTS spectrum, the chart shows a plot of the absolute value of watts at each frequency point.

### 12.13.5 EXPORTING OR RECORDING SPECTRUM DATA

The methods for performing this are fully described in section 23.

The SPECTRUM data can be exported to a .CSV format textual file on an external USB drive attached to the front panel USB port. This file contains a tabulation of all frequency points for all channels.

Briefly, this is performed by –

- Insert the drive into the front panel USB port and wait for it to be READY.

- Press the DRIVE INFO area of the screen, the screen shows the file export/import screen.
- Press the SPECTRUM button. The screen changes to allowing you to enter a file name.
- Enter the desired file name (the extension is automatically provided).
- If the file already exists then you are prompted to respond if you wish to overwrite it or not.
- The file is then written.

Alternatively you can make a record of the SPECTRUM screen by saving an image of it to a graphic file on an external USB drive attached to the front panel USB port.

Briefly, this is performed by –

- Insert the drive into the front panel USB port and wait for it to be READY.
- Display the screen to be recorded.
- Press the DRIVE INFO area of the screen, the screen shows the file export/import screen.
- Press the SCREEN IMAGE button. The screen changes to allowing you to enter a file name.
- Enter the desired file name (the extension is automatically provided).
- If the file already exists then you are prompted to respond if you wish to overwrite it or not.
- The file is then written.

## 13 OPTIMIZING LOW-LEVEL DC PERFORMANCE

If you are only using measurements configured as AC (i.e. not DC or AC+DC) or the AC levels are significantly higher than any expected DC levels (e.g. more than 30:1 higher) then low level DC performance is not required and this section can be ignored.

### 13.1 INTERNAL DC ZERO ADJUSTMENT

The PA900 automatically checks the internal DC zeroes if the environment has significantly changed and then applies any changes as needed. The automatic tracking of environmental changes can be disabled by selecting OFF for the AUTOZERO setting in the PREFERENCES screen, in which case the user should occasionally perform this Internal DC Zero operation manually.

This is achieved by pressing the SYS CONFIG button from any main screen and then pressing the INTERNAL button in the DC ZERO area. The PA900 will then perform an Internal DC Zero operation and save the adjustments recorded. A screen will show the progress of the operation and will wait for you to press the RETURN button on that screen when the action has been successfully completed.

Recommendations:

If AUTOZERO has been set to OFF then it is recommended to perform this Internal DC Zero operation at least daily, or whenever the environment has changed by more than  $\pm 2\text{C}$  from that in which it was last performed.

If AUTOZERO has been set to ON but the PA900 is in a significantly different environment that in which it was calibrated then there will be a few minutes after turning on the PA900 while the DC zeroes are tracking that change in environment. To reduce this small shift during the first few minutes of operation you may wish to perform an Internal DC Zero operation in the normally used environment, otherwise there is no need to perform this operation.

Note:

This operation takes a few seconds and does not require that signals be removed from the PA900 terminals. Note that this operation only affects channels which are configured for use.

While performing the Internal DC Zero you should not send any configuration interface commands to the PA900.

### 13.2 EXTERNAL DC ZERO ADJUSTMENT

If you are using external current transducers or shunts which may have a significant DC offset in their output you can perform an External DC Zero operation to set those offsets to the presently measured values. This external DC zero operation can also be used to account for any external DC offsets (leakage currents or thermally induced voltages) or to adjust any remaining offsets in the PA900 caused by adverse environments (e.g. nearby heat sources and/or unusual orientation of the PA900).

This differs from the Internal DC Zero described above because it corrects for any externally applied DC offset, so you must ensure that there are no DC signals present on the terminals of the PA900 which are not wished to be adjusted for.

This is achieved by pressing the SYS CONFIG button from any main screen and then pressing the EXTERNAL button in the DC ZERO area. You are then shown a screen which requests that you select whether to adjust the DC offset for all channels (ALL), or only those configured for scaling (ONLY SCALED), or to abort the action (NO). After you select the desired choice the PA900 will immediately use the latest obtained DC measurements and apply them as DC offsets. If no channels were affected by this operation then a message is displayed for a short time. If the measured DC values were too large to be adjusted then a message is displayed for a short time and no adjustments are made.

Recommendation:

If it is desired to use this external DC zero ability when AUTOZERO is set to OFF then it is recommended to first perform an internal DC zero operation and ensure that valid measurement results are available by returning to any of the measurement results screens and checking that the readings being indicated are those expected before returning to the SYS CONFIG screen and performing the external DC zero operation.

Note:

This takes very little time and has an immediate effect. Channels which are not configured are not affected by this action.

### 13.3 USING AN X CURRENT OPTION INPUT AT LOW LEVELS

X option current inputs have a resolution of  $1\mu\text{V}$  or lower when used with an external current shunt. To achieve this level of performance the user must be aware of thermally induced DC voltages which can occur both within the shunt itself and in the wiring between the shunt and the terminals of the PA900. The user can reduce these effects by using high quality wiring and connectors, and balancing the two sense wires by using the same gages and lengths, using the same connector types, and routing the two wires together. In severe circumstances this can also be affected by air currents passing over the shunt or the wiring, so you may need to take precautions to prevent unwanted airflow over them.

Recommendations:

Twisting together the two sense wires from the shunt to the PA900 terminals both reduces these thermal voltage effects and also reduces the inductive pick-up of AC current in these wires, so is highly recommended. You should also note that the use of thinner gage wiring (e.g. 26awg or thinner) will produce the best thermal voltage performance as thinner wiring does not allow significant heat transfer through it.

The use of coaxial cable is not recommended as often the two conductors are not of the same material.

Even when all precautions are taken, there will typically be several micro-volts of thermally induced offset voltages. The regular use of the External DC Zero capability described above is highly recommended when using shunts.

## 14 PERFORMING STARTUP OR INRUSH MEASUREMENTS

The PA900 provides several methods for performing measurements of Inrush or for device startup. Which method is chosen is up to you, as each has its merits.

It is assumed in this section that you are conversant with the general operating methods used in the PA900 as described in section 12.

This section is specifically written to describe two such methods for measuring Inrush currents; however it may equally be applied for other device startup measurements.

Usually the measurement configuration suitable for inrush measurement is not the same as that used for 'normal' power measurements. This often results in errors being made in either the inrush measurement or in normal power measurements because these configuration changes are forgotten or improperly made.

Inrush measurements are usually performed with no bandwidth restrictions whereas normal power measurements may have a restricted bandwidth.

Inrush measurements typically need to be performed on the HI range of any D current option channels, whereas normal power measurements use the most optimal range of current measurement for the normal current levels of a device.

### 14.1 OBTAINING A GRAPHICAL AND NUMERICAL INRUSH CURRENT MEASUREMENT

This first method described requires no specific configuration changes to the MEAS CONFIG screen to perform an inrush measurement as any changes required will be automatically applied.

This has the advantage of being an easily repeatable measurement; the measurement is not dependent on remembering to re-configure for inrush measurements (and remembering to reverse that later), and the configuration of the SCOPE can typically be left at the settings for the inrush measurement so they do not need to be changed and also none of these settings have any significant impact on the inrush measurement itself, only how it is displayed.

For full details regarding using the SCOPE screen see section 12.10.

The example screen below shows an example SCOPE screen used for this purpose, showing an inrush current measurement having been performed. In this case voltage was continuously applied to the PA900 terminals; the power switch of the device being tested was used to apply the power inrush. This can also be achieved by turning on and off the source of the voltage.

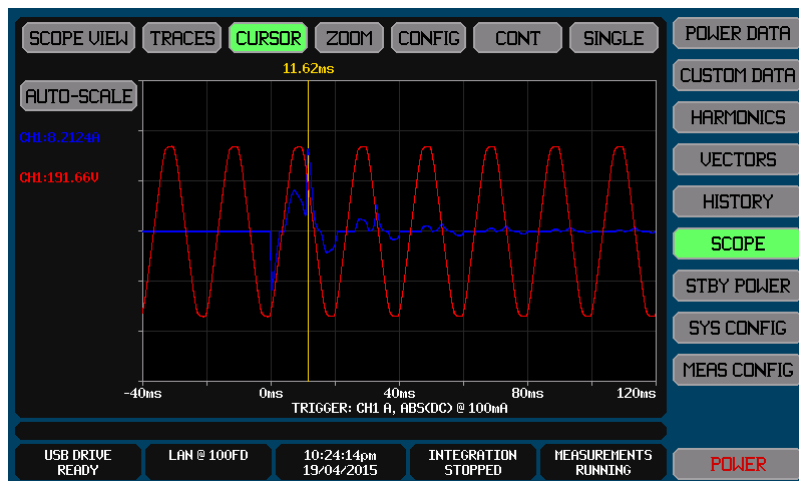

1. Turn off the device being tested. It does not matter if the voltage is switched off between the PA900 and the device (so the voltage is always present at the PA900) or at the supply to the device + PA900 (so the voltage is not initially present at the PA900). Typically a device should have power removed for some period of time before re-applying power for a meaningful inrush measurement (often several minutes).
2. Configure the PA900 Scope capture for the inrush measurement as shown in the example screen below –

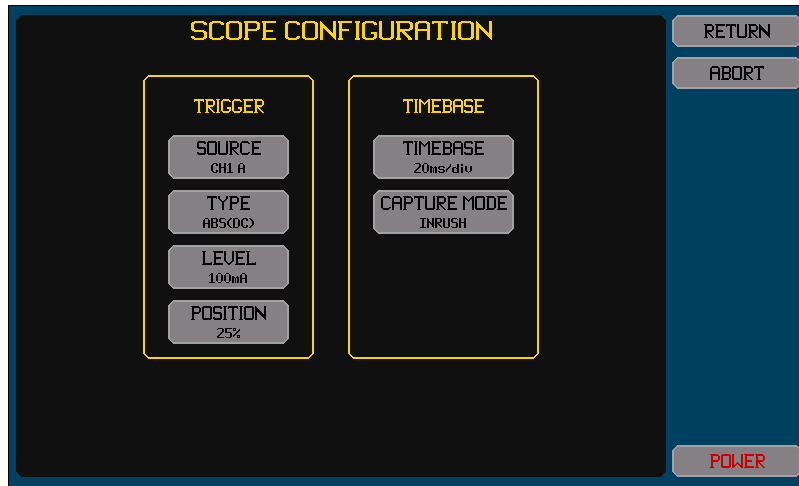

This example uses channel 1 as monitoring the power to the device being tested – any channel configured for measurements can be used.

This example shows a 100mA trigger level being used. This is a typical trigger level to use for this purpose; however some devices being tested may draw more than this when turned off, in those cases this level should be increased to above the current level drawn by the device while turned off (or consider switching the source of the power rather than using the device power switch).

This example shows 20ms/division as the timebase and the trigger position will be at the 25% position on the screen – resulting in the final screen having 40ms shown before the trigger event and 120ms afterwards. You can select a different timebase as required if the inrush event is known to be shorter or longer. The 25% trigger position is recommended for this type of measurement.

The CAPTURE MODE is selected as INRUSH. This setting tells the PA900 to automatically ignore any bandwidth limitation provided by the existing BANDWIDTH setting and also to force the use of the HI range of any unscaled D current option channels while the inrush capture is in progress. After the capture has been made then these settings will automatically revert to those configured.

- Configure the traces which will be shown on the screen. The screen below shows an example of two traces being configured to be captured (current and voltage). As shown here, it is useful to include the supply voltage as a trace, as this allows you to inspect the supply voltage to see if it was being significantly disturbed by the inrush surge current and so having an impact on the inrush current measurement.

Trace 1 must be the signal which will measure the inrush current; the other traces can be any signals which are also desired to be captured.

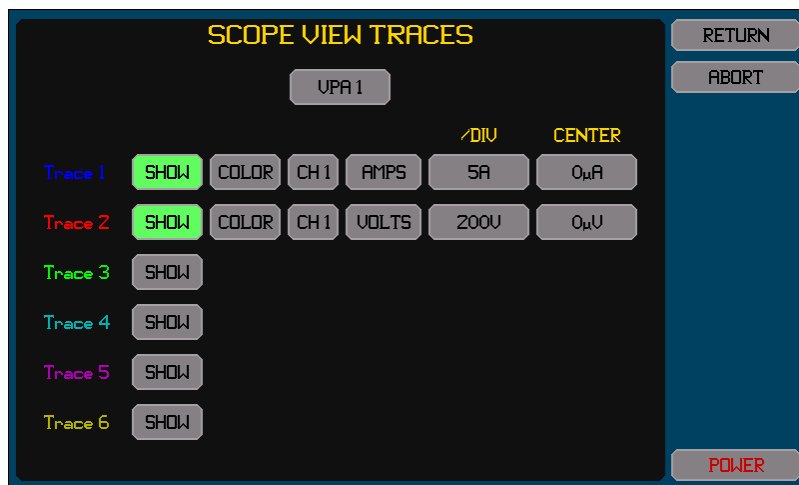

For each trace–

Pressing the SHOW button toggles the trace on/off. The button is highlighted colored green when enabled.

Change the color by pressing the COLOR button until the adjacent trace number shows the desired color.

There are two buttons to the right of the COLOR button which allows you to select the channel and signal to trace. Either the voltage or current or watts signals may be traced. The watts signal is the result of multiplying the voltage and current signals. All traces must be in channels configured in the same VPA as that in which the trigger source channel is configured.

The button in the /DIV column allows you to set the scaling in the units of the selected signal. Note that this is entered per division and there are a total of 6 vertical divisions in the chart (3 above and 3 below the centerline). This can also be set after the capture has been made to the best 1/2/5 values to show all traces within the extents of the chart when the AUTOSCALE button is pressed on the SCOPE VIEW screen. This only affects how the trace will subsequently be displayed and so can be changed afterwards.

The button in the OFFSET column allows you to set the signal level which will correspond to the centerline of the chart. This only affects how the trace will subsequently be displayed and so can be changed afterwards. For this type of measurement this is typically set to zero.

4. Press the SINGLE button to initiate an inrush capture. The PA900 will now wait until an inrush event is detected by the current exceeding the trigger level set above, as shown by the SINGLE button label changing to WAITING.
5. Apply power to the device.
6. The PA900 screen will detect the current inrush and capture the signals as shown on the screen.

The screen will have a cursor which is automatically set to the position of the maximum inrush current, and the numerical data to the left of the chart will show the signals at the cursor position so the trace 1 data shows the maximum inrush current.

You may re-scale the traces vertically to properly show them on the screen if you wish. This is best accomplished by pressing the AUTOSCALE button which will automatically adjust the display scaling so that the traces optimally fit on the chart.

You may zoom in to show more detail horizontally surrounding the inrush event by pressing the ZOOM button and selecting a zoom timebase which is faster than the timebase used for the capture.

You may move the cursor by dragging it across chart. Pressing the CURSOR button repositions the cursor at the maximum inrush event position.

7. The above may be repeated as many times as you wish without requiring any action by you other than pressing the SINGLE button and then re-applying power to the device.
8. Any other screen may be viewed after the inrush capture is completed, the MEAS CONFIG settings were re-activated and so all power measurements are as they are configured. This screen is still available though and can be returned to later.

## 14.2 OBTAINING A NUMERICAL INRUSH CURRENT MEASUREMENT

Before performing the inrush measurement in this manner, you must ensure that the present MEAS CONFIG screen settings are compatible with performing such a measurement, and then replace the 'normal' power measurement configuration settings afterwards.

The PA900 must be configured typically with a UNFILTERED setting for BANDWIDTH, or alternatively with a specific frequency bandwidth limit.

All D current option channels which will be used for this inrush current measurement should be configured for the HI A RANGE selection.

Having checked that the PA900 is correctly configured, you should now prepare to make the inrush measurement. The example screen below shows the PA900 POWER DATA screen which will be used for this purpose.

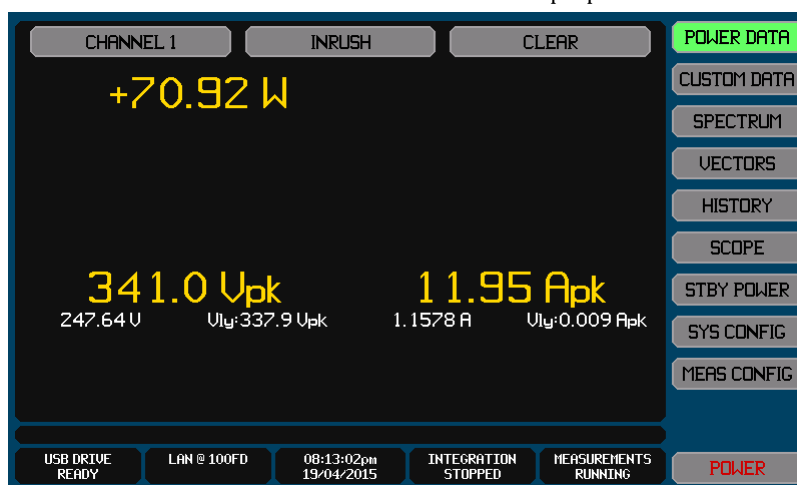

1. Turn off the device being tested. It does not matter if the voltage is switched off between the PA900 and the device (so the voltage is always present at the PA900) or at the supply to the PA900 + device (so the voltage is not initially present at the PA900). Typically a device should have power removed for some period of time before re-applying power for an inrush measurement (often several minutes).
2. Select the POWER DATA screen on the PA900 and configure it to show the desired channel or VPA (the left button across the top of the screen) and select to show the INRUSH data (the middle button across the top of the screen). The screen will look similar to that shown in the example above.
3. Press the CLEAR button on this screen. This will clear any previously made inrush measurements and the screen will show the highest measurements with the device being tested unpowered (so should be very small current and power). If an inrush measurement is being repeatedly made to ensure that the worst case measurement is made then you can skip clearing the previous results, in that case the results shown will only be updated if an inrush measurement exceeds those previously made.
4. Apply power to the device.
  - a. The PA900 screen will be updated to show the highest data recorded since it was last cleared.
  - b. The Apk and A data are the most important results shown for this type of testing, showing the highest peak current and highest single measurement period RMS current respectively. These provide you with the measurement of the

peak current surge and a measure of the short-term RMS current surge (which is typically much lower than the peak surge).

- c. The Vpk, and V data shows the highest peak voltage and highest RMS voltage respectively. This is typically not particularly important for inrush current measurements, but if it shows very high voltages then this could indicate that the supply has excessive overshoot when recovering from the surge current so it might not be suitable for this type of testing.
- d. The W data shows the highest single measurement period power surge. Typically this is not used for inrush applications.

Note:

The measurements obtained for inrush are not affected by the RESPONSE setting for the VPA.

If it is desired to perform normal power measurements after performing inrush measurements using this method, then you must not forget to return to the MEAS CONFIG screen and re-apply the original settings if any were altered for the inrush measurement.

## 14.3 RECORDING INRUSH DATA

The methods for performing this are fully described in section 23.

Whichever method is used to obtain the inrush measurement, the resulting data can be recorded by saving an image of the screen showing the results to a graphic file on an external USB drive attached to the front panel USB port.

Briefly, this is performed by –

- Insert the drive into the front panel USB port and wait for it to be READY.
- Display the screen to be recorded.
- Press the DRIVE INFO area of the screen, the screen shows the file export/import screen.
- Press the SCREEN IMAGE button. The screen changes to allowing you to enter a file name.
- Enter the desired file name (the extension is automatically provided).
- If the file already exists then you are prompted to respond if you wish to overwrite it or not.
- The file is then written.

If the inrush waveform was captured using the SCOPE VIEW screen then that data can be exported to a .CSV format textual file on an external USB drive attached to the front panel USB port. This file contains a tabulation of the points in each SCOPE VIEW waveform for all channels.

Briefly, this is performed by –

7. Insert the drive into the front panel USB port and wait for it to be READY.
8. Press the DRIVE INFO area of the screen, the screen shows the file export/import screen.
9. Press the SCOPE DATA button. The screen changes to allowing you to enter a file name.
10. Enter the desired file name (the extension is automatically provided).
11. If the file already exists then you are prompted to respond if you wish to overwrite it or not.
12. The file is then written.



## 15 INTEGRATING DATA

The PA900 can provide integrated results, for example AHr, WHr, VAHr etc.. This section describes how to configure integration and how to start and stop integration.

It is assumed in this section that you are conversant with the general operating methods used in the PA900 as described in section 12.

Integrated data measurement results can be viewed using the POWER DATA screens as described in section 12.5.1.4 (for individual channel results) or 12.5.2.3 (for VPA total results).

Note:

You do not have to be viewing integrated data for data to be integrated.

Integrated results do not only provide the total integrated data but also can provide you with bought, sold, charge and discharge integrated data as follows-

Bought integrated data includes only data while the channel or VPA has positive Watts and is only available in VPAs which are not configured for DC ONLY COUPLING.

Sold integrated data includes only data while the channel or VPA has negative Watts and is only available in VPAs which are not configured for DC ONLY COUPLING.

Charge integrated data includes only data while the channel or VPA has positive DC Amps and is only available in VPAs which are configured for DC ONLY COUPLING.

Discharge integrated data includes only data while the channel or VPA has negative DC Amps and is only available in VPAs which are configured for DC ONLY COUPLING.

### 15.1 CONFIGURING INTEGRATION

You may configure for manually controlled integration or for automatically time controlled integration by pressing the Integration Info area when not performing integration.

The START button on this screen makes any changes immediately active and starts integration.

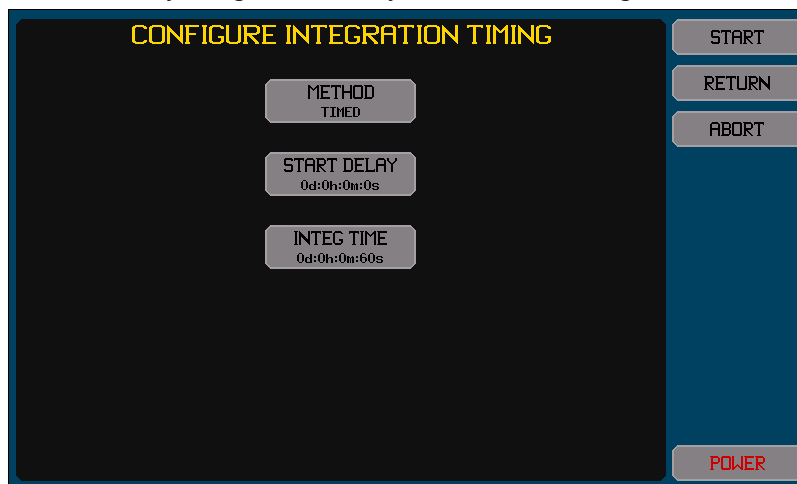

#### 15.1.1 SELECTING TO PERFORM MANUALLY TIMED INTEGRATION

If it is desired to manually control starting and stopping integration then select MANUAL as the METHOD setting on this screen.

#### 15.1.2 SELECTING TO PERFORM AN AUTOMATICALLY TIMED INTEGRATION

If it is desired to automatically control the timing and stopping of integration then select TIMED as the METHOD setting on this screen.

When configured in this manner, after manually starting the integration sequence the configured delay period is performed after which the automatically timed integration is performed.

Note:

The delay can be configured to a zero time.

You can still stop integration manually at any time.

You can configure the delay time using the START DELAY button and the desired run time using the INTEG TIME button. These are both configured in the same general manner-

In the data entry screens for the START DELAY and INTEG TIME settings there are four entries, one for each unit of days, hours, minutes and seconds.

The screen always starts with the days data selected; you can jump to any of the four time units directly by pressing the respective time entry area.

You can enter a numeric between 0 and 99 into any of the four screens. The actual time used is the total time created by combining all four data with their respective units.

When the ENT button is pressed the selected time unit area automatically changes to next area to the right, unless the seconds data is selected when the action is same as pressing the overall RETURN button.

## 15.2 STARTING AND STOPPING INTEGRATION

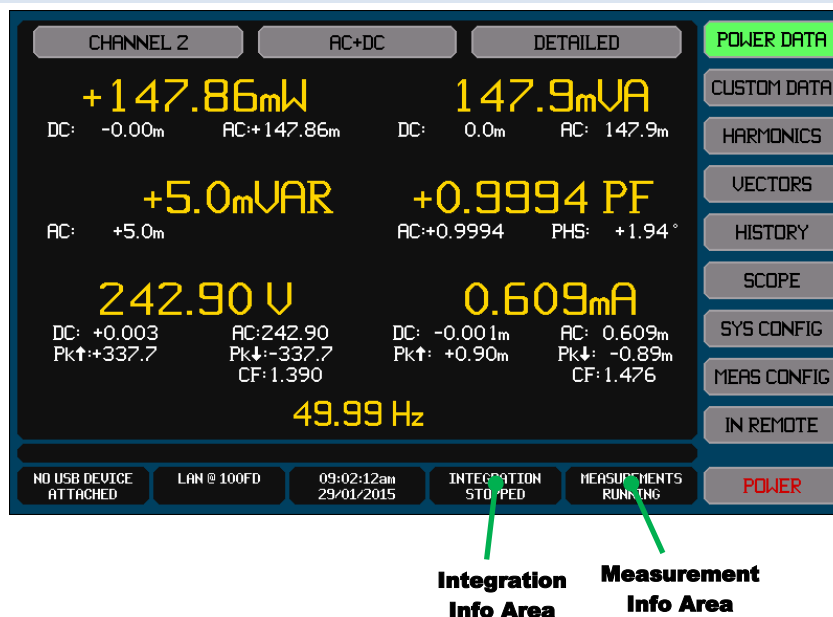

All main screens have an integration info area as shown on the example screen above. This shows the present status of integration as follows –

**STOPPED.** Indicates that no integration is presently being performed. To start integration press the Integration Info Area and press the START button on that screen.

**RUNNING.** Indicates that a manually controlled integration is being performed. Integration will continue until manually stopped. Press the Integration Info Area to stop integration.

**PAUSED.** Indicates that a manually controlled integration is being performed but has been paused by you pressing the Measurement Info area to hold it. Integration will continue when the measurement hold is released or integration is manually stopped. Press the Integration Info Area to stop integration.

**DELAY.** Indicates that a timed integration is being performed and is delaying prior to collecting integrated data. The progress bar to the right shows how much of the delay has expired. Press the Integration Info Area to stop integration.

**RUN.** Indicates that a timed integration is being performed and is collecting integrated data. The progress bar to the right shows how much of the configured run time has expired. Press the Integration Info Area to stop integration.

**PAUSE.** Indicates that a timed integration is being performed, the delay time has expired, but the PA900 is not collecting integrated data because you have held measurement results. The progress bar to the right shows how much of the configured run time has expired. Press the Integration Info Area to stop integration.

Note:

When starting integration, any previous integration results are always cleared and a new integration is started.

## 15.3 EXPORTING OR RECORDING INTEGRATED MEASUREMENTS

The methods for performing this are fully described in section 23.

All measurements can be exported to a .CSV format textual file on an external USB drive attached to the front panel USB port. This file contains all measurements (including harmonics) for all channels and all VPAs.

Briefly, this is performed by –

- Insert the drive into the front panel USB port and wait for it to be READY.
- Press the DRIVE INFO area of the screen, the screen shows the file export/import screen.
- Press the MEASUREMENTS button. The screen changes to allowing you to enter a file name.
- Enter the desired file name (the extension is automatically provided).
- If the file already exists then you are prompted to respond if you wish to overwrite it or not.
- The file is then written.

Alternatively you can make a record of any measurement screen by saving an image of it to a graphic file on an external USB drive attached to the front panel USB port.

Briefly, this is performed by –

- Insert the drive into the front panel USB port and wait for it to be READY.
- Display the screen to be recorded.

- Press the DRIVE INFO area of the screen, the screen shows the file export/import screen.
- Press the SCREEN IMAGE button. The screen changes to allowing you to enter a file name.
- Enter the desired file name (the extension is automatically provided).
- If the file already exists then you are prompted to respond if you wish to overwrite it or not.
- The file is then written.

## 16 PERFORMING MEASUREMENTS OF PWM GENERATED SIGNALS

Because of its wide bandwidth and spread-spectrum sampling method the PA900 can make high accuracy measurements of PWM based signals however the user should take some special precautions when wiring and configuring the PA900 specifically for these measurements. This section details those precautions.

It is assumed in this section that you are conversant with the general operating methods used in the PA900 as described in section 12.

Note:

In PWM applications the voltage signals contain significant signal content at two or more frequencies, typically –

- The “carrier frequency”. This is sometimes called the PWM switching frequency, also sometimes called the PWM Frequency. In some sources this may be at a fixed frequency, while in others it may vary to reduce interference, improve efficiency, and/or improve waveform shape of the modulation signal content. In most cases this is a ‘square-wave’ voltage whose peaks are fixed by the internal DC voltage from which the source is generated (sometimes called the “bus voltage”) and the duty cycle is continuously varied to control the modulation signal component. The carrier frequency component often the largest component of the voltage signals.
- The “modulation frequency”. This is the frequency at which the carrier frequency duty cycle is varied to cause signal content at a frequency much lower than the carrier frequency, including DC in some cases. In the case where the load is a motor this is sometimes called the drive frequency and for a synchronous motor this frequency sets the motor speed. For an inductive load (e.g. a motor) the current signal generally includes very little of a carrier frequency component, being primarily only at the modulation frequency.

### 16.1 CHOICE OF CHANNELS

When considering which channels to use in PWM applications it is important to consider the type of channel (the 1<sup>st</sup> letter of the two letter channel option). The 2<sup>nd</sup> letter is only important with regards to the current level and the type of transducer if one is being used.

A and S channel types are not recommended for high accuracy applications where the carrier frequency is above 80kHz (10kHz if harmonics accuracy is needed) and W channel types are generally not recommended above a 400kHz carrier frequency (50kHz if harmonics accuracy is needed).

In many PWM applications (e.g. motor drives) the duty cycle of the waveforms can range from a few percent up to almost 100%. This means that for best accuracy the signal integrity must typically be maintained up to a frequency of >10 times the carrier frequency for non-harmonic measurements (e.g. RMS voltage, RMS current and total power) and >80 times the carrier frequency for harmonic measurements (e.g. individual harmonics and THD). If the range of duty cycles is known to be less than this and is nominally centered close to 50% then higher carrier frequencies can be accommodated with accuracy.

### 16.2 WIRING RECOMMENDATIONS

You should keep all wiring between the source, the PA900, and the load as short as possible. If using the 3 $\emptyset$ 3w(3ch) method you should ensure that the inter-connection between the three V- terminals is kept as short as possible and is left floating.

Generally PWM generated voltage signals have very short rise and fall times on their switching edges. If the wiring is long then these signals can have very significant overshoot and ringing caused by the inductance of the wiring. Such overshoots and ringing can cause interference which may affect nearby electronic equipment, and in severe cases may affect the measurement accuracy and in extreme cases the overshoot voltages may be higher than the PA900 is able to withstand.

#### 16.2.1 RECOMMENDED 3-PHASE, 3-WIRE WIRING METHOD SELECTION

This section is only applicable if the source and load are 3-phase with no neutral connection (i.e. 3-phase, 3-wire). For single phase, 2-phase (2 $\emptyset$ 3w), and 3-phase with a neutral connection (3 $\emptyset$ 4w) applications use the normally applicable wiring method.

If the accuracy of harmonics results is not of significant importance to you then either 3 $\emptyset$ 3w(2ch) or 3 $\emptyset$ 3w(3ch) wiring methods can be used.

If the accuracy of harmonics results is of significant importance to you then it is recommended to use the 3 $\emptyset$ 3w(3ch) wiring method. Generally the accuracy of non-harmonic results are unaffected by this choice.

In the PA900 there is very little difference between these choices in regards to the available measurement results. For both choices the majority of inter-phase non-harmonic and harmonic measurements are available and inter-phase voltage scope signals are available.

The individual phase voltages have significantly less high frequency content than the inter-phase voltages in multi-phase PWM applications. At near zero crossings of the inter-phase voltage signal the two phase signals have nearly the same PWM duty cycle, so the inter-phase signal consists of one or two (depending on the switching method) very slim pulses having full DC bus voltage amplitude and a very low duty cycle (significantly less than 1%). These pulses have very significant content at high frequencies well above the specified frequency range of the power analyzer so any high frequency non-linearity or sampling artifacts within the power analyzer may become significant and cause the appearance of harmonics in those results, possibly up to a few percent at typically 3<sup>rd</sup> harmonic.

Because the PA900 is not designed solely for mains power applications but has a wide bandwidth extending up to several MHz, the presence of such signals well above the specified bandwidth may affect it slightly. By using the 3-channel method this effect is eliminated as extremely slim pulse widths will only occur at the very extremes of output amplitude in each phase and generally PWM switching systems are designed to not achieve such slim pulses since these also have a significant impact on the PWM drive itself.

## 16.3 CONFIGURATION RECOMMENDATIONS

### 16.3.1 RECOMMENDED FREQ SPEED SYSTEM PREFERENCE

This setting is contained in the SYS CONFIG – PREFERENCES screen.

In most cases the NORMAL system preference setting for FREQ SPEED is recommended for PWM applications.

If the load is a variable speed motor and fast changes in speed are likely to occur then setting the FREQ SPEED preference to FAST should be considered. In this case you should also consider using a short LF/PERIOD setting in the MEAS CONFIG for that VPA.

If the load is a motor being operated at a nominally fixed speed and the modulation frequency has significant jitter such as is often caused by motor jitter or by the beat between the modulation and carrier frequencies of the PWM signals then the SLOW setting should be considered. This can be of particular importance when viewing harmonics results as the beat frequencies between the modulation and carrier frequencies have the maximum effect on those results.

### 16.3.2 RECOMMENDED MEAS CONFIG SETTINGS

Settings not described here are not affected by the signals having PWM content so no specific recommendations are needed.

#### 16.3.2.1 LF/PERIOD SETTING

Generally there is no PWM specific precaution regarding this setting. However you should consider that this setting not only affects the measurement period (and so the update rate) but also sets the minimum frequency measurable by the PA900, which can be of importance when using a variable modulation frequency (e.g. a variable speed motor drive).

If it is important that the measurement results track significant rapid changes in modulation frequency or other measurement results then this should be set for as fast of a LF/PERIOD setting as possible for the minimum modulation frequency to be measured.

#### 16.3.2.2 FUND SETTING

If the load is inductive (such as a motor) then the CURRENT setting should be used; only if there is no load or the load is not inductive should the VOLTAGE setting be used. If either the CURRENT or VOLTAGE setting is used then the maximum frequency entered should be as low as possible, at or slightly above the maximum expected modulation frequency and below ½ the minimum expected carrier frequency.

If the amount of modulation is very low, particularly if VOLTAGE is selected, then the PA900 might not be able to extract the modulation frequency from the selected signal and in those cases you should select a FIXED setting and enter a frequency equal to the modulation frequency. The frequency entered will need to be changed if the modulation frequency is changed.

#### 16.3.2.3 BANDWIDTH SETTING

There are two possible methods of configuring the bandwidth of measurements of PWM based signals, each method has its' merits.

1. Using a wide bandwidth for measurements. If it is desirable to ensure that all non-harmonic measurements (such as voltage, current and power) contain the signal content with as wide of a bandwidth as possible then the BANDWIDTH setting should be set to UNFILTERED. All non-harmonic measurements made by the PA900 will then include all signal content within the bandwidth capabilities of the specific channels installed in the unit. Because the voltage measurement includes the carrier frequency content the measurement results for voltage, VA, PF and VAR might be significantly different from those which you may expect; however this ensures that the power results contain all of the power in the load by including motor losses at high frequencies and so yields the best possible accuracy for efficiency and power loss measurements.
2. Using a restricted bandwidth for measurements. If it is desirable to only include the modulation frequency content (and its' harmonics) in the measured voltage, VA, PF and VAR then BANDWIDTH should be set to USER and a frequency entered which is less than ½ of the lowest expected PWM carrier frequency but above that of the highest expected modulation frequency. In the PA900 the effect of such significant filtering is generally negligible on the measurement result accuracy and has the possible advantage of yielding the expected voltage, VA, PF and VAR results; however the power results will not contain motor losses at high frequencies.

Note:

Signals captured using the SCOPE VIEW screen are also affected by this setting.

The use of the AUTO-TRACK setting for BANDWIDTH is not recommended in PWM applications unless the HARMONICS setting is set to less than 1/6<sup>th</sup> of the minimum expected value for the ratio between the modulation and carrier frequencies.

The apparent difference in the voltage and related measurements between the bandwidth selections described above is a result of the difference in the measured signal content, this is not specific to the PA900.

- a. The wide bandwidth RMS voltage includes both carrier and modulation components, so the resultant voltage measurement =  $\sqrt{(V_{\text{carrier}}^2 + V_{\text{modulation}}^2)}$ .
- b. Typically the RMS current is unaffected by the measurement bandwidth as it includes very little carrier component because of an inductive load.
- c. Typically measurement bandwidth does not affect Watts and related measurements (e.g. efficiency) other than including any carrier frequency losses in the load since Watts measurements only include frequency components which are present in both voltage and current signals.
- d. Typically V, VA and VAR will be much higher and PF will be much lower for measurements with an unrestricted bandwidth than those measurements for just the modulation component. This is just because of the carrier frequency content of the signals themselves as described in a) above.

#### 16.3.2.4 HARMONICS SETTING

If harmonics measurements are not required then this should be set to either 0 or 1 (if set to 1 then the vectors and cycle view screens are available, otherwise they are not).

Otherwise, this setting depends on the BANDWIDTH setting method selected. Generally, because of the presence of the PWM carrier signal, measurement of more than a few harmonics is inappropriate in these applications.

1. BANDWIDTH set to UNFILTERED. The PA900 applies sufficient bandwidth restrictions only to harmonics measurements in this case so it is necessary to ensure that harmonic measurements do not include any significant artifacts of the PWM carrier frequency. You should compute the highest required harmonic having a frequency of  $\frac{1}{4}$  of the PWM carrier frequency and enter that number (or less) for the HARMONICS setting. If the drive is subsequently operated at a different modulation frequency then this setting may need to be altered. For example, if the modulation frequency is 50Hz and the PWM carrier frequency is 5kHz then the highest recommended HARMONICS setting is  $(\frac{1}{4} * 5000 / 50) = 25$ .
2. BANDWIDTH set to USER. In this case the value set for HARMONICS selects the highest limit for the number of available harmonics but the PA900 will also automatically and dynamically limit it to the harmonic having a frequency of  $\frac{1}{2}$  of the BANDWIDTH frequency setting. So in this case this setting only sets a maximum limit to the number of available harmonics, typically the actual number is limited by the BANDWIDTH setting.
3. BANDWIDTH set to AUTO-TRACK. In this case the PA900 will automatically limit the bandwidth to 3 times the frequency of the highest harmonic set by the HARMONICS setting. You should set a HARMONICS setting of less than PWM carrier frequency /  $(6 * \text{highest modulation frequency})$ . For example, if the highest expected modulation frequency is 50Hz and the PWM carrier frequency is 5kHz then the highest recommended HARMONICS setting is  $(5000 / (6 * 50)) = 16$ .

Note:

Generally either no harmonics measurements are needed (so set HARMONICS to 0 or 1), or only a few have significance to you (so set HARMONICS to the lowest number possible).

The HARMONICS setting has no effect on non-harmonic measurements (e.g. RMS voltage and current, and Watts, VA, VAR, and PF).

Signals captured using the CYCLE VIEW screen are also affected by this choice, but signals captured by the SCOPE VIEW screen are not.

#### 16.3.2.5 RESPONSE SETTING

Because of the various asynchronous signal contents and also because often the measurements being made are within an overall control loop (e.g. motor speed control), these signals often have considerable variability so the use of result "smoothing" is recommended. This is selected by your choice for the RESPONSE setting and MEDIUM is the recommended choice in most PWM applications.

Note:

This setting applies to all measurement results.

Often in PWM applications harmonic results require more smoothing than non-harmonic results because of the inter-harmonic and sub-harmonic signal content present in these signals caused by the asynchronous nature of the carrier and modulation frequencies, in those cases it is recommended to change the RESPONSE setting according to which results you wish to obtain at that time. Changing this setting does not "restart" the smoothing but continues it, so changing the RESPONSE setting while the signals are present is recommended to avoid unnecessarily long settling times when a long RESPONSE setting is selected.

It is generally better to smooth results by applying a longer RESPONSE setting than selecting a longer LF/PERIOD setting as the RESPONSE smoothing is a multi-order smoothing filter whereas the effect of the measurement period is the equivalent of a single order filter and also does not apply continuous filtering so has less effect.

---

### 16.3.3 PWM GENERATOR EFFICIENCY MEASUREMENTS

In some applications it may be desired to measure both the output of a PWM power generator and also the supply to it, e.g. for power generator efficiency measurements. This is achieved by configuring the two measurements in two different VPAs in the same PA900 as follows-

1. If there will be significant changes to the levels or signals which require tracking for efficiency results and the supply is DC which contains ripple at the modulation frequency of the PWM generator (or little ripple at any frequency) and all channels are W type channels or all are not W type channels.
  - The MEAS MODE should be set to MULTI VPA.
  - The PWM generator output VPA should be configured as VPA1.
  - The DC supply VPA should be configured as VPA2 and DC measurements (FUND=NONE and COUPLING=DC ONLY).
  - The LF/PERIOD setting of the DC VPA (VPA2) should be set to "VPA1".
  - Use the same RESPONSE setting in both VPAs.

In this manner the PA900 will measure the DC supply exactly synchronously with the measurements of the PWM generator output, and so will reject the ripple content and also will accurately track changes in efficiency caused by changes in the signals.

2. Same as option 1 above but the PWM measurement channels and the DC measurement channels are not of the same type.
  - The MEAS MODE should be set to SYNC VPA.
  - Both sets of measurements should be configured in separate VPAs. Any VPA can be used for either measurement and both are independently configured.

- The FUND setting of the DC VPA should be set to the VPA measuring the PWM Generator.
- The HARMONICS setting for the DC VPA should be set to 0 (it can also be set to a non-zero value, in which case the ripple content of the DC supply will be available as harmonics).
- Use the same LF/PERIOD and RESPONSE settings in both VPAs.

In this manner the two VPA measurements will be closely synchronized by always starting them at the same time so efficiency will track fast changes to signals. Both measurement periods will be almost the same, so synchronization will be very close and measurements will be almost continuous as any pauses between measurements will be very short (typically a few tens of  $\mu\text{sec}$ ).

3. If there will be significant changes to the levels or signals which require tracking for efficiency results and the supply is either DC containing ripple at some frequency other than the modulation frequency, or it is an AC supply (e.g. mains).
  - The MEAS MODE should be set to SYNC VPA.
  - Both sets of measurements should be configured in separate VPAs. Any VPA can be used for either measurement and both are independently configured. It is recommended that, if possible, both LF/PERIOD settings be the same value.
  - Use the same RESPONSE setting in both VPAs.

In this manner the two VPA measurements will be closely synchronized by always starting them at the same time, even though they might not actually end at exactly the same time, so efficiency will track fast changes to signals as much as possible but there may be a slight difference between the two measurement periods and neither measurement will be continuous as each must wait for the other to finish before it can restart.

4. If none of the above situations are true, or if you are uncertain if any of the above situations are true.
  - The MEAS MODE should be set to MULTI VPA.
  - Both sets of measurements should be configured in separate VPAs. Any VPA can be used for either measurement and both are completely independently configured.
  - Although the two measurement periods will be asynchronous you can reduce any abnormal efficiency results during fast changes as follows –
    - Use the same LF/PERIOD setting in both VPAs if possible.
    - Use the shortest possible measurement period in the LF/PERIOD settings of both VPAs.
    - Use the same RESPONSE setting in both VPAs.

In this manner the two VPA measurements will be not be synchronized in any manner, so efficiency may not correctly track fast changes to signals but will be accurate while both measurements are stable. In this option both measurements are always continuous. Note that you can readily change to option #3 above by simply changing the MEAS MODE to SYNC VPA.



## 17 PERFORMING EN50564 LOW POWER MEASUREMENTS

The STBY POWER Screen gives you the ability to configure, start/stop, and view the results of low power measurements in accordance with EN50564:2011.

It is assumed in this section that you are conversant with the general operating methods used in the PA900 as described in section 12.

The STBY POWER screen can be selected for view from any of the Main Data Screens by pressing the STBY POWER button.

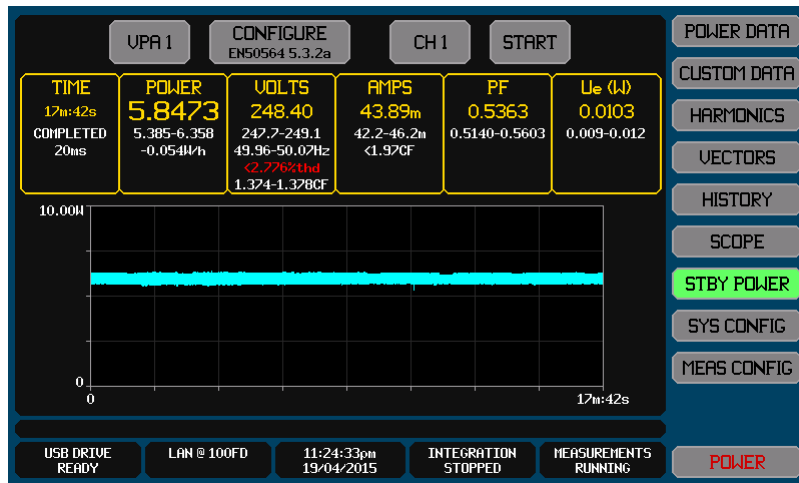

The PA900 has the ability to perform low power measurements independently in each VPA, so a single PA900 can perform up to 3 independent low power measurements. You select which VPA is being configured, controlled and viewed by using the VPA button (the leftmost across the top of the screen).

The PA900 performs the low power measurement in accordance with EN50564:2011 para. 5.3.2, which is the recommended method for all low power measurements.

If you prefer a measurement according to EN50564:2011 para. 5.3.3 (*“Average reading method”*) or 5.3.4 (*“Direct meter reading method”*) then these can be accommodated using the POWER DATA screen with the VPA properly configured and (as needed) using the Integration capabilities of the PA900 described elsewhere in this document. The STBY POWER screen should generally not be used for these methods, but you should note that the method employed in the STBY POWER screen to EN50564:2011 5.3.2 is *“the recommended approach”* and *“should always be used if there is any doubt regarding the behavior of the product or stability of the mode”*.

Note:

The word *“sampling”* in EN50564:2011 relates to sampling of the individual measurement period results of the PA900, not to the sampling of the signals used to perform each such measurement.

### 17.1.1 VPA MEASUREMENT CONFIGURATION FOR EN50564:2011 MEASUREMENTS

There are some settings in the MEAS CONFIG screen which the user should ensure are appropriate for performing EN50564:2011 compliant measurements. These are not enforced by the PA900 to allow you more flexibility in using this type of measurement.

All settings on the MEAS CONFIG screen which are not listed here do not affect how low power measurements are performed to EN50564:2011.

Note:

The RESPONSE configuration setting for the VPA is not applied to the STBY POWER results.

The COUPLING configuration setting for the VPA is not applied to the STBY POWER results (all STBY POWER results use AC+DC coupling as required by EN50564:2011).

Although allowed by the PA900, it is not recommended to reconfigure a VPA during a low power measurement.

The MEAS CONFIG screen shown below gives an example of a fully EN50564:2011 compliant configuration of the PA900 when the power source and load are connected via a LPA-1 accessory.

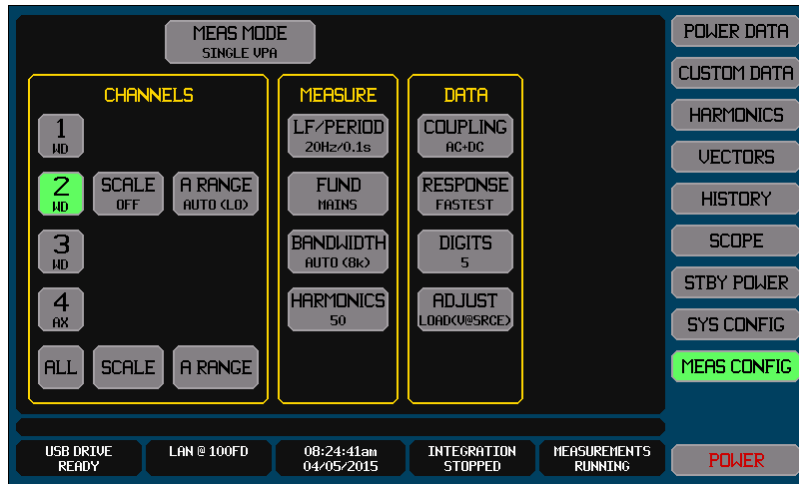

### 17.1.1.1 RECOMMENDED LF/PERIOD SETTING

The PA900 performs one “sample” every measurement period, so to strictly accommodate the requirement of EN50564:2011 para. 5.3.2 that there must be at least one sample per second the VPA must be configured for a LF/PERIOD setting of either 10Hz/0.3s, 20Hz/0.1s or 45Hz/20ms.

Recommendation:

Generally, the 20Hz/0.1s setting is recommended for LF/PERIOD which exceeds the requirement by a factor of 10:1; however for shorter low power measurements, or where the load is known to have fast excursions in power, the 45Hz/20ms setting should be considered.

### 17.1.1.2 RECOMMENDED FUND SETTING

EN50564 measurements are normally performed on mains power.

Recommendation:

Generally, the MAINS setting for FUND is recommended.

### 17.1.1.3 RECOMMENDED BANDWIDTH SETTING

EN50564:2011 para. 4.4.2 requires that power measurement be made with “a frequency response exceeding 2KHz”.

Recommendation:

Generally, the AUTO-TRACK setting for BANDWIDTH is recommended which fully meets this requirement.

### 17.1.1.4 RECOMMENDED HARMONICS SETTING

EN50564:2011 para. 4.3.2 requires limits on the THD of the voltage source and requires that this THD shall be computed using up to and including the 13<sup>th</sup> harmonic.

Recommendation:

The setting should be at least 13 for HARMONICS.

Note:

The reported voltage THD on the STBY POWER screen only includes up to the 13<sup>th</sup> harmonic no matter what HARMONICS is set to as long as it is set to at least 13.

### 17.1.1.5 RECOMMENDED ADJUST SETTING

EN50564:2011 Appendix D requires that the error introduced by the shunt be accounted for in the total error figures or be otherwise compensated for. EN50564:2011 Appendix B discusses two methods of connecting the power analyzer and the load.

Recommendation:

It is recommended that the “Lower Power Loads” connections described in EN50564:2011 B.4.2 (which is the method when using accessory LPA-1) is always used. Use a setting of LOAD(V@SRCE) for ADJUST to compensate for this wiring method.

The small inaccuracy of the compensation is included in the reported error figure.

## 17.1.2 LOW POWER MEASUREMENT CONFIGURATION

The low power measurement itself is configured by pressing the CONFIGURE button on the STBY POWER screen.

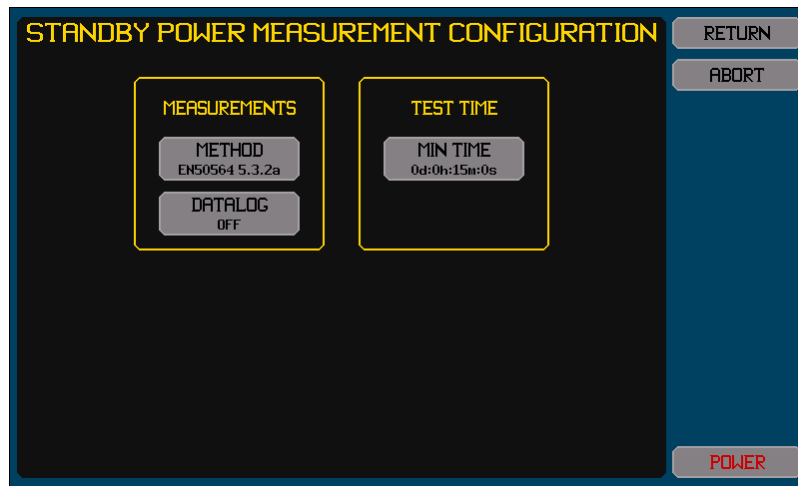

### 17.1.2.1 SETTING THE EN50564:2011 METHOD

The PA900 can perform two types of measurement as defined by EN50564:2011 para. 5.3.2. These are set as EN50564 5.3.2a and 5.3.2d for the METHOD setting and relate to the first and fourth methods described in EN50564:2011 para. 5.3.2 respectively, i.e. the methods for measuring “power consumption within a mode is not cyclic...” (5.3.2a) and “Modes that are known (based on instructions for use, specifications or measurements) to be of limited duration...” (5.3.2d).

Note:

The use of the wording “not cyclic” in EN50564:2011 can be confusing. It does not mean that the load does not vary; it simply means that any variation does not have a known and constant frequency of variation.

Recommendation:

In almost all circumstances the 5.3.2a setting should be used.

### 17.1.2.2 SETTING IF TO SIMULTANEOUSLY DATA LOG

The DATALOG button allows you to select if the PA900 is to automatically start and stop data logging when a low power measurement is started and stopped.

Recommendation:

Typically this is not used, so this is set to NO.

For correct operation when set to YES the data logging should already have been configured to use manual timing (with no delay and less than a 1 second interval) and with the desired data being logged (at least the Watts result is recommended).

### 17.1.2.3 SETTING THE TEST TIME (EN50564:2011 5.3.2A)

If you selected the EN50564 5.3.2a method then the TEST TIME section is shown on the screen with a button which allows you to set the minimum test time for the measurement.

Note:

For strict compliance to EN50564:2011 para. 5.3.2 the low power measurement should be performed for a minimum of 15 minutes and should not be completed until the slope obtained by linear regression of the power during the final 2/3<sup>rd</sup> of the total period is less than that allowed by EN50564:2011.

For convenience where strict adherence to the standard is not required, the PA900 allows the user to configure a total period of other than 15 minutes.

The PA900 will automatically extend the total period if the slope during the final 2/3<sup>rd</sup> of the elapsed time does not achieve the maximum required and will not automatically stop the measurement until this is achieved and the minimum period has also been achieved, but you may manually stop the measurement at any time.

If the measurement is stopped by the user rather than automatically stopped to the requirements of EN50564:2011 this is shown by denoting that the measurement was “STOPPED” rather than “COMPLETED” on the PA900 screen.

In the data entry screens for the TEST TIME setting there are four entries, one for each unit of days, hours, minutes and seconds.

The screen always starts with the days data selected; you can jump to any of the four entries directly by pressing the respective time entry area.

You can enter a numeric between 0 and 99 into any of the four entries. The actual time used is the total time created by combining all four entries with their respective units.

When the ENT button is pressed the selected time unit area automatically changes to next entry to the right, unless the seconds entry is selected when the action is same as pressing the overall RETURN button.

### 17.1.2.4 SETTING THE START/STOP DETECTION LEVELS (EN50564:2011 5.3.2D)

If you selected the EN50564 5.3.2d method then the MODE DETECT section is shown on the screen with two buttons which allows you to set the power levels at which the specific product mode will be detected as starting and ending. These levels are in Watts and the PA900 will detect the start condition as soon as the measured power level exceeds the START setting, and will automatically stop the measurement when measured power level drops below the END setting.

Note:

You may also manually stop the measurement, and by setting an END level of 0.0W and a START level of 0.0W then effectively the measurement period will be totally manually controlled.

### 17.1.3 PERFORMING A LOW POWER MEASUREMENT AND VIEWING THE RESULTS

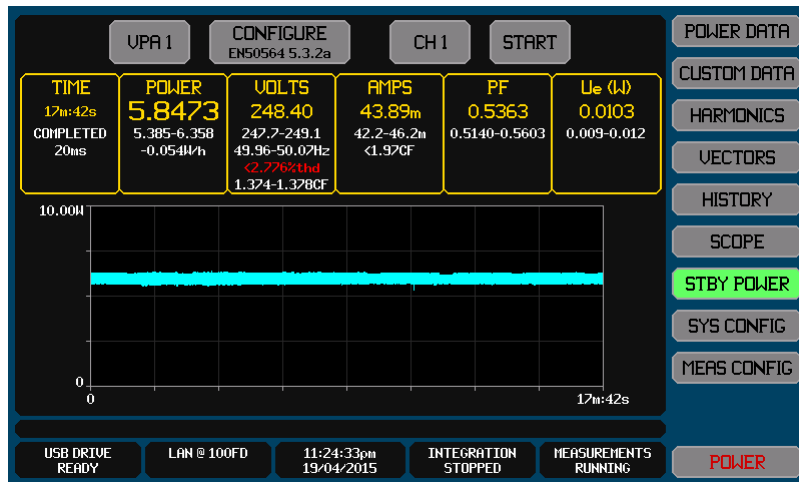

You can START and manually stop a low power measurement by pressing the START button (which is labelled STOP while a measurement is being performed). This controls low power measurements in all channels within the selected VPA.

Note:

For strict accordance with EN50564:2011 para. 4.3 the voltage source to the device being measured may need to be a regulated power source with limits on the voltage level and stability, frequency value and stability, voltage crest factor and voltage distortion. It is possible that the local mains supply meets these requirements, but this is often not the case. Also, the EN50564:2011 requirements for voltage level and frequency are often overridden by other standards, usually calling for EN50564:2011 measurement of power and imposing limits on the measurement result, but which are specific to local supply voltages or frequencies different to those defined in EN50564:2011. The PA900 maintains a record of the voltage level, frequency, voltage crest factor and voltage THD during a low power measurement and reports the range of these measurements encountered during the measurement, and also reports if any of the crest factor or THD requirements are exceeded by coloring the data red if those EN50564:2011 requirements are exceeded, but the PA900 does not stop a low power measurement nor otherwise prevent the user from recording the final measurement result.

You do not have to remain on the STBY POWER screen during the measurement. The measurement will automatically progress whether this screen is being displayed or not.

The measurement hold capability of the PA900 is not applied to the STBY POWER results.

The following data is shown in each of the results areas on this screen, listed in order from top to bottom in each area. Except for the total measurement time, all data is for the last 2/3<sup>rd</sup> of the measurement time if configured for EN50564 5.3.2a method or for the entire measurement time if configured for the 5.3.2d method. You can select which channel within the selected VPA is being viewed by using the CH n button (which is labelled according to the presently selected channel). This does not affect measurements, only the data being displayed.

#### 17.1.3.1 TIME RESULTS AREA

1. The elapsed total time of the low power measurement.
2. "WAITING" (if waiting for the configured START power level to be exceeded when configured for the 5.3.2d method), "RUNNING" (when less than the minimum test time), "EXTENDING" (if beyond the minimum test time), if manually stopped then it shows "STOPPED", and if automatically completed it shows "COMPLETED".
3. The average actual measurement sampling period.

#### 17.1.3.2 POWER RESULTS AREA

1. The average power (in Watts).
2. The range of power encountered.
3. The slope of the linear regression in W/hour (only shown if configured for the 5.3.2a method).

#### 17.1.3.3 VOLTS RESULTS AREA

1. The average AC+DC RMS supply voltage.
2. The range of AC+DC RMS supply voltage encountered.
3. The range of AC+DC RMS supply frequency encountered.
4. The highest supply voltage THD (measured over the 2<sup>nd</sup> through 13<sup>th</sup> harmonics) encountered. This is colored RED if this exceeds the requirements of EN50564:2011 (the screen shown above gives an example of this occurring).
5. The range of supply voltage crest factor (CF) encountered. This is colored RED if this exceeds the requirements of EN50564:2011.

#### 17.1.3.4 AMPS RESULTS AREA

1. The average AC+DC RMS load current.
2. The range of AC+DC RMS load current encountered. This is colored RED if this exceeds the capabilities of the PA900 during the last 2/3<sup>rd</sup> of the measurement time.
3. The highest load current crest factor (CF) encountered.
4. This data is not required by EN50564:2011 but is included for informative purposes.

#### 17.1.3.5 PF RESULTS AREA

1. The average AC+DC PF.
2. The range of AC+DC PF encountered.
3. This data is not required by EN50564:2011 but is included for informative purposes.

#### 17.1.3.6 UE RESULTS AREA

1. The average Ue (PA900 watts measurement error).
2. The range of Ue (PA900 watts measurement error) encountered. This is colored RED if this exceeds the requirements of EN50564:2011.

Note:

To ensure strict accordance with EN50564:2011 para. 4.4 during the measurement the PA900 maintains a record of the Ue (power measurement accuracy) as defined by EN50564:2011 para. 4.4.1. The measurements are maintained in real-time during the measurement, dynamically applying the MCR correction on the limit as required by EN50564:2011 para. 4.4.1.

If the correct ADJUST setting is used, the error of performing this adjustment is included in the reported Ue figures, so Uw in EN50564:2011 D.1.2 may be ignored when you report results unless there are significant wiring losses.

#### 17.1.3.7 WATTS MEASUREMENT GRAPH

Below the numerical data a chart graphically shows every sampled power (in watts) vs. time during the entire measurement.

---

#### 17.1.4 RECORDING STBY POWER DATA

The method for performing this is fully described in section 23.

If generating a report which is in strict conformance to the requirements of EN50564:2011 para. 6 then this can be achieved by simply exporting an image of the STBY POWER screen after the completion of the measurement and including it in a report along with the additional (non-measurement related) requirements of EN50564:2011. This exceeds the requirements of EN50564:2011 and includes many of the additional recommended features.

Briefly, this is performed by –

1. Insert the drive into the front panel USB port and wait for it to be READY.
2. Display the screen to be recorded.
3. Press the DRIVE INFO area of the screen, the screen shows the file export/import screen.
4. Press the SCREEN IMAGE button. The screen changes to allowing you to enter a file name.
5. Enter the desired file name (the extension is automatically provided).
6. If the file already exists then you are prompted to respond if you wish to overwrite it or not.
7. The file is then written.

## 18 TESTING COMPLIANCE TO HARMONICS EMISSIONS STANDARDS

The PA900 can perform EUT testing for full compliance to EN61000-3-2 or EN61000-3-12 mains supply harmonics emissions standards. The method by which you may perform this is described in this section.

The standards referenced in this section are licensed, copyrighted material and cannot be reprinted, even in part, in this manual. Throughout this section it is assumed that you have access to the applicable standards.

It is assumed in this section that you are conversant with the general operating methods used in the PA900 as described in section 12 of this manual.

Note:

Making a compliance assessment of a EUT to the requirements of EN61000-3-2 or -12 can only be performed from the front panel of the PA900 and does not require the use of a computer. The assessment results can be recorded to a USB drive attached to the PA900 in the commonly used textual CSV format, and any screen images can also be saved in BMP format for recording purposes. This USB drive can then be transferred to a computer and a report document generated by you as needed. If preferred, the PA900 may be configured for EN61000-4-7 measurements by configuring the measurement mode of the PA900 to either EN61000-3-2 or -12 and the measurements can be obtained via an interface which allows you to perform compliance testing via an interface with suitable computer software which implements the assessment requirements (Vitretek does not provide such software).

In some situations you may be required to make measurements of results such as THC without actually performing an assessment of the EUT. Generally this is a requirement in the standards which is to be performed by a EUT manufacturer to predetermine the EUT conditions under which to provide formal assessments of the EUT undertaken by a testing agency. In these situations you should configure the PA900 for the applicable measurement mode (EN61000-3-2 or -12) and use the HARMONICS screen to view the actual "real-time" THC measurement result while changing the EUT conditions. You can record this result by saving an image of the applicable HARMONICS screen from the PA900 to a USB drive, which also contains the actual harmonics. You should also consider that the supply source and wiring between the supply source, PA900 and the EUT may affect these results so generally should be in accordance with the standard requirements. In these situations only sections 18.1.2 and 18.2 may have relevance to you.

When configured for EN61000-3-2 or -12 measurement modes the majority of the functions and measurement availability in the PA900 are unchanged. The changes, necessary as a result of the requirements of EN61000-4-7, are as follows-

- The fundamental frequency range, the measurement bandwidth, the measurement period, the number of harmonics, and the response filtering are all set according to EN61000-4-7 and cannot be altered.

- DC ONLY coupling is not available.

- The FREQ SPEED preference setting is ignored.

- The 3 $\phi$ 3w(2ch) WIRING configuration is not available.

- The method of making harmonics measurements is as defined by EN61000-4-7; the specifications for harmonics in 30.2 of this document do not apply.

- Harmonics are not available for Watts or for inter-channel Voltages.

- Harmonics phase for other than the 1<sup>st</sup> harmonic (i.e. the fundamental), and the current 5<sup>th</sup> harmonic when EN61000-3-12 is configured, are not available. When available, the current 5<sup>th</sup> harmonic phase is relative to the voltage fundamental rather than to the current fundamental as it is usually reported by the PA900.

- Certain PA900 activities can be performed while in these modes but must not be performed while an assessment is in progress-

  - The measurement mode must not be changed.

  - The channel content of VPA1 must not be changed.

  - The Internal and External DC Zero capability in the SYS CONFIG screen must not be used.

  - A scope capture using the INRUSH Capture Mode must not be performed.

### 18.1 STANDARDS COMPLIANCE

When performing assessment testing to the requirements of the EN61000-3-2 and -12 you are often performing a legal regulatory requirement. As such you may need to be in possession of justification showing that the measurement results are compliant. This section assists you with that justification and also provides information which may be of general use to you regarding these assessments.

#### 18.1.1 RELEVANT STANDARDS

The PA900 can be configured and perform assessment testing to either of the following standards-

- EN61000-3-2:2014. *Limits for harmonic current emissions (equipment input current  $\leq$  16A per phase).*

- EN61000-3-12:2011 (with corrigendum Oct. 2013). *Limits for harmonic currents produced by equipment connected to public low-voltage systems with input current  $>$  16A and  $\leq$  75A per phase.*

Both of these standards have normative references (Annex B of EN61000-3-2 and clause 7.2 of EN61000-3-12) requiring that the measurement equipment (i.e. the PA900) meet the measurement requirements of EN61000-4-7. The PA900 is compliant as a Class 1 device to the following standard-

- EN61000-4-7:2002 + A1:2009 with corrigenda Aug. 2004, May 2005 and Nov. 2011. *Testing and Measurement Techniques – General guide on harmonics and interharmonics measurements and instrumentation, for power supply systems and equipment connected thereto.*



Note:

The PA900 is capable of performing measurements to the requirements of EN61000-4-7, and performing assessments of a EUT to the requirements of EN61000-3-2 or -12, only when configured to do so.

In the future there may be later versions of these standards and those later versions will have differences which may affect assessment testing to those standards using the PA900. You are recommended to contact Vitrek should this occur to determine if any action needs to be taken in this regard, generally the PA900 can have field installed firmware upgrades which may be needed to accommodate such future changes to these standards. At this time, there are no hardware aspects of the PA900 which are foreseen as limiting the ability to accommodate changes in the standards, however that cannot be guaranteed as it cannot be foreseen what future changes may be made. Vitrek cannot be held liable in any manner for future changes to standards.

The assessment contained in the PA900 assumes that the normative references in EN61000-3-2 and -12 only require that the measurements be compliant with EN61000-4-7, and the portions of EN61000-4-7 which are either not measurement related or are additional measurements not used by EN61000-3-2 and -12 are not relevant.

Throughout this section of the manual, and within the assessment contained within the PA900, it is assumed that when a "primary" level standard (such as EN61000-3-2 or -12) call for a "secondary" level standard (such as EN61000-4-7), and both standards contain conflicting overlapping requirements, then the industry norm is applied that the primary standard overrides the secondary standard. It should also be noted in this regard that the EN61000-3-2 and -12 standards also post-date the EN61000-4-7 standard. For example-

Both the primary standards (EN61000-3-2 and -12) and the secondary standard (EN61000-4-7) contain explicit but overlapping and inconsistent requirements for the supply voltage to the EUT, the wiring to the EUT, and the impedance of the current sensor in the PA900. In so far as this occurs, the requirements of the primary standards (EN61000-3-2 and -12) have been assumed in the PA900 and in this document.

---

## 18.1.2 SUPPLY, PA900 AND EUT WIRING

Both EN61000-3-2 and -12 contain requirements on the wiring between the supply source and the EUT, including the PA900 current measurement. You must ensure that the supply source and the wiring meet these requirements.

In EN61000-3-2 see Figures A.1 and A.2

In EN61000-3-12 see clause 7.2 and note that the impedance of this wiring forms part of the calculations regarding the value of  $R_{sce}$  which is defined and referenced in many clauses of EN61000-3-12.

### 18.1.2.1 PA900 VOLTAGE CONNECTIONS AND THE ADJUST SETTING

The wiring used for the voltage terminal connections carry very little current and are not covered by any standard requirements. This wiring only needs to have sufficient insulation rating for the voltage being carried and impedances as high as several ohms have virtually no effect on the measurement results.

EN61000-3-2, -12, and EN61000-4-7 all require that you connect the voltage terminals of the PA900 across the voltage supply directly at the EUT. The PA900 allows you to do this, and if you have done so the PA900 also allows you to adjust the measured current to that of just the EUT by correcting the apparent current signal for the current drawn by the voltage terminals of the PA900, this is selected by selecting a ADJUST setting of LOAD(V@LOAD) in the MEAS CONFIG screen.

Note:

For the ADJUST settings other than NONE, the setting is shown in two parts-

The 1<sup>st</sup> part (LOAD or SRCE) defines where the results are to be shown for. In these cases it is always the EUT load which is required so only the LOAD selections are applicable.

The 2<sup>nd</sup> part (V@LOAD or V@SRCE) defines where the voltage measurement is connected to. If connected to the supply source then V@SRCE should be selected, otherwise the voltage measurement is connected to the EUT so V@LOAD should be selected.

Recommendations:

For EUT loads of over 1Arms per phase you should follow the standards and wire the voltage measurements to the voltage supply at the EUT and also you should use the LOAD(V@LOAD) ADJUST setting.

For EUT loads between 0.05Arms and 1Arms per phase you are recommended to use whichever wiring method is the most convenient for you and select the applicable LOAD(V@LOAD) or LOAD(V@SRCE) ADJUST setting. At these power levels, for a single phase supply and EN61000-3-2 testing, it may be more convenient to use the LPA-1 adaptor available for the PA900 (which is wired with the V terminals on the supply side) and use a ADJUST setting of LOAD(V@SRCE). If you use the voltage measured at the supply source method then you must ensure that the wiring to the EUT (including the PA900 current shunt) is less than 0.1 $\Omega$  (which is usually easily achieved).

For a EUT loads of below 0.05Arms per phase it is highly recommended to use the V terminals connected to the supply source method (which includes the LPA-1 adaptor) as it provides superior accuracy assuming that the wiring between the supply source and the EUT (including the PA900 current shunt) is less than 1 $\Omega$  (which is usually very easily achieved). The NONE ADJUST setting is recommended but LOAD(V@SRCE) can also be used.

#### 18.1.2.1.1 Multi-Phase Supplies without a Neutral

When using a multi-phase supply with no neutral, EN61000-4-7 suggests using an artificial neutral resistive network to produce the common voltage measurement reference point, this is not necessary with the PA900 as the voltage terminal impedance itself effectively provides such a network.



---

### 18.1.3 REPEATABILITY REQUIREMENTS

Both EN61000-3-2 and -12 require that an assessment meet a repeatability requirement. For EN61000-3-2 this is contained in clause 6.2.3.1 and in EN61000-3-12 it is contained in clause 4.2.3. In both cases it is required that better than 5% of the limit is achieved in the repeatability of measurement of average individual harmonic currents, but it is stated in the standards that this is not a requirement for assessment, but is a requirement for the selection of the assessment time.

The repeatability of the PA900 itself is far beyond these requirements in general so is not a determining factor; the primary determining factors being the repeatability of the supply source, the repeatability of the EUT harmonics themselves, and the test time used for assessment.

Recommendation:

You must configure a test time suitable for the EUT which allows you to achieve this level of repeatability. See table 1 of EN61000-3-12 or table 4 of EN61000-3-2 for some guidance regarding this.

The PA900 enforces no minimum assessment time other than 1 second. For a stable EUT and a stable supply source the standards provide no minimum assessment time as long as it is *“of sufficient duration to meet the requirements for repeatability”*. If the EUT and supply source can meet this requirement with a 1 second assessment time, then such a time may be used, however you must ensure that the 1.5 second filtering required by the standards has fully settled prior to starting an assessment so the EUT must have been powered and stable for at least 10 seconds prior to starting the assessment, the PA900 does not enforce this.

As stated in note 3 of figures A.1 and A.2 of EN61000-3-2 you may need to use a supply source which significantly exceeds their stated requirements in order to meet the repeatability requirement with some EUTs. Although these notes suggest an increased requirement for supply voltage stability, experience has shown that this also extends to waveform shape repeatability.

With some EUTs you may need to decide whether the repeatability requirement is applicable to some or perhaps to all harmonics. There are primarily two situations where this may be appropriate-

Some EN61000-3-2 class C devices with low power levels are unlikely to enable you to meet this requirement for any reasonable assessment time, primarily because there is no minimum current level stated for the repeatability requirement as it is presently worded in EN61000-3-2.

If reporting an assessment of a EUT which is failing the assessment then some harmonics measured may be very significantly higher than the limit, resulting in an unnecessarily small percentage of the measurement as the repeatability requirement as it is presently worded in EN61000-3-2 (also in EN61000-3-12 but in practice this situation is far less likely for that standard).

---

### 18.1.4 EUT CLASSIFICATIONS AND LIMITS SELECTION

For both EN61000-3-2 and -12 the PA900 does not decide which classification a EUT falls into and which limits table to apply. It is your responsibility to select the correct classification and/or limits table to apply when assessing a EUT following the guidelines of each standard and taking into account the features of the specific EUT.

When an assessment is made the PA900 takes and records internally all measurements required, and all supply voltage and measurement testing is performed, in order to make an assessment result available for any classification in EN61000-3-2 or for any limits table within EN61000-3-12. This means that you can freely make an assessment, and then check the results of that assessment afterwards to any of the classifications (but not changing between standards). This also extends to the entry of reference levels for current, watts, and PF which may be required for some classifications, and the nominal Unom and Fnom entries, and the Rsce entry; all of these may be changed freely after an assessment without requiring that a new assessment be performed. This process is called “reassess” in the PA900; basically it is reassessment of measurement results already obtained from a prior assessment.

Recommendation:

When there is doubt regarding which classification or limits table to use it is recommended that an assessment be performed to the desired standard, initially to any classification, and that you subsequently generate separate reports for each possible classification which you decide upon. With the PA900 there is no need to repeat the entire assessment process to accommodate this.

You might consider making it your general practice to generate a final assessment report which contains the assessment of the EUT to all classifications (or just to those which the EUT passes). This gives the benefit of removing any doubt regarding whether the correct classification was chosen for a EUT and may help should later versions of EN61000-3-2 result in a change of classification of the EUT (as stated in clause 5 of EN61000-3-2 this may occur in the future). By pre-assessing a EUT against each classification you are already prepared for such future changes.

#### 18.1.4.1 EN61000-3-2 CLASSIFICATIONS AND LIMITS TABLE SELECTION

The PA900 performs assessments denoted using the same classifications of EUT for classes A, B and D as defined within EN61000-3-2. However EN61000-3-2 sub-classifies EUTs within its’ Class C classification into four sub-classes, within the PA900 these are denoted as follows-

**Class C(tbl2):** the sub-class defined by the first paragraph of clause 7.3a) of this standard.

**Class C(tbl1):** the sub-class defined by the second paragraph of clause 7.3a) of this standard.

**Class C(tbl3):** the sub-class defined by the first set of requirements in clause 7.3b) of this standard.

**Class C(spcl):** the sub-class defined by the second set of requirements in clause 7.3b) of this standard.

By accommodating this expanded definition of Class C along with classes A, B and D, the table within EN61000-3-2 defining the limits to be used for a EUT is thus explicitly defined and selected by the PA900.

Recommendation:

The PA900 provides you with assistance in choosing the classification of a EUT by giving the range of Watts measurements encountered during the assessment; this along with other details available to you regarding the EUT can then be used to allow you to select the classification to use.

According to EN61000-3-2, Class C(spcl) only applies to a EUT having a specific current waveform which has a specific shape and has a specific phase relationship to the voltage waveform (see figure 2 and clause 7.3b in EN61000-3-2). The PA900 does not check that the current waveform meets this requirement and so this is your responsibility, it is recommended that you capture the current waveform in some fashion and check its shape and phase relationship and report those findings in your final assessment report to support selecting class C(spcl). In general, selection of class C(spcl) is not recommended and selection of class C(tbl3) is recommended for such a EUT if possible.

#### 18.1.4.2 EN61000-3-12 LIMITS TABLE SELECTION

The PA900 performs assessments according to EN61000-3-12 using the tables 2, 3, 4 and 5 as defined in that standard. It is your responsibility to choose the table to apply.

Note:

The PA900 provides you with assistance in choosing the classification of a EUT by giving the range of current measurements encountered during the assessment for each phase which then allows you to decide if the EUT is a “balanced load”. The definition of balanced load requires knowledge of whether the EUT was designed to have identical phase loading, and if measurements are used then the word “identical” is probably too narrow as no two measurements are ever “identical”.

The PA900 also provides you with assistance in choosing tables 4 and 5 as these rely on the EUT meeting certain conditions during assessment, entitled ‘a’, ‘b’, ‘c’, ‘d’, ‘e’ and ‘f’ in EN61000-3-12 clause 5.2, by reporting whether conditions ‘a’, ‘c’, ‘d’ and/or ‘f’ are met. The PA900 cannot assist with whether conditions ‘b’ or ‘e’ are met (which are actually both the same condition) as these depend on knowledge which cannot be obtained from measurements but are dependent on “*the design of the piece of equipment*”.

The PA900 also provides you with assistance in choosing which table to use for a “hybrid” EUT by detecting if circumstance ‘a’ applies as defined in EN61000-3-12 clause 5.2. The PA900 cannot assist with circumstance ‘b’ for “hybrid” equipment as that is dependent on “*the construction of hybrid equipment*”.

#### 18.1.4.3 EN61000-3-12 RSCE VALUE SELECTION

Assessment of a EUT to EN61000-3-12 requires a reference value entitled “Rsce” in EN61000-3-12. For all table selections, the selection of a Rsce value is critical to the pass/fail result of the assessment and EN61000-3-12 contains the methods for you to use to derive its value and also to ensure that the test wiring, current measurement resistance, and supply source resistance are applicable for a given Rsce value.

Generally, a Rsce value of 33 may be applied (which is then generally acceptable for the EUT to be used on all supplies), but often a EUT will not meet this requirement so a higher Rsce must be selected by you which allows the EUT to meet the requirements but restricts the final use of the EUT only to certain supplies.

The PA900 assists with this by allowing you to either-

- a) Configure a zero value for Rsce, in that case the PA900 automatically provides the lowest value for Rsce for which the assessment results in a passing status for all supply phases (if possible)
- b) Change the configured Rsce value manually and reassess the measurements without actually repeating the assessment itself.

Reassessing the previous assessment measurements in this manner may not be definitive as a changed Rsce value may affect the requirements for supply source and the wiring used to perform the assessment, so it may be necessary to actually repeat the entire assessment to resolve a final Rsce value which is acceptable if the initial assessment was run with wiring etc. assuming a lower Rsce value.

---

### 18.1.5 RANGE OF PA900 MEASUREMENTS FOR COMPLIANCE

It is often accepted without question that an EN61000-4-7 Class 1 compliant measurement device such as the PA900 meets the measurement requirements of EN61000-3-2 and -12. This is actually not the case in practice; the repeatability and reproducibility requirements contained in EN61000-3-2 and -12 far exceed the accuracy requirements for a Class 1 device defined by EN61000-4-7, and the Class 1 accuracy requirement in EN61000-4-7 does not guarantee that the measurement equipment even has sufficient accuracy to assess a EUT to within the limits stated in EN61000-3-2 or -12.

The range of measurements specified below for the PA900 include the requirements for Class 1 of EN61000-4-7, the repeatability and reproducibility requirements of EN61000-3-2, and the repeatability requirements of EN61000-3-12, all with a minimum of a 4:1 margin which is the industry norm for measurement uncertainty, and are valid throughout the operating environment range specified in section 25.2 of this manual when the PA900 is using its internal current shunts. If using external current shunts then see section 18.1.5.1 for further details, depending on the specifications of the external current device the range of currents, power and power factor specified may be different when using external current devices.

When configured for EN61000-3-2 or -12 measurements, the PA900 is guaranteed to exceed the requirements of the above listed standards within the following ranges of measurements (this specification replaces all other relevant accuracy specifications contained in section 28 of this manual for assessment results purposes only)-

**Frequency:** Any frequency in the range 45-54Hz or 56-65Hz (assessment using frequencies in the range 54-56Hz is possible but not recommended).

**Voltage:** Any phase voltage in the following range for each channel type (the current option does not affect the ranges allowed)-

A or S channel type: 75-700Vrms.

W channel type: 75-600Vrms.

**Voltage Crest Factor:** Solely limited by a maximum peak voltage of 1750Vpk.

**Current and Current Crest Factor:** Any current in the following range for each current option (the channel type does not affect the ranges allowed)-

H current option: 3mA-30Arms. Crest factor limited to the lower of 100 or a maximum peak current of 200Apk.

D current option (HI range selection): 2.5mA-20Arms. Crest factor limited to the lower of 100 or a maximum peak current of 150Apk.

D current option (AUTO range selection): 0.7mA-20Arms. Crest factor limited to the lower of 100 or a maximum peak current of 150Apk.

D current option (LO range selection): 0.7mA-0.265Arms. Crest factor limited to the lower of 100 or a maximum peak current of 1Apk.

Note that EN61000-3-2 disregards all harmonics <5mArms in applying assessment limits (see clause 6.2.3.4), so in practice it is reasonable to assume that there is no requirement to assess EUTs with an RMS load current <5mA as in that case all the harmonic assessment results would be disregarded.

**Total Power Factor:** Any total power factor in the range 0.0001-1.0.

**Fundamental Power Factor:** Any fundamental power factor in the range 0.01-1.0 (for EN61000-3-2 classes C(tbl3) and D only, there is no fundamental power factor range limitation for the other classes or for EN61000-3-12).

**Power:** Only limited by the voltage, current and power factor limitations stated above.

### 18.1.5.1 EXTERNAL CURRENT MEASUREMENTS

The use of external current devices with a PA900 for any EN61000-3-2 compliance testing is not needed and should not be used (unless the current option in the PA900 is X).

#### 18.1.5.1.1 Using External Current Shunts

If necessary for EN61000-3-2, and as is often needed for EN61000-3-12 to accommodate its current requirements, the use of external shunts in combination with the X current option in the PA900 is recommended.

The requirements for external shunts, when needed for compliance with EN61000-3-2, -12 and EN61000-4-7 standards, are as follows-

The resistance of the shunt must be such that the RMS voltage across the shunt is <0.15Vrms at the maximum expected current draw of the EUT. This is a requirement of EN61000-4-7 clause 5.1, however that requirement may be considered to be overridden by both EN61000-3-2 and -12 as discussed in section 18.1.1.

The power handling capability of the shunt and its ability to dissipate heat in your use of it must be such that there is less than 1% difference between its value at low currents and that at the maximum expected EUT current.

The inductance of the shunt must be <10nH per mΩ resistance of the shunt. Note that resistors which are claimed to be "non-inductive" always have some inductance so you should consult the shunt resistor data sheet for a maximum inductance value; if none is available then the shunt should not be used for this purpose. "Classical" DC shunts generally do not meet this requirement, the use of "folded" or coaxial shunts is recommended. You should also consider that since shunt inductance will always increase the measurement results for high order harmonics, so if the EUT is passing the requirements with the shunt being used then it would also pass (possibly with a wider margin) with a "perfect" shunt.

The routing of the voltage sense wiring from the shunt to the PA900 should be such that it alters the apparent impedance of the shunt at 2kHz by less than 1%. This generally means that the voltage sense wiring must be a closely twisted pair (not a coaxial cable) of thin gage wires (26awg or thinner is recommended) and that it is routed at right-angles to the current carrying wiring for a distance of at least 1 foot from the shunt and its current carrying wiring. The routing of the wiring is very dependent on many factors, some experimentation should be expected. Generally you can detect if the wiring is a problem by simply changing it and noting any changes to the very high order harmonics measurements, but this assumes that the load has sufficient such harmonic content and that it is not also affected by the changes to the wiring routing. You should note that this effect can either raise or lower high order harmonic measurements, so can cause false passing or failing indications on a EUT.

You should consider the operating environment of the shunt. Low resistance shunts typically have a high temperature coefficient of resistance which will limit their ability to be used with accuracy in a poorly controlled environment.

The shunt must be mounted and protected such as to maintain a safe environment. The shunt is operating at an unsafe voltage so you must ensure that there is sufficient mechanical shielding to ensure that objects such as defined by EN61010-1 cannot touch any live voltage part of the shunt.

#### 18.1.5.1.2 Using External Inductive Type Current Transducers

External inductive type current transducers such as coil or hall-effect types are generally not recommended as few meet the requirements. There are a few such devices which do meet the requirements however, so may be carefully considered. The important features of such a device are-

**Accuracy.** An overall accuracy of 1% (after calibration of the input:output ratio) is required. You should also consider the reliance of the device on the position of the current carrying wire within its aperture; often this is a substantial effect at these accuracy levels.

**Distortion.** This is often the dominant factor in deciding on a device. EN61000-4-7 requires that harmonics measurements be made to within 0.15% of the fundamental at each harmonic up to the 40<sup>th</sup>, so it is recommended that the device have at least twice this level of performance as typically there are other effects which are not apparent when initially choosing such a device. Note, however, that the limits allowed for harmonics in EN61000-3-12 are much larger than this and so you should also consider whether using lower performance transducers than this might be applicable.

Phase shift and frequency response. If the device has a poor phase shift specification at 50/60Hz then it usually has a poor frequency response at 2kHz. The difference between the input:output ratio at 2kHz to that at 50/60Hz should be <1%.

## 18.1.6 COMPLIANCE TESTS PERFORMED BY THE PA900 DURING ASSESSMENT

The following tests are performed by the PA900 to ensure that EUT assessment is performed in a manner compliant with the standards.

### 18.1.6.1 TESTING THE SUPPLY VOLTAGE FOR COMPLIANCE

With the PA900, you may use any voltage source having suitable power sourcing capabilities. However it should be noted that the local mains supply is often not suitable, particularly for EN61000-3-2 assessments.

In accordance with the requirements of EN61000-3-2 and -12 the supply voltage is continuously checked by the PA900 throughout the assessment of the EUT as follows. Note that although some tests are not required for some EUT classifications, the PA900 always performs all of the tests, the EUT classification only affects whether the results of these tests are visible to you.

**Voltage:** Each voltage is checked that it remains continuously within a  $\pm 2\%$  range of the user specified nominal voltage ( $U_{nom}$ ) as specified by EN61000-3-2 clause A.2a and -12 clause 7.2b.

**Frequency:** The supply frequency is checked that it remains continuously within a  $\pm 0.5\%$  range of the user specified nominal frequency ( $F_{nom}$ ) as specified by EN61000-3-2 clause A.2a and -12 clause 7.2b.

**Frequency Lock:** Short-term variations in the supply frequency are continuously checked that they remain within the  $\pm 0.03\%$  limit within every 200ms measurement period as specified by EN61000-4-7 clause 4.4.1 so is applicable to both EN61000-3-2 and -12 assessments.

In most countries the local mains supply does not meet this requirement. In addition some AC sources may have cycle-to-cycle jitter in excess of this requirement.

**Voltage Harmonics:** Each voltage is checked that it remains continuously within the specifications of EN61000-3-2 clause A.2c. For EN61000-3-12 it is your responsibility to check the voltage harmonics of each supply phase voltage when the supply is unloaded per clause 7.2d.

For EN61000-3-12 this can be performed using the PA900 HARMONICS screen but it is not part of the assessment process.

**Voltage Crest Factor:** Each voltage is checked that its crest factor remains continuously within a modification of the range specified by EN61000-3-2 clause A.2d, see below for a description of the modification to EN61000-3-2 requirements used by the PA900 in this regard. EN61000-3-12 contains no such requirement and crest factor is not checked when assessing a EUT to that standard.

The crest factor of a pure, noiseless, sinewave is  $1.414214 (= \sqrt{2}$  to 7 significant figures) and if the EN61000-3-2 stated allowable range of 1.40 to 1.42 is taken strictly (assuming that all unstated digits are zeroes) then this stated range only allows 0.4% for the total noise (always increases CF) + amplitude modulation (always increases CF) + any distortion content which results in an increase in the crest factor, this may be overly restrictive in practice. In the PA900 it is assumed that the intention of the standard is to define a  $\pm 0.01$  range centered on the nominal value for a pure sinewave (instead of the 1.41 value as stated) so the actual allowed range for supply voltage crest factor as checked by the PA900 is from 1.404214 to 1.424214 (to 7 significant figures). It should be noted that EN61000-4-7 clause 5.4.2.2d, although overridden in this regard by EN61000-3-2, states a required range of 1.404 to 1.424.

There is no definition of any bandwidth required for this measurement in either of these standards, for example a 100GHz measurement bandwidth would certainly not result in a suitable application of this limit. So it is assumed that a "reasonable" limit should be used and the PA900 uses a 20kHz bandwidth limit for this measurement.

**Phase of Voltage Peaks:** Each voltage is continuously checked that the phase position of both positive and negative peaks are  $\pm 90^\circ \pm 3^\circ$  as specified by EN61000-3-2 clause A.2d. EN61000-3-12 contains no similar requirement and the peak phase position is not checked when assessing a EUT to that standard.

There is no definition of any bandwidth required for this measurement, for example a 100GHz measurement bandwidth which could detect a noise pulse as short as 5ns would certainly not result in a suitable application of this limit as the  $3^\circ$  range only allows for a small amount of voltage noise, particularly since every supply cycle within the assessment period must meet this limit so even a very low probability noise event will cause a failure of this requirement. So it is assumed that a "reasonable" bandwidth limit should be used and the PA900 uses a 5kHz bandwidth limit for this measurement, but it should be noted that almost any such bandwidth restriction results in a delay which varies with the frequency content and exact shape of the noise pulse, as is the case for the PA900, and this delay may result in the  $3^\circ$  range requirement having limited meaning in practice.

**Inter-phase Voltage Phasing:** The phase difference between every phase pair of a multi-phase supply is required to be within  $\pm 1.5^\circ$  of  $120^\circ$  throughout the assessment period according to the requirements of both EN61000-3-2 clause A.2b and -12 clause 7.2c. The PA900 continuously checks this throughout the assessment if WIRING is configured for 3 $\phi$ 3w(3ch) or 3 $\phi$ 4w.

Recommendations:

The PA900 neither stops the assessment, nor prevents an overall assessment pass/fail result of the EUT harmonics emissions if any of these supply voltage tests fail. A separate indication is used denoting which (if any) of these tests fail. Should any of these failures be detected (particularly Voltage Crest Factor and Phase of Voltage Peaks) then you are recommended to reach a decision whether to-

- a) Ignore the failure. This is a possibility if the EUT results indicate that it meets the harmonics requirements with a high margin, particularly since in practice the presence of such supply failures would normally result in higher



harmonic emissions results (in particular, a high voltage crest factor, an unlocked frequency, or a peak phase position error caused by noise rather than distortion). If such a decision is reached, then it is recommended that you record this in your test report along with a rationale for ignoring the failure.

- b) Or, repeat the assessment. In some cases these failures may be transitory in nature; there may be a reasonable possibility that simply repeating the test would not have the same supply voltage failure. If such a decision is reached and it results in a successful assessment, then it is recommended that you record this in your test report along with a rationale for repeating the test however there is no requirement to do so.
- c) Or, independently assess whether the supply voltage failure was significant or not. If such a decision is reached, then it is recommended that you record this in your test report along with a rationale and the results of the independent test.

### 18.1.6.2 TESTING THE PA900 MEASUREMENTS FOR COMPLIANCE

In accordance with the requirements of EN61000-4-7 clauses 5.1 and 5.2 the measurements made by the PA900 are continuously checked by the PA900 throughout the assessment of the EUT as follows-

**Current Overload:** Each phase current is checked for both peak (i.e. possibly transitory) and RMS (i.e. probably significant) overloads during the entire assessment period. Peak and RMS overloads are separately indicated.

**Voltage Overload:** Each phase voltage is checked for both peak (i.e. possibly transitory) and RMS (i.e. probably significant) overloads during the entire assessment period. Peak and RMS overloads are separately indicated.

Note:

If an overload is detected then this is indicated as part of the assessment but does not affect the indicated assessed pass/fail result of the EUT. If an overload is indicated then you should decide whether or not to accept the assessment.

Recommendation:

Generally if an overload indication is shown then the final pass/fail assessment of the EUT should be disregarded and the assessment repeated with the PA900 current range reconfigured such that no overload will occur. If a voltage overload is shown then there is something seriously wrong with the supply voltage and it should be investigated.

## 18.2 CONFIGURING THE PA900 FOR EN61000-3-2 OR -12 MEASUREMENTS

This is achieved by using the MEAS CONFIG screen as follows-

1. Access the MEAS CONFIG screen by pressing the MEAS CONFIG button on the right side of the PA900 screen.
2. Press the MEAS MODE button and select the EN61000-3-2 or EN61000-3-12 choices as applicable.
3. Configure the channels which you wish to use as needed (see section 12.4.2.1).
4. None of the MEASURE area buttons are usable, they indicate the configuration for measurements suitable for compliance testing and they are not changeable.
5. In the DATA area-
  - a. Select either the AC ONLY or AC+DC COUPLING selections by pressing the COUPLING button and selecting the choice desired. Note that EN61000-3-2 and -12 have no restrictions on this setting; however EN61000-4-7 recommends that measurements be AC ONLY although it does allow AC+DC measurements.
  - b. The RESPONSE setting cannot be altered as it is set by EN61000-4-7 to a single order 1.5 second response filter.
  - c. The DIGITS setting allows you to select how many digits of resolution will be displayed for numerical results on most of the results screens. A selection of 5 is recommended.
  - d. The ADJUST setting may be set as described in section 12.4.2.3.4. As previously discussed for EN61000-3-2 and -12 measurements generally the LOAD(V@LOAD) setting is used with the V terminals connected to the voltages at the EUT, however any of the other settings may be used as long as they do not differ from the V terminal wiring point and the SRCE(V@LOAD) and SRCE(V@SRCE) settings are not relevant as those configure the PA900 to make power measurements of the source, not that in the EUT.
6. If more than one channel is selected then a COMBINE area is shown which contains the WIRING button. This allows you select the wiring for the EUT and supply source. This setting is described in section 12.4.2.4.1, however note that for a 3 $\phi$ 3w EUT the 3 $\phi$ 3w(3ch) selection and wiring method should be used.

Selecting any other screen than the MEAS CONFIG screen will save this configuration, resulting in measurements to the requirements of EN61000-4-7 (and so to the selected EN61000-3 standard) being available almost immediately.

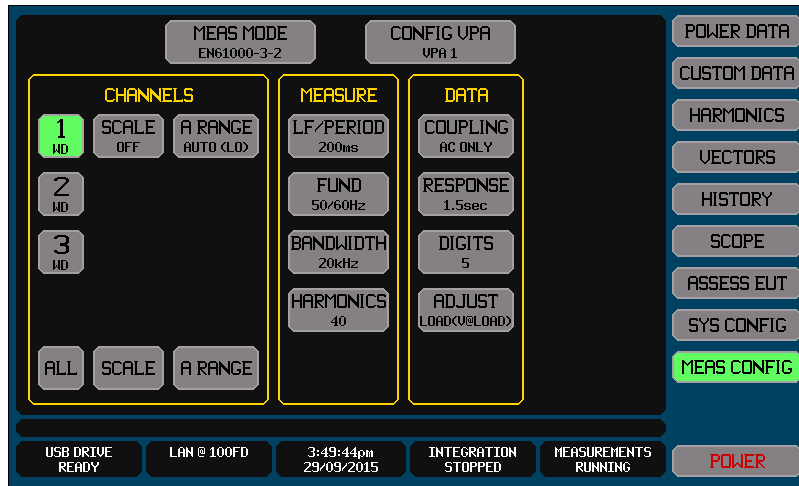

## 18.3 USING THE OTHER RESULTS SCREENS

Most of the other results screens available in the PA900 are also available, and are unchanged, when configured for EN61000-3-2 or -12 measurements, whether actually performing an assessment or not, they have no effect on the assessment being performed. See section 12 for full details regarding these screens. The HARMONICS screen has some changes however, as detailed below.

Note:

Holding measurements while performing an assessment also holds that assessment, continuing it once released.

### 18.3.1 USING THE HARMONICS SCREEN

The HARMONICS screen may be used in the normal fashion while configured for EN61000-3-2 or -12 measurements, but you can additionally select to check harmonics against the limits requirements of EN61000-3-2 or -12 (as configured). See section 12.7 for full details regarding using this screen.

Note:

A comparison against limits performed in this manner is not sufficient for EN61000-3-2 or -12 compliance assessment, but it may be used as a check that the instantaneous harmonics meet the basic requirements of those standards.

Any reference levels required to be used with the selected limits are those measured at that instant, and  $R_{sce}$  (for EN61000-3-12) is assumed to be 33.

This screen can be used to check the harmonic content of the supply source when unloaded, as required by EN61000-3-12. It can also be used to check the supply source prior to EN61000-3-2 assessment if desired.

This screen can be used prior to EN61000-3-2 or -12 assessments to adjust the settings on the EUT to determine the settings which result in the highest THC as recommended by the standard.

## 18.4 PERFORMING AN ASSESSMENT OF A EUT

This is performed by pressing the ASSESS EUT button which is only available when the PA900 is configured for EN61000-3-2 or -12 measurements.

The screen shown below shows what will be seen if the ASSESS EUT button is pressed when no prior assessment has been performed.



### 18.4.1 SELECTING THE CHANNEL TO VIEW RESULTS

The CH<sub>n</sub> (n can be 1, 2, 3 or 4) button allows you to select for which channel you are viewing the results of the last performed, or ongoing, assessment. Note that all channels are assessed at the same time; this selection only changes the channel for which the screen shows the results.

## 18.4.2 SELECTING HOW THE LIMITS REFERENCE(S) ARE OBTAINED

The second button from the left across the top of the screen (entitled MEAS REFS in the image shown above) allows you to select the method used to obtain the reference level(s) needed for setting harmonics limits. For EN61000-3-2 Class A and B this selection, although still present, is not needed as those use absolute current limits which are not dependent on any reference levels, all other classifications in EN61000-3-2 and all uses of EN61000-3-12 require this however.

Changing this selection has an immediate effect on the displayed assessment results.

Note:

The same reference levels are applied to the assessment of all phases of the EUT.

The reference levels only affect the limits applied, so do not affect the measurements made during an assessment. This allows you to change this selection at any time.

The Power Factor reference is different to the other references, as required by EN61000-3-2, in that a measured PF used as a reference is that obtained within the same measurement period as that for which a measured Amps reference is obtained. So the configured PF reference is only used if the configured Amps reference is used, and if a measured Amps reference is used then the PF reference is set to the PF present in the phase and at the time at which the Amps reference level was measured.

The available selections are-

**MEAS REFS.** When this is selected the reference levels as needed for the selected limits to be assessed are taken from those configured (see later for configuring the reference levels) and can be overridden by the maximum measured levels across all phases. As required by EN61000-3-2 and -12, if the maximum measured levels are within  $\pm 10\%$  of the configured levels then the configured levels are used by the PA900, otherwise the maximum measured levels are used by the PA900.

**USER REFS.** When this is selected the configured reference levels are used by the PA900, regardless of the measured levels.

**LAST REFS.** When this is selected the reference levels present at the time that this was selected are used for all future assessments until this setting is changed.

Recommendation:

In most situations MEAS REFS should be used. Only when indicated by the EN61000-3-2 or -12 standard should one of the other selections be used.

If you set zero for an Amps or Watts reference level and then assess the EUT using USER REFS then MEAS REFS will be used for that reference level.

EN61000-3-2 Class D EUTs assessed according to Annex C.16.2 require that the USER REFS selection be used and that the reference power be set by you according to the equation stated in that clause.

Generally, when the LAST REFS type of action is required, you should perform an initial assessment (usually with the EUT in its highest THC state) with this set to MEAS REFS and the assessment results recorded in the normal manner. Then you should select LAST REFS and perform additional assessments (with the EUT in differing states) as needed. For example, when performing the dimmed lamp tests EN61000-3-2 requires that the dimmed levels be tested to the same limits (i.e. the using the same reference levels) as used for the initial undimmed assessment.

## 18.4.3 CONFIGURING AND STARTING AN ASSESSMENT

The ASSESS button allows you to both configure and start an assessment of a EUT.

When pressed, a screen is initiated which allows to you to configure the assessment which will be performed. An example of this screen is shown below.

SECTION	PARAMETER	VALUE
SUPPLY (per phase)	VOLTAGE	230V
	FREQUENCY	50Hz
EUT DETAILS	EUT CLASS	CLASS D
	Wref	50W
ASSESSMENT TIMING	TEST TIME	2m:30s
	NUM INTERVALS	1
	AUTO START/STOP	OFF

### 18.4.3.1 CONFIGURING THE SUPPLY

The SUPPLY section allows you to configure values for the nominal supply voltage ( $U_{nom}$ ), the nominal supply frequency ( $F_{nom}$ ) and the  $R_{sce}$  value to use (if configured for EN61000-3-12 measurements, not shown above).

Note:

These settings may be changed either during or after an assessment if desired by pressing the REASSESS button as none of these affect the measurements made during an assessment



The Unom level which you should set is that for the phase voltage, not the inter-phase voltage.

With the exception of the Rsce value, the actual values entered do not change the assessment pass/fail result, they merely set the levels at which a supply error is raised if the measured voltage and/or frequency is beyond the allowed range from the entered nominal value.

As previously described in section 18.1.4.3, setting a zero value for Rsce allows the PA900 to automatically compute the Rsce value which would be needed for the EUT to have a PASS assessment status on all supply phases (if possible). However, you may be required to perform a second full assessment in this situation if the supply source and/or the EUT wiring do not meet the new Rsce value requirements. Unless you are using a supply source and EUT wiring which meets the requirements for all possible Rsce values then some iteration may be required.

#### 18.4.3.2 CONFIGURING THE EUT DETAILS

The EUT DETAILS section allows you to select the EUT classification and to set the reference levels for the limits selected according to that EUT classification. See sections 18.1.4.1 or 18.1.4.2 for details regarding the EUT classification selections.

Note:

These settings may be changed either during or after an assessment if desired by pressing the REASSESS button as none of these affect the measurements made during an assessment.

In most situations a zero value for any reference level is recommended, although the standards suggest that a manufacturer's value should always be used and reported even if it is not used in the final assessment result. Setting a reference level to zero forces the use of the maximum measured value encountered during the assessment as the reference level. See section 18.4.2 regarding how the reference levels which you configure may be overridden. The usage of reference levels is defined in the EN61000-3-2 and -12 standards, to summarize these-

A Watts reference is only used when EN61000-3-2 table 3 is selected and affects the limits for all harmonics.

An Amps reference level is only used for all EN61000-3-12 tables, for EN61000-3-2 table 2, and for the special variant of EN61000-3-2 Class C, and affects the limits for all harmonics. Note that the Amps reference level used by EN61000-3-12 is the Arms value and that for EN61000-3-2 is the fundamental current value. Also note that the Amps reference level for EN61000-3-12 assessments affects which harmonics are included in the THC and PWHC assessment measurements as well as affecting the limits applied.

A Power Factor reference level is only used for EN61000-3-2 table 2 and only affects the limit for the 3<sup>rd</sup> harmonic.

It is unclear from the EN61000-3-2 standard whether the Watts reference level should be that for the entire EUT or that of a single phase. You should resolve this in those situations where this may occur (those types of EUT which require a Watts reference level would rarely have multi-phase supplies). The PA900 assumes that this is the Watts reference for a single phase, if you decide that this is not the case then you should enter the total Watts and select for USER REFS to prevent it being overridden, and then manually check the measured Watts results shown by the PA900 to determine if the reference needs to be altered and if needed use the REASSESS button to change it (this does not require that the assessment measurement itself be repeated).

For EUTs assessed according to EN61000-3-2 Annex C.16.2 the Watts reference setting is as described in the equation contained in that clause (which results in a single phase Watts) and you should select for USER REFS to prevent it being overridden.

#### 18.4.3.3 CONFIGURING THE ASSESSMENT TIMING

The ASSESSMENT TIMING section allows you to select the timing to be used for the assessment, whether the assessment is to be performed in multiple intervals, and whether the assessment will also be affected by the EUT starting and/or stopping.

**TEST TIME:** This allows you to enter the time of an assessment or of an interval within the assessment. You enter the time in days, hours, minutes and seconds and this can be any value between 1 second and 99 days, 99 hours, 99 minutes and 99 seconds. Note that this is the time actually assessing the EUT, any time spent with the assessment paused is not counted towards this time.

In the data entry screen for TEST TIME there are four entries, one for each unit of days, hours, minutes and seconds.

The screen always starts with the days data selected; you can jump to any of the four entries directly by pressing the respective entry area.

You can enter a numeric between 0 and 99 into any of the four entries. The actual time used is the total time created by combining all four entries with their respective units.

When the ENT button is pressed the selected entry area automatically changes to next entry to the right, unless the seconds entry is selected when the action is same as pressing the RETURN button.

Recommendation:

This setting directly affects the repeatability of the assessment measurement results. You should carefully consider the value to use. See section 18.1.3 for further details regarding this.

The PA900 enforces no minimum assessment time other than 1 second. For some types of EUT Annex C of EN61000-3-2 does provide a minimum assessment time and/or a minimum interval time when multiple intervals are required, but for most EUT types the standards provide no minimum assessment time as long as it is "*of sufficient duration to meet the requirements for repeatability*". If the EUT and supply source are stable enough to meet this requirement with a 1 second assessment time, then such a time may be used, however you must ensure that the 1.5 second filtering required by the standards has fully settled prior to starting an assessment so the EUT must have been powered and stable for at least 10 seconds prior to starting the assessment, the PA900 does not enforce this and in general the EUT will actually require longer than this to stabilize.

**NUM INTERVALS:** This allows you to select that an assessment is to be performed in two or three intervals, each having an identical test time, with the assessment being paused between intervals until you press the CONTINUE button, or to be performed as a single interval.

Recommendation:

This is generally not required and so should be set to 1, but in EN61000-3-2 Annex C there are situations where this activity is required and so should be set to 2 or 3 accordingly.

**AUTO START/STOP:** This allows you to select any activities regarding when the EUT is started or stopped (i.e. draws significant power or draws little power). If set to other than OFF then there are additional settings available which allow you to enter the start/stop power detection level and the delay to use following a transition between start and stop (see below for details). The available selections are-

**OFF:** When this is selected the assessment always progresses and there is no detection of whether the EUT is started or stopped.

**DELAY ONLY:** When this is selected whenever the EUT power changes from above the detection level to below it (i.e. becomes stopped) or from below to above (i.e. becomes started) then a delay is started during which the assessment is automatically paused. This is the activity required by clause 6.2.3.3 of EN61000-3-2 and clause 4.2.4 of EN61000-3-12 when a EUT is "brought into operation" or "taken out of operation".

**AUTO PAUSE:** When this is selected the assessment is continuously paused whenever the EUT power is below the detection level.

**AUTO STOP:** When this is selected the assessment is only performed while the EUT power is above the detection level and is automatically stopped when the EUT drops below the detection or the configured test time has elapsed (whichever occurs first). If the EUT power is below the detection level when the assessment is started then it is paused until the EUT power goes above the detection and then after the configured start delay has elapsed. This is rarely used, but is useful if the EUT has only a relatively short period of operation during assessment. Typically, the TEST TIME set would be longer than the expected operation time of the EUT for this situation.

Note:

Neither any delays nor pauses are considered part of the assessment time.

Recommendation:

Most EUTs do not actually start or stop during an assessment so OFF is generally recommended for this setting. For strict assessment to EN61000-3-2 and -12 then DELAY ONLY or possibly AUTO STOP settings should be considered along with entering values for the start/stop detection power level and the delay to use.

AUTO PAUSE is rarely used, but is included to allow full configuration capability, particularly when mitigation is needed for an assessment failure.

AUTO STOP is rarely used, but is useful if the EUT has only a relatively short period of operation during assessment. Typically, also the TEST TIME would be set slightly longer than the expected operation time of the EUT in this situation.

**STOP POWER:** This allows you to enter the start/stop detection power level and is only available if AUTO START/STOP is not set to OFF. See above for how this setting is used.

Recommendation:

If needed this should be set to a suitable value to allow the PA900 to reliably detect starting and stopping events in the EUT.

**START DELAY:** This allows you to set the number of seconds to delay after the EUT is detected as starting or stopping before continuing the assessment level and is only available if AUTO START/STOP is not set to OFF.

Recommendation:

EN61000-3-2 clause 6.2.3.3 only allows this to be set to 10 seconds, and EN61000-3-12 clause 4.2.4 recommends 10 seconds but allows a longer period. The PA900 allows any delay to be entered within the range 3 seconds to 1000 seconds.

#### 18.4.3.4 STARTING THE ASSESSMENT

When the START button is pressed on this screen the assessment is started as you have configured it and you are returned to the ASSESS EUT screen, otherwise if the CANCEL button is pressed any entries you have made are discarded and you are returned to the ASSESS EUT screen without an assessment being started.

Recommendation:

You must ensure that the 1.5 second filtering required by the standards has fully settled prior to starting an assessment so the EUT must have been powered and have been stable for at least 10 seconds prior to starting the assessment, the PA900 does not enforce this and in general the EUT will require longer than this to stabilize.

For certain types of EUT the standards may have additional requirements regarding a minimum stabilizing time period during which the supply source and EUT are powered prior to starting an assessment. Particularly see Annex C of EN61000-3-2 for further details.

---

### 18.4.4 VIEWING THE RESULTS OF AN ASSESSMENT

Both during an assessment and after an assessment has been performed the results of that assessment are displayed in the ASSESS EUT screen.

Note:

In some cases, as described in the following sub-sections, the data shown is specific to the selected PA900 channel to be viewed as selected by the leftmost button across the top of the screen.

Throughout this screen all textual results information follow the same meaning for textual coloring as follows-

If colored gold then the data is as configured by you.

If colored white then the data is showing a measurement.

If colored green then the data indicates that there is no error or precautionary condition.

If colored red then the data indicates an error or precautionary condition.

Although you may only view the results of the assessment, and may only start an assessment, from this screen, you do not need to maintain viewing this screen during or after an assessment. You can freely change between screens while an assessment is in progress and the results of a completed assessment are retained if you change to viewing another screen.

The results of an assessment are only lost if you power cycle the PA900, you make a significant change to the measurement configuration, or you start a new assessment with the ASSESS button.

#### 18.4.4.1 TEXTUAL RESULTS - SUPPLY

The SUPPLY area shows the textual results of measurements made on the supply voltage during the assessment. The data shown are (in order from top to bottom of the area)-

1. The pass/fail status of the supply checks (see section 18.1.6.1), note that this covers all phases of the supply not just that selected to be viewed. If any failure is detected then a numerical code is shown colored red which contains an indication of all detected failures by means of adding the codes for each failure, otherwise it shows OK colored green. The codes are-
  - 1: The voltage was not within the allowed range from the configured Unom value throughout the assessment.
  - 2: The frequency was not within the allowed range from the configured Fnom value throughout the assessment.
  - 4: The frequency changed by more than 0.03% during any 200ms measurement period.
  - 8: The supply voltage harmonics did not meet the requirements of EN61000-3-2 clause A.2c throughout the assessment. Note that when performing EN61000-3-12 assessments no checking of the supply voltage harmonics is performed.
  - 16: The supply voltage crest factor was not within the allowed range per EN61000-3-2 clause A.2d throughout the assessment. Note that when performing EN61000-3-12 assessments or an EN61000-3-2 class A or B assessment is being displayed this failure is not included.
  - 32: The supply voltage peak phase position was not within the allowed range per EN61000-3-2 clause A.2d throughout the assessment. Note that when performing EN61000-3-12 assessments or an EN61000-3-2 class A or B assessment is being displayed this failure is not included.
  - 64: The inter-phase supply voltage phase was not within the allowed range per EN61000-3-2 clause A.2b or EN61000-3-12 clause 7.2c throughout the assessment.

Recommendations:

If codes 1 and/or 2 are found then either the assessment was not performed with the supply source set correctly, or the Unom and/or Fnom settings in the PA900 were incorrectly set. In this later case you only need to change those settings with a REASSESS, in the former case the supply source needs to be corrected and the entire assessment repeated.

If codes other than 1 or 2 are found then the supply source is not suitable for performing the assessment.

2. The nominal voltage and frequency configured (i.e. Unom/Fnom). Note that these are only displayed with 1V and 1Hz resolution, the full entered value resolution is actually used.
3. The Rsce value configured or automatically determined by the PA900. The same value of Rsce is used for all phases.
4. The actual measured voltage range of the supply phase selected. The minimum-maximum voltages measured during the assessment.
5. The actual measured frequency range of the supply. The minimum-maximum frequencies measured during the assessment.

#### 18.4.4.2 TEXTUAL RESULTS - MEASUREMENTS

The MEASUREMENTS area shows the textual results of measurements in the channel selected to be viewed during the assessment. The data shown are (in order from top to bottom of the area)-

1. If an overload was detected during the assessment (see section 18.1.6.2) then this shows a suitable message colored red describing that overload, otherwise it shows OK colored green.
2. The actual measured power consumption of the EUT. The minimum-maximum power measured during the assessment.
3. The actual measured current loading of the EUT. The minimum-maximum current (RMS) measured during the assessment.
4. The actual measured power factor of the EUT. The minimum-maximum power factor measured during the assessment.
5. The actual measured THC (Total Harmonic Current, in Amps) of the EUT. The minimum-maximum THC measured during the assessment.

#### 18.4.4.3 TEXTUAL RESULTS - LIMITS

The LIMITS area shows the textual results of the limits selection and additional details regarding limits selection obtained during the assessment. The data shown are (in order from top to bottom of the area)-

1. The classification of the EUT (class for EN61000-3-2, table for EN61000-3-12).
2. The limits table called for by the selected classification (EN61000-3-2 only).
3. The reference levels for the selected limits table (if any).
4. Which "conditions" were detected (EN61000-3-12 only, does not include conditions b or e). You should note that if condition a or d is detected then the detection of conditions c and f may be unreliable as the 5<sup>th</sup> harmonic content may be extremely small (EN61000-4-7 requires that phase be ignored for harmonics less than 0.15% of the Amps reference level so in that situation you must consider whether to assume that these conditions are present or not depending on the construction of the EUT independently of the indications of the PA900).

5. Which “*circumstances*” required for the table selection were detected (EN61000-3-12 only, does not include circumstance b).

#### 18.4.4.4 TEXTUAL RESULTS – ASSESSMENT

The ASSESSMENT area shows the status of an ongoing assessment, or the final assessment after an assessment has been completed. PASS (or PASSING during an assessment) is shown colored green if the result of checking the limits is a pass, otherwise FAIL (or FAILING during an assessment) is shown colored red. The assessment pass/fail shown is the total assessment, for all phases of the EUT.

If a failure is detected within the channel selected to be displayed, then below this is a listing of the lowest numbered harmonics (up to three are listed) which are causing the failure. The failures shown are-

**AVG > LIMIT:** This indicates that the indicated harmonic current in this channel has an average measured value above the applicable limit and no exemption was found which would allow this.

**MAX > LIMIT:** This indicates that the indicated harmonic current in this channel had one or more measured values during the assessment which were above the applicable limit and no exemption was found which would allow this.

**THC > LIMIT:** This indicates that the THC (Total Harmonic Current, as calculated from the average harmonics over the entire assessment) for this channel was above the allowable limit (EN61000-3-12 only).

**PWHC > LIMIT:** This indicates that the PWHC (Partial Weighted Harmonic Current, as calculated from the average harmonics over the entire assessment) for this channel was above the allowable limit (EN61000-3-12 only).

Note:

If nothing is shown below a FAIL or FAILING status then the channel selected to be displayed is not causing the failure

Although a PASSING/FAILING status is shown for the EUT during an assessment, this is not the final status and may change later during the assessment. Similarly, the listed failures shown for measured harmonics is not the final list and may change later during the assessment.

The presence or absence of AVG > LIMIT and MAX > LIMIT indications do not mean that the respective data is above or below the limit as contained in the table of the standard, but its presence indicates that it is above the maximum amount allowed by the standard for that specific data after including any allowable exemptions, see EN61000-3-2 clause 6.2.3.4 or EN61000-3-12 clause 4.2.5 for details regarding how the table limits are applied as limits on measured harmonic data and any exemptions which may be applied.

If an indicated harmonic fails for both AVG > LIMIT and MAX > LIMIT reasons then only the AVG > LIMIT reason is shown in this list.

The THC and PWHC > LIMIT indications are as required by EN61000-3-12 and so do not use the measurements of THC and PWHC but are instead calculated from the average individual harmonics throughout the assessment (including disregarding harmonics in the calculation of THC and PWHC if their average measured value is below the required disregard level, see EN61000-3-12 clause 4.2.5).

#### 18.4.4.5 GRAPHICALLY CHARTED RESULTS

Below the textual results is a chart which shows one of various measurements made by the selected channel as they have been taken during the assessment.

You can select which of the following measurements is to be traced on this chart by using the UP and DOWN arrow keys to the left of the chart.

**Arms:** the RMS measurements of RMS current are charted and the Max, Avg and Min numerical data shown are the maximum, average and minimum measurements during the entire assessment.

**Watts:** the measurements of power are charted and the Max, Avg and Min numerical data shown are the maximum, average and minimum measurements during the entire assessment.

**THC:** the measurements of the total harmonic current (the combination of all harmonics other than the fundamental) are charted. Note that the chart does not show the data which is checked against a EN61000-3-12 limit as that data is the THC of the average harmonics throughout the assessment, however the Lim and Avg numerical data shown are the limit and that data respectively and if performing EN61000-3-12 assessment then the Avg data is colored red or green according to if it fails or passes respectively and the limit value is plotted on the chart as a horizontal line at that current level for reference purposes. Although this measurement is not used for EN61000-3-2 assessments it is still available as a useful reference.

**POHC:** the measurements of the partial odd harmonic current (the combination of all odd harmonics 21<sup>st</sup> and above) are charted. Note that the chart does not show the data which is used to define the POHC based exemption for EN61000-3-2 harmonics as that data is the POHC of the average harmonics throughout the assessment, however the Lim and Avg numerical data shown are the limit and the data respectively which are used for that exemption and if a EN61000-3-2 assessment is being performed the limit value is plotted on the chart as a horizontal line at that current level for reference purposes. Although this measurement is not used for EN61000-3-12 assessments it is still available as a useful reference.

**PWHC:** the measurements of the partial weighted harmonic current (the combination of all harmonics 14<sup>th</sup> and above, each weighted by their harmonic number) are charted. Note that the chart does not show the data which is checked against a EN61000-3-12 limit as that data is the PWHC of the average harmonics throughout the assessment, however the Lim and Avg numerical data shown are the limit and that data respectively and if performing EN61000-3-12 assessment then the Avg data is colored red or green according to if it fails or passes respectively and the limit value is plotted on the chart as a horizontal line at that current level for reference purposes. Although this measurement is not used for EN61000-3-2 assessments it is still available as a useful reference.

**A<sub>hn</sub>** (n is 1 to 40): the measurements of the selected current harmonic are charted. The Lim, Max and Avg numeric data shown are the limit (if any), the highest measured value and the average measured value respectively. If the selected



harmonic has a limit set by the relevant standard then the Max and Avg data are colored red or green according to if it fails or passes respectively and the limit value is plotted on the chart as a horizontal line at that current level for reference purposes.

Note:

The horizontal scale of this chart is always time, and is always scaled with the start of the assessment at the left end and the configured end of the assessment at the right end. If the assessment was stopped prior to the configured ending time then the chart will not have data shown encompassing the entire horizontal span of the chart, only for the time of the actual assessment.

The chart always has a zero value at the bottom of the vertical axis, and automatically selects a suitable 1/2/5 based value for the upper limit for the vertical axis to ensure that the trace (including that for the limit if applicable) is entirely shown.

This chart is provided to assist you in determining factors causing the failure or not of a EUT to meet the requirements of the standards. The charted data shown is not actually that used to determine the pass/fail status, as that encompasses data in more detail than can be shown on such a chart.

Individual harmonics are allowed to be above the limit for moderate periods of time, and by certain amounts, and may be completely disregarded, so it is valid to see individual harmonics charted above the limit line but with an assessment status of PASS. See the standards for details regarding how limits are applied (EN61000-3-2 clause 6.2.3.4 or EN61000-3-12 clause 4.2.5).

---

### 18.4.5 CHANGING THE CONFIGURATION AND REASSESSING THE EUT

If you press the REASSESS button, either during an assessment, or after one has completed, then this initiates the configuration screen similar to pressing the ASSESS button, and allows you to change any of the SUPPLY or EUT DETAILS section entries but does not allow changes to the TIMING section entries. When the RETURN button is pressed the assessment results screen is returned to with all assessment results now displayed using the newly entered configuration.

As previously mentioned, during an assessment the PA900 makes and records all measurements as needed to perform an assessment of the EUT to any of the classifications and with any reference level(s).

---

### 18.4.6 CONTINUING A PAUSED ASSESSMENT

If an assessment has been configured to be performed in more than 1 interval, then the PA900 will automatically pause an assessment when each of the intervals has been completed (except for the last one when it will stop). In this case there is an additional button shown across the top of the screen which is entitled CONTINUE which is only shown while the PA900 is paused in this manner. While the CONTINUE button is shown, you should change the EUT conditions according to the instructions in the standard and then press the CONTINUE button to start the next interval which will be started immediately.

In this manner each interval has an identical assessment time and all measurements while paused are disregarded as not being part of the assessment. The chart across the bottom of the screen shows only the assessed measurements with no gaps between intervals, vertical lines are shown in gold separating the intervals within the assessment for your reference.

Recommendation:

You must ensure that the 1.5 second filtering required by the standards has fully settled prior to continuing an assessment in this manner so the EUT must have been operating under the changed conditions for at least 10 seconds prior to continuing the assessment, the PA900 does not enforce this and this appears to have been overlooked in the standards.

---

### 18.4.7 STOPPING AN ASSESSMENT

An assessment in progress is denoted on the ASSESS EUT screen by the ASSESS button being highlighted with a green color. While highlighted an assessment may be manually stopped by pressing the ASSESS button. This does not abort an assessment but stops it just as if the test time had elapsed.

Note:

This may be useful if you are not sure if the EUT has stable characteristics so have set a lengthy test time, but subsequently discover during the assessment that the EUT is stable so the assessment may be shortened and still meet the repeatability requirements.

There is no loss of accuracy or lack of conformance to standards in the PA900 itself by shortening a single interval assessment in this manner. However the chart shown on the screen and the historical records contained in the report file are scaled to the configured total assessment time so your ability to use those to obtain timing information is reduced in resolution (this data is not required by a standard).

Generally, an assessment being performed in multiple intervals should not be stopped in this manner unless it is wished to discard its results. Doing so will result in a shortened interval which is not the same as preceding intervals and any remaining intervals are not performed at all so in the case of multiple intervals the assessment will not be to the requirements of the standards.

There is a situation where it is valid to use this method of stopping an assessment with multiple intervals however; if the assessment pauses with the CONTINUE button being shown (so is at the end of an interval) and you realize that the number of intervals configured is incorrect and sufficient intervals have actually been performed, then you can stop the assessment at this time and meet the requirements of the standards.

---

### 18.4.8 RECORDING THE RESULTS OF AN ASSESSMENT

After an assessment has been performed then an additional button entitled REPORT is shown in the rightmost position at the top of the screen. This is only shown if a valid USB Drive is inserted into the front panel USB port and no other activity is in progress (such as data logging for example) to that drive. Pressing this button allows you to enter a filename on that drive in which to save all details regarding the assessment (the .CSV extension for the filename is automatically appended to the filename). After entry of the

filename, if a file already exists on the drive with that name then you are also asked to select if it is OK to overwrite it. After entering the filename (and selecting to overwrite as needed) the PA900 internally forms a file to write to the drive containing all of the details and results of the assessment, including an historical record of all harmonics and then writes this to the drive using the filename you supplied.

The file contains textual information using the “comma separated value” syntax commonly used for spreadsheet information and can be opened by many different programs on a computer, including text editors and word processing programs. Such a file is written as each line being a “record”, and each column within that record being a “field”, with fields being separated from each other by a comma character.

The file written by the PA900 in this manner has the following records–

<b>Record number</b>	<b>Fields</b>
The first set of records shows the assessment performed and the overall pass/fail outcome of the assessment.	
1	Time of day, date (when the actual assessment measurements were started)
2	EN61000-3-2 or EN61000-3-12
3	CLASSIFICATION, EUT classification (for EN61000-3-2) or table (for EN61000-3-12).
4	ASSESSMENT, PASS or FAIL (overall pass/fail result for the EUT)
5	Always a blank record
The next set of records shows details about the assessment timing.	
6	ASSESSMENT TIME, configured total, actual total.
7	INTERVALS, number of intervals into which the total assessment time was split.
8	START/STOP, IGNORED or DELAY or PAUSE or SINGLE, detection level (if not IGNORED), start delay (if not IGNORED)
9	Always a blank record
The next set of records shows details about the voltage supply.	
10	SUPPLY V, configured, maximum, average, minimum (the last three are repeated for each phase if multi-phase)
11	SUPPLY F, configured, maximum, average, minimum
12	RSCE, configured, assessed Only filled if recording a EN61000-3-12 assessment but record is always present
13	SUPPLY ERROR, code code is 0 if no errors, otherwise is the addition of the following error codes- 1: outside of voltage range 2: outside of frequency range 4: frequency jitter beyond requirement 8: voltage harmonics over requirement (does not occur for EN61000-3-12) 16: voltage crest factor not in required range (does not occur for EN61000-3-12 or EN61000-3-2 classes A or B) 32: voltage peak phase position not in required range (does not occur for EN61000-3-12 or EN61000-3-2 classes A or B) 64: inter-phase voltage phase not in required range
14	Always a blank record
The next set of records shows details about the PA900 and its' configuration.	
15	PA900, serial number, main firmware version, FPGA version
16	CHANNELS, channel number, type and current option, configured range (all but the 1 <sup>st</sup> field are repeated for each phase if multi-phase)
17	SETTINGS, adjust setting, coupling setting, wiring setting
18	Always a blank record
The next set of records shows details about the limits being applied for the assessment.	
19	CONDITIONS, condition letters Only filled if recording a EN61000-3-12 assessment but record is always present
20	CIRCUMSTANCES, circumstance letters Only filled if recording a EN61000-3-12 assessment but record is always present
21	WREF, configured, used, maximum measured, MEAS or USER or LAST Only filled if recording an assessment which requires a Wref but record is always present
22	AREF, configured, used, maximum measured, MEAS or USER or LAST Only filled if recording an assessment which requires a Aref but record is always present
23	PFREF, configured, used, MEAS or USER or LAST Only filled if recording an assessment which requires a PFref but record is always present
24	Always a blank record
The next set of records shows details about general measurements made during the assessment.	
25	Descriptive headings for the data contained in the following set of records.

26	OVERLOAD, code, 2 empty fields (all but the 1 <sup>st</sup> field are repeated for each phase if multi-phase) code is 0 if no overloads detected, otherwise is the addition of- 1: current peak overload 2: current rms overload 4: voltage peak overload 8: voltage rms overload
27	ARMS, maximum, average and minimum (all but the 1 <sup>st</sup> field are repeated for each phase if multi-phase)
28	WATTS, maximum, average and minimum (all but the 1 <sup>st</sup> field are repeated for each phase if multi-phase)
29	PF, maximum, average and minimum (all but the 1 <sup>st</sup> field are repeated for each phase if multi-phase)
30	THC, maximum, average and minimum (all but the 1 <sup>st</sup> field are repeated for each phase if multi-phase)
31	POHC, maximum, average and minimum (all but the 1 <sup>st</sup> field are repeated for each phase if multi-phase)
32	PWHC, maximum, average and minimum (all but the 1 <sup>st</sup> field are repeated for each phase if multi-phase)
33	Always a blank record

The next set of records shows details about the harmonics measurements and any limits applied during the assessment.

34	Descriptive headings for the data contained in the following set of records.
35 to 74 inclusive	AH <sub>n</sub> (n is 1 to 40), limit (if any), maximum, average, time over 150% of limit (if EN61000-3-2 class A only), failure code (last 4 fields repeated for each supply phase if multi-phase) If a field is not applicable then it is empty but is always present failure code is 0 if no failure, or the addition of- 1: average value failed to meet the requirement 2: maximum value failed to meet the requirement
75	POHC, limit, an empty field, measurement value, 2 empty fields (last 4 fields repeated for each supply phase if multi-phase) Only filled if recording a EN61000-3-2 assessment but record is always present
76	THC, limit, an empty field, measurement value, an empty field, failure code (last 4 fields repeated for each supply phase if multi-phase) Only filled if recording a EN61000-3-12 assessment but record is always present failure code is 0 if no failure or 1 if failed to meet the requirement
77	PWHC, limit, an empty field, measurement value, an empty field, failure code (last 4 fields repeated for each supply phase if multi-phase) Only filled if recording a EN61000-3-12 assessment but record is always present failure code is 0 if no failure or 1 if failed to meet the requirement
78	Always a blank record

The next set of records gives historical measurements during the assessment, enabling you to generate graphs if you wish to. Measurements of Arms, Watts, THC, POHC, PWHC, and every harmonic are available for each phase of the supply.

79	Descriptive headings for the data contained in the following set of records.
80 to 591 inclusive	512 records containing the maximum measured Arms during each of 512 equally spaced time slices covering at least the entire configured total assessment time. These are always in increasing time order and not all records may be filled but all are always present. Each record has the starting time of the corresponding time slice (relative to the 1 <sup>st</sup> point) as the first field.
592	Always a blank record
593 to 1106 inclusive	As records 79 to 592 but for Watts measurements.
1107 to 1620 inclusive	As records 79 to 592 but for THC measurements.
1621 to 2134 inclusive	As records 79 to 592 but for POHC measurements.
2135 to 2648 inclusive	As records 79 to 592 but for PWHC measurements.
2649 onwards	40 sets of records which are as records 79 to 592 but for each current harmonic measurement starting with the fundamental. This is a total of 40 times 514 records.

**Note:**

A file generated in this manner can be up to 3Mbytes in size.

The recorded data covers all channels assessed independently of which channel is selected as being viewed on the screen.

In the descriptive records, each phase of the supply is denoted as PhA through PhD, in order of increasing channel number in the PA900.

Although Vitrek will attempt to preserve this layout of the records and fields within the file, it may change if needed in future upgrades.

All times, limits and measurement results are generated in floating point format with 6 significant digits with an exponent value that is always divisible by 3 and have the native units of the data being represented (e.g. times are in seconds, voltages are in Volts, currents are in Amps, powers are in Watts). Note that no percentages are generated.

Saving this data as a file may be repeated as many times as you wish and you may REASSESS the assessment as many times as you wish. In this manner you can record the results of assessments to several different classifications (with different file names) without performing separate full assessments. You can also save an image of the screen as described in 23.5.1 of this document.



## 19 MEASURING ELECTRICAL POWER TO EN60034-2-1 REQUIREMENTS

Standard EN60034-2-1:2014 clause 5.5.2 requires that direct measurements of motor electrical power to that standard have 0.2% or better accuracy.

The PA900 can perform such measurements over a wide range of voltages and currents, either with bandwidth limiting or not.

Generally you should configure the PA900 for measurements which are suitable for the motor being tested; the following MEAS CONFIG settings are recommended-

LF/PERIOD setting of 10Hz/0.3s or 20Hz/0.1s

FUND setting of MAINS (for a drive frequency in the range 45 to 65Hz and a non-PWM driven motor) or VOLTAGE (for a non-PWM driven motor drive frequency within the range from the LF/PERIOD setting up to a limit defined by you) or CURRENT (for a PWM driven motor drive frequency within the range from the LF/PERIOD setting up to a limit defined by you).

The highest frequency setting when using the VOLTAGE or CURRENT settings should be just slightly above the maximum expected motor drive or modulation frequency.

BANDWIDTH should be set for AUTO-TRACK or UNFILTERED as desired, however the recommendations for PWM driven motors contained in section 16 should be followed for those situations.

HARMONICS is generally not needed, so setting this to 0 or 1 is recommended.

The other MEAS CONFIG settings are not important for best performance so may be set according to the recommendations of section 12.4.

To achieve the necessary accuracy the use of the A type channels with the H current option, is recommended for a wide range of voltages and currents. However a smaller range of voltages and currents may be achieved with other channel types and/or current options. The charts shown below show the allowable range of voltages and currents which can be measured with an AH channel to within the requirements of EN60034-2-1, both with and without bandwidth restriction employed.

Note that the allowable range is continuous, there are no areas contained within it which are not applicable, and these charts assume a 2 year recalibration interval for the PA900. These charts have been generated using the accuracy specifications contained in section 28. For charts for other channel types or current options, or in different conditions, please contact Vitrek.

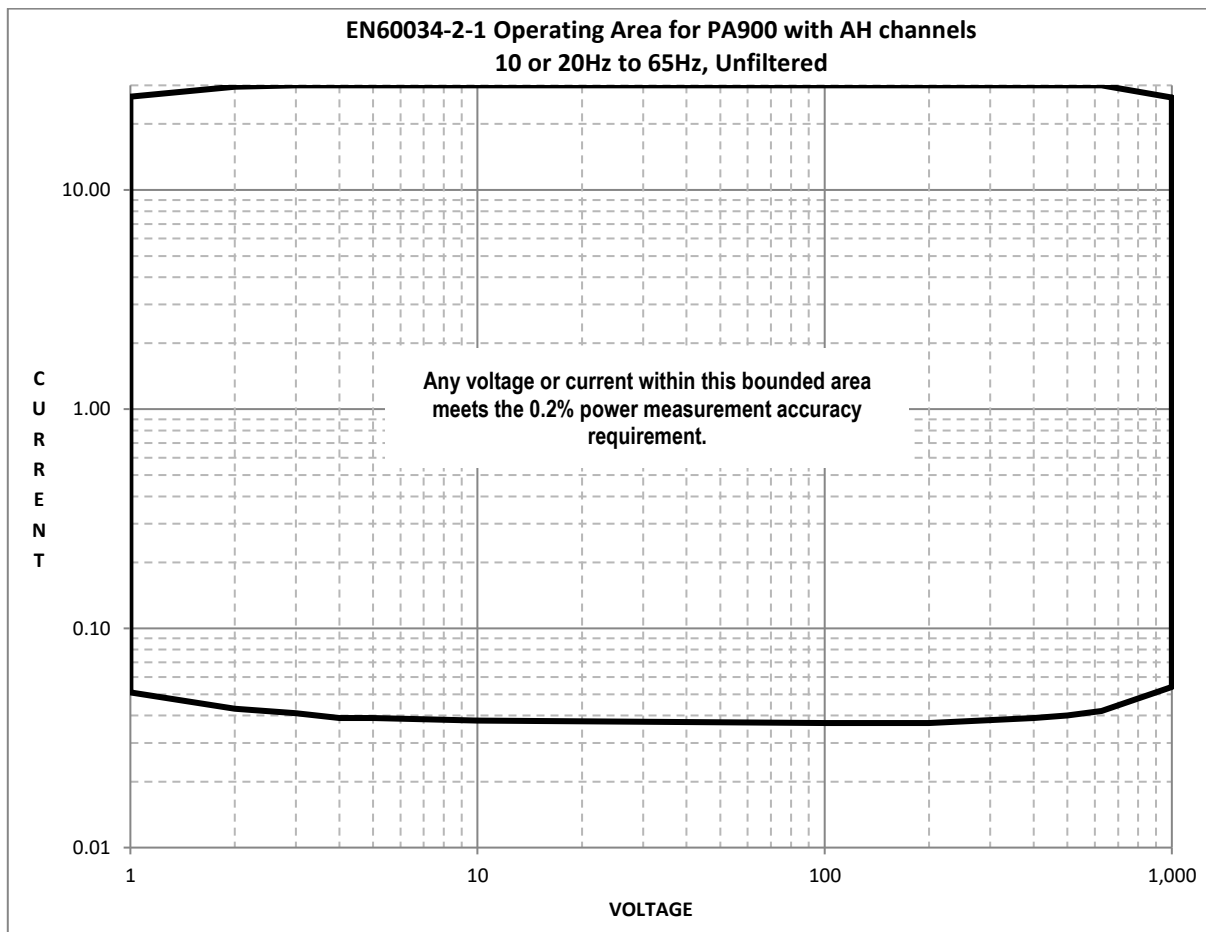

**EN60034-2-1 Operating Area for PA900 with AH channels  
10 or 20Hz to 65Hz, 2kHz filter, PWM depth > 10%**

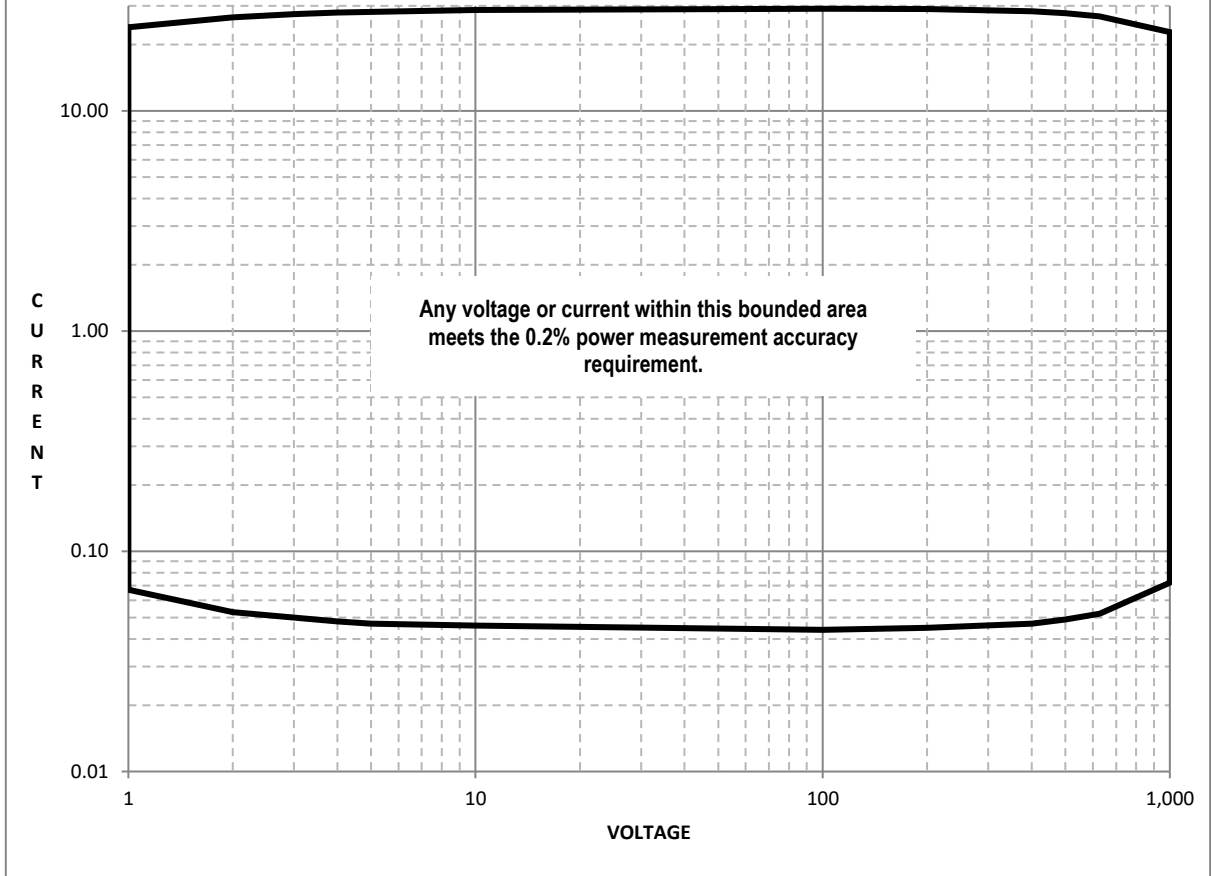

## 20 MEASURING ELECTRICAL POWER TO AVIONICS REQUIREMENTS

It is assumed in this section that you are conversant with the general operating methods used in the PA900 as described in section 12.

Throughout this section, “requirement” is used to describe the avionics industry document defining the testing being performed (see the list below for those specifically referred to in this document), “equipment” is used to describe the equipment being tested to one of these requirements, and “supply” is used to describe the power supply (or supplies) being used to provide the power to that equipment.

The PA900 may be able to be used for testing equipment to other avionics requirements by using the general methods described in this section, but this section is specifically tailored for testing performed to the following requirements -

RTCA DO-160E/F/G (Section 16 – Power Input)

Boeing 787B3-0147

Airbus ABD0100.1.8 (A380) – requires W type channels.

Airbus ABD0100.1.8.1 (A350) – requires W type channels.

Note:

It is your responsibility to ensure that any testing you perform to a requirement fully meets that requirement.

Requirement Airbus ABD0100.1.8.1 (A350) specifically requires spectrum analysis rather than harmonic analysis. You should use the PA900 spectrum analysis as described in section 12.13 instead of harmonic analysis for testing ‘harmonics’, ‘inter-harmonics’ and ‘sub-harmonics’ to that requirement.

This section describes using the PA900 during several tests defined by the requirements. If this section does not list a specific test then this does not indicate that the PA900 is incapable of assisting you in the execution of that test, it only indicates that it may be of limited use or that Vitrek has not evaluated the use of the PA900 to that requirement. For example, the SCOPE or HISTORY capabilities may be of use in many test steps.

### 20.1 CONNECTING THE PA900

For all tests carried out to these requirements the PA900 should be connected using one of the methods described in section 9. Generally either the 1-phase or 3-phase 4-wire methods will be used for these applications, corresponding to the supply being used by the equipment.

In some cases you may be providing the equipment with more than one supply. The PA900 can be configured to use multiple VPAs, one per supply, with the channels of each VPA connected accordingly. The PA900 will then monitor each supply independently and it not required that each supply have the same frequency. This section has been written assuming that only single supply is being tested.

### 20.2 CONFIGURING THE MEASUREMENTS MADE BY THE PA900

The measurement configuration of the PA900 varies slightly between requirements, and varies with whether an AC or a DC supply is being used by the equipment.

For certain specific tests the configuration may require to be altered from that shown in this sub-section; where that is necessary it is detailed in the specific sub-section for that test.

The sub-sections below indicate the settings for the MEAS CONFIG screen for 3-phase, 1-phase and DC supplies.

The channels shown below are examples, in practice select the actual channels being used for the supply.

If testing multiple supplies, then configure the MEAS MODE to MULTI-VPA and configure each VPA for each supply type.

#### 20.2.1 AC 3-PHASE SUPPLIES

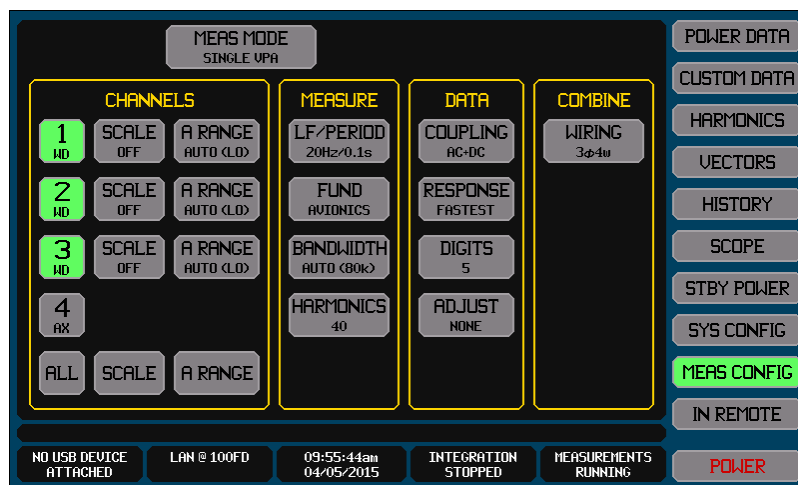

For the A RANGE setting for each channel –

For SD, AD or WD channels it will be as shown above. This will not be shown if using SH, AH or WH channels as no setting is required.

The AUTO setting should be chosen as shown above; the text shown in each A RANGE button may have a different range (LO) or (HI) indicated as that shows the actual range selected for the current being passed at that time.

For the FUND setting –

This must be set to AVIONICS as shown above.

For the BANDWIDTH setting –

Except for the Airbus requirements, the AUTO-TRACK setting should be chosen as shown above; the text shown in the button may have a different frequency indicated as this depends on the actual measured frequency at the time of each test.

For the Airbus requirements a 300kHz fixed frequency bandwidth limit setting should be set using the USER choice and setting 300kHz as the limit.

For the HARMONICS setting -

For DO-160E/F/G a setting of 40 should be chosen as shown above.

For 787B3-0147 a setting of 62 should be chosen.

For the Airbus requirements a setting of 500 should be chosen (the PA900 will automatically limit the actual number of harmonics to  $\leq 150$ kHz as required in the Airbus requirements because of the 300kHz BANDWIDTH setting used).

## 20.2.2 AC 1-PHASE SUPPLIES

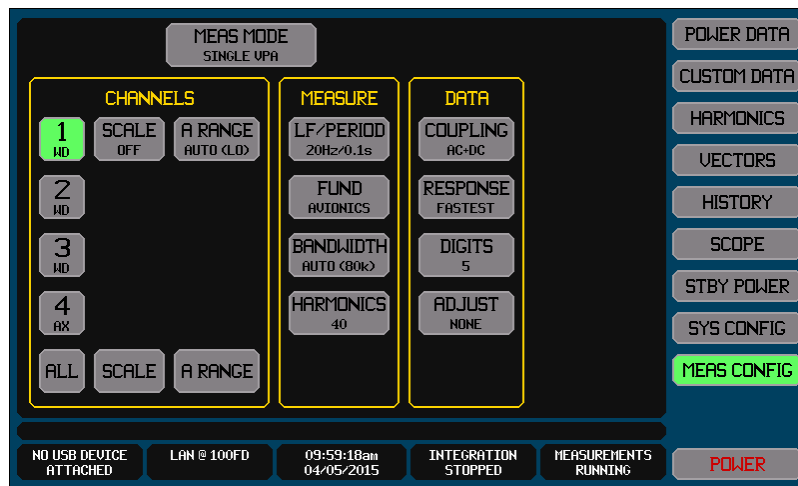

For the A RANGE setting –

For SD, AD or WD channels it will be as shown above. This will not be shown if using SH, AH or WH channels as no setting is required.

The AUTO setting should be chosen as shown above; the text shown in each A RANGE button may have a different range (LO) or (HI) indicated as that shows the actual range selected for the current being passed at that time.

For the FUND setting –

This must be set to AVIONICS as shown above.

For the BANDWIDTH setting –

Except for the Airbus requirements, the AUTO-TRACK setting should be chosen as shown above; the text shown in the button may have a different frequency indicated as this depends on the actual measured frequency at the time of each test.

For the Airbus requirements a 300kHz fixed frequency bandwidth limit setting should be set by using the USER choice and setting 300 kHz as the limit.

For the HARMONICS setting -

For DO-160E/F/G and 787B3-0147 a setting of 40 should be chosen as shown above.

For the Airbus requirements a setting of 500 should be chosen (the PA900 will automatically limit the actual number of harmonics to  $\leq 150$ kHz as required in the Airbus requirements because of the 300kHz BANDWIDTH setting used).

## 20.2.3 DC SUPPLIES

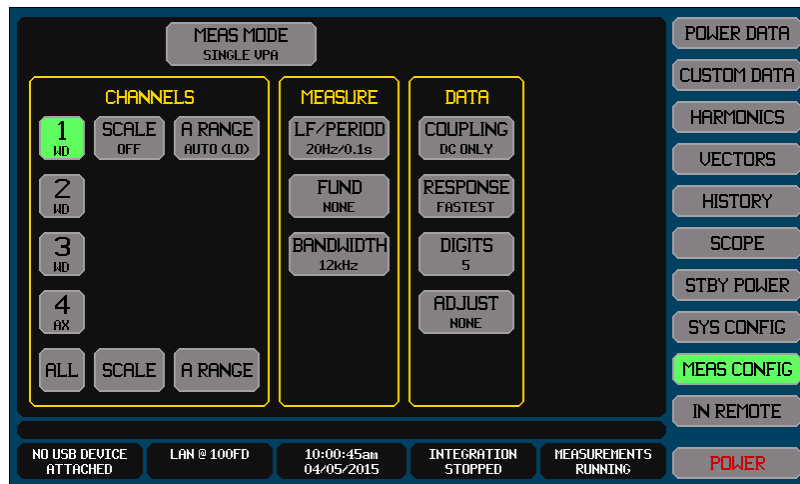

For the A RANGE setting –

For SD, AD or WD channels it will be as shown above. This will not be shown if using SH, AH or WH channels as no setting is required.

The AUTO setting should be chosen as shown above; the text shown in each A RANGE button may have a different range (LO) or (HI) indicated as that shows the actual range selected for the current being passed at that time.

For the FUND setting –

This must be set to NONE as shown above.

For the BANDWIDTH setting –

A 12kHz fixed frequency bandwidth limit setting should be set by using the USER choice and setting 12 kHz as the limit.

## 20.3 USING THE PA900 TO MONITOR THE SUPPLY

These requirements all require equipment being tested to meet performance requirements while being subjected to various levels, frequencies, and disturbances to the supply being used to power it. In most cases you will use a power supply, possibly with some other circuitry or instruments, to provide the required supply to the equipment.

The PA900 can be used to monitor the supply to the equipment to ensure that most of these tests are being carried out properly rather than just relying on the source producing the desired voltage, frequency and waveform.

For these tests the PA900 is not making a measurement of the equipment, but is confirming the supply being used to power the equipment. Whether the tests pass or not is not dependent on measurements made by the PA900.

If you wish to record the measurements made, then it is recommended to either –

Save a graphical copy of the screen(s) to a USB Drive (see section 23.5)

Or, export all measurement results to a USB Drive (see section 23.5)

### 20.3.1 CONFIRMING THE VOLTAGE AND FREQUENCY OF THE SUPPLY

The PA900 may be used to confirm that the supply voltage and frequency are as required for many of the tests to be performed.

This is performed by using the POWER DATA screen which should be selected to display the results for the entire VPA (i.e. the entire supply), showing the COUPLED data (so the AC+DC or the DC data is shown as configured for this supply), and showing the full DETAILED information.

The primary data (shown in larger, gold colored text) for voltage and current shows the average of the phase voltages and currents from the supply (for a 1-phase or DC supply there is only a single phase).

The secondary data (shown in a smaller, white colored text) for voltage and current lists the voltages and currents from each phase from the supply (for a 1-phase or DC supply there is only a single phase). Also included in the secondary data for voltage are the inter-phase phase measurements.

The frequency shows the supply frequency (not shown for a DC supply).

### 20.3.2 CONFIRMING THE VOLTAGE MODULATION DEPTH OF THE SUPPLY

The PA900 may be used to confirm that the supply voltage modulation depth is as required for certain of the tests to be performed.

Note:

The bandwidth of the measurement may have a severe impact on the results obtained. The requirements do not generally state any specific bandwidth for such a measurement, yet this is a measurement of peak values which are very dependent on the measurement bandwidth by definition. You may wish to alter the MEAS CONFIG - BANDWIDTH setting while performing these tests to a lower value (e.g. 4kHz) to reduce the bandwidth of the measurement.

The PA900 cannot confirm the frequency content of the modulation.

It is required that this value be measured over many measurement periods of the PA900 (so giving a result for low frequency modulation) this is achieved by using the POWER DATA screen configured to show each channel, and INRUSH data.

To use this screen follow the procedure described below –

1. Select the POWER DATA screen as shown above.
2. Press the CLEAR button.
3. Wait for the desired period of time (for example 2 minutes for DO160E 16.5.1.2). The time and date displayed on the PA900 screen may be of assistance in determining the time elapsed.
4. Press the area showing MEASUREMENTS RUNNING (this is called the MEASUREMENT INFO area in this manual). This holds all measurements enabling you to view and record data without being concerned about the time taken to do so.
5. Record the indicated voltage Vpk and Vly data. The difference between these is the difference between the highest peak and the lowest valley encountered during the period between pressing the CLEAR button and recording the result.
6. Step 2 clears the data for all channels, so for a 3-phase supply you do not need to repeat the entire procedure for each phase if all phases are being modulated. Just repeat step 5, changing the selected channel to record the measurements for each phase.
7. Do not forget to release the measurement hold after recording all phases.

Note:

It may also be useful (but not required) to view the short-term modulation; this is performed by using the POWER DATA screen as above but configured to show the COUPLED data and showing DETAILED. In the secondary data (shown in a smaller, white colored text) for voltage is a measurement result entitled Pk-Vly. This is the maximum peak-to-valley difference measured and updated each measurement period. Because the PA900 is configured for a 100ms measurement period this value will fluctuate in response to modulation at frequencies which are not a multiple of 10Hz.

### 20.3.3 CONFIRMING THE DC VOLTAGE CONTENT OF THE SUPPLY

The PA900 may be used to confirm that the supply voltage DC content is as required for certain of the tests to be performed.

This is performed by using the POWER DATA screen which should be selected to display the results for each channel, showing the COUPLED data (so the AC+DC or the DC data is shown as configured for this supply), and showing the full DETAILED information.

In the secondary data (shown in a smaller, white colored text) for voltage is a measurement result entitled DC. This is the DC content of the supply voltage phase being viewed.

### 20.3.4 CONFIRMING THE VOLTAGE DISTORTION OF THE SUPPLY

The PA900 may be used to confirm that the supply voltage distortion content is as required for certain of the tests to be performed.

Note:

As defined in DO160E/F/G 16.5.1.8.1.1 this is an impossible measurement to perform as it requires that the distortion be measured over an infinite number of harmonics. In this manual it is assumed that the requirement intended that this measurement be performed over the same number of harmonics as defined for the current distortion tests in each requirement.

This is performed by using the POWER DATA screen which should be selected to display the results for each channel, showing the FUNDAMENTAL data, and showing the full DETAILED information.

In the secondary data (shown in a smaller, white colored text) for voltage is a measurement result entitled THDf. This is the percentage distortion content referenced to the fundamental component of the supply voltage phase being viewed.

### 20.3.5 CONFIRMING THE VOLTAGE RIPPLE CONTENT OF THE SUPPLY

The PA900 may be used to confirm that the supply voltage ripple content is as required for certain of the tests to be performed.

Note:

The bandwidth of the measurement may have a severe impact on the results obtained. The requirements do not generally state any specific bandwidth for such a measurement, yet this is a measurement of peak values which are very dependent on the measurement bandwidth by definition. You should alter the MEAS CONFIG - BANDWIDTH setting while performing these tests to a value to provide a standardized bandwidth of the measurement - Vitrek recommends a setting of 25kHz for BANDWIDTH for these tests.

The PA900 cannot confirm the frequency content of the modulation.

This is performed by using the POWER DATA screen which should be selected to display the results for each channel, showing the COUPLED data, and showing the full DETAILED information.

In the secondary data (shown in a smaller, white colored text) for voltage are measurement results entitled Pk, one with an up arrow and the other with a down arrow. These provide the measurement of the highest and lowest extents of the ripple, the difference between these two measurements is the peak-to-peak ripple.

## 20.4 USING THE PA900 TO TEST COMPLIANCE TO LOADING REQUIREMENTS

The PA900 can be used to monitor the supply to the equipment to ensure that most of these tests are being carried out properly and also simultaneously make the desired load current measurements.

If you wish to record the measurements made, then it is recommended to either -

- Save a graphical copy of the screen(s) to a USB Drive (see section 23.5)
- Or, export all measurement results to a USB Drive (see section 23.5)
- Or, export all harmonics results to a USB Drive (see section 23.5)
- Or, export all spectrum results to a USB Drive (see section 23.5)
- Or, export the cycle view results to a USB Drive (see section 23.5)

---

## 20.4.1 TESTING THE LOAD CURRENT DISTORTION MEETS REQUIREMENTS

The PA900 may be used to confirm that the supply voltage and frequency are as required, and the load current is within the distortion limits.

Note:

In the reporting requirements of DO160E/F/G it is stated that the load current harmonics must be reported, but it is also stated that the spectrum of the load current must be reported. It is assumed that this is intended to be either, not both as written, as they allow the use of either type of equipment and do not require both. If both are required then the spectrum may also be measured and recorded using the methods shown in section 12.13.

There are several reporting requirements for this test, each of which requires a specific screen to view. These are described in the following sub-sections.

### 20.4.1.1 VIEWING THE VOLTAGE AND CURRENT WAVEFORMS

The voltage and current waveforms can be viewed using the SCOPE – CYCLE VIEW screen configured to show the desired voltages and currents (all three phases of voltage and current can be displayed together if desired).

### 20.4.1.2 VIEWING THE VOLTAGE AND CURRENT HARMONICS

The voltage and current harmonics can be viewed using the HARMONICS screen. There is no need to view the harmonics to be able to record them, but it is recommended to do so to check that the measurement is being made properly. This screen can be used to view all of the voltage or current harmonics graphically for any phase of the supply with a variety of formats, and also provides a scrollable numerical listing showing up to 8 harmonics at a time.

### 20.4.1.3 VIEWING THE LOAD INPUT CURRENT

This is performed by using the POWER DATA screen which should be selected to display the results for entire VPA (i.e. the entire supply), showing the COUPLED data, and showing the full DETAILED information.

The primary data (shown in larger, gold colored text) for voltage and current shows the average of the phase voltages and currents from the supply (for a 1-phase supply there is only a single phase).

The secondary data (shown in a smaller, white colored text) for voltage and current lists the voltages and currents from each phase from the supply (for a 1-phase supply there is only a single phase).

The frequency shows the supply frequency.

### 20.4.1.4 VIEWING THE SUPPLY VOLTAGE THD AND LOAD CURRENT THD

This is performed by using the POWER DATA screen which should be selected to display the results for each channel, showing the FUNDAMENTAL data, and showing the full DETAILED information.

In the secondary data (shown in a smaller, white colored text) for voltage and for current is a measurement result entitled THDf. This is the percentage distortion content referenced to the fundamental component of the supply voltage and current for the phase being viewed.

---

## 20.4.2 TESTING THE LOAD PHASE IMBALANCE MEETS REQUIREMENTS

The PA900 may be used to confirm that the load phase imbalance is as required.

This is performed by using the POWER DATA screen which should be selected to display the results for entire VPA (i.e. the entire supply), showing the COUPLED data, and showing the full DETAILED information.

The primary data (shown in larger, gold colored text) for voltage and current shows the average of the phase voltages and currents from the supply (for a 1-phase supply there is only a single phase), the primary data for W, VA, VAR and PF show the total values for the entire supply.

The secondary data (shown in a smaller, white colored text) lists the measurements for each phase from the supply (for a 1-phase supply there is only a single phase).

The frequency shows the supply frequency.

The displayed VA is the “apparent power (volts-amperes)” requirement. The displayed W is the “real power (watts)” requirement. The displayed VAR is the “reactive power (vars)” requirement. The values for each phase can be checked against the requirement.

---

## 20.4.3 TESTING THE LOAD DC CURRENT CONTENT MEETS REQUIREMENTS

The PA900 may be used to confirm that the load DC current content is as required.

This is performed by using the POWER DATA screen which should be selected to display the results for each channel, showing the COUPLED data, and showing the full DETAILED information.

In the secondary data (shown in a smaller, white colored text) for current is a measurement result entitled DC. This is the DC content of the load current for the phase being viewed.

---

## 20.4.4 TESTING THE LOAD INRUSH CURRENT MEETS REQUIREMENTS

The PA900 may be used to confirm that the load inrush current is as required.

This is performed using the Inrush Current Capability of the SCOPE VIEW screen as described in section 12.14.1.

The timebase must be set to cover a long enough period to ensure the full requirements are met (2 seconds for DO160F, so 0.5s/div with a 25% trigger position is recommended), and you will have to zoom in to the smaller time periods and check the load current accordingly.



---

## 20.4.5 TESTING THE LOAD CURRENT MODULATION MEETS REQUIREMENTS

The PA900 may be used to confirm that the load current modulation is as required.

Note:

The bandwidth of the measurement may have a severe impact on the results obtained. You may wish to alter the MEAS CONFIG - BANDWIDTH setting while performing these tests to a lower value (e.g. 4kHz) to reduce the bandwidth of the measurement.

It is required that this value be measured over many measurement periods of the PA900 (so giving a result for low frequency modulation) this is achieved by using the POWER DATA screen configured to show each channel, and INRUSH data.

To use this screen follow the procedure described below –

1. Select the POWER DATA screen as shown above.
2. Press the CLEAR button.
3. Wait for the desired period of time (for example 1.5 seconds for DO160F 16.7.6).
4. Press the area showing MEASUREMENTS RUNNING (this is called the MEASUREMENT INFO area in this manual). This holds all measurements enabling you to view and record data without being concerned about the time taken to do so.
5. Record the indicated current Apk and Vly data. The difference between these is the difference between the highest peak and the lowest valley encountered during the period between pressing the CLEAR button and recording the result.
6. Step 2 clears the data for all channels, so for a 3-phase supply you do not need to repeat the entire procedure for each phase if all phases are being modulated. Just repeat step 5, changing the selected channel to record the measurements for each phase.
7. Do not forget to release the measurement hold after recording all phases.

---

## 20.4.6 TESTING THE LOAD POWER FACTOR MEETS REQUIREMENTS

The PA900 may be used to confirm that the load power factor is as required.

This is performed by using the POWER DATA screen which should be selected to display the results for entire VPA (i.e. the entire supply), showing the COUPLED data, and showing the full DETAILED information.

For all power factor data, if followed by an upwards pointing arrow the power factor is leading, otherwise it is lagging.

The primary data (shown in larger, gold colored text) for PF shows the overall power factor from the supply (for a 1-phase supply there is only a single phase).

The secondary data (shown in a smaller, white colored text) for power factor lists the power factor from each phase from the supply (for a 1-phase supply there is only a single phase).

## 21 SHARING MEASUREMENTS AND ACTIVITIES WITHIN MULTIPLE INSTRUMENTS

Certain measurements and activities can be shared between two or more PA900 instruments. This provides the following capabilities –

- Up to 1000 PA900s may be interconnected.
- The SYNC measurement mode which allows VPAs within a single PA900 to have synchronous measurement starting and period (see section 12.4.1) is extended to accomplish this among multiple PA900s configured using this measurement mode.
- All PA900s measurements can be held or released simultaneously from any PA900.
- All PA900s integrations can be started and/or stopped from any PA900.
- All PA900s historical data collection can be started or stopped simultaneously from any PA900.
- All PA900s share their IN, MID and OUT power totals and display the total of all PA900s and show the overall system efficiency data.
- Any VPA in any PA900 can make its' fundamental available to any other VPA(s) in any other PA900(s) by using one of the 3 available global fundamental frequencies.

### 21.1 INTERCONNECTING MULTIPLE PA900S

PA900s perform these abilities by communicating with each other via their LAN interfaces. You do not need to be using the LAN interface for communicating with the units via a computer as that can be accomplished using a different interface if desired, or there can be no interfacing to a computer.

#### 21.1.1 INTERCONNECTING NOT USING THE LAN INTERFACE WITH A COMPUTER

In this case the individual PA900s should typically be configured to use the AUTO-IP LAN interface mode. This allows the individual instruments to determine their own IP addresses and discover each other automatically.

Note:

- If only 2 PA900s are to be interconnected then simply use a standard LAN cable (CAT5e recommended) between the LAN ports of the PA900s without connecting them to a network. A cross-over cable is not required, but may be used if desired.
- If more than 2 PA900s are to be interconnected then a switch or hub must be used, with each PA900 LAN port connected to ports on that switch or hub. In situations where a great many units are to be interconnected then multiple switches or hubs may be used.
- The individual PA900s can be connected to each other via an existing network if desired. All such instruments must be visible to each other on that network. In this case it may be desirable to use DHCP or FIXED IP LAN modes instead of AUTO-IP.

#### 21.1.2 INTERCONNECTING WHILE ALSO USING THE LAN INTERFACES WITH A COMPUTER

In this case the PA900s communicate with each other over the LAN network to which each unit is connected using whatever LAN configuration is required for the network. All such instruments must be visible to each other on that network.

Note:

- The PA900s communicate with each other using UDP port 10734, such traffic must be able to be communicated between the PA900s through any intermediate routers. The PA900 uses IGMP to attempt to manage any routers, managed switches, or "snooping" switches, to allow the transmission of such traffic.

#### 21.1.3 HAVING SEVERAL GROUPS OF PA900S WITHIN A SINGLE NETWORK

Each PA900 can be configured to operate its multi-unit capabilities within a defined group number. This is configured by you on the Multi-Unit Configuration Screen (see below) and can be any numeric value between 0 and 255 inclusive. There is no particular significance to the group number other than only PA900s configured for the same group number provide the multiple unit capabilities. Each group may have up to 1000 members, and there may be 256 such groups, so the maximum number of PA900s which can be connected to the same LAN segment is 256,000.

### 21.2 CONFIGURING MULTI-UNIT CAPABILITY

Each PA900 used within an interconnected multi-unit group needs to be configured for which group number they are a member of, and which global fundamental data (if any) is being provided by each VPA in the PA900. This achieved by using the MULTI-UNIT button from the Interface configuration screen as follows –

- Press the Interface information area on most screens to access the Interface Configuration screen.
- Press the MULTI-UNIT button at the top of this screen to access the Multi-Unit Configuration screen (an example of this screen is shown below).
- Either turn OFF multi-unit capabilities, or turn them ON and select the multi-unit group number using the OFF/GROUP n button at the top of this screen.
- For each configured VPA within this PA900 you can select for that VPA fundamental to be provided globally to all PA900s within the multi-unit group by selecting that it be provided to all units as the GFUND1, GFUND2 or GFUND3 data. Note –
  - Only a single unit and a single VPA within that unit can provide data to any given GFUND data.

- Any number of VPAs in any number of PA900s may use each GFUND measurement data (including a VPA within the same PA900 which is providing the data).
- A GFUND data cannot be circularly configured, e.g. if VPA1 within a PA900 is configured to use GFUND1 as its fundamental then VPA1 within that PA900 cannot be configured to provide the VPA1 fundamental as GFUND1.
- If a conflict is discovered in a GFUND data provided by this PA900 (i.e. another PA900 is also configured to provide this data) then the button is colored RED.
- You can display a list of the units discovered within the configured multi-unit group in the OTHER MEMBERS area of the Multi-Unit Configuration screen (other than the PA900 on which it is being displayed). Typically this can take a few seconds to respond to other PA900s being taken into or out of service or their multi-unit configuration being changed. If more than one other unit is detected then PREV and/or NEXT buttons are provided to scroll between the discovered units. The information displayed for each discovered unit includes –
  - The identity name (if any) for that unit.
  - The IP address of that unit.
  - If that unit is configured for SYNC mode measurements.
  - If that unit provides any IN, MID and/or OUT measurement data.
  - If that unit is configured to provide any GFUND measurement data.

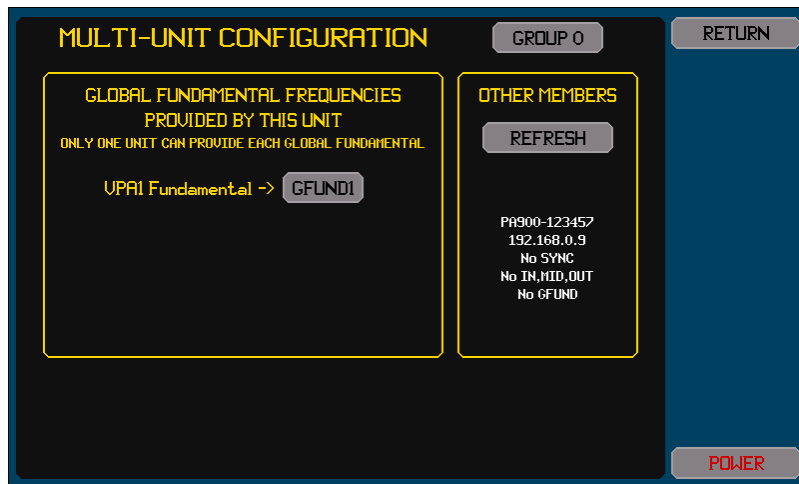

### 21.3 SYNCHRONIZING MEASUREMENTS WITHIN A GROUP OF UNITS

All PA900s configured within the same Multi-Unit group number, and are connected to each other, and are configured for SYNC measurement mode (see 12.4.1) will start their measurements at the same time and another measurement cannot be started until all such measurements have been completed within all VPAs in all configured units in this manner. See section 22 for further details regarding this.

Note:

- Only units configured to use the SYNC measurement mode are synchronized in this manner.
- Other than configuring the required units to use the SYNC measurement mode, no other configuration is necessary to achieve this capability.

Recommendation:

- This capability should only be used when necessary; measurements are generally not continuous when operated in this manner. Typically this is only useful when units are measuring values which vary considerably over time and even in such situations typically simply using a faster measurement period and result response averaging is usually recommended.

### 21.4 HOLDING AND RELEASING MEASUREMENTS IN A GROUP OF UNITS

Holding or releasing measurements using the front panel or an interface on any PA900 within a multi-unit group affects all units within that group simultaneously, no configuration is necessary to achieve this capability.

### 21.5 STARTING, STOPPING AND CONFIGURING INTEGRATION IN A GROUP OF UNITS

Starting and/or stopping integration using the front panel or an interface on any PA900 within a multi-unit group affects all units within that group simultaneously, no configuration is necessary to achieve this capability. The integration configuration of the unit on which integration was started is automatically used within all such units. See section 15 for details regarding integration.

### 21.6 STARTING AND STOPPING HISTORICAL DATA COLLECTION IN A GROUP OF UNITS

Starting and/or stopping historical data collection using the front panel or an interface on any PA900 within a multi-unit group affects all units within that group simultaneously, no configuration is necessary to achieve this capability.

Note:

- The times and dates shown on the screen for each unit within such a group are determined within each specific PA900, so differences in the displayed data may be seen. The actual starting date/time is the same for all such units.

## **21.7 IN, MID AND OUT TOTAL POWER AND EFFICENCY DATA IN A GROUP OF UNITS**

All units within a multi-unit group automatically provide their IN, MID and OUT power data to all other members of the group without needing configuration. The IN, MID, OUT and Efficiency data available from any individual PA900 within the group always includes the data from all members of the group.

## 22 SYNCHRONIZING MEASUREMENTS BETWEEN VPAS

The PA900 can be configured to synchronize the starting time of measurements in different VPAs to accommodate measurements of power loss and efficiency when the power levels are varying rapidly over time. This is always possible within a single PA900 and optionally also between multiple PA900s using the Multi-Unit capabilities (see section 21).

This is achieved by selecting the SYNC measurement mode in the PA900 (for a single PA900) or in each PA900 which it is desired to synchronize within a Multi-Unit group.

Note:

Not all units in a Multi-Unit Group need to be configured with the same measurement mode, the same measurement period or to use the same fundamental frequency.

Selecting the SYNC measurement mode only has any benefit when it is desired to accurately track power loss and/or efficiency during significant changes of power level. In most applications the SYNC mode is not recommended.

Synchronizing VPAs in this manner causes all such VPAs except for the one with the longest measurement period to have small gaps between their measurement periods during which no measurement is being made. Typically this has little consequence and is not specific to the PA900 but applies to any synchronized measurement periods having different lengths.

This is not the same as selecting for the measurement period of a VPA to be synchronous to that of another VPA in the same PA900 by setting the PERIOD setting in one VPA to another VPA in the same PA900 (see 12.4.2.2.1 for details regarding this) as configuring in that manner selects that both VPAs have exactly the same measurement period and forces them to use exactly the same fundamental frequency for measurement synchronization (this is only available within a single PA900). When configured for SYNC mode, even in different PA900s, you can configure any VPAs to use the same fundamental frequency and so have the exactly the same measurement period length by using the FUND configuration setting or they can each independently derive their own fundamental frequencies as needed.

Within a single PA900, or within multiple PA900's in the same Multi-Unit group, if configured in SYNC measurement mode all VPAs perform synchronization collectively as follows –

After completing every measurement period every such VPA checks if all other VPAs in the collection are presently waiting after completing their measurement periods. If all such VPAs have already completed their measurement periods then all VPAs are commanded to start a new measurement period, otherwise this VPA waits to be commanded by another VPA to start a further measurement period and informs all other VPAs as such (using a multi-cast packet within a Multi-Unit group if synchronizing multiple PA900's).

In this manner each VPA may optionally be configured with a different measurement period (or not), whether by setting a different PERIOD setting for each or because VPAs have different signals to which they are synchronizing their measurement periods (i.e. each is measuring signals having different and unrelated frequency content).

Within a single PA900 the starting times of such measurements are synchronized to within 10 $\mu$ s, and for VPAs in different PA900's using the Multi-Unit capability this is extended slightly by the LAN interface delay. The synchronizing information passed between multiple PA900's is a single minimum length packet on the LAN interface which is multicast to all configured PA900's with the highest priority, so typically this incurs an additional delay of 6.4 $\mu$ s times (1 + the number of intervening switches in the network topology).

The effect of such slight differences between the starting times of the measurements is typically quite minor as described below-

These differences only effect measurements of power loss and efficiency when signals are changing; there is no error if the signals are not substantially changing and there is no error in the measurements of power within each VPA itself under any circumstances.

Since multiple PA900s use multi-casted communications for synchronization and almost all switches forward multi-casted packets virtually simultaneously between ports, this delay is not dependent on the number of PA900s in a Multi-Unit Group. The worst case delay (for a 100M LAN) between multiple PA900's with a single intervening switch is 152 $\mu$ s if both a) there is other traffic present on that network portion at exactly the same time as one PA900 finishes a measurement period and b) that traffic has the maximum packet length and c) is destined for one of the PA900s being synchronized. Traffic between other network nodes has negligible affect for typical switches as they employ different packet buffers and routing between nodes.

Irrespective of the cause of these delay errors, they are not cumulative. I.e. the error over 5 measurement periods is 1/5<sup>th</sup> of the error over one measurement period. In many circumstances it is useful to use this to advantage by selecting a faster nominal measurement period in every VPA and selecting for averaging using the same RESPONSE setting in each VPA.

If all such VPAs are configured for 100ms nominal measurement periods then the worst-case error in power loss or efficiency measurements is 0.001% of the inter-measurement change per  $\mu$ s of delay between VPAs (or 0.01% if configured for a period of 10ms, or 0.00033% if configured for 300ms). Within the same PA900 this yields a worst case error of 0.01% of the change, or typically 0.0164% of the change with different PA900's without intervening switches. As an example using 100ms measurement periods, if a power level suddenly changes from 100W to 200W during a single 100ms measurement period, then there is a possible error of up to 0.01% of 100W (i.e. 10mW) in power loss/efficiency in that one 100ms measurement period in which the 100W power level change occurred but there is no error in the measured power loss or efficiency in any measurement period either before or after the change.

If such VPAs are measuring signals having different frequency content then the differences in measurement periods caused by that different content is typically of more significance than errors caused by synchronization delays. This is because the measurement periods are not the same and so exact synchronization is not possible. It is not possible to give a general typical figure for this effect, but the measurement period for every VPA can be estimated by calculating the period of the nearest integer number of fundamental cycles in the configured measurement period and then calculating the difference between the

shortest and longest such measurement period. For example, if one VPA is measuring mains at a frequency of 50Hz, and another is measuring the output of an electronic lighting ballast at a frequency of 15.23456kHz and both are set for a measurement period of 100ms, then the first measurement period will be that of 5 cycles (i.e. 100ms) while the second will be that of 1523 cycles (i.e. 99.97ms) so this incurs an additional 30µs of difference (i.e. an error of 0.03% of change between measurement periods). It should be noted that this error is typically far less than that caused by the common industry practice of erroneously forcing all measurement periods to be exactly the same as that causes all but one of the signals to be incorrectly measured whether the signal levels are changing or not. The PA900 does not force all measurement periods to be identical.

Range changes typically have the most dominant effect as they very significantly elongate a measurement period (possibly by 10:1 or more) only in the affected channel(s). There is a common industry practice of requiring a range change for changes in voltage and/or current levels of 3:1 or less which is very dominant in these situations as such a change forces loss of synchronization and the inaccuracy caused by forcing the highest suitable range is generally much larger than the inter-measurement delay errors (e.g. if inaccuracy is specified as 0.05%range then that is an error of up to 0.45% caused by selecting a fixed range which is only one range higher than needed for that particular level). In the PA900 this is of far less consequence as a range change can only occur in D type current option channels, only takes 1ms, is only a single range change, only occurs when a very large change in current level occurs (1000:1), and has a negligible effect on accuracy.

#### Recommendation:

As discussed above there is considerable multi-cast LAN traffic when measurement periods are being synchronized between multiple PA900's in this manner. This can have a slight effect on other network traffic if it is allowed to traverse the entire network. Multi-cast traffic is not passed through a correctly configured router and also IGMP "snooping" switches can be used which limit multi-cast traffic to only those nodes which request it (i.e. only PA900's). When multiple PA900's are synchronized in this manner it is recommended to limit any effects on the remainder of the network by using such devices as needed.



USB Drive Port

USB Drive Info Area

The Front Panel USB Port can be used with a USB Drive for many purposes, among which are –

- Exporting the configuration as an importable binary file.
- Exporting the custom screen definition as an importable binary file.
- Exporting the Volts and Amps Harmonics Limits as an importable binary file.
- Exporting all measurements (including harmonics listings) to a file in tabular ASCII (CSV) format.
- Exporting Volts, Amps and Watts harmonics listings to a file in tabular ASCII (CSV) format.
- Exporting Volts, Amps and Watts spectrum listings to a file in tabular ASCII (CSV) format.
- Exporting Volts and Amps single cycle waveforms to a file in tabular ASCII (CSV) format.
- Exporting Volts and Amps waveforms captured by SCOPE VIEW to a file in tabular ASCII (CSV) format.
- Exporting historically logged selected measurements to a file in tabular ASCII (CSV) format.
- Exporting a binary image file in BMP format of most screens.
- Data Logging selected measurements (including harmonics listings) to a file in tabular ASCII (CSV) or a binary format.
- Importing a previously saved binary configuration.
- Importing a previously saved binary or user generated ASCII (CSV) custom screen definition file.
- Importing previously saved binary or user generated ASCII (CSV) Volts and/or Amps Harmonic Limits file.
- Importing factory updates.

### 23.1 DRIVE COMPATIBILITY

A wide variety of drives are compatible with the PA900. These must meet all of the following requirements-

- The drive must be directly connected to the Front Panel USB Port, a hub must not be used and an extension cable is not recommended.
- Meet the requirements of the USB Mass Storage Class specification and be a single physical drive (some multi-drive convertors cannot be used).
- Meet USB2.0 or higher using full-speed (note that if marked as High Speed then it also meets the Full Speed requirement).
- Require less than 500mA of power from the USB port (some USB3.0 drives do not meet this requirement).
- The drive must use 512 bytes per sector (this is a requirement of the USB Mass Storage Class but there are a few drives which do not use this sector size).
- The drive may be partitioned, but only the first FAT32 (as defined by Microsoft) partition will be used and it must be <4Tbyte in size. In most cases you can reformat the drive to meet this requirement. Generally, drives or partitions <1Gbyte cannot be formatted with FAT32 however.

### 23.2 CHECKING DRIVE COMPATIBILITY

If a drive is compatible with a computer that does not necessarily mean that it will be compatible with the PA900 and vice versa. The PA900 requires the drive to meet a small sub-set of the standards, so even drives that do not fully meet the standards are often compatible.

The best method to check if a drive is compatible with the PA900 is to insert it into the front panel USB drive port. The USB Drive Info area on any main screen of the PA900 shows the connection status.

The indications are as follows (assuming no data logging is active) –

**NO USB DEVICE ATTACHED.** The PA900 has not detected that any device is attached, typically the PA900 will detect a device is attached within about 1 second, if the drive is attached but the PA900 remains showing this for an extended period of time then the drive is not compatible with USB2.0 full-speed operation and should be removed.

**USB DEVICE ATTACHING.** This indicates that the PA900 has detected the device as being attached and is performing the initial USB enumeration of the device. This typically takes about 1 second, but on some drives may take a little longer.



USB DEVICE FAULT.	This indicates that the PA900 has detected the device as being attached but the device failed to enumerate properly. This may indicate that the device draws more than 500mA of power or that the drive is not compatible with the USB2.0 specification. The drive should be removed and after waiting a few seconds it should be reinserted, if the message returns then the drive is not compatible with the PA900 (this can also sometimes be caused by a partial or intermittent insertion of the drive into the PA900 – it is recommended to check if the connections are clean).
USB DEVICE INCOMPATIBLE.	This indicates that the drive has enumerated correctly, but that the drive is either not detected as a Mass Storage Class device or has multiple drives, and so is not compatible with the PA900.
USB DRIVE MOUNTING.	This indicates that the PA900 has detected the drive and is attempting to mount the drive. For some drives this can take several seconds, portable hard drives can take even longer as the drive must achieve the correct rotation speed before it will mount.
USB DRIVE INCOMPATIBLE.	This indicates that the drive has been correctly detected and has been correctly mounted, but inspection of the drive has not found a valid FAT32 partition for the PA900 to use. The drive may need to be formatted. Not all drives are formatted with FAT32 when purchased (but most are) so require formatting on a computer before they can be used with a PA900.
USB DRIVE READY.	This indicates that the drive has been successfully enumerated and mounted and is compatible with the PA900. There is a very small possibility that the drive may fail compatibility at some later point in time, such as when reading or writing files, but this has never been seen and is very unlikely.

Note:

While data is transferring between the drive and the PA900 the background of the USB Drive Info area flashes a dark maroon color. Do not remove a drive while this is colored. Many drives have an LED (or similar), on many drives this indicates activity but on some drives this indicates connection state. Do not rely on a LED mounted on the drive for deciding whether a drive can be safely removed.

If using a computer running Windows to format a drive -

Depending on the size of the drive, the default for Windows may not be the FAT32 format. In those cases you should ensure that the FAT32 format is selected before starting to format the drive.

For best performance, the Allocation Unit Size (or cluster size) should be set to a setting of 8kbytes or higher (for most drives 16k is optimal for speed).

For reasons unknown to Vitrek, some drives cannot be formatted by Windows to the FAT32 format. In those cases you may need to obtain a third party drive format application to format the drive. There are several that are free of charge available on the internet.

## 23.3 FILES

The PA900 only operates on files in the root directory of the drive and only uses the 8.3 filename format.

The PA900 does not include the ability to format a drive nor for file management. These actions should be performed using a computer if required.

Note:

By definition, 8.3 filenames are not case sensitive so the use of uppercase letters is recommended in filenames to avoid confusion.

The following file names may not be used except for specific file types –

MLO  
PA900.S19  
PA900.HEX  
WELCOME.IMG  
VHLIMIT.CSV  
AHLIMIT.CSV  
CUSTOM.CSV

## 23.4 CHECKING THE DRIVE FILE STRUCTURE

If a drive is accidentally removed, or the PA900 has power removed, while activity is in progress then it is possible that the file structure of the drive has been damaged. It is recommended to use a utility program on a computer to check for and repair any file structure damage which may have occurred if this is suspected.

## 23.5 EXPORTING FILES TO A DRIVE

This is achieved by pressing the USB Drive Info area while a drive is correctly attached. This initiates a screen which allows you to export files.

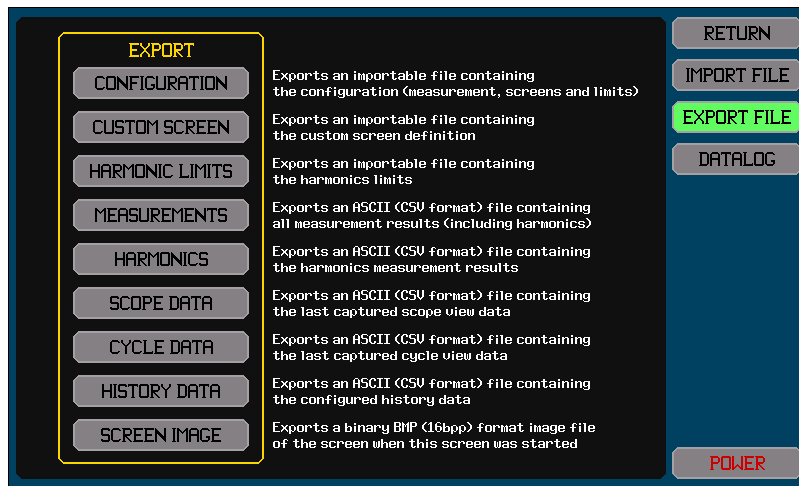

Next to each button are descriptions of the file which will be exported to the drive if the corresponding button is pressed.

After pressing the button for the type of file to export the following occurs –

1. You are prompted to enter the filename of the file to be exported (the extension is automatically provided).
2. If the file specified already exists you are asked if it is OK to overwrite the file.
3. For some types of files you are asked for which VPA to export the selected data.
4. The selected data is then written to the selected file.  
The right side of the screen shows the export progress and when completed you may press another button for a further USB drive activity or press the RETURN button to return to the screen which was being viewed when the USB Drive Info area was initially pressed.  
If the POWER button is pressed while file activity is in progress then the power off is delayed until it is completed.

### 23.5.1 SCREEN IMAGE FILE (.BMP EXTENSION)

The image generated is that of the screen which was present when the USB Drive Info Area was first pressed. Many of the screen images shown in this document were generated in this manner.

This is a standard 16bpp BMP format file (as defined by Microsoft and Adobe) with 800 x 480 pixel size. Most image processing and viewing programs can open this file format, but it has been found that some photo image software (e.g. Google Picasa) cannot as the 16bpp format is not commonly used for photographs (but is commonly used for graphics images).

Gimp, Adobe Photoshop, Windows Photo Viewer, Paint, and Word are just a few examples of programs which can open these files (these program names may be trademarks of their respective owners).

These files are quite large (751Kbytes) and are uncompressed images for maximum quality.

### 23.5.2 BINARY (.CFG EXTENSION) FILES

These types of exported files have a proprietary binary format and are intended to be later imported into a PA900.

You can have as many files of these types of files on the drive as you wish, so you can have many different configurations, custom screens or sets of harmonics limits etc. available to the PA900 in this manner. You can also share these between different users of PA900's, or use them to maintain a record of a configuration used.

#### 23.5.2.1 CONFIGURATION FILE

The file contains:

- All screen configurations.
- The custom screen definition.
- All measurement configurations.
- Any voltage and current harmonics limits defined.
- The measurement preference settings.

The file does not contain the power preference setting, the interface configuration or the time and date format configuration settings. These files are approximately 17K bytes in length.

#### 23.5.2.2 CUSTOM DATA SCREEN DEFINITION FILE

These files are approximately 12K bytes in length.

#### 23.5.2.3 HARMONIC LIMITS FILE

This file contains both voltage and current harmonic limits.

These files are approximately 5K bytes in length.

### 23.5.3 COMMA SEPARATED VALUE (.CSV EXTENSION) FILES

These types of exported files are in the CSV ASCII format and have the .CSV extension in the filename.

These are tabulated files of data suitable for directly importing into many spreadsheet (e.g. Excel™) programs or text editors.

Each file is formatted as records (or rows or lines) of columns of data.  
Each file has headings as the first record describing each column of data.

**Recommendation:**

It is not recommended to rely on specific data being in a specific location in the file. Future updates may add measurement results from time to time, and measurement result availability may depend on configuration, channel content, and options installed. This may mean that a specific result is not always in exactly the same position in the file. The file contains column headings (and row headings for some formats), it is recommended to use these to determine the meaning of results in specific locations of the file.

**Note:**

Some data may be blank, this indicates that the measurement is not available.

Unless otherwise shown, all data is in scientific numeric format using the natural units for the measurement.

### 23.5.3.1 MEASUREMENTS FILE

The file contains every measurement, including harmonics, in all VPAs and all channels.

These files are variable in length and can be up to 350K bytes long.

The first column of every record contains the description of that measurement, following that are the results for that measurement for each channel or each VPA as appropriate in each column.

There are separate sections of the file for channel based and VPA based data and the first record of each section are headers describing each column.

The first section is the data for each VPA, below is an example of the first few records of the VPA data section (only VPA1 has measurements available in this example).

```
DATA,VPA1,VPA2,VPA3
Frequency,+50.0373E+0,,
V13(pk),+0.00000E-9,,
V13(dc),+0.00000E-9,,
V13(ac),+0.00000E-9,,
V13(acdc),+0.00000E-9,,
V13(rect),+0.00000E-9,,
V13(CF),+0.00000E-9,,
V13(FF),+0.00000E-9,,
V23(pk),+0.00000E-9,,
V23(dc),+0.00000E-9,,
```

As shown above, some of this data is labelled V13 or similar, V13 indicates that the voltage is that measured on the 1<sup>st</sup> channel in the VPA, relative to that of the 3<sup>rd</sup> channel in the VPA and similarly for the others.

The second section is the data for each channel and there is also a blank record between the sections, below is an example of the first few records of the channel data section (only channel 2 has measurements available in this example).

```
DATA,CH1,CH2,CH3,CH4
Frequency,,+50.0373E+0,,
Voverload,,0,,
Aoverload,,0,,
V(hipk),,+340.222E+0,,
V(lopk),,-340.329E+0,,
V(pk),,+340.329E+0,,
V(valley),,+340.169E+0,,
V(pk-valley),,+160.217E-3,,
V(dc),,-56.2930E-3,,
V(ac),,+247.463E+0,,
V(acdc),,+247.463E+0,,
V(rect),,+221.627E+0,,
V(CF),,+1.37527E+0,,
V(FF),,+1.11657E+0,,
A(hipk),,+410.819E-3,,
A(lopk),,-411.306E-3,,
A(pk),,+411.306E-3,,
```

Next is the harmonics section, as a continuation of the channel section. Harmonics are listed up to the highest harmonic measured in any channel. All phase data is in degree units. Below is an example of the first few lines of the harmonics results section (only channel 2 has measurements available in this example).

```
Vrms H1,,+247.348E+0,,
Vphase H1,,+0.00000E-9,,
Arms H1,,+85.3248E-3,,
Aphase H1,,+24.2236E+0,,
Vrms H2,,+136.983E-3,,
Vphase H2,,+162.880E+0,,
Arms H2,,+445.047E-6,,
Aphase H2,,+66.5414E+0,,
Vrms H3,,+1.69455E+0,,
Vphase H3,,+119.687E+0,,
Arms H3,,+71.7911E-3,,
Aphase H3,,+99.8311E+0,,
Vrms H4,,+52.4739E-3,,
Vphase H4,,+170.166E+0,,
```

### 23.5.3.2 HARMONICS FILE

This type of file cannot be exported when the MEAS MODE setting on the MEAS CONFIG screen is set to SPECTRUM.

This file contains the Volts, Amps and Watts harmonics for each channel in the selected VPA.

These files are variable in length, can be up to 130K bytes long and may contain up to 501 records.

The first record contains a heading describing each column.

The first column of every record contains the harmonic number, following that are columns for each channel and signal.

Below is an example of the first few lines (without showing the end of each line for clarity).

```
HARMONIC, FREQUENCY, CH1V, CH1Vphs, CH1A, CH1Aphs, CH1W, CH2V, CH2Vphs, CH2A, CH2Aphs, CH2W...
1, +50.0000E+0, +6.97876E+0, +0.00000E-9, +55.4819E-3, +42.6391E-3, +387.195E-3, +118.166E-6, ...
2, +100.000E+0, +2.63699E-3, -86.5401E+0, +19.1173E-6, -89.4316E+0, +50.3517E-9, +229.248E-9, ...
```

### 23.5.3.3 SPECTRUM FILE

This type of file can only be exported when the MEAS MODE setting on the MEAS CONFIG screen is set to SPECTRUM.

This file contains the Volts, Amps and Watts spectrum for each channel in the selected VPA.

These files are variable in length, can be up to 2.6M bytes long and may contain up to 16385 records.

The first record contains a heading describing each column.

The first column of every record contains the frequency for that record, following that are columns for each channel and signal.

Below is an example of the first few lines (without showing the end of each line for clarity).

```
FREQUENCY, CH1V, CH1A, CH1W, CH2V, CH2A, CH2W, CH3V, CH3A, CH3W, CH4V, CH4A, CH4W
+5.00027E+0, +19.3319E-3, +201.972E-6, -3.90450E-6, +3.94747E-3, +190.021E-9, ...
+10.0005E+0, +51.4375E-6, +797.568E-9, +0.02993E-9, +339.423E-6, +94.8379E-9, ...
+15.0008E+0, +86.7463E-6, +851.724E-9, +0.06808E-9, +200.026E-6, +58.1269E-9, ...
+20.0011E+0, +173.584E-6, +1.39412E-6, +0.10565E-9, +82.4952E-6, +183.892E-9, ...
```

### 23.5.3.4 SCOPE VIEW WAVEFORM FILE

This file contains all Volts and Amps signal waveforms for each channel as captured by the latest completed scope capture (this is not dependent on the traces configured for the SCOPE VIEW screen).

These files are variable in length, can be up to 4Mbytes long and may contain up to 32769 records.

The first record contains a heading describing each column.

The first column of every line contains the time in seconds units relative to the trigger point, following that are columns for each channel and signal.

All possible data columns are always included; data which is not captured has a blank field.

The file is always ordered in increasing time.

Below is an example of the first few lines of this file. All voltages are in volts units, all currents are in amps units, and the time column is in seconds units relative to the trigger point (only channel 2 has waveforms available in this example).

```
TIME, CH1V, CH1A, CH2V, CH2A, CH3V, CH3A, CH4V, CH4A
-37.3109E-3, , , +99.4792E+0, -4.54687E-3, , , ,
-37.2380E-3, , , +91.7955E+0, -2.06459E-3, , , ,
-37.1651E-3, , , +84.0672E+0, +2.82051E-3, , , ,
-37.0923E-3, , , +76.3141E+0, +3.01298E-3, , , ,
-37.0194E-3, , , +68.5283E+0, +4.84707E-3, , , ,
-36.9465E-3, , , +60.4204E+0, +2.24682E-3, , , ,
-36.8736E-3, , , +52.3775E+0, -1.87460E-3, , , ,
-36.8008E-3, , , +44.4456E+0, -107.568E-6, , , ,
-36.7279E-3, , , +36.6903E+0, -5.38010E-3, , , ,
-36.6550E-3, , , +29.1832E+0, -3.80430E-3, , , ,
-36.5821E-3, , , +21.8476E+0, -3.35975E-3, , , ,
-36.5093E-3, , , +14.7098E+0, -178.348E-6, , , ,
-36.4364E-3, , , +7.48967E+0, +1.59737E-3, , , ,
-36.3635E-3, , , +120.091E-3, +2.75470E-3, , , ,
-36.2906E-3, , , -7.38952E+0, +3.04030E-3, , , ,
-36.2178E-3, , , -14.9958E+0, -318.668E-6, , , ,
```

### 23.5.3.5 CYCLE VIEW WAVEFORM FILE

This file contains all Volts and Amps single cycle waveforms for each channel in the selected VPA (the same waveforms as viewable on the CYCLE VIEW screen, but not dependent on the traces configured for the CYCLE VIEW screen).

These files are variable in length, can be up to 57Kbytes long and always contains 513 records.

The file is always ordered in increasing time.

Below is an example of the first few lines of this file. All voltages are in volts units, all currents are in amps units, and the time column is the time in seconds units. This file can contain invalid data points at certain times because data at that specific time was not captured, you should interpolate between the surrounding valid points as needed.

```
TIME, CH1V, CH1A, CH2V, CH2A, CH3V, CH3A, CH4V, CH4A
+0.00000E-9, -26.0264E-3, -201.044E-6, +8.43946E+0, -503.817E-6, -1.20731E-3, +6.93599E-6, ,
+4.88278E-6, +95.3605E-3, +642.353E-6, +8.37996E+0, +340.689E-6, -6.12500E-3, +1.12330E-6, ,
+9.76557E-6, +208.673E-3, +1.47869E-3, +8.32045E+0, +1.15167E-3, +3.84172E-3, -8.02481E-6, ,
+14.6484E-6, +332.154E-3, +2.33160E-3, +8.25465E+0, +2.02310E-3, +8.46606E-3, +5.58841E-6, ,
+19.5311E-6, +456.807E-3, +3.19158E-3, +8.18958E+0, +2.84094E-3, -7.00548E-3, -6.89178E-6, ,
```

```
+24.4139E-6,+570.967E-3,+4.02716E-3,+8.12532E+0,+3.69523E-3,+2.50181E-3,-3.62742E-6,,
+29.2967E-6,+691.224E-3,+4.89038E-3,+8.05385E+0,+4.51385E-3,+7.29706E-3,+531.195E-9,,
+34.1795E-6,+819.305E-3,+5.75712E-3,+7.98462E+0,+5.39458E-3,-7.69836E-3,-2.13687E-6,,
+39.0623E-6,+935.345E-3,+6.58707E-3,+7.92010E+0,+6.18618E-3,-9.43694E-3,-7.59902E-6,,
+43.9451E-6,+1.04597E+0,+7.39428E-3,+7.84676E+0,+7.01683E-3,+1.06170E-3,+3.92235E-6,,
+48.8278E-6,+1.17663E+0,+8.26958E-3,+7.77180E+0,+7.86220E-3,+8.23923E-3,+5.63256E-6,,
+53.7106E-6,+1.29847E+0,+9.11749E-3,+7.70139E+0,+8.71496E-3,-10.0168E-3,-8.82787E-6,,
+58.5934E-6,+1.40948E+0,+9.94132E-3,+7.62663E+0,+9.49106E-3,-9.59577E-3,-10.1849E-6,,
```

### 23.5.3.6 HISTORICAL MEASUREMENT FILE

The contents of this file are configured by the trace selections on the HISTORY screen. The file covers the period of time in 8192 equally spaced time increments between when the history log was started up to either when the file is generated or when it was previously stopped.

This contains the maximum, average and minimum measured data during each preceding time increment. Unlike data logging, this is guaranteed to include all data measured during that time increment so it actually has better event capture capability and extent recording capability than a data log file and is considerably smaller and easier to generate, particularly if measurement extents or trend analysis is the intention.

These files are variable in length, can be up to 1.3M bytes long and always contains 8193 records.

Note:

If further traces covering the same period of time are wished to be exported in another file then stop the historical record first, then repeatedly configure the desired traces and export the file for those traces, until all required traces have been exported.

Below is an example of the first few lines of this file. The time column is the time in seconds units. This file can contain invalid data points at certain times because data at that specific time was not captured, you should interpolate between the surrounding valid points as needed.

```
TIME,Max CH2:Hz,Avg CH2:Hz,Min CH2:Hz,Max CH2:V:CPL,Avg CH2:V:CPL,Min CH2:V:CPL,...
+783.813E-3,+50.0000E+0,+50.0000E+0,+50.0000E+0,+247.097E+0,+247.097E+0,...
+1.56763E+0,+50.0000E+0,+50.0000E+0,+50.0000E+0,+247.121E+0,+247.109E+0,...
+2.35144E+0,+50.0000E+0,+50.0000E+0,+50.0000E+0,+247.121E+0,+247.121E+0,...
```

## 23.6 IMPORTING FILES FROM A DRIVE

The PA900 can import configuration or update files from a drive. This is achieved by pressing the USB Drive Info area while a drive is correctly attached.

This initiates a screen in which you should press the IMPORT FILE button to initiate the import file screen, and example of which is shown below.



The right side area of the screen shows a listing of the files which may be imported for the file type selected by the buttons on the left side (the IMPORT area). Which file type is being shown is indicated by the respective button in the IMPORT area being highlighted colored green. To change the type of file listed press the desired IMPORT area file type button.

The files (if any) are listed as buttons in the right side area, with each button showing the filename and file date, if a large number of files are available then there are scroll buttons shown to allow you to scroll through the list. To import a file press the button for that specific file in the file listing area. The right side area of the screen then changes to indicate the progress of the import. After completion you may press any of the IMPORT area buttons to repeat this, or may press the EXPORT DATA button to export a file, or press the RETURN button to return to the screen which was being viewed when the USB Drive Info area was initially pressed.

### 23.6.1 IMPORTING BINARY CONFIGURATION, CUSTOM SCREEN AND HARMONIC LIMITS FILES

These are binary files which have been previously exported by a PA900. The PA900 automatically recognizes these files by their contents and no specific filenames or extensions are assumed by the PA900.

---

## 23.6.2 CREATING AND IMPORTING AN ASCII HARMONICS LIMITS FILE

You can create an ASCII format harmonics limits file for either voltage or current limits on a computer using a plain text editor such as Windows Notepad.

The file must be named VHLIMIT.CSV to define the voltage harmonics limits, or AHLIMIT.CSV to define the current harmonics limits. If present, these files are listed along with any binary harmonics files present on the drive when the HARMONIC LIMITS file type is selected in the IMPORT area of the screen.

Each line of the file must contain the following fields in the order shown with the comma character separating each field –

1. The letter H.
2. A number of characters forming an integer between 1 and 500 inclusive which sets the harmonic for which a limit is being set by this line.

The fundamental is harmonic 1.

If more than one line sets the limit for a harmonic, the last one is used.

The file does not need to define every harmonic; harmonics not included in the file are not checked against a limit.

3. Either the character 1 if the limit is to be the highest of the percentage and level limits, or 2 if the limit is to be the addition of the percentage and level limits.
4. Either the character 0 if the percentage limit is to be the percentage of the fundamental amplitude or 1 if it is to be the percentage of the total signal.
5. A number of characters forming a floating number which is the percentage limit (in percent).
6. A number of characters forming a floating number which is the level limit (in Volts or Amps).

The file may contain blank lines if desired.

A simple example of the contents of such a file is-

```
H,2,1,0,0.1,1  
H,3,2,1,0.2,2
```

This sets limits as follows –

1<sup>st</sup> line: For harmonic 2, the higher of 0.1% of fundamental or 1V or A

2<sup>nd</sup> line: For harmonic 3, the addition of 0.2% of signal and 2V or A

---

## 23.6.3 CREATING AND IMPORTING AN ASCII CUSTOM SCREEN DEFINITION FILE

You can create an ASCII format custom screen definition on a computer using a plain text editor such as Windows Notepad.

The file must be named CUSTOM.CSV.

If present, this file is listed along with any binary custom screen definition files present on the drive when the CUSTOM SCREEN file type is selected in the IMPORT area of the screen.

A custom screen is like a spreadsheet composed of 57 cells arranged in 15 rows with row 0 (the topmost row) only having a single column (column 0) and rows 1 through 14 having 4 columns (the leftmost column is 0, the rightmost is 3).

For cells other than the row 0 cell, for text sizes other than 12pix or 16pix the target cell is expanded to include surrounding cells as follows –

22pix text size: includes the cell to the right of the target cell.

28pix and 36pix text sizes: includes the cell to the right of the target cell and also the cells immediately below both the target cell and that to the right of it.

Note that the length of the text in a cell might cause the cell to be overrun into adjacent cells for any text height defined. You may need to adjust your definition to obtain the desired format.

Each line of the file defines one cell in the custom screen and may be defined in any order in one of the following formats –

### 23.6.3.1 DEFINING A BLANK CELL

Lines to define a blank cell are not needed as all custom screen cells always start as blank when reading the definition from a file, however you may wish to include blank cell definitions for improved readability of the file.

This is defined by a line containing the following fields in the order shown with the comma character separating each field –

1. The letter C.
2. A number of characters forming an integer between 0 and 14 inclusive which sets which row the cell is in which this line defines.
3. A numeric character between 0 and 3 inclusive which sets which column the cell is in which this line defines.

### 23.6.3.2 DEFINING A CELL WHICH IS TEXT ONLY

This is defined by a line containing the following fields in the order shown with the comma character separating each field –

1. The letter C.
2. A number of characters forming an integer between 0 and 14 inclusive which sets which row the cell is in which this line defines.
3. A numeric character between 0 and 3 inclusive which sets which column the cell is in which this line defines.
4. A numeric character which defines the character font size for this cell as follows –  
0: Text which is 12pix high

- 1: Text which is 16pix high
- 2: Text which is 22pix high
- 3: Text which is 28pix high
- 4: Text which is 36pix high
- 5. A numeric character which defines the text horizontal justification for this cell as follows –
  - 0: Text is left justified
  - 1: Text is centre justified
  - 2: Text is right justified
- 6. Three sets of characters separated by the colon character each of which forms an integer between 0 and 255 inclusive, setting the intensity for the red, green and blue colors respectively.
- 7. A blank field (no characters)
- 8. A blank field (no characters)
- 9. Up to 60 characters which defines the text to be shown in this cell.

### **23.6.3.3 DEFINING A CELL WHICH IS A MEASUREMENT RESULT**

This is defined by a line containing the following fields in the order shown with the comma character separating each field –

- 1. The letter C.
- 2. A number of characters forming an integer between 0 and 14 inclusive which sets which row the cell is in which this line defines.
- 3. A numeric character between 0 and 3 inclusive which sets which column the cell is in which this line defines.
- 4. A numeric character which defines the character font size for this cell as follows –
  - 0: Text which is 12pix high
  - 1: Text which is 16pix high
  - 2: Text which is 22pix high
  - 3: Text which is 28pix high
  - 4: Text which is 36pix high
- 5. A numeric character which defines the text horizontal justification for this cell as follows –
  - 0: The entire text is left justified
  - 1: The entire text is centre justified
  - 2: The entire text is right justified
- 6. Three sets of characters separated by the colon character each of which forms an integer between 0 and 255 inclusive, setting the intensity for the red, green and blue colors respectively.
- 7. A definition of the measurement result to show (see 24.5 RDEF Measurement Definition Sub-Fields for the allowed formats of this field).
- 8. A numeric character which sets which defines if the measurement result is to be followed by the applicable units character(s) as follows –
  - 0: No units character(s) will be included.
  - 1: Units character(s) will be included.

### **23.6.3.4 DEFINING A CELL WHICH IS A MEASUREMENT RESULT WITH LEADING TEXT**

This is defined by a line containing the following fields in the order shown with the comma character separating each field –

- 1. The letter C.
- 2. A number of characters forming an integer between 0 and 14 inclusive which sets which row the cell is in which this line defines.
- 3. A numeric character between 0 and 3 inclusive which sets which column the cell is in which this line defines.
- 4. A numeric character which defines the character font size for this cell as follows –
  - 0: Text which is 12pix high
  - 1: Text which is 16pix high
  - 2: Text which is 22pix high
  - 3: Text which is 28pix high
  - 4: Text which is 36pix high
- 5. A numeric character which defines the text horizontal justification for this cell as follows –
  - 0: The entire text is left justified
  - 1: The entire text is centre justified
  - 2: The entire text is right justified
- 6. Three sets of characters separated by the colon character each of which forms an integer between 0 and 255 inclusive, setting the intensity for the red, green and blue colors respectively.
- 7. A definition of the measurement result to show (see section 24.5 for the allowed formats of this field).



8. A numeric character which defines if the measurement result is to be followed by the applicable units character(s) as follows –
  - 0: No units character(s) will be included.
  - 1: Units character(s) will be included.
9. Up to 5 characters which define the text to be shown before the measurement result in this cell (this may be blank which has the same resultant cell as if the previous format was used).

### 23.6.3.5 EXAMPLE CUSTOM SCREEN ASCII FILE

A simple example of the contents of such a file is-

```
C,0,0,3,1,255:255:255,,,MEASUREMENTS
C,2,0,1,1,255:255:255,,,Ch2
C,3,0,1,1,255:255:255,V:CH2,1
C,4,0,1,1,255:255:255,A:CH2,1
C,5,0,1,1,255:255:255,W:CH2,1
C,6,0,1,1,255:255:255,VA:CH2,1
C,7,0,1,1,255:255:255,PF:CH2,1
C,8,0,1,1,255:255:255,FREQ:CH2,1
```

This sets the screen to be similar to that shown below.



### 23.6.4 UPDATING THE FIRMWARE OR THE FPGA

These files must have a specific filename.

There are several types of update files; most of these are associated with updating the firmware or the FPGA to a newly released update from Vitrek. Follow the instructions provided with the firmware or FPGA release to import and use these files.

### 23.6.5 CHANGING THE WELCOMING SCREEN

This file must have a specific filename of WELCOME.IMG and is in a proprietary binary format.

One of the file selection possibilities in the UPDATE type of file import is to change the welcoming screen shown on the PA900 when it is turned on. An application is provided with the PA900 allowing you to convert a standard image file into the format needed for this file. The image must be exactly 800 pixels wide by 480 pixels high to be used by this utility.

## 23.7 DATA LOGGING

The PA900 has the capability of data logging up to 16 user defined measurements (or sets of harmonics measurements) at a user defined interval. This can be performed to one of the following –

1. To an external USB Drive, using an internal 32Mbyte buffer to reduce the impact that drive speed has on the achievable data logging rate. The maximum rate of data logging will be limited by the drive speed (see section 23.7.8).
2. To the internal 32Mbyte buffer. This will be automatically transferred to the configured file on an external USB drive when one is subsequently connected. This internal buffer is volatile, the contents will be lost if power is removed from the PA900 or the PA900 is turned off. There is no restriction on the maximum data logging rate (other than the length of the buffer).
3. To an internal memory in the PA900. This memory varies in size between individual PA900 instruments, but is at least 2GBytes in length. This is non-volatile, that is the contents will not be lost if power is removed from the PA900 or the PA900 is turned off. The maximum rate of data logging will be slightly limited by the memory speed (see section 23.7.8).

Note:

Older PA900 instruments which are upgraded to firmware which has this capability might not have the capability of data logging to internal memory. Contact Vitrek for details regarding an upgrade if this is not available and it is desired.

Data which has been logged to internal memory can be exported to an external USB drive at any future time by returning to this screen and pressing the EXPORT button next to the information regarding the contents of the internal memory. The exported file can be in either ASCII (.CSV) or binary (.BIN) formats. Once data has been logged to internal memory it cannot be erased, it can only be overwritten by a further data logging operation to internal memory.

Data logging can create very large files; you should ensure that the drive has sufficient room available prior to starting data logging. If the maximum file size for FAT32 (4Gbytes) is reached or the drive becomes full prior to you stopping data logging then data logging is automatically stopped by the PA900 and a data logging error status is set.

Data logging to other than the internal memory allows you to insert the drive before, during or after performing the data logging. An internal 32Mbyte internal FIFO buffer is used to reduce the possibility of record loss caused by the absence of or a slow write speed of the USB Drive. For shorter data logging (<8M data) you can use this internal buffer for data logging and then save it to a drive later.

Data logging is not synchronous to any measurement period, but logs the latest measurements at each respective time interval.

In this document each set of data recorded at each data log interval is called a data log record, and each data within each record is called a data. When logging to internal memory, internal buffer, or an external binary file each data takes 4bytes. When logging to an external ASCII file each data has a variable length, but is typically 12bytes.

Prior to performing data logging you must configure the file details, data logging timing, and the file data contents. Initiating the screen which allows you to do this is achieved by pressing the USB Drive Info area. If data logging is not being performed and a drive is presently inserted then this will start the file import/export screen, in this case press the DATALOG button on that screen to access the data logging screen.

This screen can also be used to view the status of data logging while data is being captured. You can either stay on this screen or return to it later to view the status. You do not have to remain on this screen during data logging.

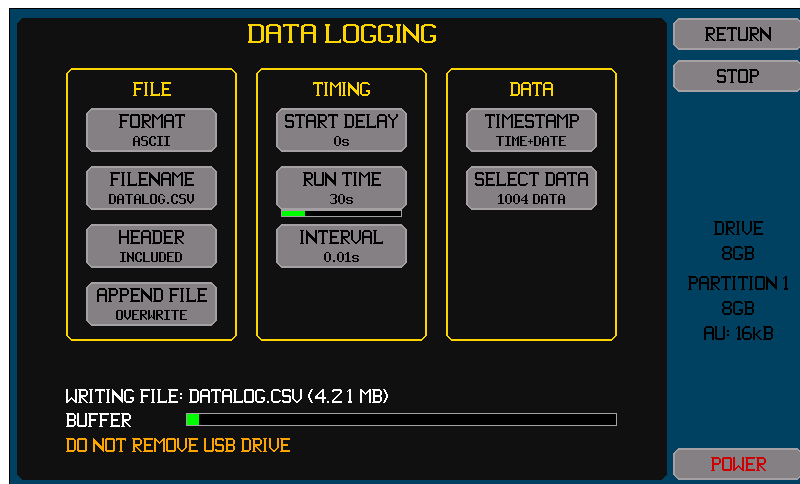

There are four areas on this screen, the lower area (shown in this example) showing the status is only shown if either a data logging activity is presently taking place or a previously run data log has been completed and a drive has not been both removed and inserted since then.

### 23.7.1 CONFIGURING THE DATA LOG

This is performed by using the buttons in the FILE Area.

The FORMAT button allows you to select if the file is to be written to an external drive with ASCII or BINARY data formats or is to be saved to INTERNAL memory.

If data is selected to be written to INTERNAL memory then there are no other buttons shown in the FILE area.

The internal memory in the PA900 is typically over 10x faster than external USB drives, allowing a faster data logging rate and/or more data to be logged.

After capturing a data log to internal memory, you can export this at a later time or date to an external drive in either ASCII or BINARY formats. You should note that the amount of time taken to export this may be considerable as external memory is considerably slower than the internal memory. You should also note that exporting this into an external drive using the ASCII format results in a file which is typically 3x larger than the internal memory data, which may exceed the maximum file size or the external drive size, in those cases you will need to export it in BINARY format and convert that file on a computer to the ASCII format.

If data is selected to be written in ASCII format then it is written as one record per line, with each data within the record being comma separated.

This is often called the CSV format and files generated in this format can usually be opened with commercially available spreadsheet programs (such as Excel) and with many data base programs.

You should first confirm that the application is able to open the size of file likely to be generated while data logging, for example some versions of Excel can only open a file with less than 65536 records.

If data is selected to be written in BINARY format then it can only be read using an application provided with the PA900, which converts the file to ASCII format.

A binary file is nominally 3x smaller than the equivalent ASCII file so more data can be written into the maximum allowed data log file size of 4Gbytes.

A binary file typically has a 3:1 faster writing speed than the equivalent ASCII file, allowing shorter intervals to be used when logging to a slower drive.

Although the binary file is limited to 4Gbytes in length, the resulting ASCII file may not be limited to this if it is saved in the supplied application to a drive which does not use the FAT32 format (most computer hard drives use NTFS or later formats which do not have this 4Gbyte limitation).

The FILENAME button allows you to set the name of the file which will be written.

Only filenames using the 8.3 form are allowed.

The extension is automatically provided (either .CSV or .BIN depending on the FORMAT setting).

The following file names may not be used –

VHLIMIT.CSV  
AHLIMIT.CSV  
CUSTOM.CSV

The HEADER button allows you to select if the file will start with a header record or not (this is only available for the ASCII FORMAT setting).

If a header is set to be included, then the first file record will contain a textual description of each column of data.

Recommendation:

It is recommended to always include a header. In this manner if the file is inspected at some later date it is not necessary to remember what each data column corresponds to.

The APPEND FILE button allows you to select what will happen if the specified file already exists on the drive when data logging is started (or the drive is subsequently inserted after starting it).

Recommendation:

APPEND should only be selected when it is known that the existing data has the same format. If set to append to an existing file then the existing contents of the file may not be of the correct format to allow the file to be opened on a computer after completing the data log.

---

## 23.7.2 CONFIGURING DATA LOGGING TIMING

This is performed by using the buttons in the TIMING Area.

The START DELAY button allows you to select if actual data logging is to start after a delay has expired following pressing the START button.

In the data entry screens for START DELAY there are four entries, one for each unit of days, hours, minutes and seconds.

The screen always starts with the days data selected; you can jump to any of the four entries directly by pressing the respective entry area.

You can enter a numeric between 0 and 99 into any of the four entries. The actual time used is the total time created by combining all four entries with their respective units.

When the ENT button is pressed the selected entry area automatically changes to next entry to the right, unless the seconds entry is selected when the action is same as pressing the overall RETURN button.

Pressing the RETURN button returns to the Data Logging Configure Screen and saves the configured time, whereas pressing the CANCEL button returns to the Data Logging Configure Screen without saving any changed data.

The RUN TIME button allows you to select if data logging is to run until manually stopped (MANUAL) or to run for a specific period of time. If set to run for a specific time then the entry of that time follows the same procedure as setting the START DELAY (above).

The INTERVAL button allows you to set the data logging interval. The entry of the interval follows the same procedure as that for the START DELAY and the RUN TIME (above), but uses a different set of four entries (hours, minutes, seconds, and 1/100<sup>th</sup> seconds). If an interval time of 0 is entered then 0.002 seconds is used.

---

## 23.7.3 CONFIGURING DATA LOGGING RECORD CONTENTS

This is performed by using the buttons in the DATA area.

The TIMESTAMP button allows you to select if each record is to contain the time of day and date information, or not.

The first data of every record is always the record number which continuously increments.

If enabled, the time of day is the second data of every record and in ASCII format it is formatted as the prevalent time format setting for the PA900 (i.e. 12 or 24 hour format).

If enabled, the date is the third data of every record and in ASCII format it is formatted as the prevalent date format setting for the PA900 (i.e. DD:MM:YYYY or MM:DD:YYYY).

Recommendation:

It is recommended to always select that a timestamp will be included, otherwise you will have no record of when a data log file was actually generated.

The SELECT DATA button allows you to select each of the 16 data selections which will be logged. The lower half of the button shows how many data in total (including the record number and any timestamp information) will be generated by the present selections for the SELECT DATA and TIMESTAMP settings. For the ASCII format, each data is typically 12 bytes of storage, otherwise each data is exactly 4 bytes of storage.

Pressing the SELECT DATA button starts a screen which allows you to enable or disable each of the 16 data selections and, if enabled, to select what data to log for each data selection. The screen shown below is an example of this screen.

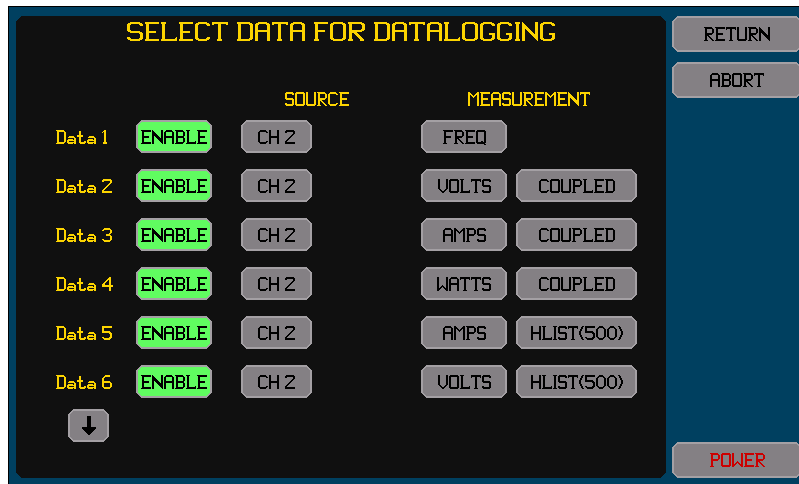

Only measurements which are presently configured to be measured can be selected while in this screen.

Each ENABLE button is highlighted (green) if the data is enabled; otherwise the ENABLE button is not highlighted and is colored grey.

If the SOURCE is selected to be from a VPA then there is a second SOURCE button which selects whether the total for the VPA or that from a specific phase of the VPA is to be used.

If a harmonic list is selected as the MEASUREMENT then you must also enter the number of harmonics to be listed. The listing always includes the fundamental up to and including this entered harmonic. If a harmonic is not being measured at the data log time then the respective data recorded is zero.

Typically each enabled entry is one field in the data log; however if a harmonic listing is selected the entry will create the same number of fields as the number of harmonics set to be listed.

You do not need to enable consecutive entries; the file will only contain fields for enabled entries in the order defined and skip over entries which are not enabled. If an entry is not enabled, any prior selection of the source and measurement data is still saved. In this manner you may have several different data logging data sets and change between them by changing which entries are enabled.

Pressing the RETURN button returns to the Data Logging Configure Screen and saves the configured data entries, whereas pressing the CANCEL button returns to the Data Logging Configure Screen without saving any changes.

#### 23.7.4 STARTING AND STOPPING DATA LOGGING

This is performed by using the START/STOP button on the right side of this screen.

Note:

If a data log has previously been performed but no drive was inserted to save that data and then a further data log is started, the data captured by the prior data log will be lost.

Stopping data logging only stops the collection of data, the data saved in the buffer is still written out to the drive or to internal memory. You can also stop this by pressing the ABORT button while not actively data logging but still writing the internal buffer, but doing so may produce a partial final record in the resulting file.

#### 23.7.5 CLEARING THE DATA FROM A COMPLETED UNSAVED DATA LOG

If a data log is performed to an external USB drive but is completed without a drive being inserted to save that data then this prevents any other USB Drive activity (such as importing or exporting a file) from being performed until this data is either saved to a drive or it is cleared. The data may be cleared by pressing the CLEAR button on the right side of this screen. The CLEAR button is only shown when a data log has been completed but no data from it has been saved to a drive.

#### 23.7.6 VIEWING DATA LOGGING STATUS

You can remain on this screen, or can return to this screen, to show the status of a progressing data logging activity.

The status information shown in the lower area of this screen is –

If logging to internal memory: The amount of that memory used and the total available.

If logging to an external drive (or to the internal buffer): The filename of the data log file and the present size of it.

A description of any errors which have occurred.

A bar which shows the amount of the internal memory buffer which is presently used (a green bar growing from the left as more buffer is used), and the maximum amount used (a vertical line within the bar area). If this indicates that a significant amount of the buffer has been used (>75%) then you should consider either using a faster drive, logging less data, or using a longer data logging interval.

**CAUTION:** removing a drive while data logging may damage the file system on the drive and may render the drive and the data on it unusable. Once inserted and saving data log data it must not be removed until the entire file has been written.

---

### 23.7.7 EXPORTING A DATA LOG FROM THE INTERNAL MEMORY

If the internal memory contains data log records then these may be exported to an external drive.

This is achieved by inserting the USB drive into the front panel port and pressing the EXPORT button next to the INT MEMORY area on the data logging screen. After pressing this you are prompted to enter the desired file format (ASCII or BINARY), followed by the desired filename (the extension is automatically provided), followed by a request to overwrite the file (only if it already exists on the USB drive). The file transfer is then initiated, and the progress can be viewed in the status area on the lower part of this screen. The resultant file always contains a header record.

Note:

Since a typical USB drive has a sustained write speed of 500Kbytes/sec (or possibly less) and the internal memory can contain several Gbytes, this activity can take a very long time (possibly several hours or more).

Once started you do not need to stay on this screen, you can continue to use the PA900 normally other than being unable to import or export files and not being able to perform data logging.

If exporting to an ASCII format file then the resultant file will typically be 3x larger than the amount of internal memory used. This might be more than the 4Gbyte file size limit for FAT32. In this case you should export the data in binary format and externally convert it into ASCII using the supplied application.

---

### 23.7.8 INTERNAL BUFFER USAGE

The PA900 has a large internal FIFO buffer (32Mbytes) which is used for data log data. This buffer serves two purposes-

1. If you are data logging to a file on a drive then it reduces the impact on data logging which inconsistencies in the write speed of the drive may have, or if it has an insufficient sustained write speed.
2. It allows you to insert a drive to save the data log data at any time; before, during or after performing the data log.

The progress bar shown in the lower portion of the Data Logging Configuration and Status screen shows how much of this buffer is presently used and also the maximum amount which has been used.

Note:

Data stored into this memory always has a binary format; the amount of this memory used per data log record is given by (4 bytes x number of data shown in the SELECT DATA button).

Data logging always saves the captured data into this internal buffer. At any time, if data has been stored in this internal buffer and the drive is available and not busy, then data is written from this buffer to the drive with the format configured.

This memory is volatile, so turning off the PA900 will lose any data stored in it.

If this buffer is overrun then data logging continues, but some records will be lost. It will always be entire records which are lost if this occurs, not data within records, so the integrity of the resulting file is unaffected.

Because writing data to the drive can lag behind the rate at which data is being collected, data will continue to be saved to the drive after data logging has been stopped manually or the configured run time has elapsed. Since the sustained write speed of a USB Flash Drive may be <500Kbytes/sec and the buffer may contain up to 32Mbytes and the data written to the drive can be several times larger than the data in the memory, this could continue for several minutes or more after stopping data logging.

---

### 23.7.9 OPTIMIZING AND TESTING FILE WRITE SPEED

Generally the PA900 is not the limitation to the maximum achievable data logging rate to an external USB drive. The drive average sustained write speed and the USB speed itself are typically the main limitations.

If the total data log will be less than 8Mdata then speed is not of concern as the internal buffer is large enough to accommodate this.

The internal memory in the PA900 has a much faster average sustained write speed than external USB drives, but still needs to be considered when logging at very high rates and with large data counts. The typical maximum sustained speed for the internal memory is over 5Mbytes/sec (1.25Mdata/sec), so if data logging at the maximum rate (0.002sec or 500/sec) the maximum amount of data per record which can be logged without record loss is 2500 data (higher at slower data logging rates).

Drives are not consistent in their timing; a typical drive will occasionally pause while writing data which will cause the buffer usage bar to move in an inconsistent manner. It is recommended to perform a test data log to a drive before attempting to create a substantial data log file to ensure that the drive can support the required average data write rate. This test run should be for at least a few minutes.

If the drive will not support the required mean sustained write speed required for the desired data log interval and data then the internal buffer will fill up and records will be lost.

To achieve the fastest sustained average write speed with an external USB drive the following recommendations are made-

For most drives a large allocation unit size (or cluster size) will achieve the fastest sustained write speed. You may wish to reformat the drive to have a larger allocation unit size than was present when purchased (16kbyte is recommended for data logging). As an example the following results were obtained using a typical USB Drive (4Gbyte size, writing a 70Mbyte file) -

4kbyte allocation unit (as purchased): 330kbytes/sec sustained speed (82.5Kdata/sec in binary format)

8kbyte allocation unit: 511kbytes/sec sustained speed (127.75Kdata/sec in binary format)

16kbyte allocation unit: 670kbytes/sec sustained speed (167.5Kdata/sec in binary format)

32kbyte allocation unit: 715kbytes/sec sustained speed (176.25Kdata/sec in binary format)

Note that these figures are far less than the published maximum write speed for this device (3Mbytes/sec), but neither the bus speed nor the PA900 were the limiting factors for the above tests.

A typical drive is fastest if there are no other files on it; this ensures that the PA900 can write the file into consecutive areas of the drive.

For best speeds, use a portable hard drive not a flash drive. Hard drives typically have more consistent and faster write speeds.



## 24 USING THE PA900 FROM AN INTERFACE

### 24.1 COMPUTER CONTROL OF THE PA900

There are a great many software languages, compilers and development platforms. It is beyond the scope of this document to attempt to provide you with complete assistance regarding writing software to control the PA900, so it is described in general form. Examples, where given, use the Microsoft Visual Studio Express 2012 development platform and the VB.NET language. The examples are portions of code and in practice you may wish to provide handlers for recovering from timeout errors.

The protocol used for communications is entirely ASCII based, using the commonly used command and data fields approach, and is the same protocol for all interfaces.

Note:

Use of the PA900 via an interface is not dependent on the PA900 front panel being set to any specific screen.

#### 24.1.1 RS232 (SERIAL) INTERFACE

Baud Rate	9600, 19200, 57600 or 115200
Handshake	Bi-directional, hardware (RTS/CTS)
Data Bits	8
Parity	None
Start/Stop Bits	1
Connector	9-pin Male Dsub
Interface Pinout Type	DTE (same as PC computer)
Cable required	9-wire female-female null modem cable, fully wired
Cable Length	<50ft (per standard, in practice considerably longer cable lengths are often used without problems)

##### 24.1.1.1 CONNECTING TO THE RS232 INTERFACE

The RS232 connector located on the rear panel of the PA900 must be connected to the computer. For a standard PC type computer this requires a 9-pin female-female null modem cable, the pinout on the PA900 connector is identical to that on a standard PC, so the data and handshake lines must cross-over in the cable. Suitable cables are available from Vitrek in a selection of lengths.

Note:

This cable must accommodate not only the data signals and ground, but also the RTS, CTS and DTR signals as a minimum.

##### 24.1.1.2 USING A USB-TO-RS232 CONVERTOR

Many computers do not have a RS232 interface available; in these cases you may need to use a USB-to-RS232 convertor (sometimes called a 'dongle') to provide the RS232 interface. Many such convertors are available but many do not have adequate performance; Vitrek offers a fully tested convertor which is recommended.

Although the use of a convertor may not appear to require the alteration of software written by you for a direct RS232 port, the majority of USB-to-RS232 convertors have a fairly severe latency delay (typically 10ms or more) for each transmitted and received string of characters. In high speed applications this may severely restrict the overall speed. Also, many convertors have buffers for transmitted and received characters within the convertor itself. Experience has shown that the state of the buffer for characters transmitted from the computer to the PA900 is not properly managed in some convertors which can result in buffer overrun. This can cause character loss when performing high-speed transfers of commands to the PA900. If using such a convertor and the user is experiencing data loss (usually seen as randomly occurring command errors at the PA900) then the following is recommended based on our experience—

Use a different convertor. Vitrek offers a fully tested convertor.

Ensure you are using the latest driver for the convertor in your computer. If changing between convertors then it is recommended to uninstall all previous USB-to-RS232 convertor drivers after removing the present USB-to-RS232 convertor and then rebooting the computer prior to installing a different convertor. Many different manufacturers of convertors use a similar chip set and are detected as compatible devices and may erroneously re-use the existing driver.

Limit all transmitted data to a maximum of 64 characters and rate limit each packet transmitted by using pauses in your software. In extreme cases this 64 character limit may need to be lowered. Experience has shown that some convertors are only reliable when single characters are transmitted. The rate limiting time delay between packets should be greater than the USB frame rate of 1ms.

Some convertors rely on the mechanical ground connection from the RS232 end to the convertor. Although a convertor may appear to be operating correctly, if the screws mounting a RS232 cable to the convertor are not installed then the convertor becomes very sensitive to interference. This typically gives a similar issue to the buffer management issue noted above, but most often yields character loss in both transmitted and received data.

##### 24.1.1.3 USE OF THE RS232 CONTROL SIGNALS

This section uses the signals names as they are present at the computer end of the cable.

The DTR signal (output from the computer) is used by the PA900 to detect that a controller is present on the RS232 port so must be asserted for any interface activity to be recognized. The cable used, any cable convertor used, the computer, and the software must all support the DTR signal. If not included in the cable a disconnected DTR signal is seen by the PA900 as the absence of a computer and any characters received will be taken as interference and discarded. If the correct DTR signal cannot be provided then a special cable can be constructed which ties the DSR and DTR signals together, in this manner the PA900 itself provides the DTR signal.



The DSR signal (input to the computer) is asserted by the PA900 whenever the RS232 port of the PA900 is enabled. Generally this signal is not used by the computer so is not often a cause for concern.

The CTS signal (input to the computer) is used by the PA900 to handshake data transmitted from the computer and must be supported by the cable used, any cable convertor used, the computer, and the software. Improper support for this signal is generally seen as occasional errors in commands to the PA900 caused by command transmission corruption.

The RTS signal (output from the computer) is used by the PA900 to handshake data transmitted from the PA900. Generally this signal is not used by the computer so is not often a cause for concern but it must be included in the cable as a disconnected signal disables all data transmitted from the PA900.

#### 24.1.1.4 WRITING SOFTWARE TO CONTROL THE PA900 VIA RS232

Before your software can communicate with the PA900 it generally must create an object for the specific serial port and configure it.

As an example the following lines of code configure and open the port for communications (SerialPort1 is defined as a System.IO.Ports.SerialPort object)-

```
SerialPort1.BaudRate = 115200
SerialPort1.PortName = "COM1"
SerialPort1.Handshake = IO.Ports.Handshake.RequestToSend
SerialPort1.ReadTimeout = 100
SerialPort1.WriteTimeout = 100
SerialPort1.DtrEnable = True
SerialPort1.Open()
```

Since the PA900 communicates entirely using the standard ASCII character set, methods for sending and receiving character strings must be used, remembering to always terminate both transmitted and received strings with the <CR> and/or <LF> characters.

To transmit a command string (TransmitString) to the PA900 the following is an example -

```
SerialPort1.WriteLine(TransmitString)
```

To receive a response string (ReceiveString) from the PA900 the following is an example -

```
Dim ReceiveString as String = SerialPort1.ReadLine()
```

---

### 24.1.2 LAN (ETHERNET) INTERFACE

Speed	10baseT or 100baseTX, auto-selected
Duplex	Half or full-duplex, auto-selected
MDI/MDIX	Auto-selected
Protocols	ICMPv4, ARP, UDP/IPv4, TCP/IPv4, DHCPv4, mDNS, IGMPv3 (reducing to v1 or v2 automatically as needed)
TCP Port	10733
Max. MTU	1500 (maximum Ethernet payload)
Remote Connections	Only one remote connection is allowed at any given time
Connector	RJ45
Cable required	CAT5 or CAT5e, UTP or STP
Cable Length	<100m (per standard)

#### 24.1.2.1 CONNECTING TO THE LAN INTERFACE

The LAN connector located on the rear panel of the PA900 must be connected to your network or connected to a computer either directly or through a switch (a hub is not recommended). Standard CAT5e UTP cable is sufficient for the majority of applications and the PA900 has auto MDI/MDIX so the use of a crossover cable is not necessary.

#### 24.1.2.2 IP ADDRESSING

Since the LAN interface of the PA900 uses IP communications, an IP address must be assigned in some manner to the PA900. There are three methods of doing this as described in section 12.3.2.3-

1. Using a manually entered IP address, gateway and subnet mask.
2. Using an IP address, gateway and subnet mask obtained from a DHCP server (all three must be provided by the server).
3. Using an IP address obtained by the Auto-IP method (RFC3927). The IP address will be in the range from 169.254.1.0 to 169.254.254.255.

Whichever method is used, you should note the IP address of the PA900 and use that address to communicate with the PA900 via the LAN interface. If you use a fixed manually entered IP then this will not change unless the manual configuration of the PA900 is changed, however using DHCP it may occasionally change (depending on the specific DHCP server, it may issue the same IP address each time or it may not) and using Auto-IP it will never be the same IP address each time that the PA900 is linked. The actual IP address of the PA900 can be viewed by pressing the Interface Info area available on most screens and if colored orange then it should not be used as it has not been validated, typically it will change to white text within a few seconds at which time it may be used.

Note:

If using Auto-IP then the traffic to and from the PA900 should not be able to pass through a router, so the PA900 must be local to the computer.

If using DHCP or Auto-IP then it may take some time to obtain a valid IP address after attachment to the network. This typically takes a few seconds, but can occasionally take considerably longer.

The PA900 does not support generating VLAN traffic, and although it can receive VLAN formatted traffic it ignores the VLAN information. If used on a network which uses VLAN then it should be located on a portion of that network which does not have the VLAN content. Check with your IT department regarding this if necessary.

### 24.1.2.3 CONCERNS REGARDING SECURITY USING THE PA900 VIA LAN

You may be concerned with the security of your network when connecting a PA900 to it. Such a concern is generally unnecessary as the PA900 is not capable of any transfers that can detrimentally affect other equipment or computers on the network.

Additionally, the PA900 can be configured for Auto-IP (RFC3927) IP addressing. In that case no traffic to or from the PA900 should be able to pass through a router, so the PA900 can be made to be local to a portion of a network.

Note:

The PA900 generally has a benign presence on the LAN and does not broadcast any traffic related to its presence on the LAN (other than DHCP traffic if enabled and ARP traffic as needed).

The PA900 only supports –

- The DHCP Protocol (only if configured to use DHCP).

- The ARP protocol (only to ensure the uniqueness of its own IP address, and as necessary to confirm the presence of the computer which has a TCP/IP socket established to the PA900, the PA900 does not arbitrarily generate ARP requests).

- The ICMP reception of a 'ping' and the transmission of its response (it cannot generate a 'ping').

- If the PA900 is configured to have an IDENTITY name then this is verified as being unique using mDNS when the PA900 is turned on, or just connected to the LAN, or the identity name is changed. The identity capability may be disabled to remove the capability of generating mDNS traffic.

- Transfer of ASCII data from the PA900 to a computer using streaming TCP/IP protocol to which it has a TCP/IP socket established only when and as directed by that computer (only a single socket is allowed by the PA900). Data transmitted from the PA900 can only be measurement results and measurement status information. These are all non-broadcast datagrams, so in a well-designed network these datagrams will not be transmitted beyond the connection between the computer and the PA900.

All LAN packets received which are not supported are silently discarded and ignored.

The PA900 does not support –

- Communications with a computer with which it does not have a TCP/IP socket established (which can only be established by the computer, not by the PA900).

- Reception of any broadcast requests other than DHCP (only if enabled) and ARP (all other received broadcasts are silently ignored).

- Transmission of any broadcast packets other than DHCP (only if enabled) and ARP (only as required to ensure the uniqueness of its own IP address).

- Transporting any binary data.

- Any network management protocols such as SNMP, SSDP, LLDP, SDP, CDP etc., or routing protocols such as RIP etc.

- Any 'file system', NETBIOS or similar protocols.

- Any HTTP, FTP, etc. which might enable a 'program' to be transferred to or from the PA900 via the LAN.

- Any POP, SMTP, IMAP, NetBIOS, NetBT, IPX or similar protocols which might establish a connection to another computer.

### 24.1.2.4 WRITING SOFTWARE TO CONTROL THE PA900 VIA LAN

All communication with the PA900 uses TCP/IP port 10733 in the PA900. The PA900 only allows one active socket at any given time, so you should close the TCP/IP socket when finished using it. To avoid unnecessary lockouts, the PA900 will allow a replacement socket if the previously active socket is still open but has not been active for >1 minute, in which case it will close the expired socket (this only occurs if a new socket is attempted, otherwise the PA900 will keep a socket open even if it is not active).

TCP/IP has CRC error checking, packet loss detection, and automatic retransmission of lost or corrupted data. This means that the user need not perform error checking using commands such as \*ERR? when using the LAN interface except for testing your software, as each command is guaranteed to reach the PA900 without error.

Before your software can communicate with the PA900 it generally must create an object for the socket and then configure and open it.

```
Dim enet_socket As System.Net.Sockets.TcpClient
enet_socket.Connect(System.Net.IPAddress.Parse(EnetIPAddrBox.Text), 10733)
enet_socket.ReceiveTimeout = 1000
```

To close the socket the following is an example.

```
enet_socket.Close()
```

The example above shows using the IP address of a PA900 to open a connection to it. Alternatively the identity name of the PA900 can be used, but with 'local' appended to the end of it, as an example if the PA900 identity is PA900-123456 then a socket with it can be opened using –

```
enet_socket.Connect("PA900-123456.local", 10733)
```

Opening a socket using the identity name has the advantage that you do not need to know the IP address of the PA900, only its' identity name, so your software does not need to be modified to accommodate changes to the network configuration.

Since the PA900 communicates entirely using the standard ASCII character set, methods for sending and receiving character strings must be used, remembering to always terminate both transmitted and received strings with the <CR> and/or <LF> characters.

To transmit a command string (TransmitString) to the PA900 the following is an example -

```
Dim send_data As Byte() = System.Text.Encoding.ASCII.GetBytes(TransmitString + Chr(10))
Dim send_len As Integer = cmd_string.Length
enet_socket.GetStream.Write(send_data, 0, send_len + 1)
```

To receive a response string (ReceiveString) from the PA900 the following is an example -

```
Dim sr As New System.IO.StreamReader(enet_socket.GetStream())
Dim ReceiveString as String = sr.ReadLine()
```

---

### 24.1.3 USB INTERFACE

Connector	USB B connector
Cable required	USB 2.0 A-B Cable
Compatibility	Compatible with Windows XP and later operating systems
USB Speed	Full-speed
USB Device	Enumerates as a Human Interface Device (HID) of the Vendor-specific type
Driver	None required

#### 24.1.3.1 CONNECTING TO THE USB INTERFACE

The USB connector located on the rear panel of the PA900 must be connected to the computer or a hub using a standard USB AB type cable. The use of a quality cable is particularly recommended if interference is likely, as lower quality cables have poor shielding (if any) and have a high RF impedance in the ground connection.

The PA900 does not require a vendor supplied driver, so no installation is required. When the PA900 is first connected to a computer (sometimes to each specific USB port of a computer) the operating system of the computer must load its native HID device driver, this may take a short while. During that time the PA900 cannot be communicated with via the USB. The PA900 appears as a standard HID Input Device with Vendor-specific properties, it is shown in the Windows Device Manager as a Human Interface Device -> USB Input Device.

#### 24.1.3.2 WRITING SOFTWARE TO CONTROL THE PA900 VIA USB

Since the PA900 appears as a standard HID Device with Vendor-specific properties, you must communicate through the standard Windows® interface for such devices. This can be a difficult task, so Vitrek includes a pair of DLL files to ease this communication (SLABHIDtoUART.dll and SLABHIDDevice.dll, both of which must be accessible to your program). All attempts to open the port, transmit strings through the port, receive strings through the port and close the port should be directly made through simple calls to these DLL files. Header files defining these calls for VB.NET, for C# and for C/C++ are also provided (SLABCP2110.vb, SLABCP2110.cs and SLABCP2110.h respectively).

When compiling applications using the Visual Studio development platform you should compile for x86 processors otherwise there may be conflicts with the supplied DLL files.

Note that most communications require knowledge of the USB VID (Vendor ID) and PID (Product ID) numbers used by the PA900. These are 4292 and 34869 respectively for all PA900 units.

Before your software can communicate with the PA900 it generally must create an object for the socket and then configure and open it.

```
Dim num_devices As Integer
Dim usbdevice As System.IntPtr
HidUart_GetNumDevices(num_devices, 4292, 34869)
If (num_devices > 0 And HidUart_Open(usbdevice, 0, 4292, 34869) = HID_UART_SUCCESS) Then
    HidUart_SetUartConfig(usbdevice, 115200, HID_UART_EIGHT_DATA_BITS, HID_UART_NO_PARITY, /
        ID_UART_SHORT_STOP_BIT, HID_UART_RTS_CTS_FLOW_CONTROL)
    HidUart_SetTimeouts(usbdevice, 0, 1000)
End If
```

To close the connection the following is an example.

```
HidUart_Close(usbdevice)
```

Since the PA900 communicates entirely using the standard ASCII character set, methods for sending and receiving character strings must be used, remembering to always terminate both transmitted and received strings with the <CR> and/or <LF> characters.

Although not shown here, it is recommended that you should check if the device handle is active by using the *HidUart\_IsOpened* function call prior making calls for transmitting or receiving data. If this call indicates an invalid handle then you should repeat the process of opening a socket and obtaining a new device handle. This is only needed when significant interference is present and is necessary because some operating systems (e.g. Windows) disconnect a USB device which has interference.

To transmit a command string (TransmitString) to the PA900 the following is an example -

```
Dim send_data As Byte() = System.Text.Encoding.ASCII.GetBytes(cmd_string + Chr(10))
Dim send_len As Integer = cmd_string.Length
Dim written As Integer
HidUart_Write(usbdevice, send_data, send_len + 1, written)
```

To receive a response string (ReceiveString) from the PA900 the following is an example -

```
' The USB only operates with byte arrays - so must handle each byte and detect the LF
' terminator
' Although usually all characters in a response are received in a single array, this cannot be
' relied upon
```

```

' Uses a 2 second timeout to receive a complete line (far longer than needed)
Dim Timer As Stopwatch = Stopwatch.StartNew()
Dim rx_lf As Boolean = False
ReceiveString = ""
While (Not (rx_lf))
    Dim rx_data(1024) As Byte
    Dim rx_index As Integer = 0
    Dim bytes As Integer = 0
    HidUart_Read(usbdevice, rx_data, 1024, bytes)
    ' Because we configured a 0 read timeout this will return immediately if there's no
    ' characters
    While (bytes)
        If (rx_data(rx_index) = 10) Then
            rx_lf = True
            Exit While
        End If
        rx_index += 1
        bytes -= 1
    End While
    ReceiveString += System.Text.Encoding.ASCII.GetString(rx_data, 0, rx_index)
    If (Timer.ElapsedMilliseconds > 2000) Then
        ' Timeout occurred - need to take some action here
        Timer.Stop()
        Exit Function
    End If
End While

```

### 24.1.3.3 SUMMARY OF PROVIDED DLL FUNCTIONS

In all function calls requiring a PID and/or VID, you must use the values noted above for the PA900.

The definitions for the function shown below use a C language form for clarity; do not use the calls exactly as shown instead use the header provided for the specific language being used.

CAUTION – the provided DLL files also contain other functions, you must not call these other functions otherwise it may render the PA900 permanently inoperative.

#### *HidUart\_GetNumDevices*

This function returns the number of devices connected to the host with matching vendor and product ID (VID, PID).

HID\_UART\_STATUS HidUart\_GetNumDevices (DWORD\* numDevices, WORD vid, WORD pid)

*numDevices*—Returns the number of devices connected on return.

*vid*—Filter device results by vendor ID.

*pid*—Filter device results by product ID.

Return Value: HID\_UART\_STATUS = HID\_UART\_SUCCESS, HID\_UART\_INVALID\_PARAMETER

#### *HidUart\_GetString*

This function returns a null-terminated vendor ID string, product ID string, serial string, device path string, manufacturer string, or product string for the device specified by an index passed in *deviceNum*. The index for the first device is 0 and the last device is the value returned by *HidUart\_GetNumDevices()* - 1.

HID\_UART\_STATUS HidUart\_GetString (DWORD deviceNum, WORD vid, WORD pid, char\* deviceString, DWORD options)

*deviceNum*—Index of the device for which the string is desired.

*vid*—Filter device results by vendor ID.

*pid*—Filter device results by product ID.

*deviceString*—Variable of type HID\_UART\_DEVICE\_STRING which will contain a NULL terminated ASCII device string on return. The string is 260 bytes.

*options*—Determines if *deviceString* contains a vendor ID string, product ID string, serial string, device path string, manufacturer string, or product string.

Return Value: HID\_UART\_STATUS = HID\_UART\_SUCCESS, HID\_UART\_DEVICE\_NOT\_FOUND, HID\_UART\_INVALID\_PARAMETER, HID\_UART\_DEVICE\_ACCESS\_ERROR

#### *HidUart\_GetOpenedString*

This function returns a null-terminated vendor ID string, product ID string, serial string, device path string, manufacturer string, or product string for the device specified by *device*.

HID\_UART\_STATUS HidUart\_GetOpenedString (HID\_UART\_DEVICE device, char\* deviceString, DWORD options)

*device*—Device object pointer as returned by *HidUart\_Open()*.

*deviceString*—Variable of type HID\_UART\_DEVICE\_STRING which will contain a NULL terminated ASCII device string on return. The string is 260 bytes.

*options*—Determines if *deviceString* contains a vendor ID string, product ID string, serial string, device path string, manufacturer string, or product string.

Return Value: HID\_UART\_STATUS = HID\_UART\_SUCCESS, HID\_UART\_INVALID\_DEVICE\_OBJECT, HID\_UART\_INVALID\_PARAMETER, HID\_UART\_DEVICE\_ACCESS\_ERROR

### *HidUart\_Open*

Opens a device using a device number between 0 and *HidUart\_GetNumDevices()*-1 and returns a device object pointer which will be used for subsequent accesses.

HID\_UART\_STATUS HidUart\_Open (HID\_UART\_DEVICE\* device, DWORD deviceNum, WORD vid, WORD pid)

*device*—Returns a pointer to a PA900 device object. This pointer will be used by all subsequent accesses to the device.

*deviceNum* —Zero-based device index, between 0 and (*HidUart\_GetNumDevices()* - 1).

*vid*—Filter device results by vendor ID.

*pid*—Filter device results by product ID.

Return Value: HID\_UART\_STATUS= HID\_UART\_SUCCESS, HID\_UART\_INVALID\_DEVICE\_OBJECT, HID\_UART\_DEVICE\_NOT\_FOUND, HID\_UART\_INVALID\_PARAMETER, HID\_UART\_DEVICE\_IO\_FAILED, HID\_UART\_DEVICE\_ACCESS\_ERROR, HID\_UART\_DEVICE\_NOT\_SUPPORTED

Note - Be careful when opening a device. Any HID device may be opened by this library. However, if the device is not actually a PA900, use of this library will cause undesirable results. The PA900 PID and VID must always be used.

### *HidUart\_Close*

Closes an opened device using the device object pointer provided by *HidUart\_Open()*.

HID\_UART\_STATUS HidUart\_Close (HID\_UART\_DEVICE device)

*device*—Device object pointer as returned by *HidUart\_Open()*.

Return Value: HID\_UART\_STATUS= HID\_UART\_SUCCESS, HID\_UART\_INVALID\_DEVICE\_OBJECT, HID\_UART\_INVALID\_HANDLE, HID\_UART\_DEVICE\_ACCESS\_ERROR

Note - *device* is invalid after calling *HidUart\_Close()*. It is recommended to set *device* to NULL after this call.

### *HidUart\_IsOpened*

Returns the device opened status.

HID\_UART\_STATUS HidUart\_IsOpened (HID\_UART\_DEVICE device, BOOL\* opened)

*device*—Device object pointer as returned by *HidUart\_Open()*.

*opened*—Returns *TRUE* if the device object pointer is valid and the device has been opened using *HidUart\_Open()*.

Return Value: HID\_UART\_STATUS= HID\_UART\_SUCCESS, HID\_UART\_INVALID\_DEVICE\_OBJECT, HID\_UART\_INVALID\_PARAMETER

### *HidUart\_Read*

Reads the available number of bytes into the supplied buffer and returns the number of bytes read which can be less than the number of bytes requested. This function returns synchronously after reading the requested number of bytes or after the timeout duration has elapsed. Read and write timeouts can be set using *HidUart\_SetTimeouts()*.

HID\_UART\_STATUS HidUart\_Read (HID\_UART\_DEVICE device, BYTE\* buffer, DWORD numBytesToRead, DWORD\* numBytesRead)

*device*—Device object pointer as returned by *HidUart\_Open()*.

*buffer*—Address of a buffer to be filled with read data.

*numBytesToRead*—Number of bytes to read from the device into the buffer (1-32768). This value must be less than or equal to the size of *buffer*.

*numBytesRead*—Returns the number of bytes actually read into the buffer on completion.

Return Value: HID\_UART\_STATUS = HID\_UART\_SUCCESS, HID\_UART\_READ\_ERROR, HID\_UART\_INVALID\_PARAMETER, HID\_UART\_INVALID\_DEVICE\_OBJECT, HID\_UART\_READ\_TIMED\_OUT, HID\_UART\_INVALID\_REQUEST\_LENGTH

Note - *HidUart\_Read()* returns HID\_UART\_READ\_TIMED\_OUT if the number of bytes read is less than the number of bytes requested. This will only occur after the read timeout has elapsed. If the number of bytes read matches the number of bytes requested, this function will return HID\_UART\_SUCCESS.

### *HidUart\_Write*

Write the specified number of bytes from the supplied buffer to the device. This function returns synchronously after writing the requested number of bytes or after the timeout duration has elapsed. Read and write timeouts can be set using *HidUart\_SetTimeouts()*.

HID\_UART\_STATUS HidUart\_Write (HID\_UART\_DEVICE device, BYTE\* buffer, DWORD numBytesToWrite, DWORD\* numBytesWritten)

*device*—Device object pointer as returned by *HidUart\_Open()*.

*buffer*—Address of a buffer to be sent to the device.

*numBytesToWrite*—Number of bytes to write to the device (1-4096 bytes). *This value must be less than or equal to the size of buffer.*

*numBytesWritten*—Returns the number of bytes actually written to the device.

Return Value: HID\_UART\_STATUS = HID\_UART\_SUCCESS, HID\_UART\_WRITE\_ERROR, HID\_UART\_INVALID\_PARAMETER, HID\_UART\_INVALID\_DEVICE\_OBJECT, HID\_UART\_WRITE\_TIMED\_OUT, HID\_UART\_INVALID\_REQUEST\_LENGTH

Note - *HidUart\_Write()* returns HID\_UART\_WRITE\_TIMED\_OUT if the number of bytes written is less than the number of bytes requested.

### *HidUart\_FlushBuffers*



This function flushes the receive buffer in the PA900 and the HID driver.

```
HID_UART_STATUS HidUart_FlushBuffers (HID_UART_DEVICE device, BOOL flushTransmit, BOOL flushReceive)
```

*device*—Device object pointer as returned by *HidUart\_Open()*.

*flushTransmit* —Set to *TRUE* to flush the device transmit buffer.

*flushReceive* —Set to *TRUE* to flush the device receive buffer and HID receive buffer.

Return Value: HID\_UART\_STATUS = HID\_UART\_SUCCESS, HID\_UART\_INVALID\_DEVICE\_OBJECT, HID\_UART\_DEVICE\_IO\_FAILED

#### *HidUart\_Cancello*

This function cancels any pending HID reads and writes.

```
HID_UART_STATUS HidUart_CancelIo (HID_UART_DEVICE device)
```

*device*—Device object pointer as returned by *HidUart\_Open()*.

Return Value: HID\_UART\_STATUS = HID\_UART\_SUCCESS, HID\_UART\_INVALID\_DEVICE\_OBJECT, HID\_UART\_DEVICE\_IO\_FAILED

#### *HidUart\_SetTimeouts*

Sets the read and write timeouts. Timeouts are used for *HidUart\_Read()* and *HidUart\_Write()*. The default value for timeouts is 1000 ms, but timeouts can be set to wait for any number of milliseconds between 0 and 0xFFFFFFFF.

```
HID_UART_STATUS HidUart_SetTimeouts (HID_UART_DEVICE device, DWORD readTimeout, DWORD writeTimeout)
```

*device*—Device object pointer as returned by *HidUart\_Open()*.

*readTimeout*—*HidUart\_Read()* operation timeout in milliseconds.

*writeTimeout*—*HidUart\_Write()* operation timeout in milliseconds.

Return Value: HID\_UART\_STATUS = HID\_UART\_SUCCESS, HID\_UART\_INVALID\_DEVICE\_OBJECT

Note - If read timeouts are set to a large value and no data is received, then the application may appear unresponsive. It is recommended to set timeouts appropriately before using the device.

#### *HidUart\_SetUartConfig*

Sets the baud rate, data bits, parity, stop bits, and flow control. Caution, this sets parameters within the PA900 – do NOT alter these settings from those shown below.

```
HidUart_SetUartConfig(device, 115200, HID_UART_EIGHT_DATA_BITS, HID_UART_NO_PARITY, HID_UART_SHORT_STOP_BIT, HID_UART_RTS_CTS_FLOW_CONTROL)
```

*device*—Device object pointer as returned by *HidUart\_Open()*.

Return Value: HID\_UART\_STATUS = HID\_UART\_SUCCESS, HID\_UART\_INVALID\_PARAMETER, HID\_UART\_INVALID\_DEVICE\_OBJECT, HID\_UART\_DEVICE\_IO\_FAILED

---

## 24.1.4 GPIB INTERFACE

The GPIB capabilities, as defined by IEEE488.1 are SH1 AH1 T6 L4 SR1 RL1 PP1 DC1 DT0 C0 E2.

### 24.1.4.1 CONNECTING TO THE GPIB INTERFACE

It is recommended to use a high quality, shielded, GPIB cable. Suitable cables are available from Vitrek in a selection of lengths.

### 24.1.4.2 REMOTE AND LOCAL OPERATION

The GPIB itself has a protocol for establishing and controlling the local/remote state of the PA900 so there are no PA900 commands required to do so as for other available interfaces. The front panel button (shown when in the remote state) requests that the local state be entered, but it is the GPIB interface which controls that state and may deny that request.

### 24.1.4.3 WRITING SOFTWARE TO CONTROL THE PA900 VIA GPIB

Generally messages and controls are sent and received via the GPIB using calls into the DLL driver provided by the manufacturer of the specific GPIB controller being used in the computer. You should consult the documentation provided with the controller regarding writing software to communicate with the PA900.

#### 24.1.4.3.1 Terminating Command Sets

In addition to the command terminator characters described in 24.2.1.1 the use of the EOI signal of the GPIB interface may be used.

#### 24.1.4.3.2 Receiving Responses via the GPIB Interface

The PA900 always terminates all responses with the CR and LF characters as in the other available interfaces, however for the GPIB interface the EOI interface signal is also asserted with the LF character.

Unlike the other interfaces available for the PA900, the GPIB requires an action from the controller to be able to receive response information from the PA900. This activity could occur in the GPIB interface when no response is available.

Many devices simply hold the GPIB interface when this occurs and rely on a timeout occurring at the controller to release the GPIB. The PA900 always provides a response, and that response is always terminated by the CR and LF characters (the later with EOI asserted). If there is no response then there are no response characters preceding the CR, but the CR and LF+EOI characters are always transmitted. In this manner the bus itself does not become “hung” when this occurs, but instead you must consider the possibility of receiving a response which contains nothing in your software.

### 24.1.4.3.3 Register and Command Differences to Other Interfaces

Some registers and commands are different in the GPIB to those for the other interfaces, and some are only available from the GPIB interface.

The LOCAL and LOCKOUT commands are silently ignored if received via the GPIB interface.

The ESR register has a different format than for the other interfaces, for the GPIB interface its contents are as defined by IEEE488.2.

The \*ESE, \*ESE?, \*SRE, \*SRE?, \*TST? and \*WAI commands (as defined by IEEE488.2) are available from the GPIB interface but are unavailable for the other interfaces.

For all other interfaces if a query command is sent to the PA900, and then another query command is sent to the PA900 in a different set of commands before the response of the prior query has been fully transmitted by the PA900 then an error is raised and the second query command is discarded. For the GPIB interface if this occurs then an error is raised and the response to the second query command replaces that of the 1<sup>st</sup> query command. This is as required by IEEE488.2.

### 24.1.4.4 IEEE488.2 COMPATIBILITY

The PA900 is largely compatible with mandatory portions of the IEEE488.2 standard, however there are some deviations.

The PA900 does not lockup the GPIB when requested to talk and there is no prior query command response to transmit, as required by the IEEE488.2 standard; as described above the PA900 responds with a blank response in this case.

The PA900 does not use a whitespace character as a command or data separator as required by the IEEE488.2 standard; in most cases whitespace characters are ignored by the PA900.

The “pon” bit of the ESR register has an extended meaning in the PA900 beyond that required by IEEE488.2.

## 24.2 COMMAND SYNTAX

All commands to the PA900 use the standard 7-bit ASCII character set using 8-bit encoding (the 8<sup>th</sup> bit is zero) independent of the actual interface being used. A command is a stream of characters, the PA900 storing received characters until a command terminator character is received and only then is action taken on the commands. Further characters may be received while the PA900 is taking the actions needed for a preceding command but no action will be taken on them until all pending command decode activity is completed.

Each command is a KEYWORD field defining the command possibly followed by further fields which refine the action of the command. The available command keywords and the fields required for each are described in tables later in this section.

More than one command can be present in a single command set, in which case each command is separated from the previous by a command separator character. If an error is found in any command within a command set then that command and any remaining commands which follow it in the command set will not be actioned.

Since the interface is based on streaming ASCII characters the use of separator and terminator characters is required to ensure that the extents of each field can be established. To improve the readability of commands you may also wish to employ whitespace characters to spread apart fields.

### 24.2.1 SPECIAL CHARACTERS

Certain ASCII characters serve a special purpose as described below.

#### 24.2.1.1 COMMAND TERMINATOR CHARACTERS

The end of a command set is determined by the presence of a command terminator which may be the line-feed, carriage return, form feed or NULL (0 value) ASCII characters.

Everything between successive command terminators is a command set. A command set is limited to a maximum of 4095 characters in total. There is no action taken or error generated if a command terminator is immediately followed by another command terminator.

#### 24.2.1.2 COMMAND SEPARATOR CHARACTER

If more than one command is in a command set then each successive command is separated from the previous by a command separator which is the semi-colon ASCII character (;).

Everything between successive command separators or command terminators is a command. There is no action taken or error generated if a command separator is immediately followed by another command separator or a command terminator.

#### 24.2.1.3 FIELD SEPARATOR CHARACTER

Most commands require command fields which refine the action of the command; each field is separated from the previous by a field separator which is the comma ASCII character (,).

Everything between successive field separators, command separators or command terminators is a field.

#### 24.2.1.4 SUB-FIELD SEPARATOR CHARACTER

In some cases a single command field is made up of several sub-fields; each sub-field is separated from a previous sub-field by a sub-field separator which is the colon ASCII character (:).

Everything between successive sub-field separators, field separators, command separators or command terminators is a sub-field.

#### 24.2.1.5 WHITESPACE CHARACTERS

Most fields and sub-fields can have one or more whitespace characters at the beginning and/or end. The space, tab and underscore ASCII characters are considered as whitespace characters.



---

## 24.2.2 FIELDS WITHIN A COMMAND

Command fields are one of the types described below. In certain cases a single field may be formed by multiple sub-fields, in which case each successive sub-field (each having one of the field types described below) is separated from the previous by a preceding sub-field separator character.

### 24.2.2.1 KEYWORD COMMAND FIELD SYNTAX

A KEYWORD field is a combination of printable ASCII characters which match the corresponding allowable keywords as described later. A KEYWORD field is not case-sensitive (e.g. the letters V and v are equivalent) and may be preceded and/or followed by one or more whitespace characters but may not contain any whitespace characters within it.

Examples of valid KEYWORD fields are –

```
*CLS
*cls
*Cls
ARANGE
Arange
CH1
Ch1
ch1
```

### 24.2.2.2 STRING COMMAND FIELD SYNTAX

A STRING field is any combination of any printable ASCII characters in the range 'space' through 'z'. A STRING field is literal, containing the exact definition of the required string; however certain characters have special meaning –

```
!      The Ω character
\      The ø character
$      The μ character
^      The Σ character
[      The up arrow character
\      The down arrow character
]      The ° character
'      The centre dot character
```

Note that STRING fields are only terminated by a command terminator or separator character and may contain what would normally be any other separator character (if printable).

Examples of valid STRING fields are –

```
This is a string field
Volts:
```

### 24.2.2.3 NR1 COMMAND FIELD SYNTAX

A NR1 field is any combination of ASCII numeric (0 through 9) characters which form an integer value. A NR1 command field must not include a polarity character. A NR1 field may be preceded and/or followed by one or more whitespace characters but may not contain any whitespace characters within it.

All NR1 fields must be in the range 0 to 4294967295 and will cause a syntax error if outside of this range and in most commands this range is further limited and will cause a data range error if that range is exceeded.

Examples of valid NR1 fields are –

```
10
153465782
```

### 24.2.2.4 NR3 COMMAND FIELD SYNTAX

A NR3 field is any combination of ASCII characters which form a floating point value. A NR3 field may be preceded and/or followed by one or more whitespace characters but may not contain any whitespace characters within it.

All NR3 fields are decoded and used within the PA900 with approximately 1 in 10<sup>7</sup> resolution and may be in the range -10<sup>+99</sup> to 10<sup>+99</sup> and may contain a number of characters which is only limited by the maximum length of a command set.

Examples of valid NR3 fields are –

```
10
10.0
+10.0
1e1
-10.0
+1.2345678E+6
+1.2345678e+6
+1.2345678e-6
```

+1.2345678e6  
153465782.34

#### 24.2.2.5 VDEF COMMAND FIELD SYNTAX

This field type allows you to define a VPA using any one of the following syntaxes-

1 to 3	NR1 syntax
A1 to A3	KEYWORD syntax
VPA1 to VPA3	KEYWORD syntax
CH1 to CH4	KEYWORD syntax, defines the VPA which is presently configured to use the channel identified by CH1 to CH4; some commands do not support this syntax within a VDEF field

#### 24.2.2.6 CDEF COMMAND FIELD SYNTAX

This field type allows you to define a channel using any one of the following syntaxes-

1 to 4	NR1 syntax
CH1 to CH4	KEYWORD syntax

#### 24.2.2.7 RDEF COMMAND FIELD SYNTAX

This field type contains 1 to 5 sub-fields which define a measurement result to be used. See a later section for details regarding the sub-fields of the RDEF command field type.

#### 24.2.2.8 DDEF COMMAND FIELD SYNTAX

This field type contains 1 to 5 sub-fields which define a measurement result to be used. See a later section for details regarding the sub-fields of the DDEF command field type.

#### 24.2.2.9 COLOR COMMAND FIELD SYNTAX

A COLOR command field contains three NR1 type sub-fields defining the level of the red, green and blue color components respectively. Each value is a maximum of 255 corresponding to full brightness of the respective color.

#### 24.2.2.10 BLANK COMMAND FIELD SYNTAX

In some cases it is allowed to have a blank command field. This is a field which has a preceding field separator character but is immediately followed by another separator or terminator character. Except for a STRING command field, a blank field may contain one or more whitespace characters but no other characters.

### 24.3 RESPONSES TO COMMANDS

Some commands cause the PA900 to respond with a requested data response or set of data responses. The response is formed by a set of fields, similar to those for commands described above.

Note that all command keywords which end with the ? character cause a response; all command keywords which do not end with the ? character do not cause a response.

All responses from the PA900 use the standard 7-bit ASCII character set using 8-bit encoding (the 8<sup>th</sup> bit is zero) independent of the actual interface being used.

You may request more than one response in a set of commands, in which case each response (or set of responses) is separated from the previous by a comma separator and the responses are included in the same order as they were requested. A complete response is always terminated by a carriage return followed by a line feed ASCII character and may contain up to 65535 characters in total.

It is expected that after a command is given to the unit to produce a response that the originator will not issue further commands requesting a response until that prior response has been fully received. If the unit receives a command which requests a response but the prior response has not been fully transmitted then this raises a Tx Overrun error.

#### 24.3.1 RESPONSE FIELDS

As defined for each such command a response is one or more fields, each of which is of the following types.

##### 24.3.1.1 STRING RESPONSE FIELD SYNTAX

A STRING response is a set of ASCII characters forming the response. Only printable ASCII characters are used and the length of a STRING response is variable, the terminating comma (if more response fields follow it) or the terminating carriage return and line feed characters should be used to determine the end of a STRING field.

##### 24.3.1.2 NR1 RESPONSE FIELD SYNTAX

A NR1 response is a set of ASCII numeric characters defining an integer value. The length of a NR1 response is variable, the terminating comma (if more response fields follow it) or the terminating carriage return and line feed characters should be used to determine the end of a NR1 field. A NR1 response never includes a polarity symbol as all such responses are positive.

##### 24.3.1.3 NR3 RESPONSE FIELD SYNTAX

A NR3 response is a set of ASCII characters defining a floating point numeric value. The length of a NR3 response is fixed at 11 characters however it is recommended that the terminating comma (if more response fields follow it) or the terminating carriage return and line feed characters be used to determine the end of a NR3 field.

A NR3 response always has the following parts in the order shown –

A polarity character, defining the polarity of the numeric

6 digit characters with an embedded decimal point character, defining the mantissa portion of the numeric

The letter E character (upper case)

A polarity character, defining the polarity of the exponent

A single digit character defining the exponent (which is always a multiple of 3)

There is a special case of a NR3 response which is used to indicate that the data is not available. Normally a zero value uses a +0.00000E-9 response; a response of +0.00000E+0 indicates that the value is unavailable.

## 24.4 COMMAND KEYWORDS AND FIELDS

In the tables below, the specified command KEYWORD should be followed by each field (if any) in the order described in the table with each field separated from the previous by a field separator character. E.g. VSCALE,1,0 – turns off voltage scaling for channel 1.

NOTES:

For clarity, each command within each section is listed in alphabetical order and all tables listing those commands have the same column usage.

Where the FIELD(s) column indicates a dash (-) then that command requires no fields.

Where the FIELD(s) column indicates that fields are required, then those fields must be included with the command in the order shown in the table.

### 24.4.1 INTERFACE CLEAR COMMANDS

Both of these commands perform the same function. The use of either of these commands is recommended when starting a session with the PA900 to ensure that any incomplete activities performed in a prior session are properly discarded.

COMMAND KEYWORD	FIELD(s)	FIELD FORMAT	FIELD DATA RANGE	DESCRIPTION
*CLS	-	-	-	Clears all interface registers and flushes any unsent Tx data, selects the LOCAL state, and abandons any unsaved measurement configuration changes from the interface
*RST				

### 24.4.2 LOCAL/REMOTE STATE CONTROL COMMANDS

The PA900 automatically enters the REMOTE state when any command is received via an interface. While in the REMOTE state a front panel user cannot change the measurement or interface configuration without first selecting to return to the LOCAL state. Interface commands are always actioned independent of the LOCAL/REMOTE state. These commands are invalid commands if received via the GPIB interface.

COMMAND KEYWORD	FIELD(s)	FIELD FORMAT	FIELD DATA RANGE	DESCRIPTION
LOCAL	-	-	-	Enters the LOCAL state (front panel measurement configuration changes enabled)
LOCKOUT	-	-	-	Enters the LOCKOUT state (front panel measurement configuration changes disabled and you cannot unlock from the front panel)

### 24.4.3 UNIT AND CHANNEL IDENTIFICATION QUERY COMMANDS

COMMAND KEYWORD	FIELD(s)	FIELD FORMAT	FIELD DATA RANGE	DESCRIPTION
CHNL?	<i>c</i>	CDEF	-	Responds with two fields describing channel <i>c</i> - 1 <sup>st</sup> field: (STRING) Two letter channel type (or NF if not fitted, or NI if fitted but has invalid data) 2 <sup>nd</sup> field: (NR1) Serial Number
IDENT?	-	-	-	Responds with the STRING identity name configured for this PA900.
*IDN?	-	-	-	Responds with six fields describing the PA900 as follows - 1 <sup>st</sup> field: (STRING) Manufacturer 2 <sup>nd</sup> field: (STRING) Model (with /H500/EN/MU appended if the respective option is installed) 3 <sup>rd</sup> field: (STRING) Unit serial number 4 <sup>th</sup> field: (NR1) Firmware major version number 5 <sup>th</sup> field: (NR1) Firmware minor version number 6 <sup>th</sup> field: (NR1) Firmware build number

### 24.4.4 ERROR REGISTER QUERY COMMANDS

Each register accumulates interface command errors and is cleared when read. The use of the ERR register is recommended, the OPC and ESR registers are included for legacy purposes.

It is not recommended to include an error register query command with any other commands in a set of commands; any syntax error in those other commands may cause the error register query command to not be actioned.

These commands should be used following commands during testing of your software; they may be removed later if desired. For the LAN interface it is highly unlikely that a command will be corrupted, so the regular use of this type of error checking is not necessary; however for the USB and RS232 interfaces it is possible for commands to become corrupted during transmission to the PA900 so the use of the \*ERR? command is recommended in high interference environments.

The ERR register is automatically cleared when an interface is disconnected or when a LAN interface socket is closed.

Non-zero contents of the ERR register cause the screen of the PA900 to indicate an error message in the Error Info Area. This message remains until the ERR register is cleared.

COMMAND KEYWORD	FIELD(s)	FIELD FORMAT	FIELD DATA RANGE	DESCRIPTION
*ERR?	-	-	-	Responds with the NR1 ERR register contents and clears the register Response is the highest error encountered since cleared and has the following possible values - 0: No error has occurred 1: The command cannot not be executed at this time 2: The content or configuration of the PA900 was not compatible with a command 3: An interface command field was syntactically valid but the data was out of the valid range 4: An interface command field was syntactically invalid 5: An interface command field was expected but not found 6: An interface command field was found but not expected 7: An invalid interface command was found 8: The requested response data contains too many characters 9: A response was requested but the previous response has not been read 10: A Rx overrun occurred
*ESR?	-	-	-	Responds with the NR1 ESR register contents and clears the register. The response forms a single byte quantity with the following logical bit meanings (b0 is the LS bit) for other than the GPIB interface - b0: Set if an interface command error occurred b1: Set if a Tx overrun occurred This register has a different format for the GPIB interface as follows- b0: Set by the *OPC command (which is only available in the GPIB interface) b3: A query error has occurred b4: a command execution error occurred b5: a command error occurred b7: set if a power on has occurred (for the PA900 this is extended to also be set when the GPIB interface is changed from disabled to enabled)
*OPC?	-	-	-	Responds with the NR1 OPC register contents and clears the register The response forms a single byte quantity with the following logical bit meanings (b0 is the LS bit) for other than the GPIB interface - b0: Set if an interface command error did not occur b1: Set if an interface command had too many or too few fields b2: Set if an interface command field syntax or data range error occurred b3: Set if an interface command field was not compatible with the content or configuration b4: Set if a Tx overrun occurred b5: Set if a Rx overrun occurred b6: Set if an unknown command was received The response to this command has a different format for the GPIB interface as follows- The response is always a NR1 having value 1

#### 24.4.5 GPIB SPECIFIC COMMANDS

The commands in the table below are only allowed, or only have a usable functionality, when received via the GPIB interface.

COMMAND KEYWORD	FIELD(s)	FIELD FORMAT	FIELD DATA RANGE	DESCRIPTION
*WAI	-	-	-	In the PA900 this command provides no function but is a valid command
*ESE	<i>m</i>	NR1	0 to 255	This command sets the value of the ESE register and has the same format as for the ESR register response used for the PA900 GPIB interface- b0: Set by the *OPC command (which is only available in the GPIB interface) b3: A query error has occurred b4: a command execution error occurred b5: a command error occurred This register provides a mask for the ESR register to set b5 of the STB register if an enabled bit of the ESR register becomes set
*ESE?	-	-	-	Responds with the present NR1 contents of the ESE register
*OPC	-	-	-	Sets b0 of the ESR register
*SRE	<i>m</i>	NR1	0 to 255	Sets the SRE register and has the following format- b0: set to allow STB b0 to cause an SRQ b4: set to allow STB b4 to cause an SRQ b5: set to allow STB b5 to cause an SRQ
*SRE?	-	-	-	Responds with the present NR1 contents of the SRE register
*STB?	-	-	-	Responds with the NR1 contents of the STB register as follows- b0: set if a enabled bit in the MCR register is set b4: set if a response is available from the PA900 b5: set if a enabled bit in the ESR register is set b6: set according to the MSS bit required by IEEE488.2
*TST?	-	-	-	Responds with an NR1 value of 0 always and performs no other function

COMMAND KEYWORD	FIELD(s)	FIELD FORMAT	FIELD DATA RANGE	DESCRIPTION
MCE	<i>m</i>	NR1	varied	Sets the value of the MCE register which enables the respective bits of the MCR register (see the MCR? command) to set b0 of the STB register
MCE?	-	-	-	Responds with the present NR1 contents of the MCE register

#### 24.4.6 DATE AND TIME CONTROL AND QUERY COMMANDS

It may take up to 500ms for a change in date and/or time to become apparent in the display or in interface query commands.

COMMAND KEYWORD	FIELD(s)	FIELD FORMAT	FIELD DATA RANGE	DESCRIPTION
DATE	<i>d</i>	NR1	1 to 31	Sets the date ( <i>d</i> ), month ( <i>m</i> ) and year ( <i>y</i> )
	<i>m</i>	NR1	1 to 12	
	<i>y</i>	NR1	0 to 99	
DATEFMT	<i>f</i>	NR1	0 or 1	Sets MDY ( <i>f</i> =0) or DMY ( <i>f</i> =1) displayed date format
DATE?	-	-	-	Responds with the STRING format present date (as selected format) E.g. DD/MM/YYYY
TIME	<i>h</i>	NR1	0 to 23	Sets the hour ( <i>h</i> , 24 hour format), minute ( <i>m</i> ) and second ( <i>s</i> ). The <i>s</i> field is optional.
	<i>m</i>	NR1	0 to 59	
	<i>s</i>	NR1	0 to 59	
TIMEFMT	<i>f</i>	NR1	0 or 1	Sets 24 hour ( <i>f</i> =0) or 12 hour ( <i>f</i> =1) displayed time format
TIME?	-	-	-	Responds with the STRING format present time (as selected format) E.g. HH:MM:SSam

#### 24.4.7 SYSTEM PREFERENCES SET AND QUERY COMMANDS

COMMAND KEYWORD	FIELD(s)	FIELD FORMAT	FIELD DATA RANGE	DESCRIPTION
AUTOZERO	<i>s</i>	NR1	0 or 1	Sets that environmental tracking of DC zeroes is enabled ( <i>s</i> =1) or disabled ( <i>s</i> =0)
AUTOZERO?	-	-	-	Responds with the NR1 DC zero environment tracking setting - 0: Environment tracking is disabled 1: Environment tracking is enabled
FREQSPEED	<i>s</i>	NR1	0 to 2	Sets that the response speed to frequency changes is fast ( <i>s</i> =0), normal ( <i>s</i> =1) or slow ( <i>s</i> =2)
FREQSPEED?	-	-	-	Responds with the NR1 frequency change response speed is fast (0), normal (1) or slow (2)
PHASEPREF	<i>s</i>	NR1	0 to 7	Sets the PHASE preference setting according to the NR1 value of <i>s</i> as follows (see 12.3.1.6 for full details)- 0: Math, -180 to +180° range, CW = increasing phase on the vectors chart 1: Math, -180 to +180° range, CCW = increasing phase on the vectors chart 2: Math, 0 to 360° range, CW = increasing phase on the vectors chart 3: Math, 0 to 360° range, CCW = increasing phase on the vectors chart 4: Delay, -180 to +180° range, CW = increasing phase on the vectors chart 5: Delay, -180 to +180° range, CCW = increasing phase on the vectors chart 6: Delay, 0 to 360° range, CW = increasing phase on the vectors chart 7: Delay, 0 to 360° range, CCW = increasing phase on the vectors chart
PHASEPREF?	-	-	-	Responds with the NR1 value of the PHASEPREF setting as described above.
SUMVA	<i>s</i>	NR1	0 or 1	Sets the VA/VAR total method as VAR is summed, VA is calculated ( <i>s</i> =0) or VA is summed, VAR is calculated ( <i>s</i> =1).
SUMVA?	-	-	-	Responds with the NR1 VA/VAR total method as VAR is summed and VA is calculated (0) or VA is summed and VAR is calculated (1).
VARPOL	<i>s</i>	NR1	0 or 1	Sets the VAR polarity as VAR is positive ( <i>s</i> =0) or negative ( <i>s</i> =1) for leading PF
VARPOL?	-	-	-	Responds with the NR1 VAR polarity setting as VAR is positive (0) or negative (1) for leading PF

#### 24.4.8 MEASUREMENT STATE CONTROL AND QUERY COMMANDS

These commands which have a VDEF field will raise an error if the VDEF field defines a VPA which is not available.

COMMAND KEYWORD	FIELD(s)	FIELD FORMAT	FIELD DATA RANGE	DESCRIPTION
CLRINRUSH	-	-	-	Clears all inrush (max. hold) measurement results Inrush results are invalid until the next measurement period completion
DATALOG	<i>s</i>	NR1	0 or 1	Sets whether data logging is to be started ( <i>s</i> =1) or stopped ( <i>s</i> =0)
DATALOG?	-	-	-	Responds with two fields indicating the present state of data logging - 1 <sup>st</sup> field (NR1) - 0: no data logging activity is presently being performed 1: performing data logging 2 <sup>nd</sup> field (NR1) - This field is maintained after a data log is terminated and is cleared to 0 when a data log is started. 0: There has been no data logging error 1: Data logging was terminated because of file size limitation (approx. 4Gbytes) 2: Data logging was terminated because the drive became full

COMMAND KEYWORD	FIELD(s)	FIELD FORMAT	FIELD DATA RANGE	DESCRIPTION
				3: Data logging was terminated because of a drive write error 4: Data logging has terminated because the drive was removed
HISTORY	s	NR1	0 or 1	Stops (s=0) or (re)starts (s=1) historical data collection, data is cleared on (re)starting
HISTORY?	-	-	-	Responds with NR1 whether historical data collection is being performed (1) or not (0)
HOLD	s	NR1	0 or 1	Sets whether measurements are held (s=1) or not (s=0)
HOLD?	-	-	-	Responds with NR1 whether measurements are held (1) or not (0)
INTEG	s	NR1	0 or 1	Stops (s=0) or (re)starts (s=1) integrated data collection, data is cleared and the configured delay is initiated on (re)starting as applicable
INTEG?	-	-	-	Responds with NR1 indicating the present state of integration – 0: integrated results are not being updated 1: integrated results are going to be updated after the configured delay has expired 2: integrated results are held because of measurement hold 3: integrated results are being updated
MCR?	-	-	-	Responds with the NR1 MCR (Measurement Completion Register) and clears it The NR1 is a 32-bit word formed by the following logically 'or-ed' bits (b0 is the LS bit) - b0 through 2: set if VPA 1 through 3 resp. have completed a non-harmonic measurement b3: set if motor measurements have been completed b8 through 10: set if VPA 1 through 3 resp. have completed a harmonic measurement b16: set if spectrum measurements have been completed Note: this register is also cleared when any measurement configuration change is made with the SAVECONFIG command.
SCOPE	s	NR1	0 to 2	Stops (s=0), starts a single (s=1) or starts a continuous (s=2) scope view capture If starting (s =1 or s =2) then any previously captured scope view data is cleared.
SCOPE?	-	-	-	Returns the present status of scope view capture as a NR1 as follows – 0: Scope view capture is stopped (no data has been collected) 1: Scope view capture is stopped (data has been collected) 2: A single scope view capture is in progress (no data has been collected) 3: Continuous scope view capture is in progress (no data has been collected) 4: Continuous scope view capture is in progress (data has been collected)
STBYRUN	v	VDEF	-	Stops (s=0) or starts (s=1) a standby power measurement in VPA v
	s	NR1	0 or 1	
STBYSTATE?	v	VDEF	-	Returns the present state of standby power measurement in VPA v as a NR1 as follows- 0: No standby measurement in progress and no data is available (none has been previously run) 1: The last standby measurement was stopped by the operator and data is available 2: The last standby measurement was stopped normally and data is available 3: A EN50564 5.3.2d measurement is in progress but is waiting for the start detection level (no data is available). 4: A EN50564 5.3.2a measurement is in progress and is within the specified minimum time period (data is available). 5: A EN50564 5.3.2a measurement is in progress and has been extended beyond the specified minimum time period (data is available). 6: A EN50564 5.3.2d measurement is in progress (data is available).

#### 24.4.9 CONFIGURATION STORE AND RECALL COMMANDS

The PA900 contains 10 internal configuration storage areas into which you may save all configuration settings other than the power preference setting, the interface configuration and the time and date format configuration settings.

There is also a FACTORY configuration storage allowing you to set the configuration settings to the factory defaults (this storage cannot be overwritten).

COMMAND KEYWORD	FIELD(s)	FIELD FORMAT	FIELD DATA RANGE	DESCRIPTION
*SAV	n	NR1	1 to 10	Saves the present configuration into store n.
*RCL	n	NR1	0 to 10	Recalls the configuration from either – n = 0: Factory settings n = 1 to 10: store n (must have been previously saved into)

#### 24.4.10 MEASUREMENT CONFIGURATION EDIT COMMANDS

The Measurement Configuration Edit commands shown below have been split into separate sections for clarity; all of the commands described in these sections are controlled by the EDITCONFIG and SAVECONFIG commands.



While performing an internal DC zero you should not send any of these commands to the PA900.

These commands are checked only for syntax and compatibility with the installed hardware (if applicable) when each command is received and are not executed and the consistency of setting combinations are not checked until the SAVECONFIG command is used. In this manner you may configure measurements using these commands in any order without the need to consider intermediate potentially incompatible setting combinations. For this reason, the CH1 to CH4 variants of the VDEF field format are not allowed for these commands.

If you are unsure if there are any pending commands from these sections (e.g. from a prior session where the SAVECONFIG command was not used) then you may use the EDITCONFIG command to ensure that there are none (the \*RST or \*CLS command also accomplish this and are the recommended method but also perform other functions).

A typical command flow is-

Send the EDITCONFIG command (only to ensure there are no previously unsaved measurement configuration changes)

Send the required measurement configuration commands (in any order)

Send the SAVECONFIG command (to execute the prior measurement configuration commands)

The above command flow can be sent in any number of sets of commands, including all in the same set of commands.

COMMAND KEYWORD	FIELD(s)	FIELD FORMAT	FIELD DATA RANGE	DESCRIPTION
EDITCONFIG	-	-	-	Sets the configuration to be edited by the interface to that presently being used in the PA900.
SAVECONFIG	-	-	-	Sets the presently used configuration within the PA900 to include all changes made via the interface since the prior EDITCONFIG or SAVECONFIG command. When this command is executed all measurements in progress may be abandoned and restarted with the changed configuration (depending on the changes made)

#### 24.4.10.1 MEASUREMENT MODE CONFIGURATION COMMAND

COMMAND KEYWORD	FIELD(s)	FIELD FORMAT	FIELD DATA RANGE	DESCRIPTION
MODE	<i>m</i>	NR1	0 to 3, or 5 or 7	Sets the overall operating mode for the PA900 - <i>m</i> =0: Single VPA mode <i>m</i> =1: Multi-VPA mode (only valid if more than one channel fitted) <i>m</i> =2: Sync-VPA mode (only valid if more than one channel fitted) <i>m</i> =3: EN61000-3-2 mode <i>m</i> =5: EN61000-3-12 mode <i>m</i> =7: SPECTRUM mode

#### 24.4.10.2 CHANNEL CONFIGURATION COMMANDS

COMMAND KEYWORD	FIELD(s)	FIELD FORMAT	FIELD DATA RANGE	DESCRIPTION
ARANGE	<i>c</i>	CDEF	-	Sets the current input range for channel <i>c</i> - <i>r</i> =0: Selects the HI range <i>r</i> =1: selects the LO range <i>r</i> =2: selects for auto-range (only valid for a D current input channel)
	<i>r</i>	NR1	H input : 0 only D input : 0 to 2 X input : 0 to 1	
ASCALE	<i>c</i>	CDEF	-	Sets the current scaling and offset for channel <i>c</i> If <i>s</i> =zero then turns off scaling and offset ( <i>o</i> is ignored), otherwise turns on scaling and offset using <i>s</i> and <i>o</i> respectively Field <i>o</i> is optional, zero is used if not present
	<i>s</i>	NR3	0.0, or +1e-6 to +1e6	
	<i>o</i>	NR3	Within the measurable range of the channel current option	
VSCALE	<i>c</i>	CDEF	-	Sets voltage scaling for channel <i>c</i> If <i>s</i> =zero then turns off scaling Otherwise turns on voltage scaling using <i>s</i>
	<i>s</i>	NR3	0.0, or +1e-3 to +1e6	

#### 24.4.10.3 VPA CONFIGURATION COMMANDS

COMMAND KEYWORD	FIELD(s)	FIELD FORMAT	FIELD DATA RANGE	DESCRIPTION
ADJUST	<i>v</i>	VDEF	-	Sets that signals in VPA <i>v</i> may be adjusted for the voltage drop across the A terminals, or the current in the V terminals <i>a</i> =0: No adjustments are made <i>a</i> =1: adjusts the A signal to compensate for the V input current when V is connected at the source and you require the results at the source (the V current is added to the A signal) <i>a</i> =2: adjusts the V signal to compensate for the A input drop when V is connected at the load and you require the results at the source (the A drop is added to the V signal) <i>a</i> =3: adjusts the V signal to compensate for the A input drop when V is connected at the source and you require the results at the load (the A drop is subtracted from the V signal) <i>a</i> =4: adjusts the A signal to compensate for the V input current when V is connected at the load and you require the results at the load (the V current is subtracted from the A signal)
	<i>a</i>	NR1	0 to 4	



COMMAND KEYWORD	FIELD(s)	FIELD FORMAT	FIELD DATA RANGE	DESCRIPTION
BANDWIDTH	<i>v</i>	VDEF	-	Sets the Bandwidth Limit for VPA <i>v</i> <i>h</i> =0: Auto-Track Bandwidth Limiting <i>h</i> =1: No Bandwidth Limiting <i>h</i> =2: Fixed frequency bandwidth limiting set by the <i>freq</i> field in Hz The <i>freq</i> field is optional and is ignored if present if <i>h</i> is not 2.
	<i>h</i>	NR1	0 to 2	
	<i>freq</i>	NR3	>0.0	
CHANNELS	<i>v</i>	VDEF	-	Sets the channels included in VPA <i>v</i> to <i>c</i> = additive channel selection, CH1=1, CH2=2, CH3=4, CH4=8
	<i>c</i>	NR1	0 to 15	
COUPLE	<i>v</i>	VDEF	-	Sets the default measurement result coupling for VPA <i>v</i> to AC+DC ( <i>c</i> =0), AC ( <i>c</i> =1) or DC ( <i>c</i> =2)
	<i>c</i>	NR1	0 to 2	
DIGITS	<i>v</i>	VDEF	-	Sets the number of displayed digits for VPA <i>v</i> results to <i>d</i>
	<i>d</i>	NR1	3 to 6	
EFFGROUP	<i>v</i>	VDEF	-	Sets the efficiency group for VPA <i>v</i> to None ( <i>e</i> =0), IN ( <i>e</i> =1), MIDDLE ( <i>e</i> =2) or OUT ( <i>e</i> =3)
	<i>e</i>	NR1	0 to 3	
FUND	<i>v</i>	VDEF	-	Sets the fundamental frequency for VPA <i>v</i> <i>f</i> =0: No fundamental ( <i>freq</i> ignored) <i>f</i> =1: Fixed fundamental ( <i>freq</i> sets the frequency) <i>f</i> =2: V input measurement ( <i>freq</i> sets the maximum allowed frequency) <i>f</i> =3: A input measurement ( <i>freq</i> sets the maximum allowed frequency) <i>f</i> =4: MAINS fundamental ( <i>freq</i> ignored) <i>f</i> =5: AVIONICS fundamental ( <i>freq</i> ignored) <i>f</i> =6 through 8: Use VPA1 through 3 resp. as the fundamental frequency ( <i>freq</i> ignored) – cannot use VPA <i>v</i> <i>f</i> =9 through 11: Use GFUND1 through 3 resp. as the fundamental frequency ( <i>freq</i> ignored) The <i>freq</i> field need not be present if not needed
	<i>f</i>	NR1	0 to 11	
	<i>freq</i>	NR3	Set by PERIOD command selection	
HARMS	<i>v</i>	VDEF	-	Sets the maximum number of harmonics for VPA <i>v</i> to <i>h</i>
	<i>h</i>	NR1	0 to 500	
PERIOD	<i>v</i>	VDEF	-	Sets the measurement period for VPA <i>v</i> <i>p</i> =0: VLF <i>p</i> =1: LF <i>p</i> =2: 10Hz/0.3s <i>p</i> =3: 20Hz/0.1s <i>p</i> =4: 45Hz/20ms <i>p</i> =5: 150Hz/10ms <i>p</i> =6: 500Hz/2ms (not valid unless the VPA contains W type channels) <i>p</i> =7: Full synchronization with VPA1 (not valid if <i>v</i> = VPA1) <i>p</i> =8: Full synchronization with VPA2 (not valid if <i>v</i> = VPA1 or VPA2)
	<i>p</i>	NR1	<i>v</i> = 1 : 0 to 6 <i>v</i> = 2 : 0 to 7 <i>v</i> = 3 : 0 to 8	
RESPONSE	<i>v</i>	VDEF	-	Sets the measurement response for VPA <i>v</i> to Fastest ( <i>r</i> =0), Medium ( <i>r</i> =1), Slow ( <i>r</i> =2) or Slowest ( <i>r</i> =3)
	<i>r</i>	NR1	0 to 3	
STBYA	<i>v</i>	VDEF	-	Sets VPA <i>v</i> for EN50564 5.3.2 method A standby power measurements <i>d</i> is the minimum number of days for the measurement. <i>h</i> is the minimum number of hours for the measurement. <i>m</i> is the minimum number of minutes for the measurement. <i>s</i> is the minimum number of seconds for the measurement.
	<i>d</i>	NR1	0 to 99	
	<i>h</i>	NR1	0 to 99	
	<i>m</i>	NR1	0 to 99	
	<i>s</i>	NR1	0 to 99	
STBYD	<i>v</i>	VDEF	-	Sets VPA <i>v</i> for EN50564 5.3.2 method D standby power measurements <i>s</i> is the starting power detection level. <i>e</i> is the ending power detection level.
	<i>s</i>	NR3	≥0.0	
	<i>e</i>	NR3	≥0.0 and ≤s	
WIRING	<i>v</i>	VDEF	-	Sets the wiring method for VPA <i>v</i> <i>w</i> =0: N x 1Ø method. <i>w</i> =1: 2Ø3w method. <i>w</i> =2: 3Ø3w (2 channel) method. <i>w</i> =3: 3Ø3w (3 channel) method. <i>w</i> =4: 3Ø4w method
	<i>w</i>	NR1	0 to 4	

#### 24.4.10.4 SCOPE VIEW CONFIGURATION COMMANDS

COMMAND KEYWORD	FIELD(s)	FIELD FORMAT	FIELD DATA RANGE	DESCRIPTION
SCOPEINRUSH	<i>e</i>	NR1	0 or 1	Sets if performing a scope capture will temporarily override the A RANGE setting to HI and the BANDWIDTH setting to UNFILTERED ( <i>e</i> =1) or not ( <i>e</i> =0).
TIMEBASE	<i>b</i>	NR1	0 to 20	Sets the scope data capture timebase to 5µs ( <i>b</i> =0), 10µs ( <i>b</i> =1), 20µs ( <i>b</i> =2), 50µs ( <i>b</i> =3), 100µs ( <i>b</i> =4), 200µs ( <i>b</i> =5), 500µs ( <i>b</i> =6), 1ms ( <i>b</i> =7), 2ms ( <i>b</i> =8), 5ms ( <i>b</i> =9), 10ms ( <i>b</i> =10), 20ms ( <i>b</i> =11), 50ms ( <i>b</i> =12), 100ms ( <i>b</i> =13), 200ms ( <i>b</i> =14), 500ms ( <i>b</i> =15), 1s ( <i>b</i> =16), 2s ( <i>b</i> =17), 5s ( <i>b</i> =18), 10s ( <i>b</i> =19) or 20s ( <i>b</i> =20)
TRIGGER	<i>i</i>	NR1	0 to 7	Configures scope data capture triggering Trigger Input ( <i>i</i> ) : <i>i</i> =0: Trigger using CH 1 V input signal
	<i>t</i>	NR1	0 to 3	
	<i>p</i>	NR1	0 to 3	

COMMAND KEYWORD	FIELD(s)	FIELD FORMAT	FIELD DATA RANGE	DESCRIPTION
	<i>l</i>	NR3	Any	<i>i</i> =1: Trigger using CH 1 A input signal <i>i</i> =2: Trigger using CH 2 V input signal <i>i</i> =3: Trigger using CH 2 A input signal <i>i</i> =4: Trigger using CH 3 V input signal <i>i</i> =5: Trigger using CH 3 A input signal <i>i</i> =6: Trigger using CH 4 V input signal <i>i</i> =7: Trigger using CH 4 A input signal Trigger Detection Method ( <i>t</i> ) : <i>t</i> =0: DC rising edge <i>t</i> =1: DC falling edge <i>t</i> =2: Rectified signal (rising edge) <i>t</i> =3: High Frequency Trigger Position ( <i>p</i> ) : <i>p</i> =0: Trigger is at 0% of the captured time span <i>p</i> =1: Trigger is at 25% of the captured time span <i>p</i> =2: Trigger is at 50% of the captured time span <i>p</i> =3: Trigger is at 75% of the captured time span Trigger Level ( <i>l</i> ) in V or A units as applicable

#### 24.4.10.5 INTEGRATION CONFIGURATION COMMANDS

COMMAND KEYWORD	FIELD(s)	FIELD FORMAT	FIELD DATA RANGE	DESCRIPTION
INTEGAUTO	<i>i</i>	NR1	0 or 1	Sets that integration will be automatically timed ( <i>i</i> =1) or manually stopped and started ( <i>i</i> =0)
INTEGDELAY	<i>d</i>	NR1	0 to 99	Sets the automatically timed integration start delay time to <i>d</i> days, <i>h</i> hours, <i>m</i> minutes plus <i>s</i> seconds.
	<i>h</i>	NR1	0 to 99	
	<i>m</i>	NR1	0 to 99	
	<i>s</i>	NR1	0 to 99	
INTEGRUN	<i>d</i>	NR1	0 to 99	Sets the automatically timed integration run time to <i>d</i> days, <i>h</i> hours, <i>m</i> minutes plus <i>s</i> seconds.
	<i>h</i>	NR1	0 to 99	
	<i>m</i>	NR1	0 to 99	
	<i>s</i>	NR1	0 to 99	

#### 24.4.10.6 MOTOR MEASUREMENT CONFIGURATION COMMANDS

These commands only have an effect if a motor channel is installed, but they are still valid if no motor channel is installed.

COMMAND KEYWORD	FIELD(s)	FIELD FORMAT	FIELD DATA RANGE	DESCRIPTION
DIR	<i>n</i>	NR1	0 or 1	Sets that the DIR input is taken as meaning a forward direction if HI ( <i>n</i> =0) or LO ( <i>n</i> =1) at the time of the detected SPD input edge. This only has effect for a SPD setting of 3.
MTRDIGITS	<i>n</i>	NR1	3 to 6	Sets that motor results shall be displayed with <i>n</i> digits on the POWER DATA and CUSTOM screens.
MTRFFGROUP	<i>n</i>	NR1	0 to 3	Sets the efficiency group for motor power to None ( <i>n</i> =0), IN ( <i>n</i> =1), MIDDLE ( <i>n</i> =2) or OUT ( <i>n</i> =3)
MTRPERIOD	<i>n</i>	NR1	0 to 11	Sets the measurement period for motor measurement according to the value of <i>n</i> as follows- 0: 10ms measurement period 1: 30ms measurement period 2: 100ms measurement period 3: 300ms measurement period 4: 1s measurement period 5: 3s measurement period 6: 10s measurement period 7: 30s measurement period 8: 100s measurement period 9: Measurement period synchronous with VPA1 10: Measurement period synchronous with VPA2 11: Measurement period synchronous with VPA3
MTRPOLES	<i>n</i>	NR3	1.0 to 100.0	Sets that the motor has <i>n</i> poles, this is used when converting between electrical drive frequency and motor shaft rotation speed.
MTRSLIP	<i>n</i>	NR1	0 to 3	Sets the motor slip shall be calculated according to <i>n</i> as follows- 0: no motor slip calculation 1: motor slip uses the frequency from VPA1 as the drive frequency 2: motor slip uses the frequency from VPA2 as the drive frequency 3: motor slip uses the frequency from VPA3 as the drive frequency

COMMAND KEYWORD	FIELD(s)	FIELD FORMAT	FIELD DATA RANGE	DESCRIPTION
SPD	<i>n</i>	NR1	0 to 6	Sets that the Motor Speed shall be measured according to <i>n</i> as follows- 0: No speed measurement 1: Speed measured using an analog input on the SPD connector 2: Speed measured using a digital input on the SPD connector 3: Speed measured using a digital input on the SPD connector with direction indicated by the digital input on the DIR connector 4: Speed derived from the electrical drive frequency measured in VPA1 (only valid if VPA1 configured for use) 5: Speed derived from the electrical drive frequency measured in VPA2 (only valid if VPA2 configured for use) 6: Speed derived from the electrical drive frequency measured in VPA3 (only valid if VPA3 configured for use)
SPDOFFSET	<i>n</i>	NR3	-1e9 to +1e9	Sets that the offset for speed measurements shall be <i>n</i> , in units of rpm. This only has effect for SPD settings of 1, 2 or 3.
SPDRISING	<i>n</i>	NR1	0 or 1	Sets that the rising edge ( <i>n</i> =1) or falling edge ( <i>n</i> =0) of the digital SPD input shall be detected. This only has effect for SPD settings of 2 or 3.
SPDSCALE	<i>n</i>	NR3	-1e9 to +1e9	Sets that the scale factor for speed measurements shall be <i>n</i> , either in units of rpm/V (SPD setting 1) or pulses/rev (SPD setting 2 or 3). It has no effect for other settings of SPD.
TRQ	<i>n</i>	NR1	0 or 2	Sets that the Motor Torque shall be measured according to <i>n</i> as follows- 0: No torque measurement 1: Torque measured using an analog input on the TRQ connector 2: Torque measured using a digital input on the TRQ connector
TRQOFFSET	<i>n</i>	NR3	-1e9 to +1e9	Sets that the offset for torque measurements shall be <i>n</i> in units of Nm. This only has effect for TRQ settings of 1 or 2.
TRQSCALE	<i>n</i>	NR3	-1e9 to +1e9	Sets that the scale factor for torque measurements shall be <i>n</i> , either in units of Nm/V (TRQ setting 1) or Nm/Hz (TRQ setting 2). It has no effect for other settings of TRQ.

#### 24.4.10.7 DATA LOGGING CONFIGURATION COMMANDS

These commands will return an error if used while data logging is running.

COMMAND KEYWORD	FIELD(s)	FIELD FORMAT	FIELD DATA RANGE	DESCRIPTION
LOGDATA	<i>t</i>	NR1	0 or 1	Sets the data to be saved in each data logging record – Each record includes a time/date field ( <i>t</i> =1) or not ( <i>t</i> =0) and data for each DDEF field (in order)
	<i>0 to 16 fields</i>	DDEF	-	
LOGDELAY	<i>d</i>	NR1	0 to 99	Sets the data logging start delay time to <i>d</i> days, <i>h</i> hours, <i>m</i> minutes plus <i>s</i> seconds
	<i>h</i>	NR1	0 to 99	
	<i>m</i>	NR1	0 to 99	
	<i>s</i>	NR1	0 to 99	
LOGFILE	<i>f</i>	NR1	0 or 1	Configures the file used for data logging – File Format – <i>f</i> =0: ASCII <i>f</i> =1: Binary <i>f</i> =2: Internal (no further fields should be present) Header – <i>h</i> =0: No header (not valid for binary format) <i>h</i> =1: Header included File append – <i>a</i> =0: File (if exists) will be overwritten <i>a</i> =1: File (if exists) will be appended File Name ( <i>name</i> ) (excluding extension, first eight characters only) – this is case insensitive and may only contain valid file name characters for the 8.3 filename format (long file names are not supported).
	<i>h</i>	NR1	0 or 1	
	<i>a</i>	NR1	0 or 1	
LOGINTERVAL	<i>h</i>	NR1	0 to 99	Sets the data logging interval time to <i>h</i> hours, <i>m</i> minutes, <i>s</i> seconds plus <i>f</i> 1/100 <sup>th</sup> seconds (if all fields are zero then 0.002s is used)
	<i>m</i>	NR1	0 to 99	
	<i>s</i>	NR1	0 to 99	
	<i>f</i>	NR1	0 to 99	
LOGRUN	<i>d</i>	NR1	0 to 99	Sets the data logging run time to <i>d</i> days, <i>h</i> hours, <i>m</i> minutes plus <i>s</i> seconds (if all fields are 0 then selects manually timed)
	<i>h</i>	NR1	0 to 99	
	<i>m</i>	NR1	0 to 99	
	<i>s</i>	NR1	0 to 99	

#### 24.4.11 MEASUREMENT CONFIGURATION QUERY COMMANDS

These commands respond with the requested configuration being used at the time of the command, not including any unsaved changes.

These commands which have a VDEF field will raise an error if the VDEF field defines a VPA which is not available.

These commands which have a CDEF field will raise an error if the CDEF field defines a channel which is not installed.

COMMAND KEYWORD	FIELD(s)	FIELD FORMAT	FIELD DATA RANGE	DESCRIPTION
ADJUST?	v	VDEF	-	Responds with the NR1 adjustment setting for VPA v – 0: No adjustments are made 1: adjusts the A signal to compensate for the V input current when V is connected at the source and you require the results at the source (the V current is added to the A signal) 2: adjusts the V signal to compensate for the A input drop when V is connected at the load and you require the results at the source (the A drop is added to the V signal) 3: adjusts the V signal to compensate for the A input drop when V is connected at the source and you require the results at the load (the A drop is subtracted from the V signal) 4: adjusts the A signal to compensate for the V input current when V is connected at the load and you require the results at the load (the V current is subtracted from the A signal)
ARANGE?	c	CDEF	-	Responds with the NR1 current input range setting for channel c – 0: Set for the HI range 1: Set for the LO range 2: Set for auto-range, using the HI range 3: Set for auto-range, using the LO range
ASCALE?	c	CDEF	-	Responds with the current scaling and offset settings for channel c in two fields – 1 <sup>st</sup> NR3 : current scaling setting (0.0 if not configured for scaling and offset) 2 <sup>nd</sup> NR3 : current offset setting (0.0 if not configured for scaling and offset)
BANDWIDTH?	v	VDEF	-	Responds with the NR1 Bandwidth Limit setting for VPA v – 0: Auto-Track Bandwidth Limit 1: No bandwidth limit 2: Fixed frequency bandwidth limit, this is followed by a NR3 field containing the bandwidth limit frequency in Hz.
CHANNELS?	v	VDEF	-	Responds with the NR1 channel inclusion setting for VPA v – 0: none 1 through 15: additive channel selection, CH1=1, CH2=2, CH3=4, CH4=8
COUPLE?	v	VDEF	-	Responds with the NR1 default measurement result coupling setting for VPA v – 0: AC+DC 1: AC Only 2: DC Only
DIGITS?	v	VDEF	-	Responds with the NR1 displayed digits setting for VPA v
DIR?	-	-	-	Responds with the NR1 DIR input polarity setting (DIR command)
EFFGROUP?	v	VDEF	-	Responds with the NR1 efficiency group setting for VPA v – 0: None 1: IN 2: MIDDLE 3: OUT
FUND?	v	VDEF	-	Responds with the fundamental frequency setting for VPA v as two fields, the 1 <sup>st</sup> field is a NR1 and the 2 <sup>nd</sup> is a NR3 – NR1 value - 0: No fundamental, NR3 is 0.0 1: Fixed fundamental, NR3 is the fixed value 2: V input measurement, NR3 is the maximum limit 3: A input measurement, NR3 is the maximum limit 4: MAINS, NR3 is 0.0 5: AVIONICS, NR3 is 0.0 6 through 8: Use VPA1 through 3 resp. as the fundamental frequency, NR3 is 0.0 9 through 11: Use GFUND1 through 3 resp. as the fundamental frequency, NR3 is 0.0
HARMS?	v	VDEF	-	Responds with the NR1 maximum number of harmonics setting for VPA v
INTEGAUTO?	-	-	-	Responds with a NR1 if integration is automatically controlled (1) or manually controlled (0)
INTEGDELAY?	-	-	-	Responds with four NR1 values for the automatically controlled integration delay time (days, hours, minutes and seconds respectively).
INTEGRUN?	-	-	-	Responds with four NR1 values for the automatically controlled integration run time (days, hours, minutes and seconds respectively).
LOGDATA?	-	-	-	Responds with the presently defined data content in each data logging record – 1 <sup>st</sup> field (NR1) indicates if time and date is included (1) or not (0) 2 <sup>nd</sup> through 17 <sup>th</sup> fields (STRING) indicate the definition for each data field in the record (a blank field in the response indicates that the field is not included in the record)
LOGDELAY?	-	-	-	Responds with the present delay time for data logging as four NR1 fields indicating the days, hours, minutes and seconds respectively.
LOGFILE?	-	-	-	Responds with the present file settings for data logging – 1 <sup>st</sup> field (NR1) indicates if the file is in binary (1) or ASCII (0) format or saved to internal memory (2) 2 <sup>nd</sup> field (NR1) indicates if a header record will be included (1) or not (0) 3 <sup>rd</sup> field (NR1) indicates if an existing file will be append to (1) or overwritten (0) 4 <sup>th</sup> field (STRING) is the file name (including extension)

COMMAND KEYWORD	FIELD(s)	FIELD FORMAT	FIELD DATA RANGE	DESCRIPTION
LOGINTERVAL?	-	-	-	Responds with the present interval for data logging as four NR1 fields indicating the hours, minutes, seconds and 0.01seconds respectively.
LOGRUN?	-	-	-	Responds with the present run time for data logging as four NR1 fields indicating the days, hours, minutes and seconds respectively (manually controlled if all fields are 0)
MODE?	-	-	-	Responds with a NR1 showing the present overall operating mode for the PA900. 0: Single VPA mode 1: Multi-VPA mode 2: Sync-VPA mode 3: EN61000-3-2 mode 5: EN61000-3-12 mode 7: SPECTRUM mode
MTRDIGITS?	-	-	-	Responds with NR1 number of displayed digits for motor measurement results.
MTRREFFGROUP?	-	-	-	Responds with the NR1 efficiency group setting for motor power – 0: None 1: IN 2: MIDDLE 3: OUT
MTRPERIOD?	-	-	-	Responds with the Nr1 measurement period for motor measurements- 0: 10ms measurement period 1: 30ms measurement period 2: 100ms measurement period 3: 300ms measurement period 4: 1s measurement period 5: 3s measurement period 6: 10s measurement period 7: 30s measurement period 8: 100s measurement period 9: Measurement period synchronous with VPA1 10: Measurement period synchronous with VPA2 11: Measurement period synchronous with VPA3
MTRPOLES?	-	-	-	Responds with the NR3 setting for the number of motor poles (set with the MTRPOLES command)
MTRSLIP?	-	-	-	Responds with the NR1 selection controlling the calculation of motor slip- 0: no motor slip calculation 1: motor slip uses the frequency from VPA1 as the drive frequency 2: motor slip uses the frequency from VPA2 as the drive frequency 3: motor slip uses the frequency from VPA3 as the drive frequency
PERIOD?	v	VDEF	-	Responds with the NR1 measurement period setting for VPA v – 0: VLF 1: LF 2: 10Hz/0.3s 3: 20Hz/0.1s 4: 45Hz/20ms 5: 150Hz/10ms 6: 500Hz/2ms 7: Full synchronization with VPA1 8: Full synchronization with VPA2
RESPONSE?	v	VDEF	-	Responds with the NR1 measurement response setting for VPA v – 0: Fastest 1: Medium 2: Slow 3: Slowest
SCOPEINRUSH?	-	-	-	Responds with a NR1 – 0: BANDWIDTH and A RANGE will not be overridden during a scope data capture. 1: BANDWIDTH and A RANGE will be overridden during a scope data capture.
SPD?	-	-	-	Responds with the NR1 indicating the configured SPD input- 0: No speed measurement 1: Speed measured using an analog input on the SPD connector 2: Speed measured using a digital input on the SPD connector 3: Speed measured using a digital input on the SPD connector with direction indicated by the digital input on the DIR connector 4: Speed derived from the electrical drive frequency measured in VPA1 (only valid if VPA1 configured for use) 5: Speed derived from the electrical drive frequency measured in VPA2 (only valid if VPA2 configured for use) 6: Speed derived from the electrical drive frequency measured in VPA3 (only valid if VPA3 configured for use)
SPDOFFSET?	-	-	-	Responds with the NR3 setting for the speed measurement offset
SPDRISING?	-	-	-	Responds with NR1 indicating if the rising edge (1) or the falling edge of the SPD digital input is being detected
SPDSCALE?	-	-	-	Responds with the NR3 setting for the speed measurement scaling

COMMAND KEYWORD	FIELD(s)	FIELD FORMAT	FIELD DATA RANGE	DESCRIPTION
STBY?	v	VDEF	-	Responds with the standby power measurement settings for VPA v – If the configured method is EN50564 5.3.2a: 1 <sup>st</sup> field is a STRING of value A 2 <sup>nd</sup> field is a NR1 with the days minimum measurement time setting 3 <sup>rd</sup> field is a NR1 with the days minimum measurement time setting 4 <sup>th</sup> field is a NR1 with the days minimum measurement time setting 5 <sup>th</sup> field is a NR1 with the days minimum measurement time setting If the configured method is EN50564 5.3.2d: 1 <sup>st</sup> field is a STRING of value D 2 <sup>nd</sup> field is a NR3 with the starting power detection level setting 3 <sup>rd</sup> field is a NR3 with the ending power detection level setting
TIMEBASE?	-	-	-	Responds with the NR1 scope data capture timebase setting as 5µs (0), 10µs (1), 20µs (2), 50µs (3), 100µs (4), 200µs (5), 500µs (6), 1ms (7), 2ms (8), 5ms (9), 10ms (10), 20ms (11), 50ms (12), 100ms (13), 200ms (14), 500ms (15), 1s (16), 2s (17), 5s (18), 10s (19) or 20s (20)
TRIGGER?	-	-	-	Responds with the scope data capture triggers settings as the following four fields – 1 <sup>st</sup> field (NR1) is the trigger input selection – 0: Trigger using CH 1 V input signal 1: Trigger using CH 1 A input signal 2: Trigger using CH 2 V input signal 3: Trigger using CH 2 A input signal 4: Trigger using CH 3 V input signal 5: Trigger using CH 3 A input signal 6: Trigger using CH 4 V input signal 7: Trigger using CH 4 A input signal 2 <sup>nd</sup> field (NR1) is the trigger method selection – 0: DC rising edge 1: DC falling edge 2: Rectified signal (rising edge) 3: High Frequency 3 <sup>rd</sup> field (NR1) is the trigger position selection – 0: trigger is at 0% of the captured time span 1: trigger is at 25% of the captured time span 2: trigger is at 50% of the captured time span 3: trigger is at 75% of the captured time span 4 <sup>th</sup> field (NR3) is the configured trigger level in V or A units as applicable
TRQ?	-	-	-	Responds with the NR1 indicating the configured TRQ input- 0: No torque measurement 1: Torque measured using an analog input on the TRQ connector 2: Torque measured using a digital input on the TRQ connector
TRQOFFSET?	-	-	-	Responds with the NR3 setting for the torque measurement offset
TRQSCALE?	-	-	-	Responds with the NR3 setting for the torque measurement scaling
VSCALE?	c	CDEF	-	Responds with the NR3 voltage scaling setting (0.0 if not configured for scaling) for channel c
VPA?	c	CDEF	-	Responds with the NR1 indicating which VPA channel c is configured in (1 through 3) or if not configured or not installed (0)
WIRING?	v	VDEF	-	Responds with the NR1 wiring method setting for VPA v – 0: N x 1Ø method. 1: 2Ø3w method. 2: 3Ø3w (2 channel) method. 3: 3Ø3w (3 channel) method. 4: 3Ø4w method

#### 24.4.12 CONFIGURATION TEMPORARY SAVE AND LOAD COMMANDS

These commands allow the user to temporarily save and reload the complete configuration of the PA900 (the saved configuration is volatile, i.e. it is not retained after a power cycle).

COMMAND KEYWORD	FIELD(s)	FIELD FORMAT	FIELD DATA RANGE	DESCRIPTION
TEMPSAVECFG	-	-	-	Saves the present complete configuration of the PA900 into an internal temporary storage.
TEMPLOADCFG	-	-	-	Reloads the previously saved configuration from a TEMPSAVECFG command. If there was no previous TEMPSAVECFG command then this command raises an error. This command can only be used once for each TEMPSAVECFG command.

#### 24.4.13 HARMONICS LIMITS CONFIGURATION AND CONFIGURATION QUERY COMMANDS

Any changes made to harmonics limits take an immediate effect but are volatile until the SAVEHLIMITS command is used (i.e. will not be retained when power is turned off).

COMMAND KEYWORD	FIELD(s)	FIELD FORMAT	FIELD DATA RANGE	DESCRIPTION
CLRHLIMITS	i	KEYWORD	V or A	Removes all voltage (i=V) or current (i=A) harmonic limits



COMMAND KEYWORD	FIELD(s)	FIELD FORMAT	FIELD DATA RANGE	DESCRIPTION
HLIMIT	<i>i</i>	KEYWORD	V or A	Sets voltage ( <i>i</i> =V) or current ( <i>i</i> =A) limit for harmonic <i>h</i> according to the remaining fields as follows - <i>t</i> sets the type of limit (if any) to apply - <i>t</i> =0: no limit applied (further fields are optional and are ignored if present) <i>t</i> =1: the limit is the highest of the percentage and level limits <i>t</i> =2: the limit is the addition of the percentage and level limits <i>p</i> sets whether the percentage limit is a percentage of the fundamental ( <i>p</i> =0) or of the total signal ( <i>p</i> =1) <i>plimit</i> and <i>llimit</i> are the percentage and level limits respectively Note : setting a limit with both <i>plimit</i> and <i>llimit</i> =0.0 will never pass
	<i>h</i>	NR1	1 to 500	
	<i>t</i>	NR1	0 to 2	
	<i>p</i>	NR1	0 or 1	
	<i>plimit</i>	NR3	≥0.0	
HLIMIT?	<i>i</i>	KEYWORD	V or A	Responds with the HLIMIT command STRING needed to reproduce the voltage ( <i>i</i> =V) or current ( <i>i</i> =A) limit for harmonic <i>h</i>
	<i>h</i>	NR1	1 to 500	
SAVEHLIMITS	<i>i</i>	KEYWORD	V or A	Saves all voltage ( <i>i</i> =V) or current ( <i>i</i> =A) harmonic limits

#### 24.4.14 DC ZERO CONTROL AND QUERY COMMANDS

COMMAND KEYWORD	FIELD(s)	FIELD FORMAT	FIELD DATA RANGE	DESCRIPTION
DCZERO	-	-	-	Initiates an INT DC ZERO activity on all configured channels (same as the SYS CONFIG -> INT DC ZERO button) Sets DCZ register as needed and clears DCZERR register Suspends normal measurement actions of the PA900 until ENDDCZERO is received
DCZ?	-	-	-	Responds with the NR1 DCZ register b0 through 3: set if CH 1 through 4 resp. are performing an INT DC Zero activity Each bit clears when the activity is successfully completed or ENDDCZERO commanded
DCZERR?	-	-	-	Responds with the NR1 DCZERR register b0 through 3: set if CH 1 through 4 resp. have found an error during an INT DC Zero activity
ENDDCZERO	-	-	-	Terminates an INT DC ZERO activity on all channels (aborts if still in progress) Clears DCZ and DCZERR registers Returns to normal measurement actions of the PA900
EXTDCZERO	<i>o</i>	NR1	0 or 1	Performs an external DC Zero. If <i>o</i> is 0 then all channels have their DC zeroes adjusted to the present DC measurements, otherwise if <i>o</i> is 1 then only those channels which are scaled have their DC zeroes adjusted to the present DC measurements.

#### 24.4.15 CUSTOM SCREEN CONFIGURATION AND CONFIGURATION QUERY COMMANDS

The actual custom screen is not updated with the results of any changes until the SAVECUSTOM command is actioned. The use of the CLRCUSTOM command is recommended prior to starting to generate a custom screen via the interface to ensure that no existing contents of a custom screen are included in a newly generated screen. Following a SAVECUSTOM command no further custom screen commands can be executed for up to 300ms and attempting to do so raises an error.

Note that the CUSTOM command must either be the only command or the last command in a set of commands (i.e. it must be terminated by a command terminator character).

A custom screen is composed of 57 cells arranged in 15 rows with row 0 (the topmost row) only having a single column and rows 1 through 14 having 4 columns (the leftmost column is 0). For cells other than the row 0 cell, for text sizes other than 12pix or 16pix then the target cell is expanded to include surrounding cells as follows -

22pix text size: includes the cell to the right of the target cell.

28pix and 36pix text sizes: includes the cell to the right of the target cell and also the cells immediately below both the target cell and that to the right of it.

COMMAND KEYWORD	FIELD(s)	FIELD FORMAT	FIELD DATA RANGE	DESCRIPTION
CLRCUSTOM	-	-	-	Sets the custom screen totally blank
CUSTOM	<i>r</i>	NR1	0 to 14	Set custom screen cell row ( <i>r</i> ), column ( <i>c</i> ) according to the remaining fields - <i>size</i> sets the text size to 12pix ( <i>size</i> =0), 16pix ( <i>size</i> =1), 22pix ( <i>size</i> =2), 28pix ( <i>size</i> =3) or 36pix ( <i>size</i> =4) <i>just</i> sets the horizontal text justification to left ( <i>just</i> =0), centered ( <i>just</i> =1) or right ( <i>just</i> =2) <i>colour</i> sets the text colour (R:G:B values) <i>def</i> sets the measurement result to be shown (blank if none required) <i>units</i> selects whether to include the measurement results units ( <i>units</i> =1) or not ( <i>units</i> =0) <i>text</i> sets the text to include. If <i>def</i> is defined then up to the first 5 characters of <i>text</i> are included to the left of the measurement result otherwise the cell contains up to the first 60 characters of <i>text</i> ; if no characters are to be included in the cell then the <i>text</i> field need not be present If both <i>def</i> and <i>text</i> fields are blank (or not included) then only the <i>r</i> and <i>c</i> fields are used
	<i>c</i>	NR1	0 to 3	
	<i>size</i>	NR1	0 to 4	
	<i>just</i>	NR1	0 to 2	
	<i>colour</i>	COLOR	-	
	<i>def</i>	RDEF	-	
	<i>units</i>	NR1	0 or 1	
CUSTOM?	<i>r</i>	NR1	0 to 14	Responds with the CUSTOM command string to recreate custom screen row <i>r</i> and column <i>c</i>
	<i>c</i>	NR1	0 to 3	



COMMAND KEYWORD	FIELD(s)	FIELD FORMAT	FIELD DATA RANGE	DESCRIPTION
SAVECUSTOM	-	-	-	Saves the present custom screen internally and makes any changes active

## 24.4.16 MEASUREMENT RESULTS QUERY COMMANDS

These commands which have a VDEF field will raise an error if the VDEF field defines a VPA which is not available.

These commands which have a CDEF field will raise an error if the CDEF field defines a channel which is not installed.

COMMAND KEYWORD	FIELD(s)	FIELD FORMAT	FIELD DATA RANGE	DESCRIPTION
CYCLEVIEW?	<i>c</i>	CDEF	-	Responds with the 512 data points of cycle view data for channel <i>c</i> voltage ( <i>s</i> =V), current ( <i>s</i> =A) or power ( <i>s</i> =W) waveforms The data points correspond to phases of the fundamental starting at 0° and then at successive (360/512)° increments. Each data point contains two fields as follows – 1 <sup>st</sup> field : NR1 indicating if this data point has a valid data (1) or not (0) 2 <sup>nd</sup> field : NR3 indicating the level at this data point Note – the response is a large number of characters (approximately 7K) and is a total of 1024 fields. Not all data points may be valid, interpolate between valid data points as appropriate.
	<i>s</i>	KEYWORD	V or A or W	
HARMLIST?	<i>i</i>	KEYWORD	V or A or W	Responds with one NR3 harmonic amplitude for the voltage input ( <i>i</i> =V) or current input ( <i>i</i> =A) or power ( <i>i</i> =W) of channel <i>c</i> for each harmonic starting with the <i>start</i> harmonic up to and including the <i>end</i> harmonic (the fundamental is harmonic 1).
	<i>c</i>	CDEF	-	
	<i>start</i>	NR1	1 to 500	
	<i>end</i>	NR1	<i>start</i> to 500	
HISTORYDATA?	<i>n</i>	NR1	2 to 1024	Responds with <i>n</i> data points of historical data defined by <i>def</i> , starting at historical data collection time <i>start</i> and ending at <i>end</i> (both in seconds relative to the time at which historical data collection was last started) Each data point is four fields as follows – 1 <sup>st</sup> field: NR1 indicating if this data point contains data (1) or not (0) 2 <sup>nd</sup> field: NR3 indicating the maximum data recorded 3 <sup>rd</sup> field: NR3 indicating the average data recorded 4 <sup>th</sup> field: NR3 indicating the minimum data recorded Note – the response can be a very large number of characters (up to 38.9K) and fields (up to 4096).
	<i>start</i>	NR3	≥0.0	
	<i>end</i>	NR3	> <i>start</i>	
	<i>def</i>	DDEF	-	
HISTORYTIME?	-	-	-	Responds with an NR3 indicating the length of time covered by the present historical data (in seconds)
HLIMITFAIL?	<i>c</i>	CDEF	-	Responds with a NR1 indicating if harmonic <i>h</i> ( <i>h</i> >0) or all harmonics ( <i>h</i> =0) for the voltage ( <i>i</i> =V) or current ( <i>i</i> =A) of channel <i>c</i> is passing (responds with 0) or failing (responds with 1) Note – a harmonic which has no limit or is not being measured is considered as passing
	<i>i</i>	KEYWORD	V or A	
	<i>h</i>	NR1	0 to 500	
LEADING?	<i>srce</i>	KEYWORD	CH1, CH2, CH3, CH4, A1, A2, A3, VPA1, VPA2, or VPA3	Responds with a NR1 indicating if the selected data source ( <i>srce</i> ) has a leading PF (responds with 1) or lagging PF (responds with 0) <i>srce</i> is either- A1 to A3: selects VPA1 to 3 as the data source VPA1 to VPA3: selects VPA1 to 3 as the data source CH1 to CH4: selects channel 1 to channel 4 as the data source
MAXHARMS?	<i>v</i>	VDEF	-	Responds with a NR1 indicating the number of harmonics being measured in VPA <i>v</i>
READ?	≥1 fields	RDEF	-	Responds with the requested measurement result(s). You may specify any number of results to be obtained in a single READ? command as long as the command is within the allowable maximum number of characters in a command set and the response generated is less than the maximum number of characters in a response.
REREAD?	-	-	-	Responds with the measurement results defined by the last received READ? command. Note – this is typically used when a large number of results are to be repeatedly requested and a slow interface (e.g. USB or RS232) is being used. Sending the READ? command once and then repeating by using the REREAD? command achieves higher throughput because of the reduction in characters required. When using the LAN interface there is typically very little difference if the REREAD? command is used vs using the READ? Command.
SCOPEVIEW?	<i>c</i>	CDEF	-	Responds with <i>n</i> data points of scope view data defined by <i>c</i> and <i>s</i> , starting at time <i>start</i> and ending at <i>end</i> (both in seconds relative to the trigger detection time) Each data point is three fields as follows – 1 <sup>st</sup> field: NR1 indicating if this data point contains data (1) or not (0) 2 <sup>nd</sup> field: NR3 indicating the minimum level at this data point 3 <sup>rd</sup> field: NR3 indicating the maximum level at this data point Note – the response can be a very large number of characters (up to 55.3K) and fields (up to 6144). Note – if the requested timespan is a small fraction of the captured timespan then not all response data may have valid data.
	<i>s</i>	KEYWORD	V or A or W	
	<i>n</i>	NR1	2 to 2048	
	<i>start</i>	NR3	-	
	<i>end</i>	NR3	> <i>start</i>	
STBYERR?	<i>c</i>	CDEF	-	Responds with a NR1 indicating if the PA900 measurement error was outside of the requirements of EN50564 at any time during the measurement (responds with 1) or not (responds with 0)
STBYHISTORY?	<i>c</i>	CDEF	-	Responds with <i>n</i> data points of standby historical data defined by <i>def</i> , ending at relative time <i>end</i> (in seconds relative to the time at which the standby measurement was started)
	<i>n</i>	NR1	2 to 1024	
	<i>end</i>	NR3	>0.0	

COMMAND KEYWORD	FIELD(s)	FIELD FORMAT	FIELD DATA RANGE	DESCRIPTION
	<i>def</i>	STRING	W, V, VCF, VTHD, FREQ, A, ACF, PF or ERR	The <i>def</i> field is- W: responds with the Watts data V: responds with the Volts data VCF: responds with the Volts Crest Factor data VTHD: responds with the Volts Distortion data (in percent) FREQ: responds with the Frequency data A: responds with the Amps data ACF: responds with the Amps Crest Factor data PF: responds with the Power Factor data ERR: responds with the PA900 Measurement Error data (in Watts) Each data point is three fields as follows – 1 <sup>st</sup> field: NR1 indicating if this data point contains data (1) or not (0) 2 <sup>nd</sup> field: NR3 indicating the maximum data recorded 3 <sup>rd</sup> field: NR3 indicating the minimum data recorded Note – the response can be a very large number of characters (up to 24.6K) and fields (up to 3072).
STBYVCF?	<i>c</i>	CDEF	-	Responds with a NR1 indicating if the voltage crest factor was outside of the requirements of EN50564 at any time during the measurement (responds with 1) or not (responds with 0)
STBYVTHD?	<i>c</i>	CDEF	-	Responds with a NR1 indicating if the voltage distortion was outside of the requirements of EN50564 at any time during the measurement (responds with 1) or not (responds with 0)

## 24.5 RDEF MEASUREMENT DEFINITION FIELD SUB-FIELDS

This field is made up of one to five sub-fields, each separated by the sub-field separator (colon character). The sub-fields may be specified in any order and may optionally be omitted (a default value being used as needed).

Sub-Field	Sub-field Format	Value	Description
Measurement Data	KEYWORD	FREQ	Responds with a signal frequency (in Hz)
		PERIOD	Responds with a signal period (in seconds)
		INTEGTIME	Responds with the integration time (in Hours)
		VOLTS or V	Responds with a voltage (in V)
		VPH-PH	Responds with an inter-phase voltage (in V). The measurement source field must be CH1 through CH4 defining a channel which is configured in a VPA which is configured for 3p3w(3ch) or 3p4w wiring.
		AMPS or A	Responds with a current (in A)
		WATTS or W	DEFAULT if no other Measurement Data sub-field found Responds with a real power (in W)
		LOSS	Responds with a real power loss (in W)
		EFFICIENCY or EFF	Responds with a real power efficiency (in %)
		VAR	Responds with an imaginary power (in W)
		VA	Responds with an apparent power (in VA)
		PF	Responds with power factor
		PHASE	Responds with apparent phase ( $\cos^{-1}(\text{PF})$ , in degrees)
		LOADZ or ZLOAD	Responds with load impedance (in ohms)
		SERIESR	Responds with load series resistance (in ohms)
		SERIESL	Responds with load series inductance (in henries)
		PARALLELR	Responds with load parallel resistance (in ohms)
		PARALLELC	Responds with load parallel capacitance (in farads)
		SPEED	Responds with motor speed (in rpm)
		SLIP	Responds with motor slip (in %)
TORQUE	Responds with motor torque (in Nm)		
HP	Responds with motor power (in HP, use WATTS or W for motor power in watts)		
STBYTIME	Responds with elapsed standby power measurement time (in hours)		
STBYERR	Responds with standby power measurement error (in W)		
Measurement Source	KEYWORD	CH1, CH2, CH3 or CH4	CH1 is DEFAULT if no other Measurement Source sub-field found Data is from the selected channel
		A1, A2, A3, VPA1, VPA2 or VPA3	Data is from the selected VPA
		MOTOR	Data is a motor measurement result (only the Data field is used with this source, any other fields are ignored)
		IN	Data is from the IN efficiency group (or starts at this group if 2 <sup>nd</sup> Measurement Source is MIDDLE or OUT)
		MIDDLE	Data is from the MIDDLE efficiency group (or starts at this group if 2 <sup>nd</sup> Measurement Source is OUT)
2 <sup>nd</sup> Measurement Source (ignored if Measurement Source is a single channel or is MOTOR)	KEYWORD	OUT	Data is from the OUT efficiency group
		MIDDLE	Data is to the MIDDLE efficiency group (only valid if Measurement Source is IN)
		OUT	Data is to the OUT efficiency group (only valid if Measurement Source is IN or MIDDLE)

Sub-Field	Sub-field Format	Value	Description
		pA ... D	Data is from the 1 <sup>st</sup> through 4 <sup>th</sup> (resp.) channel of the selected VPA
		pAC	Data is the voltage measured between phases A and C of the selected VPA
		pAB	Data is the voltage measured between phases A and B of the selected VPA
		pBC	Data is the voltage measured between phases B and C of the selected VPA
		pN	Data is the neutral current of the selected VPA
		WYE	Data is the 'Wye' voltage of the selected VPA
		DELTA	Data is the 'Delta' voltage of the selected VPA
		SEQZERO	Data is the zero sequence data of the selected VPA
		SEQPOS	Data is the positive sequence data of the selected VPA
		SEQNEG	Data is the negative sequence data of the selected VPA
		TOTAL or AVERAGE	DEFAULT if no other 2 <sup>nd</sup> Measurement Source sub-field found Data is the total for the selected VPA, except for VOLTS and AMPS data which is the average of all channels/phases
Measurement Type	KEYWORD	DC	Data is the DC component
		AC	Data is the AC component
		ACDC or RMS	Data is the ACDC component
		COUPLED	DEFAULT if no other Measurement Type sub-field found Data is the DC, AC or ACDC component as COUPLING setting
		RECTIFIED	Data is the average rectified (ACDC)
		STBY	Data is the average standby power measurement (ACDC)
		STBYMIN	Data is the minimum standby power measurement (ACDC)
		STBYMAX	Data is the maximum standby power measurement (ACDC)
		STBYCFMIN	Data is the minimum crest factor standby power measurement (ACDC)
		STBYCFMAX	Data is the maximum crest factor standby power measurement (ACDC)
		STBYTHDMAX	Data is the maximum THD standby power measurement (as the percentage of the fundamental)
		STBYSLOPE	Data is the slope (in W/sec) of the standby power measurement
		FF	Data is the form factor (ACDC)
		CF	Data is the crest factor (ACDC)
		PK	Data is peak (ACDC)
		VALLEY	Data is valley peak (ACDC)
		PK-VLY	Data is the difference between peak and valley peak
		HIPK	Data is the highest peak (including polarity, ACDC)
		LOPK	Data is the lowest peak (including polarity, ACDC)
		THDF	Data is THD relative to fundamental amplitude (in %)
		THDSIG	Data is THD relative to ACDC amplitude (in %)
		H1 ... 500	Data is harmonic amplitude data for the specified harmonic
		P1 ... 500	Data is harmonic phase data for the specified harmonic (in degrees with $\pm 180^\circ$ range)
		INRUSH	Data is the inrush data (max hold, ACDC)
		INRUSHPK	Data is the peak inrush data (max hold, PK data)
		INRUSHVLY	Data is the valley peak inrush data (min hold, VALLEY data)
		INTEG	Data is the integrated data (as COUPLING setting)
		INTAVG	Data is the average integrated data (as COUPLING setting)
		CHARGE	Data is the integrated charge data (DC only)
		DISCHARGE	Data is the integrated discharge data (DC only)
		BOUGHT	Data is the integrated bought data (as COUPLING setting)
		SOLD	Data is the integrated sold data (as COUPLING setting)
		%2 ... 500	Data is as Hn but expressed as a percentage of the fundamental
%S2 ... 500	Data is as Hn but expressed as a percentage of the ACDC amplitude		
THC	Total Harmonic Current (only valid when used with AMPS data for a channel)		
POHC	Partial Odd Harmonic Current (only valid when used with AMPS data for a channel)		
PWHC	Partial Weighted Harmonic Current (only valid when used with AMPS data for a channel)		
Ending Harmonic (only used if Measurement Type is H1 ... 500 or %2 ... 500)	NR1	1 to 500	Data includes harmonics up to and including this number (if this sub-field is not specified then data only includes the single harmonic specified in the Measurement Type sub-field)

A list of allowed combinations is provided below. In this list the following codes are used to reduce the length of the list –

CHn Any of CH1, CH2, CH3 or CH4  
An Any of A1, A2 or A3  
pX Any of pA, pB, pC or pD  
Hn Any of H1 ... 500  
n Any of 1 ... 500  
Pn Any of P1 ... 500  
%n Any of %2 ... 500 or %S2 ... 500

Not all combinations shown may be allowed in all circumstances; channels might not be installed or the configuration may not provide valid results for a specific combination. Not all valid combinations may be shown below and where a default sub-field value may be used the combination is only shown without defining that specific sub-field.

FREQ:CHn	VOLTS:An:pX:THDsig	VOLTS:An:INTAVG:H1	AMPS:An:pX:SOLD
FREQ:CHn:STBYMIN	VOLTS:An:pX:%n	VOLTS:An:CHARGE	AMPS:An:pX:Hn
FREQ:CHn:STBYMAX	VOLTS:An:pX:%n:n	VOLTS:An:DISCHARGE	AMPS:An:pX:Hn:n
FREQ:An	VOLTS:An:pAC:AC	VOLTS:An:BOUGHT	AMPS:An:pX:Pn
INTEGTIME:CHn:INTEG	VOLTS:An:pAC:ACDC	VOLTS:An:SOLD	AMPS:An:pX:THDf
INTEGTIME:CHn:CHARGE	VOLTS:An:pAC	VOLTS:An:H1	AMPS:An:pX:THDsig
INTEGTIME:CHn:DISCHARGE	VOLTS:An:pAC:RECTIFIED	VPH-PH:CHn:DC	AMPS:An:pX:%n
INTEGTIME:CHn:BOUGHT	VOLTS:An:pAC:FF	VPH-PH:CHn:AC	AMPS:An:pX:%n:n
INTEGTIME:CHn:SOLD	VOLTS:An:pAC:CF	VPH-PH:CHn:ACDC	AMPS:An:pN:DC
INTEGTIME:An:INTEG	VOLTS:An:pAC:PK	VPH-PH:CHn	AMPS:An:pN:AC
INTEGTIME:An:CHARGE	VOLTS:An:pAC:HIPK	VPH-PH:CHn:RECTIFIED	AMPS:An:pN:ACDC
INTEGTIME:An:DISCHARGE	VOLTS:An:pAC:LOPK	VPH-PH:CHn:FF	AMPS:An:pN
INTEGTIME:An:BOUGHT	VOLTS:An:pAC:INRUSH	VPH-PH:CHn:CF	AMPS:An:pN:RECTIFIED
INTEGTIME:An:SOLD	VOLTS:An:pAC:INRUSHPK	VPH-PH:CHn:PK	AMPS:An:pN:FF
STBYTIME:CHn	VOLTS:An:pAC:INTEG	VPH-PH:CHn:Hn	AMPS:An:pN:CF
STBYTIME:An	VOLTS:An:pAC:INTAVG	VPH-PH:CHn:Hn:n	AMPS:An:pN:PK
VOLTS:CHn:DC	VOLTS:An:pAC:BOUGHT	VPH-PH:CHn:THDf	AMPS:An:pN:INRUSH
VOLTS:CHn:AC	VOLTS:An:pAC:SOLD	VPH-PH:CHn:THDsig	AMPS:An:pN:INRUSHPK
VOLTS:CHn:ACDC	VOLTS:An:pAC:Hn	VPH-PH:CHn:%n	AMPS:An:pN:Hn
VOLTS:CHn	VOLTS:An:pAC:Hn:n	VPH-PH:CHn:%n:n	AMPS:An:pN:Hn:n
VOLTS:CHn:RECTIFIED	VOLTS:An:pAC:Pn	AMPS:CHn:DC	AMPS:An:pN:Pn
VOLTS:CHn:FF	VOLTS:An:pAC:THDf	AMPS:CHn:AC	AMPS:An
VOLTS:CHn:CF	VOLTS:An:pAC:THDsig	AMPS:CHn:ACDC	AMPS:An:RECTIFIED
VOLTS:CHn:PK	VOLTS:An:pAC:%n	AMPS:CHn	AMPS:An:PK
VOLTS:CHn:VALLEY	VOLTS:An:pAC:%n:n	AMPS:CHn:RECTIFIED	AMPS:An:INRUSH
VOLTS:CHn:PK-VLY	VOLTS:An:pBC:AC	AMPS:CHn:FF	AMPS:An:INRUSHPK
VOLTS:CHn:HIPK	VOLTS:An:pBC:ACDC	AMPS:CHn:CF	AMPS:An:INTEG
VOLTS:CHn:LOPK	VOLTS:An:pBC	AMPS:CHn:PK	AMPS:An:INTAVG
VOLTS:CHn:INRUSH	VOLTS:An:pBC:RECTIFIED	AMPS:CHn:VALLEY	AMPS:An:INTEG:H1
VOLTS:CHn:INRUSHPK	VOLTS:An:pBC:FF	AMPS:CHn:PK-VLY	AMPS:An:INTAVG:H1
VOLTS:CHn:INRUSHVLY	VOLTS:An:pBC:CF	AMPS:CHn:HIPK	AMPS:An:CHARGE
VOLTS:CHn:INTEG	VOLTS:An:pBC:PK	AMPS:CHn:LOPK	AMPS:An:DISCHARGE
VOLTS:CHn:INTAVG	VOLTS:An:pBC:HIPK	AMPS:CHn:INRUSH	AMPS:An:SEQZERO
VOLTS:CHn:INTEG:H1	VOLTS:An:pBC:LOPK	AMPS:CHn:INRUSHPK	AMPS:An:SEQPOS
VOLTS:CHn:INTAVG:H1	VOLTS:An:pBC:INRUSH	AMPS:CHn:INRUSHVLY	AMPS:An:SEQNEG
VOLTS:CHn:CHARGE	VOLTS:An:pBC:INRUSHPK	AMPS:CHn:INTEG	AMPS:An:BOUGHT
VOLTS:CHn:DISCHARGE	VOLTS:An:pBC:INTEG	AMPS:CHn:INTAVG	AMPS:An:SOLD
VOLTS:CHn:BOUGHT	VOLTS:An:pBC:INTAVG	AMPS:CHn:INTEG:H1	AMPS:An:H1
VOLTS:CHn:SOLD	VOLTS:An:pBC:BOUGHT	AMPS:CHn:INTAVG:H1	WATTS:CHn:DC
VOLTS:CHn:Hn	VOLTS:An:pBC:SOLD	AMPS:CHn:CHARGE	WATTS:CHn:AC
VOLTS:CHn:Hn:n	VOLTS:An:pBC:Hn	AMPS:CHn:DISCHARGE	WATTS:CHn:ACDC
VOLTS:CHn:Pn	VOLTS:An:pBC:Hn:n	AMPS:CHn:BOUGHT	WATTS:CHn
VOLTS:CHn:THDf	VOLTS:An:pBC:Pn	AMPS:CHn:SOLD	WATTS:CHn:Hn
VOLTS:CHn:THDsig	VOLTS:An:pBC:THDf	AMPS:CHn:Hn	WATTS:CHn:Hn:n
VOLTS:CHn:%n	VOLTS:An:pBC:THDsig	AMPS:CHn:Hn:n	WATTS:CHn:%n
VOLTS:CHn:%n:n	VOLTS:An:pBC:%n	AMPS:CHn:Pn	WATTS:CHn:INRUSH
VOLTS:CHn:STBY	VOLTS:An:pBC:%n:n	AMPS:CHn:THDf	WATTS:CHn:INTEG
VOLTS:CHn:STBYMIN	VOLTS:An:pAB:AC	AMPS:CHn:THDsig	WATTS:CHn:INTAVG
VOLTS:CHn:STBYMAX	VOLTS:An:pAB:ACDC	AMPS:CHn:%n	WATTS:CHn:INTEG:H1
VOLTS:CHn:STBYCFMIN	VOLTS:An:pAB	AMPS:CHn:%n:n	WATTS:CHn:INTAVG:H1
VOLTS:CHn:STBYCFMAX	VOLTS:An:pAB:RECTIFIED	AMPS:CHn:STBY	WATTS:CHn:CHARGE
VOLTS:CHn:STBYTHDMAX	VOLTS:An:pAB:FF	AMPS:CHn:STBYMIN	WATTS:CHn:DISCHARGE
VOLTS:An:pX:DC	VOLTS:An:pAB:CF	AMPS:CHn:STBYMAX	WATTS:CHn:BOUGHT
VOLTS:An:pX:AC	VOLTS:An:pAB:PK	AMPS:CHn:STBYCFMAX	WATTS:CHn:SOLD
VOLTS:An:pX:ACDC	VOLTS:An:pAB:INRUSH	AMPS:CHn:THC	WATTS:CHn:STBY
VOLTS:An:pX	VOLTS:An:pAB:INRUSHPK	AMPS:CHn:POHC	WATTS:CHn:STBYMIN
VOLTS:An:pX:RECTIFIED	VOLTS:An:pAB:Hn	AMPS:CHn:PWHC	WATTS:CHn:STBYMAX
VOLTS:An:pX:FF	VOLTS:An:pAB:Hn:n	AMPS:An:pX:DC	WATTS:CHn:STBYSLOPE
VOLTS:An:pX:CF	VOLTS:An:pAB:Pn	AMPS:An:pX:AC	WATTS:An:pX:DC
VOLTS:An:pX:PK	VOLTS:An:pAB:THDf	AMPS:An:pX:ACDC	WATTS:An:pX:AC
VOLTS:An:pX:HIPK	VOLTS:An:pAB:THDsig	AMPS:An:pX	WATTS:An:pX:ACDC
VOLTS:An:pX:LOPK	VOLTS:An:pAB:%n	AMPS:An:pX:RECTIFIED	WATTS:An:pX
VOLTS:An:pX:INRUSH	VOLTS:An:pAB:%n:n	AMPS:An:pX:FF	WATTS:An:pX:H1
VOLTS:An:pX:INRUSHPK	VOLTS:An:SEQZERO	AMPS:An:pX:CF	WATTS:An:pX:INRUSH
VOLTS:An:pX:INTEG	VOLTS:An:SEQPOS	AMPS:An:pX:PK	WATTS:An:pX:INTEG
VOLTS:An:pX:INTAVG	VOLTS:An:SEQNEG	AMPS:An:pX:HIPK	WATTS:An:pX:INTAVG
VOLTS:An:pX:INTEG:H1	VOLTS:An:WYE	AMPS:An:pX:LOPK	WATTS:An:pX:INTEG:H1
VOLTS:An:pX:INTAVG:H1	VOLTS:An:DELTA	AMPS:An:pX:INRUSH	WATTS:An:pX:INTAVG:H1
VOLTS:An:pX:CHARGE	VOLTS:An	AMPS:An:pX:INRUSHPK	WATTS:An:pX:CHARGE
VOLTS:An:pX:DISCHARGE	VOLTS:An:RECTIFIED	AMPS:An:pX:INTEG	WATTS:An:pX:DISCHARGE
VOLTS:An:pX:BOUGHT	VOLTS:An:PK	AMPS:An:pX:INTAVG	WATTS:An:pX:BOUGHT
VOLTS:An:pX:SOLD	VOLTS:An:INRUSH	AMPS:An:pX:INTEG:H1	WATTS:An:pX:SOLD
VOLTS:An:pX:Hn	VOLTS:An:INRUSHPK	AMPS:An:pX:INTAVG:H1	WATTS:An:pAC:DC
VOLTS:An:pX:Hn:n	VOLTS:An:INTEG	AMPS:An:pX:CHARGE	WATTS:An:pAC:AC
VOLTS:An:pX:Pn	VOLTS:An:INTAVG	AMPS:An:pX:DISCHARGE	WATTS:An:pAC:ACDC
VOLTS:An:pX:THDf	VOLTS:An:INTEG:H1	AMPS:An:pX:BOUGHT	WATTS:An:pAC

WATTS:An:pAC:H1	VAR:An:pX:ACDC	VA:An:pX:INTAVG	PF:An:pX:INTAVG
WATTS:An:pAC:INRUSH	VAR:An:pX	VA:An:pX:INTEG:H1	PF:An:pX:INTAVG:H1
WATTS:An:pAC:INTEG	VAR:An:pX:H1	VA:An:pX:INTAVG:H1	PF:An:pX:H1
WATTS:An:pAC:INTAVG	VAR:An:pX:INTEG	VA:An:pX:CHARGE	PF:An:pAC:AC
WATTS:An:pAC:CHARGE	VAR:An:pX:INTAVG	VA:An:pX:DISCHARGE	PF:An:pAC:ACDC
WATTS:An:pAC:DISCHARGE	VAR:An:pX:INTEG:H1	VA:An:pX:BOUGHT	PF:An:pAC
WATTS:An:pAC:BOUGHT	VAR:An:pX:INTAVG:H1	VA:An:pX:SOLD	PF:An:pAC:INTAVG
WATTS:An:pAC:SOLD	VAR:An:pX:BOUGHT	VA:An:pAC:DC	PF:An:pAC:H1
WATTS:An:pBC:DC	VAR:An:pX:SOLD	VA:An:pAC:AC	PF:An:pBC:AC
WATTS:An:pBC:AC	VAR:An:pAC:AC	VA:An:pAC:ACDC	PF:An:pBC:ACDC
WATTS:An:pBC:ACDC	VAR:An:pAC:ACDC	VA:An:pAC	PF:An:pBC
WATTS:An:pBC	VAR:An:pAC	VA:An:pAC:H1	PF:An:pBC:INTAVG
WATTS:An:pBC:H1	VAR:An:pAC:H1	VA:An:pAC:INTEG	PF:An:pBC:H1
WATTS:An:pBC:INRUSH	VAR:An:pAC:INTEG	VA:An:pAC:INTAVG	PF:An:AC
WATTS:An:pBC:INTEG	VAR:An:pAC:INTAVG	VA:An:pAC:CHARGE	PF:An:ACDC
WATTS:An:pBC:INTAVG	VAR:An:pAC:BOUGHT	VA:An:pAC:DISCHARGE	PF:An
WATTS:An:pBC:CHARGE	VAR:An:pAC:SOLD	VA:An:pAC:BOUGHT	PF:An:INTAVG
WATTS:An:pBC:DISCHARGE	VAR:An:pBC:AC	VA:An:pAC:SOLD	PF:An:INTAVG:H1
WATTS:An:pBC:BOUGHT	VAR:An:pBC:ACDC	VA:An:pBC:DC	PF:An:H1
WATTS:An:pBC:SOLD	VAR:An:pBC	VA:An:pBC:AC	PHASE:CHn:AC
WATTS:An:DC	VAR:An:pBC:H1	VA:An:pBC:ACDC	PHASE:CHn:H1
WATTS:An:AC	VAR:An:pBC:INTEG	VA:An:pBC	PHASE:An:pX:AC
WATTS:An:ACDC	VAR:An:pBC:INTAVG	VA:An:pBC:H1	PHASE:An:pX:H1
WATTS:An	VAR:An:pBC:BOUGHT	VA:An:pBC:INTEG	PHASE:An:pAC:AC
WATTS:An:H1	VAR:An:pBC:SOLD	VA:An:pBC:INTAVG	PHASE:An:pAC:H1
WATTS:An:INRUSH	VAR:An:AC	VA:An:pBC:CHARGE	PHASE:An:pBC:AC
WATTS:An:INTEG	VAR:An:ACDC	VA:An:pBC:DISCHARGE	PHASE:An:pBC:H1
WATTS:An:INTAVG	VAR:An	VA:An:pBC:BOUGHT	PHASE:An:AC
WATTS:An:INTEG:H1	VAR:An:H1	VA:An:pBC:SOLD	PHASE:An:H1
WATTS:An:INTAVG:H1	VAR:An:INTEG	VA:An:DC	LOADZ:CHn:DC
WATTS:An:CHARGE	VAR:An:INTAVG	VA:An:AC	LOADZ:CHn:AC
WATTS:An:DISCHARGE	VAR:An:INTEG:H1	VA:An:ACDC	LOADZ:CHn:ACDC
WATTS:An:BOUGHT	VAR:An:INTAVG:H1	VA:An	LOADZ:CHn
WATTS:An:SOLD	VAR:An:BOUGHT	VA:An:H1	LOADZ:CHn:H1
WATTS:IN	VAR:An:SOLD	VA:An:INTEG	SERIESR:CHn:AC
WATTS:MIDDLE	VA:CHn:DC	VA:An:INTAVG	SERIESR:CHn:H1
WATTS:OUT	VA:CHn:AC	VA:An:INTEG:H1	SERIESL:CHn:AC
LOSS:IN:MIDDLE	VA:CHn:ACDC	VA:An:INTAVG:H1	SERIESL:CHn:H1
LOSS:IN:OUT	VA:CHn	VA:An:CHARGE	PARALLELR:CHn:AC
LOSS:MIDDLE:OUT	VA:CHn:H1	VA:An:DISCHARGE	PARALLELR:CHn:H1
EFFICIENCY:IN:MIDDLE	VA:CHn:INTEG	VA:An:BOUGHT	PARALLELC:CHn:AC
EFFICIENCY:IN:OUT	VA:CHn:INTAVG	VA:An:SOLD	PARALLELC:CHn:H1
EFFICIENCY:MIDDLE:OUT	VA:CHn:INTEG:H1	PF:CHn:AC	STBYERR:CHn:STBY
VAR:CHn:AC	VA:CHn:INTAVG:H1	PF:CHn:ACDC	STBYERR:CHn:STBYMIN
VAR:CHn:ACDC	VA:CHn:CHARGE	PF:CHn	STBYERR:CHn:STBYMAX
VAR:CHn	VA:CHn:DISCHARGE	PF:CHn:INTAVG	MOTOR:WATTS
VAR:CHn:H1	VA:CHn:BOUGHT	PF:CHn:INTAVG:H1	MOTOR:SPEED
VAR:CHn:INTEG	VA:CHn:SOLD	PF:CHn:H1	MOTOR:SLIP
VAR:CHn:INTAVG	VA:An:pX:DC	PF:CHn:STBY	MOTOR:TORQUE
VAR:CHn:INTEG:H1	VA:An:pX:AC	PF:CHn:STBYMIN	MOTOR:HP
VAR:CHn:INTAVG:H1	VA:An:pX:ACDC	PF:CHn:STBYMAX	
VAR:CHn:BOUGHT	VA:An:pX	PF:An:pX:AC	
VAR:CHn:SOLD	VA:An:pX:H1	PF:An:pX:ACDC	
VAR:An:pX:AC	VA:An:pX:INTEG	PF:An:pX	

## 24.6 DDEF MEASUREMENT DEFINITION FIELD SUB-FIELDS

This field is made up of one to five sub-fields, each separated by the sub-field separator (colon character). The sub-fields may be specified in any order and may optionally be omitted (a default value being used as needed).

Sub-Field	Sub-field Format	Value	Description
Measurement Data	KEYWORD	FREQ	Signal frequency (in Hz)
		VOLTS or V	Voltage (in V)
		AMPS or A	Current (in A)
		WATTS or W	DEFAULT if no other Measurement Data sub-field found Real power (in W)
		LOSS	Real power loss (in W)
		EFFICIENCY or EFF	Real power efficiency (in %)
		VAR	Imaginary power (in W)
		VA	Apparent power (in VA)
		PF	Power factor
		SPEED	Motor speed (in rpm)
		SLIP	Motor slip (in %)
		TORQUE	Motor torque (in Nm)
		LOADZ	Load impedance (in ohms)



Sub-Field	Sub-field Format	Value	Description
Measurement Source	KEYWORD	CH1, CH2, CH3 or CH4	CH1 is DEFAULT if no other Measurement Source sub-field found Data is from the selected channel
		A1, A2, A3, VPA1, VPA2 or VPA3	Data is from the selected VPA
		MOTOR	Data is a motor measurement result (only the Data field is used with this, any other fields are ignored)
		IN	Data is from the IN efficiency group
		MIDDLE	Data is from the MIDDLE efficiency group
		OUT	Data is from the OUT efficiency group
		IN-MID	Data is from the IN efficiency group to the MIDDLE efficiency group
		IN-OUT	Data is from the IN efficiency group to the OUT efficiency group
2 <sup>nd</sup> Measurement Source (ignored if Measurement Source is not a VPA)	KEYWORD	pA ... D	Data is from the 1 <sup>st</sup> through 4 <sup>th</sup> (resp.) channel of the selected VPA
		pAC	Data is the voltage measured between phases A and C of the selected VPA
		pAB	Data is the voltage measured between phases A and B of the selected VPA
		pBC	Data is the voltage measured between phases B and C of the selected VPA
		pN	Data is the neutral current of the selected VPA
		TOTAL or AVERAGE	DEFAULT if no other 2 <sup>nd</sup> Measurement Source sub-field found Data is the total for the selected VPA, except for VOLTS and AMPS data which is the average of all channels/phases in the selected VPA
Measurement Type	KEYWORD	DC	Data is the DC component
		AC	Data is the AC component
		ACDC or RMS	Data is the ACDC component
		COUPLED	DEFAULT if no other Measurement Type sub-field found Data is the DC, AC or ACDC component as configured for the VPA
		CF	Data is the crest factor (ACDC)
		PK	Data is peak (ACDC)
		VALLEY	Data is valley peak
		PK-VLY	Data is the difference between peak and valley peak
		HIPK	Data is the highest peak (including polarity, ACDC coupled)
		LOPK	Data is the lowest peak (including polarity, ACDC coupled)
		THDF	Data is THD relative to fundamental amplitude (in %)
		THDSIG	Data is THD relative to ACDC amplitude (in %)
		H1 or H2 or H3	Data is harmonic amplitude data for the 1 <sup>st</sup> , 2 <sup>nd</sup> or 3 <sup>rd</sup> harmonic respectively
		P1	Data is harmonic phase data for the fundamental (in degrees with $\pm 180^\circ$ range)
HLIST	Data is a list of the harmonic amplitudes for each harmonic. This may only be used with the LOGDATA command, and only with a channel Measurement Source, and only with voltage or current Measurement Data.		
Ending Harmonic (only used if Measurement Type is HLIST)	NR1	1 to 500	This sub-field is only used with a Measurement Type of HLIST; if present it is ignored for other measurement types. Data includes harmonics up to and including this number (if this sub-field is not specified then the data includes all allowable harmonics)

A list of allowed combinations is provided below. In this list the following codes are used to reduce the length of the list –

CHn Any of CH1, CH2, CH3 or CH4  
An Any of A1, A2 or A3  
pX Any of pA, pB, pC or pD  
Hn Any of H1 ... 3

Not all combinations shown may be allowed in all circumstances; channels might not be installed or the configuration may not provide valid results for a specific combination. Not all valid combinations may be shown below and where a default sub-field value may be used the combination is only shown without defining that specific sub-field.

FREQ:CHn	VOLTS:CHn:LOPK	VOLTS:An:pX:CF	VOLTS:An:pAC:CF
FREQ:An	VOLTS:CHn:Hn	VOLTS:An:pX:PK	VOLTS:An:pAC:PK
VOLTS:CHn:DC	VOLTS:CHn:P1	VOLTS:An:pX:HIPK	VOLTS:An:pAC:HIPK
VOLTS:CHn:AC	VOLTS:CHn:THDf	VOLTS:An:pX:LOPK	VOLTS:An:pAC:LOPK
VOLTS:CHn:ACDC	VOLTS:CHn:THDsig	VOLTS:An:pX:Hn	VOLTS:An:pAC:Hn
VOLTS:CHn	VOLTS:CHn:HLIST	VOLTS:An:pX:P1	VOLTS:An:pAC:P1
VOLTS:CHn:CF	VOLTS:CHn:HLIST:n	VOLTS:An:pX:THDf	VOLTS:An:pAC:THDf
VOLTS:CHn:PK	VOLTS:An:pX:DC	VOLTS:An:pX:THDsig	VOLTS:An:pAC:THDsig
VOLTS:CHn:VALLEY	VOLTS:An:pX:AC	VOLTS:An:pAC:AC	VOLTS:An:pBC:AC
VOLTS:CHn:PK-VLY	VOLTS:An:pX:ACDC	VOLTS:An:pAC:ACDC	VOLTS:An:pBC:ACDC
VOLTS:CHn:HIPK	VOLTS:An:pX	VOLTS:An:pAC	VOLTS:An:pBC



VOLTS:An:pBC:CF	WATTS:An:ACDC	LOADZ:CHn
VOLTS:An:pBC:PK	WATTS:An	LOADZ:CHn:H1
VOLTS:An:pBC:HIPK	WATTS:An:H1	MOTOR:WATTS
VOLTS:An:pBC:LOPK	WATTS:IN	MOTOR:SPEED
VOLTS:An:pBC:Hn	WATTS:MIDDLE	MOTOR:SLIP
VOLTS:An:pBC:P1	WATTS:OUT	MOTOR:TORQUE
VOLTS:An:pBC:THDf	LOSS:IN-MID	
VOLTS:An:pBC:THDsig	LOSS:IN-OUT	
VOLTS:An:pAB:AC	LOSS:MID-OUT	
VOLTS:An:pAB:ACDC	EFFICIENCY:IN-MID	
VOLTS:An:pAB	EFFICIENCY:IN-OUT	
VOLTS:An:pAB:CF	EFFICIENCY:MID-OUT	
VOLTS:An:pAB:PK	VAR:CHn:AC	
VOLTS:An:pAB:Hn	VAR:CHn:ACDC	
VOLTS:An:pAB:P1	VAR:CHn	
VOLTS:An:pAB:THDf	VAR:CHn:H1	
VOLTS:An:pAB:THDsig	VAR:An:pX:AC	
VOLTS:An	VAR:An:pX:ACDC	
VOLTS:An:PK	VAR:An:pX	
VOLTS:An:H1	VAR:An:pX:H1	
AMPS:CHn:DC	VAR:An:pAC:AC	
AMPS:CHn:AC	VAR:An:pAC:ACDC	
AMPS:CHn:ACDC	VAR:An:pAC	
AMPS:CHn	VAR:An:pAC:H1	
AMPS:CHn:CF	VAR:An:pBC:AC	
AMPS:CHn:PK	VAR:An:pBC:ACDC	
AMPS:CHn:VALLEY	VAR:An:pBC	
AMPS:CHn:PK-VLY	VAR:An:pBC:H1	
AMPS:CHn:HIPK	VAR:An:AC	
AMPS:CHn:LOPK	VAR:An:ACDC	
AMPS:CHn:Hn	VAR:An	
AMPS:CHn:P1	VAR:An:H1	
AMPS:CHn:THDf	VA:CHn:DC	
AMPS:CHn:THDsig	VA:CHn:AC	
AMPS:CHn:HLIST	VA:CHn:ACDC	
AMPS:CHn:HLIST:n	VA:CHn	
AMPS:An:pX:DC	VA:CHn:H1	
AMPS:An:pX:AC	VA:An:pX:DC	
AMPS:An:pX:ACDC	VA:An:pX:AC	
AMPS:An:pX	VA:An:pX:ACDC	
AMPS:An:pX:CF	VA:An:pX	
AMPS:An:pX:PK	VA:An:pX:H1	
AMPS:An:pX:HIPK	VA:An:pAC:DC	
AMPS:An:pX:LOPK	VA:An:pAC:AC	
AMPS:An:pX:Hn	VA:An:pAC:ACDC	
AMPS:An:pX:P1	VA:An:pAC	
AMPS:An:pX:THDf	VA:An:pAC:H1	
AMPS:An:pX:THDsig	VA:An:pBC:DC	
AMPS:An:pN:DC	VA:An:pBC:AC	
AMPS:An:pN:AC	VA:An:pBC:ACDC	
AMPS:An:pN:ACDC	VA:An:pBC	
AMPS:An:pN	VA:An:pBC:H1	
AMPS:An:pN:CF	VA:An:DC	
AMPS:An:pN:PK	VA:An:AC	
AMPS:An:pN:H1	VA:An:ACDC	
AMPS:An	VA:An	
AMPS:An:PK	VA:An:H1	
AMPS:An:H1	PF:CHn:AC	
WATTS:CHn:DC	PF:CHn:ACDC	
WATTS:CHn:AC	PF:CHn	
WATTS:CHn:ACDC	PF:CHn:H1	
WATTS:CHn	PF:An:pX:AC	
WATTS:CHn:H1	PF:An:pX:ACDC	
WATTS:An:pX:DC	PF:An:pX	
WATTS:An:pX:AC	PF:An:pX:H1	
WATTS:An:pX:ACDC	PF:An:pAC:AC	
WATTS:An:pX	PF:An:pAC:ACDC	
WATTS:An:pX:H1	PF:An:pAC	
WATTS:An:pAC:DC	PF:An:pAC:H1	
WATTS:An:pAC:AC	PF:An:pBC:AC	
WATTS:An:pAC:ACDC	PF:An:pBC:ACDC	
WATTS:An:pAC	PF:An:pBC	
WATTS:An:pAC:H1	PF:An:pBC:H1	
WATTS:An:pBC:DC	PF:An:AC	
WATTS:An:pBC:AC	PF:An:ACDC	
WATTS:An:pBC:ACDC	PF:An	
WATTS:An:pBC	PF:An:H1	
WATTS:An:pBC:H1	LOADZ:CHn:DC	
WATTS:An:DC	LOADZ:CHn:AC	
WATTS:An:AC	LOADZ:CHn:ACDC	

## 25 INSIDE THE PA900

This section is intended to give you an insight into the internal structure of the PA900. In order to use the PA900 knowledge of the internal operation of the PA900 is not necessary. In many places a full description is not provided to protect IP rights. The diagram below is a simplified block diagram of the measurement flow inside a PA900.

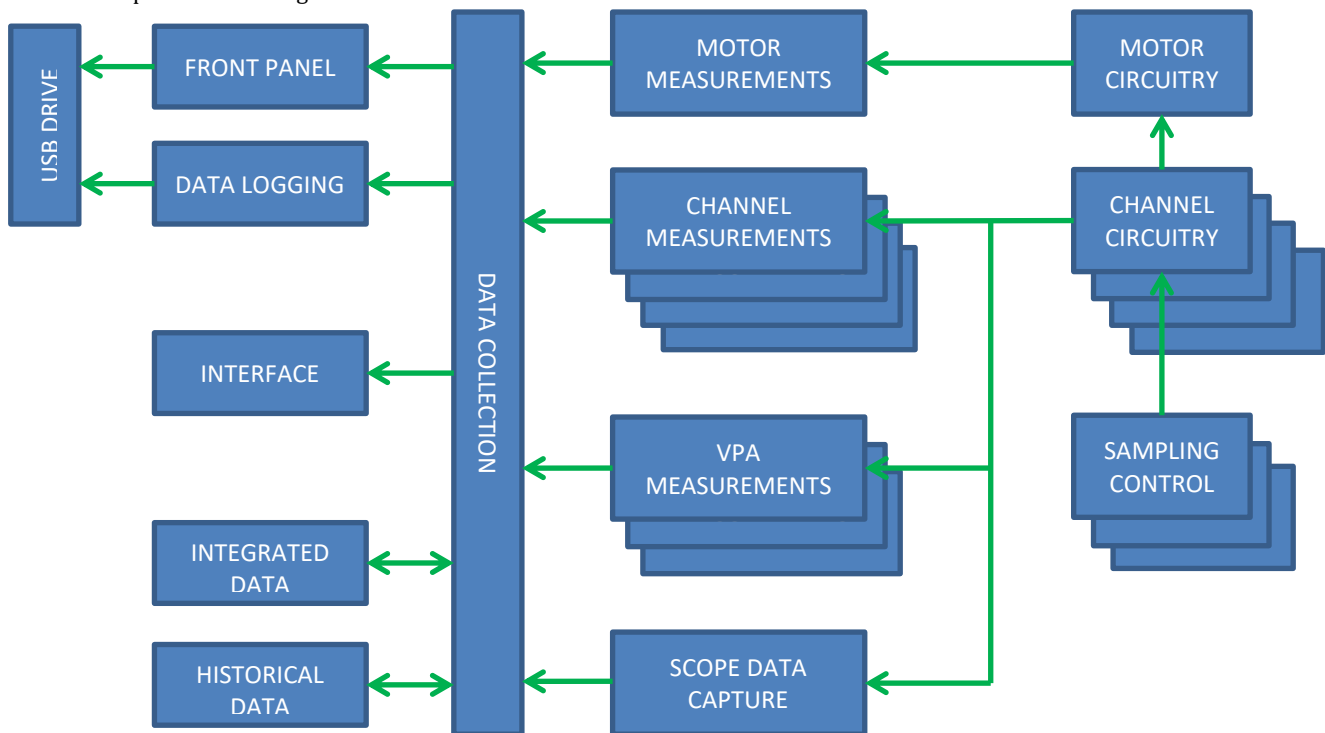

### 25.1 GENERAL MEASUREMENT METHODS

All measurement results obtained within the PA900 are based on digital 22 or 24-bit resolution samples obtained of the voltage and current signals provided to each of the PA900 channels. The analog-to-digital conversion technique used in the PA900 is a proprietary 2-stage compound ADC method.

The signals themselves are not modified prior to sampling other than fixed scaling and minimal low-pass filtering to reduce sampling anomalies and the only modifications made to the samples are –

- Application of calibration scaling and offsets.
- Adding or subtracting scaled current samples from the voltages samples, or vice versa, to compensate for the V or A terminal burden of the channel as enabled by the ADJUST configuration setting.
- Low-pass filtering according to the BANDWIDTH configuration setting.

The following measurements are all performed by the PA900 at all times as required, unless otherwise stated these are continuously applied using all samples of the signals –

Frequency	The frequency of a selected voltage or current signal within each VPA has its frequency measured using all samples obtained for the selected signal. Frequency is determined using the reciprocal period of zero value crossings of the band-pass filtered selected signal samples.
Highest and lowest peaks	The highest and lowest of all samples obtained for each signal within each measurement period are recorded as the highest and lowest peak measurement results.
Lowest half-cycle valley	The largest of all samples obtained for each signal within each half-cycle of the fundamental period is recorded, the smallest of these recorded half-cycle samples within each measurement period is recorded as the signal valley measurement results.
Other non-harmonic measurement results.	All other non-harmonic measurements are performed using all samples within each measurement period. All AC and AC+DC measurement results are the RMS values, and all DC measurement results are the mean values during each measurement period.
Harmonic analysis	An anti-aliased sub-set of the samples used for non-harmonic measurements within each measurement period are used for DFT based harmonic analysis; each set is collected and analysed before another set may be collected (for EN61000-3-2 and -12 the analysis is performed within each measurement period so there is never a delay between periods).
Spectral analysis	An anti-aliased set of samples are used for DFT based spectrum analysis; each set is collected and then analysed before another set is collected.
Scope trigger detection and capture.	A set of samples are used for scope trigger detection and capture; each set is collected and then analysed before another set may be collected.

In all cases the measurement results obtained from the PA900 are directly the results of these analyses; for example neither the measurement results nor the calibration scaling applied are modified for signal frequency content.

## 25.2 CHANNEL CIRCUITRY

The diagram below is a simplified block diagram of the circuitry for each channel. Up to 4 channels can be installed in a PA900. Although not shown in this diagram, there is digital filtering on the sample data for both voltage and current as required for the BANDWIDTH configuration of the controlling VPA and the data is scaled and offset according to the channel calibration data and to user set scale and offset factors. The analog filtering shown in the diagram is simply to reduce sampling artifacts.

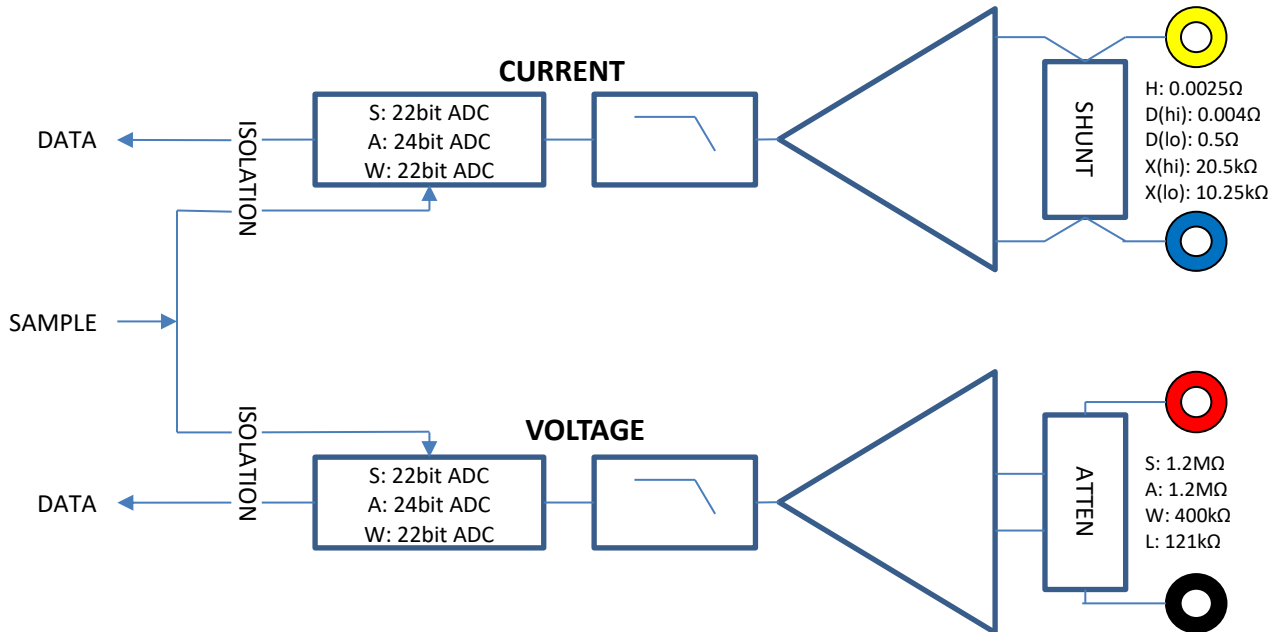

## 25.3 SAMPLING CONTROL

There are 3 sampling controls in a PA900. Typically each is associated with a VPA, however if you configure the LF/PERIOD setting in a VPA to synchronize that VPA to a lower numbered VPA then the sampling control of that VPA is used for the channels in the VPA so configured.

Sampling control performs the following–

Calculation of the measurement period for measurement results.

The measurement period is adjusted to be an integer number of fundamental cycles which is the closest to the configured measurement period for the controlling VPA.

A half-cycle period is also generated for controlling the period of half-cycle valley measurements.

Calculation and control of the sampling period of channels.

The required sampling period is calculated to yield an integer number of samples in a measurement period which gives the closest sampling period to the nominal sampling period for the channels being controlled. The sampling period is also adjusted to not yield an integer number of samples in any harmonic (including the fundamental) over 500Hz. The nominal sampling period for the channel types are as follows (this does not limit the HF amplitude performance of the PA900) –

L, S or A types: 245KSPS

W type: 910KSPS

Each actual sampling period is controlled with 2.5ps average resolution and 2.6ns incremental resolution with a quasi-random distribution of incremental sample periods within a range sufficient to avoid Nyquist sampling limits.

This yields an effective sampling rate of 384MSPS and synchronization to the measured fundamental to within <1ppm.

Starting and stopping measurement periods.

If the PA900 measurement mode is configured to anything other than SYNC-VPA then each sampling control always immediately starts a measurement period when the previous one ends. In this manner all channel and VPA measurements are totally 'gapless'.

If the PA900 measurement mode is configured to SYNC-VPA then each sampling control will start all measurement periods if all measurement periods have ended. In this manner all channel and VPA measurements are synchronized, but only the longest one is 'gapless'.

## 25.4 CHANNEL MEASUREMENTS

For each of the channels the following measurements are performed –

Voltage and current DC (the average of the samples in the measurement period).

Voltage and current maximum peak (the highest sample in the measurement period).

Voltage and current minimum peak (the lowest sample in the measurement period).

Voltage and current half-cycle based valley measurements.

Voltage and current rectified (the average modulus sample in the measurement period).

Voltage and current RMS (the square root of the average squared sample in the measurement period).

Watts (the average of the voltage and current samples multiplied together in the measurement period)

Harmonic amplitude and phase analysis of the voltage and current samples (using Fourier Transforms). This analysis is only performed if a) the fundamental frequency is known, and b) you have configured for at least 1 harmonic to be analyzed.

Formulation of the Cycle View data from all samples in the measurement period. Cycle view places every sample from the measurement period at the correct phase to build a single cycle formed from all cycles present during the measurement period. This uses the results of the harmonic analysis at the fundamental to position the samples correctly and it uses the fundamental frequency.

Spectral analysis of the voltage and current samples (using Fourier Transforms). This analysis is only performed if configured.

D current option only (if configured for auto-range):

At any time during a measurement period if the range is presently the LO range and the current is at least close to overload then the HI range is immediately commanded in this channel and the relevant sampling control is commanded to start a new measurement period however all channels in the affected VPA are commanded to not discard the existing peak results when starting this measurement period.

If at the end of the measurement period the range is presently the HI range but all samples within the measurement were below a level indicating that the LO range may be used, then the LO range is commanded prior to starting the next measurement period.

## 25.5 VPA MEASUREMENTS

### 25.5.1 VPA FUNDAMENTAL FREQUENCY

Each VPA provides a fundamental frequency to its associated sampling control as determined by the FUND configuration setting in the VPA; this may be by measurement, by configuration, or from another VPA.

If the fundamental frequency is measured then this is from the voltage or current in the lowest numbered channel in the VPA and uses the following method-

This is performed by measurement of the period between zero crossings of the output of a digital band-pass filter which uses the configured samples from the channel.

Hysteresis is employed on the zero crossing detection to prevent near fundamental signal components from creating false zero crossing detections.

Because the filtering is band-pass the frequency is established regardless of any DC signal content.

The low frequency corner of the band-pass filter is set by the LF/PERIOD setting for the VPA.

The high frequency corner of the band-pass filter is continuously adjusted to match the measured frequency. The maximum corner frequency of this filter is limited by the FUND setting of the VPA.

To correctly detect the edges of the waveform there must be at least 3 samples in each cycle, thus the maximum measurable frequency is just over 80kHz for L, A and S channel types, or just over 305kHz for W channel types.

### 25.5.2 VPA AMPLITUDE MEASUREMENTS

For each of the VPAs the following measurements are performed depending on the WIRING configuration of the VPA.

N x 1 $\emptyset$	There are no VPA measurements performed.
2 $\emptyset$ 3w	Measurements of the difference between the two channel voltages (this produces the results for $\emptyset$ AB data) and measurements of the sum of the two channel currents (this produces the results for N data).
3 $\emptyset$ 3w(2ch)	Measurements of the difference between the two channel voltages (this produces the results for $\emptyset$ AB data) and measurements of the sum of the two channel currents (this produces the results for $\emptyset$ C data).
3 $\emptyset$ 3w(3ch)	Measurements of the difference between every pair of channel voltages (this produces the results for $\emptyset$ AB, $\emptyset$ AC and $\emptyset$ BC data).
3 $\emptyset$ 4w	Measurements of the difference between every pair of channel voltages (this produces the results for $\emptyset$ AB, $\emptyset$ AC and $\emptyset$ BC data) and measurements of the sum of the three channel currents (this produces the results for N data).

VPA measurements are a sub-set of the channel voltage/current measurements –

DC (the average of the samples in the measurement period).

Peak (the highest modulus sample in the measurement period).

Rectified (the average modulus sample in the measurement period).

RMS (the square root of the average squared sample in the measurement period).

## 25.6 DATA COLLECTION

This collects together the measurement results from the Channel and VPA Measurements to provide all final measurement results. In many cases this involves more than one actual measurement result with calculations performed to produce each final result. All final measurement results are continuously calculated and have the configured response filtering imposed, those results are then held as required if you have commanded to hold measurements. In this manner all response filtered results have the correct and linear response filtering characteristics.

Examples of final results computations include –

AC voltages and currents are computed from the DC and AC+DC RMS measurement results using the fact that  $(AC+DC)^2 = (AC)^2 + (DC)^2$

DC Watts for a channel is computed from the multiplication of the DC voltage and current (and is identical to DC VA).

AC Watts for a channel is computed using the fact that  $W(AC+DC) = W(DC) + W(AC)$

VA for a channel is computed from the multiplication of the appropriate voltage and current data.

PF (for a channel or for a VPA) is computed using the fact that  $PF = W / VA$ .

VAR for a channel is computed using the fact that  $VA^2 = W^2 + VAR^2$  with the polarity of the resultant VAR set according to the configured lead/lag information.

VPA total Watts is computed from the sum of the Watts for the channels in the VPA

VPA total VAR and VA is computed according to the method selected in the configuration for that VPA.

VPA overall lead/lag is taken from the polarity of the sum of the channel VAR for the VPA.

The total Watts for an efficiency group is the sum of the VPA total Watts for each VPA configured by the EFF/LOSS setting to be in the requested group.

## 25.7 INTEGRATED DATA

At the end of every measurement period in any VPA, all integrated results are accumulated with the product of the result and the entire measurement period time (if integration was neither started nor stopped during it) or a partial measurement period time (if integration was started and/or stopped during it).

## 25.8 DATA LOGGING

While data logging is running the configured data is obtained from the 'data collection' block and is saved into a large buffer FIFO. The output of this FIFO is formatted as needed and written to the USB Drive if possible.

## 26 OPTIONS AND ACCESSORIES

### 26.1 ACCESSORY RM-7

This accessory provides a rack mounting kit which allows the PA900 to be mounted in a 4U (7") space in a 19" rack.

### 26.2 ACCESSORY LPA-1

This accessory provides the connections necessary for you to connect a mains plug for a unit under test to a mains supply, with one channel of the PA900 analyzing the power drawn by the unit under test.

Note: this accessory is limited to a maximum of 300Vrms and 10Arms.





## 27 DIMENSIONAL, ENVIRONMENTAL AND POWER SUPPLY SPECIFICATIONS

### 27.1 DIMENSIONAL

Nominal Dimensions	137mmH x 248mmW x 284mmD (5.4" x 9.75" x 11.2") with feet not extended
Nominal Weight	3.2kg (7lb) net, 5kg (11lb) shipping

### 27.2 ENVIRONMENTAL

Storage Environment	-20 to 75C (-4 to 167F) (non-condensing)
Operating Environment	0 to 40C (32 to 104F), <85% RH (non-condensing), Pollution Degree 2
Operating Altitude	0 to 2000m (6560ft) ASL

### 27.3 POWER SUPPLY

Line Power	Installation Category II; 85-264Vrms, 45 to 65Hz, 40VA max. Internally fused with a non-user serviceable fuse
------------	--

## 28 ELECTRICAL CHANNEL INPUT AND ACCURACY SPECIFICATIONS

Specifications are valid under the following conditions-

- All specifications are valid following a 20 minute warm-up period after turning power ON in the PA900, when operated from the specified source of power and within the specified environmental conditions.
- All specifications in the tables of this section other than those labelled Base Scaling Error are valid for the lifetime of the PA900; Base Scaling Error specifications are valid for up to 2 years after calibration in normal use, or 6 months when continuously used above 75% of the maximum specified voltage or current signal range.
- All specifications are valid at the PA900 terminals.
- DC floor specifications assume that AUTOZERO is ON. If AUTOZERO is OFF add the DC Floor specification per C from the temperature of the last performed INT DC ZERO or when AUTOZERO was last ON (whichever occurred last).
- MAINS specifications are valid for signals with 45Hz to 65Hz fundamental with 20 to 100 harmonics configured and when using AUTO-TRACK bandwidth limiting; otherwise use the AVIONICS or AC specifications as applicable.
- AVIONICS specifications are valid for signals with 300Hz to 900Hz fundamental with 20 to 62 harmonics configured or for signals with 45Hz to 65Hz fundamental with >100 harmonics configured, and when using AUTO-TRACK bandwidth limiting; otherwise use the AC or MAINS specifications.
- Accuracy specifications are valid for Crest Factors <100 (within peak measurable input signal range and bandwidth limitations).
- Harmonics specifications are valid for <(10%/configured number of harmonics) cycle-to-cycle jitter in fundamental frequency and with each harmonic <(100%/harmonic number) of the total signal.

Note:

The No Damage input signal range is that which will not cause immediate damage. Continued use of these levels may reduce reliability and/or future accuracy.

The Measurable input signal range is that which can be measured (the No Damage limits may limit the time for which they may be applied). The maximum measurable level shown is a typical value; the actual measurable maximum level is within  $\pm 2\%$  of that shown.

The Specified input signal range is that of continuously applied signal levels for which measurements are guaranteed to be within the specified accuracies. The RMS level is also the maximum rated working signal level for safety purposes.

Accuracy specifications are guaranteed maximum errors. You should round the total maximum error upwards to the next integer count of resolution (e.g. if the total error is 18.3mV and the data is read with 1mV resolution then use 19mV as the maximum error).

All percentages are % of reading unless otherwise described.

When a signal has multiple significant frequency components (e.g. significant DC and AC components), add the relevant specifications for each such component.

$V_{DC}$ ,  $A_{DC}$ ,  $V_{AC}$ ,  $A_{AC}$ ,  $V_{AC+DC}$ ,  $A_{AC+DC}$ ,  $V_{RDG}$ ,  $A_{RDG}$  etc. indicate the relevant voltage, current etc. reading.

H is the harmonic or spectrum point number.

N is the configured number of harmonics or spectrum points.

F or  $F_{FUND}$  is the frequency of the signal in kHz.

$F_{BW}$  is the frequency of the user bandwidth setting in kHz.

### 28.1 INPUT ISOLATION SPECIFICATIONS

Valid for any V terminal to PA900 chassis ground; any A terminal to PA900 chassis ground; and between any V and any A terminal.

Impedance  $>1G\Omega \parallel <30pF$

Max. Voltage 4500V<sub>PK</sub> max without damage  
 2500V<sub>RMS</sub> max for <1s without damage  
 1000V<sub>RMS</sub> max continuous rated working voltage (CAT I/II)  
 600V<sub>RMS</sub> max continuous rated working voltage (CAT III)  
 300V<sub>RMS</sub> max continuous rated working voltage (CAT IV)

### 28.2 VOLTAGE MEASUREMENT SPECIFICATIONS

The specifications for voltage are independent of the current input option installed in the respective channel.

#### 28.2.1 VOLTAGE INPUT CAPABILITY AND CHARACTERISTICS

Specification	S Channel Type	A Channel Type	L Channel Type	W Channel Type
No Damage Voltage Range	<1ms	<3000V <sub>RMS</sub> and V <sub>PK</sub>	<500V <sub>RMS</sub> and 3000V <sub>PK</sub>	<3000V <sub>RMS</sub> and V <sub>PK</sub>
	<100ms	<2000V <sub>RMS</sub>	<300V <sub>RMS</sub>	<1500V <sub>RMS</sub>
	<5s	<1500V <sub>RMS</sub>	<250V <sub>RMS</sub>	<1000V <sub>RMS</sub>
	Continuous	<1000V <sub>RMS</sub>	<160V <sub>RMS</sub>	<650V <sub>RMS</sub>
PA900 Unpowered	As above			
Measurable Voltage Range	<1803V <sub>RMS</sub> and V <sub>PK</sub>	<182.3V <sub>RMS</sub> and V <sub>PK</sub>	<1803V <sub>RMS</sub> and V <sub>PK</sub>	<1803V <sub>RMS</sub> and V <sub>PK</sub>
Specified Voltage Range	<1000V <sub>RMS</sub> and <1750V <sub>PK</sub>	<160V <sub>RMS</sub> and <175V <sub>PK</sub>	<650V <sub>RMS</sub> and <1750V <sub>PK</sub>	<650V <sub>RMS</sub> and <1750V <sub>PK</sub>
Impedance Burden	1.201M $\Omega$ $\pm$ 0.25%	121k $\Omega$ $\pm$ 0.25%	399.5k $\Omega$ $\pm$ 0.25%	399.5k $\Omega$ $\pm$ 0.25%
3dB Bandwidth (typical)	900kHz		3MHz	

## 28.2.2 VOLTAGE MEASUREMENT ACCURACY

The charts below show guaranteed maximum voltage errors for DC, MAINS, AVIONICS, and 50kHz throughout a 1V to 1000V range of applied voltages expressed as % of reading and are valid within  $\pm 5C$  of the calibration temperature (add 0.005% per C beyond this) and where no significant common-mode is present. Following the charts is a table which can be used to calculate the guaranteed accuracies for applications other than shown in the charts and also for the computation of numerical errors.

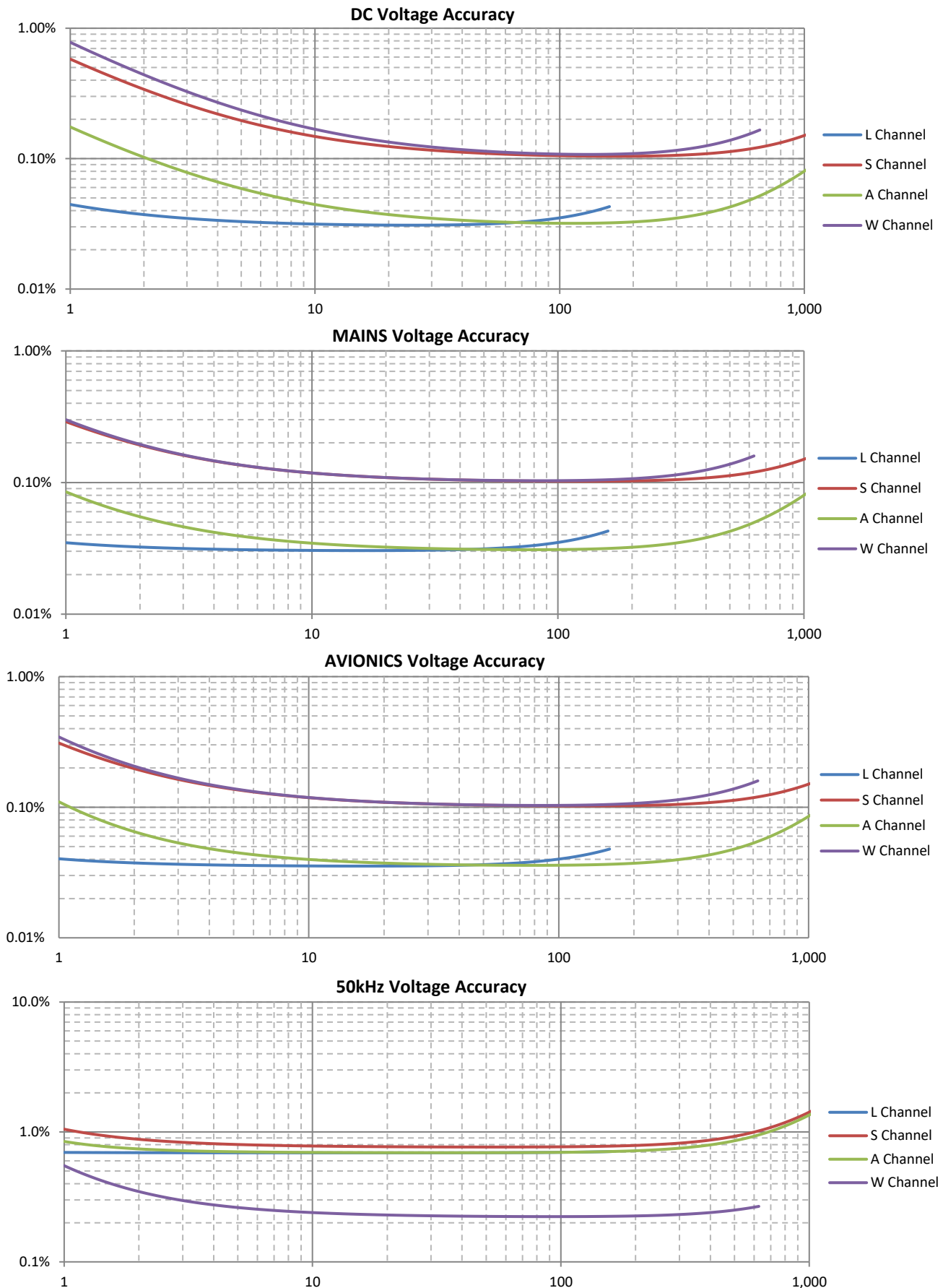

### 28.2.2.1 PRIMARY VOLTAGE MEASUREMENT ACCURACY TABLE

Add relevant errors from the table below for the maximum error in primary voltage measurements (e.g. DC, AC, AC+DC, Rectified, Peak, Valley, Peak-Valley).

MAXIMUM SCALING ERRORS					
Apply to all results as shown below as a percentage of the reading If signal contains significant levels at multiple frequencies, apply to each level & frequency					
Specification	S Channel Type	A Channel Type	L Channel Type	W Channel Type	
<b>Base Scaling Error</b> Apply to all results	0.1%	0.03%		0.1% (0.2% if 2ms LF/PERIOD)	
<b>Frequency Dependent Scaling Error</b> Apply to all results other than DC or MAINS	AVIONICS	None	0.005%	None	
	LF or VLF	0.01%		0.05%	
	<10kHz	F*0.005%		F*0.002%	
	10k-40kHz	0.05%+(F-10)*0.012%			
	40k-100kHz	0.41%+(F-40)*0.025%		0.08%+(F-40)*0.004%	
	100k-1MHz	Typically (F/1000) <sup>2</sup> *100%		0.32%+(F-100)*0.013%	
	>1MHz	Not specified		Typically (F/3500) <sup>2</sup> *100%	
<b>Self-Heating Scaling Error</b> Apply to all results (only significant at higher voltages) 1 minute nominal time constant	0.05%*(V <sub>AC+DC</sub> /1000) <sup>2</sup>		0.5%*(V <sub>AC+DC</sub> /1000) <sup>2</sup>	0.15%*(V <sub>AC+DC</sub> /1000) <sup>2</sup>	
<b>Temperature Scaling Error</b> Apply to all results if outside of ±5C from calibration temperature	0.005% per C outside of ±5C from calibration temperature				
<b>Bandwidth Limit Scaling Error</b> Apply if using USER bandwidth setting	10%*(F/F <sub>BW</sub> ) <sup>2</sup> , unspecified for F > 0.3*F <sub>BW</sub>				
MAXIMUM FLOOR ERRORS					
Apply to all results as shown below in Volts (generally only significant at low input levels)					
Specification	S Channel Type	A Channel Type	L Channel Type	W Channel Type	
<b>Base Floor Error</b> Apply to all results	1.8mV	450µV	45µV	1.8mV	
<b>DC Floor Error</b> Apply to DC and RECTIFIED results Apply to AC+DC results after multiplying by V <sub>DC</sub> /V <sub>AC+DC</sub>	3mV	1mV	100µV	5mV	
<b>AC Floor Error</b> Apply to AC, AC+DC, and RECTIFIED results	MAINS, LF, VLF & F <sub>BW</sub> ≤10kHz	100µV/V <sub>RDG</sub>	100µV/V <sub>RDG</sub>	4µV/V <sub>RDG</sub>	200µV/V <sub>RDG</sub>
	AVIONICS & F <sub>BW</sub> ≤50kHz	300µV/V <sub>RDG</sub>	300µV/V <sub>RDG</sub>	8µV/V <sub>RDG</sub>	650µV/V <sub>RDG</sub>
	Otherwise	1.1mV/V <sub>RDG</sub>	1.1mV/V <sub>RDG</sub>	11µV/V <sub>RDG</sub>	1.5mV/V <sub>RDG</sub>
<b>Peak Floor Error</b> Apply to PK, VLY and PK-VLY results	MAINS, LF, VLF & F <sub>BW</sub> ≤10kHz	40mV	40mV	8mV	60mV
	AVIONICS & F <sub>BW</sub> ≤50kHz	75mV	75mV	11mV	125mV
	Otherwise	125mV	125mV	17mV	175mV
<b>Common Mode Error</b> Apply to AC, AC+DC, and RECTIFIED results Apply using voltage on V LO terminal relative to chassis ground. Error has 90° phase shift to common-mode voltage	1µV per V.Hz (11.5mV@230V/50Hz)		100nV per V.Hz (1.15mV@230V/50Hz)	700nV per V.Hz (8.05mV@230V/50Hz)	
<b>Adjacent Channel Error</b> Apply to AC, AC+DC, and RECTIFIED results Apply using adjacent channel A LO or V LO terminal voltage relative to chassis ground. Error has 90° phase shift to adjacent channel voltage	300nV per V.Hz (3.45mV@230V/50Hz)		30nV per V.Hz (345µV@230V/50Hz)	210nV per V.Hz (2.415mV@230V/50Hz)	

### 28.2.2.2 SECONDARY VOLTAGE MEASUREMENT ACCURACY TABLE

Specification	S Channel Type	A Channel Type	L Channel Type	W Channel Type	
<b>Crest Factor Error</b>	(Total Floor Error from preceding table for PK results) / V <sub>AC</sub>				
<b>Form Factor Error</b>	(Total Floor Error from preceding table for AC+DC results) / V <sub>RECTIFIED</sub>				
<b>Inter-Channel Error</b> For 120° between equal amplitudes	(Relevant Voltage Errors from preceding table at the inter-channel voltage) + 0.0015%*F				
<b>Harmonic or Spectrum Error</b>	AC Voltage Errors from preceding table at V and F of the harmonic or spectrum point + (H/N) <sup>2</sup> *0.3% of reading + (if not fundamental) from below using the frequency of the harmonic or spectrum point				
	<10kHz	0.01% of V <sub>AC+DC</sub>	0.006% of V <sub>AC+DC</sub>	0.015% of V <sub>AC+DC</sub>	
	10k-115kHz	0.05% of V <sub>AC+DC</sub>		0.03% of V <sub>AC+DC</sub>	
	115k-435kHz	Not Available		0.08% of V <sub>AC+DC</sub>	
<b>Inter-Channel Fundamental Phase Error</b>	0.02°+0.15°*F			0.01°+0.07°*F	
<b>Harmonic-Fundamental Phase Error (typical, BANDWIDTH configured as UNFILTERED)</b>	0.02°+0.1°*F+0.001°*H			0.02°+0.03°*F+0.001°*H	
<b>%THD Error</b> Errors shown are all expressed in %THD units	(0.005+0.000025*N)*%THD+0.00005*N*√N + from below using the frequency of highest included harmonic				
	<10kHz	0.025+1.25/V <sub>AC</sub>	0.015+1/V <sub>AC</sub>	0.015+0.2/V <sub>AC</sub>	0.03+1.5/V <sub>AC</sub>
	10k-115kHz	0.15+3.5/V <sub>AC</sub>		0.15+0.35/V <sub>AC</sub>	0.06+4/V <sub>AC</sub>
	115k-435kHz	Not Available		0.15+4/V <sub>AC</sub>	

### 28.2.2.3 EXAMPLES

#### Example 1

For an A type channel the maximum error of a measurement of the AC+DC voltage of a 230Vrms signal at 50Hz is a worst case of ±0.034% of reading as calculated by:

Scaling Errors:

- Base Scaling = ±0.03%
- Frequency Dependent Scaling = None at MAINS
- Self-heating Scaling = ±0.05%\*(230V/1000)<sup>2</sup> = ±0.002645%
- Temperature Scaling = none within 5C of the calibration temperature
- Bandwidth Limit Scaling = none when using AUTO-TRACK

Total Scaling errors =  $\pm 0.032645\%$  of reading

**Floor Errors:**

- Base Floor =  $450\mu\text{V}$
- DC Floor =  $(0\text{V}/230\text{V}) * 1\text{mV} = 0$
- AC floor =  $(100\mu\text{V}/230\text{V})$  at MAINS =  $0.43\mu\text{V}$  (can be ignored)
- Common-Mode = if not 3 $\phi$ 3w(2ch) wiring = none
- Common-Mode = if 3 $\phi$ 3w(2ch) wiring =  $1\mu\text{V} * (230\text{V}/\sqrt{3}) * 50\text{Hz} = 6.6\text{mV}$  at  $(30+90)^\circ = \pm 3.3\text{mV}$
- Total Floor Errors =  $\pm 0.45\text{mV}$  or  $\pm 3.75\text{mV} = 0.0002\%$  or  $0.0016\%$  of reading

**Example 2**

For an A type channel the maximum error of a measurement of the fundamental of a 230Vrms voltage at 50Hz when 50 harmonics are configured is a worst case of  $\pm 0.035\%$  of reading as calculated by:

**Scaling Errors:**

- Base Scaling =  $\pm 0.03\%$
- Frequency Dependent Scaling = None at MAINS
- Self-heating Scaling =  $\pm 0.05\% * (230\text{V}/1000)^2 = \pm 0.002645\%$
- Temperature Scaling = none within 5C of the calibration temperature
- Bandwidth Limit Scaling = none when using AUTO-TRACK
- Total Scaling errors =  $\pm 0.032645\%$  of reading

**Floor Errors:**

- Base Floor =  $450\mu\text{V}$
- AC floor =  $(100\mu\text{V}/230\text{V})$  at MAINS =  $0.43\mu\text{V}$  (can be ignored)
- Common-Mode = if not 3 $\phi$ 3w(2ch) wiring = none
- Common-Mode = if 3 $\phi$ 3w(2ch) wiring =  $1\mu\text{V} * (230\text{V}/\sqrt{3}) * 50\text{Hz} = 6.6\text{mV}$  at  $(30+90)^\circ = \pm 3.3\text{mV}$
- Total Floor Errors =  $\pm 0.45\text{mV}$  or  $\pm 3.75\text{mV} = 0.0002\%$  or  $0.0016\%$  of reading

**Harmonic Amplitude Errors:**

- $(H/N)^2 * 0.3\%$  of reading =  $(1/50) * 0.03\% = \pm 0.0006\%$
- Is fundamental, so no further harmonic amplitude error
- Total Harmonic Amplitude Errors =  $\pm 0.0006\%$  of reading

**Example 3**

For an A type channel the maximum error of a measurement of a 10%THD of a 230Vrms voltage at 50Hz when 50 harmonics are configured is a worst case of  $\pm 0.10\%$  as calculated by:

$$(0.005 + 0.000025 * N) * \% \text{THD} = (0.005 + (0.000025 * 50)) * 10 = 0.0625\% \text{THD}$$

$$0.00005 * N * \sqrt{N} = 0.00005 * 50 * \sqrt{50} = 0.0177\% \text{THD}$$

$$0.015 + 1/V_{AC} = 0.015 + 1/230 = 0.0193\% \text{THD}$$

**Example 4**

For an A type channel the maximum error of the inter-channel voltage fundamental phase at 50Hz is a worst case of  $0.02^\circ + 0.15^\circ * 0.05 = \pm 0.021^\circ$

**Example 5**

For an A type channel the maximum error of the crest factor of a 230V/50Hz voltage is a worst case of  $50\text{mV}/230\text{V} = 0$  to  $+0.00022$  (i.e. biased to a higher reading)

## 28.3 CURRENT MEASUREMENT SPECIFICATIONS

### 28.3.1 CURRENT INPUT CAPABILITY AND CHARACTERISTICS

Specification	Channel Type	Option H	Option D HI Range or Auto-Range when on HI Range	Option D LO Range or Auto-Range when on LO Range	Option X/V HI Range	Option X/V LO Range
<b>No Damage Current Range</b>	<8ms	All	<200A <sub>RMS</sub> and <300A <sub>PK</sub>	<150A <sub>RMS</sub> and <250A <sub>PK</sub>	<60A <sub>RMS</sub> and <150A <sub>PK</sub>	<200V <sub>RMS</sub> and <300V <sub>PK</sub>
	<40ms	All	<75A <sub>RMS</sub>	<50A <sub>RMS</sub>	<40A <sub>RMS</sub>	<50V <sub>RMS</sub> and <10V <sub>RMS</sub>
	<1s	All	<50A <sub>RMS</sub>	<30A <sub>RMS</sub>	<5A <sub>RMS</sub>	<30V <sub>RMS</sub> and <5V <sub>RMS</sub>
	Continuous	All	<30A <sub>RMS</sub>	<20A <sub>RMS</sub>	<2A <sub>RMS</sub>	<25V <sub>RMS</sub> and V <sub>PK</sub> and <5V <sub>RMS</sub> and V <sub>PK</sub>
	PA900 Unpowered	All	As Above	<2A <sub>RMS</sub> and <150A <sub>PK</sub>	<25V <sub>RMS</sub> and <300V <sub>PK</sub>	<25V <sub>RMS</sub> and <300V <sub>PK</sub>
<b>Measurable Current Range</b>	All	<225A <sub>RMS</sub> and A <sub>PK</sub>	<150A <sub>RMS</sub> and A <sub>PK</sub>	<1.02A <sub>RMS</sub> and A <sub>PK</sub>	<23.1V <sub>RMS</sub> and V <sub>PK</sub>	<0.576V <sub>RMS</sub> and V <sub>PK</sub>
<b>Specified Current Range</b>	All	<30A <sub>RMS</sub> and <200A <sub>PK</sub>	<20A <sub>RMS</sub> and <140A <sub>PK</sub>	<1A <sub>RMS</sub> and A <sub>PK</sub>	<15V <sub>RMS</sub> and <20V <sub>PK</sub>	<0.55V <sub>RMS</sub> and V <sub>PK</sub>
<b>Impedance Burden</b>	All	2.5m $\Omega$ to 7m $\Omega$	4m $\Omega$ to 12m $\Omega$	0.562 $\Omega$ $\pm$ 0.75%	20.5k $\Omega$ $\pm$ 0.25% (X) 205k $\Omega$ $\pm$ 0.25% (V)	10.25k $\Omega$ $\pm$ 0.25% (X) 102.5k $\Omega$ $\pm$ 0.25% (V)
<b>3dB Bandwidth (typical)</b>	S, A or L	1.25MHz (500kHz for option V)				
	W	5MHz			3MHz (X) 1MHz (V)	

## 28.3.2 CURRENT MEASUREMENT ACCURACY

The charts below show guaranteed maximum current errors for DC, MAINS, AVIONICS, and 50kHz throughout a 100µA to 30A range of applied currents expressed as % of reading and are valid within  $\pm 5\text{C}$  of the calibration temperature (add 0.005% per C beyond this) and where no significant common-mode is present. Following the charts is a table which can be used to calculate the guaranteed accuracies for applications other than shown in the charts and also for the computation of numerical errors.

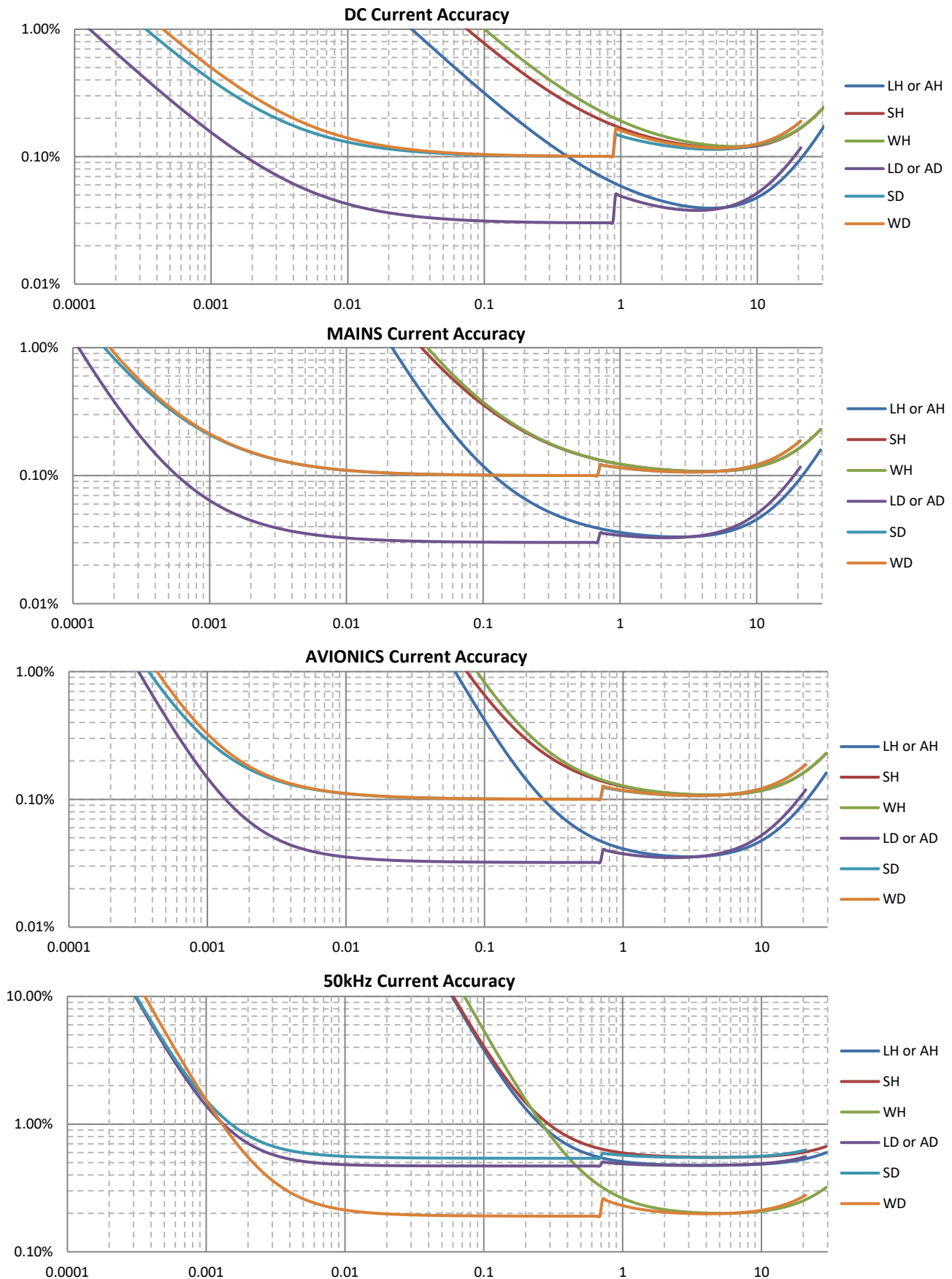



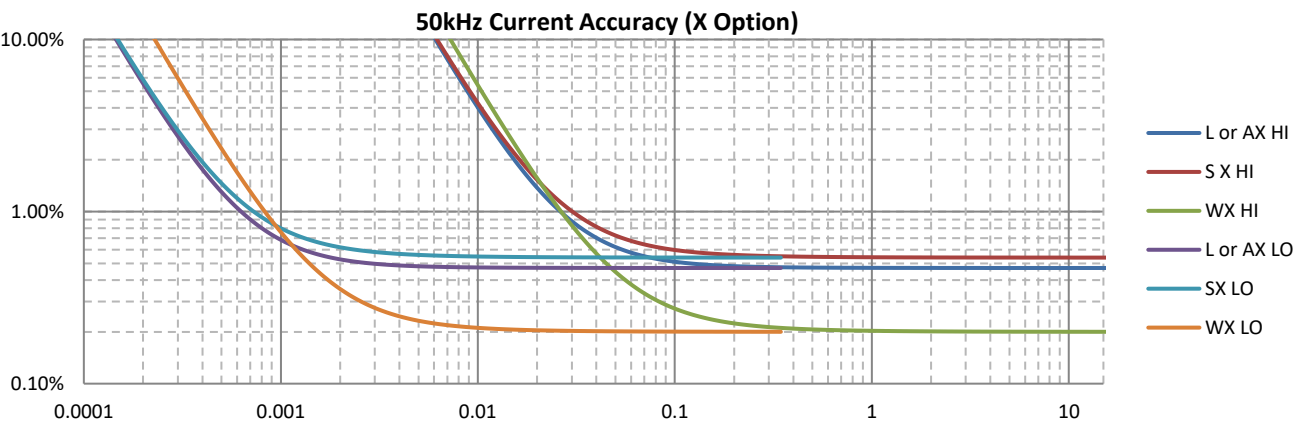
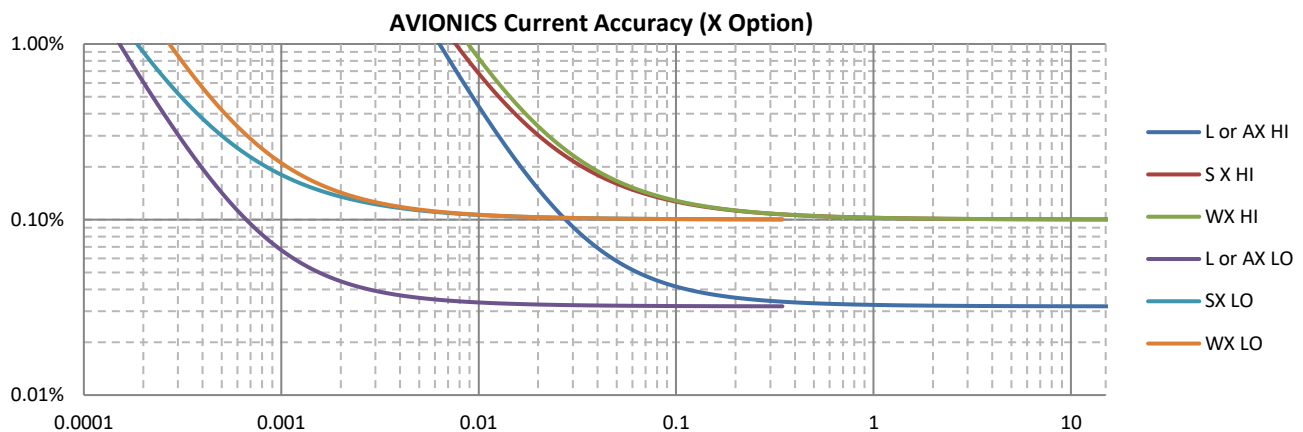
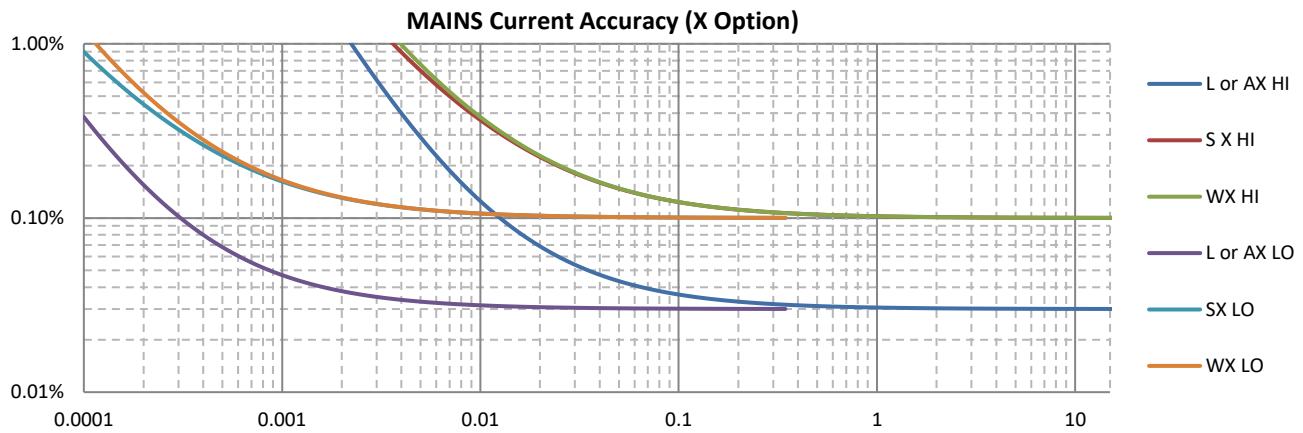
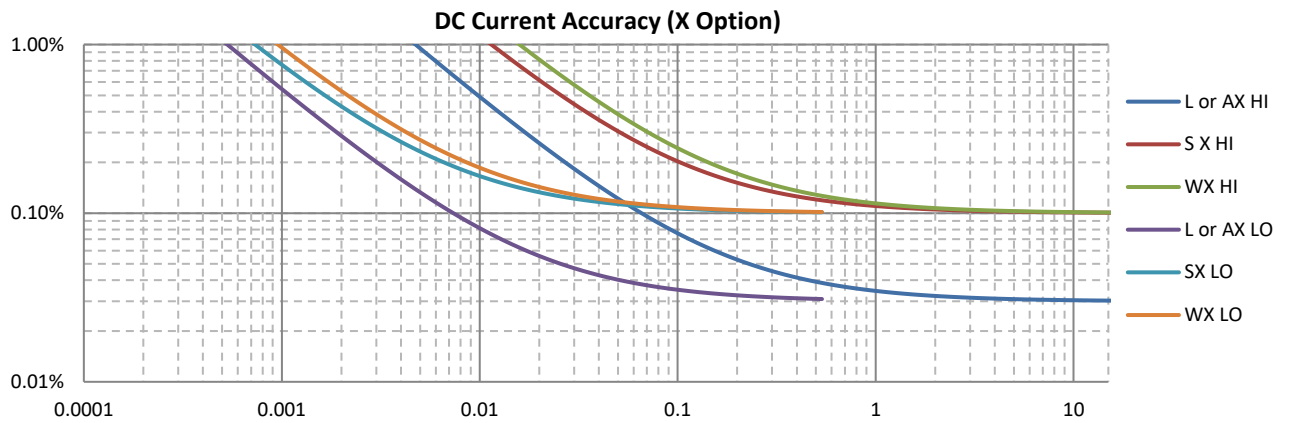

**28.3.2.1 PRIMARY CURRENT MEASUREMENT ACCURACY TABLE**

Add relevant errors from the table below for the maximum error in primary current measurements (e.g. DC, AC, AC+DC, Rectified, Peak, Valley, Peak-Valley).

MAXIMUM SCALING ERRORS							
Apply to all results as shown below as a percentage of the reading							
If signal contains significant levels at multiple frequencies, apply to each level & frequency							
Specification	Channel Type	Option H	Option D HI Range	Option D LO Range	Option X/V HI Range	Option X/V LO Range	
<b>Base Scaling Error</b>	A or L	0.03%					
Apply to all results	S or W	0.1% (0.2% if 2ms LF/PERIOD)					
<b>Frequency Dependent Scaling Error</b> Apply to all results other than DC or MAINS	LF or VLF	S, A or L	0.01%				
		W	0.05%				
	AVIONICS	A or L	0.002%				
		S or W	None				
	<10kHz	S, A or L	F*0.003%				
		W	F*0.0015%				
	10k-40kHz	S, A or L	0.03%+(F-10)*0.007%				
		W	F*0.0015%				
	40k-100kHz	S, A or L	0.24%+(F-40)*0.02% other than option V 0.24%+(F-40)*0.04% for option V				
		W	0.06%+(F-40)*0.003%	0.06%+(F-40)*0.004% option X		0.06%+(F-40)*0.007% option V	
100k-1MHz	S, A or L	Typically (F/1250) <sup>2</sup> *100% (not valid for option V)					
	W	0.24%+(F-100)*0.012%		0.3%+(F-100)*0.015% option X only			
>1MHz	W	Typically (F/5000) <sup>2</sup> *100%		Typically (F/3000) <sup>2</sup> *100% option X only			
<b>Self-Heating Scaling Error</b> Apply to all results (only significant at higher currents) 3 minute nominal time constant	All	0.00015%*A <sub>AC+DC</sub> <sup>2</sup>	0.0002%*A <sub>AC+DC</sub> <sup>2</sup>	None			
<b>Temperature Scaling Error</b> Apply to all results if outside of ±5C from calibration temperature	All	0.005% per C outside of ±5C from calibration temperature					
<b>Bandwidth Limit Scaling Error</b> Apply if using USER bandwidth setting	All	10%*(F/F <sub>BW</sub> ) <sup>2</sup> , unspecified above 0.3*F <sub>BW</sub>					
MAXIMUM FLOOR ERRORS							
Apply to all results as shown below in Amps (generally only significant at low input levels)							
Specification	Channel Type	Option H	Option D HI Range	Option D LO Range	Option X/V HI Range	Option X/V LO Range	
<b>Base Floor Error</b>	A or L	56µA	38µA	250nA	6µV	150nV	
Apply to all results	S or W	225µA	150µA	1µA	23µV	600nV	
<b>DC Floor Error</b> Apply to DC and RECTIFIED results Apply to AC+DC results after multiplying by A <sub>DC</sub> /A <sub>AC+DC</sub>	A or L	0.23mA	0.15mA	1µA	40µV (X) 60µV (V)	5µV (X) 8µV (V)	
	S	0.45mA	0.3mA	2µA	80µV (X) 120µV (V)	6µV (X) 10µV (V)	
	W	0.68mA	0.45mA	3µA	120µV (X) 180µV (V)	8µV (X) 12µV (V)	
<b>AC Floor Error</b> Apply to AC, AC+DC, and RECTIFIED results	MAINS, LF, VLF & F <sub>BW</sub> ≤10kHz	S, A or L	3.3µA/AR <sub>DC</sub>	1.5µA/AR <sub>DC</sub>	90pA/AR <sub>DC</sub>	35nV/AR <sub>DC</sub>	20pV/AR <sub>DC</sub>
		W	5µA/AR <sub>DC</sub>	2.5µA/AR <sub>DC</sub>	125pA/AR <sub>DC</sub>	50nV/AR <sub>DC</sub> (X) 100nV/AR <sub>DC</sub> (V)	50pV/AR <sub>DC</sub> (X) 100pV/AR <sub>DC</sub> (V)
	AVIONICS & F <sub>BW</sub> ≤50kHz	S, A or L	33µA/AR <sub>DC</sub>	15µA/AR <sub>DC</sub>	0.9nA/AR <sub>DC</sub>	350nV/AR <sub>DC</sub>	200pV/AR <sub>DC</sub>
		W	50µA/AR <sub>DC</sub>	25µA/AR <sub>DC</sub>	1.25nA/AR <sub>DC</sub>	500nV/AR <sub>DC</sub> (X) 1µV/AR <sub>DC</sub> (V)	500pV/AR <sub>DC</sub> (X) 1nV/AR <sub>DC</sub> (V)
	Otherwise	S, A or L	330µA/AR <sub>DC</sub>	150µA/AR <sub>DC</sub>	9nA/AR <sub>DC</sub>	3.5µV/AR <sub>DC</sub>	2nV/AR <sub>DC</sub>
		W	500µA/AR <sub>DC</sub>	250µA/AR <sub>DC</sub>	12.5nA/AR <sub>DC</sub>	5µV/AR <sub>DC</sub> (X) 10µV/AR <sub>DC</sub> (V)	5nV/AR <sub>DC</sub> (X) 10nV/AR <sub>DC</sub> (V)
<b>Peak Floor Error</b> Apply to PK, VLY and PK-VLY results	MAINS, LF, VLF & F <sub>BW</sub> ≤10kHz	S, A or L	8mA	5mA	40µA	0.75mV	25µV
		W	10mA	6.5mA	50µA	0.9mV (X) 2mV (V)	30µV (X) 70µV (V)
	AVIONICS & F <sub>BW</sub> ≤50kHz	S, A or L	25mA	17mA	125µA	2.5mV	65µV
		W	30mA	20mA	150µA	3mV (X) 7mV (V)	80µV (X) 180µV (X)
	Otherwise	S, A or L	75mA	50mA	400µA	7.5mV	200µV
		W	90mA	60mA	500µA	10mV (X) 25mV (V)	250µV (X) 600µV (V)
<b>Common Mode Error</b> Apply to all results Apply using voltage on A LO terminal relative to chassis ground. Error has 90° phase shift to common-mode voltage	All	500pA per V.Hz (5.75µA@230V/50Hz)	400pA per V.Hz (4.6µA@230V/50Hz)	20pA per V.Hz (0.23µA@230V/50Hz)	15nV per V.Hz (0.172mV@230V/50Hz) (multiply by 3 for option V)	0.5nV per V.Hz (5.75µV@230V/50Hz) (multiply by 3 for option V)	
<b>Adjacent Channel Error</b> Apply to all results Apply using adjacent channel A LO or V LO terminal voltage relative to chassis ground. Error has 90° phase shift to adjacent channel voltage	All	150pA per V.Hz (1.725µA@230V/50Hz)	120pA per V.Hz (1.38µA@230V/50Hz)	7pA per V.Hz (80.5nA@230V/50Hz)	7nV per V.Hz (80.5µV@230V/50Hz) (multiply by 3 for option V)	0.2nV per V.Hz (2.3µV@230V/50Hz) (multiply by 3 for option V)	

### 28.3.2.2 SECONDARY CURRENT MEASUREMENT ACCURACY TABLE

Specification	Channel Type	Option H	Option D HI Range	Option D LO Range	Option X/V HI Range	Option X/V LO Range	
<b>Crest Factor Error</b>	All	(Total Current Floor Error from preceding table for PK results) / $A_{AC}$					
<b>Form Factor Error</b>	All	(Total Current Floor Error from preceding table for AC+DC results) / $A_{RECTIFIED}$					
<b>Multi-Channel Error</b> For similar current level and phase in each phase.	$A_N$ (2 $\phi$ 3w)	All	Relevant Current Errors from preceding table for $A_{\theta A}$ + Relevant Current Errors from preceding table for $A_{\theta B}$ + 0.0005% of $(A_{\theta A} + A_{\theta B}) * F$				
	$A_{\theta C}$ (3 $\phi$ 3w 2ch)	All	Relevant Current Errors from preceding table for $A_{\theta A}$ + Relevant Current Errors from preceding table for $A_{\theta B}$ + 0.0015% of $(A_{\theta A} + A_{\theta B}) * F$				
	$A_N$ (3 $\phi$ 4w)	All	Relevant Current Errors from preceding table for $A_{\theta A}$ + Relevant Current Errors from preceding table for $A_{\theta B}$ + Relevant Current Errors from preceding table for $A_{\theta C}$ + 0.0015% of $(A_{\theta A} + A_{\theta B} + A_{\theta C}) * F$				
<b>Harmonic or Spectrum Error</b>		All	AC Current Errors from preceding table at A and F of the harmonic or spectrum point + $(H/N)^2 * 0.3\%$ of reading + (if not fundamental) from below using the frequency of the harmonic or spectrum point				
	<10kHz	A or L	0.006% of $A_{AC+DC}$				
	10k-115kHz		0.05% of $A_{AC+DC}$				
	<10kHz	S	0.01% of $A_{AC+DC}$				
	10k-115kHz		0.05% of $A_{AC+DC}$				
	<10kHz	W	0.015% of $A_{AC+DC}$				
10k-115kHz	0.03% of $A_{AC+DC}$						
115k-435kHz		0.08% of $A_{AC+DC}$					
<b>Current-Voltage Fundamental Phase Error</b>	S, A or L	$0.005^\circ + 0.015 * F$					
	W	$0.005^\circ + 0.007 * F$					
<b>Harmonic-Fundamental Phase Error (typical, BANDWIDTH configured as UNFILTERED)</b>	S, A or L	$0.02^\circ + 0.1 * F + 0.001 * H$					
	W	$0.02^\circ + 0.03 * F + 0.001 * H$					
<b>%THD Error</b> Errors shown are all expressed in %THD units.		All	$(0.005 + 0.000025 * N) * \%THD + 0.00005 * N * \sqrt{N}$ + from below using the frequency of highest included harmonic				
	<10kHz	A or L	$0.015 + 0.2 / A_{AC}$	$0.015 + 0.15 / A_{AC}$	$0.015 + 0.001 / A_{AC}$	$0.015 + 0.025 / A_{AC}$	$0.015 + 0.0006 / A_{AC}$
	10k-115kHz		$0.15 + 2 / A_{AC}$	$0.15 + 1.5 / A_{AC}$	$0.15 + 0.01 / A_{AC}$	$0.15 + 0.25 / A_{AC}$	$0.15 + 0.006 / A_{AC}$
	<10kHz	S	$0.025 + 0.2 / A_{AC}$	$0.025 + 0.15 / A_{AC}$	$0.025 + 0.001 / A_{AC}$	$0.025 + 0.025 / A_{AC}$	$0.025 + 0.0006 / A_{AC}$
	10k-115kHz		$0.15 + 2 / A_{AC}$	$0.15 + 1.5 / A_{AC}$	$0.15 + 0.01 / A_{AC}$	$0.15 + 0.25 / A_{AC}$	$0.15 + 0.006 / A_{AC}$
	<10kHz	W	$0.03 + 0.25 / A_{AC}$	$0.03 + 0.18 / A_{AC}$	$0.03 + 0.0012 / A_{AC}$	$0.03 + 0.03 / A_{AC}$	$0.03 + 0.001 / A_{AC}$
10k-115kHz	$0.06 + 2.5 / A_{AC}$		$0.06 + 1.8 / A_{AC}$	$0.06 + 0.012 / A_{AC}$	$0.06 + 0.3 / A_{AC}$	$0.06 + 0.01 / A_{AC}$	
115k-435kHz		$0.15 + 2.5 / A_{AC}$	$0.15 + 1.8 / A_{AC}$	$0.15 + 0.012 / A_{AC}$	$0.15 + 0.3 / A_{AC}$	$0.15 + 0.01 / A_{AC}$	

### 28.3.2.3 EXAMPLES

#### Example 1

For an AD channel (HI range) the maximum error of a measurement of the AC+DC current of a 5Arms signal at 50Hz is a worst case of  $\pm 0.037\%$  of reading as calculated by:

Scaling Errors:

- Base Scaling =  $\pm 0.03\%$
- Frequency Dependent Scaling = None at MAINS
- Self-heating Scaling =  $\pm 0.0002\% * 5^2 = \pm 0.005\%$
- Temperature Scaling = none within 5C of the calibration temperature
- Bandwidth Limit Scaling = none when using AUTO-TRACK
- Total Scaling errors =  $\pm 0.035\%$  of reading

Floor Errors:

- AC+DC floor =  $\pm 110\mu A \pm (1.5\mu A / 5A)$  at MAINS =  $\pm 110.3\mu A$
- Common-Mode = assume connected to 230V mains =  $4.6\mu A$  at  $90^\circ$  to voltage (so 0 to  $\pm 4.6\mu A$  depending on current phase)
- Total Floor Errors =  $\pm 0.1149mA = 0.0023\%$  of reading

#### Example 2

For an AD channel (HI range) the maximum error of a measurement of the fundamental current of a 5Arms signal at 50Hz when 50 harmonics are configured is a worst case of  $\pm 0.038\%$  of reading as calculated by:

Scaling Errors:

- Base Scaling =  $\pm 0.03\%$
- Frequency Dependent Scaling = None at MAINS
- Self-heating Scaling =  $\pm 0.0002\% * 5^2 = \pm 0.005\%$
- Temperature Scaling = none within 5C of the calibration temperature
- Bandwidth Limit Scaling = none when using AUTO-TRACK
- Total Scaling errors =  $\pm 0.035\%$  of reading

Floor Errors:

- AC floor =  $\pm 37\mu A \pm (1.5\mu A / 5A)$  at MAINS =  $\pm 37.3\mu A$
- Common-Mode = assume connected to 230V mains =  $4.6\mu A$  at  $90^\circ$  to voltage (so 0 to  $\pm 4.6\mu A$  depending on current phase)
- Total Floor Errors =  $\pm 0.1149mA = 0.0023\%$  of reading

Harmonic Amplitude Errors:

- $(H/N)^2 * 0.3\%$  of reading =  $(1/50) * 0.03\% = \pm 0.0006\%$
- Is fundamental, so no further harmonic amplitude error

Total Harmonic Amplitude Errors =  $\pm 0.0006\%$  of reading

**Example 3**

For an AD type channel the maximum error of a measurement of a 10%THD of a 5Arms current at 50Hz when 50 harmonics are configured is a worst case of  $\pm 0.13\%$  as calculated by:

$$(0.005 + 0.000025 * N) * \%THD = (0.005 + (0.000025 * 50)) * 10 = 0.0625\%THD$$

$$0.00005 * N * \sqrt{N} = 0.00005 * 50 * \sqrt{50} = 0.0177\%THD$$

$$0.015 + 0.15 / A_{AC} = 0.015 + 0.15 / 5 = 0.045\%THD$$

**Example 4**

For an A type channel the maximum error of the current:voltage fundamental phase at 50Hz is a worst case of  $0.005^\circ + 0.015^\circ * 0.05 = \pm 0.006^\circ$

**Example 5**

For an AD type channel the maximum error of the crest factor of a 5A/50Hz voltage is a worst case of  $5mA / 5A = 0$  to  $+0.001$  (i.e. biased to a higher reading)

**28.4 WATTS, VAR AND VA MEASUREMENT SPECIFICATIONS**

The charts below show guaranteed maximum Watts errors for DC, MAINS, AVIONICS, and 50kHz from  $100\mu W$  up to the highest available using a D option current measurement (H and X option current accuracies are similar within their respective range of currents and are not shown for clarity), expressed as % of Watts reading and are valid within  $\pm 5C$  of the calibration temperature (add 0.005% per C beyond this) and where no significant common-mode is present. Following the charts is a table which can be used to calculate the guaranteed accuracies for applications other than shown in the charts and also for the computation of numerical errors.

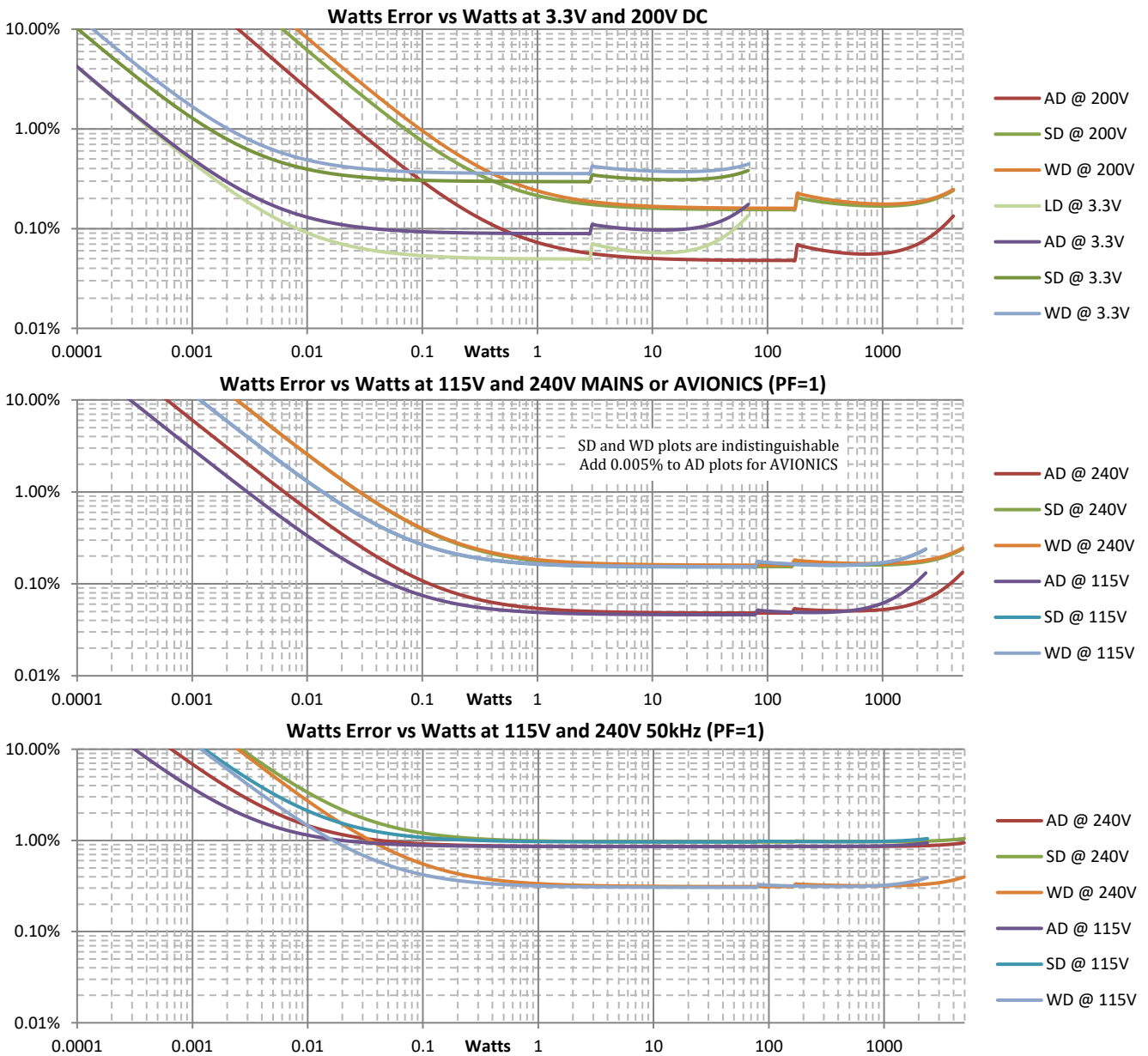

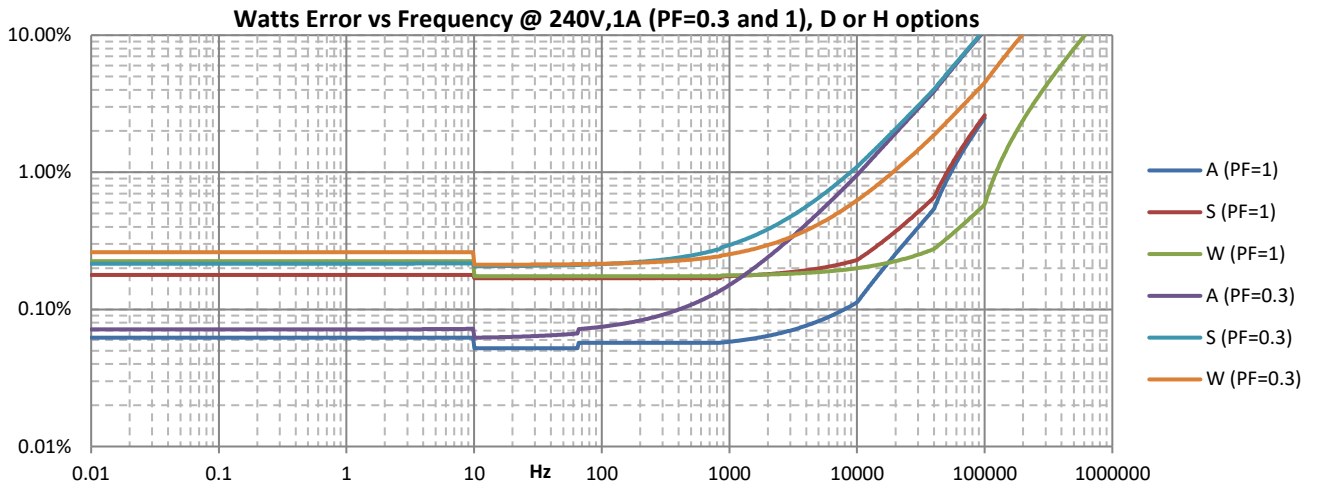

## 28.4.1 WATTS, VAR AND VA MEASUREMENT SPECIFICATIONS

### 28.4.1.1 PRIMARY WATTS, VAR AND VA MEASUREMENT ACCURACY TABLE

Add relevant errors from the table below for the maximum error in all Watts, VA and VAR measurements except harmonic Watts. Note that by definition DC Watts and DC VA are identical, and DC VAR is zero.

MAXIMUM SCALING ERRORS						
Apply to all results as shown below as a percentage of the reading						
If signal contains significant levels at multiple frequencies, apply to each level & frequency						
Specification	Channel Type	Option H	Option D HI Range	Option D LO Range	Option X/V HI Range	Option X/V LO Range
<b>Base Scaling Error</b> Apply to all results	A or L	0.045%				
	S or W	0.15% (0.3% if 2ms LF/PERIOD)				
<b>Frequency Dependent Scaling Error</b> Apply to AC component of all results other than DC or MAINS	LF or VLF	S, A or L	0.01%			
		W	0.05%			
	AVIONICS	A or L	0.005%			
		S or W	None			
	<10kHz	S, A or L	F*0.006%			
		W	F*0.0025%			
	10k-40kHz	S, A or L	0.06%+(F-10)*0.014%			
		W	F*0.0025%			
	40k-100kHz	S, A or L	0.48%+(F-40)*0.032% other than option V 0.24%+(F-40)*0.052% for option V			
		W	0.1%+(F-40)*0.005%	0.1%+(F-40)*0.0055% option X 0.1%+(F-40)*0.0085% option V		
100k-1MHz	S, A or L	Typically (F/1100) <sup>2</sup> *150% (not valid for option V)				
	W	0.4%+(F-100)*0.018%	0.43%+(F-100)*0.02% option X only			
	>1MHz	W	Typically (F/5000) <sup>2</sup> *150%		Typically (F/3000) <sup>2</sup> *150% option X only	
<b>Self-Heating Scaling Error</b> Apply as % of Power reading to all results using voltage and current Self-Heating Errors from previous tables	All	Add Voltage and Current Self-Heating Errors				
<b>Temperature Scaling Error</b> Apply to all results if outside of ±5C from calibration temperature	All	0.005% per C outside of ±5C from calibration temperature				
<b>Bandwidth Limit Scaling Error</b> Apply to AC component of all results if using USER bandwidth setting	All	20%*(F/F <sub>BW</sub> ) <sup>2</sup> , unspecified above 0.3*F <sub>BW</sub>				
MAXIMUM FLOOR ERRORS						
Apply to all results as shown below in Watts, VA or VAR as applicable (generally only significant at low input levels)						
Specification	Channel Type	Option H	Option D HI Range	Option D LO Range	Option X HI Range	Option X LO Range
<b>Base Floor Error</b> Apply to all results	L	(V <sub>AC+DC</sub> *56μA) + (A <sub>AC+DC</sub> *45μV)	(V <sub>AC+DC</sub> *38μA) + (A <sub>AC+DC</sub> *45μV)	(V <sub>AC+DC</sub> *250nA) + (A <sub>AC+DC</sub> *45μV)	(V <sub>AC+DC</sub> *6μA) + (A <sub>AC+DC</sub> *45μV)	(V <sub>AC+DC</sub> *0.15μA) + (A <sub>AC+DC</sub> *45μV)
	A	(V <sub>AC+DC</sub> *56μA) + (A <sub>AC+DC</sub> *450μV)	(V <sub>AC+DC</sub> *38μA) + (A <sub>AC+DC</sub> *450μV)	(V <sub>AC+DC</sub> *250nA) + (A <sub>AC+DC</sub> *450μV)	(V <sub>AC+DC</sub> *6μA) + (A <sub>AC+DC</sub> *450μV)	(V <sub>AC+DC</sub> *0.15μA) + (A <sub>AC+DC</sub> *450μV)
	S or W	(V <sub>AC+DC</sub> *225μA) + (A <sub>AC+DC</sub> *1.8mV)	(V <sub>AC+DC</sub> *150μA) + (A <sub>AC+DC</sub> *1.8mV)	(V <sub>AC+DC</sub> *1μA) + (A <sub>AC+DC</sub> *1.8mV)	(V <sub>AC+DC</sub> *23μA) + (A <sub>AC+DC</sub> *1.8mV)	(V <sub>AC+DC</sub> *0.6μA) + (A <sub>AC+DC</sub> *1.8mV)
<b>DC Floor Error</b> Apply to DC and AC+DC results using the Voltage and Current DC Floor Errors from previous tables	All	(V <sub>DC</sub> *Current DC Floor Error) + (A <sub>DC</sub> *Voltage DC Floor Error) + (Current DC Floor Error*Voltage DC Floor Error)				
<b>AC Floor Error (VA and VAR only)</b> Apply to AC and AC+DC VA & VAR results using voltage and current AC Floor Errors from previous tables	All	(V <sub>AC</sub> *Current AC Floor Error) + (A <sub>AC</sub> *Voltage AC Floor Error)				
<b>Common Mode Error (VA and VAR only)</b> Apply to AC component of VA and VAR results using the Voltage and Current Common Mode Errors from previous tables.	All	(V <sub>AC</sub> *Current Common Mode Error) + (A <sub>AC</sub> *Voltage Common Mode Error)				
<b>Common Mode Error (Watts only)</b> Apply to AC component of Watts results using the Voltage Common Mode Error from previous table	All	(A <sub>AC</sub> *Voltage Common Mode Error)				
<b>Adjacent Channel Error</b> Apply to AC component of all results using the Voltage and Current Adjacent Channel Errors from previous tables	All	(V <sub>AC</sub> *Current Adjacent Channel Error) + (A <sub>AC</sub> *Voltage Adjacent Channel Error)				
<b>Phase Floor Error (Watts only)</b> Apply to AC and AC+DC Watts results	S, A or L	V <sub>A</sub> F <sub>UND</sub> *(PF <sub>FUND</sub> - cos(cos <sup>-1</sup> (PF <sub>FUND</sub> ) + 0.015°*F)) Alternately, as a worst case (at PF=0) this can expressed as F*0.028% of VA				
	W	V <sub>A</sub> F <sub>UND</sub> *(PF <sub>FUND</sub> - cos(cos <sup>-1</sup> (PF <sub>FUND</sub> ) + 0.007°*F)) Alternately, as a worst case (at PF=0) this can expressed as F*0.013% of VA				
<b>Phase Floor Error (VAR only)</b> Apply to all VAR results	S, A or L	V <sub>A</sub> F <sub>UND</sub> *(1 - PF <sub>FUND</sub> - cos(cos <sup>-1</sup> (1-PF <sub>FUND</sub> ) + 0.015°*F)) Alternately, as a worst case (at PF=1) this can expressed as F*0.028% of VA				
	W	V <sub>A</sub> F <sub>UND</sub> *(1 - PF <sub>FUND</sub> - cos(cos <sup>-1</sup> (1-PF <sub>FUND</sub> ) + 0.007°*F)) Alternately, as a worst case (at PF=1) this can expressed as F*0.013% of VA				



**28.4.1.2 HARMONIC WATTS MEASUREMENT ACCURACY TABLE**

Specification	Channel Type	Option H	Option D HI Range	Option D LO Range	Option X HI Range	Option X LO Range
Harmonic or Spectrum Watts Error	All	AC Watts Errors other than Phase Floor Error from preceding table at levels and F of the harmonic or spectrum point + (H/N) <sup>2</sup> *0.5% of reading + from below using the frequency of the harmonic or spectrum point				
	<10kHz	A or L	0.006% + (0.004%+0.028%*F)/PF			
	10k-115kHz		0.05% + (0.004%+0.028%*F)/PF			
	<10kHz	S	0.01% + (0.004%+0.028%*F)/PF			
	10k-115kHz		0.05% + (0.004%+0.028%*F)/PF			
	<10kHz	W	0.015% + (0.004%+0.013%*F)/PF			
	10k-115kHz		0.03% + (0.004%+0.013%*F)/PF			
115k-435kHz	0.08% + (0.004%+0.013%*F)/PF					

**28.4.1.3 EXAMPLES**

**Example 1**

For an AD channel (HI range) the maximum error of a measurement of the AC+DC Watts at 240Vrms, 3Arms, PF=1, 50Hz is a worst case of ±0.051% of reading as calculated by:

Scaling Errors:

- Base Scaling = ±0.045%
- Frequency Dependent Scaling = None at MAINS
- Self-heating Scaling = ±0.05%\*(240V/1000)<sup>2</sup> ± 0.0002%\*3<sup>2</sup> = ±0.0029%±0.0018% = ±0.0047%
- Temperature Scaling = none within 5C of the calibration temperature
- Bandwidth Limit Scaling = none when using AUTO-TRACK
- Total Scaling errors = ±0.0497% of reading

Floor Errors:

- Base Floor = (240\*38µA) + (3\*45µV) = 9255µW = ±9.255mW
- DC floor = 0 (signals have insignificant DC content)
- 240\*3\*(1 - cos(cos<sup>-1</sup>(1) + 0.015°\*0.05)) = 720\*(1 - cos(0 + 0.015°\*0.05)) = 720\*86pW = 62nW (negligible)
- Total Floor Errors = ±9.255mW = 0.0013% of reading

**Example 2**

For an AD channel (HI range) the maximum error of a measurement of the AC+DC Watts at 240Vrms, 3Arms, PF=0.5 caused by load distortion, 50Hz is a worst case of ±0.052% of reading as calculated by:

Scaling Errors:

- Base Scaling = ±0.045%
- Frequency Dependent Scaling = None at MAINS
- Self-heating Scaling = ±0.05%\*(240V/1000)<sup>2</sup> ± 0.0002%\*3<sup>2</sup> = ±0.0029%±0.0018% = ±0.0047%
- Temperature Scaling = none within 5C of the calibration temperature
- Bandwidth Limit Scaling = none when using AUTO-TRACK
- Total Scaling errors = ±0.0497%

Floor Errors:

- Base Floor = (240\*38µA) + (3\*45µV) = 9255µW = ±9.255mW
- DC floor = 0 (signals have insignificant DC content)
- Note – V<sub>FUND</sub> is 360 and PF<sub>FUND</sub> is 1 because of distortion
- 360\*(1 - cos(cos<sup>-1</sup>(1) + 0.015°\*0.05)) = 360\*(1 - cos(0 + 0.015°\*0.05)) = 360\*86pW = 31nW (negligible)
- Total Floor Errors = ±9.255mW = 0.0026% of reading

**Example 3**

For an AD channel (HI range) the maximum error of a measurement of the AC+DC Watts at 240Vrms, 3Arms, PF=0.5 caused by load phase shift, 50Hz is a worst case of ±0.055% of reading as calculated by:

Scaling Errors:

- Base Scaling = ±0.045%
- Frequency Dependent Scaling = None at MAINS
- Self-heating Scaling = ±0.05%\*(240V/1000)<sup>2</sup> ± 0.0002%\*3<sup>2</sup> = ±0.0029%±0.0018% = ±0.0047%
- Temperature Scaling = none within 5C of the calibration temperature
- Bandwidth Limit Scaling = none when using AUTO-TRACK
- Total Scaling errors = ±0.0497%

Floor Errors:

- Base Floor = (240\*38µA) + (3\*45µV) = 9255µW = ±9.255mW
- DC floor = 0 (signals have insignificant DC content)
- 720\*(0.5 - cos(cos<sup>-1</sup>(0.5) + 0.015°\*0.05)) = 720\*(0.5 - cos(60 + 0.015°\*0.05)) = 720\*11.3µW = 8.16mW
- Total Floor Errors = ±17.415mW = 0.0048% of reading

## 28.5 POWER FACTOR MEASUREMENT SPECIFICATIONS

### 28.5.1 PF MEASUREMENT ACCURACY TABLE

Add relevant errors from the table below for the maximum error in PF measurements. For PF<sub>FUND</sub> apply only the Base Floor and Phase Errors.

Note:

DC PF is 1.0 by definition and has no error; the table below applies to AC, AC+DC and FUND PF results.

Specification	Channel Type	Option H	Option D HI Range	Option D LO Range	Option X/V HI Range	Option X/V LO Range
<b>Base Floor Error</b> Apply to all PF results	L	$(56\mu\text{A}/A_{\text{AC+DC}}) + (45\mu\text{V}/V_{\text{AC+DC}})$	$(38\mu\text{A}/A_{\text{AC+DC}}) + (45\mu\text{V}/V_{\text{AC+DC}})$	$(250\text{nA}/A_{\text{AC+DC}}) + (45\mu\text{V}/V_{\text{AC+DC}})$	$(6\mu\text{A}/A_{\text{AC+DC}}) + (45\mu\text{V}/V_{\text{AC+DC}})$	$(0.15\mu\text{A}/A_{\text{AC+DC}}) + (45\mu\text{V}/V_{\text{AC+DC}})$
	A	$(56\mu\text{A}/A_{\text{AC+DC}}) + (450\mu\text{V}/V_{\text{AC+DC}})$	$(38\mu\text{A}/A_{\text{AC+DC}}) + (450\mu\text{V}/V_{\text{AC+DC}})$	$(250\text{nA}/A_{\text{AC+DC}}) + (450\mu\text{V}/V_{\text{AC+DC}})$	$(6\mu\text{A}/A_{\text{AC+DC}}) + (450\mu\text{V}/V_{\text{AC+DC}})$	$(0.15\mu\text{A}/A_{\text{AC+DC}}) + (450\mu\text{V}/V_{\text{AC+DC}})$
	S or W	$(225\mu\text{A}/A_{\text{AC+DC}}) + (1.8\text{mV}/V_{\text{AC+DC}})$	$(150\mu\text{A}/A_{\text{AC+DC}}) + (1.8\text{mV}/V_{\text{AC+DC}})$	$(1\mu\text{A}/A_{\text{AC+DC}}) + (1.8\text{mV}/V_{\text{AC+DC}})$	$(23\mu\text{A}/A_{\text{AC+DC}}) + (1.8\text{mV}/V_{\text{AC+DC}})$	$(0.6\mu\text{A}/A_{\text{AC+DC}}) + (1.8\text{mV}/V_{\text{AC+DC}})$
<b>AC Floor Error</b> Apply to all PF results using voltage and current AC Floor Error from previous tables, this error always causes a reduced PF reading	All	$-\text{PF}_{\text{RDG}} * ((\text{Current AC Floor Error}/A_{\text{RDG}}) + (\text{Voltage AC Floor Error}/V_{\text{RDG}}))$				
<b>DC Floor Error</b> Apply to AC+DC PF result after multiplying by (1-PF)	L	$(0.23\text{mA}/A_{\text{AC+DC}}) + (0.1\text{mV}/V_{\text{AC+DC}})$	$(0.15\text{mA}/A_{\text{AC+DC}}) + (0.1\text{mV}/V_{\text{AC+DC}})$	$(1\mu\text{A}/A_{\text{AC+DC}}) + (0.1\text{mV}/V_{\text{AC+DC}})$	$(40\mu\text{A}/A_{\text{AC+DC}}) + (0.1\text{mV}/V_{\text{AC+DC}})$	$(5\mu\text{A}/A_{\text{AC+DC}}) + (0.1\text{mV}/V_{\text{AC+DC}})$
	A	$(0.23\text{mA}/A_{\text{AC+DC}}) + (1\text{mV}/V_{\text{AC+DC}})$	$(0.15\text{mA}/A_{\text{AC+DC}}) + (1\text{mV}/V_{\text{AC+DC}})$	$(1\mu\text{A}/A_{\text{AC+DC}}) + (1\text{mV}/V_{\text{AC+DC}})$	$(40\mu\text{A}/A_{\text{AC+DC}}) + (1\text{mV}/V_{\text{AC+DC}})$	$(5\mu\text{A}/A_{\text{AC+DC}}) + (1\text{mV}/V_{\text{AC+DC}})$
	S	$(0.45\text{mA}/A_{\text{AC+DC}}) + (3\text{mV}/V_{\text{AC+DC}})$	$(0.3\text{mA}/A_{\text{AC+DC}}) + (3\text{mV}/V_{\text{AC+DC}})$	$(2\mu\text{A}/A_{\text{AC+DC}}) + (3\text{mV}/V_{\text{AC+DC}})$	$(80\mu\text{A}/A_{\text{AC+DC}}) + (3\text{mV}/V_{\text{AC+DC}})$	$(6\mu\text{A}/A_{\text{AC+DC}}) + (3\text{mV}/V_{\text{AC+DC}})$
	W	$(0.68\text{mA}/A_{\text{AC+DC}}) + (5\text{mV}/V_{\text{AC+DC}})$	$(0.45\text{mA}/A_{\text{AC+DC}}) + (5\text{mV}/V_{\text{AC+DC}})$	$(3\mu\text{A}/A_{\text{AC+DC}}) + (5\text{mV}/V_{\text{AC+DC}})$	$(120\mu\text{A}/A_{\text{AC+DC}}) + (5\text{mV}/V_{\text{AC+DC}})$	$(8\mu\text{A}/A_{\text{AC+DC}}) + (5\text{mV}/V_{\text{AC+DC}})$
<b>Phase Error</b> Apply to all PF results	S, A or L	$(\text{PF}_{\text{FUND}} - \cos(\cos^{-1}(\text{PF}_{\text{FUND}}) \pm 0.015^{\circ}\text{F}))$ Alternately, as a worst case (at PF=0) this can expressed as F*0.00028				
	W	$(\text{PF}_{\text{FUND}} - \cos(\cos^{-1}(\text{PF}_{\text{FUND}}) \pm 0.007^{\circ}\text{F}))$ Alternately, as a worst case (at PF=0) this can expressed as F*0.00013				

#### 28.5.1.1 EXAMPLES

##### Example 1

For an AD channel (HI range) the maximum error of a measurement of the AC+DC PF of a 240V, 5Arms, PF=0.5 (caused by phase shift) signal at 50Hz is a worst case of  $\pm 0.000029$  as calculated by:

Floor Errors:

$$\text{Base Floor} = (38\mu\text{A}/5\text{A}) + (450\mu\text{V}/240\text{V}) = \pm 0.000009475$$

$$\text{AC Floor} = -0.5 * (((1.5\mu\text{A}/5\text{A})/5\text{A}) + ((100\mu\text{V}/240\text{V})/240\text{V})) = -0.5 * (0.00000006 + 0.000000017) = -0.00000003$$

$$\text{DC Floor} = (1-0.5) * ((0.15\text{mA}/5\text{A}) + (1\text{mV}/240\text{V})) = \pm 0.00001708$$

$$\text{Total Floor Errors} = \pm 0.000018$$

Phase Errors:

$$(0.5 - \cos(\cos^{-1}(0.5) + 0.015^{\circ} * 0.05)) = (0.5 - \cos(60^{\circ} + 0.015^{\circ} * 0.05)) = \pm 0.000011$$

$$\text{Total Phase Errors} = \pm 0.000011$$

##### Example 2

As Example 1 but where the PF=0.5 is caused by load distortion instead of phase shift, the maximum error of the measurement of the AC+DC PF is a worst case of  $\pm 0.000018$  as calculated by:

Floor Errors:

$$\text{Base Floor} = (38\mu\text{A}/5\text{A}) + (450\mu\text{V}/240\text{V}) = \pm 0.000009475$$

$$\text{AC Floor} = -0.5 * (((1.5\mu\text{A}/5\text{A})/5\text{A}) + ((100\mu\text{V}/240\text{V})/240\text{V})) = -0.5 * (0.00000006 + 0.000000017) = -0.00000003$$

$$\text{DC Floor} = (1-0.5) * ((0.15\text{mA}/5\text{A}) + (1\text{mV}/240\text{V})) = \pm 0.00001708$$

$$\text{Total Floor Errors} = \pm 0.000018$$

Phase Errors:

$$\text{PF}_{\text{FUND}} = 1.0 \text{ since load has no phase shift only distortion.}$$

$$(1 - \cos(\cos^{-1}(1) + 0.015^{\circ} * 0.05)) = (1 - \cos(0^{\circ} + 0.015^{\circ} * 0.05)) = 0$$

$$\text{Total Phase Errors} = 0$$

##### Example 3

For a WD channel (HI range) the maximum error of a measurement of the AC PF of a 100V, 5Arms, PF=0.01 (caused by phase shift) signal at 50kHz is a worst case of  $\pm 0.0062$  as calculated by:

Floor Errors:

$$\text{Base Floor} = (150\mu\text{A}/5\text{A}) + (1.8\text{mV}/100\text{V}) = \pm 0.000048$$

$$\text{AC Floor} = -0.01 * (((250\mu\text{A}/5\text{A})/5\text{A}) + ((1.1\text{mV}/100\text{V})/100\text{V})) = -0.01 * (0.00001 + 0.000011) = -0.0000001$$

$$\text{Total Floor Errors} = \pm 0.0000481$$

Phase Errors:

$$(0.01 - \cos(\cos^{-1}(0.01) + 0.007^{\circ} * 50)) = (0.01 - \cos(89.427^{\circ} + 0.007^{\circ} * 50)) = 0.006152$$

## 28.6 FREQUENCY MEASUREMENT SPECIFICATIONS

Frequency Range	FUND setting of MAINS: 45Hz to 65Hz FUND setting of AVIONICS: 300Hz to 900Hz Otherwise- LF/PERIOD setting of VLF: 0.0099Hz to 65Hz LF/PERIOD setting of LF: 0.19Hz to 1kHz LF/PERIOD setting of 300ms period: 9Hz to 305kHz (W channel type) or 80kHz (other channel types) LF/PERIOD setting of 100ms period: 19Hz to 305kHz (W channel type) or 80kHz (other channel types) LF/PERIOD setting of 20ms period: 44Hz to 305kHz (W channel type) or 80kHz (other channel types) LF/PERIOD setting of 10ms period: 145Hz to 305kHz (W channel type) or 80kHz (other channel types) LF/PERIOD setting of 2ms period: 495Hz to 305kHz (W channel type) or 80kHz (other channel types) If BANDWIDTH set to USER setting then upper limit is $0.5 \times \text{setting}$
DC Level	DC offset is automatically eliminated
Min. Input (typical)	Voltage: 0.5Vrms (W, S or A channel type) or 75mVrms (L channel type) at fundamental Current, H option: 0.05Arms at fundamental Current, D option: 0.04Arms (HI range) or 0.3mArms (LO range) at fundamental Current, X or V option: 5mVrms (HI range) or 150 $\mu$ Vrms (LO range) at fundamental
Min. Pulse Width (typical)	Greater of - 1.25 $\mu$ s (W channel type) or 5 $\mu$ s (other channel types) 0.001% of measurement period 10% of signal period
Update Period (nominal)	As shown below for FREQ SPEED settings of FAST/NORMAL/SLOW respectively - LF/PERIOD setting of VLF: greater of 1/2/15s or 1 cycle LF/PERIOD setting of LF: greater of 1/1/5s or 1 cycle LF/PERIOD setting of 300ms period: 0.25s/0.75s/2s LF/PERIOD setting of 100ms period: 55ms/250ms/1s LF/PERIOD setting of 20ms period: 25ms/200ms/700ms LF/PERIOD setting of 10ms period: 10ms/100ms/300ms LF/PERIOD setting of 2ms period: 2ms/50ms/150ms
Resolution (nominal)	W Channel Type: 0.000125%/Update Period in seconds Otherwise: 0.0005%/Update Period in seconds
Maximum Error	0.01% + Resolution
Settling Time (nominal)	Greater of (x2 if significant DC content) - a) 2 amplitude periods b) 2 frequency measurement periods c) 4 cycles of the signal

## 29 MECHANICAL CHANNEL INPUT AND ACCURACY SPECIFICATIONS (MT TYPE)

Specifications are valid under the following conditions-

- All specifications are valid following a 20 minute warm-up period after turning power ON in the PA900, when operated from the specified source of power and within the specified environmental conditions.
- All specifications other than Analog Input Measurement Specifications are valid for the lifetime of the PA900; Analog Input Measurement Specifications are valid for 2 years after calibration.
- All specifications are valid at the PA900 terminals.

Note:

The No Damage input signal range is that which will not cause immediate damage. Continued use of these levels may reduce reliability and/or future accuracy.

The Specified input signal range is that of continuously applied signal levels for which measurements are guaranteed to be within the specified accuracies.

Accuracy specifications are guaranteed maximum errors. You should round the total maximum error upwards to the next integer count of resolution (e.g. if the total error is 18.3mV and the data is read with 1mV resolution then use 19mV as the maximum error).

All percentages are % of reading unless otherwise described.

### 29.1 INPUT CAPABILITIES AND CHARACTERISTICS

Input Terminals	SPD (Speed) : BNC (isolated from PA900 chassis), configurable as analog or digital input TRQ (Torque) : BNC (isolated from PA900 chassis), configurable as analog or digital input DIR (Direction) : BNC (isolated from PA900 chassis), digital input
Input Common-Mode	Up to -15Vpk to +15Vpk specified Up to -30Vpk to +30Vpk with no damage
Analog Input Range	Up to -12Vdc to +12Vdc specified Up to -15Vpk to +15Vpk specified Up to -30Vpk to +30Vpk with no damage
Digital Input Range	LO: <0.8V (nominal) HI: >2V (nominal) Up to -30Vpk to +30Vpk with no damage
Input Impedance	Each input nominally 150kΩ to PA900 chassis ground

### 29.2 DIGITAL INPUT MEASUREMENT SPECIFICATIONS

Digital Frequency Timing	Signal must be LO for >500ns Signal must be HI for >500ns Frequency measurement up to 500kHz (typically 900kHz) Minimum measurable frequency limited by user set measurement period
DIR Setup/Hold Timing	DIR must be stable for >550ns prior to and after active edge of SPD input
Maximum Frequency Error	Measurement Period >10ms: 0.01% Measurement Period ≤10ms: 0.015%

### 29.3 ANALOG INPUT MEASUREMENT SPECIFICATIONS

Maximum Input Error	0.05% + 1mV Add (0.005% + 50μV) per C outside of ±5C from calibration temperature
---------------------	--

## 30 ANALYSIS SPECIFICATIONS

Specifications are valid under the following conditions-

- All specifications are valid following a 20 minute warm-up period after turning power ON in the PA900, when operated from the specified source of power and within the specified environmental conditions.
- All specifications are valid for the lifetime of the PA900.

Note:

All percentages are % of reading unless otherwise described.

### 30.1 INTEGRATION SPECIFICATIONS

Start Delay Time	Zero to 99 days, 99 hours, 99 minutes, 99 seconds (1 second resolution) 0.01% + 8ms maximum error
Integration Time	Manual (unrestricted period of time), or 1 second to 99 days, 99 hours, 99 minutes, 99 seconds 0.01% + 1ms maximum error
Maximum Data Error	(0.01% + 1ms) (not for integrated average data) + (0.03/measurement period in seconds)% per year

### 30.2 HARMONIC ANALYSIS SPECIFICATIONS

This section is not applicable when configured for EN61000-3-2 or -12 modes. In those modes harmonic analysis is performed to the requirements of EN61000-4-7:2002 + A1:2009 with corrigenda Aug. 2004, May 2005 and Nov. 2011 (see section 18.1.5).

Method	DFT performed at each frequency on same set of sampled signals (there is no discontinuity throughout the analysed frequency range)
Window	F > (2/measurement period): Hann (also called Hanning) Otherwise: Rectangular
Maximum Harmonic	The smaller of - a) A frequency of 435kHz (W type channels) or 115kHz (otherwise) b) 500 <sup>th</sup> c) HARMONICS setting d) If BANDWIDTH set to USER: 0.5*setting/fundamental frequency
Harmonic Bandwidth	Nominally the greater of - a) The smaller of fundamental frequency or 2/(LF/PERIOD measurement period) b) If FUND set to AVIONICS: 20Hz c) (Fundamental Frequency*Maximum Harmonic/2250)
Measurement Period	Nominally (1/Harmonic Bandwidth)
Update Interval	Nominally the greater of - a) LF/PERIOD measurement period b) Harmonic Measurement Period (from above) c) 0.25ms x $\Sigma$ (Maximum Harmonic for each channel configured for harmonics)
Data Available	Volts, Amps and Watts amplitudes for each configured harmonic Volts and Amps as a percentage of the fundamental of the same signal Volts and Amps THD as a percentage of the fundamental of the same signal Volts and Amps THD as a percentage of the AC+DC amplitude of the same signal V and A Phase of fundamental relative to the voltage fundamental of the lowest numbered channel in the VPA V and A Phase of each non-fundamental harmonic relative to the fundamental of the same signal THC (Total Harmonic Current, see section 11.10) POHC (Partial Odd Harmonic Current, see section 11.10) PWHC ((Partial Weighted Harmonic Current, see section 11.10)
Accuracy	See relevant Voltage, Current and Watts accuracy specifications

### 30.3 SPECTRUM ANALYSIS SPECIFICATIONS

Method	DFT performed at each frequency on same set of sampled signals (there is no discontinuity throughout the analysed frequency range)
Window	Hann (also called Hanning)
Frequency Resolution	0.01Hz to 1kHz
Measurement Period	Nominally (1/ Frequency Resolution)
Maximum Frequency	Minimum is 100 x Frequency Resolution Maximum is the lowest of nominally - a) 16384 x Frequency Resolution (under some circumstances as low as 8192 x Frequency Resolution) b) 435kHz (W type channels) or 115kHz (otherwise)
Data Available	Volts, Amps and Watts amplitudes for each configured spectrum frequency
Accuracy	See relevant Voltage, Current and Watts accuracy specifications

## 30.4 CYCLE VIEW SPECIFICATIONS

Signal Range	As specifications for Voltage and Current
Cycle Period	From 2.3 $\mu$ s (W type channels), 8.7 $\mu$ s (otherwise) up to 100 seconds
Time Resolution	1/512 <sup>th</sup> of a cycle
Method	Mean cycle formed by asynchronously sampling all cycles within measurement period
Maximum Error	As Voltage and Current Specifications for PK data (Watts = multiplication of V and A waveforms)

## 30.5 SCOPE SPECIFICATIONS

Signal Range	As specifications for Voltage and Current
Timebase	1/2/5 settings from 5 $\mu$ s/div to 20s/div
Capture Depth	Up to 32k points per signal
Capture Resolution	<0.00005% of specified maximum measurable peak Voltage or Current
Sampling Period (nominal)	Greater of - 1.1 $\mu$ s (W type channels) or 4.1 $\mu$ s (otherwise) 0.03% of timebase setting
Maximum Error	As Voltage and Current Specifications for PK data (Watts = multiplication of V and A waveforms)

## 30.6 HISTORICAL DATA COLLECTION SPECIFICATIONS

Collection Time	Automatically continuously variable between 1 measurement period and 584.5 million years (collection is automatically stopped after this time has elapsed but this is untested at the time of writing)
Time Resolution	Note: this is the resolution by which you can determine when an event occurred, not that of the PA900 detecting events. All events are captured. The greater of- a) 1 pixel of displayed data (front panel) or 1 increment of the requested time interval (interface) b) 1 measurement period of the data being recorded c) A maximum of 1/4096 <sup>th</sup> of the elapsed historical data collection time (typically 1/8192 <sup>th</sup> ).
Data Capture	Every measurement is included in the maximum, average and minimum data for each increment of the time resolution interval regardless of the time resolution.

## 30.7 DATA LOGGING SPECIFICATIONS

Logged Measurements	Up to 16 measurement data per record (each of which can be 1 measurement or up to 500 harmonic measurements)
Data per Record	Up to 8003 data per record
Internal FIFO Buffer	32Mbyte (always in binary format, 4 bytes per data)
Internal Memory	$\geq$ 2Gbyte (always in binary format, 4 bytes per data) non-volatile Typically 5Mbytes/sec maximum sustained mean write rate
External Data File Format	ASCII (CSV, scientific format) or Binary
Timestamp	Record number + optional date and time (1 second resolution)
Maximum File Size	4Gbyte
Maximum Records	Only limited by maximum file size
Start Delay Time	Zero to 99 days, 99 hours, 99 minutes, 99 seconds (1 second resolution) 0.01% + 8ms maximum error
Run Time	Manual (unrestricted period of time), or 1 second to 99 days, 99 hours, 99 minutes, 99 seconds (1 second resolution) 0.01% + 8ms maximum error
Log Interval	0.002 second, or 0.01 second to 99 hours, 99 minutes, 99.99 seconds (0.01 second resolution) 0.01% maximum error $\pm$ 2ms non-accumulating error



## 31 CALIBRATION ADJUSTMENT

Typically calibration adjustment should be rarely needed; however you may wish to perform it at periodic intervals to ensure optimal performance.

- The PA900 employs internal software calibration adjustments, there are no physical adjustments required. These adjustments are needed to correct for manufacturing tolerances in the components used in the PA900.
- It is important to note that there is no calibration of electro-mechanical performance (e.g. high frequency response) or design defects, giving you a high degree of certainty that the PA900 maintains its' specifications.
- Calibration adjustment can only be performed via an interface using an application provided on the CD with the PA900. This application does not control the source of the voltage or current being used for adjustment, it only controls the PA900. You should ensure -
  - The computer being used has a suitable interface installed.
  - The computer being used has the supplied PA900 calibration adjustment application installed.
  - The PA900 has been properly configured for the interface chosen.
- Calibration adjustment should only be performed after the PA900 has been continuously powered in a stable environment for at least 1 hour. If the PA900 has been moved between differing environments, then at least 3 hours should be allowed.
- In the procedure below, each installed channel is calibrated separately and the procedure varies automatically depending on the channel type (the 1<sup>st</sup> letter of the channel code) and the channel current option (the 2<sup>nd</sup> letter of the channel code).
- The supplied application automatically saves the measurement configuration of the PA900 prior to reconfiguring it for calibration adjustments and restores the saved configuration after calibration adjustment has been completed.
- The PA900 may be adjusted at any frequency between 45 and 450Hz. It normally produces the optimum results to calibrate the PA900 at 50, 55 or 60Hz. At these frequencies the specifications of the source are typically the most accurate. When calibrating at very low signal levels you may experience interference from the local mains supply, in these cases it is recommended to adjust the PA900 at a frequency of other than the local mains supply. The accuracy difference in the PA900 between 50, 55 or 60Hz is extremely small and may be ignored, and the difference between performing the adjustments at near mains frequency vs. 400Hz for aerospace applications may also be disregarded as the difference in the PA900 accuracy is negligible at the adjustment levels.

### 31.1 EQUIPMENT REQUIRED

The following equipment will be required during calibration adjustment-

1. A short circuit capable of being attached between the V or A terminals of the PA900 channels (standard 4mm banana terminals using ¼ inch spacing) and a method of grounding the short circuit. This short circuit should be constructed to minimize thermally induced EMFs.
2. (Only required for W, S and A channel types) A source of AC voltages into a 1.2Mohm load (S or A channel types) or 400Kohm load (W channel types) of 10V, 20V, and 200Vrms at a frequency of between 45 and 450Hz (the use of 50Hz or 60Hz is recommended) with sufficient amplitude accuracy to ensure the desired ratio between the specified PA900 accuracy and that of the applied voltage. For a 4:1 TUR (typically used) the voltage source should have an accuracy of <0.025%+0.75mV (S or W channel types) or <0.0075%+0.5mV (A channel types) at these levels.
3. (Only required for L channel types) A source of AC voltages into a 120kohm load of 1V, 2V, and 20Vrms at a frequency of between 45 and 450Hz (the use of 50Hz or 60Hz is recommended) with sufficient amplitude accuracy to ensure the desired ratio between the specified PA900 accuracy and that of the applied voltage. For a 4:1 TUR (typically used) the voltage source should have an accuracy of <0.0075%+50uV at these levels.
4. (Only required for channels having the H current option) A source of AC current into a 0.01ohm load (plus the impedance of the wiring between the PA900 and the source) at 1A, 2A and 10Arms at a frequency of between 45 and 450Hz (the use of 50Hz or 60Hz is recommended) with sufficient amplitude accuracy to ensure the desired ratio between the specified PA900 accuracy and that of the applied current. For a 4:1 TUR (typically used) the current source should have an accuracy of <0.025%+200uA (S or W channel types) or <0.0075%+125uA (A channel types) at these levels.
5. (Only required for channels having the D current option) A source of AC current into a 0.02ohm load (plus the impedance of the wiring between the PA900 and the source) at 1A, 2A and 10Arms at a frequency of between 45 and 450Hz (the use of 50Hz or 60Hz is recommended) with sufficient amplitude accuracy to ensure the desired ratio between the specified PA900 accuracy and that of the applied current. For a 4:1 TUR (typically used) the current source should have an accuracy of <0.025%+125uA (S or W channel types) or <0.0075%+75uA (A channel types) at these levels.
6. (Only required for channels having the D current option) A source of AC current into a 0.57ohm load (plus the impedance of the wiring between the PA900 and the source) at 100mArms at a frequency of between 45 and 450Hz (the use of 50Hz or 60Hz is recommended) with sufficient amplitude accuracy to ensure the desired ratio between the specified PA900 accuracy and that of the applied current. For a 4:1 TUR (typically used) the current source should have an accuracy of <0.02575% (S or W channel types) or <0.007875% (A channel types) at these levels.
7. (Only required for channels having the X or V current option) A source of AC voltage into a 20.5Kohm load at 0.1V, 0.5V, 2V and 10Vrms at a frequency of between 45 and 450Hz (the use of 50Hz or 60Hz is recommended) with sufficient amplitude accuracy to ensure the desired ratio between the specified PA900 accuracy and that of the applied voltage. For a 4:1 TUR (typically used) the voltage source should have an accuracy of <0.025%+12.5uV (S or W channel types) or <0.0075%+7.5uV (A channel types) at these levels. Note that some sources may require that you adjust the voltage setting to achieve the correct voltage into a 20.5Kohm load for option X or a 205Kohm load for option V.

- (Only required for channels having the X or V current option) A source of AC voltage into a 10.25Kohm load at 200mVrms at a frequency of between 45 and 450Hz (the use of 50Hz or 60Hz is recommended) with sufficient amplitude accuracy to ensure the desired ratio between the specified PA900 accuracy and that of the applied voltage. For a 4:1 TUR (typically used) the voltage source should have an accuracy of <0.02544% (S or W channel types) or <0.007815% (A channel types) at these levels. Note that some sources may require that you adjust the voltage setting to achieve the correct voltage into a 10.25Kohm load for option X or a 102.5Kohm load for option V.

## 31.2 ADJUSTMENT PROCEDURE

After first running the software application provided and connecting the chosen interface between the computer and the PA900 you should perform the actions of each of the following sections.

### 31.2.1 STARTING THE INTERFACE TO THE PA900

In the INTERFACE TO UNIT TO BE ADJUSTED area of the application-

- Using the radio buttons, select the chosen interface to the PA900.
- If using the RS232 interface select the baud rate for the RS232 interface.
- If using the LAN interface type in the IP address of the PA900. This can be seen by pressing the LAN info area on the PA900 screen.
- Press the CONNECT button, this will then be relabeled DISCONNECT and the identification of the PA900 will be shown underneath the button after the application has correctly established communications with the PA900. This shows the model number, any installed option contents, the serial number and the main firmware version. The installed channels, along with their type and option and serial numbers will be listed with radio buttons in the ADJUSTMENT CHANNEL SELECTION area of the application.
- Check that you have connected to the correct PA900 and that it has expected serial number and channel content.
- (If required) Press the SET DATE and TIME button. This will set the date and time of the PA900 to that of the computer.

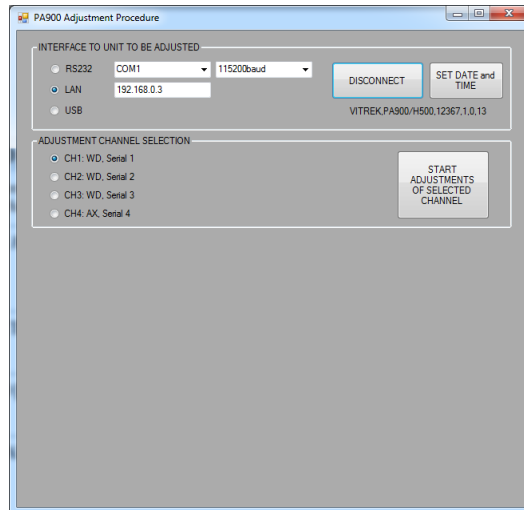

### 31.2.2 ADJUSTING EACH CHANNEL IN THE PA900

Each channel is adjusted separately, so the procedure below should be performed for each channel installed in the PA900. After a channel has been adjusted "- ADJUSTED" is shown following its serial number in the ADJUSTMENT CHANNEL SELECTION area of the application.

- Using the radio buttons in the ADJUSTMENT CHANNEL SELECTION area, select the channel to be adjusted.
- Ensure that there are no connections to any channel terminals of the PA900.
- Press the START ADJUSTMENTS OF SELECTED CHANNEL button.

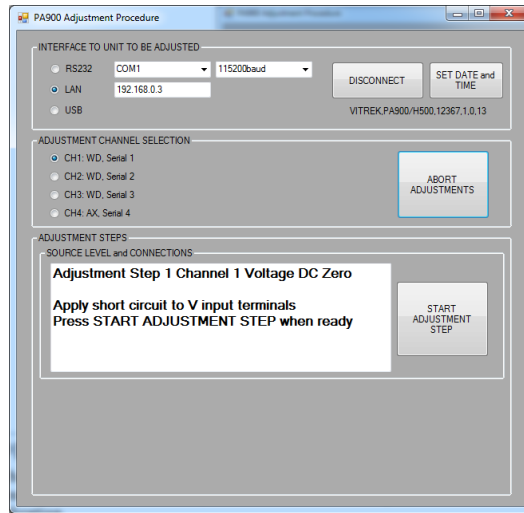

4. During each step in the adjustment procedure the same actions are needed (not all steps may be present and the source required in each step varies depending on the channel type and option being adjusted)-
  - a. Note the expected input to the terminals as noted in the SOURCE LEVEL and CONNECTIONS window and apply the source as requested. Ensure that only the expected connections are made to the PA900, there should be no other connections during any step in the procedure.
  - b. When the requested input has been provided, press the START ADJUSTMENT STEP button.

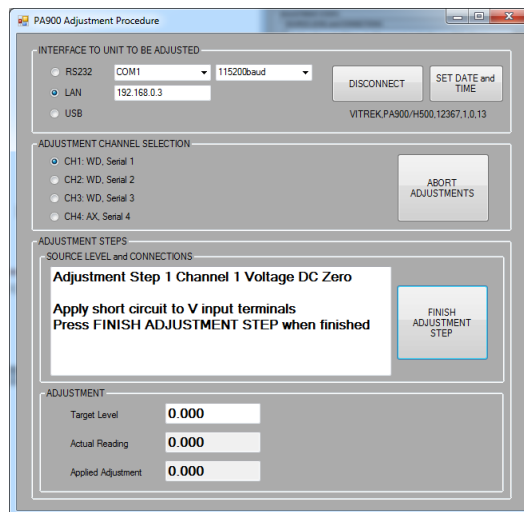

- c. For the zero adjustment steps (steps 1, 2 and 3): the ADJUSTMENT area shows the target level (always zero), the actual PA900 reading, and the applied adjustment. These are each in volts or amps units depending on the zero being adjusted. Adjustment is automatic for these steps, so you should just press the FINISH ADJUSTMENT STEP button for each when you are satisfied that the zero has been fully adjusted.
  - i. Where a short circuit is requested to be applied, you should also ground the short circuit.
  - ii. Where an open circuit is requested to be applied, all terminals should have no connections.
  - iii. Particularly for the LO range X or V option DC zero adjustment (step 3 for the X or V option) there may be thermally induced voltages on the short circuit being used. For step 3 of the X or V current option adjustment it is recommended to wait at least 1 minute for any thermals to have dissipated before pressing the FINISH ADJUSTMENT STEP button.
  - iv. You should be aware of the PA900 specifications for the channel and step being adjusted. Using this will assist you in determining if you are satisfied with the adjustment or not. In some steps the last digit is not trimmed to be exactly correct.
- d. For the scaling adjustment steps (steps 4 onwards): the ADJUSTMENT area shows the target level (which may be overwritten if desired), the actual PA900 reading (both in Volts or Amps as applicable), the applied adjustment (in percent) and allows you to either adjust the PA900 manually or automatically. If applying the adjustment manually then you can change the size of each step with the COARSE, MEDIUM and FINE radio buttons and the target value is not used. If applying the adjustment automatically then the user must ensure that the correct target value is entered and the source is fully settled before checking the AUTO ADJUST checkbox. When you are satisfied with the adjustment press the FINISH ADJUSTMENT STEP button to proceed to the next step.
  - i. You should be aware of the PA900 specifications for the channel and step being adjusted. Using this will assist you in determining if you are satisfied with the adjustment or not. If you adjust the reading down to the last digit then in some circumstances this will yield unnecessarily long adjustment times and in some steps the last digit cannot be trimmed to be exactly correct.

- e. After the last step has been completed for this channel (there are up to 12 steps for each channel) press the SAVE ADJUSTMENTS button to save the adjustments to the channel and return to selecting the next channel to adjust.
- f. NOTE: pressing the ABORT ADJUSTMENTS button at any time during the adjustment of a channel will discard any adjustments made to that channel until the SAVE ADJUSTMENTS button is pressed.

---

### **31.2.3 FINISHING THE PROCEDURE**

When all adjustments have been performed on all channels requiring adjustment, the user may press the DISCONNECT button to disconnect the application from the PA900. The adjustments were saved when each channel adjustment was completed.

WARNING: Do not remove power from the PA900 during or until at least 10 seconds after completing adjustments.

## 32 CALIBRATION VERIFICATION

To be determined.