



Remote Communicaton Manual

DU8090Z
DU8190Z

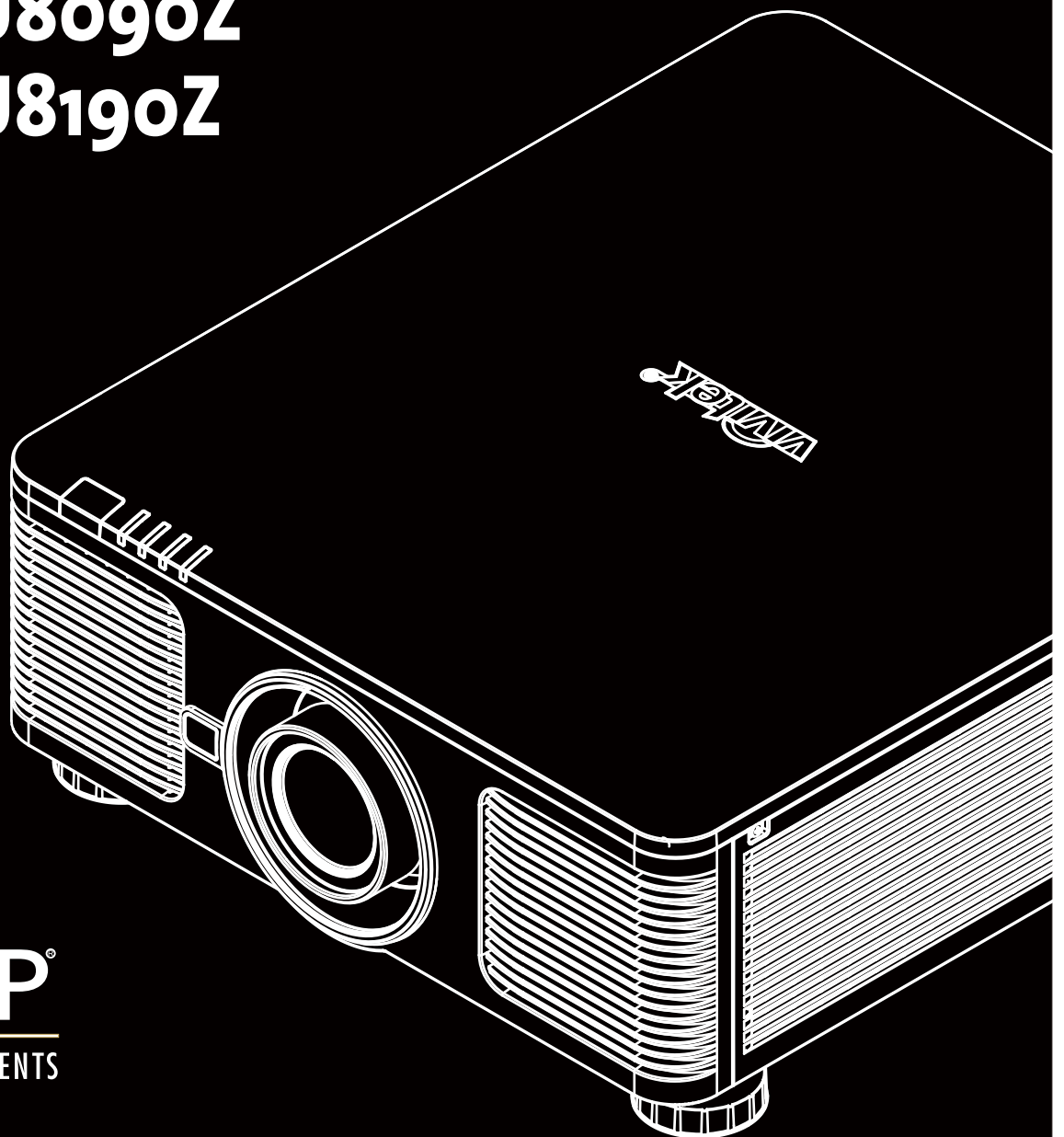

Table of Contents

The Serial Interface RS-232 Command	2
Communication parameter	2
Operation commands.....	2
Operation command syntax	2
List of operation commands	3
Simulated IR remote controller commands	14
List of simulated IR remote controller commands	14
Control the Projector Through a Network.....	15
Cable connection	15
Set up the projector for networking	16
Control the projector through a network.....	17
Control the projector through a web browser	17
Control projector with TCP/IP communication protocol	21
About Vivitek Support	22

The Serial Interface RS-232 Command

This projector supports to control by RS-232 command, there exist two types of RS-232 serial commands:

- Operation command: Available menu options are INPUT, PICTURE, ALIGNMENT, CONTROL and SERVICE.
- Simulated IR remote controller commands: Controls projector via RS-232 command, the commands simulate IR remote controller and its control keys.

Communication parameter

You can use the serial control command to input commands for projector control or retrieve its operational data through Windows client terminal software, e.g. Hyper Terminal, with ASCII characters. You need to set up the following communication parameters in advance:

Item	Parameter:
Bit per Second	9600 bps
Data Bit	8-bit
Parity	None
Stop Bit	1
Flow Control	None
Port	7000

Note:

- The terminal software does not return every command input character
- The transmission performance varies with the length of RS-232 cable

Operation commands

Operation command syntax

An operation command is prefixed by character "op", followed by control commands and settings separated by space blank [SP], and ended by carriage return pair "CR" and "ASCII hex 0D". Syntax of serial control commands:

op[SP]<operation command>[SP]<Setting Value>[CR]

- op** : A constant indicating this is an operation command.
[SP] : Indicate one blank space.
[CR] : Indicate the command ending carriage return pair "CR" and "ASCII hex 0D".
Setting value : Settings of operation command

Types of setup strings	Characters of settings	Description
Query current setup	?	Question mark "?" indicates querying current setup
Setup	= <settings>	Syntax: Symbol "=" suffixed with setup values
Increase setup order of adjustment items	+	Some settings are changed in steps. Symbol "+" indicates changing one step up
Decrease setup order of adjustment items	-	Some settings are changed in steps. Symbol "-" indicates changing one step down
Execute operation command	None	Certain operation commands execute after input without further setting or regulators.

Examples:

Control items	Input command	Projector return message
Query current brightness	op bright ? [CR]	OP BRIGHT = 101
Set up brightness	op bright = 127 [CR]	OP BRIGHT = 127
Set up input signal source to HDMI	op input.sel = 0 [CR]	OP INPUT.SEL = 0
Reset projection lens to center position	lens.center	

Note:

When sending the multiple commands, make sure the return message of the last command is received before sending out the next one.

List of operation commands

INPUT

OSD Function	Operation command	Settings/Return Values	Note
Input Select	input.sel	? = 0 = HDMI 1 1 = HDMI 2 2 = VGA 3 = Component / BNC 4 = DVI 5 = 3G-SDI 6 = HDBaseT	Not applicable when the project is at below status. • Standby mode • When the blank function is activated
PIP/PIP Option	pip.mode	? = 0 = Off 1 = On	Not applicable when the project is at below status. <input type="checkbox"/> Standby mode <input type="checkbox"/> When PIP is off
PIP/PIP Input	pip.sel	? = 0 = HDMI 1 1 = HDMI 2 2 = VGA 3 = Component / BNC 4 = DVI 5 = 3G-SDI 6 = HDBaseT	Not applicable when the project is at below status. <input type="checkbox"/> Standby mode <input type="checkbox"/> When PIP is off
PIP/ Position	pip.pos	? = 0 = Top Left 1 = Top Right 2 = Bottom Left 3 = Bottom Right 4 = PBP	Not applicable when the project is at below status. <input type="checkbox"/> Standby mode <input type="checkbox"/> When PIP is off
Auto Source	auto.src	? = 0 = Off 1 = On	Not applicable when the projector is in standby mode.
Color Space	color.space	? = 0 = Auto 1 = YPbPr (Rec. 709) 2 = YcbCr (Rec. 601) 3 = RGB-PC (0-255) 4 = RGB-Video (16-235)	Not applicable when the project is in standby mode or the input signal is not yet locked.
Aspect Ratio	aspect	? = 0 = 5:4 1 = 4:3 2 = 16:10 3 = 16:9 4 = 1.88 5 = 2.35 6 = LetterBox 7 = Source 8 = Native	• Not applicable when the project is in standby mode or the input signal is not locked yet. • When the Zoom function is set to Zoom in, the Unscaled function is disabled.
Overscan	zoom	? = 0 = Off 1 = Crop 2 = Zoom	• Not applicable when the project is in standby mode or the input signal is not locked yet. • When the Zoom function is set to Zoom in, the Unscaled function is disabled.

OSD Function	Operation command	Settings/Return Values		Note
VGA Setup/H Total	h.total	? = + -	0-200	<ul style="list-style-type: none"> Not applicable when the project is in standby mode or the input signal is not locked yet. Apply for VGA and Component signal input.
VGA Setup/H Start	h.pos	? = + -	0-200	<ul style="list-style-type: none"> Not applicable when the project is in standby mode or the input signal is not locked yet. Apply for VGA and Component signal input.
VGA Setup/H Phase	h.phase	? = + -	0-200	<ul style="list-style-type: none"> Not applicable when the project is in standby mode or the input signal is not locked yet. Apply for VGA and Component signal input.
VGA Setup/V Start	v.pos	? = + -	0-200	<ul style="list-style-type: none"> Not applicable when the project is in standby mode or the input signal is not locked yet. Apply for VGA and Component signal input.
Test Pattern	pattern	? =	0 = Off 1 = White 2 = Black 3 = Red 4 = Green 5 = Blue 6 = Checkboard 7 = CrossHatch 8 = V Burst 9 = H Burst 10 = Color Bar	Not applicable when the project is in standby mode.
3D/3D Format	3d.format	= ?	0 = Off 1 = Auto 2 = Side-By-Side (Half) 3 = Top-And-Bottom 4 = Frame Sequential	Not applicable when the project is at below status. <input type="checkbox"/> Standby mode
3D/Eye Swap	3d.swap	= ?	0 = Normal 1 = Reverse	Not applicable when the project is at below status. <input type="checkbox"/> Standby mode
3D/DLP Link	3d.dlplink	= ?	0 = Off 1 = On	Not applicable when the project is at below status. <input type="checkbox"/> Standby mode
3D/Dark Time	3d.darktime	= ?	0 = 0.65 ms 1 = 1.3 ms 2 = 1.95 ms	Not applicable when the project is at below status. <input type="checkbox"/> Standby mode
3D/sync delay	3d.syncdelay	= ?	1 – 60	Not applicable when the project is at below status. <input type="checkbox"/> Standby mode
3D/Sync Reference	3d.syncref	= ?	0 = External 1 = Internal 2 = Auto	Not applicable when the project is at below status. <input type="checkbox"/> Standby mode

PICTURE

OSD Function	Operation command	Settings/Return Values		Note
Picture Mode	pic.mode	? = + -	0 = High Bright 1 = Presentation 2 = Video	Not applicable when the project is in standby mode.
Brightness	bright	? = + -	0-200	Not applicable when the project is in standby mode or the input signal is not locked yet.
Contrast	contrast	? = + -	0-200	Not applicable when the project is in standby mode or the input signal is not locked yet.
Saturation	saturat	? = + --	0-200	<ul style="list-style-type: none"> • Apply for YUV signal input • Not applicable when the project is in standby mode or the input signal is not locked yet.
Hue	tint	? = + -	0-200	<ul style="list-style-type: none"> • Apply for YUV signal input • Not applicable when the project is in standby mode or the input signal is not locked yet.
Sharpness	sharp	? = + -	0-20	Not applicable when the project is in standby mode or the input signal is not locked yet.
Color Temperature	color.temp	? =	0 = 5400K 1 = 6500K 2 = 7500K 3 = 9300K 4 = Native	Not applicable when the project is in standby mode or the input signal is not locked yet.
Gamma	gamma	? =	0 = 1.0 1 = 1.8 2 = 2.0 3 = 2.2 4 = 2.35 5 = 2.5 6 = S-Curve	Not applicable when the project is in standby mode or the input signal is not locked yet.
Input Balance /Red Offset	red.offset	? = + -	0-200	Not applicable when the project is in standby mode or the input signal is not locked yet.
Input Balance /Green Offset	green.offset	? = + -	0-200	Not applicable when the project is in standby mode or the input signal is not locked yet.
Input Balance /Blue Offset	blue.gain	? = + -	0-200	Not applicable when the project is in standby mode or the input signal is not locked yet.

OSD Function	Operation command	Settings/Return Values		Note
Input Balance /Red Gain	red.gain	? = + -	0-200	Not applicable when the project is in standby mode or the input signal is not locked yet.
Input Balance /Green Gain	green.gain	? = + -	0-200	Not applicable when the project is in standby mode or the input signal is not locked yet.
Input Balance /Blue Gain	blue.gain	? = + -	0-200	Not applicable when the project is in standby mode or the input signal is not locked yet.
HSG/Red Gain	hsg.r.gain	? = + -	0-200	Not applicable when the project is in standby mode or the input signal is not locked yet.
HSG/Green Gain	hsg.g.gain	? = + -	0-200	Not applicable when the project is in standby mode or the input signal is not locked yet.
HSG/Blue Gain	Hsg.b.gain	? = + -	0-200	Not applicable when the project is in standby mode or the input signal is not locked yet.
HSG/Cyan Gain	hsg.c.gain	? = + -	0-200	Not applicable when the project is in standby mode or the input signal is not locked yet.
HSG/Magenta Gain	hsg.m.gain	? = + -	0-200	Not applicable when the project is in standby mode or the input signal is not locked yet.
HSG/Yellow Gain	Hsg.y.gain	? = + -	0-200	Not applicable when the project is in standby mode or the input signal is not locked yet.
HSG/Red/Saturation	hsg.r.sat	? = + -	0-200	Not applicable when the project is in standby mode or the input signal is not locked yet.
HSG/Green/Saturation	hsg.g.sat	? = + -	0-200	Not applicable when the project is in standby mode or the input signal is not locked yet.
HSG/Blue/Saturation	Hsg.b.sat	? = + -	0-200	Not applicable when the project is in standby mode or the input signal is not locked yet.
HSG/Cyan/Saturation	hsg.c.sat	? = + -	0-200	Not applicable when the project is in standby mode or the input signal is not locked yet.
HSG/Magenta/Saturation	hsg.m.sat	? = + -	0-200	Not applicable when the project is in standby mode or the input signal is not locked yet.

OSD Function	Operation command	Settings/Return Values		Note
HSG/Yellow/Saturation	Hsg.y.sat	? = + -	0-200	Not applicable when the project is in standby mode or the input signal is not locked yet.
HSG/Red/Hue	hsg.r.hue	? = + -	0-200	Not applicable when the project is in standby mode or the input signal is not locked yet.
HSG/Green/Hue	hsg.g.hue	? = + -	0-200	Not applicable when the project is in standby mode or the input signal is not locked yet.
HSG/Blue/Hue	Hsg.b. hue	? = + -	0-200	Not applicable when the project is in standby mode or the input signal is not locked yet.
HSG/Cyan/Hue	hsg.c. hue	? = + -	0-200	Not applicable when the project is in standby mode or the input signal is not locked yet.
HSG/Magenta/Hue	hsg.m. hue	? = + -	0-200	Not applicable when the project is in standby mode or the input signal is not locked yet.
HSG/Yellow/Hue	Hsg.y. hue	? = + -	0-200	Not applicable when the project is in standby mode or the input signal is not locked yet.
HSG/White/Red Gain	hsg.wr.gain	? = + -	0-200	Not applicable when the project is in standby mode or the input signal is not locked yet.
HSG/White/Green Gain	hsg.wg.gain	? = + -	0-200	Not applicable when the project is in standby mode or the input signal is not locked yet.
HSG/White/Blue Gain	Hsg.wb.gain	? = + -	0-200	Not applicable when the project is in standby mode or the input signal is not locked yet.
HSG Reset	hsg.reset		(execute)	Not applicable when the project is in standby mode or the input signal is not locked yet.
Noise Reduction	nr	? = + -	0-3 (Noise Reduction)	Not applicable when the project is in standby mode or the input signal is not locked yet.
Dynamic Black	dblack	? = =	0 = Off 1 = On	Not applicable when the projector is in standby mode.
Freeze	freeze	? = =	0 = Off 1 = On	Not applicable when the projector is in standby mode

Alignment

OSD Function	Operation command	Settings/Return Value		Note
Lens control	zoom.in		(execute)	The Lens control command does not apply when the projector is in standby mode.
Lens control	zoom.out		(execute)	The Lens control command does not apply when the projector is in standby mode.
Lens control	focus.near		(execute)	The Lens control command does not apply when the projector is in standby mode.
Lens control	focus.far		(execute)	The Lens control command does not apply when the projector is in standby mode.
Lens control	lens.up		(execute)	The Lens control command does not apply when the projector is in standby mode.
Lens control	lens.down		(execute)	The Lens control command does not apply when the projector is in standby mode.
Lens control	lens.left		(execute)	The Lens control command does not apply when the projector is in standby mode.
Lens control	lens.right		(execute)	The Lens control command does not apply when the projector is in standby mode.
Lens Type	lens.type	? =	0 = non-UST 1 = UST lens	Not applicable when the project is at below status. <input type="checkbox"/> Standby mode
Lens Memory / Load Memory	lens.load	? =	1-10 set of lens memory (Load)	Not applicable when the project is at below status. <input type="checkbox"/> Standby mode
Lens Memory / Save Memory	lens.save	? =	1-10 set of lens memory (Save)	Not applicable when the project is at below status. <input type="checkbox"/> Standby mode
Lens Memory / Clear Memory	lens.clear	? =	1-10 set of lens memory (Save)	Not applicable when the project is at below status. <input type="checkbox"/> Standby mode
Center Lens	lens.center		(execute)	The Lens control command does not apply when the projector is in standby mode.
Digital Zoom / Digital Zoom	digi.zoom	= ?	0 - 100	Not applicable when the project is in standby mode or the input signal is not locked yet.
Digital Zoom / Digital Pan	digi.pan	= ?	-320 - 320 (depend on input timing; use "op digi.pan ?" to query current setting)	Not applicable when the project is in standby mode or the input signal is not locked yet.
Digital Zoom / Digital Scan	digi.scan	= ?	-200 - 200 (depend on input timing; use "op digi.scan.?" to query current setting)	Not applicable when the project is in standby mode or the input signal is not locked yet.
Digital Zoom / Reset	digi.zoom.rst		(execute)	Not applicable when the project is in standby mode or the input signal is not locked yet.

OSD Function	Operation command	Settings/Return Value	Note
Warp / Keystone H	h.keystone	= ? Horizontal -600 ~ + 600	Not applicable when the project is at below status. <input type="checkbox"/> Standby mode
Warp / Keystone V	v.keystone	= ? Vertical -400 ~ + 400	Not applicable when the project is at below status. <input type="checkbox"/> Standby mode
Warp / Rotation	rotation	= ? -100 ~ +100	Not applicable when the project is at below status. <input type="checkbox"/> Standby mode
Warp / H Pin/Barrel	h.pin.barrel	= ? -150 ~ + 300	Not applicable when the project is at below status. <input type="checkbox"/> Standby mode
Warp/ V Pin/Barrel	v.pin.barrel	= ? -150 ~ + 300	Not applicable when the project is at below status. <input type="checkbox"/> Standby mode
Warp/ Top Left Corner/Horizontal	4corner.ulx	= ? -192 ~+192	Not applicable when the project is at below status. <input type="checkbox"/> Standby mode
Warp/ Top Left Corner/Vertical	4corner.uly	= ? -120 ~+120	Not applicable when the project is at below status. <input type="checkbox"/> Standby mode
Warp/ Top Right Corner/ Horizontal	4corner.urx	= ? -192 ~+192	Not applicable when the project is at below status. <input type="checkbox"/> Standby mode
Warp/ Top Right Corner/ Vertical	4corner.ury	= ? -120 ~+120	Not applicable when the project is at below status. <input type="checkbox"/> Standby mode
Warp/Bottom left Corner/ Horizontal	4corner.llx	= ? -192 ~+192	Not applicable when the project is at below status. <input type="checkbox"/> Standby mode
Warp/Bottom left Corner/ Vertical	4corner.lly	= ? -120 ~+120	Not applicable when the project is at below status. <input type="checkbox"/> Standby mode
Warp/Bottom Right Corner/ Horizontal	4corner.lrx	= ? -192 ~+192	Not applicable when the project is at below status. <input type="checkbox"/> Standby mode
Warp/Bottom Right Corner/ Vertical	4corner.lry	= ? -120 ~+120	Not applicable when the project is at below status. <input type="checkbox"/> Standby mode
Blanking / Top	blanking.top	= ? 0 ~ 360	Not applicable when the project is at below status. <input type="checkbox"/> Standby mode
Blanking / Bottom	blanking.bottom	= ? 0 ~ 360	Not applicable when the project is at below status. <input type="checkbox"/> Standby mode
Blanking / left	blanking.left	= ? 0 ~ 534	Not applicable when the project is at below status. <input type="checkbox"/> Standby mode
Blanking / Right	blanking.right	= ? 0 ~ 534	Not applicable when the project is at below status. <input type="checkbox"/> Standby mode

OSD Function	Operation command		Settings/Return Value	Note
Blanking / Reset	blanking.reset		(execute)	Not applicable when the project is at below status. <input type="checkbox"/> Standby mode
Edge Blend	eb.stat	= ?	0 = Off 1 = On	Not applicable when the project is at below status. <input type="checkbox"/> Standby mode
Edge Blend / Align Pattern	eb.adl	= ?	0 = Off 1 = On	Not applicable when the project is at below status. <input type="checkbox"/> Standby mode
Edge Blend / White Level	eb.top	= ?	0 100~500	Not applicable when the project is at below status. <input type="checkbox"/> Standby mode
Edge Blend / White Level	eb.bottom	= ?	0 100~500	Not applicable when the project is at below status. <input type="checkbox"/> Standby mode
Edge Blend / White Level	eb.left	= ?	0 100~500	Not applicable when the project is at below status. <input type="checkbox"/> Standby mode
Edge Blend / White Level	eb.right	= ?	0 100~500	Not applicable when the project is at below status. <input type="checkbox"/> Standby mode
Edge Blend / Black Level	eb.blu.top	= ?	0 ~ 32	Not applicable when the project is at below status. <input type="checkbox"/> Standby mode
Edge Blend / Black Level	eb.blu.bottom	= ?	0 ~ 32	Not applicable when the project is at below status. <input type="checkbox"/> Standby mode
Edge Blend / Black Level	eb.blu.left	= ?	0 ~ 32	Not applicable when the project is at below status. <input type="checkbox"/> Standby mode
Edge Blend / Black Level	eb.blu.right	= ?	0 ~ 32	Not applicable when the project is at below status. <input type="checkbox"/> Standby mode
Edge Blend / Black Level	eb.all	= ?	0 ~ 32	Not applicable when the project is at below status. <input type="checkbox"/> Standby mode
Edge Blend / Black Level	eb.red	= ?	0 ~ 32	Not applicable when the project is at below status. <input type="checkbox"/> Standby mode
Edge Blend / Black Level	eb.green	= ?	0 ~ 32	Not applicable when the project is at below status. <input type="checkbox"/> Standby mode
Edge Blend / Black Level	eb.blue	= ?	0 ~ 32	Not applicable when the project is at below status. <input type="checkbox"/> Standby mode
Edge Blend / Reset	eb.reset		(execute)	Not applicable when the project is at below status. <input type="checkbox"/> Standby mode

OSD Function	Operation command	Settings/Return Value	Note
Screen Format	screen.format	= 0 = 16:10 ? 1 = 16:9 2 = 4:3	Not applicable when the project is at below status. *Standby mode

CONTROL

OSD Function	Operation command	Settings/Return Values	Note
Language	lang	? = 0 = English 1 = French 2 = Spanish 3 = German 4 = Portuguese 5 = Chinese Simplified 6 = Chinese Traditional 7 = Japanese 8 = Korean	Not applicable when the project is at below status. <input type="checkbox"/> Standby mode
Projection mode	orientation	= 0 = Front ? 1 = Ceiling + Front 2 = Rear 3 = Ceiling + Rear 4 = Auto	Not applicable when the project is in standby mode
Cooling Condition	cooling.condition	= 0 = Front ? 1 = Ceiling + Front 2 = Freetilt 3 = Auto	Not applicable when the project is in standby mode
Altitude	altitude	? = 1 = On 2 = Auto	Not applicable when the project is in standby mode
Auto Power Off	auto.powoff	? = 0 = Off 1 = On	Not applicable when the project is in standby mode
Auto Power On	auto.powon	? = 0 = Off 1 = On	Not applicable when the project is in standby mode
Network/ Standby Power	net.power	= 0 = Off ? 1 = On	Not applicable when the project is in standby mode
Network/DHCP	net.dhcp	? = 0 = Off 1 = On	Not applicable when the project is in standby mode
Network/IP Address	net.ipaddr	? = <string>	Not applicable when the project is in standby mode
Network/Subnet Mask	net.subnet	? = <string>	Not applicable when the project is in standby mode
Network/Gateway	net.gateway	? = <string>	Not applicable when the project is in standby mode
Network/DNS	net.dns	= <string> ?	Not applicable when the project is in standby mode

OSD Function	Operation command	Settings/Return Values	Note
Light Power	laser.mode	? = 0 = Eco Mode 1 = Normal Mode 2 = custom Power Mode	<input type="checkbox"/> Not applicable when the project is in standby mode <input type="checkbox"/> Not applicable when the project is in cooling or lighting up status.
Customer Power Level	laser.power	? = 20-100 Adjust range: 20%-100%	<ul style="list-style-type: none"> • Not applicable when the project is in standby mode • The command is available when Light Power is set to Custom Power Level (laser.mode=2)
Background	no.signal	? = 0 = Logo 1 = Black 2 = Blue 3 = White	Not applicable when the project is in standby mode
Startup Logo	startup.logo	? = 0 = Off 1 = On	Not applicable when the project is in standby mode
Remote Sensor	ir.enable	? = 0 = Off (Disable) 1 = On (Enable)	Not applicable when the project is in standby mode
ID Control Enable	Id.control.enable	? = 0 = Disable 1 = Enable	
Control ID Number	Control.id	? = 0 - 99	ID Control Enable function has to be enabled before setting the number.
Trigger	trig.1	? = 0 = Off 1 = Screen 2 = 5:4 3 = 4:3 4 = 16:10 5 = 16:9 6 = 1.88 7 = 2.35 8 = LetterBox 9 = Source 10 = Native	Not applicable when the projector is in standby mode.
OSD Settings/ Menu Position	osd.menupos	= ? 0 = Top Left 1 = Top Right 2 = Bottom Left 3 = Bottom Right 4 = Center	Not applicable when the project is in standby mode
OSD Settings/ Menu Transparency	osd.trans	= ? 0 = 0% 1 = 25% 2 = 50% 3 = 75%	Not applicable when the project is in standby mode
OSD Settings/ Time Out	osd.timer	= ? 0 = Always On 1 = 10 Seconds 2 = 30 Seconds 3 = 60 Seconds	Not applicable when the project is in standby mode
OSD Settings/ Message Box	osd.msgbox	= ? 0 = Off 1 = On	Not applicable when the project is in standby mode

SERVICE

OSD Function	Operation command	Settings/Return Values		Note
Model	model	?	<String>	Not applicable when the project is in standby mode
Serial Number	ser.no	?	<String>	Not applicable when the project is in standby mode
Software Version	sw.ver	?	<String>	Not applicable when the project is in standby mode
Active Source	act.source	?		Not applicable when the project is in standby mode
Signal format	signal	?	<string>	Not applicable when the project is in standby mode
H Refresh Rate	h.refresh	?	<number>	Not applicable when the project is in standby mode or the input signal is not locked yet.
V Refresh Rate	v.refresh	?	<number>	Not applicable when the project is in standby mode or the input signal is not locked yet.
Pixel Clock	pixel.clock	?	<number>	In unit of MHz
Light Time	laser.hours	?	<number>	Not applicable when the project is in standby mode
Factory Reset	fact.reset		(execute)	

Others

Function	Operation command	Settings/Return Values		Note
Power On	power.on		(execute)	
Power Off	power.off		(execute)	
Projector Status	status	?	0 = Standby 1 = Warm Up 2 = Imaging 3 = Cooling 4 = Error	Not applicable when the Network Standby is set to Off (less 0.5W)
Blank	blank	= ?	0= Disable 1= Enable	Not applicable when the project is in standby mode
Error Detection	errcode	?	<string>	
System Temperature - Ti	ti	?	<number>	Not applicable when the project is in standby mode
System Temperature - Ti2	ti2	?	<number>	Not applicable when the project is in standby mode
System Temperature - Tc	tc	?	<number>	Not applicable when the project is in standby mode
System Temperature - Tb1	tb1	?	<number>	Not applicable when the project is in standby mode
System Temperature - Tb2	tb2	?	<number>	Not applicable when the project is in standby mode

Note: The projector returns string "NA" when the input command does not apply to current projector status or setup.

Simulated IR remote controller commands

This control command simulates the IR remote controller and its control keys. It shares the same syntax of operation command. It begins with characters "ky", followed by control commands and settings separated by space blank [SP], and ended by carriage return pair "CR" and "ASCII hex 0D". Control command syntax:

ky[SP]<operation command>[CR]

Examples:

Power On ky power.on [CR]
Power Off ky power.off [CR]

List of simulated IR remote controller commands

Item	Function	Operation command	Description
1	Power On	power.on	Power On
2	Power Off	power.off	Power Off
3	Menu	menu	Display OSD menu
4	Exit	exit	Exit
5	Enter	enter	ENTER key
6	Up	up	Move cursor upward or change upward
7	Down	down	Move cursor downward or change downward
8	Left	left	Move cursor to the left or change to the left
9	Right	right	Move cursor to the right or change to the right

Control the Projector Through a Network

This machine supports the following methods in remotely controlling the projector through a network:

- Control projector through web browser.
- Control projector with RS-232 control or simulated IR commands via TCP/IP communication protocol.

Cable connection

You may connect the projector to a PC or to an external integrated video and control signal transmission box through LAN for remote control.

Connect the projector to a PC

See figure below for connecting the projector to a PC in RJ-45 cable for control. For connection through LAN, connect the hub through to the projector's HDBaseT/LAN port.

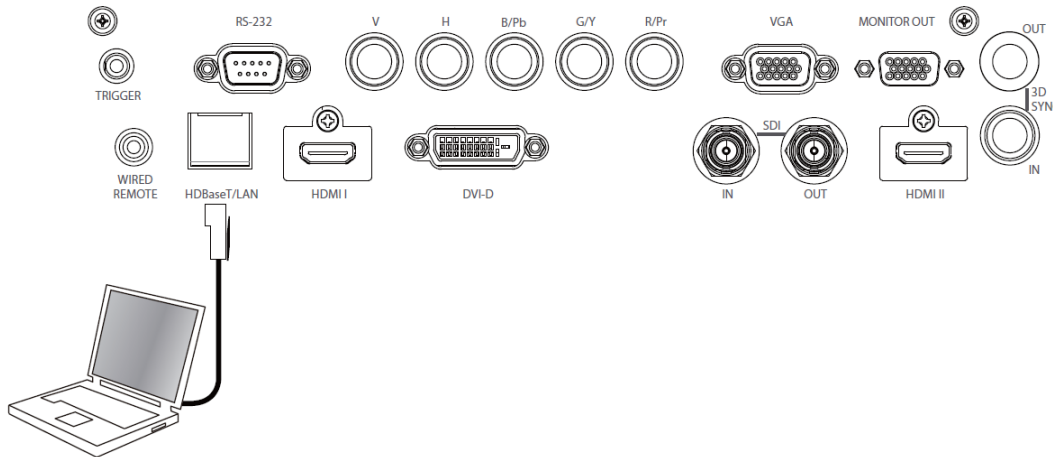

Connect with an external integrated video and control signal transmission box

You may connect the projector to an external integrated video and control signal transmission box with RJ-45 cable for concurrent video and networking control signal transmission. Please connect the PC to the transmission box with one RJ-45 cable or RS-232 cable, then connect the transmission box to the HDBaseT/LAN terminal of the projector by one RJ-45 cable, please refer to below illustration.

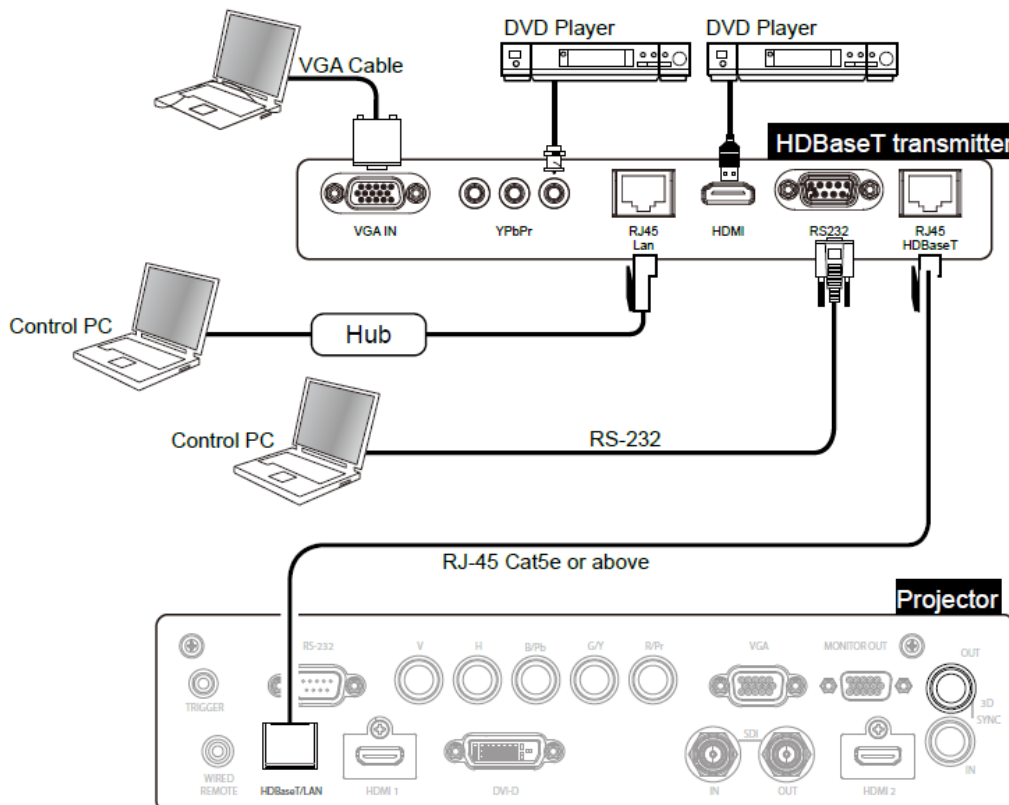

Set up the projector for networking

Before performing projector control by network, please configure the network setting and make sure Standby Power is set to On.

INPUT	PICTURE	ALIGNMENT	CONTROL	SERVICE
Network				
Standby Power			Off	↔/▶
DHCP	172.016.026.197		Off	↔/▶
IP Address	255.255.254.000			
Subnet Mask	255.255.255.000			
Gateway	000.000.000.000			
DNS	000.000.000.000			
MAC Address	00:18:23:00:00:00			
EXIT = Back		Item Adjust ◀▶		Scroll ▲▼

Network Mode: Switch network mode for projector control or service, the default setting is Projector Control.

Projector Control: Switch Network Mode for projector control.

Service: Switch Network Mode for service, the network configuration is changed to default setting for service. Note this option is for firmware update in service only.

Standby Power: Select the standby power consumption option

On: This is highest standby power consumption option for enabling projector control via RS-232 and LAN. Please select this option if you would like to control the projector via Ethernet.

Off: the standby power consumption is kept under 0.5W, RS-232 and network control are turned off

Caution:

Network and RS-232 control are disabled if Standby Power is set to off for reducing the standby power consumption (less 0.5W). Please make sure Standby Power is set to On before controlling the projector via RS-232 or LAN.

DHCP: Enable or disable the DHCP service. When DHCP is set to ON, the DHCP server of the domain will assign an IP address to the projector. The IP address will appear in the IP address window and you don't need to set the IP address. Otherwise, the domain does not or cannot assign any IP address, and 0. 0. 0. 0 is shown on the IP address window.

IP Address: Set DHCP "OFF" and specify an IP address manually. Use the ◀▶ button to select the number in the address to change. Use the ▲▼ button to increase or decrease the number in the IP address.

Subnet Mask: Set the sub mask. The input method is the same as the setting for IP address.

Gateway: Set the gateway. The input method is the same as the setting for IP address.

DNS: Set the DNS. The input method is the same as the setting for IP address.

MAC Address: Show projector's MAC Address.

Caution:

Search DHCP or IP address, it will take the projector several seconds to apply network configuration.

Control the projector through a network

Control the projector through a web browser

Open the web browser of your control PC, type the projector's IP address. The left of the web page shows below four options:

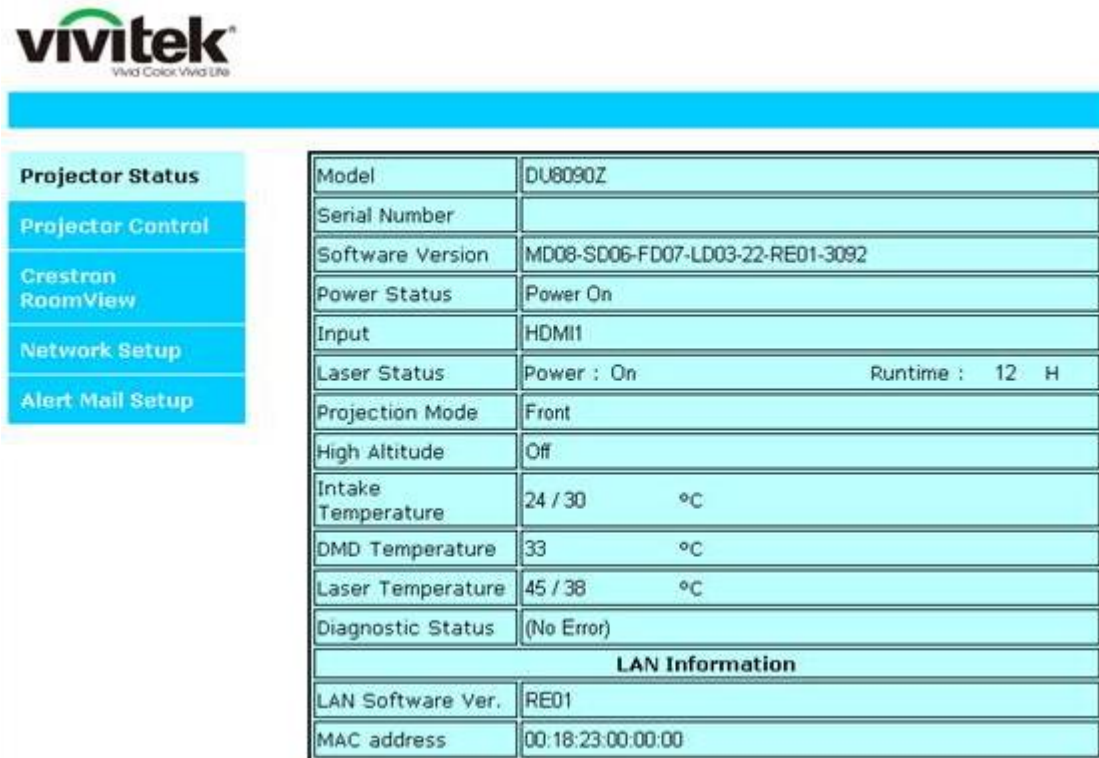

The screenshot shows the Vivitek web interface. On the left, there is a navigation menu with four options: **Projector Status**, **Projector Control**, **Crestron RoomView**, and **Alert Mail Setup**. The **Projector Status** option is selected, displaying a table of projector information.

Model	DU8090Z	
Serial Number		
Software Version	MD08-SD06-FD07-LD03-22-RE01-3092	
Power Status	Power On	
Input	HDMI1	
Laser Status	Power : On	Runtime : 12 H
Projection Mode	Front	
High Altitude	Off	
Intake Temperature	24 / 30	°C
DMD Temperature	33	°C
Laser Temperature	45 / 38	°C
Diagnostic Status	(No Error)	
LAN Information		
LAN Software Ver.	RE01	
MAC address	00:18:23:00:00:00	

Projector Status: Display current projector settings.

Projector Control: This page provides power buttons, input options and Lens control button for the control.

Crestron RoomView: Display Crestron web control page.

Network Setup: Setting for projector link.

Alert Mail Setup: Settings for projector abnormality email reminders. In case of any abnormality the project sends emails to preset users.

Projector Status

This page shows the current status of the projector.

Model	: Projector model name
Software Version	: The version of the software installed in the projector
Power Status	: Current projector startup status
Input	: Display the current input source.
Laser status	: Display current light source status and the usage.
Projection Mode	: Display current projection mode
High Altitude	: Display current High Altitude setting.
Intake Temperature	: Display detected temperature of intake air.
DMD Temperature	: Display detected temperature by the sensor near DMD chip.
Laser Temperature	: Display detected temperature by the sensor on laser module.
Diagnostic Status	: Indicate self-diagnosis message by the projector.

Network control setup message (RJ-45 Version)

LAN Version	: Network control software version number
MAC address	: Projector MAC address setup

Projector Control

This page provides the control buttons for power, blank, Input Selection and Lens control.



Projector Status

Projector Control

Crestron RoomView

Network Setup

Alert Mail Setup

Power

Blank

Input Selection

Lens Control

Zoom	Focus		Shift
<input type="button" value="IN"/>	<input type="button" value="IN"/>		<input type="button" value="Up"/>
		<input type="button" value="Left"/>	<input type="button" value="Right"/>
<input type="button" value="OUT"/>	<input type="button" value="OUT"/>		<input type="button" value="Down"/>

- Power : Projector power on/off control.
- Blank : Interrupt the projection temporarily or start the projection again.
- Input Selection : Select the input source by pressing the buttons.
- Lens Control : Select the button to adjust Zoom, Focus or Lens position.

Creston RoomView

This page shows Creston control page for projector control, the available options are as below options.



Power: Press this button to turn power on or off.

Source List: Switch projector input sources. Press the ▲ or ▼ arrow key to scroll through the dropdown list of available input sources

Image adjust options

Press the ◀ or ▶ arrow key to scroll through available adjustment options.

Freeze: Freeze current projection screen. The projection screen prompts the "Still open" message after the freeze function enabled. Press the Freeze button again to unfreeze the screen.

Contrast: Click this button and the adjustment window displays. Click the ◀▶ arrow keys to adjust contrast.

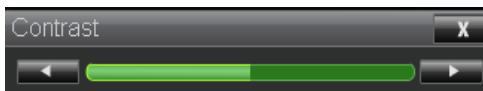

Brightness: Click this button and the adjustment window displays. Click the ◀▶ arrow keys to adjust brightness.

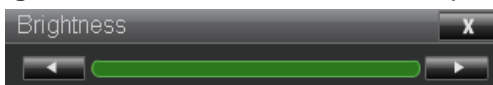

Sharpness: Click this button and the adjustment window displays. Click the ◀▶ arrow key to adjust sharpness.

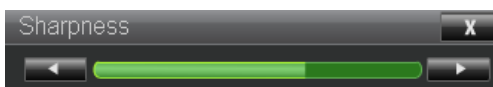

Zoom: Zoom the projection image. Click the "+" key to zoom in and "-" to zoom out. You may click the four arrow keys in the window to move the zoomed projection image.



Control key window

This window simulates keys on the remote controller and control panel.



Enter: Confirm and select function options

Menu: Press to display OSD menu. Press again to exit it.

Auto: Run the auto image adjustment function.

Blank: Pause the image projection, i.e. the projection image is masked. Press again to resume the projection.

Source: The signal source menu displays. Press to display signal source in the projection screen.

Tools: Check Crestron equipment for its setup

Info: Display current projector status and Crestron setup.

Network Setup

This page allows you to configure network setting of the projector.

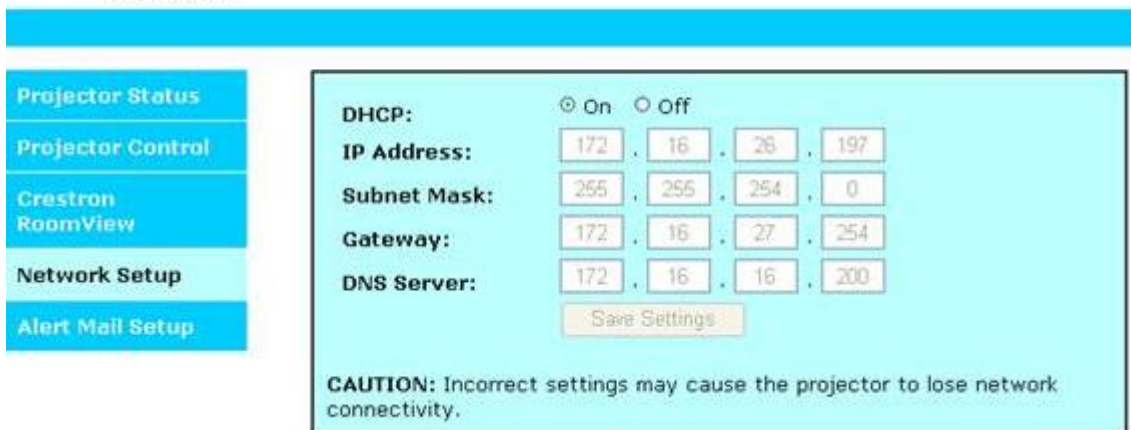
- DHCP** : The DHCP server of the domain will assign an IP address to the projector automatically if DHCP is set to On, otherwise network configuration need to be set manually.
- IP Address** : Input the IP address of the projector.
- Subnet Mask** : Configure the subnet mask.
- Gateway** : Configure the gateway
- DNS Server** : Set the address of DNS server
- Save Setting** : Click the button to confirm the change if any change is made.
Note that current connection is interrupted after change the network settings, please connect the projector again by new network setting.

Alert Mail Setup

This projector can send emails with projector abnormality messages to preset users. Set up the projector before enabling this function:

SMTP Server	: Set up SMTP server name.
Port	: Set up port name.
User Name	: Input user name for the projector to send the reminding message through a SMTP server
Password	: Input password.
E-mail Alert	: Enable or Disable reminding message
From	: Set up sender's email address
To	: Set up receiver's email address
CC	: Set up email address of the email send a copy of a business letter or an e-mail to someone
Projector Name	: Set up projector name or ID.
Location	: Set up projector installation location.
Apply	: Press this button to confirm changes you have made.
Send Test Mail	: Send test email. Press this button to validate email settings after setup is completed.

Control projector with TCP/IP communication protocol

This projector supports TCP/IP communication protocol which enables you to send RS-232 operation commands or simulated IR commands to control projectors connected with RJ45 cable via terminal connection application software, e.g. Tera Term. Please set up IP address and port number with the terminal connection application software before controlling your projector with TCP/IP communication protocol:

IP Address: IP address of projector

Port: Please set transmission port number to 7000

See the section on serial interface RS-232 control commands for details on RS-232 operation commands or simulated IR commands.

About Vivitek Support

If you cannot find solutions from this user guideline, please contact us using the contact information below:

North and Central America

VIVITEK USA

15700 Don Julian Road, Suite B, City of Industry, CA 91745, U.S.A.

General Enquiries: marketing@vivitek.com.tw

Service & Support Enquiries: T.service1@vivitek.com.

Telephone: 1-855-VVK-BEST (1-855-885-2378)

Europe, Middle East and Africa

VIVITEK EMEA

Zandsteen 15, 2132 MZ Hoofddorp, The Netherlands

General Enquiries: support@vivitek.eu

Service & Support Enquiries: support@vivitek.eu

Tel: +31 20 655 0960

ASIA

VIVITEK ASIA

4F, No. 186, Ruey Kuang Road, Neiho, Taipei 11491, Taiwan R.O.C.

General Enquiries: marketing@vivitek.com.tw

Service & Support Enquiries: gary.hsua@vivitek.com.tw

Tel: +886 2 8797 2088

CHINA

VIVITEK CHINA

Cimic Plaza, No. 1090 Shiji Boulevard, Pudong Shanghai, 201209, China

General Enquiries: marketing@vivitek.com.cn

Service & Support Enquiries: service@vivitek.com.cn

Tel: +86-21-5836-0088

INDIA

VIVITEK INDIA

Plot No. 43, Sector – 35, HSIDC, GURGAON – 122001 (Haryana), India

General Enquiries: sales@vivitek.in

Service & Support Enquiries: service@vivitek.in

Tel: +91 124-4874900

TAIWAN

VIVITEK TAIWAN

4F, No. 186, Ruey Kuang Road, Neiho, Taipei 11491, Taiwan R.O.C.

General Enquiries: marketing@vivitek.com.tw

Service & Support Enquiries: kenny.kt.chang@vivitek.com.tw

Tel: +886 2 8797 2088