

vivitek® User Manual

HK2200



FCC Notice

This equipment has been tested and found to comply with the limits for a Class B digital device, pursuant to part 15 of the FCC Rules. These limits are designed to provide reasonable protection against harmful interference in residential installation. This equipment generates, uses and can radiate radio frequency energy and if not installed and used in accordance with the instructions, may cause harmful interference to radio communications. However, there is no guarantee that interference will not occur in a particular installation. If this equipment does cause harmful interference to radio or television reception, detectable by turning the equipment in question off and on, the user is encouraged to try to correct the interference by one or more of the following measures:

- Reorient or relocate the receiving antenna
- Increase the distance between the equipment and the receiver
- Connect the equipment to an outlet on a different circuit than that which the receiver is connected to
- Or consult the dealer or an experienced radio/TV technician for help.

This device complies with Part 15 of the FCC Rules. Operation is subject to following two conditions:

1. This device may not cause harmful interference, and
2. This device must accept any interference that may cause undesired operation.

Safety instructions

Read all of these instructions before you operate your projector and save for future reference.

1. **Read instructions**
All the safety and operating instructions should be read before the appliance is operated.
2. **Notes and warnings**
All notes and warnings in the operating instructions should be adhered to.
3. **Cleaning**
Unplug the projector from the wall socket before cleaning. Use a damp cloth for cleaning the projector housing. Do not use liquid or aerosol cleaners.
4. **Accessories**
Do not place this product on an unstable cart, stand, or table. The product may fall, causing serious damage to the product.
Keep the plastic packing materials (from the projector, accessories and optional parts) out of the reach of children as these bags may result in death by suffocation. Be particularly careful around the small children.
5. **Ventilation**
The projector is equipped with ventilation holes (intake) and ventilation holes (exhaust).
Do not block or place anything near these slots, or internal heat build-up may occur, causing picture degradation or damage to the projector.
6. **Power sources**
Check that the operating voltage of your unit is identical with the voltage of your local power supply.
7. **Servicing**
Do not attempt to service this projector yourself. Refer all servicing to qualified service personnel.
8. **Replacement parts**
When replacement parts are required, be sure that the replacement parts are specified by the manufacture. Unauthorized substitutions may result in fire, electric shock or other hazards.
9. **Moisture Condensation**
Never operate this projector immediately after moving it from a cold location to a warm one. When the projector is exposed to such a change in temperature, moisture may condense on the lens and the crucial internal parts. To prevent the unit from possible damage, do not use the projector for at least 2 hours when there is an extreme or sudden change in temperature.

Notes on the AC Power Cord

AC Power Cord must meet the requirement of countries where you use this projector. Please confirm your AC plug type with the graphics below and ensure that the proper AC Power Cord is used. If the supplied AC Power Cord does not match your AC outlet, please contact your sales dealer. This projector is equipped with a grounding type AC line plug. Please ensure that your outlet fits the plug. Do not defeat the safety purpose of this grounding type plug. We highly recommend using a video source device also equipped with a grounding type AC line plug to prevent signal interference due to voltage fluctuations.

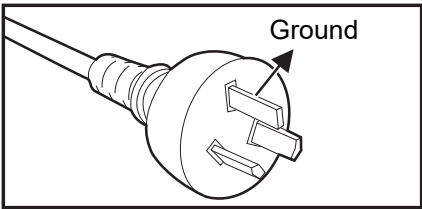

For Australia and Mainland China

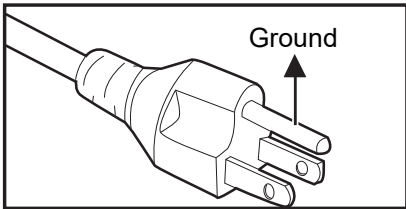

For the U.S.A. and Canada

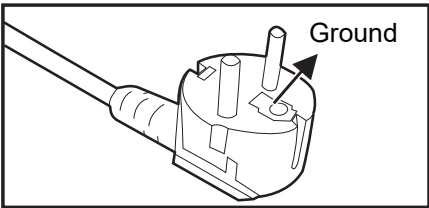

For Continental Europe

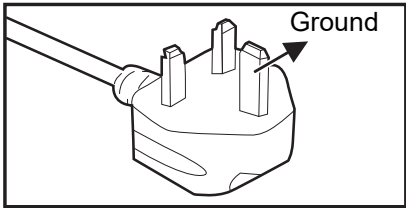

For the U.K.

Table of Contents

Introduction	6
Shipping contents	6
Projector Overview	7
Controls and functions	8
Projector & Remote control	8
Installing the Batteries	10
Remote Control Operation	11
Positioning your projector	12
Choosing a location	12
Obtaining a preferred projected image size	13
Shifting the projection lens	14
Adjusting the Projector Height	15
Adjusting the Projector Focus and Zoom	15
Operation	16
Installing the USB wireless dongle	16
Powering On the Projector	16
Powering Off the Projector	16
Home Screen	17
Connection	18
Connecting to a Wi-Fi Network	19
Screencasting with a Smartphone, Tablet, or PC	20
Screencasting by Mirror Cast	25
Presenting from a Media Player	26
Using the menus	27
Securing the projector	28
Upgrading firmware	30
Menu operation	31
Maintenance	41
Cleaning the Lens	41
Cleaning the Projector Housing	41
Replacing the Lamp	42
Specifications	44
Dimensions	45
Appendix	46
LED Indicator Messages	46
Troubleshooting	49
RS-232 Protocol	50

Introduction

Shipping contents

Carefully unpack and verify that you have all of the items shown below. If any of these items are missing, please contact your place of purchase.

Standard accessories

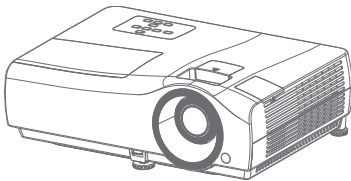

Projector



Remote control



AAA batteries*2

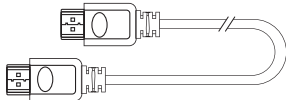

HDMI cable

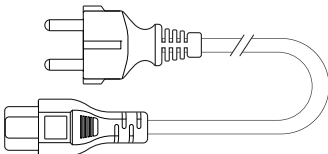

Power cord

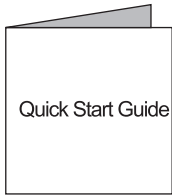

Quick start guide

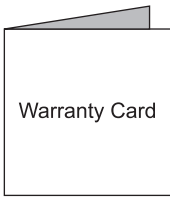

Warranty card

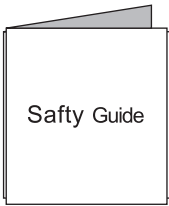

Safety guide

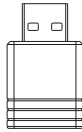

USB Wireless dongle

Projector Overview

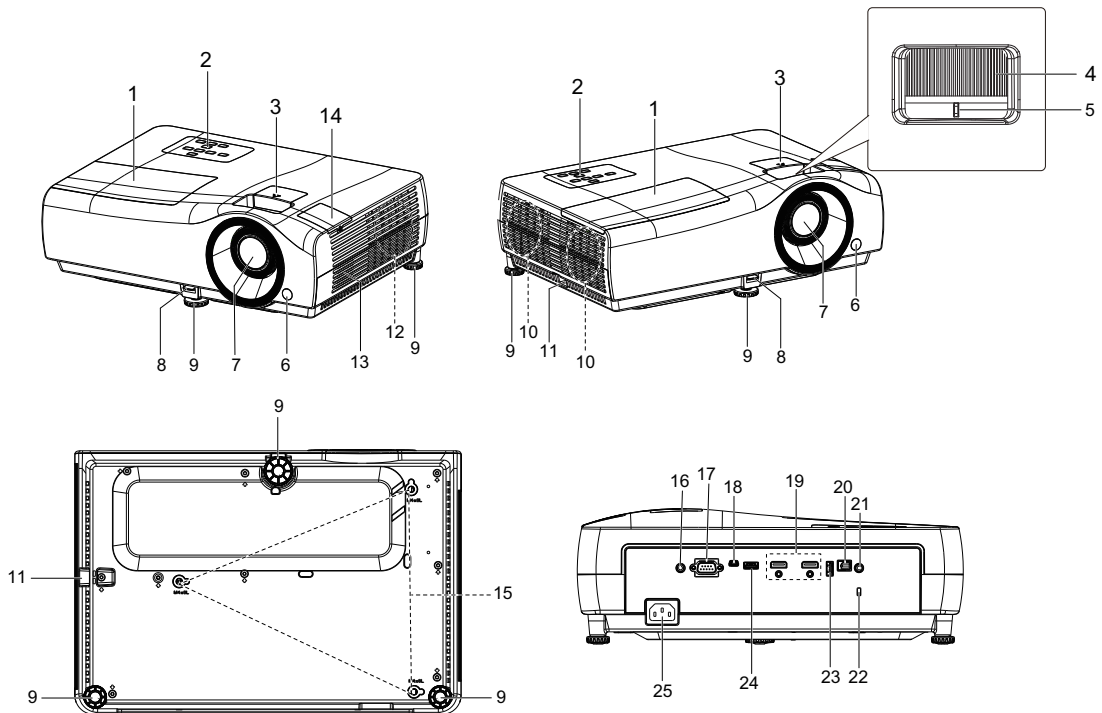







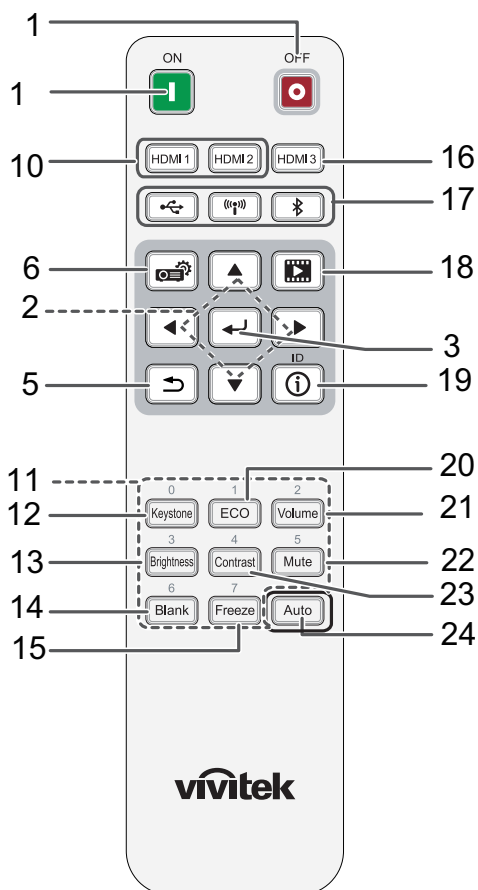
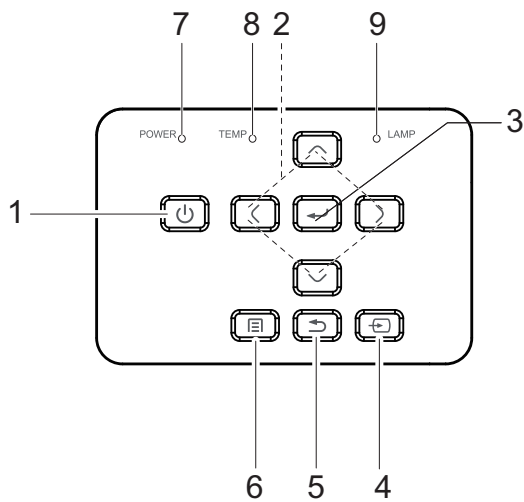

- | | |
|--|--|
| <ul style="list-style-type: none"> 1. Lamp cover 3. Lens shift 5. Zoom ring 7. Projection lens 9. Adjuster feet 11. Security bar 13. Speaker 15. Ceiling mount holes
 17. RS-232 control port
 19. HDMI input ports 21. Audio output jack 23. USB Type-A port (USB 2.0) 25. AC power socket | <ul style="list-style-type: none"> 2. Control panel 4. Focus ring 6. Front IR remote control sensor 8. Quick-release lever 10. Ventilation holes (air exhaust) 12. Ventilation holes (air inlet) 14. Hidden USB wireless dongle port 16. 12V DC output terminal
Triggers external devices such as an electric screen or light control, etc 18. USB Mini-B port (for firmware upgrades) 20. SPDIF output port 22. Kensington anti-theft lock slot 24. USB Type-A port (USB 3.0) |
|--|--|

Controls and functions

Projector & Remote control



1. Power
Turns the projector on and off.
 ON / **OFF**
Turns the projector on and off.
2. Arrow keys (▲/▼/◀/▶)
When the On-Screen Display (OSD) menu is activated, these keys are used as directional arrows to select the desired menu items and to make adjustments.
3. OK
Used to confirm the selection on the menu.
4. Source
Displays the source selection bar.
5. Back
Used to return to the previous layer.
Goes back to previous OSD menu, exits and saves menu settings.
6. Menu
Turns on the On-Screen Display (OSD) menu.
7. Power indicator light
(See "[LED Indicator Messages](#)" on page 46.)
8. Temperature warning light
(See "[LED Indicator Messages](#)" on page 46.)
9. Lamp indicator light
(See "[LED Indicator Messages](#)" on page 46.)
10. HDMI 1/HDMI 2
Selects HDMI 1 or HDMI 2 input source.
11. Number keys
12. Keystone
Displays the Keystone correction menu.
13. Brightness
Displays the setting bars for adjustments of the appropriate brightness values.

- | | |
|---|---|
| <p>14. Blank
Used to hide the screen picture.</p> <p>15. Freeze
Used to freeze/unfreeze the on-screen picture.</p> <p>16. HDMI 3
No function</p> <p>17.  /  / 
  USB: Switch to Media Player source.
  Wi-Fi: Switch to wireless linking.
  Bluetooth: No function</p> <p>18.  Media Player
Accesses projector Home Screen page.</p> | <p>19.  ID
No function</p> <p>20. ECO
Displays the lamp mode selection bar (Normal / ECO / Dynamic ECO).</p> <p>21. Volume
Displays the volume adjustment bar.</p> <p>22. Mute
Toggles projector audio between on and off.</p> <p>23. Contrast
Displays the setting bars for adjustments of the appropriate contrast values.</p> <p>24. Auto
No function</p> |
|---|---|

Installing the Batteries

1. Press and open the battery cover, as illustrated.
2. Remove the old batteries (if applicable) and install two AAA batteries. Make sure that the positive and negative ends are positioned correctly, as illustrated.
3. Replace the battery cover until it clicks into place.

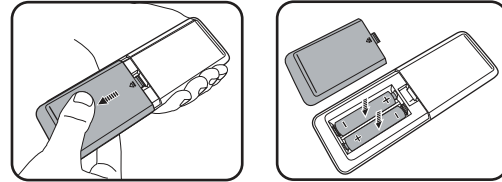

Caution

- ***Risk of explosion if battery is replaced by an incorrect type.***
- ***Dispose of used batteries according to the instructions.***
- ***Make sure the plus and minus terminals are correctly aligned when loading a battery.***



Note

- ***Keep the batteries out of the reach of children. There is a danger of death by accidentally swallowing the batteries.***
- ***Remove batteries from remote control when not using for extended periods.***
- ***Do not dispose of the used batteries along with household waste. Dispose of used batteries according to local regulations.***
- ***Danger of explosion may happen if batteries are incorrectly replaced. Replace all the batteries with new ones.***
- ***Batteries should not be in or near to fire or water, keep batteries in a dark, cool and dry place.***
- ***If suspect battery leakage, wipe out the leakage and then replace new batteries.***
- ***If the leakage adheres to your body or clothes, rinse well with water immediately.***

Remote Control Operation

Point the remote control at the infrared remote sensor and press a button.

- Operating the projector from the front

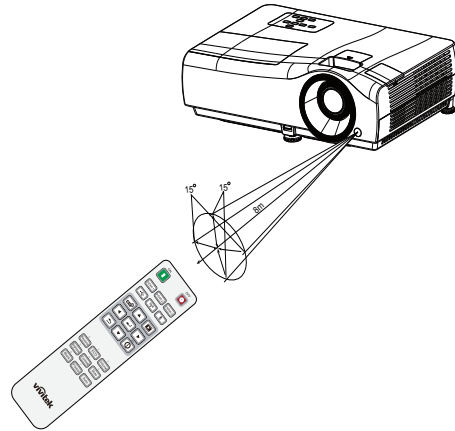

Note

- ***Do not point the laser directly to the people's eyes (especially small children). There is a danger of injury to the eyes.***
- ***The remote control may not operate when there is sunlight or other strong light such as a fluorescent lamp shining on the remote sensor.***
- ***Operate the remote control from a position where the remote sensor is visible.***
- ***Do not drop the remote control or jolt it.***
- ***Keep the remote control out of locations with excessively high temperature or humidity.***
- ***Do not get water on the remote control or place wet objects on it.***
- ***Do not disassemble the remote control.***

Positioning your projector

Choosing a location

Before choosing an installation location for your projector, take the following factors into consideration:

- Size and position of your screen
- Electrical outlet location
- Location and distance between the projector and the rest of your equipment

You can install your projector in the following ways.

1. Front

Select this location with the projector placed on the table in front of the screen. This is the most common way to position the projector for quick setup and portability.

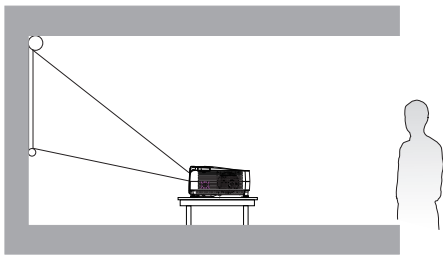

2. Rear

Select this location with the projector placed on the table behind the screen. Note that a special rear projection screen is required.

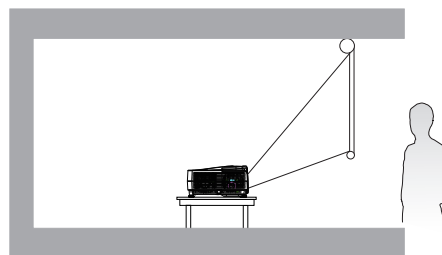

3. Front+Ceiling

Select this location with the projector suspended upside-down in front of the screen. Purchase the Projector Ceiling/Wall Mount Kit from your dealer to mount your projector.

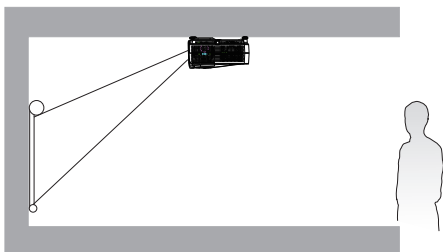

4. Rear+Ceiling

Select this location with the projector suspended upside-down from behind the screen. Note that a special rear projection screen and the Projector Ceiling/Wall Mount Kit are required for this installation location.

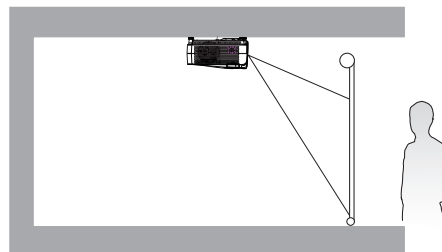

After turning on the projector, go to **SETTINGS Menu > Projection** and press ◀/▶ to select a setting.

Obtaining a preferred projected image size

The distance from the projector lens to the screen, the zoom setting (if available), and the video format each factors in the projected image size.

Projection dimensions

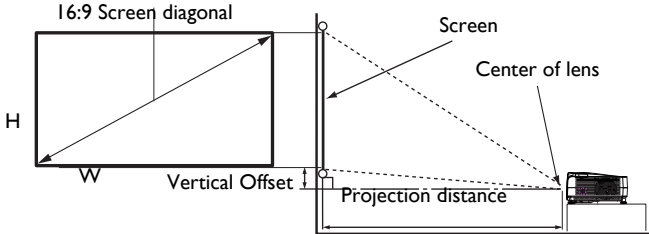

- The screen aspect ratio is 16:9 and the projected picture is in a 16:9 aspect ratio

Screen size				Distance from screen (mm)		
Diagonal		H (mm)	W (mm)	Min length	Average	Max length
Inch	mm			(max. zoom)		(min. zoom)
30	762	374	664	750	863	976
40	1016	498	886	1001	1151	1302
50	1270	623	1107	1251	1439	1627
60	1524	747	1328	1501	1727	1953
70	1778	872	1550	1751	2015	2278
80	2032	996	1771	2001	2302	2603
90	2286	1121	1992	2251	2590	2929
100	2540	1245	2214	2502	2878	3254
110	2794	1370	2435	2752	3166	3580
120	3048	1494	2657	3002	3454	3905
130	3302	1619	2878	3252	3741	4231
140	3556	1743	3099	3502	4029	4556
150	3810	1868	3321	3752	4317	4881
160	4064	1992	3542	4003	4605	5207
170	4318	2117	3763	4253	4893	5532
180	4572	2241	3985	4503	5180	5858
190	4826	2366	4206	4753	5468	6183
200	5080	2491	4428	5003	5756	6509
210	5334	2615	4649	5253	6044	6834
220	5588	2740	4870	5504	6331	7159
230	5842	2864	5092	5754	6619	7485
240	6096	2989	5313	6004	6907	7810
250	6350	3113	5535	6254	7195	8136
260	6604	3238	5756	6504	7483	8461
270	6858	3362	5977	6754	7770	8787
280	7112	3487	6199	7004	8058	9112
290	7366	3611	6420	7255	8346	9437

300	7620	3736	6641	7505	8634	9763
-----	------	------	------	------	------	------

For example, if you are using a 120-inch screen, the recommended projection distance is 3454 mm.

If your measured projection distance is 5000 mm, the closest match in the "[Distance from screen \(mm\)](#)" column is 4893 mm. Looking across this row shows that a 170" (about 4.3 m) screen is required.

Note

- **All measurements are approximate and may vary from the actual sizes. We recommend that if you intend to permanently install the projector, you should physically test the projection size and distance using the actual projector in situ before you permanently install it, so as to make allowance for this projector's optical characteristics. This will help you determine the exact mounting position so that it best suits your installation location.**
- **To optimize your projection quality, we suggest doing the projection by following the values in the non-gray cells.**
- **The values in the gray cells are for reference only.**

Shifting the projection lens

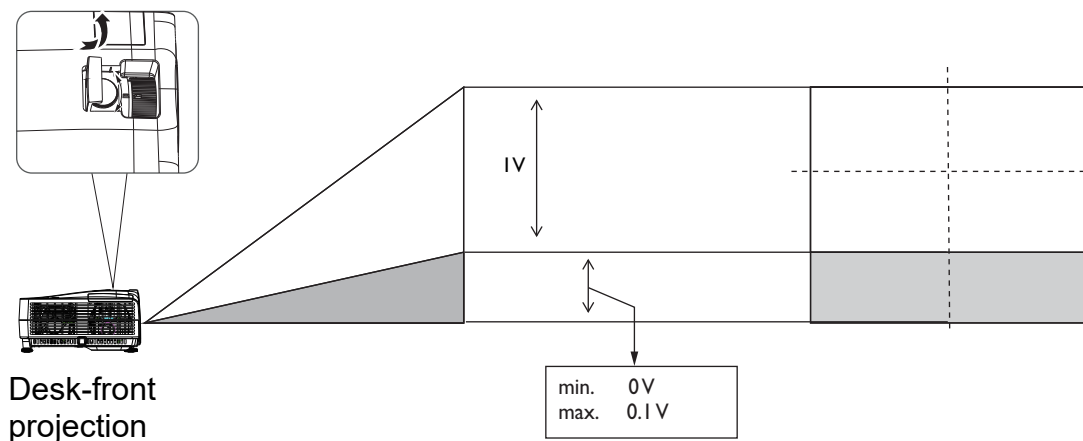

Note

- **Please stop turning the adjustment knob when you hear a clicking sound indicating the knob has reached its limit. Over-turning the knob may cause damage.**

Adjusting the Projector Height

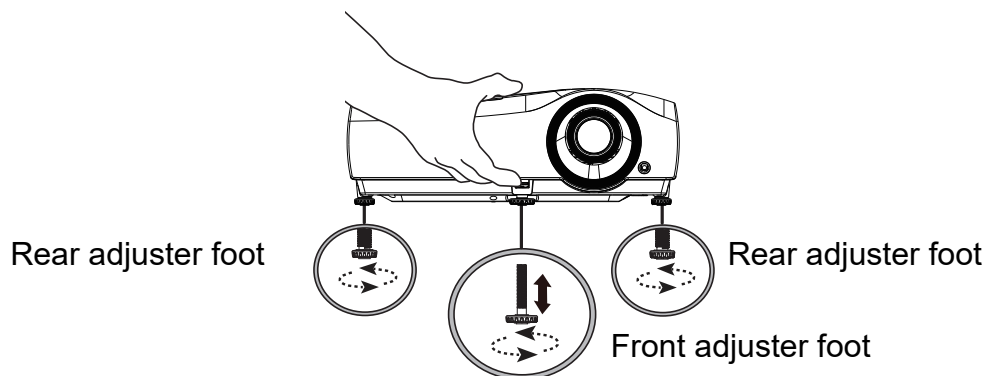

The projector is equipped with 1 front adjuster foot and 2 rear adjuster feet. These adjusters change the image height and projection angle.

1. Pull the quick-release lever and lift the front of the projector. Once the image is positioned where you want it, release the quick-release lever to lock the foot in position. You may also screw the front adjuster foot to change the image height.
 2. Use the rear adjuster foot to fine tune the horizontal angle.
- To retract the foot, screw the adjuster foot in a reverse direction.

Note

- *To avoid damaging the projector, make sure that the adjuster feet are fully retracted before placing the projector in its carrying case.*

Adjusting the Projector Focus and Zoom

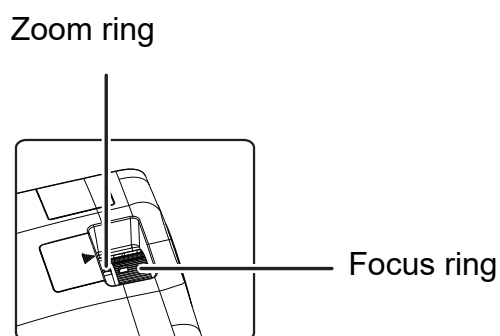

1. Focus the image by rotating the focus ring. A still image is recommended for focusing.
2. Adjust the image size by sliding the zoom ring.



Operation

Installing the USB wireless dongle

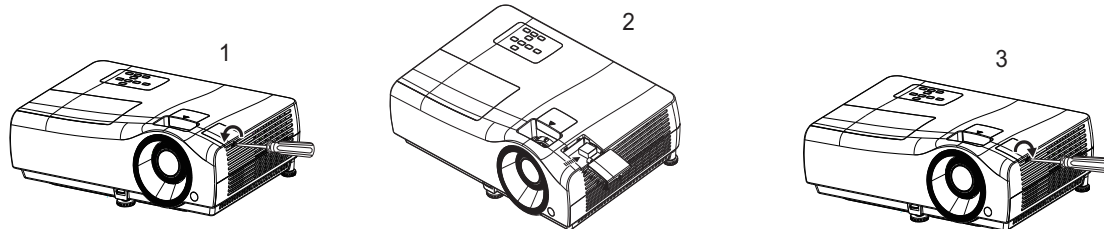
Follow the illustrations below to install the USB wireless dongle. Make sure that the cover is installed back after the USB wireless dongle is plugged. Do not turn the power on with the cover open.



Powering On the Projector



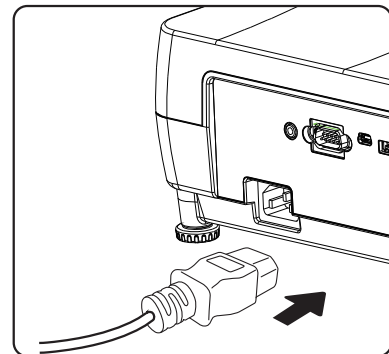



1. Complete the AC power cord and peripheral signal cable(s) connections.
2. Press  on the projector or  **ON** on the remote control to turn on the projector. The projector takes a minute or so to warm up.
3. Turn on your source (computer, notebook, DVD, etc.). The projector automatically detects your source when Auto source setting is ON.
 - If the projector doesn't detect a valid signal, the message 'No Signal' will continue to be displayed.



Warning



- *Never look into the lens when the lamp is on. This can damage your eyes.*
- *This focal point concentrates high temperature. Do not place any object near it to avoid possible fire hazard.*

Powering Off the Projector

1. Press  on the projector or  **OFF** on the remote control to turn off the projector lamp. You will see a message "Power off Please press power again" appear on the screen.
2. Press  on the projector or  **OFF** on the remote control again to confirm.
 - If you want to turn the projector back on, you must wait until the projector has completed the cooling cycle and has entered stand-by mode. Once in stand-by mode, simply press  on the projector or  **ON** on the remote control to restart the projector.
3. Disconnect the AC power cord from the electrical outlet and the projector.
4. Do not turn on the projector right after power off.

Home Screen

Home Screen is the projector's operating system that allows you to choose HDMI input source, media player, AirReceiver, wireless linking, as well as language settings.

When the projector is not projecting an image from a connected source it will display Home Screen by default. If the projector is projecting from a source, you can return to Home Screen page by pressing  or .



The Home Screen page offers the following features:

- **Source List** - Selects input source for Media Player, HDMI1 or HDMI2.
- **AirReceiver** - Allows you to wirelessly cast content from smartphones, tablets, or PCs.
- **Network** - Connects the projector to a wireless network.
- **Mirror Cast** - Allow you to cast content directly from smartphones , tables or PCs which are compatible with Miracast function.

Connection

When connecting a signal source to the projector, be sure to:

1. Turn all equipment off before making any connections.
2. Use the correct signal cables for each source.
3. Ensure the cables are firmly inserted.

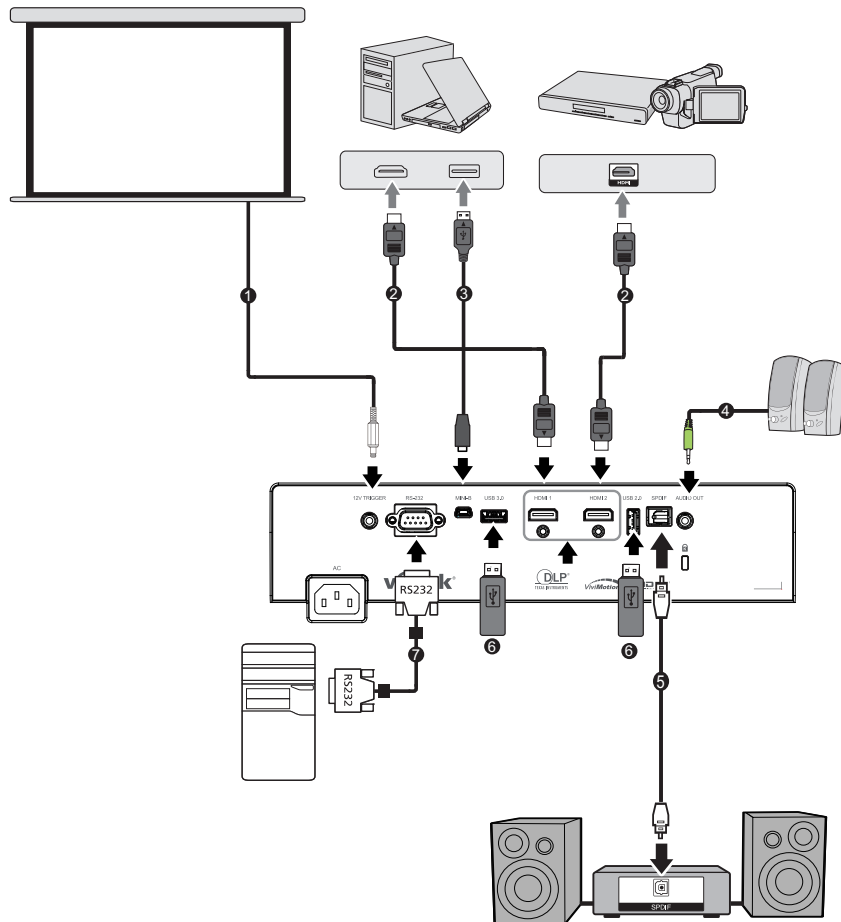

1. 12V Trigger for screen control
2. HDMI cable
3. USB cable (Mini-B to A type)
4. Audio cable
5. SPDIF cable
6. USB Storage Device for Media Player, Firmware Upgrade
7. RS232 cable

Important

- ***In the connections shown above, some cables may not be included with the projector. They are commercially available from electronics stores.***
- ***The connection illustrations above are for reference only. The rear connecting jacks available on the projector vary with each projector model.***
- ***Please check your computer's baud rate at 9600 so that you can connect the projector by using a suitable RS-232 cable.***

Connecting to a Wi-Fi Network

Before you can project wirelessly via the projector you must first connect the projector to a wireless network.

1. Install the USB wireless dongle before using (See 16 page).
2. Power on the projector. See "Powering On the Projector" on page 16.
3. On the Home Screen page interface, select **Network** and press **OK** to access the wireless settings.



4. Turn on the **Wi-Fi** to see available networks.
5. Select the **SSID** for the wireless AP you want to connect to and press **OK**.

Screencasting with a Smartphone, Tablet, or PC

Screencasting allows you to wirelessly cast content from smartphones, tablets, or PCs (using either the iOS, MacOS, Android, or Windows operating systems) that are connected to the same network as the projector by AirReceiver.

Note

- ***Why don't some apps or videos wirelessly cast (or stream) content from my mobile device to the projector?***

While many protocols and apps have been tested to wirelessly cast (or stream) content smoothly to the projector, sometimes there are regional restrictions or compatibility issues for video streaming from a mobile device to the projector. It is recommended to contact your mobile device manufacturer, telecom provider or application developer for compatibility and limitations.

- ***Some live-streaming applications such as Netflix, Amazon Video, etc. do not support screencasting via the the projector.***
- ***DRM protected movies from iTunes do not support screencasting via the the projector.***
- ***AirReceiver and Mirror Cast have been set on by default.***



Screencasting with an iOS Device

1. Power on the projector. See ["Powering On the Projector"](#) on page 16.
2. Connect the projector to a Wi-Fi network. See ["Connecting to a Wi-Fi Network"](#) on page 19.
3. Connect your device to the same Wi-Fi network as the projector.
4. Swipe up from the bottom of the device's screen to access the iOS control console.



5. Tap the **Screen Mirroring** button on the iOS control console.

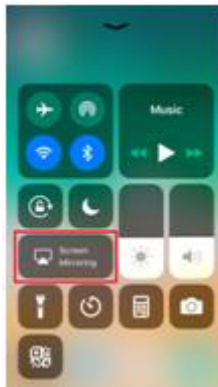

6. In the **Screen Mirroring** menu select the device name "Vivitek".

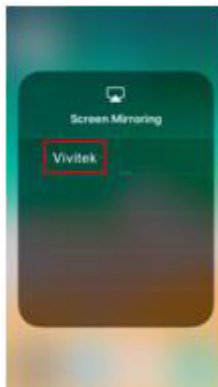

7. Your iOS device's screen will be displayed on the projector.

Screencasting with a MacOS Device

1. Power on the projector. See ["Powering On the Projector"](#) on page 16.
2. Connect the projector to a Wi-Fi network. See ["Connecting to a Wi-Fi Network"](#) on page 19.
3. Connect your device to the same Wi-Fi network as the projector.
4. Open the status menu at the top of the screen and then click the Screen Mirroring button.



5. In the Screen Mirroring menu select the device name "Vivitek".

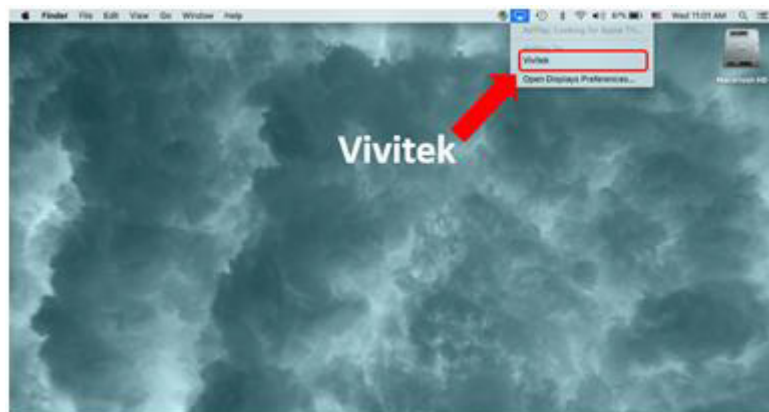

6. Your MacOS device's screen will be displayed on the projector.

Screencasting with an Android Device



1. Power on the projector. See ["Powering On the Projector" on page 16](#).
2. Connect the projector to a Wi-Fi network. See ["Connecting to a Wi-Fi Network" on page 19](#).
3. Connect your device to the same Wi-Fi network as the projector.
4. Launch the wireless casting function on your device.

Note

- **Every Android smartphone/tablet brand uses a different name for their wireless casting feature. Check your device's user manual or call the device's support line to find out the name of your device's casting feature.**

5. In the wireless casting menu select the device name "Vivitek".
6. Your Android device's screen will be displayed on the projector.

Screencasting with a Windows PC

1. Power on the projector. See ["Powering On the Projector" on page 16](#).
2. Connect the projector to a Wi-Fi network. See ["Connecting to a Wi-Fi Network" on page 19](#).
3. Connect your PC to the same Wi-Fi network as the projector.
4. Launch the Chrome web browser  on your PC.
5. Click on the menu button  at the top right corner of the browser window.



6. Select **Cast...** in the Chrome menu.



7. In the **Cast tab** menu select the device name "Vivitek".



8. Select either **Cast tab** cast the browser tab you are viewing, or **Cast desktop** to cast your PC's entire desktop.

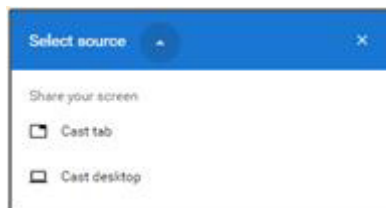

9. Your Windows PC's screen will be displayed on the projector.

Screencasting by Mirror Cast

1. Launch Miracast function on your device.
2. In the casting menu select the device ID name "AirReceiver_ xxxx" for example.
3. Your device's screen will be displayed on the projector directly without Wi-Fi Network.

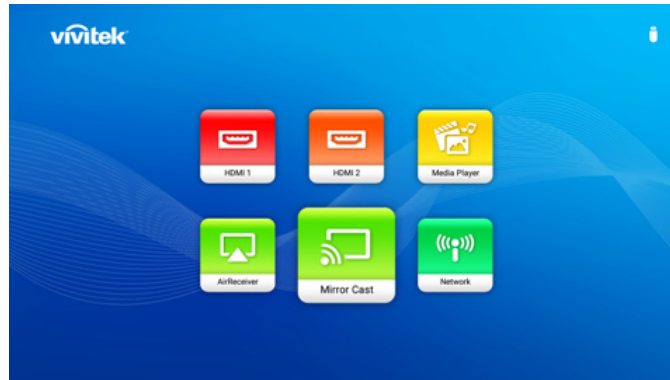

Screencasting Problems

Problem: Unable to find Vivitek in my device's casting list.

1. Ensure that both devices are in the same network and successfully connected
2. Restart AirReceiver on the projector several times (Check AirReceiver > Restart/ Close > RESTART).
3. Change the device's discovery setting and check again (Check AirReceiver > Advanced Setting > Device Discovery Tweaks > Turn Off / On)

Problem: Casting is successful but the display screen is black.

4. Go to AirReceiver > Advanced Settings > Use Hardware (HW) Codec, turn off this feature and check again.

Problem: Unable to find the casting function in your Android smartphone/tablet.

5. The casting function might be located in the device's Setting > Wireless and network section.
6. If you are still unable to find your device's casting function, visit Google Play to download and install a casting application (Example: Google Home). After successfully installing and launching Google Home, select Account from the Menu bar > and choose Mirror device to start casting.









Presenting from a Media Player

The USB port on the projector allows you to browse the image and document files stored on a USB flash drive connected to the projector. It can eliminate the need for a computer source.

Supported files formats

Video format	Audio format	Photo format
<ul style="list-style-type: none">• MPEG1• MPEG4• H.263• Motion JPEG	<ul style="list-style-type: none">• MPEG1/2 Layer1• MPEG1/2 Layer2• FLAC	<ul style="list-style-type: none">• JPEG Base-line• JPEG Progressive• PNG non-interlace• PNG interlace• BMP







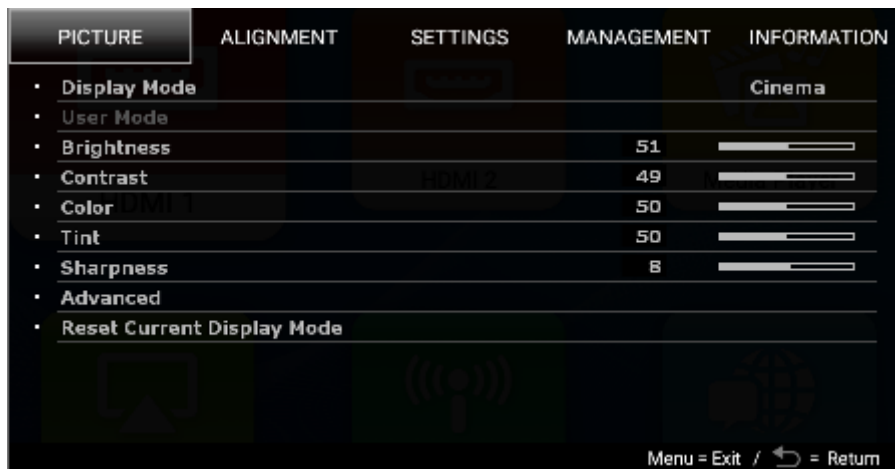

Viewing files

1. Plug a USB flash drive into the **USB** port in the rear of the projector.
2. Press  on the projector and select Media Player or press  on the remote control. The projector displays the built in media reader main page.
3. Press /// to select and press **OK** to enter the sub-folder or display a file.
4. After a file is displayed, press **OK** to call out the function bar. You can press / to select the function and press **OK** to enact the selected item.

Using the menus

The projector has multilingual on-screen display (OSD) menus that allow you to make image adjustments and change a variety of settings.



1. Press  on the projector or  on the remote control to open the OSD menu.
2. When OSD is displayed, use / to select any feature in the main menu.
3. After selecting the desired main menu item, press  to enter sub-menu for feature setting.
4. Use / to select the desired item and adjust the settings with /.
5. To enter the next level of OSD menu, press **OK**.
6. Press **Menu** twice* to leave and save the settings.

*The first press leads you back to the main menu and the second press closes the OSD menu.

Securing the projector

Utilizing the password function

Setting a password

1. Go to **MANAGEMENT** Menu > **Password**. Press **OK**. The password setting page appears.
2. Select **Change Password** and press **OK**.
3. The four arrow keys (▲, ►, ▼, ◀) respectively represent 4 digits (1, 2, 3, 4). According to the password you desire to set, press the arrow keys to enter six digits for the password.
4. Confirm the new password by re-entering the new password. Once the password is set, the OSD menu returns to the **Password** page.
5. To activate the **Power On Lock** function, press ▲/▼ to highlight **Power On Lock** and press ◀/▶ to select **On**. Input the password again.



Note

- *The digits being input will display as asterisks on-screen. Make a note of your selected password and keep it in a safe place in advance or right after the password is entered so that it is available to you should you ever forget it.*
- *Once a password has been set and the power on lock is activated, the projector cannot be used unless the correct password is entered every time the projector is started.*

If you forget the password

If you enter the wrong password, the password error message will appear, and the **Input Current Password** message follows. If you absolutely do not remember the password, you can use the password recall procedure.

If you enter an incorrect password 5 times in succession, the projector will automatically shut down in a short time.

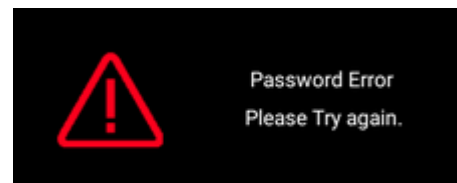

Entering the password recall procedure

1. Press and hold **OK** for 3 seconds. The projector will display a coded number on the screen.
2. Write down the number and turn off your projector.
3. Seek help from the local service center to decode the number. You may be required to provide proof of purchase documentation to verify that you are an authorized user of the projector.

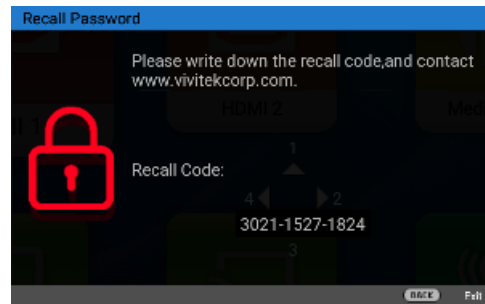

Changing the password

1. Go to **MANAGEMENT Menu > Password > Change Password**.
2. Press **OK**. The message “**Input Current Password**” appears.
3. Enter the old password.
 - If the password is correct, another message “**Input New Password**” appears.
 - If the password is incorrect, the password error message will appear, and the message “**Input Current Password**” appears for your retry. You can press  **BACK** to cancel the change or try another password.
4. Enter a new password.
5. Confirm the new password by re-entering the new password.

Disabling the password function

To disable password protection, go to **MANAGEMENT Menu > Password > Power On Lock** and press **◀/▶** to select **Off**. The message “**Input Current Password**” appears. Enter the current password.

- If the password is correct, the OSD menu returns to the password setting page. You will not have to enter the password next time turning on the projector.
- If the password is incorrect, the password error message will appear, and the message “**Input Current Password**” appears for your retry. You can press  **BACK** to cancel the change or try another password.

Note

- *Though the password function is disabled, you need to keep the old password in hand should you ever need to re-activate the password function by entering the old password.*

Upgrading firmware

1. Go to Vivitek website to download the latest firmware file.
2. Unzip the download file, find and save the file named "update_signed.zip" to the USB flash drive. (Suggest to use the USB flash drive with FAT32 format)
3. Insert USB flash drive into USB port in the rear of the projector.
4. Go to **MANAGEMENT Menu > Firmware Upgrade** menu and press **OK**.

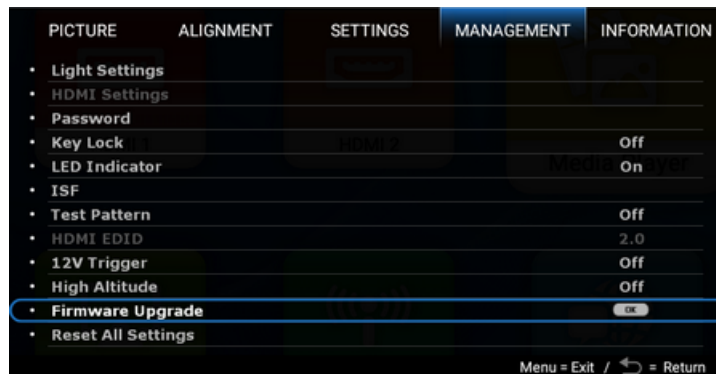
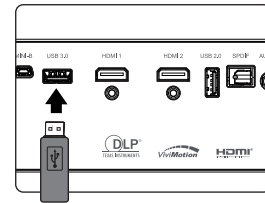

5. Select Yes to upgrade the firmware version. In the process of upgrading, please keep power on until updating finished.
6. When you see this message "Upgrade Sucessfully", firmware upgrade is done.

Menu operation

Note

- Please note that the on-screen display (OSD) menus vary according to the signal type selected and the projector model you are using.
- The menu items are available when the projector detects at least one valid signal. If there is no equipment connected to the projector or no signal detected, limited menu items are accessible.

PICTURE menu

<p>Display Mode</p>	<p>The projector is preset with several predefined picture modes so that you can choose one to suit your operating environment and input signal picture type.</p> <ul style="list-style-type: none"> • Bright: Maximizes the brightness of the projected image. This mode is suitable for environments where extra-high brightness is required, such as using the projector in well lit rooms. • Vivid TV: With well-saturated color, fine-tuned sharpness and a higher brightness level, Vivid TV mode is perfect for watching movies in a living room where there is a small amount of ambient light. • Cinema: Complement with accurate color and deepest contrast at lower brightness level, Cinema mode is suitable for playing movies in an environment with a bit of ambient light, like in living room. • User: Recalls the settings customized based on the current available display modes. See "User Mode" on page 31. • ISF Night: Only available when ISF is enabled. • ISF Day: Only available when ISF is enabled. • Smooth Picture: Hidden as default. Shows only when Smooth Picture is switched on in the ALIGNMENT menu. • 3D: Is appropriate for playing 3D images and 3D video clips. This mode is only available when 3D function is enabled. • HLG: Delivers Hybrid Long Gamma effects by adding a logarithmic curve with extra brightness over the top of the signal. This mode is only available when: ALIGNMENT > HDR is set at Auto, and HLG content is detected.
<p>User Mode</p>	<p>When Display Mode is set to User, you can adjust Bright, Vivid TV, Cinema individually.</p>
<p>Brightness</p>	<p>The higher the value, the brighter the image. Adjust this control so the black areas of the image appear just as black and that detail in the dark areas is visible.</p>
<p>Contrast</p>	<p>The higher the value, the greater the contrast. Use this to set the peak white level after you have previously adjusted the Brightness setting to suit your selected input and viewing environment.</p>
<p>Color</p>	<p>Lower setting produces less saturated colors. If the setting is too high, colors on the image will be overpowering, which makes the image unrealistic.</p>

Tint	The higher the value, the more greenish the picture becomes. The lower the value, the more reddish the picture becomes.
Sharpness	The higher the value, the sharper the picture becomes.
Advanced	<p>Gamma Selection</p> <p>Gamma refers to the relationship between input source and picture brightness. Choose a preferred gamma mode from among 1.8/2.0/2.1/2.2/2.3/2.4/2.5/2.6/User.</p>
	<p>HDR Brightness</p> <p>The projector can automatically adjust the brightness levels of your image according to the input source. You can also manually select a brightness level to display better picture quality. When the value is higher, the image becomes brighter; when the value is lower, the image becomes darker.</p>
	<p>Color Temperature</p> <p>There are several preset color temperature settings available. The available settings may vary according to the signal type selected.</p> <ul style="list-style-type: none"> • Preset: Selects a color temperature from among Normal, Cool, Lamp Native, or Warm. <p>You can also set a preferred color temperature by adjusting the following options.</p> <ul style="list-style-type: none"> • Red Gain/Green Gain/Blue Gain: Adjusts the contrast levels of Red, Green, and Blue. • Red Offset/Green Offset/Blue Offset: Adjusts the brightness levels of Red, Green, and Blue.

**Advanced
(Continued)**

Color Management

This function provides six sets (RGBCMY) of colors to be adjusted. When you select each color, you can independently adjust its range and saturation according to your preference.

- **Primary Color:** Selects a color from among R (Red), G (Green), B (Blue), C (Cyan), M (Magenta), or Y (Yellow).
- **Hue:** Increase in the range will include colors consisted of more proportions of its two adjacent colors. Please refer to the illustration for how the colors relate to each other.
For example, if you select Red and set its range at 0, only pure red in the projected picture will be selected. Increasing its range will include red close to yellow and red close to magenta.

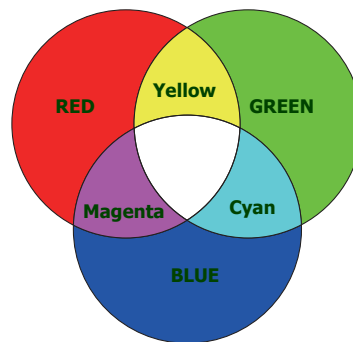

- **Saturation:** Adjusts the values to your preference. Every adjustment made will reflect to the image immediately. For example, if you select Red and set its value at 0, only the saturation of pure red will be affected.

Note

- *Saturation is the amount of that color in a video picture. Lower settings produce less saturated colors; a setting of "0" removes that color from the image entirely. If the saturation is too high, that color will be overpowering and unrealistic.*
- **Gain:** Adjusts the values to your preference. The contrast level of the primary color you select will be affected. Every adjustment made will reflect to the image immediately.

Note

- *When "White" is selected, "Hue/Saturation/Gain" is changed into "Red Gain/Green Gain/Blue Gain."*

Advanced (Continued)	<p>ViviSettings</p> <ul style="list-style-type: none"> • Color Enhancer: Allows you to fine-tune the saturation of colors with larger flexibility. It modulates complex color algorithms to flawlessly render saturated colors, fine gradients, intermediate hues and subtle pigments. • Flesh Tone: Provides a smart adjustment of hue only for calibrating people's skin color, not other colors in the image. It prevents discoloration of skin tones from the light of the projection beam, portraying every skin tone in its most beautiful shade. • ViviPeaking: It is a super-resolution technology which radically enhances Full HD content in terms of colors, contrast, and textures. It's also a Detail Enhancement Technology refines surface details for true-to-life images that pop off the screen. Users can adjust levels of sharpness and detail enhancement for optimal viewing. • ViviMotion: You can use this feature to smooth fast-moving videos by comparing consecutive image frames and inserting an intermediate image frame between them.
	<p>Noise Reduction</p> <p>Reduces electrical image noise caused by different media players.</p>
	<p>ViviBlack</p> <p>Changes the black level of the projected pictures to enhance the effect of contrast ratio.</p>
	<p>Brilliant Color</p> <p>This feature utilizes a new color-processing algorithm and system level enhancements to enable higher brightness while providing truer, more vibrant colors in picture. It enables a greater than 50% brightness increase in mid-tone images, which are common in video and natural scenes, so the projector reproduces images in realistic and true colors.</p>
Reset Current Display Mode	<p>Returns all of the adjustments you've made for the selected Display Mode to the factory preset values.</p>

ALIGNMENT menu



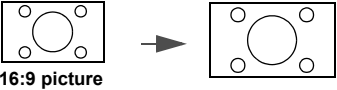
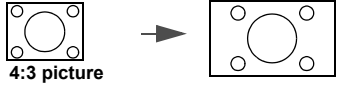
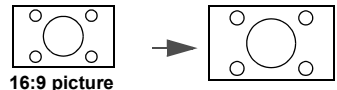
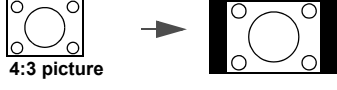

Digital Zoom	<p>Conceals the poor picture quality in the four edges.</p> <p>The greater the value, the more portion of the picture is concealed while the screen remains filled and geometrically accurate. Setting 0 means the picture is 100% displayed.</p>
3D	<p>This projector features a 3D function which enables you to enjoy the 3D movies, videos, and sporting events in a more realistic way by presenting the depth of the images. You need to wear a pair of 3D glasses to view the 3D images.</p> <ul style="list-style-type: none"> • 3D Mode: The default setting is Auto and the projector automatically chooses an appropriate 3D format when detecting 3D contents. If the projector cannot recognize the 3D format, manually choose a 3D mode according to your preference. • 3D Sync Invert: When your 3D image is distorted, enable this function to switch between the image for the left eye and the right eye for more comfortable 3D viewing experience.
HDR	<p>The projector supports HDR imaging sources. It can automatically detect the dynamic range of the source for SDR or HDR10 or HLG, and optimize settings to reproduce contents under wider dynamic range. Meanwhile, the Display Mode cannot be adjusted after switching to HDR.</p>
Smooth Picture	<p>Minimizes the acoustic noise. It is suitable for the need of watching movies that requires an ultra-quiet environment so that you won't be disturbed by the noise of the projector. When this mode is used, the following menu functions will be automatically changed to the designated settings and grayed out.</p> <ul style="list-style-type: none"> • On: To turn on XPR (The display resolution will be 3840 x 2160.) • Off: To turn off XPR (The display resolution will be 1920 x 1080.)



<p>Aspect Ratio</p>	<p>There are several options to set the image's aspect ratio depending on your input signal source.</p> <ul style="list-style-type: none"> • Auto: Scales an image proportionally to fit the projector's native resolution in its horizontal or vertical width.  • Fill: Projects an image as its original resolution and resizes it to fit within the display area.  • 4:3: Scales an image so that it is displayed in the center of the screen with a 4:3 aspect ratio.  • 16:9: Scales an image so that it is displayed in the center of the screen with a 16:9 aspect ratio. 
	<p>Keystone Corrects vertical keystone of the image manually.</p>

SETTINGS menu

Projection	The projector can be installed on a ceiling or behind a screen, or with one or more mirrors. See "Choosing a location" on page 12.
Language	Sets the language for the On-Screen Display (OSD) menus.
Splash Screen	Allows you to select which logo screen will be displayed during projector start-up.
Auto Off Timer	Allows the projector to turn off automatically if no input signal is detected after a set period of time to prevent unnecessary waste of lamp life.
Direct Power On	Allows the projector to turn on automatically once the power is fed through the power cord.
Menu Settings	<ul style="list-style-type: none"> • Menu Position: Sets the On-Screen Display (OSD) menu position. • Menu Display Time: Sets the length of time the OSD will remain active after your last key press. • Message: Sets the reminder messages on or off.
Auto Source	Allows the projector to automatically search for a signal.
Audio Settings	<ul style="list-style-type: none"> • Effect: <ul style="list-style-type: none"> • Mode: This function utilizes MaxxAudio sound enhancement technology, which incorporates Waves's algorithms to deliver great effects of the bass and treble, and provide you with immersive cinematic audio experience. The following preset sound modes are provided: Normal, Cinema, Music, Dynamic, and User. The User mode allows you to personalize the sound settings. When selecting the User mode, you may make manual adjustments with the User Settings function. If the Mute function is activated, adjusting Effect will turn off the Mute function. • User Settings: Select desired frequency bands (100 Hz, 300 Hz, 1k Hz, 3k Hz, and 10k Hz) to adjust the levels according to your preference. The settings made here define the User mode. • Mute: Temporarily turns off the sound. • Volume: Adjusts the sound level. • S/PDIF: Enable or disable S/PDIF. • Reset Audio Settings: All of the adjustments you've done for the Effect menu return to the factory preset values.

MANAGEMENT menu

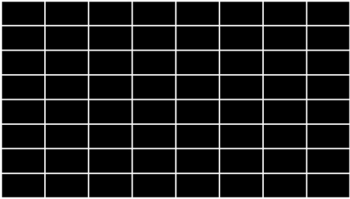
<p>Light Settings</p>	<ul style="list-style-type: none"> • Light Mode: Selects a suitable lamp power from among the provided modes. <ul style="list-style-type: none"> • Normal: Provides full lamp brightness. • ECO: Lowers brightness to extend the lamp life and decreases the fan noise. • Dynamic ECO: Adjusts the lamp power automatically depending on the content brightness level while optimizing display quality. • Reset Light Timer: See "Replacing the Lamp" on page 42. • Light Timer: Displays Light Timer information.
<p>HDMI Settings</p>	<ul style="list-style-type: none"> • HDMI Range Selects a suitable color format to optimize display quality. <ul style="list-style-type: none"> • Auto: Automatically selects a suitable color space and gray level for the incoming HDMI signal. • Full: Utilizes the Full range RGB 0-255. • Limited: Utilizes the Limited range RGB 16-235.
<p>Password</p>	<p>See "Utilizing the password function" on page 28.</p>
<p>Key Lock</p>	<p>With the control keys on the projector and remote control locked, you can prevent your projector settings from being changed accidentally (by children, for example). When the Key Lock is on, no control keys on the projector will operate except  POWER.</p> <p>To release panel key lock, press and hold  (the right key) on the projector or remote control for 3 seconds.</p> <p> Note</p> <ul style="list-style-type: none"> • <i>If you turn off the projector without disabling panel key lock, the projector will still be in locked status the next time it is turned on.</i>
<p>LED Indicator</p>	<p>You can turn off the LED warning lights. This is to avoid any light disturbance when viewing images in a dark room.</p>
<p>ISF</p>	<p>The ISF calibration menu is password protected and only accessible by authorized ISF calibrators. The ISF (Imaging Science Foundation) has developed carefully crafted, industry-recognized standards for optimal video performance and has implemented a training program for technicians and installers to use these standards to obtain optimal picture quality from video display devices. Accordingly, we recommend that setup and calibration be performed by an ISF certified installation technician.</p> <p> Note</p> <ul style="list-style-type: none"> • <i>For more information, go to www.imagingscience.com or contact the dealer or retailer from whom you purchased the projector.</i>

Test Pattern	<p>Adjusts the image size and focus and check that the projected image is free from distortion.</p> 
HDMI EDID	<ul style="list-style-type: none"> • HDMI EDID Switch HDMI EDID between HDMI 1.4 or HDMI 2.0 in order to solve compatibility issue with uncertain old players. <ul style="list-style-type: none"> • 2.0: Enhanced mode can switch to HDMI 2.0 EDID • 1.4: Standard mode can switch to HDMI 1.4 EDID.
12V Trigger	<ul style="list-style-type: none"> • On: If this is selected, the projector will send electronic signal out when it is turned on. • Off: If this is selected, the projector will not send electronic signal out when it is turned on.
High Altitude	<p>We recommend you use the High Altitude when your environment is between 1500 m –3000 m above sea level, and ambient temperature is between 0°C–30°C.</p> <p>Operation under "High Altitude" may cause a higher decibel operating noise level because of increased fan speed necessary to improve overall system cooling and performance.</p> <p>If you use this projector under other extreme conditions excluding the above, it may display auto shut-down symptoms, which is designed to protect your projector from over-heating. In cases like this, you should switch to High Altitude mode to solve these symptoms.</p> <p>However, this is not to state that this projector can operate under any and all harsh or extreme conditions.</p> <p> Note</p> <ul style="list-style-type: none"> • <i>Do not use the High Altitude if your altitude is between 0 m and 1500 m and ambient temperature is between 0°C and 35°C. The projector will be over cooled, if you turn the mode on under such a condition.</i>
Firmware Upgrade	See "Upgrading firmware" on page 30.
Reset All Settings	Returns all settings to the factory preset values.

INFORMATION menu

- **Model Name:** Shows the current model name of your projector.
- **Source:** Shows the current signal source.
- **Resolution:** Shows the native resolution of the input signal.
- **Light Usage Time:** Shows the number of hours the lamp has been used.
- **3D Format:** Shows the current 3D mode.
- **Firmware Version:** Shows the system & DLP versions of your projector.
- **Serial No.:** Shows the serial number of your projector.

Maintenance

The projector needs proper maintenance. You should keep the lens clean as dust, dirt or spots will project on the screen and diminish image quality. If any other parts need replacing, contact your dealer or qualified service personnel. When cleaning any part of the projector, always switch off and unplug the projector first.

Warning

- ***Never open any of the covers on the projector. Dangerous electrical voltages inside the projector can cause severe injury. Do not attempt to service this product yourself. Refer all servicing to qualified service personnel.***

Cleaning the Lens

Gently wipe the lens with lens cleaning paper. Do not touch the lens with your hands.

Cleaning the Projector Housing

Gently wipe with a soft cloth. If dirt and stains are not easily removed, use a soft cloth dampened with water, or water and neutral detergent, and wipe dry with a soft, dry cloth.

Note

- ***Turn off the projector and remove the AC power cord from the power outlet before beginning maintenance work.***
- ***Make sure the lens is cool before cleaning.***
- ***Do not use detergents or chemicals other than those noted above. Do not use benzene or thinners.***
- ***Do not use chemical sprays.***
- ***Use a soft cloth or lens paper only.***

Replacing the Lamp

As the projector operates over time, the brightness of the projector lamp gradually decreases and the lamp becomes more susceptible to breakage. We recommend replacing the lamp if a warning message is displayed. Do not attempt to replace the lamp yourself. Contact the qualified service personnel for replacement.

Note

- ***The lamp is extremely hot right after turning off the projector. If you touch the lamp, you may scald your finger. When you replace the lamp, wait for at least 45 minutes for the lamp to cool down.***
- ***Do not touch the lamp glass at any time. The lamp may explode due to improper handling, including the touching of the lamp glass.***
- ***Lamp lifetime may differ from lamp to lamp and according to the environment of use. There is no guarantee of the same lifetime for each lamp. Some lamps may fail or terminate their lifetime in a shorter period of time than other similar lamps.***
- ***A lamp may explode as a result of vibration, shock or degradation as a result of hours of use as its lifetime draws to an end. Risk of explosion may differ according to the environment or conditions in which the projector and lamp are being used.***
- ***Wear protective gloves and eyeglasses when fixing or detaching the lamp.***
- ***Faster on-off-cycles will damage the lamp and reduce lamp life. Wait at least for 5 minutes to turn off the projector after powering on.***
- ***Do not operate the lamp in proximity to paper, cloth, or other combustible material nor cover it with such materials.***
- ***Do not operate the lamp in an atmosphere containing an inflammable substance, such as thinner.***
- ***Thoroughly ventilate the area or the room when operating the lamp in an oxygen atmosphere (in the air). If ozone is inhaled, it could cause headaches, nausea, dizziness, and other symptoms.***
- ***The inorganic mercury is involved in the lamp. If the lamp bursts, the mercury inside the lamp will be exposed. Leave the area immediately if the lamp shatters while being operated and ventilate the area for at least 30 minutes in order to avoid the inhalation of mercury fumes. Otherwise it could be harmful to user's health.***

1. Turn off the projector.
2. If the projector is installed in a ceiling mount, remove it
3. Unplug the power cord.
4. Use a screwdriver to remove the screw from the cover. (Illustration #1)
Push up and remove the cover. (Illustration #2)
5. Remove the screw from the lamp module. (Illustration #3)
Raise the handle, and lift out the module. (Illustration #4)

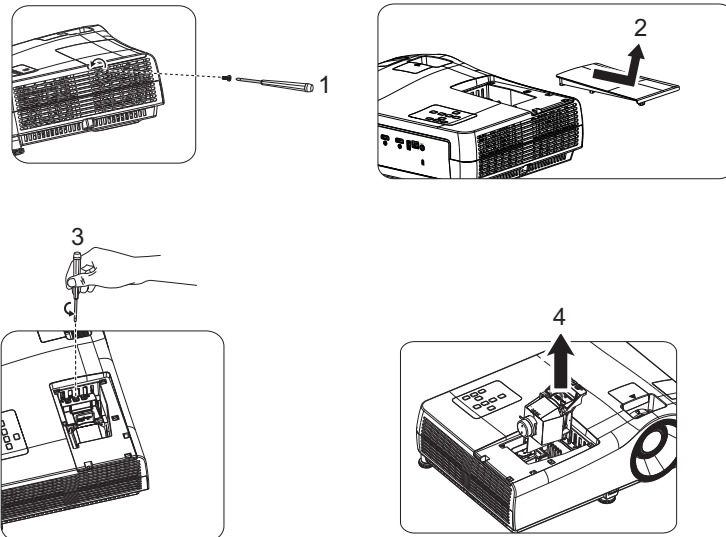

6. Insert the new lamp module into the projector and tighten the screws.
7. Replace the lamp cover and tighten the screw.
8. Turn on the projector. If the lamp does not turn on after the warm-up period, try reinstalling the lamp.
9. Reset the lamp hour. Refer to the “**MANAGEMENT > Light Settings > Reset Light Timer**” menu.

 **Note**

- *Dispose the used lamp according to local regulations.*
- *Ensure that screws are tightened properly. Screws not tightened fully may result in injury or accidents.*
- *Since the lamp is made of glass, do not drop the unit and do not scratch the glass.*
- *Do not reuse the old lamp. This could cause the lamp to explode.*
- *Be sure to turn off the projector and unplug the AC power cord before replacing the lamp.*
- *Do not use the projector with the lamp cover removed.*

Specifications

- All specifications are subject to change without notice.

Model	HK2200
Optical	
Resolution	3840 x 2160 with XPR, 1920 x 1080 without XPR
Display system	1-CHIP DMD
Lens	F = 1.9 ~ 2.47, f = 12 ~ 15.6 mm
Clear focus range	1.2m ~ 5.1m @ Wide, 1.3m ~ 4.9m @ Tele
Lamp	245 W lamp
Zoom ratio	1.3X
Electrical	
Power supply	AC100–240V, 3.60 A, 50–60 Hz (Automatic)
Power consumption	350 W (Max); 0.5 W (Standby)
Mechanical	
Weight	3.7 Kg ± 200 g (8.2 lbs ± 0.44 lbs)
Output terminals	
Speaker	5 watt x 1
Audio signal output	PC audio jack x 1 SPDIF to optical x 1
Control	
USB	Type-A (USB 3.0) x 1 Type-A (USB 2.0) x 1 Mini-B x 1 Type-A (USB 2.0 for wireless dongle) x 1
Trigger for screen control	12V DC x 1
RS-232 serial control	9 pin x 1
IR receiver	x 1
Input terminals	
Video signal input	HDMI (2.0b, HDCP 2.2) x 2
Environmental Requirements	
Operating temperature	0°C–40°C at sea level
Operating relative humidity	10%–90% (without condensation)
Operating altitude	0–1499 m at 0°C–35°C 1500–3000 m at 0°C–30°C (with High Altitude Mode on)
Storage temperature	-20°C–60°C at sea level
Storage humidity	10%–90% RH (without condensation)
Storage altitude	30°C@ 0~12,200m above sea level
Transporting	Original packing or equivalent is recommended

Dimensions

367.3 mm (W) x 254.0 mm (D) x 129.7 mm (H)

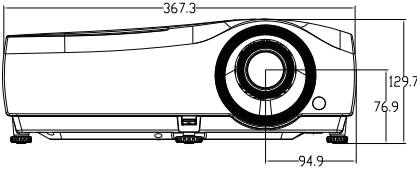
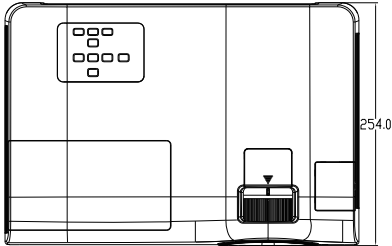

Ceiling mount installation

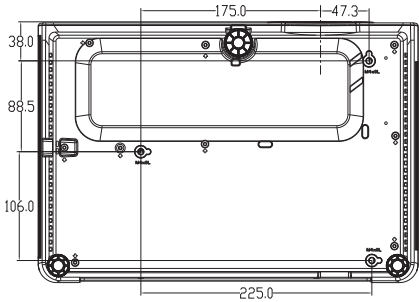





























































Ceiling mount screws:
M4 x 8 (Max. L = 8mm)

Unit: mm

Appendix

LED Indicator Messages

Light			Status & Description
POWER ○	TEMP ○	LAMP ○	
System events			
			System is in stand-by mode
			System is powering up
			System is under normal operation
			System is cooling down
			Downloading
			Colorwheel start fail
			Scaler reset fail
			Lamp life exhausted
			Lamp door is not closed
Burn-In events			
			Burn-in on
			Burn-in off
Lamp events			
			Lamp error in normal operation
			Lamp is not lit up
Thermal events			
			Fan 1 error (the actual fan speed is outside the desired speed)
			Fan 2 error (the actual fan speed is outside the desired speed)
			Fan 3 error (the actual fan speed is outside the desired speed)
			Fan 4 error (the actual fan speed is outside the desired speed)
			Temperature 1 error (over limited temperature)

 : Off	 : Orange On  : Orange Flashing	 : Green On  : Green Flashing	 : Red On  : Red Flashing
---	--	--	--

Compatibility Modes

Supported timing for HDMI (HDCP) input

- PC timings

Resolution	Mode	Vertical Frequency (Hz)	Horizontal Frequency (kHz)	Pixel Frequency (MHz)	Supported 3D format	
					Top Bottom	Side by Side
640 x 480	VGA_60	59.940	31.469	25.175		
	VGA_72	72.809	37.861	31.500		
	VGA_75	75.000	37.500	31.500		
	VGA_85	85.008	43.269	36.000		
720 x 400	720 x 400_70	70.087	31.469	28.3221		
800 x 600	SVGA_60	60.317	37.879	40.000		
	SVGA_72	72.188	48.077	50.000		
	SVGA_75	75.000	46.875	49.500		
	SVGA_85	85.061	53.674	56.250		
	SVGA_120 (Reduce Blanking)	119.854	77.425	83.000		
1024 x 768	XGA_60	60.004	48.363	65.000	V	V
	XGA_70	70.069	56.476	75.000		
	XGA_75	75.029	60.023	78.750		
	XGA_85	84.997	68.667	94.500		
	XGA_120 (Reduce Blanking)	119.989	97.551	115.5		
1152 x 864	1152 x 864_75	75	67.5	108		
1024 x 576@60Hz	Notebook Timing	60.00	35.820	46.996		
1024 x 600@65Hz	Notebook Timing	64.995	41.467	51.419		
1280 x 720	1280 x 720_60	60	45.000	74.250	V	V
1280 x 768	1280 x 768_60	59.870	47.776	79.5	V	V
1280 x 800	WXGA_60	59.810	49.702	83.500	V	V
	WXGA_75	74.934	62.795	106.500		
	WXGA_85	84.880	71.554	122.500		
	WXGA_120 (Reduce Blanking)	119.909	101.563	146.25		
1280 x 1024	SXGA_60	60.020	63.981	108.000	V	V
	SXGA_75	75.025	79.976	135.000		
	SXGA_85	85.024	91.146	157.500		
1280 x 960	1280 x 960_60	60.000	60.000	108	V	V
	1280 x 960_85	85.002	85.938	148.500		
1360 x 768	1360 x 768_60	60.015	47.712	85.500	V	V
1440 x 900	WXGA+_60	59.887	55.935	106.500	V	V
1400 x 1050	SXGA+_60	59.978	65.317	121.750	V	V
1600 x 1200	UXGA	60.000	75.000	162.000	V	V
1680 x 1050	1680 x 1050_60	59.954	65.290	146.250	V	V
640 x 480@67Hz	MAC13	66.667	35.000	30.240		
832 x 624@75Hz	MAC16	74.546	49.722	57.280		
1024 x 768@75Hz	MAC19	75.020	60.241	80.000		
1152 x 870@75Hz	MAC21	75.06	68.68	100.00		
1920 x 1080@60Hz	1920 x 1080_60	60	67.5	148.5	V	V
1920 x 1200@60Hz	1920 x 1200_60 (Reduce Blanking)	59.95	74.038	154	V	V
1920 x 1080@120Hz	1920 x 1080_120 (Only HDMI 2.0 support)	120.000	135.000	297		
3840 x 2160	3840 x 2160_30 For 4K2K model	30	67.5	297		
3840 x 2160	3840 x 2160_60 For 4K2K model (Only HDMI 2.0 support)	60	135	594		

Note

- **The timings showing above may not be supported due to EDID file and VGA graphic card limitations. It is possible that some timings cannot be chosen.**

- Video timings

Timing	Resolution	Horizontal Frequency (kHz)	Vertical Frequency (Hz)	Dot Clock Frequency (MHz)	Supported 3D format		
					Frame Packing	Top Bottom	Side by Side
480i	720 (1440) x 480	15.73	59.94	27			
480p	720 x 480	31.47	59.94	27			
576i	720 (1440) x 576	15.63	50	27			
576p	720 x 576	31.25	50	27			
720/50p	1280 x 720	37.5	50	74.25	V	V	V
720/60p	1280 x 720	45.00	60	74.25	V	V	V
1080/24P	1920 x 1080	27	24	74.25	V	V	V
1080/25P	1920 x 1080	28.13	25	74.25			
1080/30P	1920 x 1080	33.75	30	74.25			
1080/50i	1920 x 1080	28.13	50	74.25			V
1080/60i	1920 x 1080	33.75	60	74.25			V
1080/50P	1920 x 1080	56.25	50	148.5		V	V
1080/60P	1920 x 1080	67.5	60	148.5		V	V
2160/24P	3840 x 2160 (Only HDMI 2.0 support)	54	24	297			
2160/25P	3840 x 2160 (Only HDMI 2.0 support)	56.25	25	297			
2160/30P	3840 x 2160 (Only HDMI 2.0 support)	67.5	30	297			
2160/50P	3840 x 2160 (Only HDMI 2.0 support)	112.5	50	594			
2160/60P	3840 x 2160 (Only HDMI 2.0 support)	135	60	594			

- Color Depth Table

Display format (refresh rate)	Chroma subsampling	8 Bit	10 Bit	12 Bit
4K/60p (60 Hz)	04:04:04	Yes	No	No
	04:02:02	Yes	Yes	Yes
	04:02:00	Yes	Yes	Yes
4K/24p (24 Hz)	04:04:04	Yes	Yes	Yes
	04:02:02	Yes	Yes	Yes
	04:02:00	Yes	Yes	Yes

Troubleshooting

Refer to the symptoms and measures listed below before sending the projector for repairs. If the problem persists, contact your local reseller or service center. Please refer to "LED Indicator Messages" as well.

Start-up problems

If no lights turn on:

- Be sure that the power cord is securely connected to the projector and the other end is plugged into an outlet with power.
- Press the power button again.
- Unplug the power cord and wait for a short while, then plug it in and press the power button again.

Image problems

If the searching source is displayed:

- Press **Source** on the remote control to select an active input source.
- Be sure the external source is turned on and connected.
- For a computer connection, ensure your notebook computer's external video port is turned on. Refer to the computer manual.

If the image is out of focus:

- While displaying the on-screen menu, adjust the focus ring. (The image size should not change; if it does, you are adjusting the zoom, not the focus.)
- Check the projection lens to see if it needs cleaning.

Remote control problems

If the remote control does not operate:

- Be sure nothing is blocking the remote control receiver on the front of the projector. Use the remote control within the effective range.
- Aim the remote control at the screen or at the front or back of the projector.
- Move the remote control so it is more directly in front of or behind the projector and not as far to the side.

RS-232 Protocol

RS-232 Setting

Baud rate:	9600
Parity check:	None
Data bit:	8
Stop bit:	1
Flow control:	None

Examples:

Control items	Input command row	Projector return message
Execute command	reset.all[CR]	RESET.ALL
Query current brightness	op bright ?[CR]	OP BRIGHT =50
Set up brightness	op bright =100[CR]	OP BRIGHT =100
Brightness value + 1	op bright +[CR]	OP BRIGHT ="new value"
Brightness value - 1	op bright -[CR]	OP BRIGHT ="new value"
Out of range or not support	op bright =200[CR]	OP BRIGHT =NA
Illegal command	op abright =100[CR]	*Illegal format#

Function	Type	Operation	Support	ASCII
Power	Write	Power On	Y	op power.on<CR>
	Write	Power off	Y	op power.off<CR>
	Read	Power Status	Y	op standby.power ?<CR>
Source Selection	Write	HDMI 1	Y	op input.sel =0<CR>
	Write	HDMI 2	Y	op input.sel =1<CR>
	Write	Media	Y	op input.sel =2<CR>
	Read	Current source	Y	op input.sel ?<CR>
Display Mode	Write	Bright	Y	op pic.mode =0<CR>
	Write	Vivid TV	Y	op pic.mode =1<CR>
	Write	Cinema	Y	op pic.mode =2<CR>
	Write	User	Y	op pic.mode =3<CR>
	Read	Display Mode	Y	op pic.mode ?<CR>
User Mode	Write	Reset Current Display Mode	Y	op pic.reset<CR>
	Write	Refer Bright	Y	op ref.pic =0<CR>
	Write	Refer Vivid TV	Y	op ref.pic =1<CR>
Color Setting	Write	Refer Cinema	Y	op ref.pic =2<CR>
	Write	Brightness level for customer	Y	op bright =100<CR>
	Read	Brightness value	Y	op bright ?<CR>
	Write	Contrast level for customer	Y	op contrast =100<CR>
	Read	Contrast value	Y	op contrast ?<CR>
	Write	Color level for customer	Y	op color =100<CR>
	Read	Color value	Y	op color ?<CR>
	Write	Tint level for customer	Y	op tint =100<CR>
	Read	Tint value	Y	op tint ?<CR>
	Write	Sharpness level for customer	Y	op sharp =0<CR>
	Read	Sharpness value	Y	op sharp ?<CR>
	Write	Gamma 1.8	Y	op gamma =0<CR>
	Write	Gamma 2.0	Y	op gamma =1<CR>
	Write	Gamma 2.1	Y	op gamma =2<CR>
	Write	Gamma 2.2	Y	op gamma =3<CR>
	Write	Gamma 2.3	Y	op gamma =4<CR>
	Write	Gamma 2.4	Y	op gamma =5<CR>
	Write	Gamma 2.5	Y	op gamma =6<CR>
	Write	Gamma 2.6	Y	op gamma =7<CR>
	Write	Gamma User (TBD)	Y	op gamma =8<CR>
	Write	Color Temperature - Normal	Y	op color.temp =0<CR>
	Write	Color Temperature - Warm	Y	op color.temp =1<CR>
	Write	Color Temperature - Cool	Y	op color.temp =2<CR>
	Write	Color Temperature - Lamp Native	Y	op color.temp =3<CR>
	Read	Color Temperature Status	Y	op color.temp ?<CR>
	Write	Color Temperature - Red Gain	Y	op red.gain =100<CR>
	Read	Color Temperature - Red Gain value	Y	op red.gain ?<CR>
	Write	Color Temperature - Green Gain	Y	op green.gain =100<CR>
	Read	Color Temperature - Green Gain value	Y	op green.gain ?<CR>
	Write	Color Temperature - Blue Gain	Y	op blue.gain =100<CR>
	Read	Color Temperature - Blue Gain value	Y	op blue.gain ?<CR>
	Write	Color Temperature - Red Offset	Y	op red.offset =100<CR>
	Read	Color Temperature - Red Offset value	Y	op red.offset ?<CR>
	Write	Color Temperature - Green Offset	Y	op green.offset =100<CR>
	Read	Color Temperature - Green Offsetvalue	Y	op green.offset ?<CR>
	Write	Color Temperature - Blue Offset	Y	op blue.offset =100<CR>
	Read	Color Temperature - Blue Offset value	Y	op blue.offset ?<CR>
	Write	Color Management - Red Gain	Y	op hsg.r.gain =100<CR>
	Write	Color Management - Red/Hue	Y	op hsg.r.hue =100<CR>
	Write	Color Management - Red/Saturation	Y	op hsg.r.sat =100<CR>
	Write	Color Management - Green Gain	Y	op hsg.g.gain =100<CR>
	Write	Color Management - Green/Hue	Y	op hsg.g.hue =100<CR>
	Write	Color Management - Green/Saturation	Y	op hsg.g.sat =100<CR>
	Write	Color Management - Blue Gain	Y	op hsg.b.gain =100<CR>
	Write	Color Management - Blue/Hue	Y	op hsg.b.hue =100<CR>
	Write	Color Management - Blue/Saturation	Y	op hsg.b.sat =100<CR>
	Write	Color Management - Cyan Gain	Y	op hsg.c.gain =100<CR>
Write	Color Management - Cyan/Hue	Y	op hsg.c.hue =100<CR>	
Write	Color Management - Cyan/Saturation	Y	op hsg.c.sat =100<CR>	

Color Setting	Write	Color Management - Magenta Gain	Y	op hsg.m.gain =100<CR>
	Write	Color Management - Magenta/Hue	Y	op hsg.m.hue =100<CR>
	Write	Color Management - Magenta/Saturation	Y	op hsg.m.sat =100<CR>
	Write	Color Management - Yellow Gain	Y	op hsg.y.gain =100<CR>
	Write	Color Management - Yellow/Hue	Y	op hsg.y.hue =100<CR>
	Write	Color Management - Yellow/Saturation	Y	op hsg.y.sat =100<CR>
	Write	ViviSettings - Color Enhancer	Y	op color.en =8<CR>
	Write	ViviSettings - Flesh Tone	Y	op flesh.t =0<CR>
	Write	ViviSettings - ViviPeaking	Y	op vivi.peaking =0<CR>
	Write	ViviSettings - ViviMotion	Y	op vivi.motion =0<CR>
	Write	Noise Reduction	Y	op noise.r =0<CR>
	Write	ViviBlack	Y	op vivi.black =0<CR>
	Write	Brilliant color	Y	op bri.color =1<CR>
	Read	Brilliant color status	Y	op bri.color ?<CR>
	Picture	Write	Digital Zoom	Y
Write		3D Auto	Y	op threed.format =0<CR>
Write		3D Sync Top Bottom	Y	op threed.format =1<CR>
Write		3D Sync Side by side	Y	op threed.format =2<CR>
Write		3D Off	Y	op threed.format =3<CR>
Read		3D Status	Y	op threed.format ?<CR>
Write		3D inverter	Y	op threed.syncinvert =1<CR>
Write		HDR	Y	op hdr.control =1<CR>
Write		Quietest	Y	op quietest =1<CR>
Write		Aspect Auto	Y	op aspect =0<CR>
Write		Aspect real	Y	op aspect =1<CR>
Write		Aspect 4:3	Y	op aspect =2<CR>
Write		Aspect 16:9	Y	op aspect =3<CR>
Read		Aspect Status	Y	op aspect ?<CR>
Settings		Write	Keystone vertical	Y
	Write	Projector Position-Front	Y	op projection =0<CR>
	Write	Projector Position-Front+Ceiling	Y	op projection =1<CR>
	Write	Projector Position-Rear	Y	op projection =2<CR>
	Write	Projector Position-Rear+Ceiling	Y	op projection =3<CR>
	Read	Projector Position Status	Y	op projection ?<CR>
	Write	Language	Y	op lang =0<CR>
	Write	splash screen	Y	op splash.screen =0<CR>
	Write	Auto Off Timer	Y	op sleep.timer =0<CR>
	Write	Direct Power On	Y	op direct.poweron =1<CR>
	Read	Direct Power On-Status	Y	op direct.poweron ?<CR>
	Write	Menu Position	Y	op menu.position =0<CR>
	Write	Menu Display Time	Y	op menu.timer =0<CR>
	Write	Message	Y	op message =0<CR>
	Audio Settings	Write	Auto Source	Y
Write		Mute On	Y	op mute =1<CR>
Write		Mute Off	Y	op mute =0<CR>
Read		Mute Status	Y	op mute ?<CR>
Write		Volume level for customer	Y	op volume =0<CR>
Read		Volume Status	Y	op volume ?<CR>
Write		S/PDIF ON	Y	op spdif =1<CR>
Read		S/PDIF Status	Y	op spdif ?<CR>
Write		Sound Mode : Nromal	Y	op sound.mode =0<CR>
Write		Sound Mode : Cinema	Y	op sound.mode =1<CR>
Write		Sound Mode : Music	Y	op sound.mode =2<CR>
Write		Sound Mode : Dynamic	Y	op sound.mode =3<CR>
Write		Sound Mode : User	Y	op sound.mode =5<CR>
Write		User EQ - 100Hz	Y	op UserEQ.100hz =10<CR>
Read		User EQ - 100Hz	Y	op UserEQ.100hz ?<CR>
Write		User EQ - 300Hz	Y	op UserEQ.300hz =10<CR>
Read		User EQ - 300Hz	Y	op UserEQ.300hz ?<CR>
Write		User EQ - 1kHz	Y	op UserEQ.1khz =10<CR>
Read		User EQ - 1kHz	Y	op UserEQ.1khz ?<CR>
Write		User EQ - 3kHz	Y	op UserEQ.3khz =10<CR>
Read	User EQ - 3kHz	Y	op UserEQ.3khz ?<CR>	
Write	User EQ - 10kHz	Y	op UserEQ.10khz =10<CR>	
Read	User EQ - 10kHz	Y	op UserEQ.10khz ?<CR>	

	Write	Reset Audio Settings	Y	op audio.reset<CR>
Light Settings	Write	Normal mode	Y	op light.mode =0<CR>
	Write	ECO mode	Y	op light.mode =1<CR>
	Write	Dynamic ECO mode	Y	op light.mode =2<CR>
	Read	Light Mode Status	Y	op light.mode ?<CR>
	Write	Light Timer Reset	Y	op light1.reset<CR>
	Read	Light Timer	Y	op light1.hours ?<CR>
Management	Write	HDMI Settings	Y	op hdmi.range =0<CR>
	Write	Change New password & Power on lock =	Y	op security.lock =<CR>
	Write	Remove psaaword & Power on lock = off	Y	op security.unlock =<CR>
	Write	Key lock	Y	op keypad.lock =0<CR>
	Write	LED Indicator	Y	op led =0<CR>
	Write	Test Pattern	Y	op test.pattern =0<CR>
	Write	12V Trigger	Y	op trigger =0<CR>
	Write	High Altitude mode off	Y	op fanspeed =0<CR>
	Write	Firmware Upgrade	Y	op fwupgrade<CR>
Write	Reset all settings	Y	op reset.all<CR>	
Miscellaneous	Read	Model Name	Y	op model ?<CR>
	Read	Eco Blank Status	Y	op ecoblank ?<CR>
	Write	Eco Blank	Y	op ecoblank =1<CR>
	Write	Freeze	Y	op Freeze =1<CR>
	Read	Freeze Status	Y	op Freeze ?<CR>
	Write	Menu On/Off	Y	op menu<CR>
	Write	Back	Y	op back<CR>