



User Manual

用戶手冊

用戶手冊

Manual del usuario

Manuel de l'utilisateur

Benutzerhandbuch

Руководство пользователя

Manuale d'uso

ユーザーマニュアル

Preface

Copyright

©2016 Vivitek **vivitek**[®] is a trademark of Delta Electronics, Inc. All other trademarks are the property of their respective owners. All values, weights and sizes in this Manual are approximate values. Specifications are subject to change without notice.

Disclaimer

The information in this document is subject to change without notice. The manufacturer makes no representations or warranties with respect to the contents hereof and specifically disclaims any implied warranties of merchantability or fitness for any particular purpose. The manufacturer reserves the right to revise this publication and to make changes from time to time in the content hereof without obligation of the manufacturer to notify any person of such revision or changes.

Trademark Recognition



HDMI, the HDMI Logo, and High-Definition Multimedia Interface are trademarks or registered trademarks of HDMI Licensing LLC in the United States and other countries.



Important Safety Information

Important:

It is strongly recommended that you read this section carefully before using Qumi. These safety and usage instructions that will make sure you enjoy many years of safe use of Qumi. Keep this manual for future reference.

Symbols Used

Warning symbols are used on the unit and in this manual to alert you of hazardous situations.

The following symbols are used to call attention to important information.

Note:

Provides additional information on the topic at hand



Important:

Provides additional information that should not be overlooked.



Caution:

Alerts you to situations that may damage the unit..



Warning:

Alerts you to situations that may damage the unit, create a hazardous environment, or cause personal injury..

Throughout this manual, component parts and items in the OSD (On-Screen Display) menus are denoted in bold font as in this example:

“Press the **Menu** button on the remote controller to open the **Setting** menu”.

General Safety Information

- Do not open the casing. There are no user-maintainable parts inside the . For any maintenance, please contact a qualified service technician.
- Follow all warnings and precautions on the machine or in this Manual.
- According to its design, the projection light source is extremely bright. To avoid harm to eyes, do not look straight at the lens when the LED is ON.
- Do not place the machine on unstable surface or stand.
- Avoid using the system near water, in direct sunlight, or near a heating device.
- Do not place any heavy objects (e.g., books or bags) on the unit..



Qumi Installation Notice

- Allow at least a 500mm clearance around the exhaust vent.

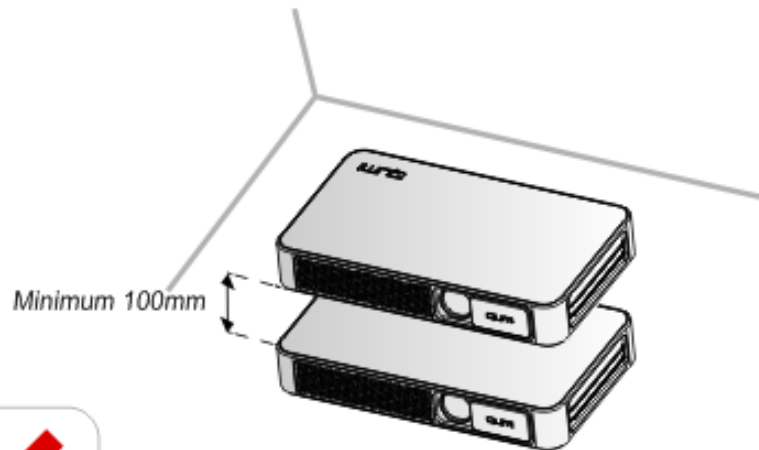

- Make sure that the intake vents do not recycle hot air from the exhaust vent.
- When operating Qumi in an enclosed space, make sure that the surrounding air temperature within the enclosure does not exceed operating temperature while Qumi is running, and the air intake and exhaust vents are unobstructed.
- All enclosures should pass a certified thermal evaluation to make sure that Qumi does not recycle exhaust air, as this may cause the device to shutdown even if the enclosure temperature is within the acceptable operating temperature range.



Caution:
Avoid usage of Qumi in dusty environment.



Power Supply Safety

- Only use the supplied adapter.
- Do not place anything on the cord. Place the cord where it will not be in the way of foot traffic.
- Remove the battery from the remote control when storing or not in use for a prolonged period.

Cleaning Qumi

- Before cleaning, disconnect the power supply cables. See “*Cleaning Qumi*” in Page 37.

Note:

Qumi will be warm after usage. Allow Qumi to cool down before storing in a compartment.

Control Warning

Before installing and using Qumi, read the regulatory notices in the [Regulatory Compliance](#) on page 48.

Symbol Explanations



DISPOSAL: Do not use household or municipal waste collection services for disposal of electrical and electronic equipment. EU countries require the use of separate recycling collection services.

Main Features

- HD720p resolution with a 16:9 aspect ratio.
- Up to 500 lumens of brightness and 5,000:1 contrast for brilliant and sharp images.
- Project a large 100” (diameter) high definition image from only 3.7 meters from the projection surface.
- Long life energy efficient LED light source with an estimated 30,000 hours of operation.
- Wirelessly stream and project documents, photos, movies and other content with the integrated wireless system.
- Built-in audio speakers with audio-out port and for attachment of external speakers.

About this Manual

This manual is intended for end users and describes how to install and operate Qumi. Wherever possible, relevant information—such as an illustration and its description—has been kept on one page. This printer-friendly format is both for your convenience and to help save paper, thereby protecting the environment. It is suggested that you only print sections that are relevant to your needs.



Table of Contents

Preface	ii
Chapter 1 At a Glance	1
Overview	1
Standard Accessories:	3
Remote Control	4
Setting Up the Remote Control	5
Chapter 2 Getting Started	6
What you need	6
Setting Up Qumi	7
HappyCast - Android Setup	12
HappyCast - iOS Setup	13
Chapter 3 Qumi User Interface.....	15
Views	15
Photo	16
Video	17
Music	18
Document	19
APP Store	20
Browser	21
Apps	22
WiFi	23
Settings.....	24
Chapter 4 On-Screen Display (OSD) Settings	25
OSD Menu Controls.....	25
OSD Menu Overview	26
OSD Language Settings.....	27
Chapter 5 Taking Care of Your Qumi.....	37
Cleaning Qumi	37
Cleaning the Lens	37
Troubleshooting	38
Vivitek Support Site	41
Specifications	42
Projection Distance vs Projection Size	43
Projection Distance and Size Table	43
Timing Mode Table.....	44
Qumi Dimensions	45
Regulatory Compliance	46
Safety Certifications	46
Disposal and Recycling	46



Chapter 1 At a Glance

Overview

Front/Top/Right View

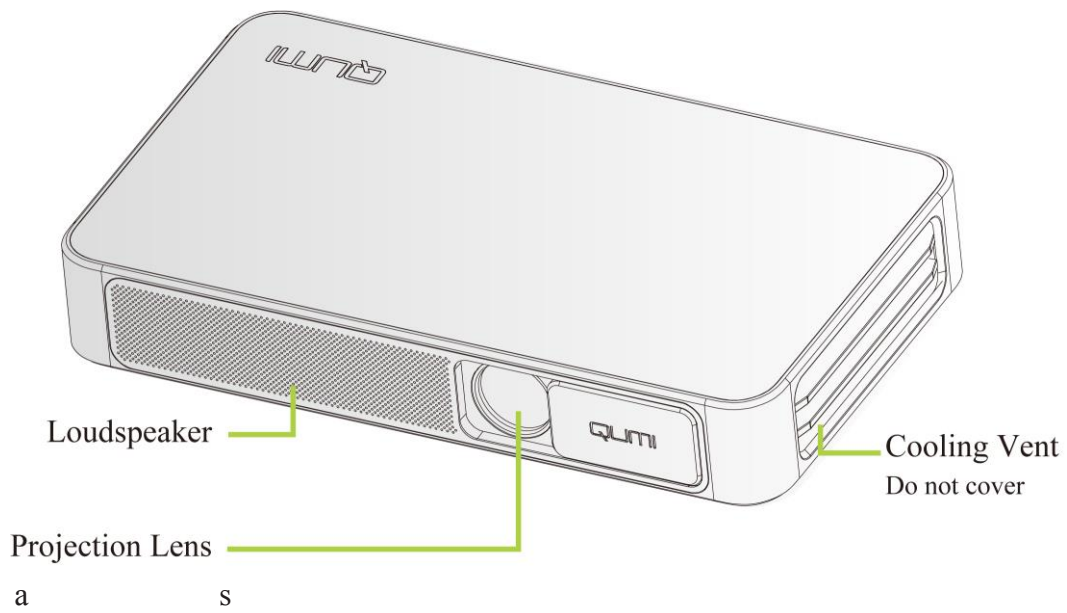

Rear/Top/Left View

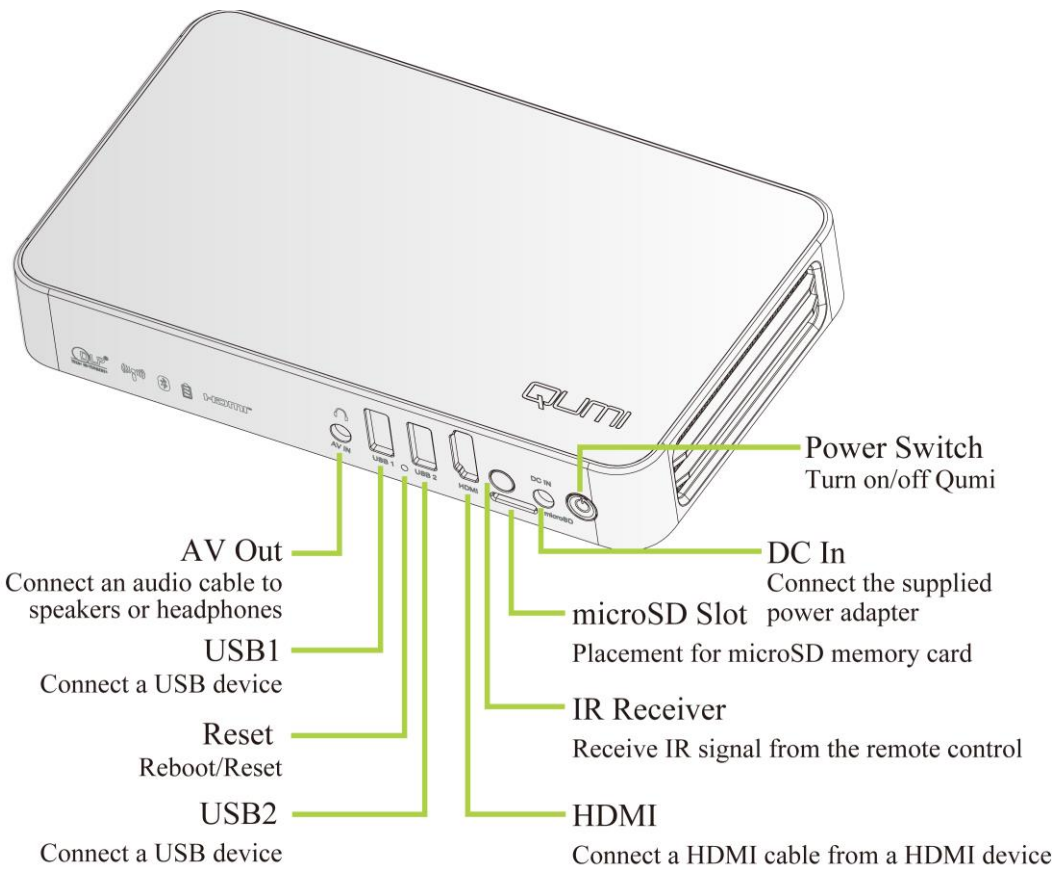

Bottom View

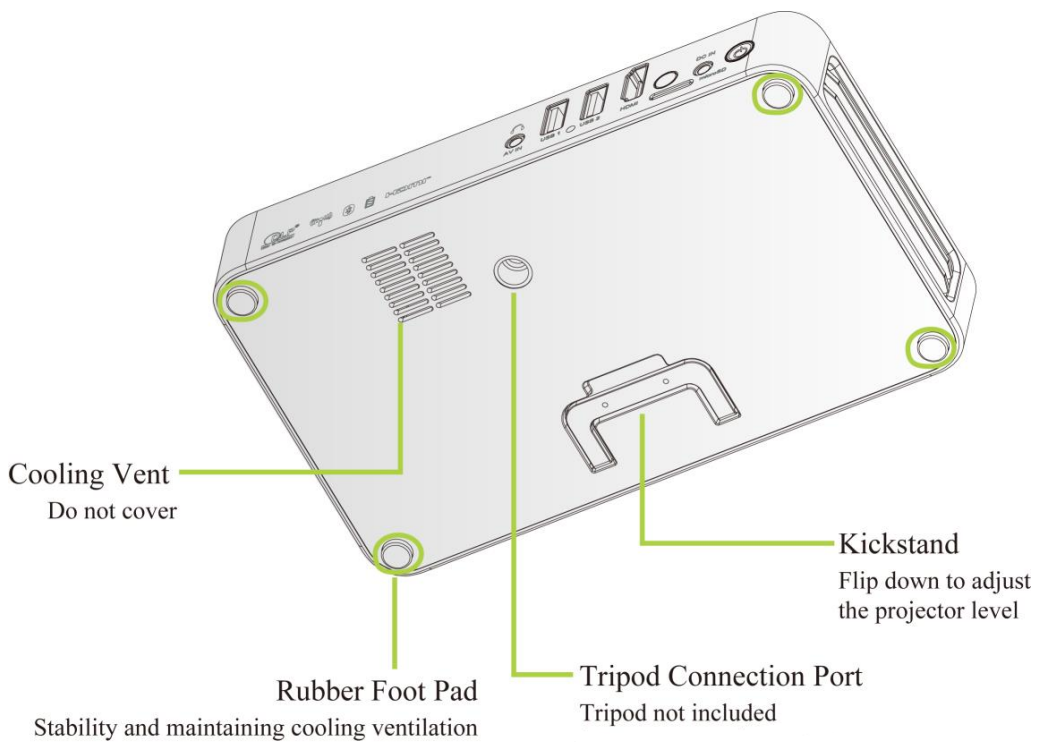

Standard Accessories:

Along with Qumi, the following accessories include:

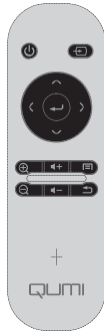

Remote control (with one R2025 battery)

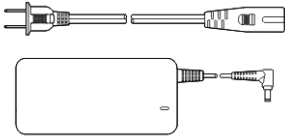

Regional Power Cord and Power Adapter



Documentation Kit
(Quick Start Guide, Warranty Card)



Standard HDMI cable

Contact your dealer immediately if any items are missing, appear damaged, or if the unit does not work. It is recommended that you keep the original packing material in case you ever need to return the equipment for warranty service.



Remote Control

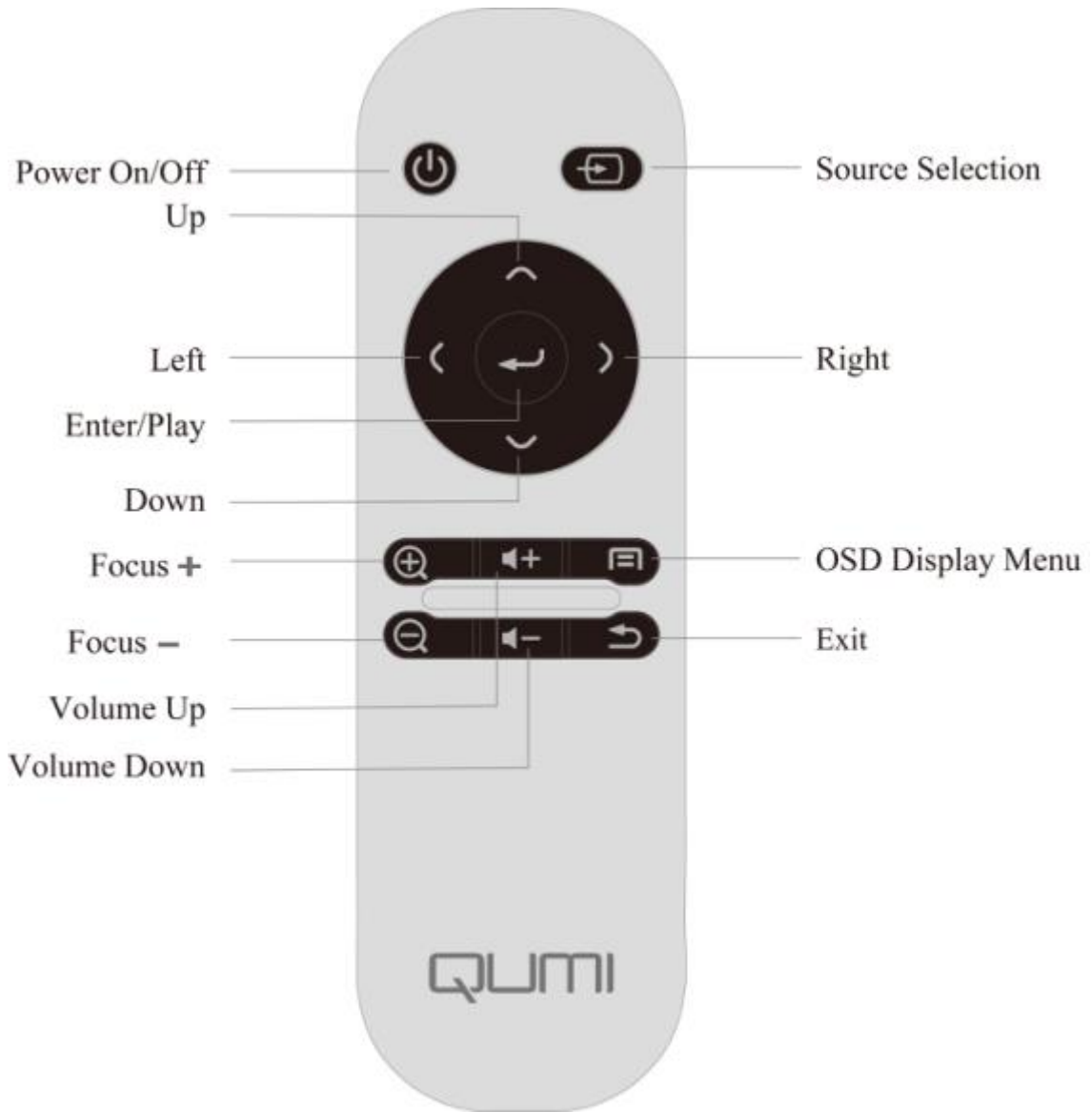

Setting Up the Remote Control

The remote control comes with one (1) 3V lithium battery (CR2025). The battery is pre-installed in the remote control.

To begin using the remote control, remove the plastic tab (A) from the battery compartment.

a u u s u

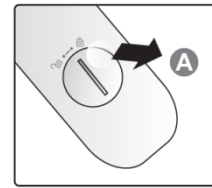

Replacing the Remote Control's Batteries

1. Remove the battery compartment cover by turning the cover towards the arrow (A). Then lift the cover out towards the arrow (B)..



2. Remove the old battery and insert the new battery with the positive side facing up.

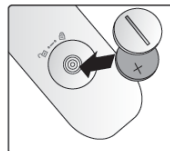

3. Install the cover and turn as shown in the illustration.



Caution:

1. Only use 3V lithium battery (CR2025).
2. Dispose of used batteries according to local ordinance regulations.
3. Remove the battery when not using Qumi for prolonged periods.

Operating Range

The remote control uses infrared (IR) transmission to control Qumi. It is necessary to point the remote towards Qumi.

The remote control functions properly within a radius of approximately 7 meters (23 feet) and 15 degrees above or below the Qumi level (If the remote is not held perpendicular to the sides or rear of Qumi).

If Qumi is unresponsive to the remote control, move closer towards Qumi.

ssa a a

Chapter 2 Getting Started

What you need

Qumi can be connected to many types of external devices and peripherals. To play music, connect Qumi to an external or portable music player. To play films, connect Qumi to a DVD, VCD or VHS player using a . . . To play video and display photos, connect Qumi to a video camera and digital camera using a . . . To display files and other types of media, connect Qumi to peripherals like a computer or USB drive.

These devices can be connected to Qumi using an appropriate cable. Make sure that the connecting device has an appropriate output connector.

a

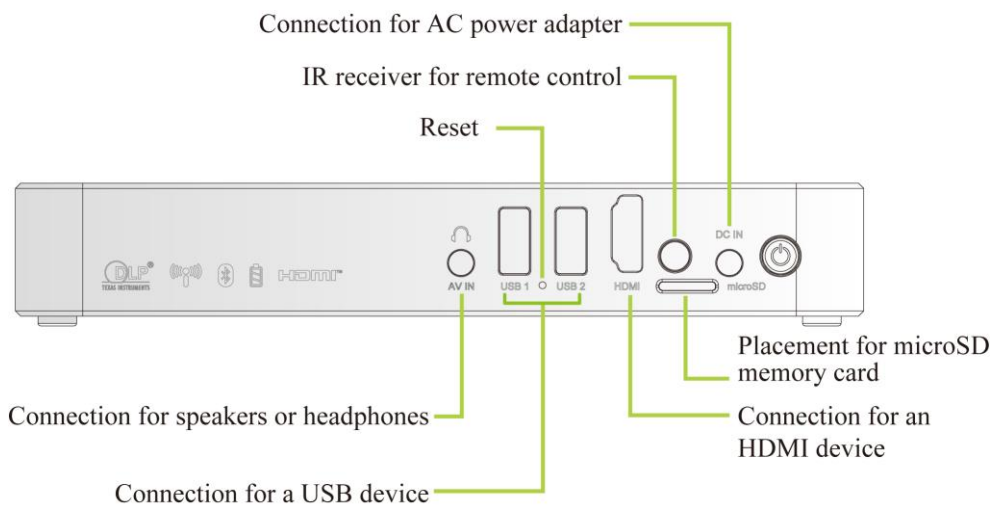

Setting Up Qumi

Connecting Peripherals by HDMI

Connect HDMI-compatible peripherals to Qumi using an HDMI cable (included)

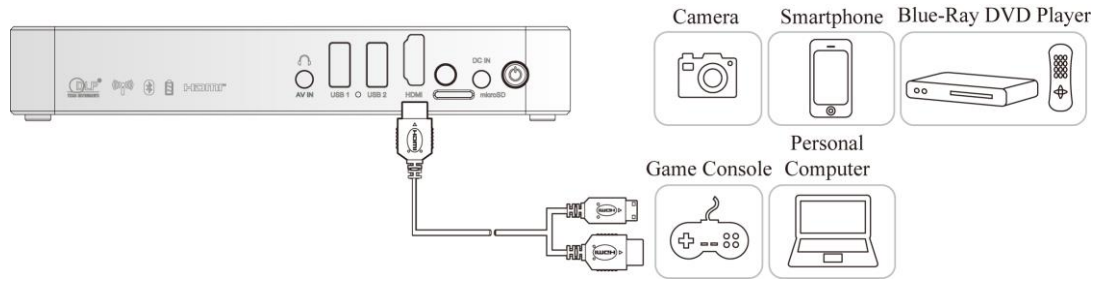

Inserting a USB device

Connect a USB device to Qumi by inserting the device(s) into the appropriate port.

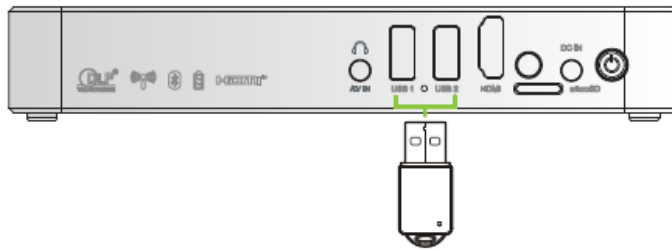

Connecting Audio

Connect earphones or speaker to Qumi by inserting into the AV-in port. Bluetooth Audio out is also available under Settings, Bluetooth. Turn Bluetooth "ON" and pair audio device.

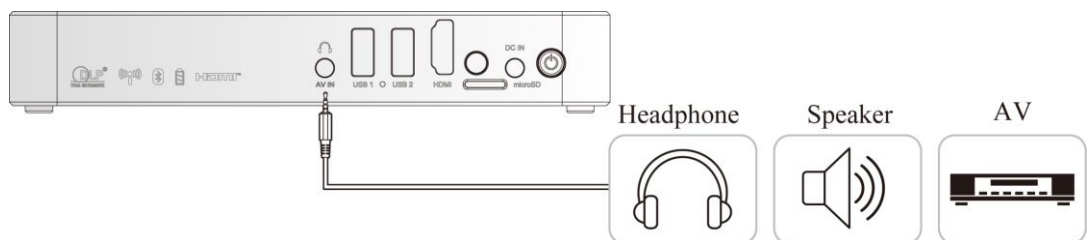

Charging the Battery

Follow the below steps to charge Qumi:

Connect the AC power adapter to Qumi.

Connect the other end of AC power adapter to a wall outlet.

During charging, the blue light on the AC power adapter will be on. After being fully charged, the blue light will automatically shut off.

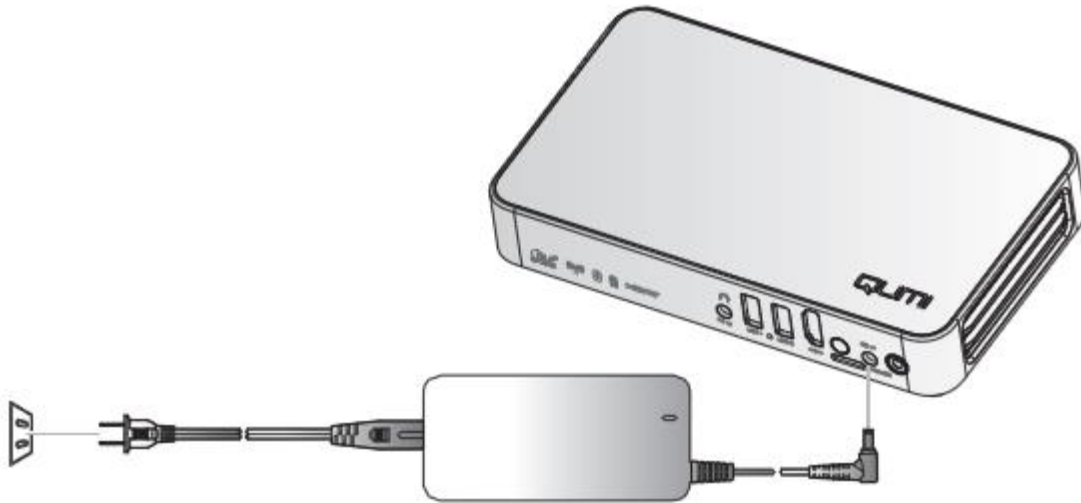

Note:

The battery will be fully charged in about 3 to 4 hours.

Starting and Shutting Down Qumi

1. Connect the AC power adapter to Qumi. Connect the other end of AC power adapter to a wall outlet.

Note:

The adapter models may differ between u s.

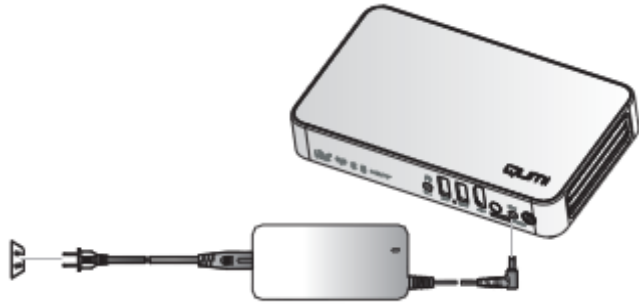

2. Press  power button to turn on Qumi.

- When AC power adapter is connected, press the power button for 1 second.
- When AC power adapter is not connected, press the power button for 3 seconds.

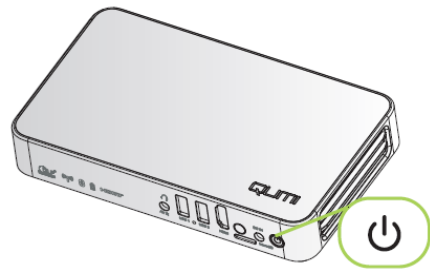

Qumi splash screen displays
and connected devices are detected
a s u s a



- If several input devices are connected, press the SOURCE selection (signal source) button on the remote control

u s a s a a s s
s a u

- HDMI: HDMI
- USB 1: USB Connection
- USB 2: USB Connection

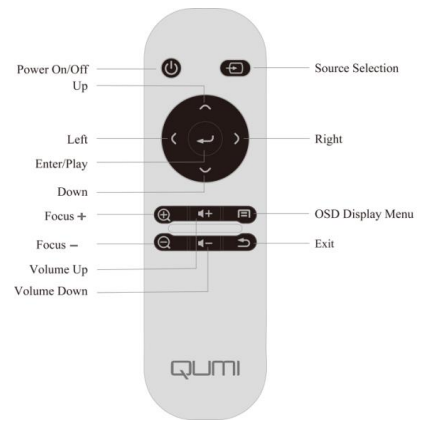

- Press  power button to power off Qumi.

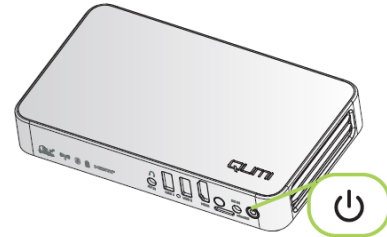

- When “Power off/Please press the power button again” message appears, press  power button. The projector will turn off.

Power off?
Please press the power button
again

- a a s s u
s s a u a a u

Adjusting the Projector Level

Flip down the kickstand to adjust the
a

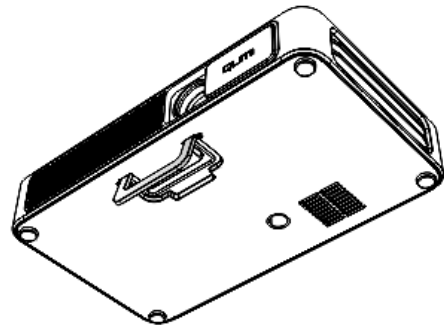

Using a Tripod

Qumi can be used with a tripod by connecting the tripod to the bottom of Qumi. Many typical tripods can be connected.

Supported Tripod Specifications:

- Type: Tripod
- S size: 1/4 - 20 L6.3 mm

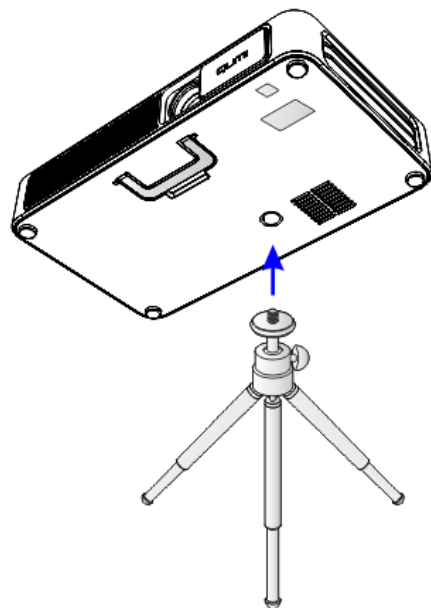

HappyCast - Android Setup

Allows the mirroring of connected Android devices (smartphone, tablet).

Option 1 (*Your Android device is connected to your Qumi WiFi hotspot*):

Enable the Qumi's Portable WiFi hotspot function (Inside the Android operating system).

Qumi Home Screen → Settings → General → More → Portable Hotspot

√ Tick Portable Wi-Fi hotspot

u as s ss u
s a s

Start the HappyCast App on your Qumi, located in the App Folder. su a u a
u s as
a

Scan the QR code (Quick Response), with your Android device, to download and install the HappyCast mobile app. Follow onscreen instructions to complete app installation.

After your Android device is connected to your Qumi's WiFi hotspot, start HappyCast app to enable screen mirroring.

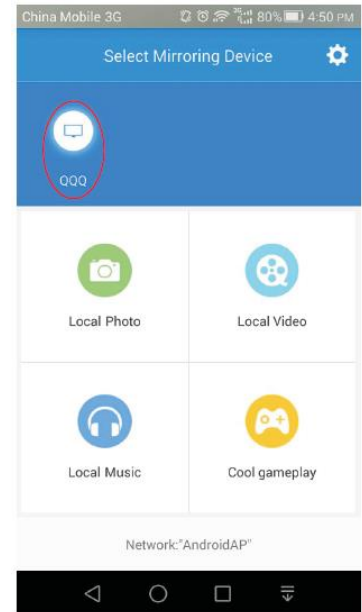

Option 2 (*Your Android device and your Qumi are connected to the same home/office WiFi network*):

Ensure that your Android device and your Qumi are connected to the same home/office WiFi network.

Start the HappyCast App  on your Qumi, located in the Apps Folder.

Scan the QR code (Quick Response), with your Android device a u a a s to download and install the HappyCast mobile pp. Follow on screen instructions to complete pp installation.

You may need to allow installation of Apps from unknown sources u . Go to Settings > Security > Unknown sources > Enable

Start HappyCast on your Android device, and enable screen mirroring.

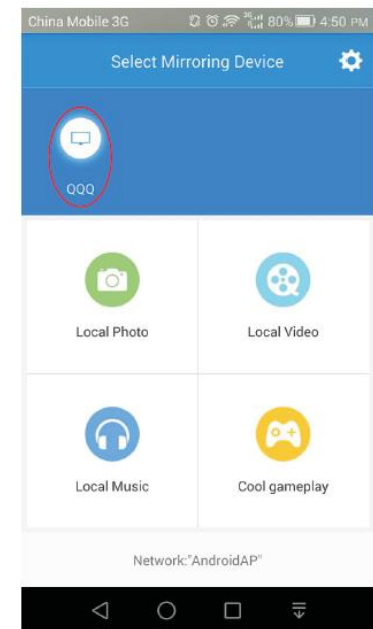

HappyCast - iOS Setup

Option 1 (Your iOS device is connected to your Qumi WiFi hotspot):

Enable the Qumi's Portable WiFi hotspot function (Inside the Android operating system).

Qumi Home Screen → Settings → General → More → Portable Hotspot

✓ Tick Portable Wi-Fi hotspot

Start the HappyCast App  on your Qumi, located in the Apps Folder as

On your iOS device, slide up from the bottom of the screen to display the control console. The AirPlay button should appear, then click on it. Select the suitable device to switch on the screen mirroring.

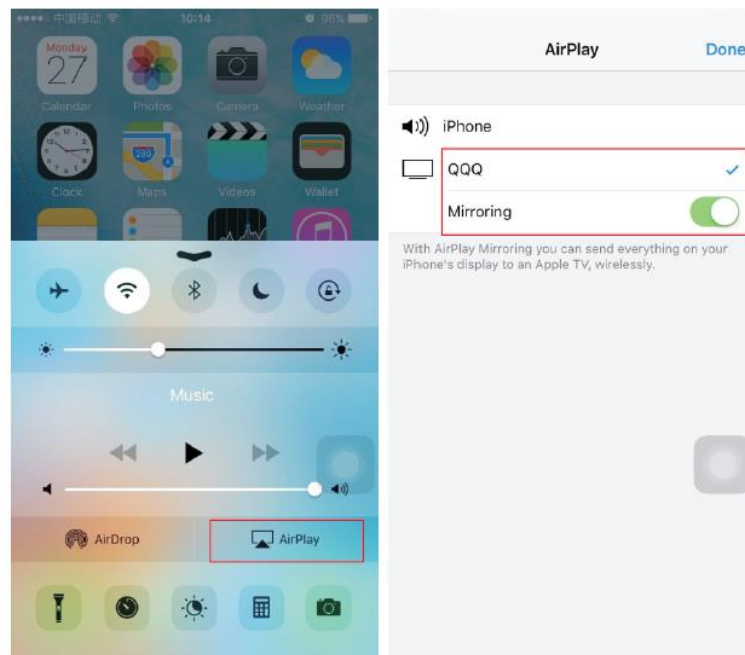

Option 2 (Your iOS device and your Qumi are connected to the same home/office WiFi network):

Ensure that your iOS device and your Qumi are under the same home/office Wi Fi network

Start the HappyCast App  on your Qumi, located in the Apps Folder

On your iOS device, slide up from the bottom of the screen to display the control console. The AirPlay button should appear s then u a Select a as to switch on the screen mirroring u

u u a

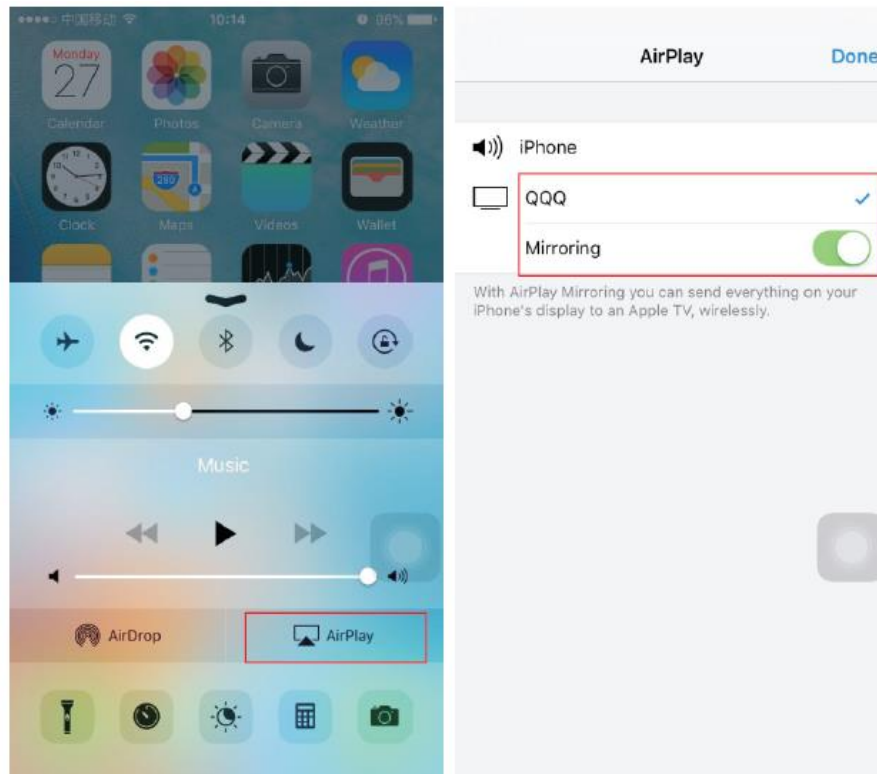

Chapter 3 Qumi User Interface

Views

The Qumi User Interface (UI) is designed to provide configuration and operational ease of use. The UI also allows you to access media files from your smart devices (phones or tablets), SDMicro cards or USB drives for a complete media experience.

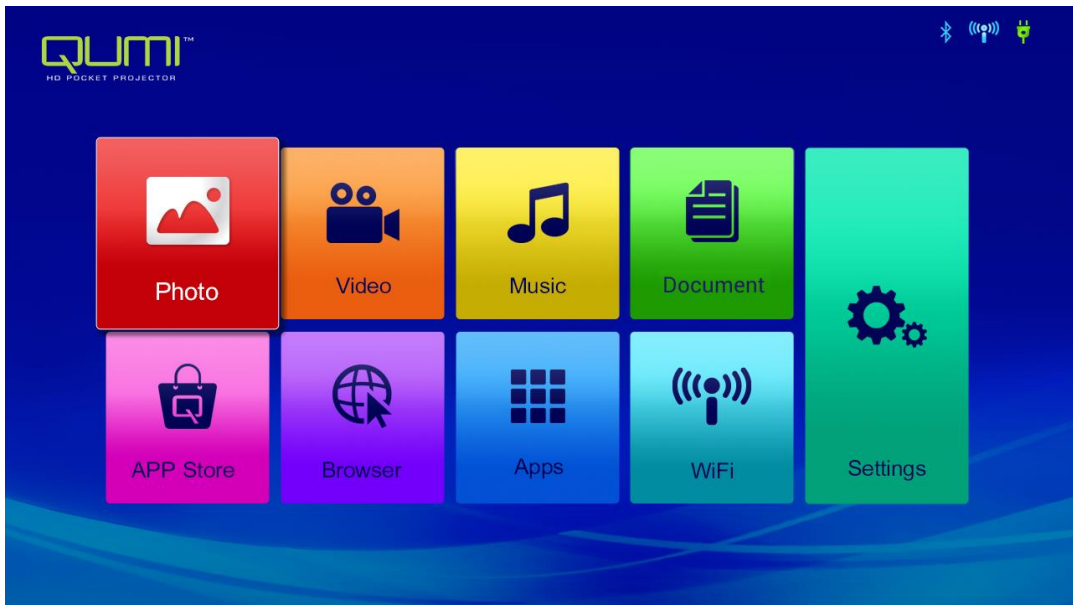







The UI contains nine main functions:

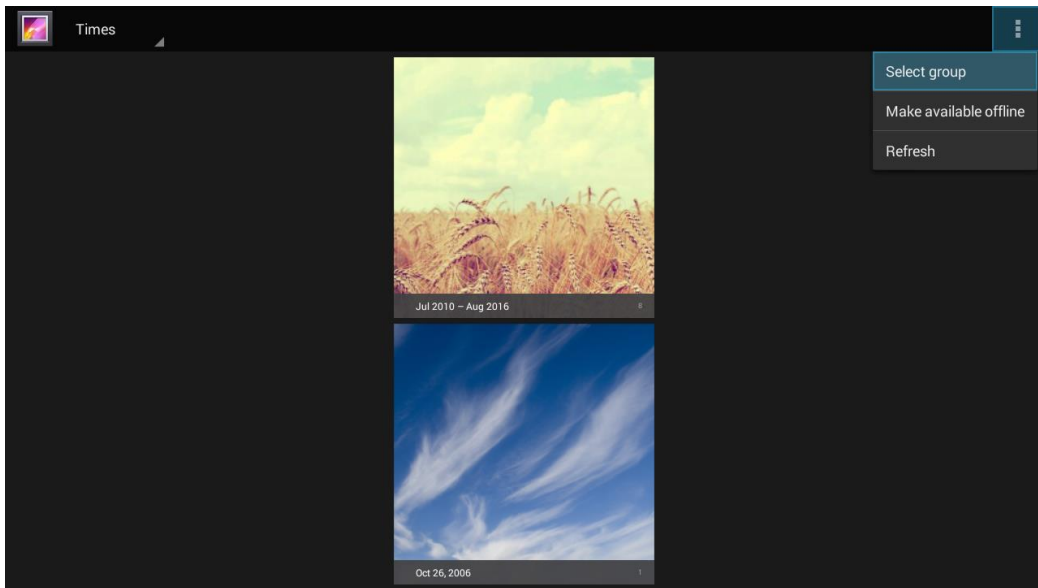
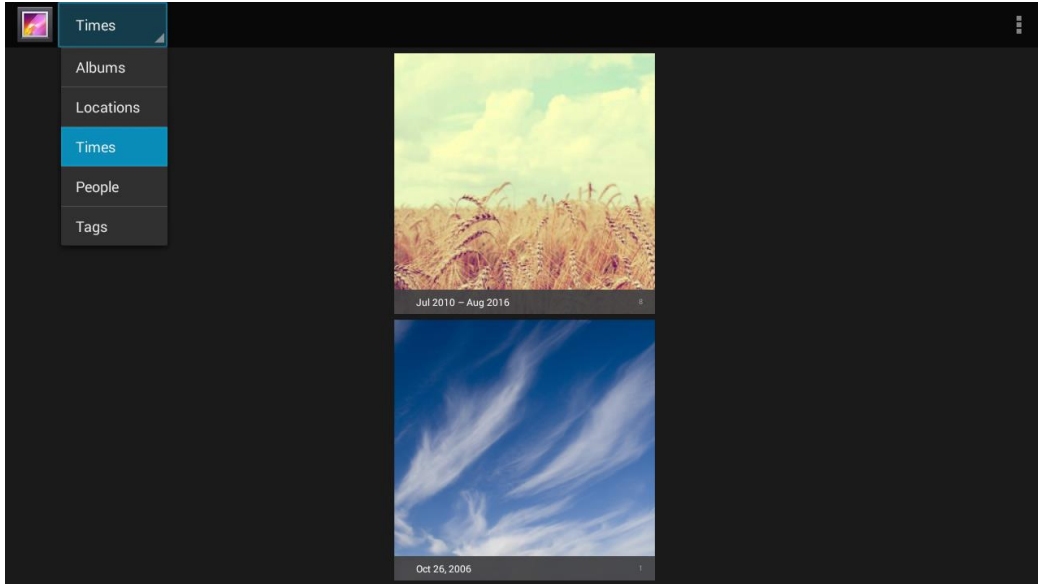



- Photo - Display photos and provides slide show functionality from files listed in the “Photo” menu or stored in the internal memory or a connected USB/SD Micro drive.
- Video - Play movies from files listed in the “Video” menu or stored in the internal memory or a connected USB drive.
- Music - Play audio from files listed in the “Audio” menu or stored in the internal memory or a connected USB/SDMicro drive.
- Document - Display document files listed in the “Document” menu or stored in the internal memory or a connected USB/SDMicro drive.
- APP Store - Manage downloads, updates and accesses to the APP Store.
- Browser- Navigate the web with the built-in browser.
- Apps - Manage and operate all application program settings related to Qumi.
- WiFi – Setup and manage wireless connections
- Settings - Access to a variety of settings including Display, Sound, Wi-Fi, Bluetooth, Storage, General, Application and System.

Photo

The available images in the connected USB drive/SD Micro or Internal Memory are listed in the Photo menu.

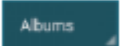







Press , ,  and  buttons on the remote controller to select files and press  to display the chosen file. The control panel display will change based on the file. The table below lists the available functions.

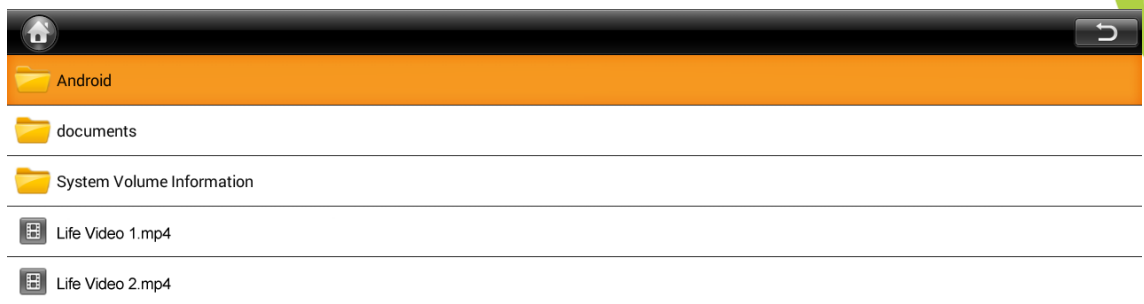

Menu Bar/Icon	Description
	Albums, Locations, Times, People, Tags
1. 	Select album, Make available offline, Refresh
	Filmstrip View, Grid View
2. 	Delete, Slideshow, Edit, Crop, Set picture as, Details, Print

Video

Available videos in the connected USB drive or Internal Memory are listed in the Video menu.









Press , ,  and  buttons on the remote controller to select files and press  to display the chosen file. The control panel display will change based on the file. The table below lists the available functions.

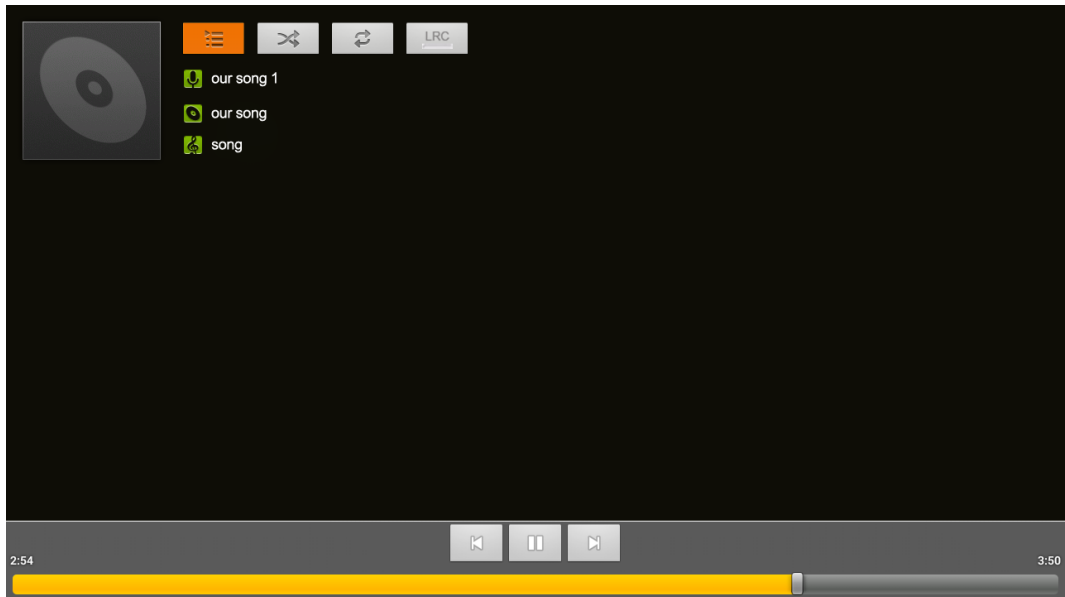



Menu Bar/Icon	Description
	Return to main menu
	Return to previous window

Music

Available music in the connected USB drive or Internal Memory are listed in the Music menu.



Press , ,  and  buttons on the remote controller to select files and press  to display the selected file. The control panel display will change based on the file. The table below lists available functions.



Menu Bar/Icon	Description
	Playlists
	Shuffle is on/Shuffle is off
	Repeat all songs/Repeat current song/Repeat is off
	Lyrics (LRC)

Document

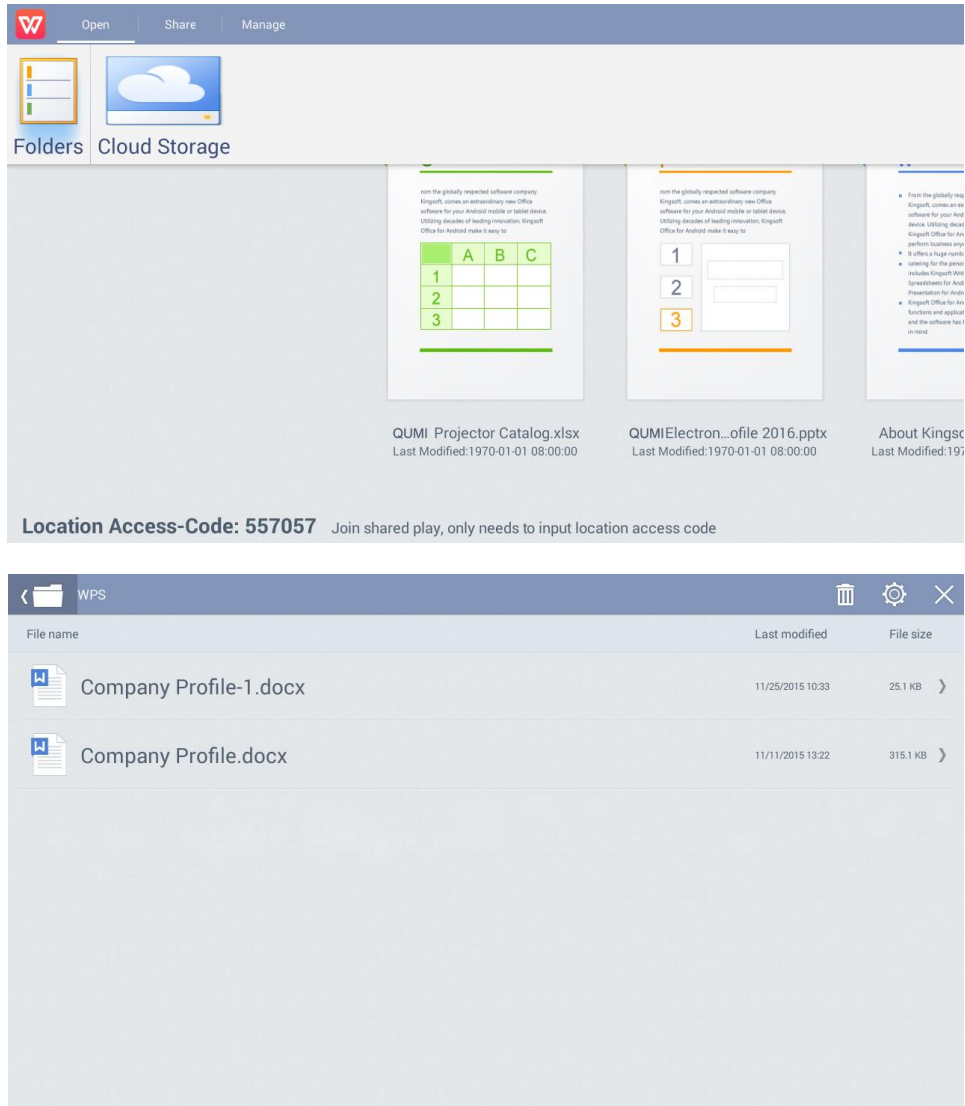
Available documents in the connected USB drive/SD Micro or Internal Memory are listed in the Document menu.



Press \curvearrowright , \curvearrowleft , \leftarrow and \rightarrow buttons on the remote controller to select files and press \leftarrow to display the chosen file. The control panel display will change based on the file. The table below lists the available functions.

Menu Bar/Icon	Description
Open	Folders, Cloud Storage
Share	Send Cloud, Join Shareplay, More
Manage	Duplicate, Delete, Erase Record
	Delete
	Sort by: File Name, Modify Time (Refresh)
	Close

To play a Powerpoint presentation:

Insert USB or SD Micro card, click "Document" on the Splash screen. Click "Open". Click "Folders". Click SD Card(sdcard1) if presentation is on SDMicroCard or click SD(sda1) if presentation is located on a USB drive. Select appropriate presentation, select "Play" or "Auto Play", use \rightarrow to move to "OK". Use \rightarrow and \leftarrow arrow buttons to scroll through presentation. To replay, select "Documents", scroll to presentation and select to play.

APP Store

Manage downloads, updates and access to the APP Store.

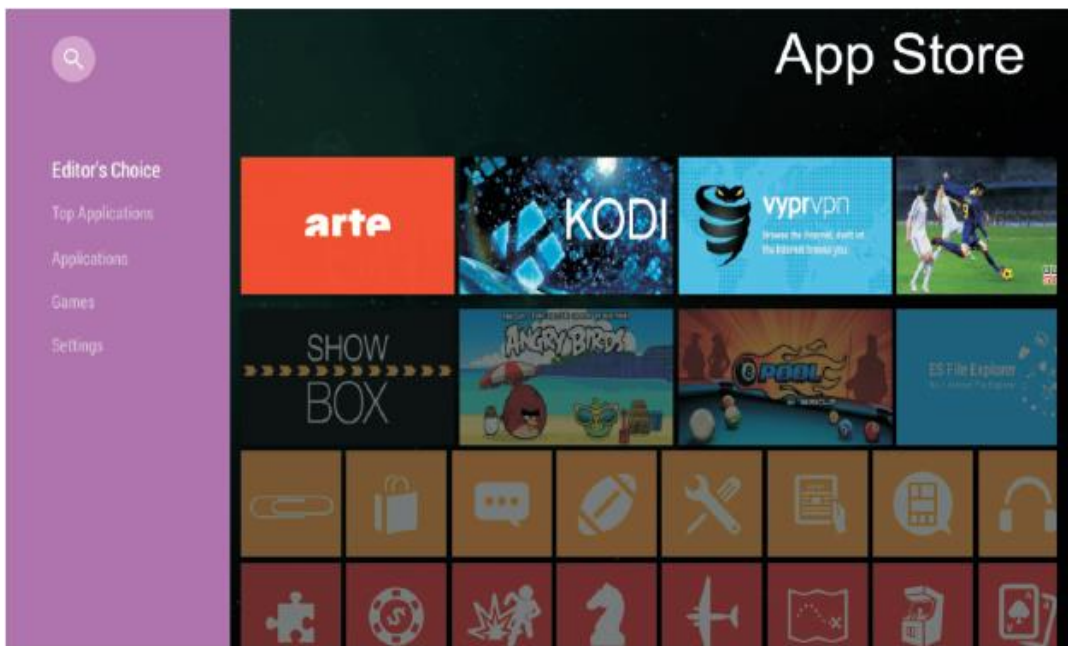



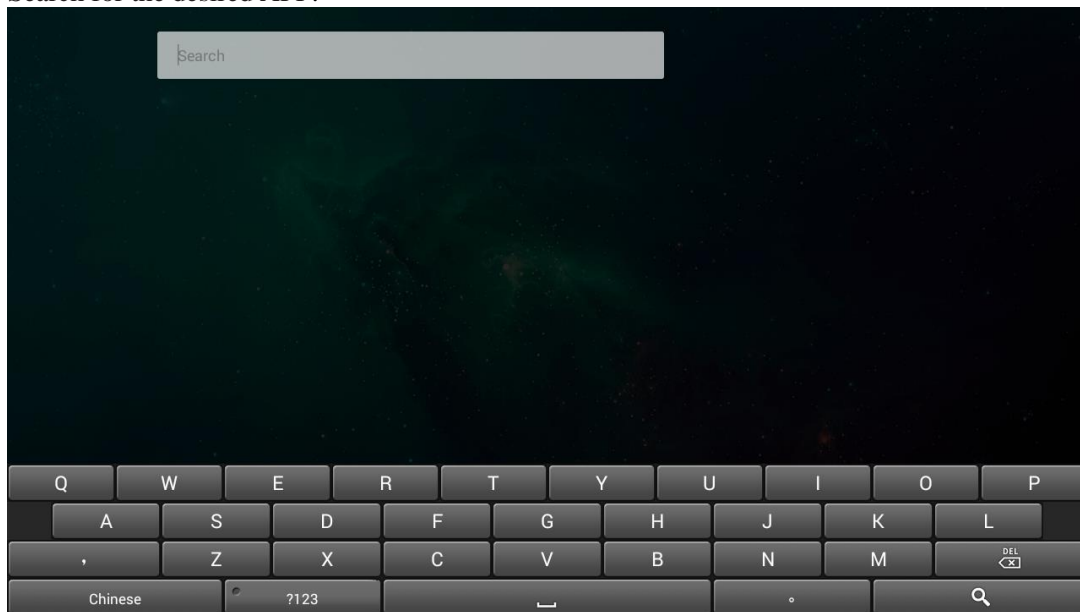

Search for the desired APP.







Browser

Navigate the web with the built-in browser.



Press , ,  and  buttons on the remote controller to select files and press  for display. The control panel display will change based on the file. The table below lists available functions.

Menu Bar/Icon	Description
	Refresh, New tab, Share page, Find on page, Request desktop site, Page info, Settings
	Bookmark this page
	Search or type URL
	Find local bookmark

Apps

Manage and operate all applications installed on Qumi.



Applications downloaded through the App Store will show in Apps.



WiFi

Setup and manage wireless connections (Example: Tablet, smartphone)

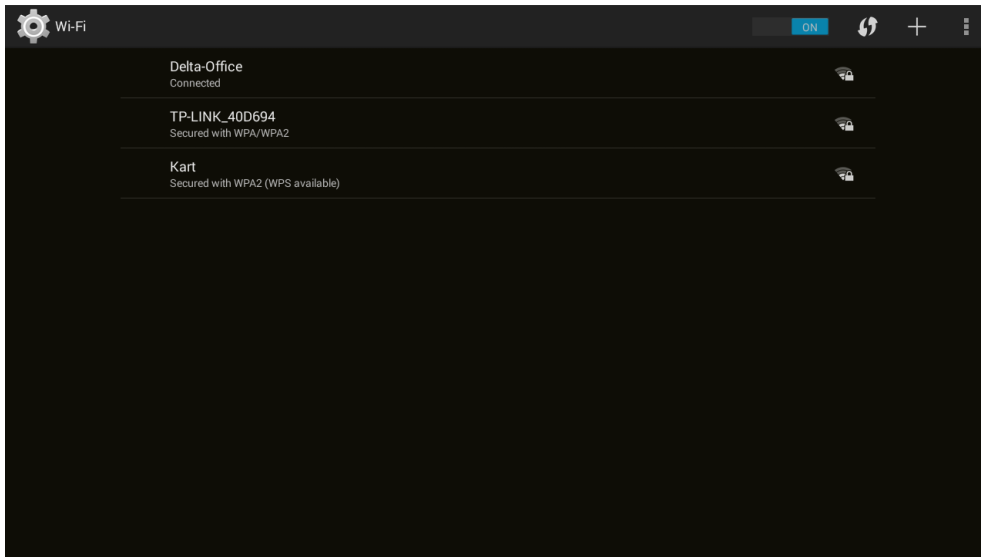

Enable WiFi -- Select network name

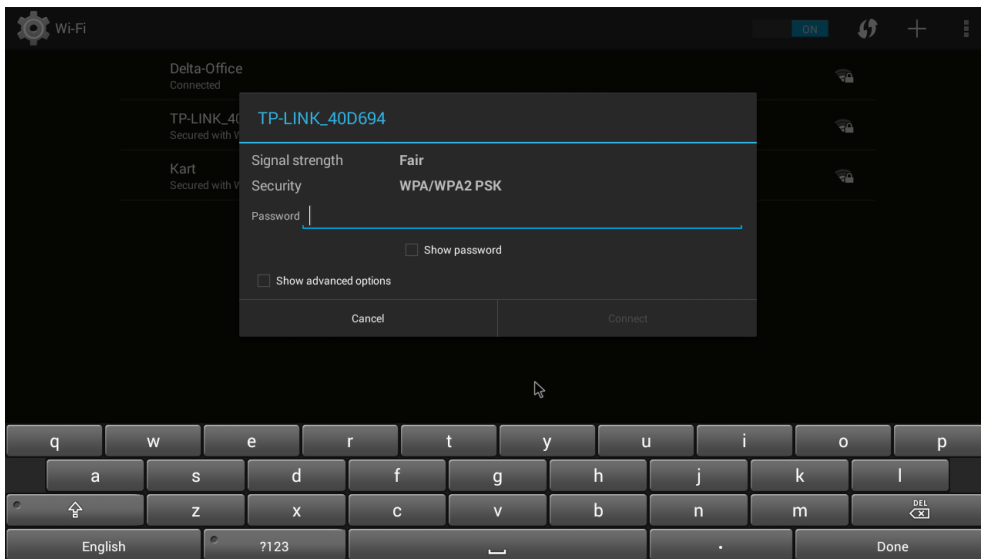

Input user name and password -- Click Connect



Press \curvearrowright , \curvearrowleft , \langle and \rangle buttons on the remote controller to select files and press \leftarrow for display. The control panel display will change based on the file. The table below lists available functions.

Menu bar/Icon	Description
OFF / ON	Turn On or Off WiFi
	Refresh (Available Networks)
	Add Network
	Scan, WPS PIN Entry, Wi-Fi Direct, Advanced



Settings

Access to a variety of settings including Display, Sound, WiFi, Bluetooth, Storage, General, Application and System.

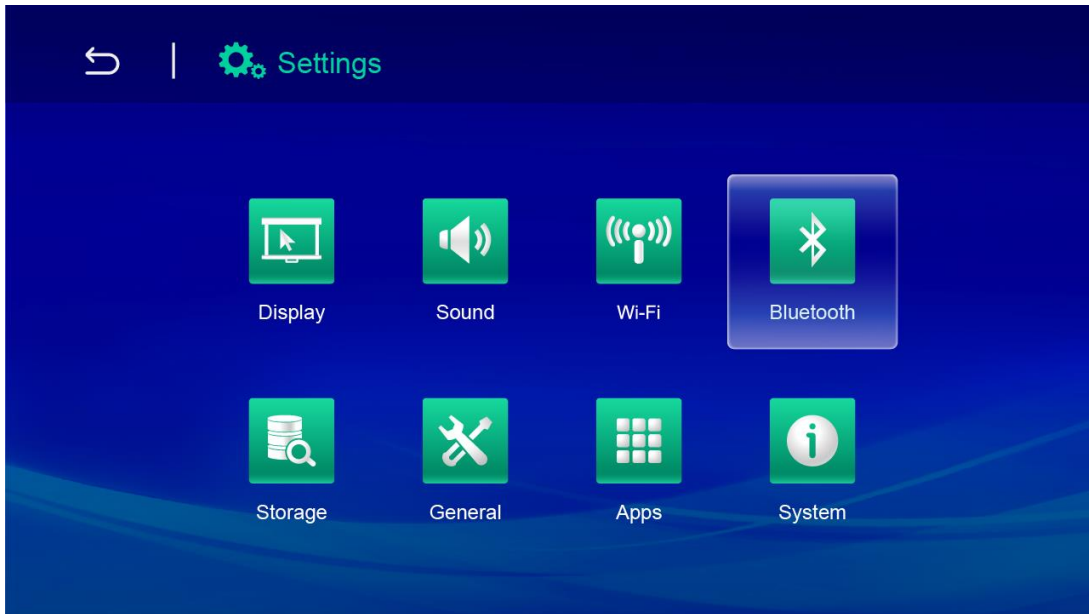

Press \curvearrowright , \curvearrowleft , \langle and \rangle buttons on the remote controller to select files and press \leftarrow for display. The control panel display will change based on the file. The table below lists available functions.

Menu Bar/Icon	Description
Display	Font size, Cast screen
Sound	Volume, System (Default notification sound, Touch sounds)
Wi-Fi	Setup and manage wireless connections
Bluetooth	Setup and manage Bluetooth devices
Storage	Internal storage display, SD card, USB storage
General	Wireless and network settings, Device settings, Personal settings, Account settings, System settings
Applications	Downloaded Apps, Running Apps, Storage space available
System	Status information, Legal information, Model, Android version, Core version, Build number

Chapter 4 On-Screen Display (OSD) Settings

OSD Menu Controls

Qumi has an On-Screen Display (OSD) settings, accessed by the OSD Menu button on the remote , that allows you to make adjustments and change setting, such as display and audio settings. The OSD menu has 10 sub-menus:

- Language – Allows for the selection of the language for the OSD Menu. Press OSD Menu key for entry. Select and move to the desired language using the Arrow Keys and then press the Menu or Exit key to confirm and exit.
- Display Settings – Allows adjustment of projector's image display settings to viewers preference. The display settings consist of Bright, Presentation, Movie and User modes. Select and move to the desired display mode using the Arrow Keys and then press the Menu or Exit key to confirm and exit.
- Sound Settings – Select or adjust the projectors audio settings. The audio settings consist of Standard, Music, Movie, Sports, and User modes. Select and move to the desired sound mode using the Arrow Keys and then press the Menu or Exit key to confirm and exit.
- Color Temperature - Adjust color temperature of screen and RGB parameters to users preference. Select and move to the desired color temperature mode using the Arrow Keys and then press the Menu or Exit key to confirm and exit.
- Aspect Ratio Modes – Select the aspect ratio to adjust how the image appears on the screen. Select and move to the target mode by using Up/Down Key and tpress the Menu or Exit key to confirm and exit.
- Projection Mode – Allows for the selection of the projection mode (Depends on mounting method). Press the Entry button to choose from the available modes.
- Keystone Correction - Corrects misaligned or distorted images so that projection is displayed correctly on the screen. Select and move to the keystone correction mode using the Arrow Keys and then press the Menu or Exit key to confirm and exit.
- Software update (USB) - Updates system software. Place the software in the root directory of USB drive, and then press OK Key to enter the update confirmation interface and select Yes to update the software.
- Reset All - Restore factory settings and default parameters of the system, including image, sound, projection, keystone, etc.
- Status - Displays relevant system information (such as software version)

Note:

If the OSD menu is non-active for 10 seconds, it will disappears.



OSD Menu Overview



Use the following table to quickly find a setting or determine the range for a setting

Main Menu	Submenu/setting
OSD Languages	Česky, English, Français, Dansk, Español, Hrvatski, Deutsch, Ελληνικά, Italiano, Magyar, Polski, Românește, Nederlands, Português, slovenščina, Norsk, русский, Srpski, Suomi, 简体中文, Svenska, 繁體中文, 日本語
Display Mode Presentations	Bright: Contrast 50, Brightness 55, Color 50, Sharpness 50, Tint 50
	Presentation: Contrast 49, Brightness 49, Color 50, Sharpness 50, Tint 50
	Movie: Contrast 49, Brightness 49, Color 40, Sharpness 50, Tint 50
	User: Contrast 50, Brightness 50, Color 40, Sharpness 50
Sound Mode	Standard: Treble 50, Bass 50
	Music: Treble 75, Bass 75
	Movie: Treble 75, Bass 90
	Sport: Treble 35, Bass 35
	User: Treble 50, Bass 50
Color Temperature	Cool: Red 50, Green 50, Blue 50
	Medium: Red 50, Green 50, Blue 50
	Warm: Red 60, Green 38, Blue 25
	User: Red 0, Green 0, Blue 0
Aspect Ratio	4:3, 16:9, ZoomX1, ZoomX2
Projection Method	3, 2, 1
Keystone Correction	Auto: Calibration
	Manual - -35 - +35
Software Update (USB)	*Follow onscreen steps for software update
Reset All	Are you sure? Yes or No
Status	LED Hours: xx
	Software Version: No. XX.X-XXX.XX.XX





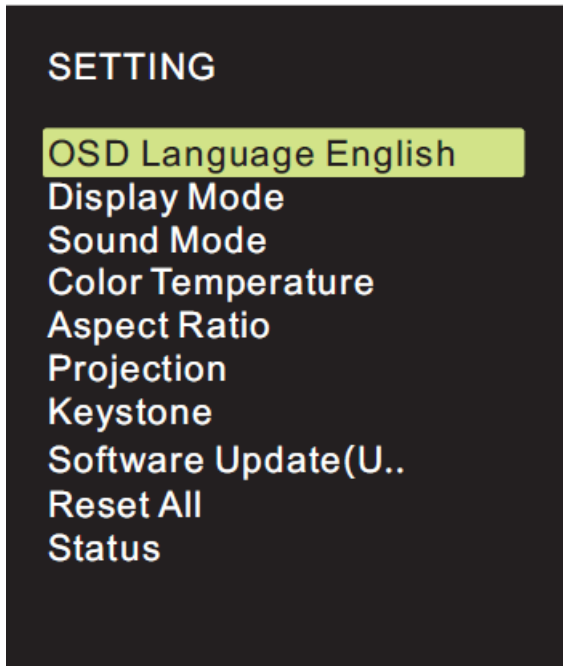

OSD Language Settings

Qumi's OSD language menu can be easily changed. Perform the following steps to change the OSD language:

1. Press the OSD Screen Menu button  on the remote control to enter the Settings menu.
2. Move the cursor to highlight the menu language, and press .





3. Press , ,  and  buttons to choose the preferred language.
4. Press  button to exit language settings.





Display Mode Settings

Perform the following steps to change the display mode:

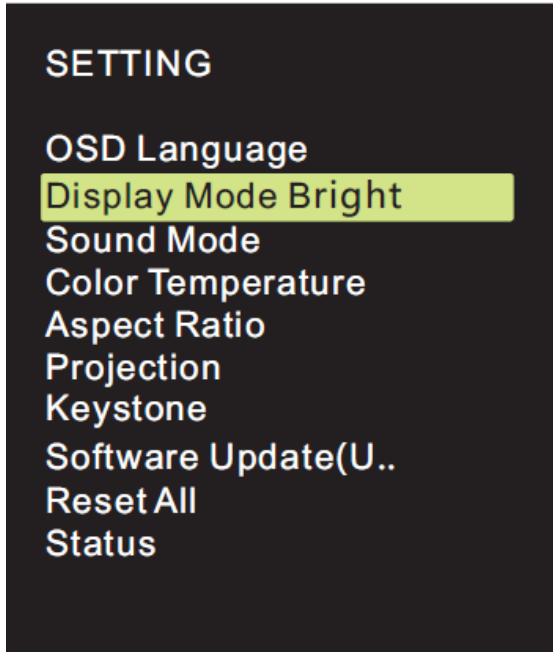
1. Press the OSD Screen Menu button  on the remote control to enter the Settings menu.
2. Move the cursor to highlight the Display Mode, and press  to enter this mode.



3. Press  and  buttons to select the desired display mode (Presentation, Bright, Movie User).
4. Press  button to exit display mode settings.

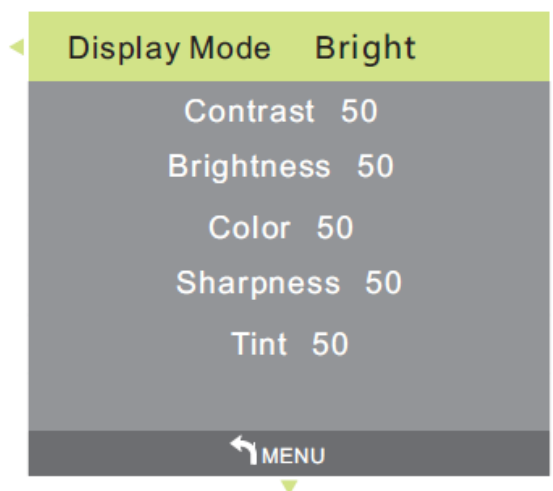



Note:



User display modes may be adjusted to the preference of the user and their applications.

Sound Mode Settings

Perform the following steps to change the sound mode:

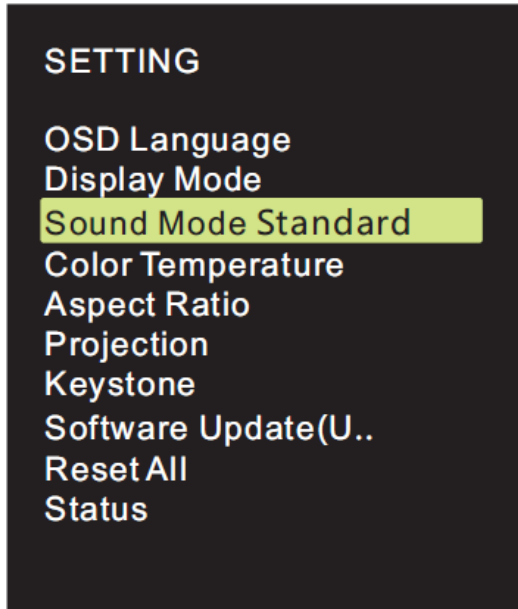
1. Press the OSD Screen Menu button  on the remote control to enter the Settings menu.
2. Move the cursor to highlight the Sound Mode, and press  to enter this mode.



3. Press  and  buttons to select the desired sound mode (Standard, Music, Film, Sport and User).
4. Press  button to exit sound mode settings.

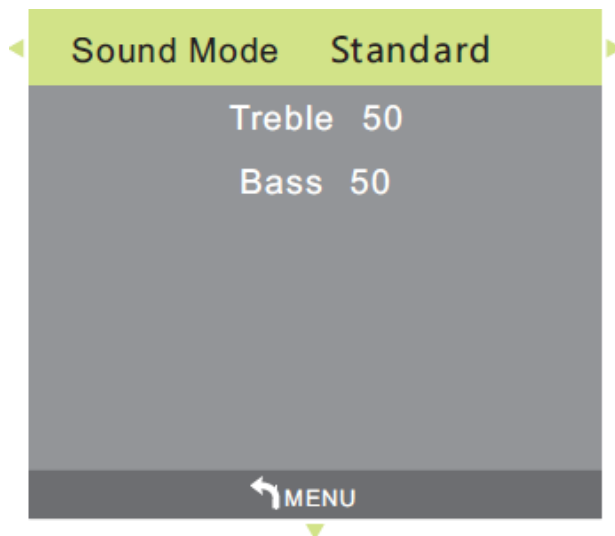



Note:
Treble and Bass can be adjusted as required by the applications.





Color Temperature Settings

Perform the following steps to change the color temperature settings:

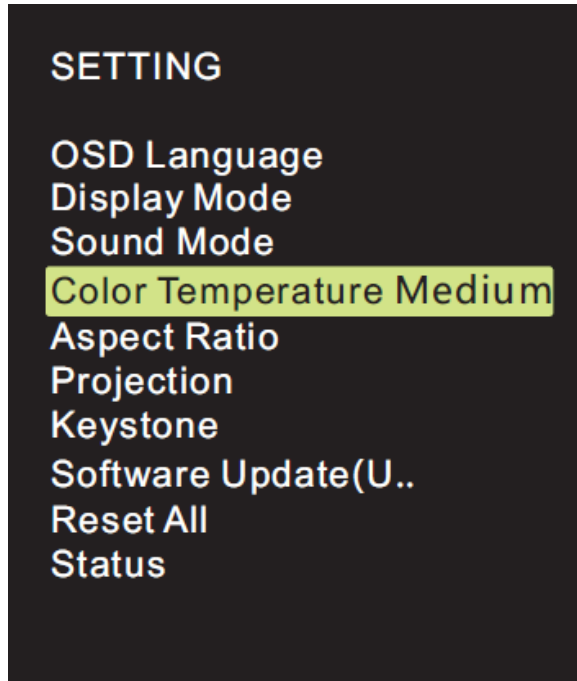
1. Press the OSD Screen Menu button  on the remote control to enter the Settings menu.
2. Move the cursor to highlight the color temperature, and press  to enter this mode.



3. Press  and  buttons to select the desired Color Temperature mode.
4. Press  button to exit the Color Temperature mode settings.

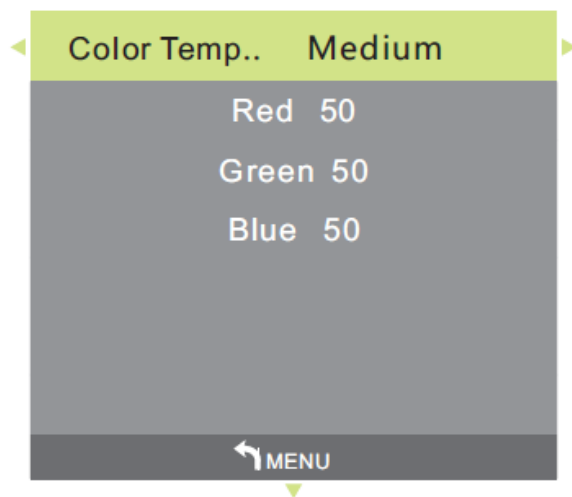



Note:



Red, green and blue colors can be adjusted as required by the applications.

Aspect Ratio Settings

Perform the following steps to change the projector's aspect ratio:

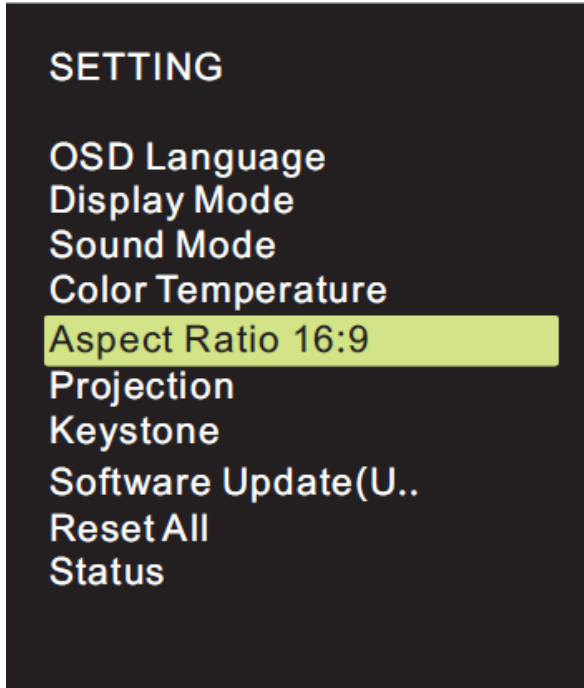
1. Press the OSD Screen Menu button  on the remote control to enter the Settings menu.
2. Move the cursor to highlight the Aspect Ratio settings and press  to enter this mode.



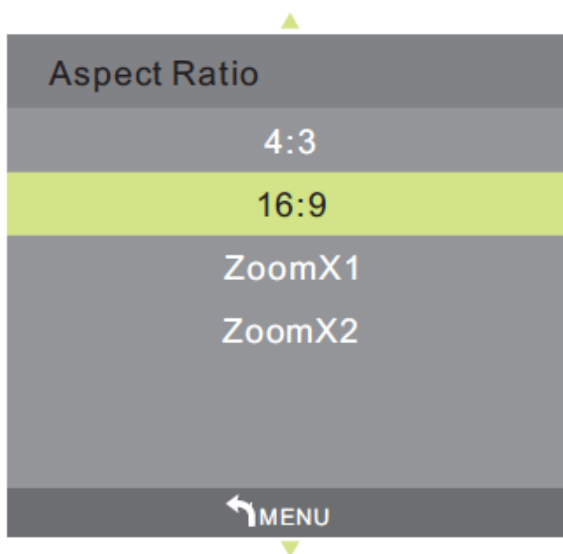

3. Press  and  buttons to select the desired Aspect Ratio mode.
4. Press  button to exit the Aspect Ratio mode settings.





Projection Method Settings

Perform the following steps to change the projector's projection method:

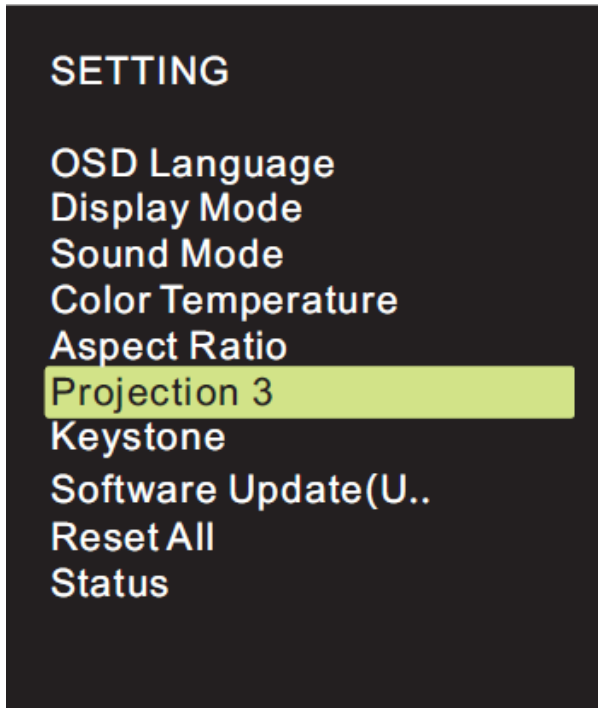

1. Press the OSD Screen Menu button  on the remote control to enter the Settings menu.
2. Move the cursor to highlight the Projection Method settings and press  to enter this mode.







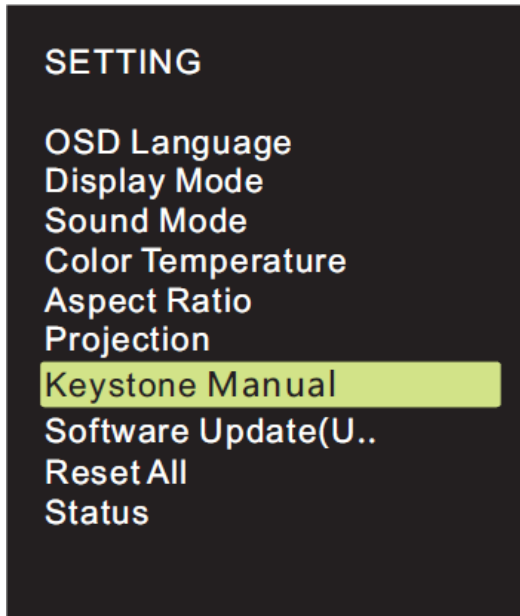

3. Repeatedly press  button to select the desired projection method (3, 2, 1).
4. Press  button to exit the Projection Method settings.

Keystone Correction Settings

Perform the following steps to change the projector's keystone correction:

1. Press the OSD Screen Menu button  on the remote control to enter the Settings menu.
2. Move the cursor to highlight the Keystone Correction settings, and press  to enter this mode.



3. Press , ,  and  buttons to select the desired Keystone Correction mode.
4. Press  button to exit the Keystone Correction settings.

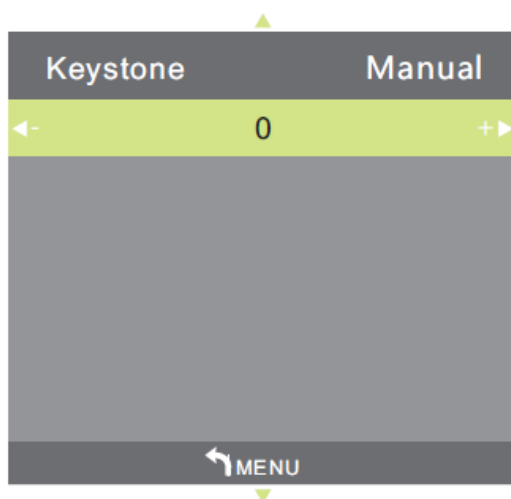

Note:
The keystone correction may be adjusted as required by the application. (Values are between -35 and +35)

Software Update Settings (USB)

For further assistance, please contact your reseller or Vivitek (www.vivitekcorp.com).



SETTING

OSD Language
Display Mode
Sound Mode
Color Temperature
Aspect Ratio
Projection
Keystone
Software Update(U..
Reset All
Status





Reset All Settings

Perform the following steps to reset all on the projector:

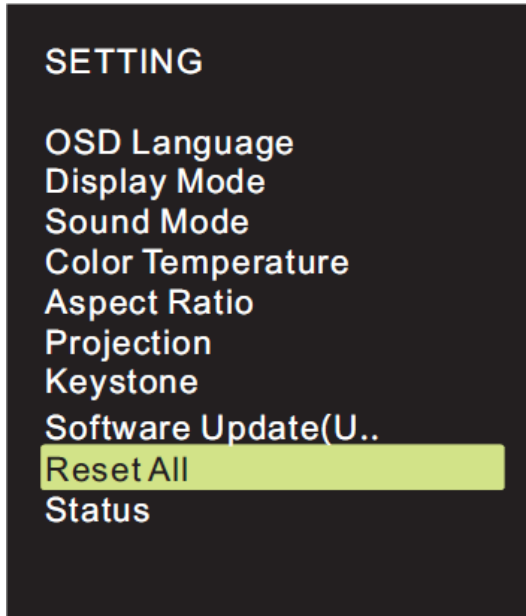
1. Press the OSD Screen Menu button  on the remote control to enter the Settings menu.
2. Move the cursor to highlight the Reset All settings and press  to enter this mode.



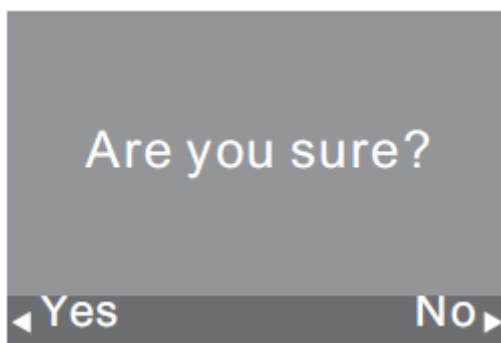

4. Press  button to select Yes and  to select No. After selecting Yes, the Qumi system will be reset to original factory settings.



Status Settings

Perform the following steps to view the projector's status:

1. Press the OSD Screen Menu button  on the remote control to enter the Settings menu.
2. Move the cursor to highlight the Status settings and press  to enter this mode.

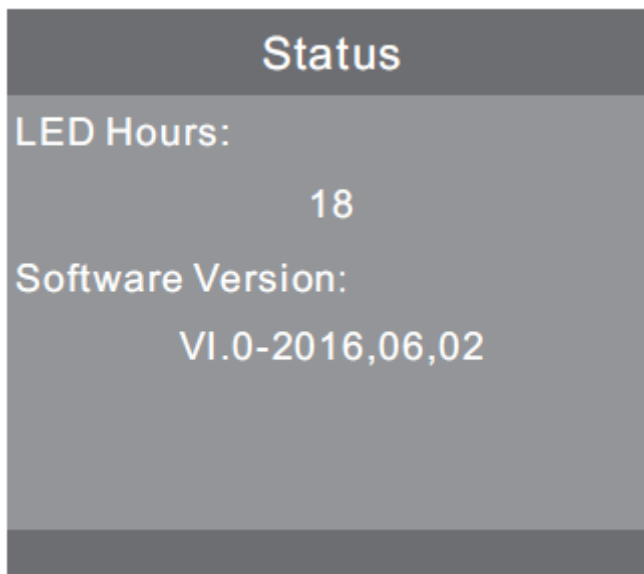
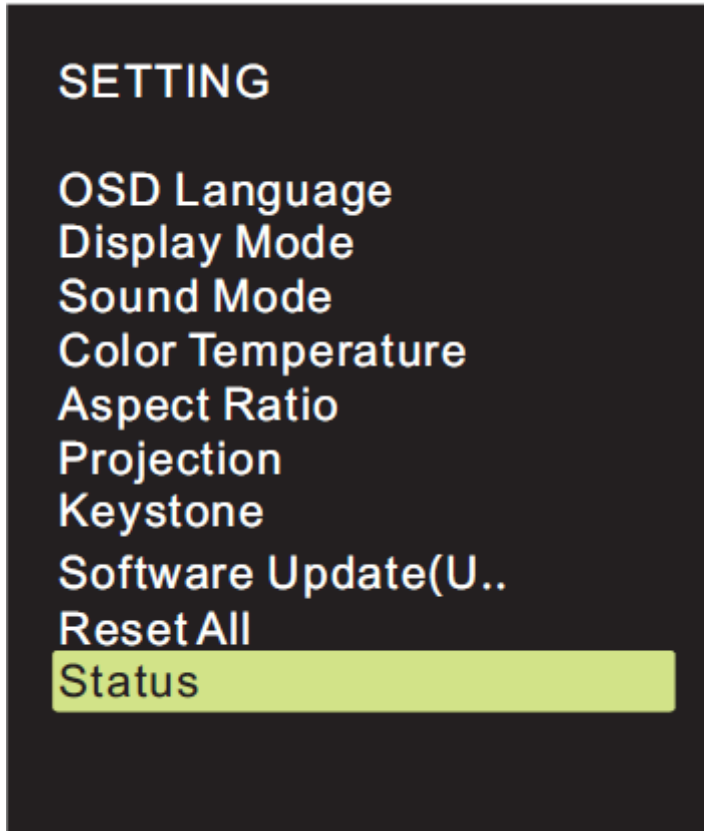

Chapter 5 Taking Care of Your Qumi

Cleaning Qumi

Cleaning Qumi to remove dust and grime will help provide trouble-free operation.



Warning:

1. *Qumi should be turned off and unplugged before cleaning. Failure to do so may result in injury or damage to the system.*
2. *Use only a dampened cloth when cleaning. Do not allow water to enter the ventilation openings on Qumi.*
3. *If a small amount of water gets into the interior of Qumi while cleaning, unplug Qumi and set in a well ventilated area for several hours before using.*
4. *If a large amount of water gets into the interior of Qumi when cleaning, unplug Qumi and have it serviced.*

Cleaning the Lens

Optical lens cleaning solutions can be purchased from most camera and other retail stores. To clean Qumi lens, perform the following steps:

1. Apply a small amount of the optic lens cleaning solution to a clean, lint free and soft cloth. (Do not apply the cleaning solution directly to the lens.)
2. Gently wipe the lens in a circular motion.



Caution:

1. Do not use abrasive cleaners or solvents.
2. To prevent discoloration or fading, do not allow the cleaning solution to contact Qumi case.



Troubleshooting

FAQs and Solutions

These guidelines provide tips to deal with problems you may encounter while using Qumi. If the problem remains unresolved, contact your Reseller or Vivitek for assistance.

The problem sometimes can be as simple as improper connection of cables. Review the following possible issues before proceeding to the problem-specific solutions.

- Use another electrical device to confirm that the electrical outlet is properly working.
- Make sure that Qumi is turned on.
- Make sure all connections are securely connected.
- Make sure that the connected device is turned on.
- Make sure that the connected PC is not in suspended mode or sleep mode.

Troubleshooting Tips

In each problem-specific section, perform the steps in the order suggested. Doing so may help solve the problem more quickly.

In order to avoid replacing non-defective parts, try to find and isolate the problem

For example, if you replace batteries and the problem remains, put the original batteries back and move to the next step.

Keep a record of the steps you take when troubleshooting. The information may be useful for reference when calling technical support or for bringing Qumi to service personnel.

System Reset Method (Reboot)



- On the rear side of Qumi (below the two USB ports), there is a small pinhole. Insert a paperclip (or similar sized object) into the hole and press for 3 seconds to reboot Qumi.

Image Problems

Problem: No image appears on the screen.

1. Check whether PC is properly configured.
2. Turn off all of the equipment and power up the equipment again in the correct order.

Problem: The image is blurred

1. Adjust the focus via remote control
2. Ensure that the distance between the Qumi and the screen is within specified range
3. Clean Qumi lens with optical lens cleaning cloth if it is dirty.

Problem: The image is wider at the top or bottom (trapezoid effect)

1. Position Qumi so that it is as perpendicular to the screen as possible.
2. Adjust the Keystone settings in the OSD to correct the problem.

Problem: The image is reversed

Check the orientation of the Projector Mode setting in the Display menu in the OSD.

Problem: Image without contrast

Adjust the Contrast setting in the Color menu in the OSD.

Problem: The color of the projected image does not match the source image

Adjust the color temperature settings in the Color Temperature setting in the OSD menu.

Remote Control Problems.

Problem: Qumi does not respond to the remote control commands

1. Aim the remote control towards the remote sensor on Qumi.
2. Make sure the path between remote and sensor is not obstructed.
3. Turn off any fluorescent lights in the room.
4. Check to see if the battery polarity is correct.
5. Replace the battery.
6. Turn off other infrared-enabled devices in the vicinity.
7. Have the remote control serviced.



Audio Problems

Problem: There is no sound

1. Adjust the volume on the audio source.
2. Check the audio cable connection.
3. Test the output of the audio source with other speakers.
4. If using Bluetooth, Turn Bluetooth on in Settings and ensure that pairing has occurred.
5. Have Qumi serviced.

Problem: The sound is distorted

1. Check the connection of audio cable.
2. Use other loudspeaker to test output of audio source.
3. Have Qumi serviced



FAQs

- 1. Is it possible to connect Qumi to a game console, such as a Microsoft® Xbox or Sony® PS3?**

Yes, Qumi can be used to display content from an Xbox or PS3 console. This can be done by connecting the HDMI cable from the game console to Qumi.

- 2. Can Qumi project television content from cable or satellite?**

Watching television content can be done by connecting a cable box, digital set-top box or satellite receiver directly to Qumi. For example, if a cable box is used, it can be connected by an HDMI cable to Qumi.

- 3. How are images from a digital camera or a USB storage device displayed?**

Images and other content can be displayed by connecting the following devices to Qumi:

- USB flash drive, USB hard drive, USB camera
- SDMicro Card
- Smartphone
- Multimedia storage viewer

Once the devices are connected, images can be displayed by using Qumi Media Center on the Splash screen.

- 4. I lost my remote. Where can I get one from?**

Contact your Reseller or Vivitek via www.vivitekcorp.com and selecting your region, to obtain another one.

5. Which cable is required for video devices to be connected with Qumi?

Video devices can be connected to Qumi by using HDMI or MHL cable if the devices contain the appropriate ports.

6. What type of video formats does Qumi support?

AVI/RM/RMVB/TS/VOB/MLV/MOV/ISO/WMV/ASF/FLV/DAT/MPG/MPEG

7. What type of audio formats does Qumi support?

MP3/WMA/AAC/WAV/OGG/AC3/DDP/TrueHD/DTS/DTS/HD/FLAC/APE

8. What type of document formats does Qumi support?

Microsoft® Office 97-2010 (Word, Excel®, PowerPoint®), Adobe® PDF (1.0, 1.1, 1.2, 1.3, 1.4).

9. What type of photo formats does Qumi support?

JPEG/BMP/GIF/PNG

10. How long will the LED light source in Qumi last and can it be replaced?

Qumi does not use a typical light source. It uses a set of Light Emitting Diodes (LED) to illuminate and project images. LED's have a greater lifespan than conventional lamps. Qumi LED's are estimated to last for approximately 30,000 hours. The lifespan of the LED depends on factors such as brightness, usage, environmental conditions. LED brightness can decrease over time. The LED module is not replaceable.

11. Why do I need to re-adjust the focus on my Qumi after it's powered up?

For the best picture quality, adjustment of the remote controller's Zoom-In (+)/Zoom-Out (-) Keys may be necessary once the operational temperature has been met.



Vivitek Support Site

Please visit www.vivitekc corp.com and selecting your region for more information, support and product registration.

Specifications

Model	Qumi Q3 Plus Series
Native Resolution	HD720p (1280 x 720)
Projection Distance	0.7m - 3.7m (2.3ft – 12.1ft)
Projection Screen Size (Diagonal)	0.5m - 2.6m (19" - 100")
Projection Lens	Motorized focus feature on remote control
Throw Ratio	1.66:1
Vertical Keystone Correction	Vertical $\pm 35^\circ$ (± 35 Steps)/Digital Auto Keystone Correction
Projection Methods	Front, Rear, Front-Ceiling, Rear-Ceiling
Data Compatibility	VGA, SVGA, XGA, SXGA, SXGA+, UXGA, Mac
Video Compatibility	SDTV (480i), EDTV (480p), HDTV (720p, 1080i/p), NTSC/NTSC 4.43, PAL (B, D, G, H, I, M, N) 60, SECAM
Certifications	UL, CCC, CE, CB, BQB, FCC ID, WEEE, RoHS, SRRC, Reach,
Operating Temperature	5 to 45°C (40 to 113°F)
Dimensions (W x D x H)	176mm (6.9") x 102.5mm (4.0") x 29.6mm (1.2")
AC Input	AC Universal 100-240V
Power Consumption	36W
Audio Speaker	2W x2 (Stereo)
Wireless	Yes (Internal IEEE 802.11 b/g/n (2.4GHz))
Bluetooth	Yes (Bluetooth® 4.0)
Battery Type (Embedded)	Yes (8,000 mAh Li-Polymer Rechargeable Battery, up to 2 hours of usage)
RAM/Storage Expansion	RAM: 1GB DDR3, Internal: 8GB (eMMC Flash) (5.1GB User Availability), Expansion: microSD Card Slot (Up to 64GB), USB Flash Drive (Up to 64GB)
I/O Connection Ports	HDMI v1.4b, Audio-Out(AV-in) 3.5mm), USB (Type A) (x2), microSD Card Slot, Reset Button

Note:

For questions regarding product specifications, please contact your local reseller.



Projection Distance vs Projection Size

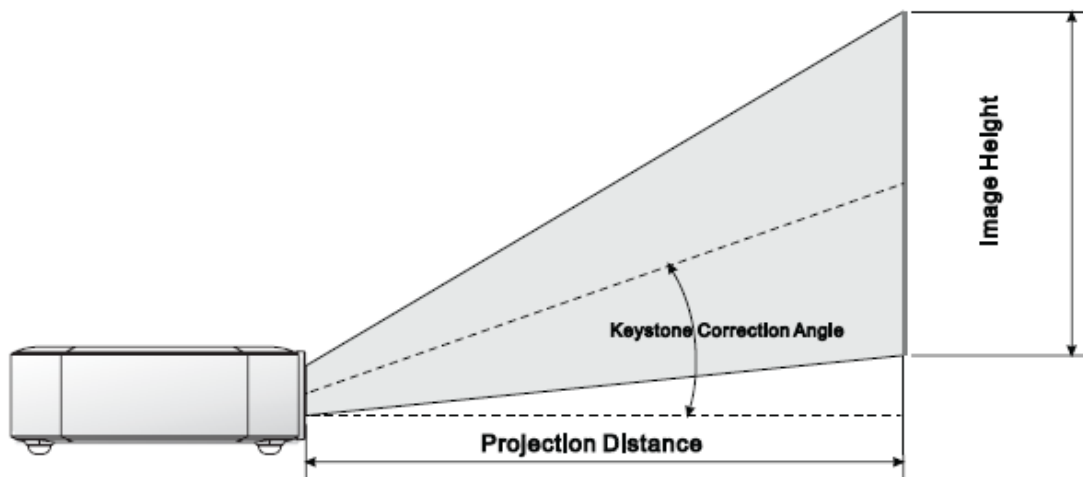

Projection Distance and Size Table

Image Diagonal (cm/inch)	Image Width (cm/inch)	Image Height (cm/inch)	Projection Distance (cm/inch)
76/30	66/26	37/15	110/43
102/40	89/35	50/20	147/58
127/50	111/44	62/25	184/72
152/60	133/52	75/30	220/87
178/70	155/61	87/34	257/101
203/80	177/70	100/40	294/116
229/90	200/78	112/44	331/130

Note:

The offset table has a 10% tolerance due to optical component variations.



Timing Mode Table

Signal	Resolution	Horizontal Synchronization (kHz)	Vertical Synchronization (Hz)	HDMI
VESA	720x400	37.9	85.0	O
	640x480	31.5	60.0	O
	640x480	37.9	72.0	O
	640x480	37.5	75.0	O
	640x480	43.3	85.0	O
	800x600	35.2	56.0	O
	800x600	37.9	60.0	O
	800x600	48.1	72.0	O
	800x600	46.9	75.0	O
	800x600	53.7	85.0	O
	800x600 (for 3D)	76.3	120.0	O
	1024x768	48.4	60.0	O
	1024x768	56.5	70.0	O
	1024x768	60.0	75.0	O
	1024x768	68.7	85.0	O
	1024x768 (for 3D)	97.6	120.0	O
	1280x800	49.7	59.8	O
	1280x800	62.8	74.9	O
	1280x800	71.6	84.8	O
	1280x1024	63.98	60.0	O
	1280x1024	79.98	75.0	O
	1280x1024	91.1	85.0	O
	1400x1050	65.3	60.0	O
	1440x900	55.9	60.0	O
	1600x1200	75.0	60.0	O
	1920x1080	67.2	60.0	O
Apple® Mac	640x480	35.0	66.68	O
	832x624	49.725	74.55	O
	1024x768	60.24	75.0	O
	1152x870	68.68	75.06	O
SDTV	480i	15.734	60.0	O
	576i	15.625	50.0	O
EDTV	480p	31.469	60.0	O
	576p	31.25	50.0	O
HDTV	720p	37.5	50.0	O
	720p	45.0	60.0	O
	1080i	33.8	60.0	O
	1080i	28.1	50.0	O
	1080p	67.5	60.0	O
	1080p	56.3	50.0	O

O: Available frequency

-: Unavailable frequency

*: Display level

Qumi Dimensions

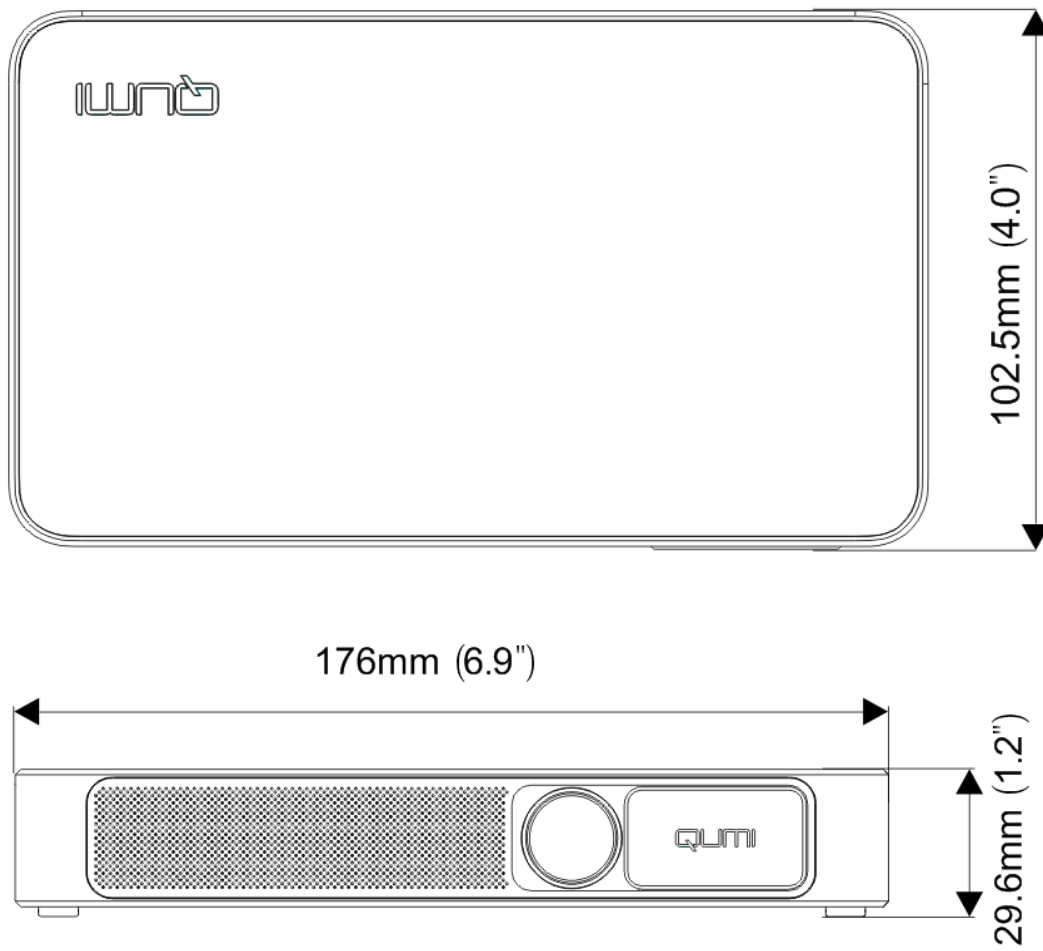

Regulatory Compliance

FCC Warning

This equipment has been tested and found to comply with the limits for a Class B digital device pursuant to Part 15 of the FCC Rules. These limits are designed to provide reasonable protection against harmful interference when the equipment is operated in a commercial environment.

This equipment generates, uses, and can radiate radio frequency energy and, if not installed and used in accordance with the instruction manual, may cause harmful interference to radio communications. Operation of this equipment in a residential area is likely to cause harmful interference in which case the user will be required to correct the interference at his/her own expense.

Any Changes or modifications not expressly approved by the parties responsible for compliance could void the user's authority to operate the equipment.

Canada

This class B digital apparatus complies with Canadian ICES-003.

Safety Certifications

Projector: CENB, REACH, ROHS, WEEE, FCCID, UL, CCC, SRRC, CB, BQB;

Power Adapter: DOE, WEEE, FCC, UL, EAC, TUV-GS, CB, PSB, TUV-S, EAC, KCC, CCC, CECP, BIS, BSMI, ISC,

Disposal and Recycling

This product may contain other electronic waste that can be hazardous if not disposed of properly. Recycle or dispose in accordance with local, state, or federal Laws. For more information, contact the Electronic Industries Alliance at www.eiae.org.



205 Westwood Ave, Long Branch, NJ 07740

Phone: 866-94 BOARDS (26273) / (732)-222-1511

Fax: (732)-222-7088 | E-mail: sales@touchboards.com