



D366 Series Digital Laser Projector

USER MANUAL

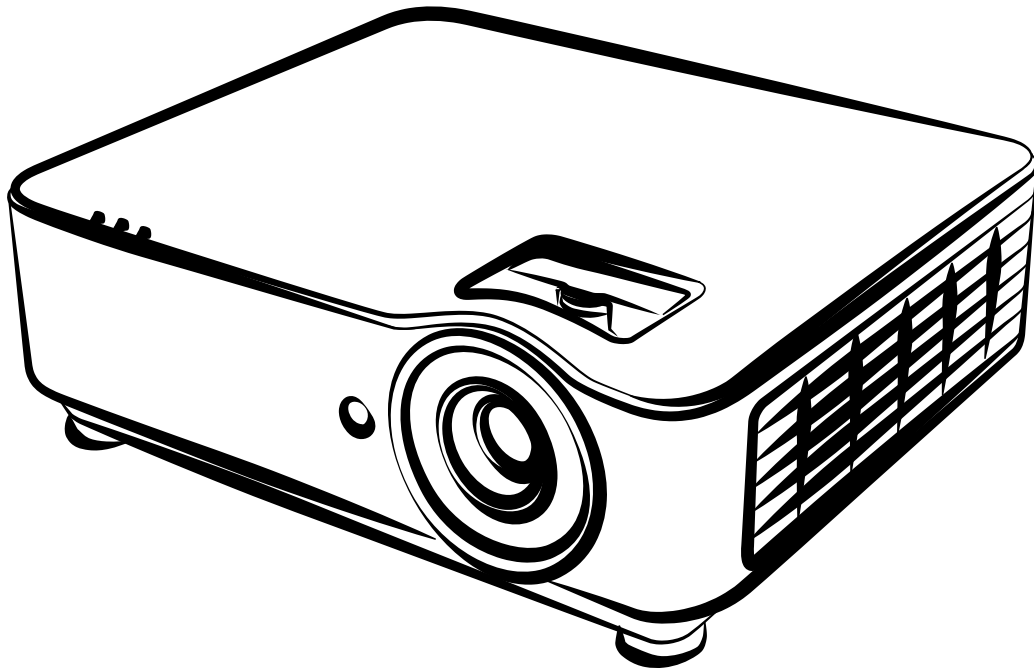

Table of Contents

1.General Information	5
Copyright	5
Disclaimer	5
Trademark Recognition	5
Important Safety Information	6
Symbols used	6
General Safety Information.....	6
Symbols used	6
Laser Warning	7
Class 2 Laser Product	7
Laser Parameter.....	7
Warning Labels	8
General Notice	9
Power Supply	9
Cleaning the Projector	9
Regulatory Warnings	9
Symbol Explanations	9
Special Care for Laser Beams!.....	9
Sun Light Warning	9
2.Getting Started	10
Package Content	10
Projector Features	11
Projector Functions	11
Connect Source Devices (DH3660Z)	12
Control Keypad.....	12
Connect Source Devices (DU3661Z)	13
Control Keypad.....	13
Remote Controller (SRC) + Function	14
Operating Range	15
Batteries	15
Combo Key Settings.....	15
Installation Guide	16
Verify Installation Location.....	16
Cooling Notes	16
Installation Notice	17
Setup and Projection options.....	17
Mounting the Projector	18
Custom Stand Mount Installation compliances.....	18
Projection Distance vs. Projection Size	19

Table of Contents

Projector Start Guide	20
1 Connect Power and Source Devices	20
2 Power ON/OFF	20
3 Select Source Device	20
4 Adjust Projector Tilt.....	21
5 Adjust Projector Lens.....	21
Adjusting the vertical image position	22
3.On-Screen Display (OSD) Menu Settings	23
OSD Menu Control	23
Navigating the OSD.....	23
INPUT Menu	24
Auto Source.....	24
HDMI	24
Video	25
Analog	25
3D.....	25
Signal Power on	25
PICTURE Menu	26
Picture Mode	26
Brightness.....	27
ViviBlack	27
Color Manager.....	27
Advanced.....	27
Picture Mode Reset	27
ALIGNMENT Menu	28
Digital Zoom	28
V Keystone	28
H Keystone	28
4 Corner.....	28
H Image Shift.....	29
V Image Shift	29
Projection.....	29
Test Pattern	29
CONTROL Menu	30
Direct Power On	30
Light Source	30
High Altitude	30
IR Control	31
Remote ID	31
HDBaseT	31
Network	31

Table of Contents

SETTINGS Menu	38
Audio	38
Blank Screen Color.....	39
Menu.....	39
Keypad Lock.....	39
Security Lock	39
Language.....	39
Reset All	40
INFO Screen	40
4.Troubleshooting	41
Common Problems and Solutions	41
Troubleshooting Tips	41
LED Error Messages	42
Image Problems Q&A.....	42
Light Source Problems	43
Remote Control Problems	43
Audio Problems	43
Having the Projector Serviced	43
HDMI Q&A.....	44
5. Specifications	45
Projector Dimensions	45
Projector DataSheet	46
Projector Time Table.....	47
6. Regulatory Compliance	49
FCC Warning	49
Canada	49
Safety Certifications.....	49
Disposal and Recycling	49
7. RS-232 Communication	50
Communication parameter setup	50
Operation commands	50

1.General Information

Copyright

This publication, including all photographs, illustrations and software, is protected under international copyright laws, with all rights reserved. Neither this manual, nor any of the material contained herein, may be reproduced without written consent of the author. © Copyright 2019

Disclaimer

The information in this document is subject to change without notice. The manufacturer makes no representations or warranties with respect to the contents hereof and specifically disclaims any implied warranties of merchantability or fitness for any particular purpose. The manufacturer reserves the right to revise this publication and to make changes from time to time in the content hereof without obligation of the manufacturer to notify any person of such revision or changes.

Trademark Recognition



Kensington is a U.S. registered trademark of ACCO Brand Corporation with issued registrations and pending applications in other countries throughout the world.



HDMI, the HDMI Logo, and High-Definition Multimedia Interface are trademarks or registered trademarks of HDMI Licensing LLC in the United States and other countries.



HDBaseT™ and the HDBaseT Alliance logo are trademarks of the HDBaseT Alliance.

All other product names used in this manual are the properties of their respective owners and are acknowledged.

Important Safety Information

**Important:**

It is strongly recommended that you read this section carefully before using the projector. These safety and usage instructions will ensure that you enjoy many years of safe use of the projector.

Keep this manual for future reference.

Symbols used

Warning symbols are used on the unit and in this manual to alert you of hazardous situations.

The following styles are used in this manual to alert you to important information.

Note:

Provides additional information about the topic.

**Important:**

Provides additional information that should not be overlooked.

**Caution:**

Alerts you to situations that may damage the unit.

**Warning:**

Alerts you to situations that may damage the unit, create a hazardous environment, or cause personal injury.

Throughout this manual, component parts and items in the OSD menus are denoted in bold font as in this example:

“Push the **Menu** button on the remote control to open the **Main** menu.”

General Safety Information

- Do not open the unit case. There are no user-serviceable parts in the unit. For servicing, contact qualified service personnel.
- Follow all warnings and cautions in this manual and on the unit case.
- To avoid damage to eyes, do not look into the lens when the light source is on.
- Do not place the unit on an unstable surface, cart, or stand.
- Avoid using the system near water, in direct sunlight, or near a heating device.
- Do not place heavy objects such as books or bags on the unit.

Symbols used

This product is intended for the adults who have the ability to operate this machine.

Please write down your projector model number and serial number and keep the information for maintenance purposes in the future. Should the equipment be lost or stolen, the information could also be used for the police report.

Model number:

Serial number:

Laser Warning

Class 2 Laser Product

This Laser Product is designated as Class 2 during all procedures of operation.



LASER LIGHT - AVOID DIRECT EYE EXPOSURE.

Do not point laser or allow laser light to be directed or reflected toward other people or reflective objects .



Direct or scattered light can be hazardous to eyes and skin.

There is a potential hazard of eye exposure to laser radiation if the included instructions are not followed.

Caution – use of controls or adjustments or performance of procedures other than those specified herein may result in hazardous radiation exposure

Laser Parameter

Wavelength	449nm - 461nm (Blue)
Mode of operation	Pulsed, due to frame rate
Pulse width	1.34ms
Pulse repetition rate	120Hz
Maximum laser energy	0.13mJ
Total internal power	>100w
Apparent source size	>10mm, at lens stop
Divergence	>100 mili Radian

As with any bright light source, do not stare into the beam.

RG2 IEC 62471-5:2015.

Warning Labels

Safety Hazard and Warning information Labels are placed at the following locations:

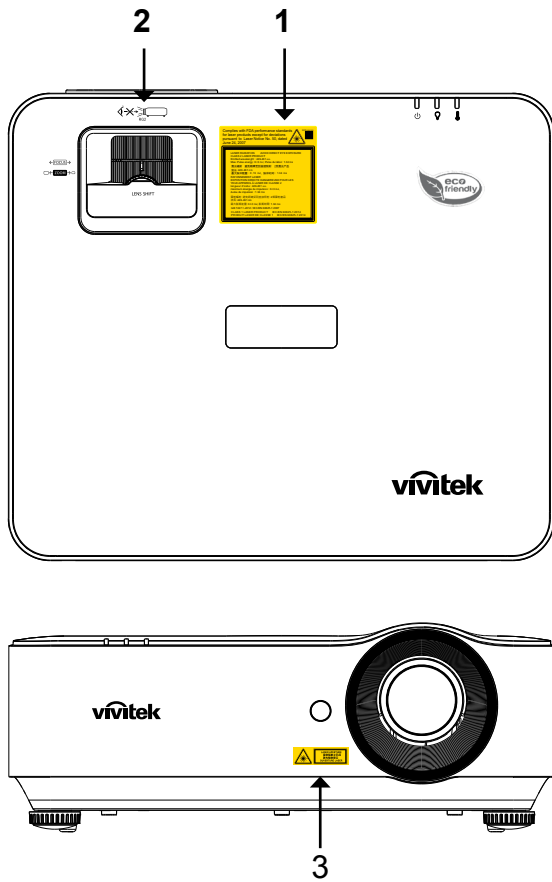

1. Explanatory Label



2. RG2 Label

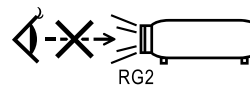

3. Hazard Warning Symbol and Aperture Label



General Notice

Power Supply

- Only use the supplied power cord.
- Do not place anything on the power cord. Place the power cord where it will not be in the way of foot traffic.
- Remove the batteries from the remote control when storing or not in use for a prolonged period.

Cleaning the Projector

- Unplug the power cord before cleaning. See Cleaning the Projector on page 9.
- Allow the light source to cool for about one hour.

Regulatory Warnings

Before installing and using the projector, read the regulatory notices in the Regulatory Compliance on page 49.

Symbol Explanations



DISPOSAL: Do not use household or municipal waste collection services for disposal of electrical and electronic equipment. EU countries require the use of separate recycling collection services.

Special Care for Laser Beams!

Special care should be considered when DLP projectors and high power laser equipment are used in the same room as. Direct or indirect hit of a laser beam on to the projector lens can severely damage the Digital Mirror Devices (DMD™).

Sun Light Warning

Avoid using the D366 Series in direct sun light. Sun light on the projector lens can severely damage the Digital Mirror Devices (DMD™).

2.Getting Started

Package Content

Carefully unpack the projector and check that the following items are included:

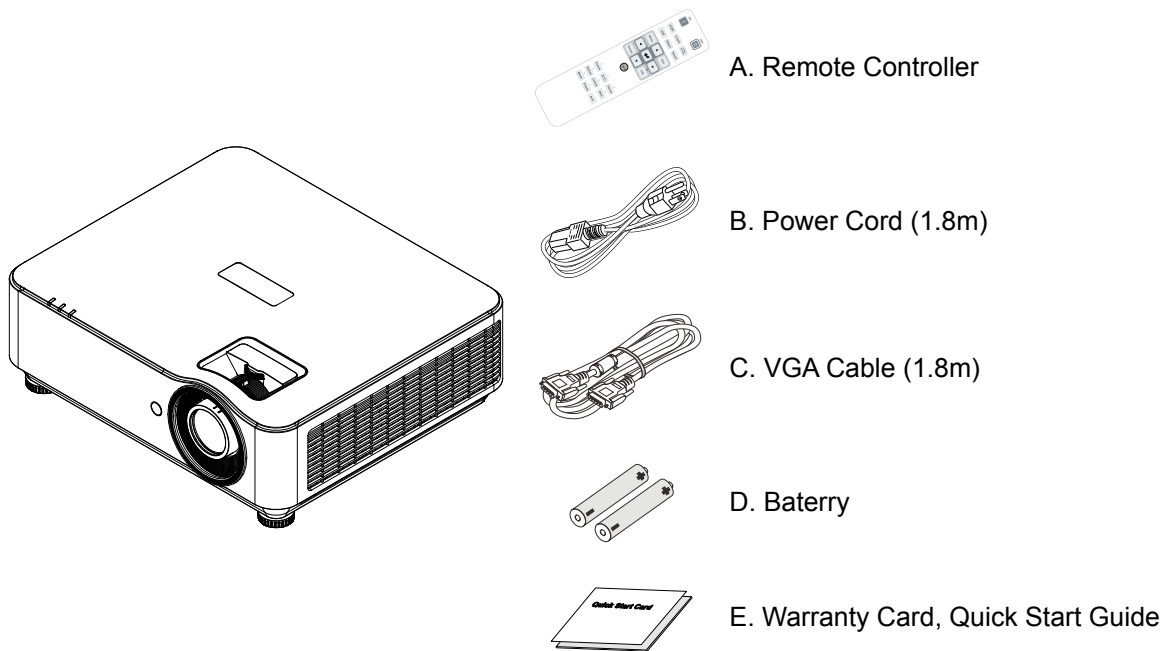

Note:

Contact your dealer immediately if any items are missing, appear damaged, or if the unit does not work. It is recommended that you keep the original packing material should you ever need to return the equipment for warranty service.



Caution:

Avoid using the projector in dusty environments.

Projector Features

- DLP® DarkChip3™ and BrilliantColor™ technologies for optimal black levels and vibrant colorful images
- Full 1080P(1920x1080) (DH3660Z model) and WUXGA (1920x1200)(DU3661Z model) resolution perfect for HD multimedia presentations and movies
- 4500 ANSI lumens(DH3660Z) and 5000 ANSI lumens(DU3661Z) with a dynamic 20,000:1 contrast ratio for an amazing image quality
- Solid-state laser phosphor light source for reliable projection and performance
- Manual zoom and focus for easy adjustment and positioning flexibility
- Vertical lens shift and 1.5x zoom ratio for greater installation convenience and flexibility
- 4 segment RGBY color wheel for improved and vivid color reproduction
- Environmentally friendly lamp-less design with an operating time up to 20,000 hours
- Project 3D content from DLP® Link™, and BluRay HDMI 1.4b for realistic life-like images
- Built-in 10W audio speaker with multiple audio-in and audio-out ports
- 360° operation and projection design for set up in all angles
- Portrait mode projection allows the projector to be easily setup and installed in a 90° installation
- Airtight sealed engine and filter-less design for improved performance against fighting dust and fibers
- Integrated network monitoring and management solutions (product certified) including Crestron® RoomView™, Extron, AMX SSDP and Telnet
- Choice of 8 pre-set display scenario modes to get the most suitable display image
- Instant on/off for immediate power on or shut down
- Anti-theft security features include: Kensington® security slot, security bar, and password protected keypad lock.

Projector Functions

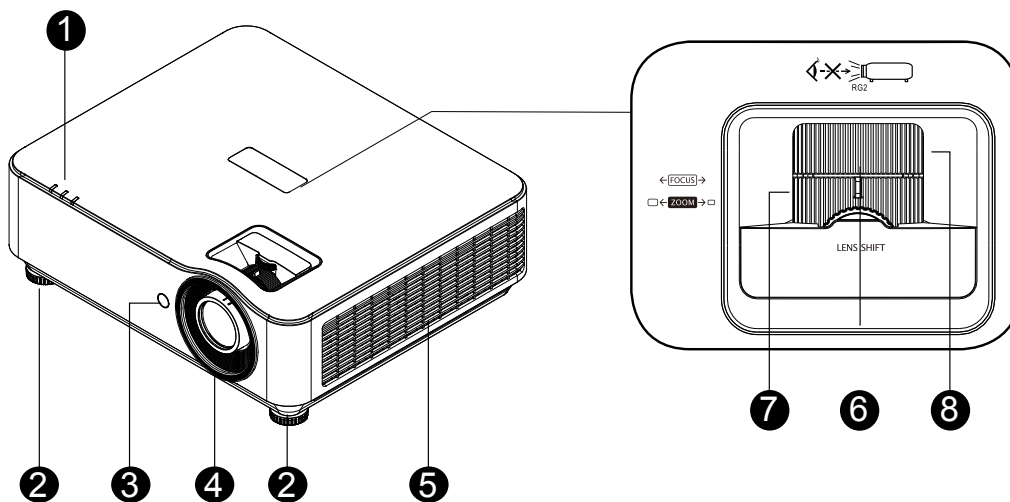

1. LED Indicator
2. Tilt Foot
3. IR Receiver
4. Lens
5. Air Vents

6. Lens Shift (vertical)
7. Lens Zoom
8. Lens Focus



Important:



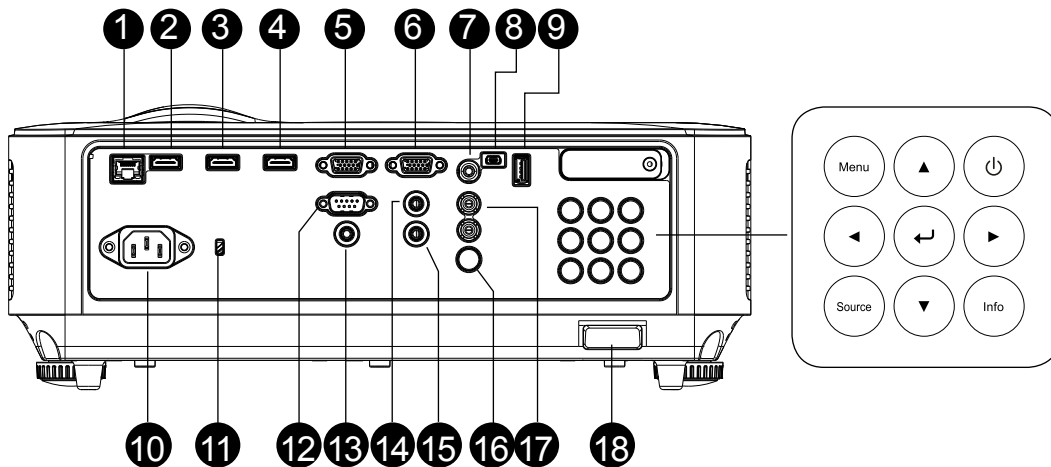

Ventilation openings on the projector allow for good air circulation, which keeps the projector light source cool. Do not obstruct any of the ventilation openings.

Connect Source Devices (DH3660Z)



1. RJ45 + function
2. HDMI 1
3. HDMI 2
4. HDMI 3
5. Monitor OUT
6. Computer
7. Video
8. Service
9. USB Power (5V.1.5A)
10. AC IN
11. Kensington Security
12. RS232
13. Audio OUT
14. Audio IN
15. Mic IN
16. IR Receiver
17. Audio IN R/L
18. Security lock

Control Keypad

-  Power I/O
-  Menu
-  Source
-  Info
-  Enter
-  Navigate ▲ ▼ ◀ ▶

Connect Source Devices (DU3661Z)

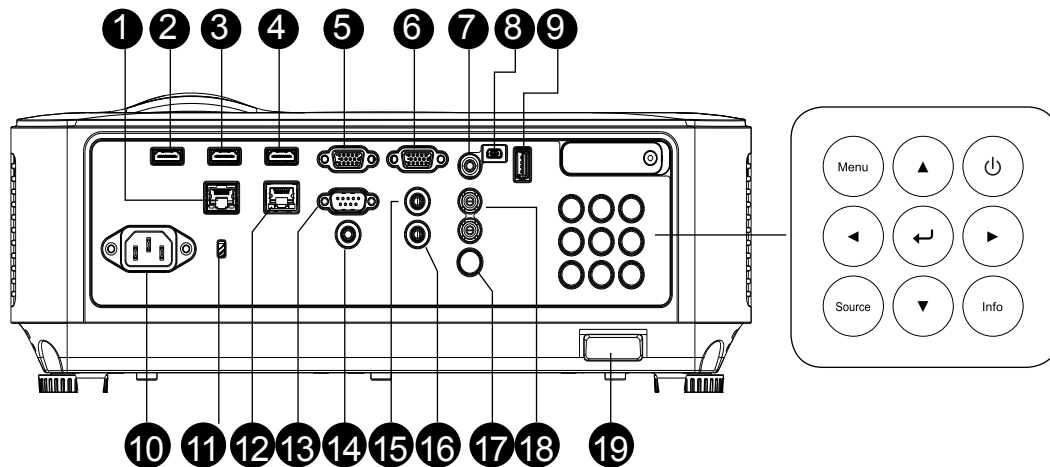

1. RJ45 + function
2. HDMI 1
3. HDMI 2
4. HDMI 3
5. Monitor OUT
6. Computer
7. Video
8. Service
9. USB Power (5V.1.5A)
10. AC IN
11. Kensington Security
12. HDBaseT
13. RS232
14. Audio OUT
15. Audio IN
16. Mic IN
17. IR Receiver
18. Audio IN R/L
19. Security lock

Control Keypad

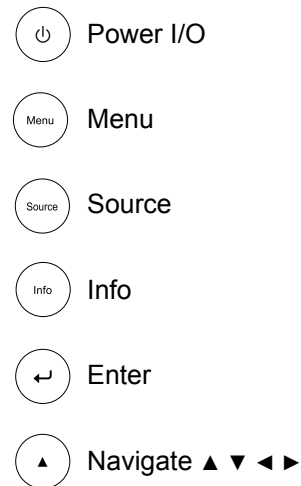

Note:

When the projector is under MHL mode, The keypad on projector should be with the same definition of the key on remote control.

MENU for App settings, ▲ Up, ▼ Down, ◀ Left and ▶ Right are used as directional arrows, also included ENTER and EXIT.

Controlling your smart device with the remote control:



Warning:

As a safety precaution, disconnect all power to the projector and connecting devices before making connections.

Remote Controller (SRC) + Function

1. IR Transmitter
2. Laser Pointer
3. Power ON
4. Power OFF

Connectivity

5. HDMI
6. Computer
7. USB
8. Video / S-Video
9. HDBaseT (DH3660z not supported)
10. Network

Functions

11. Menu
12. Source
13. Exit
14. Info / ID
15. Navigation
16. Laser Pointer

Settings

17. ECO / ID 1
18. Keystone / ID 0
19. Brightness / ID 3
20. Blank / ID 6
21. Contrast / ID 4
22. Freeze / ID 7
23. Volume / ID 2
24. Mute / ID 5
25. Auto

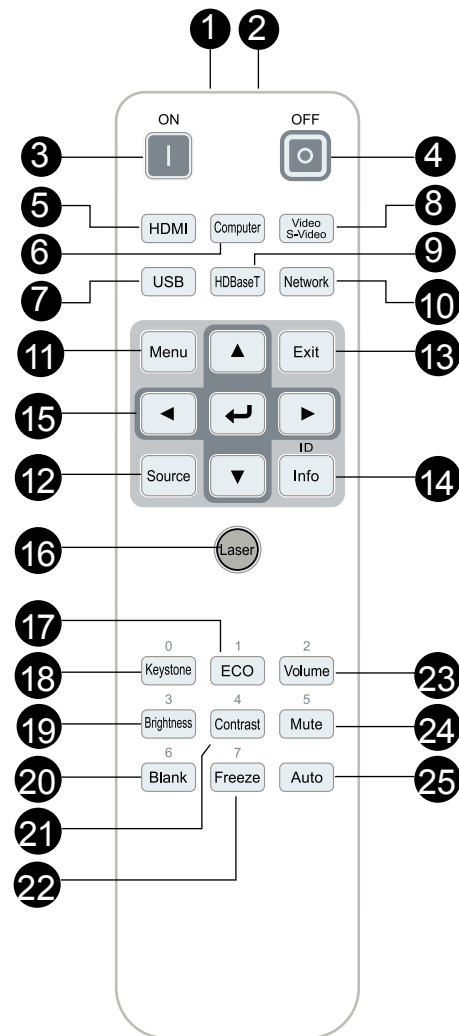

Important:

1. Avoid using the projector with bright fluorescent lighting turned on. Certain high-frequency fluorescent lights can disrupt remote control operation.

2. Be sure nothing obstructs the path between the remote control and the projector. If the path between the remote control and the projector is obstructed, you can bounce the signal off certain reflective surfaces such as projector screens.

3. The buttons and keys on the projector have the same functions as the corresponding buttons on the remote control. This user's manual describes the functions based on the remote control.

Note:

Complies with FDA performance standards for laser products except for deviations pursuant to Laser Notice No. 50, dated June 24, 2007



Caution:

Use of controls, adjustments or performance of procedures other than those specified herein may result in hazardous laser light exposure.

Operating Range

- The Remote Controller uses infrared transmission to control the projector.
- It is not necessary to point the remote directly at the projector.
- The Remote Controller will function properly within a distance radius of about 7 meters (23 feet) and vertical angle of 15 degrees above or below the projector level.

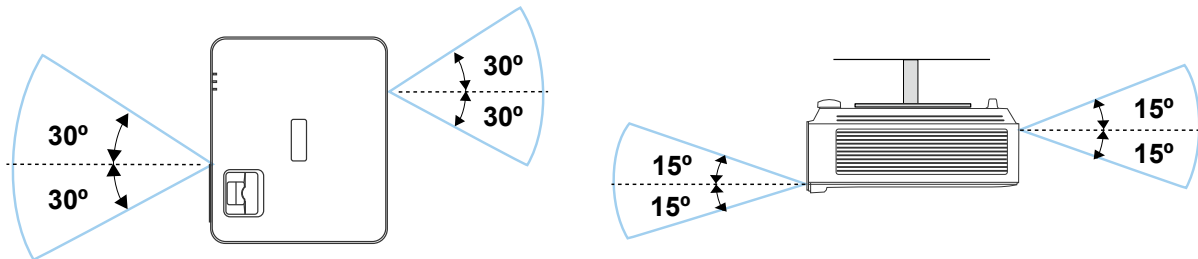

Note:

If the projector does not respond to the Remote Controller, Move to a closer range or Replace batteries.

Batteries

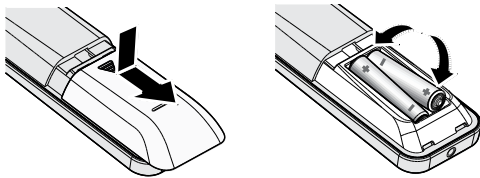

- Slide IN/OUT the battery compartment cover.
- Insert the battery with the positive side facing up.



Caution:

1. Only use AAA batteries (Alkaline batteries are recommended).
2. Dispose of used batteries according to local ordinance regulations.
3. Remove the batteries when not using the projector for prolonged periods.

Combo Key Settings

ID+0: Reset Remote Controller customer code to default settings.

ID+(1~7): Set Remote Controller customer code to "1~7".

Installation Guide

Verify Installation Location

- To supply power, use the 3-blade (with earthing lead) socket to ensure proper grounding and equalized ground potential for all Projector System equipments.
- Use the power cord provided with the Projector. In case the item is missing, use a qualified 3-blade (with earthing lead) power cord; **DO NOT USE 2-BLADE POWER CORD.**
- Verify that the voltage is stable, grounded properly and there is no electricity leakage.
- Measure the total power consumption and ensure it is within the safety capacity to avoid safety issue and short circuit.
- Turn on Altitude Mode when located in high altitude areas
- The projector can only be installed upright or inverted.
- Ensure installation brackets are firmly secured and can support the projector weight
- Avoid installing near air conditioner duct or sub-woofer.
- Avoid installing in locations with high temperature, insufficient cooling and heavy dust.
- Keep away from fluorescent lamps (>1 Meter) to avoid malfunction caused by IR interference
- Ensure the VGA IN connector is connected tightly to the VGA IN port. The screws on both sides securely fastened will secure the proper connection and wire signal to achieve optimal display.
- The AUDIO IN connector should only be connected to the AUDIO IN port. **DO NOT** connect to AUDIO OUT port or any other ports like BNC, RCA;
- Before you Power ON, ensure power cord and signal cable are connected properly. To avoid damaging the projector while starting and operating, **DO NOT** insert or remove the signal cable or the power cord.

Cooling Notes

Air Outlet

- Make sure the air outlet is 50cm clear of any obstruction to ensure proper cooling.
- Air outlet location should not be in front of the lens of other projector to avoid causing illusions.
- Keep the outlet at least 100cm away from the inlets of other projectors
- The projector generates a massive amount of heat during use. The internal fan dissipates the heat of the projector when shutting down, and such process may continue for a certain period. After the project enters STANDBY MODE status, press the AC power button to turn off the projector and remove the power cord. **DO NOT** remove the power cord during the shut-down process, as it may cause damage to the projector. In the meantime, the delayed heat radiating will also affect the service life of the projector. The shut-down process may vary depending on the model used. Whatever the case may be, make sure to disconnect the power cord till after the projector enters the STANDBY status.

Air Inlet

- Make sure there is no object blocking air input within 30 cm.
- Keep the inlet away from other heat sources
- Avoided heavy dust area

Installation Notice

- The projector can be installed and will function properly without limitation at any angle or orientation

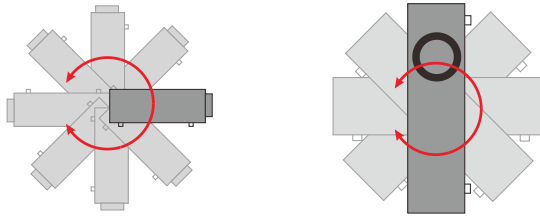

- Insure a minimum clearance space of > 500mm (19.7 inch) around all exhaust vents.

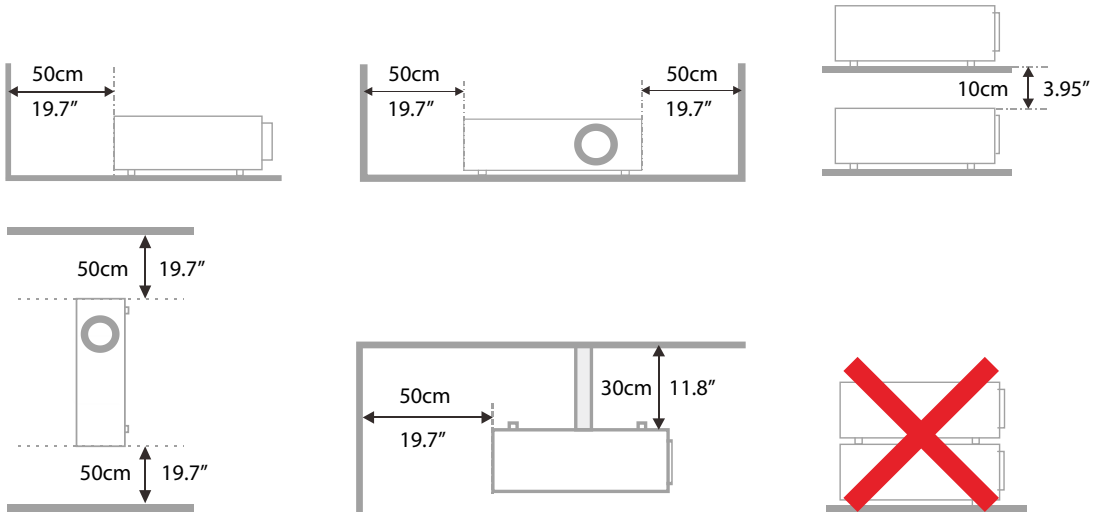

- When operating the projector in an enclosed space, ensure that the surrounding air temperature does not exceed the maximum allowed operating temperature and that all air intake and exhaust vents are unobstructed.

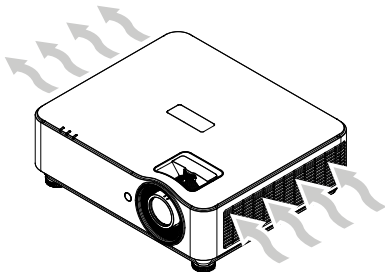

- Ensure that the intake vents do not recycle hot air or exhaust air from the exhaust vents as this may cause the device to shut-down even if the enclosure temperature is within the acceptable operating temperature range.
- All enclosures should pass a certified thermal evaluation to ensure that the projector does not recycle exhaust air.

Setup and Projection options

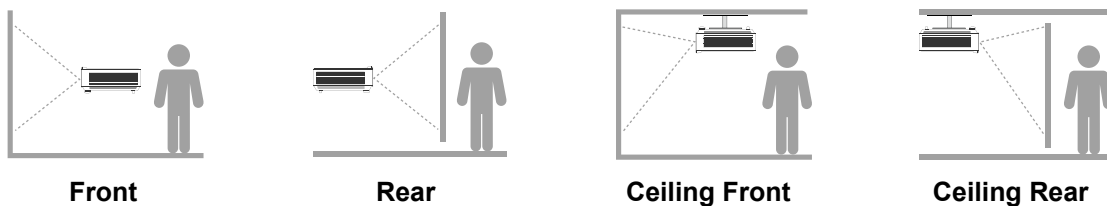

Mounting the Projector

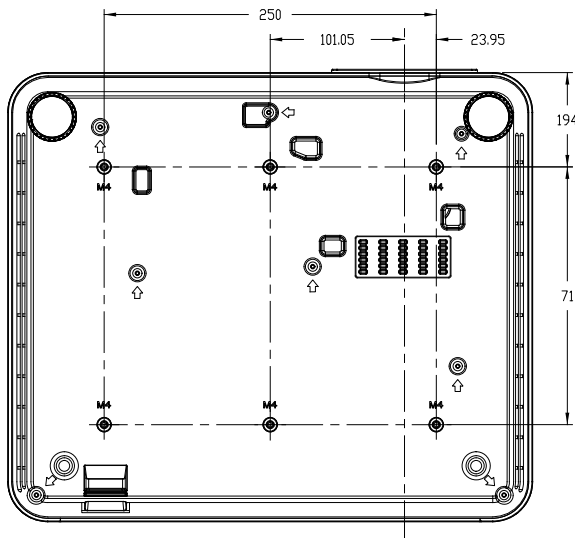

Caution: When installing, ensure that you use only UL Listed ceiling mounts.

For ceiling installations, use approved mounting hardware and M4 screws with a maximum screw depth of 8mm (0.315 inch).

The construction of the ceiling mount must be of a suitable shape and strength. The ceiling mount load capacity must exceed the weight of the installed equipment, and as an additional precaution be capable of withstanding three times the weight of the equipment over a period of 60 seconds.

Custom Stand Mount Installation compliances

For custom design mount installation such as portait, Please comply to the following :

- Use 6 screws to securely anchor the projector to the mount.
- Screw hole center dimension: 71 × 250 (pitch = 125) mm
- Ensure a sturdy base design to support the projector weight and avoid toppling over.

Note:

The drawing showing below is for referal only. It is not an accurate stand design drawing.

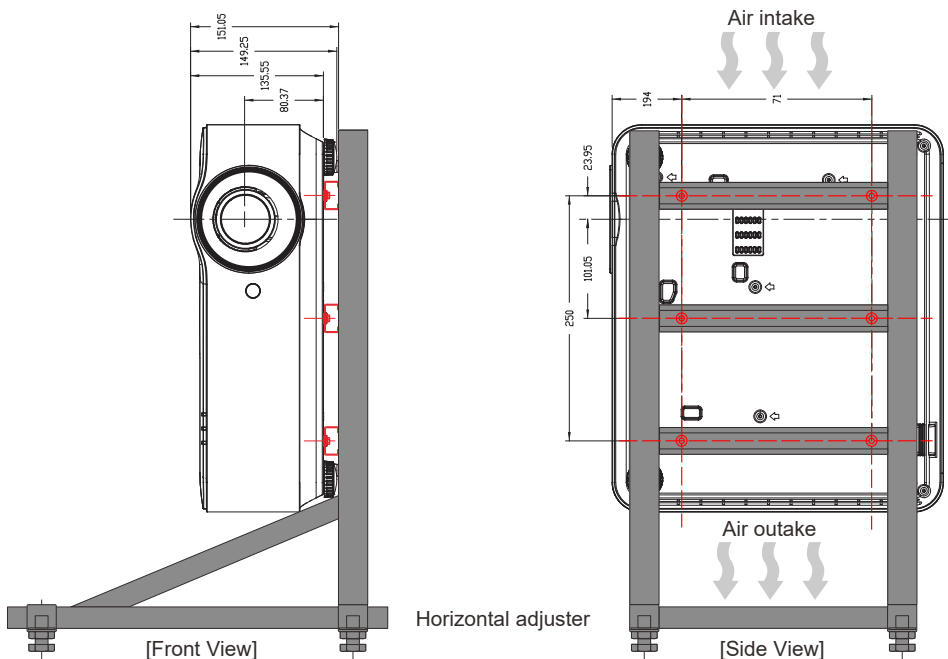

Projection Distance vs. Projection Size

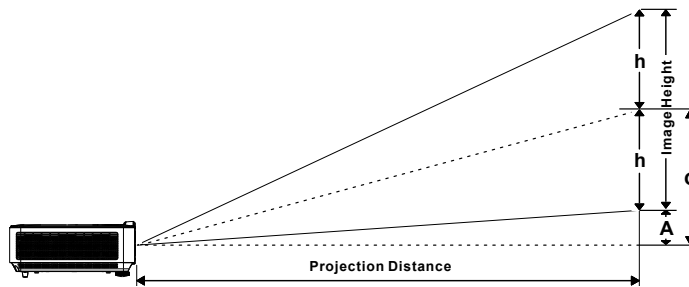

Distance and Size Table

DH3660Z (1080P)

Standard projection lens: TR 1.39~2.09; offset = 115%

Image Diagonal	Image Width		Image Height		Projector Distance (From)		Projector Distance (To)		Offset-A
	inch	cm	inch	cm	cm	inch	cm	inch	
50	110.7	43.6	62.3	24.5	154.7	60.9	231.3	91.1	93.4
60	132.8	52.3	74.7	29.4	185.7	73.1	277.6	109.3	112.1
70	155.0	61.0	87.2	34.3	216.6	85.3	323.9	127.5	130.8
80	177.1	69.7	99.6	39.2	247.6	97.5	370.1	145.7	149.4
90	199.2	78.4	112.1	44.1	278.5	109.7	416.4	163.9	168.1
100	221.4	87.2	124.5	49.0	309.5	121.8	462.7	182.2	186.8
120	265.7	104.6	149.4	58.8	371.4	146.2	555.2	218.6	224.1
140	309.9	122.0	174.3	68.6	433.3	170.6	647.8	255.0	261.5
160	354.2	139.5	199.2	78.4	495.2	195.0	740.3	291.5	298.9
200	442.8	174.3	249.1	98.1	619.0	243.7	925.4	364.3	373.6
250	553.5	217.9	311.3	122.6	773.7	304.6	1156.7	455.4	467.0
300	664.1	261.5	373.6	147.1	928.5	365.5	1388.1	546.5	560.4

DU3661Z (WUXGA)

Standard projection lens: TR 1.39~2.09; offset = 108.5%

Image Diagonal	Image Width		Image Height		Projector Distance (From)		Projector Distance (To)		Offset-A
	inch	cm	inch	cm	cm	inch	cm	inch	
50	107.7	42.4	67.3	26.5	149.7	58.9	225.1	88.6	57.2
60	129.2	50.9	80.8	31.8	179.6	70.7	270.1	106.3	68.7
70	150.8	59.4	94.2	37.1	209.6	82.5	315.1	124.1	80.1
80	172.3	67.8	107.7	42.4	239.5	94.3	360.1	141.8	91.5
90	193.9	76.3	121.2	47.7	269.5	106.1	405.2	159.5	103.0
100	215.4	84.8	134.6	53.0	299.4	117.9	450.2	177.2	114.4
120	258.5	101.8	161.5	63.6	359.3	141.4	540.2	212.7	137.3
140	301.5	118.7	188.5	74.2	419.2	165.0	630.2	248.1	160.2
160	344.6	135.7	215.4	84.8	479.0	188.6	720.3	283.6	183.1
200	430.8	169.6	269.2	106.0	598.8	235.7	900.3	354.5	228.9
250	538.5	212.0	336.5	132.5	748.5	294.7	1125.4	443.1	286.1
300	646.2	254.4	403.9	159.0	898.2	353.6	1350.5	531.7	343.3

Projector Start Guide

1 Connect Power and Source Devices

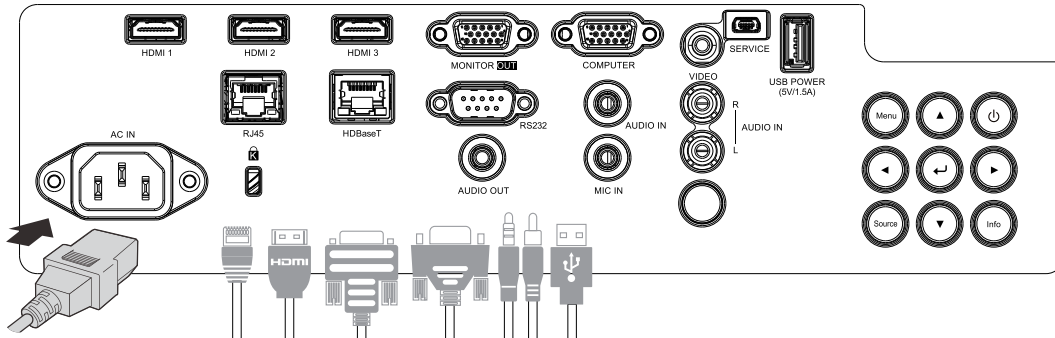

- Securely connect the provided power cord and your Source Devices. (HDMI, USB, VGA, RJ45, Computer, HDBaseT, etc.)
When connected, the power led will flash green to solid green.

2 Power ON/OFF

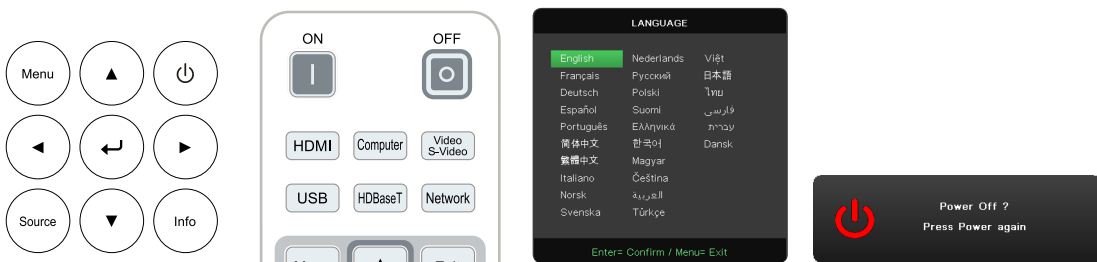

- Turn ON: Press **⏻** on the projector or **ON** the remote controller. The PWR LED will now flash green. The startup screen will display in approximately 30 seconds.
- The first time you Turn ON the projector, you can select your preferred language. see Setting Language on page
- Turn OFF: Press **⏻** on the projector or **OFF** on the remote controller. The message “Power Off? /Press Power again” will appears on-Screen Press the POWER button again to confirm the projector Turn OFF.

3 Select Source Device

- Press the **SOURCE** button and use **▼▲** to scroll through the Source Devices.
- Press **←** to select the Source Device.

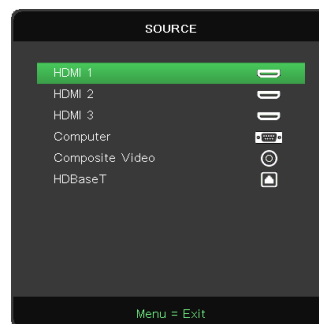



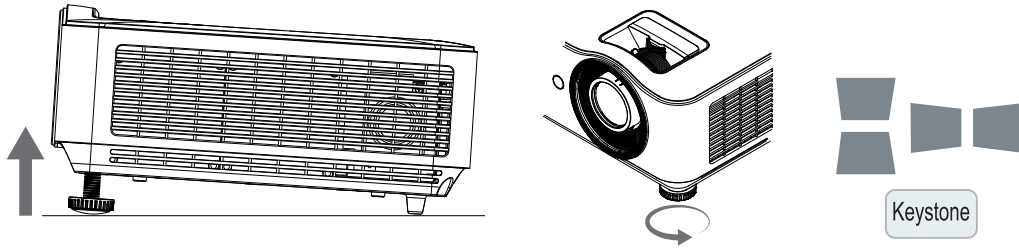

Note:
Component is supported through the RGB to Component adapter.
Only available in Audio and Video received.

Using a single HDBaseT CAT5e (above) cable, the projector supports an HDBaseT connection distances to 100m/328ft.

4 Adjust Projector Tilt



- To Raise the Tilt angle, Rotate counter clockwise both Left and Right Tilt foot.
- Press KEYSTONE button to adjust the Screen Tilt.
The Keystone control appears on the display.
Press  /  for V Keystone correcting image.
Press  /  for H Keystone correcting image.



Caution: When setting up the projector

1. The projector table or stand should be level and sturdy.
2. Position the projector so that it is perpendicular to the screen.
3. Ensure the cables are in a safe location. You could trip over them.

5 Adjust Projector Lens

Use the 3 control rings located on the projector top panel only

ZOOM

1. Rotate the Image-zoom control inner ring to resize the projected image and screen size.

The Lens-zoom range can be adjusted between 25% and -15% of display.

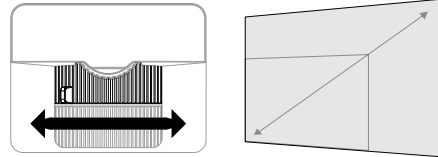

FOCUS

2. Rotate the Image-focus control outer ring to sharpen the projected image.

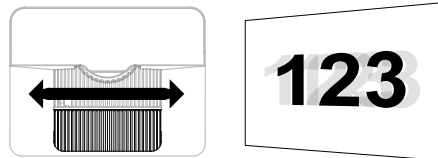

SHIFT

3. Rotate The Lens-Shift control top ring to adjust the vertical height of the projected image.

The vertical image height can be adjusted between 55% and -15% of offset position.

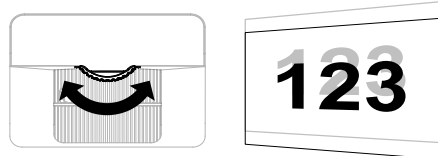

Note:

Shift is a unique system that provides lens shift while maintaining a much higher ANSI contrast ratio than traditional lens shift systems.

To view the Shift Range diagram and further clarification see page 22.

Adjusting the vertical image position

The vertical image height can be adjusted around 13% for 1080P and 11.7% for WUXGA of offset position. Note that the maximum vertical image height adjustment can be limited by the horizontal image position. For example it is not possible to achieve the maximum vertical image position height detailed above if the horizontal image position is at maximum. Please consult the Shift Range diagram below for further clarification.

Lens Shift Range Diagram

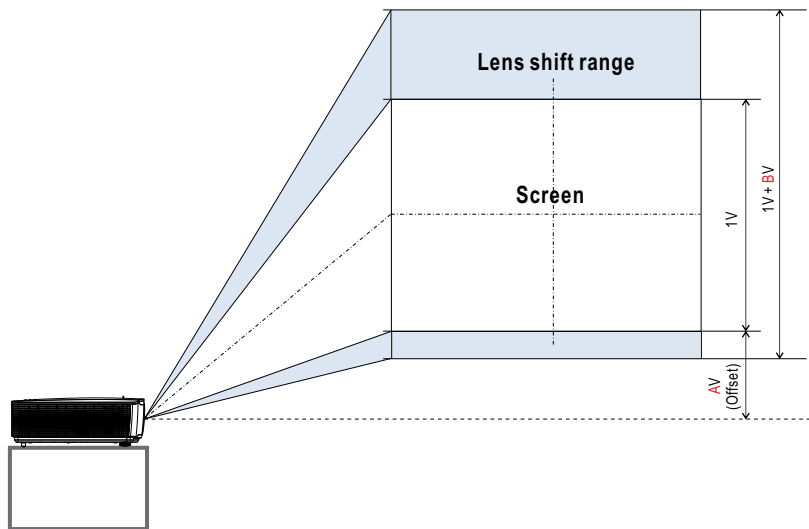

Lens Shift Range Table

	Offset (A)	Lens Shift V. (B)
1080P	15 %	13 %
WUXGA	8.5 %	11.7%

3.On-Screen Display (OSD) Menu Settings

OSD Menu Control

The On-Screen Display (OSD) lets you make image adjustments, change various settings and check the projector's current status.

Navigating the OSD

You can use the remote control or the control buttons on the projector to navigate and make changes to the OSD.

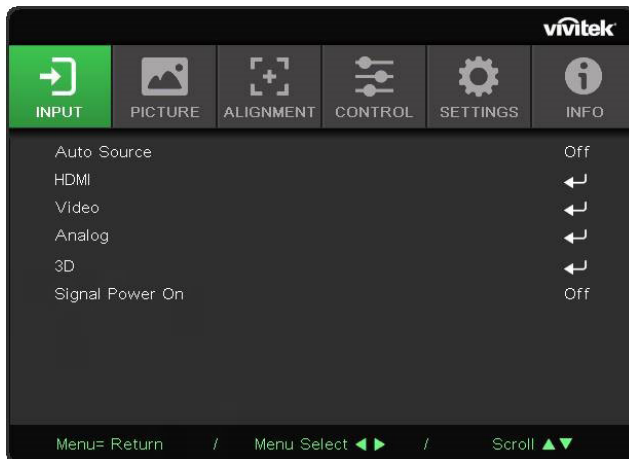

- To enter the OSD, press the MENU button.
- There are six top menu icons. Press ◀ / ▶ buttons to select menus.
- Press ▼/▲ buttons to scroll through the submenus.
- Press ◀ / ▶ buttons to change the submenus settings.
- Press ↶ to enter the advanced submenus settings
- Press the MENU button to close the OSD or leave a submenu.
- Press the EXIT button to return to the previous menu.

Note:

Depending on the video source, not all items in the OSD are available. For example, the Horizontal/Vertical Position items in the Computer menu can only be modified when connected to a PC. Items that are not available cannot be accessed and are grayed out.

INPUT Menu

Auto Source	On/Off
HDMI	HDMI Color Space: Auto, RGB, YUV
	HDMI Range: Auto, Full, Limited
	Instant Motion: On/Off
Video	Video AGC: On/Off
	Video Saturation
	Video Tint
	Closed Captioning: On/Off
Analog	H Position
	V Position
	Phase
	Clock
	Auto Sync: On/Off
3D	3D: Off, DLP-Link, IR
	3D Sync Invert: On/Off
	3D Format: Frame Sequential, Top/Bottom, Side by Side, Frame Packing
Signal Power on	On/Off

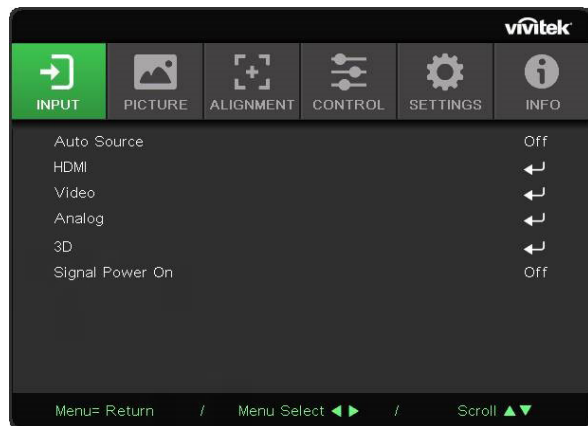







Auto Source

- Press **↶** and use **◀/▶** to set Off/ On.
- **Off:** Select the input signal manually.
- **On:** Lets projector searching for the input signal automatically..













HDMI

- Press **↶** and use **▼/▲** to scroll through submenus
- **HDMI Color Space:** set HDMI color space.
Auto: According to HDMI Info Frame to detect color space automatically.
RGB: Force to select RGB color space.
YUV: Force to select YUV color space.
- **HDMI Range:** Use **◀/▶** to set Auto/ Full/ Limited.
Auto: According to HDMI Info Frame to detect range automatically.
Full: Force to select Full Range(0~255).
Limited: Force to select Limited Range(16~235).
- **Instant Motion:**
Off: Disable the function and using normal alignment parameters.
On: Enable the function and alignment parameters return to default.









Video

- Press  and use / to scroll through submenus
- **Video AGC:**
On: enable video auto gain control.
Off: disable video auto gain control.
- **Video Saturation:**Use / to adjust saturation.
- **Video Tint:**Use / to adjust Green/ Red color.
- **Closed Captioning:**
On: enable video closed captioning.
Off: disable video closed captioning.

Analog

- Press  and use / to scroll through submenus
- **H Position:**Use / to adjust the display position in horizontal direction.
- **V Position:**Use / to adjust the display position in vertical direction.
- **Phase:**Use / to adjust and reduce the image distortion or unstable conditions
- **Clock:**Use / to adjust and reduce the image distortion or unstable conditions
- **Auto Sync:**use / to select on/off to lock image sync

3D

- Press  and use / to set 3D source, sync method and 3D format.
- Before performing 3D setting, make sure that the input signal with 3D sync is connected.
- **3D:**Use / to enable or disable 3D functions.
Off: disable 3D function.
DLP-Link: enable internal 3D sync.
IR: enable external 3D sync.
- **3D Sync Invert:**Use / to swap the 3D signal L/R or R/L.
On: enable inverse signal.
Off: follow auto lock signal.
- **3D Format:**Use / to select 3D format type :
Frame Sequential, Top/Bottom, Side By Side, Frame Packing.



Important:

People with the following conditions should view 3D image with great care:

Children under six years in age



People who are sensitive to light or allergic to light, unhealthy and have a history of cardiovascular diseases.

People who are tired or lack of sleep

People who are under the impact of drugs or alcohol

Normally, it is safe to watch 3D images. However, some people might feel uncomfortable. Refer to the guidelines that were revised and released by the 3D League on December 10, 2008. It states that those who watch 3D images, need to take a break for at least 5 to 15 minutes every thirty minutes or one hour.

Signal Power on

- Use / to set On/ Off to enable or disable auto Power On by input signal.

PICTURE Menu

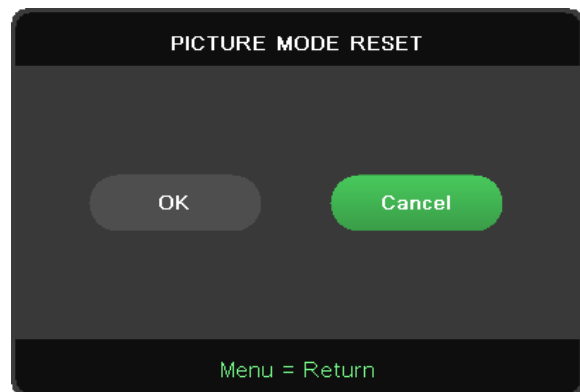
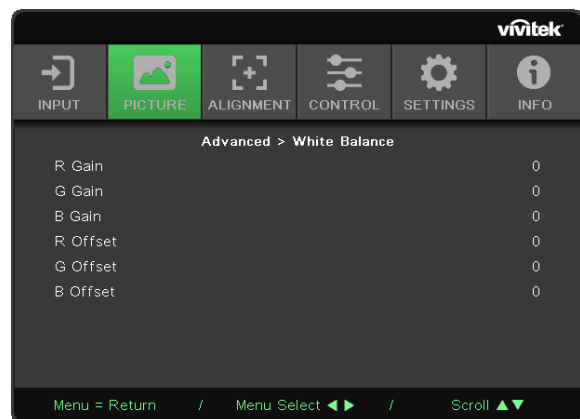
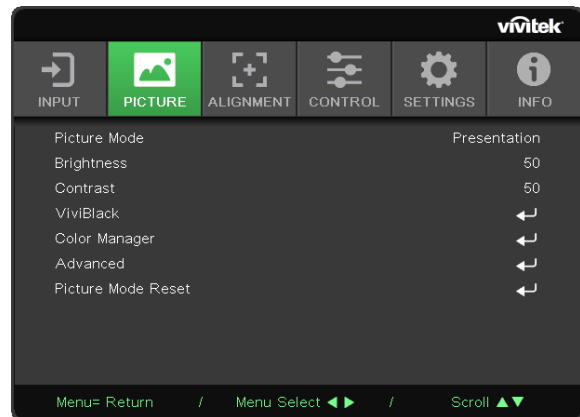

Picture Mode	Presentation
	Bright
	Movie
	Game
	sRGB
	DICOM
	User (Presentation)
Brightness	0~100
Contrast	0~100
ViviBlack	Projector Light: On/Off
Color Manager	Color: R / G / B / C / M / Y / W
	Hue: 0~100
	Saturation: 0~100
	Gain: 0~100
Advanced	Brilliant Color: 0~10
	Sharpness: 0~31
	Gamma: 1.8, 2.0, 2.2, 2.4, B&W, Linear
	Color Temperature: Warm, Normal, Cold
	White Balance: R/G/B Gain: 0~100 R/G/B Offset: 0~100
	Picture Mode reset





Picture Mode

- Use ◀/▶ to select a mode according to personal preference.
- **Presentation:** Suggest to use. The best projection effect for presentation.
- **Bright:** The mode is suitable for the application environment where is needed with highest brightness output .
- **Movie:** To provide good balance of color saturation, contrast and brightness. Suggest to use in a dark environment.
- **Game:** Using for video game.
- **sRGB:** Optimization RGB colors to reach true-to-life images with limited brightness setting.
- **DICOM:** To use for Digital Imaging and Communications in Medicine
- **User:** Personalization with preference of Brightness, Contrast, Color.

Brightness



- Press  and use  to increase or decrease the brightness level of the image.

Contrast





- Press  and use  to adjust the contrast level of the image..

ViviBlack









To enhance the black levels of the projected image dynamically per the content of the input signal.

- Press  and use  to scroll through submenus
- **Projector Light:** Use  to turn ON/OFF

Color Manager

- Press  and use  to scroll through submenus
- **Color:**to select and adjust the color(Red,Green,Blue,Cyan,Magenta,Yellow,White).
- **Hue:** Use  to adjust the Color Hue value
- **Saturation:** Use  to adjust the Color Saturation value
- **Gain:** Use  to adjust the Color Gain value
These three options are used to adjust the range of color input for the entire image. If minimal amount of red, green or blue appears in the gray areas, lower the gain of the corresponding color accordingly. As gain increases, the contrast of the image will become lower.

Advanced

- Press  and use  to scroll through submenus
- **Brilliant Color:** Use  to adjust the brilliant color of image
- **Sharpness:** Use  to adjust the sharpness of image
- **Gamma:** Use  to select the different chrominance of image.
When the ambient light is so bright that may affect the projection image in the dim area. , you can change the gamma to adjust the chrominance. The available options are 1.8, 2.0, 2.2, 2.4, B&W, Linear.
- **Color Temperature:** Use  to select the color temperature
Warm : make image reddish white.
Normal : Normal colorings of white.
Cold : make image bluish white.
- **White Balance:** Press  and use  to scroll through submenus
Use  to adjust Gain and Offset values of Red ,Green ,Blue color for white balance.
Gain: Adjust the brightness level of Red ,Green,Blue.
Offset: Adjust the contrast level of Red, Green,Blue.

Picture Mode Reset

This function will reset all Picture Mode to the default settings

Note:

"Picture Mode Reset " is only reset according to input signal.

ALIGNMENT Menu

Aspect Ratio	Fill / 4:3 / 16:9 (16:10) / Letter Box / 2.35:1
Digital Zoom	-10 ~ +10
V Keystone	-30 ~ +30
H Keystone	-30 ~ +30
4 Corner	Corner: Top-Left / Top-Right / Bottom-Left / Bottom-Right H: 0~60 V: 0~60
H Image Shift	-50 ~ +50
V Image Shift	-50 ~ +50
Projection	Front / Rear / Front+Ceiling / Rear+Ceiling
Test Pattern	Off / Grid



Aspect Ratio

- Use ◀/▶ to select the image aspect ration (Fill ,4:3 ,16:9 or 16:10 , Letter Box ,2.35:1)

Digital Zoom

- Use ◀/▶ to enlarge the projected image.

V Keystone

- Use ◀/▶ to adjust the value to correct the image Vertical distortion. The adjustable value is ±30

H Keystone

- Use ◀/▶ to adjust the Horizontal distortion of image. The adjustable value is ±30

4 Corner

This function is used to correct the image distortion that may occur in a corner due to installation or projected surface.

- Press ↶ and use ▼/▲ to scroll through submenus
- **Corner:** use ◀/▶ to select a corner (Top Left, Top Right, Bottom Left, Bottom Right)
- **H:** use ◀/▶ to increase or decrease the Horizontal value
- **V:** use ◀/▶ to increase or decrease the Vertical value

H Image Shift

- Use ◀/▶ to Shift the image Horizontally (left / right)
The maximum horizontal shift range can be up to 50%

V Image Shift

- Use ▲/▼ to Shift the image Vertically (up / down)
The maximum vertical shift range can be up to 50%

Projection

- Use ◀/▶ to select the Projection position
- **Front Desktop:** Install the projector on the desktop and project the image forward.
- **Rear Desktop:** Install the projector on the desktop and project the image from the rear of the screen.
- **Front Ceiling:** Mount the projector on the ceiling and project the image forward.
- **Rear Ceiling:** Mount the projector on the ceiling and project the image from the rear of the screen.

Test Pattern

- Use ◀/▶ to select Off / Grid , enable the test pattern image. the test pattern image

CONTROL Menu

Direct Power On	On/Off
Light Source	Light Mode: Normal (100%), Eco (80%)
	Custom Light: 25~100
High Altitude	Normal / High
IR Control	Front+Rear IR On/Front IR On/ Rear IR On
Remote ID	Default(0)/ 1/ 2/ 3/ 4/ 5/ 6/ 7
HDBaseT	On/Off
	RS232
	RJ45: On/Off
Network	Network State: Connect, Disconnect
	DHCP: On/Off
	IP Address: 0~255,0~255,0~255,0~255
	Subnet Mask: 0~255,0~255,0~255,0~255
	Gateway: 0~255,0~255,0~255,0~255
	DNS: 0~255,0~255,0~255,0~255
Apply: OK/Cancel	

DH3660Z



DU3661Z

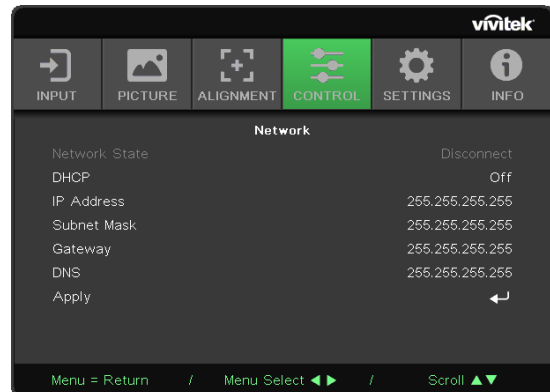

Direct Power On

- Use ◀/▶ to switch ON/OFF
This function is set to OFF by default. When it is set to ON, the projector will turn on automatically when the AC power is turned on the next time. You can use this function and the power switch (instead of the remote control) to turn on the projector.

Light Source

- Press ↵ and use ▼/▲ to scroll through submenus
- **Light Mode:** use ◀/▶ to select (Normal, Eco, Custom Light)
- **Custom Light:** use ◀/▶ to adjust brightness level between 25% to 100%

High Altitude

- Use ◀/▶ to adjust cooling fan speed (Normal, High)

IR Control

- Use ◀/▶ to select the preferred IR control location (Both IR On Front IR on, Rear IR On)
This function let you select which IR remote controller receiver is active.

Remote ID

Display current projector ID and remote control ID number. To set a unique ID for the projector and control independently.

HDBaseT

- Use ◀/▶ to switch HDBaseT_RS232_RJ45 ON/OFF Enable the control function of HDBaseT with RS232 and RJ45,

Network

Use this function to configure the network settings, so that you can control the projector via the network.

- Press ↵ and use ▼/▲ to scroll through submenus
- **Network State:** Connect / Disconnect the network automatically.
- **DHCP:** use ◀/▶ to Set DHCP to ON/OFF.
When DHCP is set to ON, the DHCP server of the domain will assign an IP address to the projector. The IP address will appear on the IP address window without applying any input. If the domain cannot assign any IP address, 0.0.0.0 will be shown on the IP address window.
- **IP Address:** Press ↵ to show the IP address input window.
Use ◀/▶ to select the number in the address to change
Use ▼/▲ to increase or decrease the number in the IP address.
(Example :Network IP Address 172. xxx. xxx. xxx.)
- **Subnet Mask:** Set the subnet mask. The input method is the same as the setting for IP address.
- **Gateway:** Set the gateway. The input method is the same as the setting for IP address.
- **DNS:** Set the DNS. The input method is the same as the setting for IP address.
- **Aply:** Press ↵ and use ▼/▲ to scroll through submenus

Wired LAN Terminal functionalites

Remote control and monitoring of a projector from a PC (or Laptop) via wired LAN is also possible. Compatibility with Crestron / AMX (Device Discovery) / Extron control boxes enables not only collective projector management on a network but also management from a control panel on a PC (or Laptop) browser screen.

- Crestron is a registered trademark of Crestron Electronics, Inc. of the United States.
- Extron is a registered trademark of Extron Electronics, Inc. of the United States.
- AMX is a registered trademark of AMX LLC of the United States.
- PJLink applied for trademark and logo registration in Japan, the United States of America, and other countries by JBMIA.

Supported External Devices

This projector is supported by the specified commands of the Crestron Electronics controller and related software (ex, RoomView ®).

<http://www.crestron.com/>

This projector is supported by AMX (Device Discovery).

<http://www.amx.com/>

This projector is compliant to support Extron device(s) for reference.

<http://www.extron.com/>

This projector supports all commands of PJLink Class1 (Version 1.00).

<http://pjlink.jbmia.or.jp/english/>

For more detail of information about the diverse types of external devices which can be connected to the LAN/RJ45 port and remote/control the projector, as well as the related control commands supporting for each external device, kindly please get contact with the Support-Service team directly.

Connecting with LAN

1. Connect an RJ45 cable to RJ45 ports on the projector and the PC (Laptop).

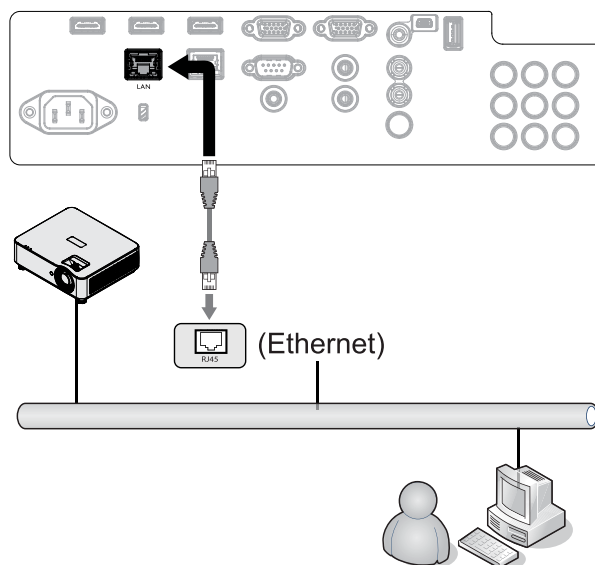

2. On the PC (Laptop), select Start → Control Panel →Network and Internet.

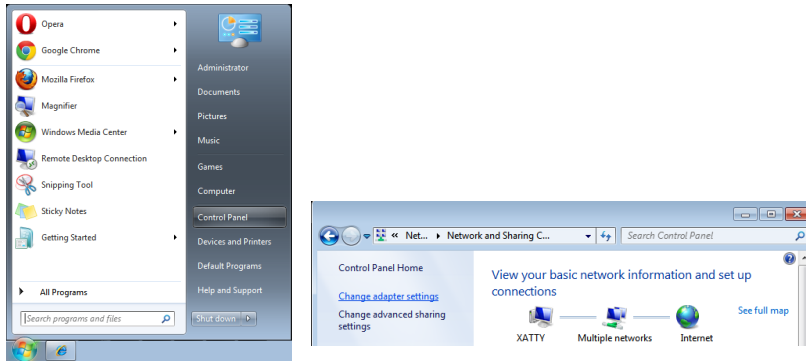

3. Right-click on Local Area Connection, and select Properties.
4. In the Properties window, select the Networking tab, and select Internet Protocol (TCP/IP).
5. Click Properties.
6. Click Use the following IP address and fill in the IP address and Subnet mask, then click OK.

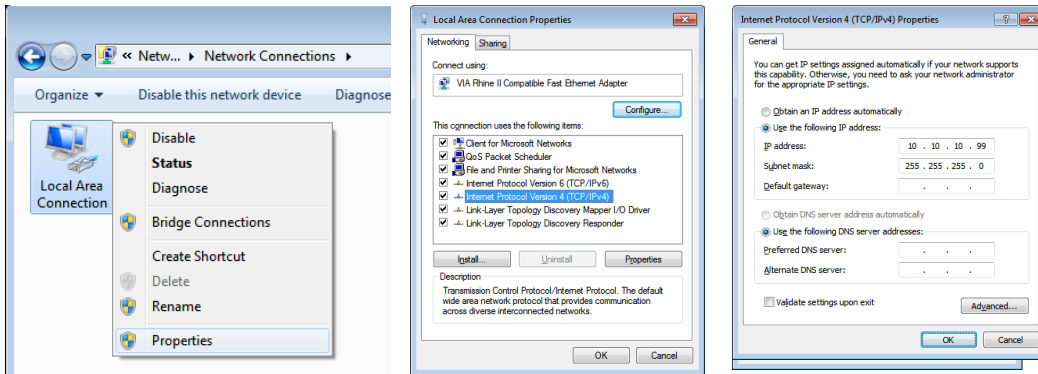

7. Press the Menu button on the projector.
8. Select Settings2→ Advanced1 → Network
9. After getting into Network, input the following:
 - DHCP: Off
 - IP Address: 10.10.10.10
 - Subnet Mask: 255.255.255.0
 - Gateway: 0.0.0.0
 - DNS Server: 0.0.0.0
10. Press (Enter) / ► to confirm settings.

Open a web browser

(for example, Microsoft Internet Explorer with Adobe Flash Player 9.0 or higher).

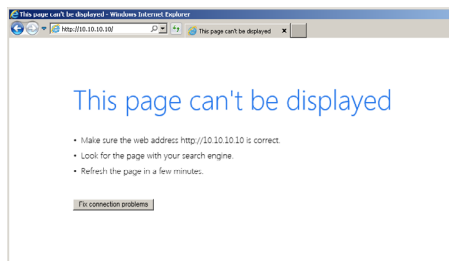

11. In the Address bar, input the IP address: 10.10.10.10.
12. Press (Enter) / ►.

The projector is setup for remote management. The LAN/RJ45 function displays as follows.

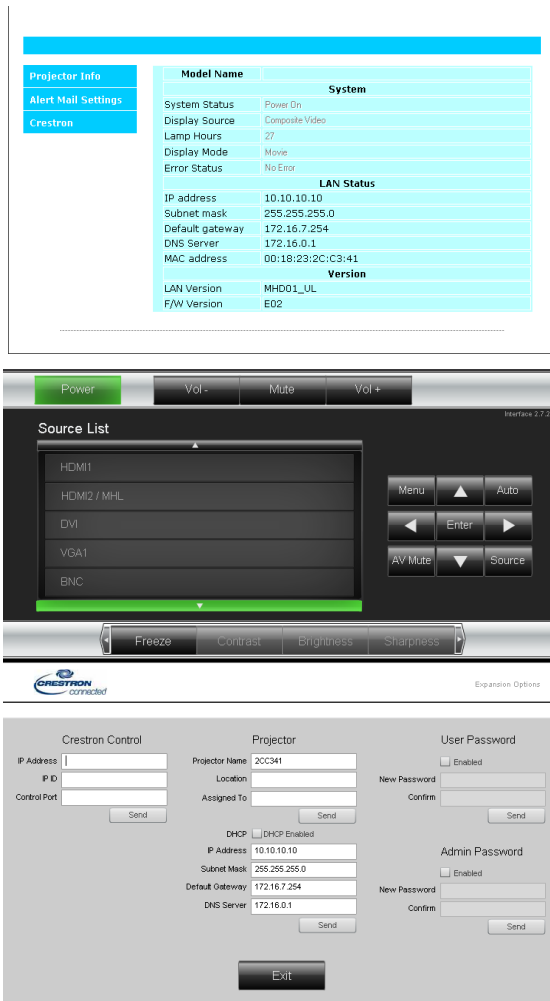

CATEGORY	ITEM	INPUT-LENGTH
Crestron Control	IP Address	15
	IP ID	3
	Port	5
Projector	Projector Name	10
	Location	10
	Assigned To	10
Network Configuration	DHCP (Enabled)	(N/A)
	IP Address	15
	Subnet Mask	15
	Default Gateway	15
	DNS Server	15
User Password	Enabled	(N/A)
	New Password	10
	Confirm	10
Admin Password	Enabled	(N/A)
	New Password	10
	Confirm	10

For more information, please visit <http://www.crestron.com>.

Preparing Email Alerts

1. Make sure that user can access the homepage of LAN RJ45 function by web browser (for example, Microsoft Internet Explorer v6.01/v8.0).
2. From the Homepage of LAN/RJ45, click Alert Mail Settings.
3. By default, these input boxes in Alert Mail Settings are blank.

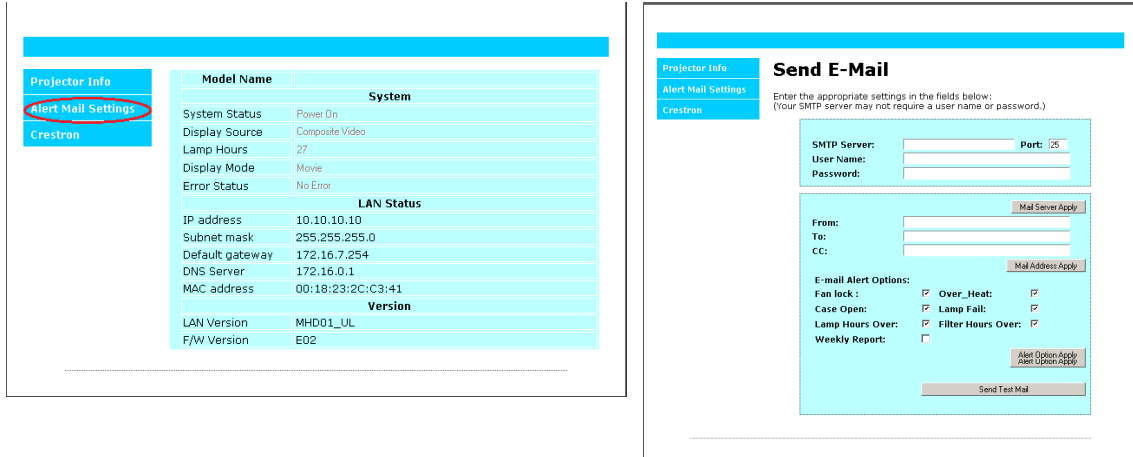

4. For Sending alert mail, input the following:

- The SMTP field is the mail server for sending out email (SMTP protocol). This is a required field.
- The To field is the recipient's email address (for example, the projector administrator). This is a required field.
- The Cc field sends a carbon copy of the alert to the specified email address. This is an optional field (for example, the projector administrator's assistant).
- The From field is the sender's email address (for example, the projector administrator). This is a required field.
- Select the alert conditions by checking the desired boxes.

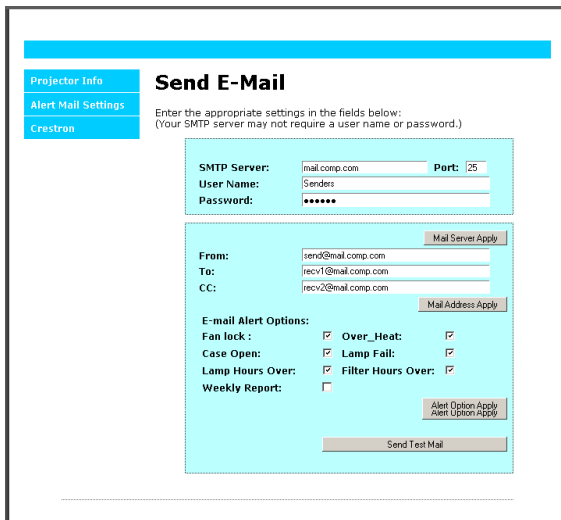

Note: Fill in all fields as specified. User can click Send Test Mail to test what setting is correct. For successful sending an e-mail alert, you must select alert conditions and enter a correct e-mail address.

RS232 by Telnet Function

Besides projector connected to RS232 interface with “Hyper-Terminal” communication by dedicated RS232 command control, there is alternative RS232 command control way, so called “RS232 by TELNET” for LAN/RJ45 interface.

Quick Start-Guide for “RS232 by TELNET”

Check and get the IP-Address on OSD of the projector.

Make sure that laptop/PC can access the web-page of the projector.

Make sure that “Windows Firewall” setting to be disabled in case of “TELNET” function filtering out by laptop/PC.

Start => All Programs => Accessories => Command Prompt

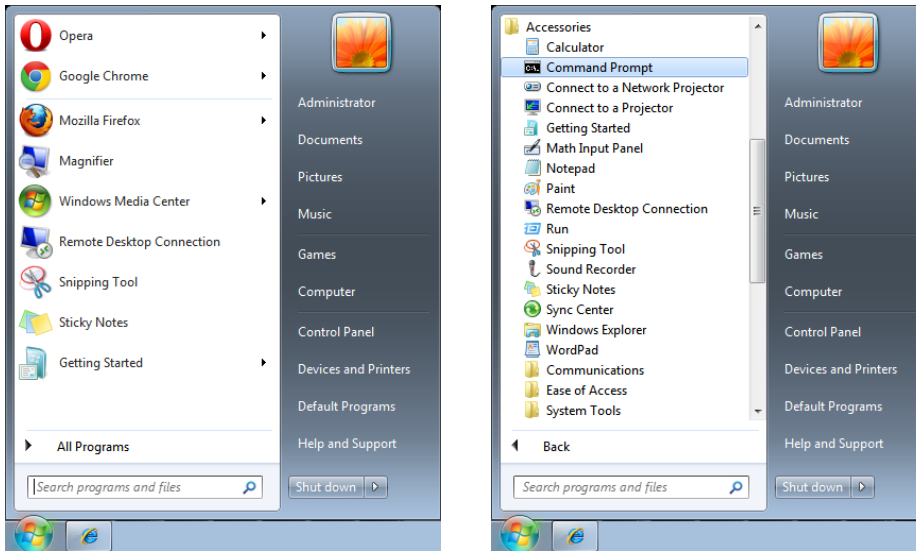

Input the command format like the below:

telnet ttt.xxx.yyy.zzz 23 (“Enter” key pressed)

(ttt.xxx.yyy.zzz: IP-Address of the projector)

If Telnet-Connection ready, and user can have RS232 command input, then “Enter” key pressed, the RS232 command will be workable.

How to have TELNET enabled in Windows 7 / 8 / 10

By default installation for Windows, “TELNET” function is not included. But end-user Systems can have it by way of “Turn Windows features On or Off” to be enabled.

Open “Control Panel” in Windows

Open “Programs”

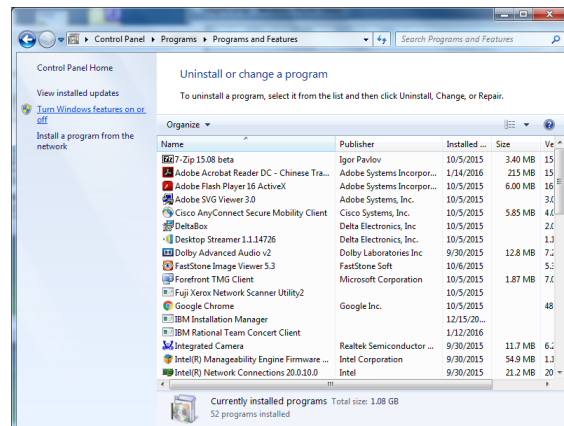
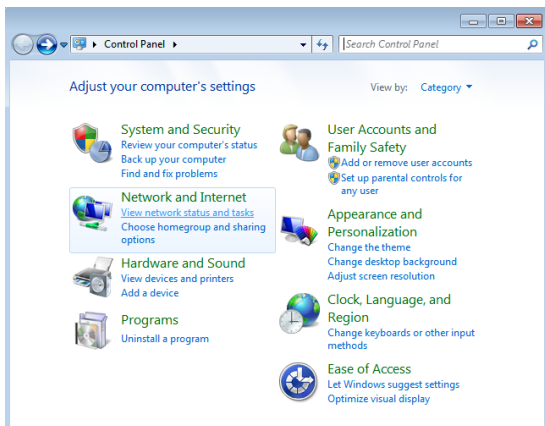

Select “Turn Windows features on or off” to open
Have “Telnet Client” option checked, then press “OK” button.

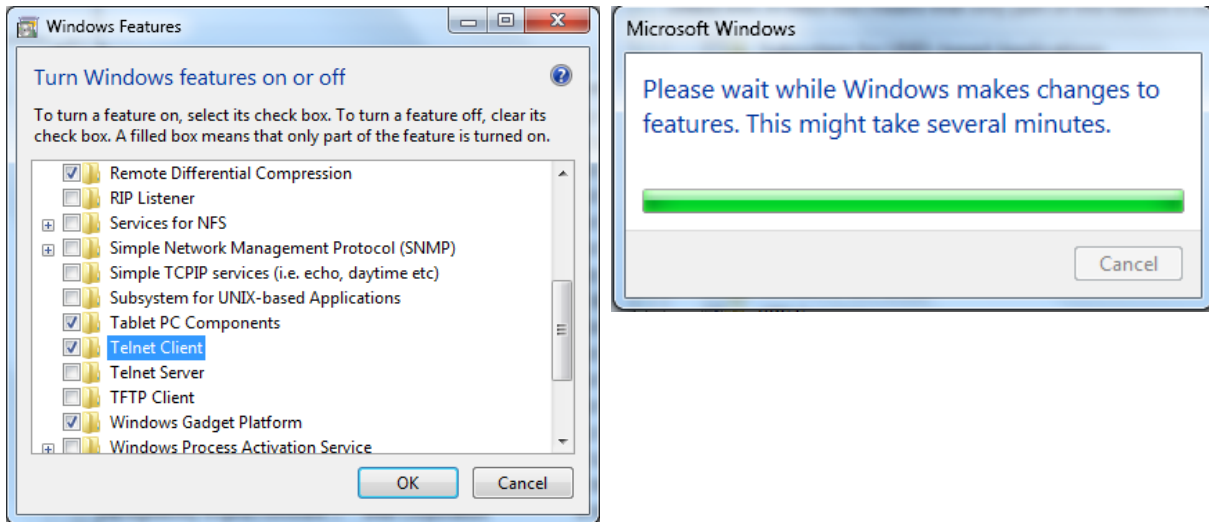

Specsheet for “RS232 by TELNET” :

1. Telnet: TCP
2. Telnet port: 23
(for more detail, kindly please get contact with the service agent or team)
3. Telnet utility: Windows “TELNET.exe” (console mode)
4. Disconnection for RS232-by-Telnet control normally: Close Windows Telnet utility directly after TELNET connection ready
5. Limitation 1 for Telnet-Control: there is less than 50 bytes for successive network payload for Telnet-Control application.
Limitation 2 for Telnet-Control: there is less than 26 bytes for one complete RS232 command for Telnet-Control.
Limitation 3 for Telnet-Control: Minimum delay for next RS232 command must be more than 200 (ms).
(*, In Windows built-in “TELNET.exe” utility, “Enter” key pressed will have “Carriage-Return” and “New-Line” code.)

SETTINGS Menu

Eco	Standby Power: Normal / Eco / On by LAN / On By HDBaseT (DU3661Z only)
	No Signal Power Off (min): 0~180
	Sleep Timer (min): 0~600
Audio	Volume: 0~10
	Mic: On/Off
Blank Screen Color	Black, Red, Green, Blue, White
Menu	Logo: On/Off
	Message: On/Off
	Menu Position: Center, Up, Down, Left, Right
	Menu Timer: Off / 20sec. / 40 sec. / 60 sec.
	Menu Translucent: Off, 50%, 100%
Keypad Lock	On/Off
Security Lock	On/Off
Language	Current Language
	Select Language Screen
Reset All	OK/Cancel

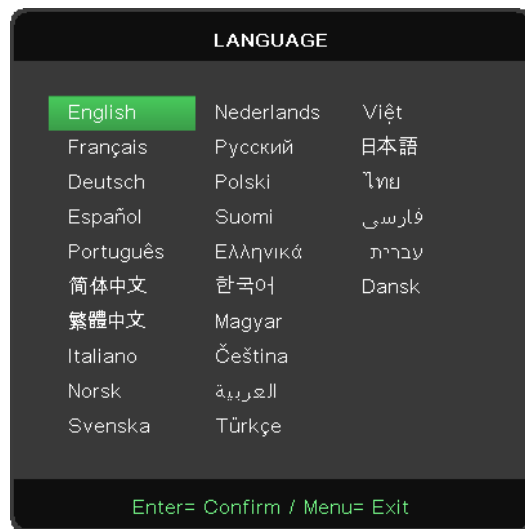
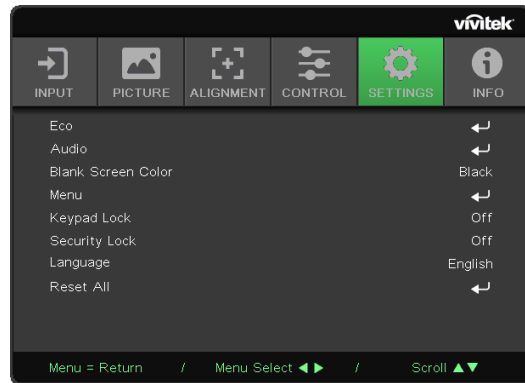

Eco

- Press and use / to scroll through submenus
- **Standby Power:** use / to switch Normal / Eco / On by LAN / On By HDBaseT (Only shown and gray out when HDBaseT_RS232_RJ45 set "On")
- **No Signal Power Off (mins):** use / to increase or decrease time lapse before automatic Power Off mode to count down under no signal before turning off projector automatically.
- **Sleep Timer (mins):** use / to increase or decrease time lapse before automatic sleep mode

Audio

- Press and use / to scroll through submenus
- **Volume:** use / to increase or decrease the projector sound volume
- **Mic:** use / to switch ON/OFF the built in microphone of projector.

Blank Screen Color

- Use ◀/▶ to select screen background color (Black, Red, Green, Blue, White)

Menu

- Press ↵ and use ▼/▲ to scroll through submenus
- **Logo:** use ◀/▶ to switch ON/OFF
- **Message:** use ◀/▶ to switch ON/OFF
- **Menu Position:** use ◀/▶ to select the menu position (Center,Up,Down,Left,Right)
- **Menu Timer:** use ◀/▶ to switch time : Off / 20sec. / 40sec. / 60sec. to pop off Menu.
- **Menu Translucent:** use ◀/▶ to switch Off / 50% /100% for Menu transparency.

Keypad Lock

- Use ◀/▶ to to switch On/Off for Keypad lock.

Note :

To unlock by keypad, please press “ ▼ ” for 5 sec and then pop-out “keypad unlock”.

Security Lock

- Use ◀/▶ to switch ON/OFF

Password

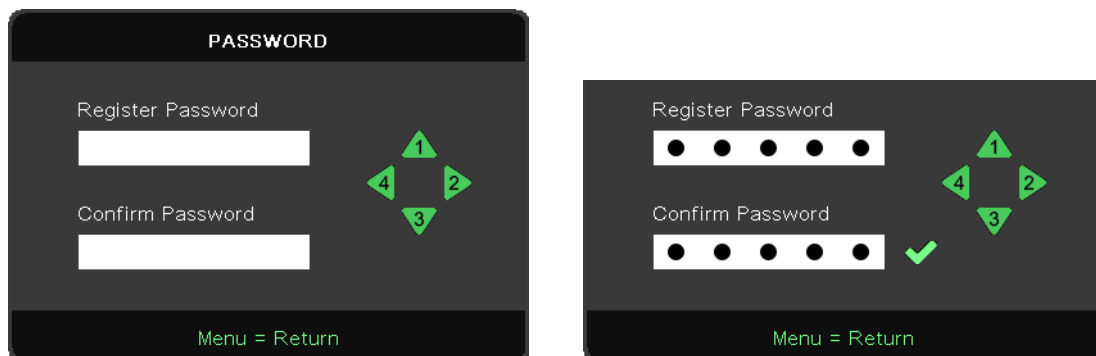

- Press the MENU button. Press ◀ / ▶ button to navigate to SETTINGS.
- Press ▼/▲ button to scroll to the Password submenu.
- Press ↵ to enter the advanced settings screen.
- Press ▼/▲ button to scroll and highlight your language.
- Press the MENU button to exit the advanced

Note:

Every time will show “password check” to key in when startup. If wrong over 5 times ,please contact with local service center.

Language

- Press the MENU button. Press ◀ / ▶ button to navigate to SETTINGS.
- Press ▼/▲ button to scroll to the **Language** submenu.
- Press ↵ to enter the advanced settings screen.
- Press ▼/▲ button to scroll and highlight your language.
- Press the MENU button to exit the advanced Setting Language

Reset All

- Press **←** and use **▼/▲** to scroll through submenus
- **Light Mode:** use **◀/▶** to select (Normal, Bright,)
- **Custom Light:** use **◀/▶** to increase or decrease the light source

Note:

Depending on the video source, not all items in the OSD are available. For example, the Horizontal/Vertical Position items in the Computer menu can only be modified when connected to a PC. Items that are not available cannot be accessed and are grayed out.

INFO Screen

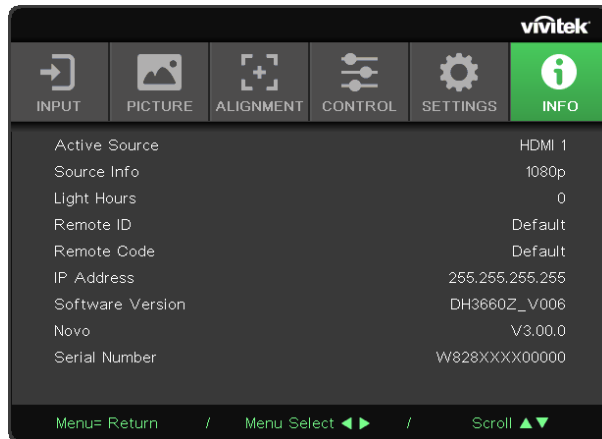

This screen displays the projector current status information to be used for technical support.

4.Troubleshooting

Common Problems and Solutions

These guidelines provide tips to deal with problems you may encounter while using the projector. If the problem remains unsolved, contact your dealer for assistance.

Often after time spent troubleshooting, the problem is traced to something as simple as a loose connection.

Check the following before proceeding to the problem-specific solutions.

- Use some other electrical device to confirm that the electrical outlet is working.
- Ensure the projector is turned on.
- Ensure all connections are securely attached.
- Ensure the attached device is turned on.
- Ensure a connected PC is not in suspending mode.
- Ensure a connected notebook computer is configured for an external display.

(This is usually done by pressing an Fn-key combination on the notebook.)

Troubleshooting Tips

In each problem-specific section, try the steps in the order suggested. This may help you to solve the problem more quickly.

Try to pin point the problem and thus avoid replacing non-defective parts.

For example, if you replace batteries and the problem remains, put the original batteries back and go to the next step.

Keep a record of the steps you take when troubleshooting: The information may be useful when calling for technical support or for passing on to service personnel.

LED Error Messages

Error Code Messages	Power LED	Light LED	Temp LED
Light Source ready	ON	OFF	OFF
Start	Flashing	OFF	OFF
Cooling	Flashing	OFF	OFF
Over Temperature T1	OFF	1 Blinks	ON
Over Temperature T2	OFF	2 Blinks	ON
Over Temperature T3	OFF	3 Blinks	ON
Over Temperature T4	OFF	4 Blinks	ON
Thermal Break Sensor Error	4 Blinks	OFF	OFF
FAN1 Error	6 Blinks	1 Blinks	OFF
FAN2 Error	6 Blinks	2 Blinks	OFF
FAN3 Error	6 Blinks	3 Blinks	OFF
FAN4 Error	6 Blinks	4 Blinks	OFF
FAN5 Error	6 Blinks	5 Blinks	OFF
1W MCU detect scaler stops working	2 Blinks	OFF	OFF
Case Open	7 Blinks	OFF	OFF
DMD Error	8 Blinks	OFF	OFF
Color Wheel Error	9 Blinks	OFF	OFF
Phosphor Wheel Error	9 Blinks	1 Blinks	OFF

Note:

In the event of an error, please disconnect the AC power cord and wait for one (1) minute before restarting the projector. If the Power or Light source LEDs are still blinking or the Over Temp LED is lit, contact your service center.

Image Problems Q&A

Q. NO image appears on the screen

- Verify the settings on your notebook or desktop PC.
- Turn off all equipment and power up again in the correct order.

Q. The image is blurred

- Adjust the Focus on the projector.
- Ensure the projector-to-screen distance is within the specified range.
- Check that the projector lens is clean.

Q. The image is reversed

- Check the Projection setting on the ALIGNMENT menu of the OSD.

Q. The image is streaked

- Set the Phase and Clock settings on the Input -> Analog menu of the OSD to the default settings.
- To ensure the problem is not caused by a connected PC's video card, connect to another computer.

Q. The image is flat with no contrast

- Adjust the Contrast setting on the PICTURE menu of the OSD.

Q. The colour of the projected image does not match the source image.

- Adjust the Color Temperature and Gamma settings on the PICTURE > Advanced menu of the OSD.

Light Source Problems

Q. There is no light from the projector

- Check that the power cable is securely connected.
- Ensure the power source is good by testing with another electrical device.
- Restart the projector in the correct order and check that the Power LED is on.

Remote Control Problems

Q. The projector does not respond to the remote control

- Direct the remote control towards remote sensor on the projector.
- Ensure the path between remote and sensor is not obstructed.
- Turn off any fluorescent lights in the room.
- Check the battery polarity.
- Replace the batteries.
- Turn off other Infrared-enabled devices in the vicinity.
- Have the remote control serviced.

Audio Problems

Q. There is no sound

- Adjust the volume on the remote control.
- Adjust the volume of the audio source.
- Check the audio cable connection.
- Test the source audio output with other speakers.
- Have the projector serviced.

Q. The sound is distorted

- Check the audio cable connection.
- Test the source audio output with other speakers.
- Have the projector serviced.

Having the Projector Serviced

If you are unable to solve the problem, you should have the projector serviced. Pack the projector in the original carton. Include a description of the problem and a checklist of the steps you took when trying to fix the problem: The information may be useful to service personnel. For servicing, return the projector to the place you purchased it.

HDMI Q&A

Q. What is the difference between a “Standard” HDMI cable and a “High-Speed” HDMI cable?

Recently, HDMI Licensing, LLC announced that cables would be tested as Standard or High-Speed cables.

Standard (or “category 1”) HDMI cables have been tested to perform at speeds of 75Mhz or up to 2.25Gbps, which is the equivalent of a 720p/1080i signal.

High Speed (or “category 2”) HDMI cables have been tested to perform at speeds of 340Mhz or up to 10.2Gbps, which is the highest bandwidth currently available over an HDMI cable and can successfully handle 1080p signals including those at increased color depths and/or increased refresh rates from the Source. High-Speed cables are also able to accommodate higher resolution displays, such as WQXGA cinema monitors (resolution of 2560 x 1600).

Q. How do I run HDMI cables longer than 10 meters?

There are many HDMI Adapters working on HDMI solutions that extend a cable’s effective distance from the typical 10 meter range to much longer lengths. These companies manufacture a variety of solutions that include active cables (active electronics built into cables that boost and extend the cable’s signal), repeaters, amplifiers as well as CAT5/6 and fiber solutions.

Q. How can I tell if a cable is an HDMI certified cable?

All HDMI products are required to be certified by the manufacturer as part of the HDMI Compliance Test Specification. However, there may be instances where cables bearing the HDMI logo are available but have not been properly tested. HDMI Licensing, LLC actively investigates these instances to ensure that the HDMI trademark is properly used in the market. We recommend that consumers buy their cables from a reputable source and a company that is trusted.

5. Specifications

Projector Dimensions

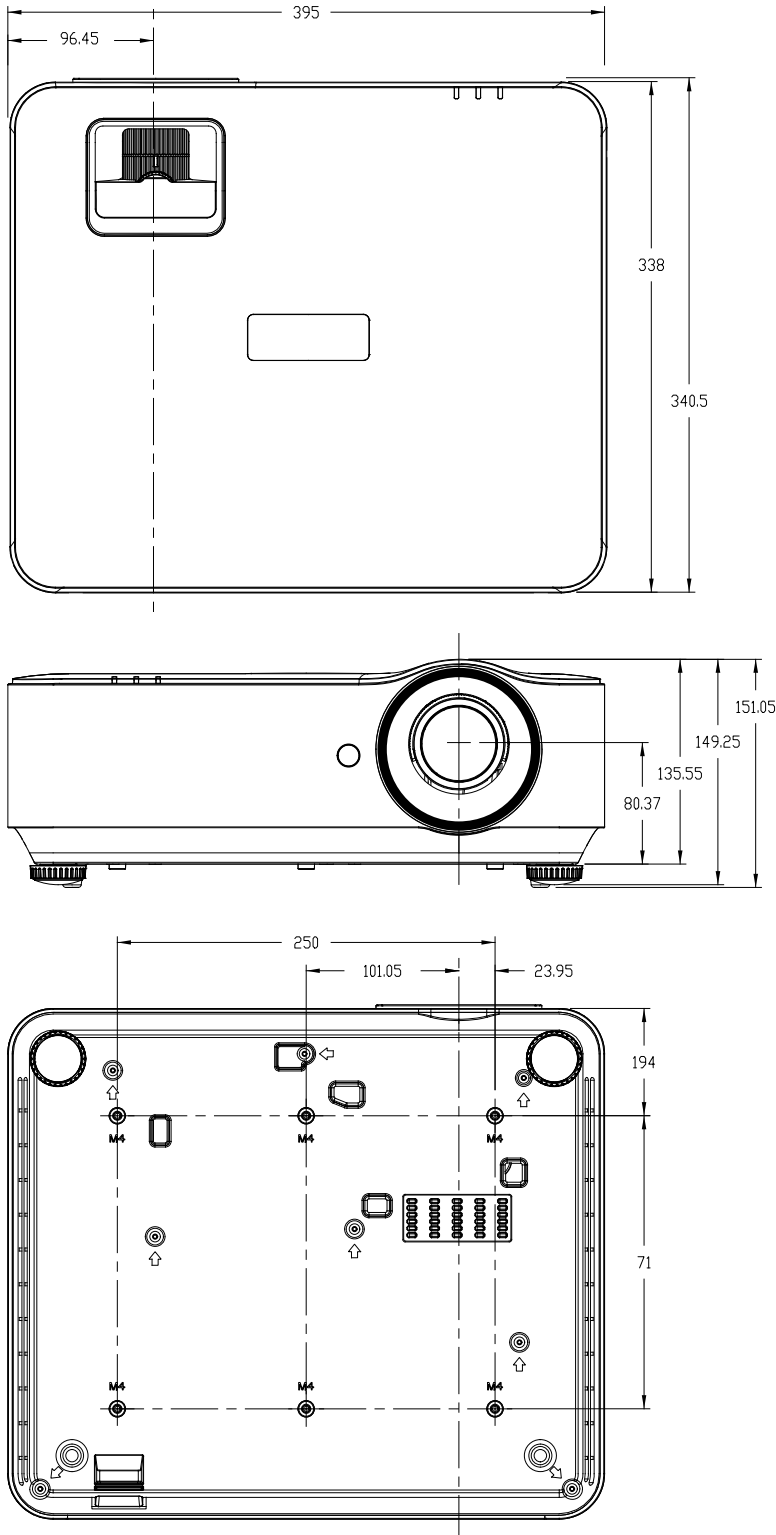

Projector DataSheet

Model Name	DH3660Z	DU3661Z
Display Type	Single Chip 0.65" DLP Technology by TI	Single Chip 0.67" DLP Technology by TI
Brightness	4,500 ANSI Lumens	5,000 ANSI Lumens
Native Resolution	1080p (1,920 x 1,080)	WUXGA (1,920 x 1,200)
Maximum Resolution	1080p (1920 x 1080p)@60Hz	WUXGA (1,920 x 1,200)@60Hz
Contrast Ratio	20,000:1	
Laser Life/Type	20,000 + hours (Laser Phosphor Light Engine)	
Throw Ratio	1.39 - 2.09:1	
Image Size (Diagonal)	25.9" - 324.9"	
Projection Distance	1.2m - 10m (3.9ft – 32.8ft)	
Projection Lens	F#2.42 - 2.97, f=20.7 - 31.05mm	
Zoom Ratio	1.5x	
Aspect Ratio	16:9	
Offset	130% / 115%	117% / 108.5%
Keystone Correction	Vertica/Horizontal $\pm 30^\circ$	
Horizontal Frequency	15, 31 - 91.4kHz	
Vertical Frequency	24 - 30Hz, 47 - 120Hz	
3D Compatibility	Yes (DLP® Link™, HDMI 1.4 (Blu-Ray 3D))	
Speaker	10W (Mono)	
Lens Shift	Yes (Vertical)	
Computer Compatibility	VGA, SVGA, XGA, SXGA, SXGA+, UXGA, WUXGA@60hz, Mac	
Video Compatibility	SDTV (480i, 576i) / EDTV (480p, 576p) / HDTV (720p, 1080i, 1080p), NTSC (M, 3.58/4.43 MHz), PAL (B,D,G,H,I,M,N) SECAM (B,D,G,K,K1,L)	
I/O Connection Ports	HDMI v1.4 (x3), VGA-In, Audio-In (Mini-Jack), VGAAOut, Audio-Out (Mini-Jack), USB Type A Power (5V/1.5A), RJ45 (10/100Mbps), RS232, USB (Service)	HDMI v1.4 (x3), HDBaseT, VGA-In, Audio-In (Mini-Jack), VGAAOut, Audio-Out (Mini-Jack), USB Type A Power (5V/1.5A), RJ45 (10/100Mbps), RS232, USB(Service)
Projection Method	Table Top, Ceiling Mount (Front or Rear)	
Security Solutions	Kensington® Security Slot, Security Bar, Keypad Lock	
Dimensions (WxDxH)	395 x 338 x 135.5mm (15.5" x 13.3" x 5.3")(without ADJ-foot)	
Weight	7kg (15.4lbs)	
Available Colors	White	
Noise Level	35dB/33dB (Normal/Eco. Mode)	
Power Supply	AC 100-240V, 50/60Hz	
Power Consumption	330W (Light Mode : Normal), 260W (Light Mode : Eco), <0.5W (Standby Mode: Eco), <2W (Standby Mode:On by Lan)	340W (Light Mode : Normal), 270W (Light Mode : Eco), <0.5W (Standby Mode: Eco), <2W (tandby Mode:On by Lan)
Standard Accessories	AC Power Cord, VGA Cable, Remote Control, Filter, Documentation Kit	
Optional Accessories	N/A	

Projector Time Table

Signal	Resolution	H-SYNC (KHz)	V-SYNC (Hz)	Composite S_Video	Component	VGA/BNC	HDMI / DVI / HDBaseT
NTSC	-	15.734	60	○ (FS)	-	-	-
PAL / SECAM	-	15.625	50	○ (FS)	-	-	-
VESA	700 x 400	31.5	70.1	-	-	○	○
	640 x 480	31.5	60	-	-	○(FS/TB/SBS)	○(FS/TB/SBS)
	640 x 480	35	66.667	-	-	MAC13	MAC13
	640 x 480	37.86	72.8	-	-	○	○
	640 x 480	37.5	75	-	-	○	○
	640 x 480	43.3	85	-	-	○	○
	640 x 480	61.9	119.5	-	-	○ (FS)	○ (FS)
	800 x 600	37.9	60.3	-	-	○(FS/TB/SBS)	○(FS/TB/SBS)
	800 x 600	46.9	75	-	-	○	○
	800 x 600	48.1	72.2	-	-	○	○
	800 x 600	53.7	85.1	-	-	○	○
	800 x 600	76.3	120	-	-	○ (FS)	○ (FS)
	832 x 624	49.722	74.546	-	-	MAC16	MAC16
	1024 x 768	48.4	60	-	-	○(FS/TB/SBS)	○(FS/TB/SBS)
	1024 x 768	56.5	70.1	-	-	○	○
	1024 x 768	60.241	75.02	-	-	MAC19	MAC19
	1024 x 768	60	75	-	-	○	○
	1024 x 768	68.7	85	-	-	○	○
	1024 x 768	97.6	120	-	-	○ (FS)	○ (FS)
	1152 x 870	68.68	75.06	-	-	MAC21	MAC21
	1280 x 720	45	60	-	-	○(FS/TB/SBS)	○(FS/TB/SBS)
	1280 x 720	90	120	-	-	○ (FS)	○ (FS)
	1280 x 768	47.4	60	-	-	○ (FS)	○ (FS)
	1280 x 768	47.8	59.9	-	-	○ (FS)	○ (FS)
	1280 x 800	49.7	59.8	-	-	○(FS/TB/SBS)	○(FS/TB/SBS)
	1280 x 800	62.8	74.9	-	-	○	○
	1280 x 800	71.6	84.9	-	-	○	○
	1280 x 800	101.6	119.9	-	-	○ (FS)	○ (FS)
	1280 x 1024	64	60	-	-	○ (FS)	○ (FS)
	1280 x 1024	80	75	-	-	○	○
	1280 x 1024	91.1	85	-	-	○	○
	1280 x 960	60	60	-	-	○ (FS)	○ (FS)
1280 x 960	85.9	85	-	-	○	○	
1400 x 1050	65.3	60	-	-	○ (FS)	○ (FS)	
1440 x 900	55.9	59.9	-	-	○ (FS)	○ (FS)	
1600 x 1200	75	60	-	-	○ (FS)	○ (FS)	
1680 x 1050	64.67	59.88	-	-	○	○	
1680 x 1050	5.29	59.95	-	-	○	○	
1920 x 1080	67.5	60	-	-	○ (FS)	○ (FS)	
1920 x 1200	74.038	59.95	-	-	○	○	

Signal	Resolution	H-SYNC (KHz)	V-SYNC (Hz)	Composite S_Video	Component	VGA/BNC	HDMI / DVI / HDBaseT
SDTV	480i	15.734	60	-	○ (FS)	-	○ (FS)
	576i	15.625	50	-	○ (FS)	-	○ (FS)
EDTV	576p	31.3	50	-	○ (FS)	-	○ (FS)
	480p	31.5	60	-	○ (FS)	-	○ (FS)
HDTV	720p	37.5	50	-	○ (FS)	-	○(FS/TB/SBS/FP)
	720p	45	60	-	○ (FS)	-	○(FS/TB/SBS/FP)
	1080i	33.8	60	-	○ (FS)	-	○(FS/TB/SBS)
	1080i	28.1	50	-	○ (FS)	-	○(FS/TB/SBS)
	1080p	27	24	-	○	-	○(TB/FP)
	1080p	28	25	-	○	-	○(TB/FP)
	1080p	33.7	30	-	○	-	○(TB/FP)
	1080p	56.3	50	-	○ (FS)	-	○(FS/TB/SBS)
1080p	67.5	60	-	○ (FS)	-	○(FS/TB/SBS)	

○ : Supported frequency

- : Not Supported frequency

FS => Field Sequential

TB => Top / Bottom

SBS => Side-By-Side

FP => Frame Packing

6. Regulatory Compliance

FCC Warning

This equipment has been tested and found to comply with the limits for a Class B digital device pursuant to Part 15 of the FCC Rules. These limits are designed to provide reasonable protection against harmful interference when the equipment is operated in a commercial environment.

This equipment generates, uses, and can radiate radio frequency energy and, if not installed and used in accordance with the instruction manual, may cause harmful interference to radio communications. Operation of this equipment in a residential area is likely to cause harmful interference in which case the user will be required to correct the interference at his/her own expense.

Changes or modifications not expressly approved by the parties responsible for compliance could void the user's authority to operate the equipment.

Canada

This class B digital apparatus complies with Canadian ICES-003.

Safety Certifications

FCC-B, UL, CCC, CE, KC, CB, CU, RoHS, ICES-003 (Canada)

Disposal and Recycling

This product may contain other electronic waste that can be hazardous if not disposed of properly. Recycle or dispose in accordance with local, state, or federal Laws. For more information, contact the Electronic Industries Alliance at www.eiae.org.

7. RS-232 Communication

Communication parameter setup

You can use the serial control command to input commands for projector control or retrieve its operational data through Windows client terminal software

Item	Parameter:
Bit per Second	9600 bps
Data Bit	8-bit
Parity	None
Stop Bit	1
Flow Control	None

Operation commands

Operation command syntax

An operation command is prefixed by character “op”, followed by control commands and settings separated by space blank [SP], and ended by carriage return pair “CR” and “ASCII hex 0D”. Syntax of serial control commands:

op[SP]<operation command>[SP]<Setting Value>[CR]

op A constant indicating this is an operation command.

[SP] Indicate one blank space.

[CR] Indicate the command ending carriage return pair “CR” and “ASCII hex 0D”.

Setting value Settings of operation command

Types of setup strings	Characters of settings	Description
Query current setup	?	Question mark "?" indicates querying current setup
Setup	= <settings>	Syntax: Symbol "=" suffixed with setup values
Increase setup order of adjustment items	+	Some settings are changed in steps. Symbol "+" indicates changing one step up
Decrease setup order of adjustment items	-	Some settings are changed in steps. Symbol "-" indicates changing one step down
Execute operation command	None	Certain operation commands execute after input without further setting or regulators.

Examples:		
Control items	Input command row	Projector return message
Query current brightness	op bright ?[CR]	OP BRIGHT = 50
Set up brightness	op bright = 100[CR]	OP BRIGHT = 100
Out of range or not support	op bright = 200[CR]	OP BRIGHT = NA
Illegal command	op abright = 100[CR]	*Illegal format#

Function	Operation	Set	Get	Inc	Dec	EXE	Values
Auto Source	auto.src	V	V				0 = Off 1 = On
HDMI Color Space	color.space	V	V				0 : Auto 1 : RGB 2 : YUV
HDMI Range	hdmi.range	V	V				0 : Auto 1 : Full 2 : Limited
Instant Motion	instant.motion	V	V				0 : Off 1 : On
Video AGC	video.agc	V	V				0 : Off 1 : On
Video Saturation	video.saturation	V	V	V	V		0 ~ 100
Video Tint	video.tint	V	V	V	V		0 ~ 100
Closed Caption	cc	V	V				0 : Off 1 : On
H Position	h.pos	V	V	V	V		-5 ~ +5 -100 ~ +100(Auto Sync Off)
V Position	v.pos	V	V	V	V		-5 ~ +5 -100 ~ +100(Auto Sync Off)
Phase	phase	V	V	V	V		0 ~ 31
clock	clock	V	V	V	V		-5 ~ +5
Auto Sync	auto.sync	V	V				0 : Off 1 : On
HDBaseT Control	hdbaset	V	V				0 : Off 1 : On
HDBaseT Connect	hdbaset.connect		V				0 : Disconnect 1 : Connected
3D	threed	V	V				0 : Off 1 : DLP-Link 2 : IR
3D Sync Invert	threed.syncinvert	V	V				0 = Off 1 = On
3D Format	threed.format	V	V				0 : Frame Sequential 1 : Top / Bottom 2 : Side by side 3 : Frame Packing
Signal Power On	signal.poweron	V	V				0 : Off 1 : On
Picture Mode	pic.mode	V	V				0:Presentation 1:Bright 2:Movie 3:Game 4:sRGB 5:DICOM 6:User
Brightness	bright	V	V	V	V		0 ~ 100
Contrast	contrast	V	V	V	V		0 ~ 100
Projector Light	projector.light	V	V				0 : Off 1 : On
HSG/Red Gain	hsg.r.gain	V	V	V	V		0 ~ 100
HSG/Green Gain	hsg.g.gain	V	V	V	V		0 ~ 100
HSG/Blue Gain	Hsg.b.gain	V	V	V	V		0 ~ 100
HSG/Cyan Gain	hsg.c.gain	V	V	V	V		0 ~ 100

Function	Operation	Set	Get	Inc	Dec	EXE	Values
HSG/Magenta Gain	hsg.m.gain	V	V	V	V		0 ~ 100
HSG/Yellow Gain	hsg.y.gain	V	V	V	V		0 ~ 100
HSG/Red/Saturation	hsg.r.sat	V	V	V	V		0 ~ 100
HSG/Green/Saturation	hsg.g.sat	V	V	V	V		0 ~ 100
HSG/Blue/Saturation	Hsg.b.sat	V	V	V	V		0 ~ 100
HSG/Cyan/Saturation	hsg.c.sat	V	V	V	V		0 ~ 100
HSG/Magenta/Saturation	hsg.m.sat	V	V	V	V		0 ~ 100
HSG/Yellow/Saturation	Hsg.y.sat	V	V	V	V		0 ~ 100
HSG/Red/Hue	hsg.r.hue	V	V	V	V		0 ~ 100
HSG/Green/Hue	hsg.g.hue	V	V	V	V		0 ~ 100
HSG/Blue/Hue	Hsg.b. hue	V	V	V	V		0 ~ 100
HSG/Cyan/Hue	hsg.c. hue	V	V	V	V		0 ~ 100
HSG/Magenta/Hue	hsg.m. hue	V	V	V	V		0 ~ 100
HSG/Yellow/Hue	Hsg.y. hue	V	V	V	V		0 ~ 100
HSG/White/Red Gain	hsg.wr.gain	V	V	V	V		0 ~ 100
HSG/White/Green Gain	hsg.wg.gain	V	V	V	V		0 ~ 100
HSG/White/Blue Gain	Hsg.wb.gain	V	V	V	V		0 ~ 100
Brilliant Color	bri.color	V	V	V	V		0 ~ 10
Sharpness	sharp	V	V	V	V		0 ~ 31
Gamma	gamma	V	V				0 = 1.8 1 = 2.0 2 = 2.2 3 = 2.4 4 = B&W 5 = Linear
Color Temperature	color.temp	V	V				0 = Warm 1 = Normal 2 = Cold
White Balance /Red Offset	red.offset	V	V	V	V		-100 ~ +100
White Balance /Green Offset	green.offset	V	V	V	V		-100 ~ +100
White Balance /Blue Offset	blue.offset	V	V	V	V		-100 ~ +100
White Balance /Red Gain	red.gain	V	V	V	V		0 ~ 200
White Balance /Green Gain	green.gain	V	V	V	V		0 ~ 200
White Balance /Blue Gain	blue.gain	V	V	V	V		0 ~ 200
Picture Mode Reset	pic.mode.reset					V	
Aspect Ratio	aspect	V	V				0 = Fill 1 = 4:3 2 = 16:9(16:10) 3 = LetterBox 4 = 2.35:1
Digital Zoom	zoom	V	V	V	V		-10 ~ +10
V Keystone	v.keystone	V	V	V	V		-30 ~ +30
H Keystone	h.keystone	V	V	V	V		-30 ~ +30
4 Corner Top Left X	4corner.tlx	V	V	V	V		0 ~ +60
4 Corner Top Left Y	4corner.tly	V	V	V	V		0 ~ +60
4 Corner Top Right X	4corner.trx	V	V	V	V		0 ~ +60
4 Corner Top Right Y	4corner.try	V	V	V	V		0 ~ +60
4 Corner Bottom Left X	4corner.blx	V	V	V	V		0 ~ +60
4 Corner Bottom Left Y	4corner.bly	V	V	V	V		0 ~ +60
4 Corner Bottom Right X	4corner.brx	V	V	V	V		0 ~ +60
4 Corner Bottom Right y	4corner.bry	V	V	V	V		0 ~ +60
H Image Shift	img.hshift	V	V	V	V		-50 ~ +50
V Image Shift	img.vshift	V	V	V	V		-50 ~ +50
Projection	projection	V	V				0 = Front 1 = Rear 2 = Front+ Ceiling 3 = Rear + Ceiling

Function	Operation	Set	Get	Inc	Dec	EXE	Values
Test Pattern	test.pattern	V	V				0 = Off 1 = Grid
Direct Power On	direct.poweron	V	V				0 : Off 1 : On
Light Mode	light.mode	V	V				0: Normal (100%) 1: Eco (80%) 2: Custom Light (25~100)
Custom Light	custom.light	V	V	V	V		25 ~ 100
Fan Speed	fanspeed	V	V				0 = Normal 1 = High
IR Control	ir.control	V	V				0 : Front / Rear IR On 1 : Front IR On 2 : Rear IR On
Remote ID	remote.id	V	V				0 : Default(ID0) 1 : ID1 2 : ID2 3 : ID3 4 : ID4 5 : ID5 6 : ID6 7 : ID7
NetWork Status	net.status		V				0 : Disconnect 1 : Connected
NetWork / DHCP	net.dhcp	V	V				0 = Off 1 = On
NetWork / IP Address	net.ipaddr	V	V				<string>
NetWork / Subnet	net.subnet	V	V				<string>
NetWork / Gateway	net.gateway	V	V				<string>
NetWork / DNS	net.dns	V	V				<string>
NetWork Apply	net.apply	V					0 : Cancel 1 : OK
Standby Power	standby.power	V	V				0 : Normal 1 : ECO 2 : On By Lan 3 : On By HDBaseT
No Signal Power Off	nosignal.poweroff	V	V				0 ~ 36
Sleep Timer	sleep.timer	V	V				0 ~ 120
Volume	volume	V	V	V	V		0 ~ 10
Mic	mic	V	V				0 : Off 1 : On
Blank Screen Color	blankscreen.color	V	V				0 = Black 1 = Red 2 = Green 3 = Blue 4 = White
Logo	logo	V	V				0 = Off 1 = On
Message	message	V	V				0 : Off 1 : On
MENU Position	menu.position	V	V				0 : Cneter 1 : Up 2 : Down 3 : Left 4 : Right
MENU Timer	menu.timer	V	V				0 : Off 1 : 20 2 : 40 3 : 60

Function	Operation	Set	Get	Inc	Dec	EXE	Values
MENU Translucent	menu.trans	V	V				0 : Off 1 : 50% 2 : 100%
Keypad Lock	keypad.lock	V	V				0 : Off 1 : On
Security Lock	security.lock	V	V				1 : Up 2 : Down 3 : Left 4 : Right
Security Unlock	security.unlock	V					1 : Up 2 : Down 3 : Left 4 : Right
Language	lang	V	V				0 = English 1 = French 2 = German 3 = Spanish 4 = Portuguese 5 = Simplified Chinese 6 = Traditional Chinese 7 = Italian 8 = Norwegian 9 = Swedish 10 = Dutch 11 = Russian 12 = Polish 13 = Finnish 14 = Greek 15 = Korean 16 = Hungarian 17 = Czech 18 = Arabic 19 = Turkish 20 = Vietnamese 21 = Japanese 22 = Thai 23 = Farsi 24 = Hebrew 25 = Danish
Reset All	reset.all					V	
Source Info	source.info		V				<string>
Light Hours 1	light1.hours		V				<string>
Light Hours 1 Reset	light1.reset					V	
Remote Code	remote.code		V				<string>
Software Version	sw.ver		V				<string>
Serial Number	ser.no		V				<string>
Auto Image	auto.img					V	
Light 1 Status	light1.stat		V				0 = Off 1 = On
Model	model		V				<string>
Pixel Clock	pixel.clock		V				<string>
H Refresh Rate	h.refresh		V				<string>
V Refresh Rate	v.refresh		V				<string>
Blank	blank	V	V				0 = Off 1 = On
Power On	power.on					V	
Power Off	power.off					V	

Function	Operation	Set	Get	Inc	Dec	EXE	Values
Projector Status	status		V				0 : Reset 1 : Standby 2 : Active 3 : cooling 4: Warming 5: Power Up
Mute	mute	V	V				0 : Off 1 : On
Freeze	freeze	V	V				0 : Off 1 : On
Input Select	input.sel	V	V				1 :RGB 4: Video 6: HDMI 1 9: HDMI 2 12: HDMI 3 15: HDBaseT



Vivitek EMEA Headquarters
Zandsteen 15
2132 MZ Hoofddorp
The Netherlands
Customer Service & Technical Support:
Monday - Friday 09:00 - 18:00
English (UK): 0333 0031993
Germany: 0231 7266 9190
France: 018 514 8582
International +31 (0) 20 721 9318

A brand of  **DELTA**

Visit www.vivitek.eu for more product info
Copyright© 2019 Delta Electronics, Inc. All Rights Reserved.