

### Tools Required

- Rubber Mallet
- Phillips Screwdriver
- Drill + Drill Bit

### Parts List

1. (4 each) 14" or 16" Grooved Legs
2. (2) Back Panels
3. (2) Left Side Cabinet Door Panels
4. (1) Short Front Panel
5. (4) Casters
6. (1) Upper Right Panel
7. (1) Right Side Cabinet Door Panel (lower)
8. (1) LCD Projector Shelf Assembly (Box T-POS)
9. (1) Keyboard Assembly with Hardware (Box TKS)
10. (1) Electrical Assembly with Hardware
11. (1) **EACH top shelf (handle), middle shelf (8 bosses) & bottom shelf (4 bosses)**
12. (1) Interior Shelf & (4 Brackets with Hardware)
13. (1) Steel Drop Down Shelf (Box TDDS)

### \*\*\*READ INSTRUCTIONS BEFORE BEGINNING ASSEMBLY

### \*\*\*BACK & FRONT OF SHELVES ARE 24"W, SIDES ARE 18"W

STEP 1: Place the four 16" fluted legs over the corner posts (bosses) of the bottom shelf so that the channels face each other. Use a rubber mallet to tap legs into place. Make sure that legs are even and fully seated. (FIGURE 1)

STEP 2: Hold the Interior Shelf between the four legs at the desired height. Mark where you want the shelf to sit. Hold brackets up to these marks and drill two pilot holes on the inside of each leg. (The holes in the legs will be towards each other along the 24"W side of the shelf.)

The adjustable shelf brackets will be attached to these holes. Attach brackets as shown in Figure 2 using 2 screws per bracket.

\*\*Make sure to leave 2 of the brackets on one of the 24" sides loose for inserting the cabinet panel. This 24" side will be the 'Front' of the cart.

Step 3: LOWER CABINET- Locate back panel (back panels have moderate ventilation holes, are 24"W and do not have doors) and slide down into grooves of the 2 back legs. Slide lower left side panel into left front & back leg grooves (Left Panels are smaller cabinet doors with the hinges on the left/lock & handle on the right.) Lower Right Panel is a cabinet door with hinge on the right and lock/handle on the left. Slide this panel into the remaining 18" side fluted channels. Take front panel (largest cabinet door) and slide into place with the lock positioned so that it is under the handle. You can now finish tightening the shelf brackets and put your adjustable shelf on brackets. (Panel sliding into channel shown in Figure 3. Upper right panel shown in photo.)

STEP 4: Take middle shelf and place onto legs so that the bosses are fitting into the holes in the top of the legs. Be sure that the ribbed side is facing down. Push shelf down as far as you can by hand. Gently tap with mallet if necessary.

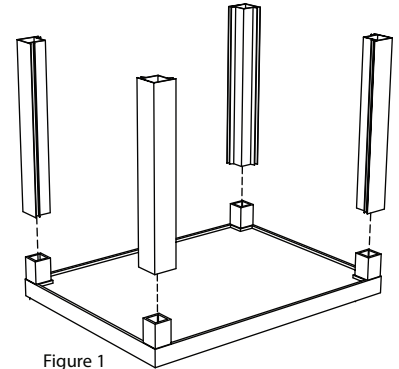
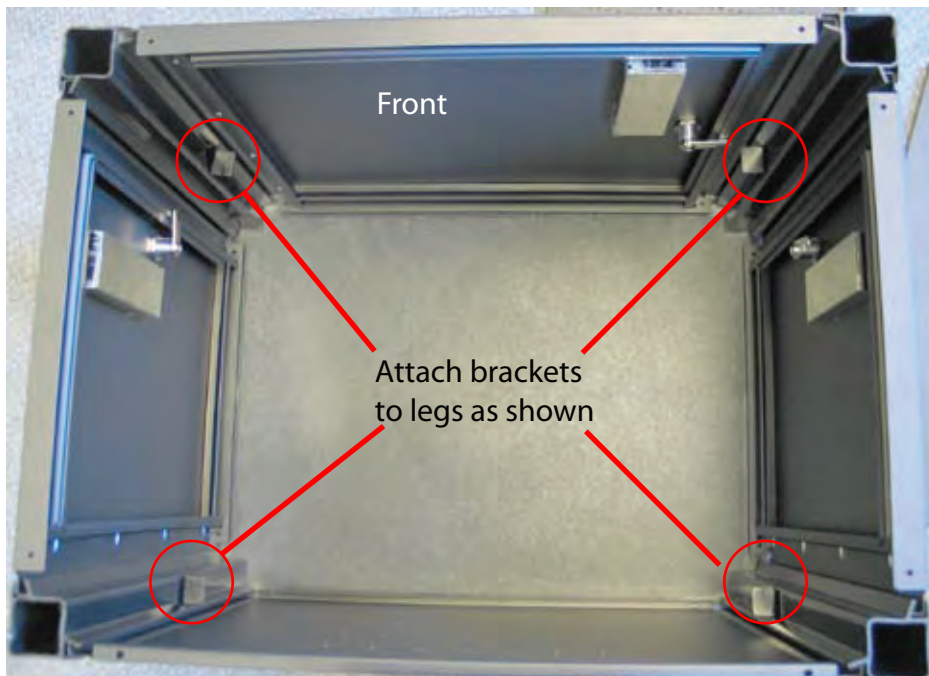
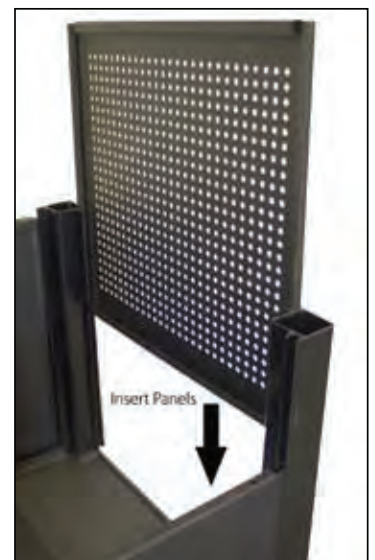

Figure 1



Figure 2

Figure 3 shows how to insert panel into channel. **Upper right panel shown.**





**STEP 5 - Assemble LCD Shelf & Brackets.** First you must separate the rails. This is done by extending the rails out until you see a small black plastic lever. Depending on how you are holding the assembly, you will push the lever up or down until the rails release. Do this for both rails. (See Figure 5)

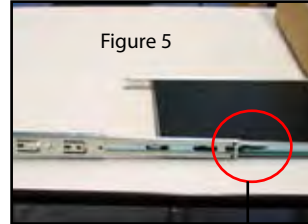

Lever

**STEP 6:** Mark hole pattern onto middle shelf by holding LCD shelf assembly in position. If you like, you may pre drill into the middle shelf. The LCD projector shelf will attach here when built. (See Figure 4 (previous page) for placement- do not put legs on or put panels in yet)



Figure 6

You will then attach the brackets to the outer part of the rails, two brackets per rail. Attach with the included hardware to the outermost holes on the outside of the rails. One hole is a bit tricky to get to and you will have to adjust the sliding rail (see left) and attach through a hole on the sliding rail. Make sure that you are attaching the brackets so that the rail will be attached to the shelf as shown in Figures 7, circled in red.

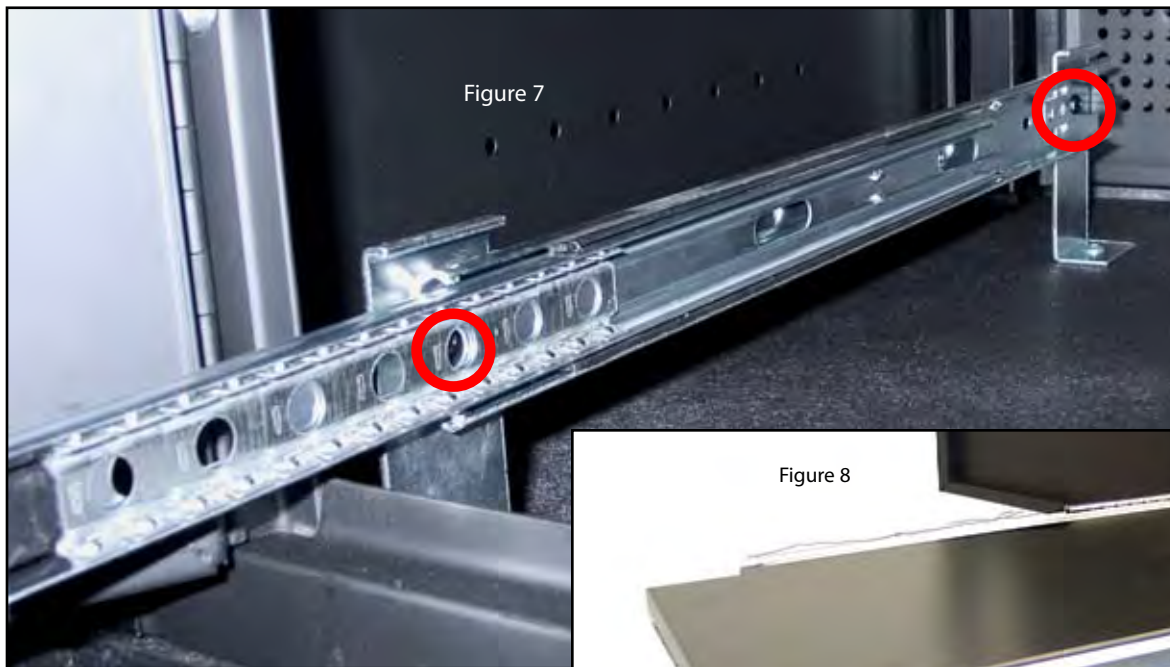

Figure 7

You may then slide the LCD Projector Tray back onto the rails. Slide in and out a few times to make sure everything is secure.



Figure 8

Figure 9

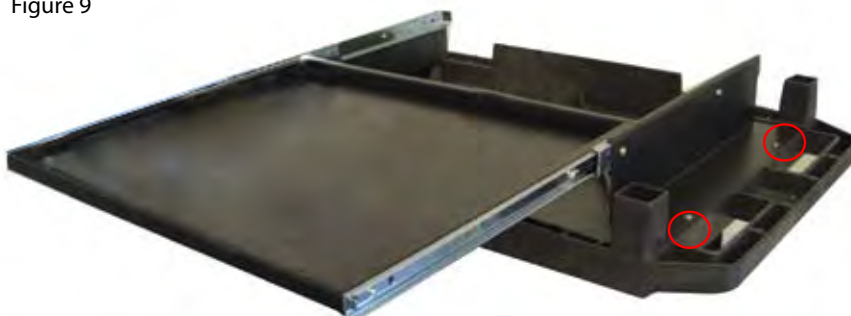

**STEP 7 - The Keyboard assembly needs to be attached to the top shelf. Turn the top shelf upside down. Line the holes in the metal bracket up with the four small holes on the underside of the top shelf. Attach with screws.**

**STEP 8- Take remaining legs and place over bosses on middle shelf.**

Left Panels are smaller cabinet doors with the hinges on the left/lock & handle on the right.

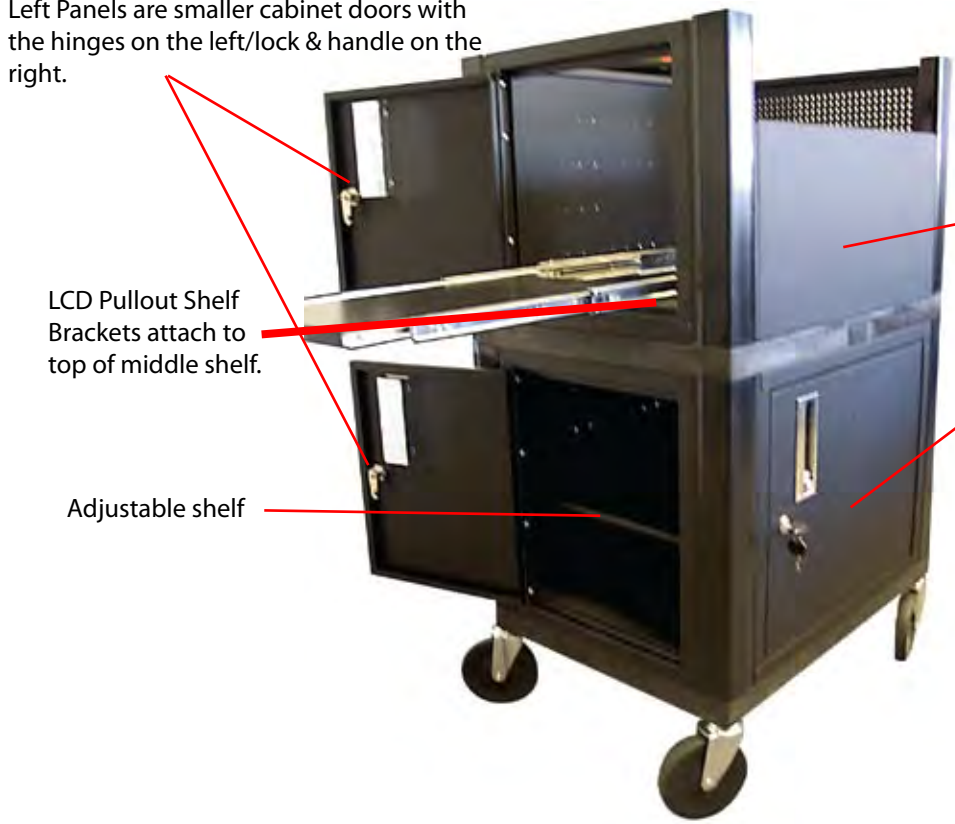

LCD Pullout Shelf Brackets attach to top of middle shelf.

Adjustable shelf

Top Front Panel is shorter than all other panels with no perforations

Lower Front Panel is the largest cabinet door

**STEP 9: Put 2 side and rear panels into channels on legs as shown in photos on this page.**

Back Panels have moderate perforation and are interchangeable top and bottom



Top Right Panel (right) has heaviest perforation. The electrical can be installed on this panel. Follow enclosed electrical assembly instructions. This can be done at any time, but will be easiest before top shelf encloses cabinet. See video for further placement options.

Lower Right Panel is a cabinet door with hinge on the right and lock/handle on the left.



**STEP 10 -** Take top shelf assembly (below) and place onto legs so that the bosses are fitting into the holes in the top of the legs and handle is to the left. The keyboard tray will be accessible through the short panel. Be sure that the ribbed side is facing down. Push shelf down as far as you can by hand. Gently tap with mallet if necessary. (See photo right)

Top Shelf Assembly



The drop down shelf attaches to the right side legs



# Touchboards

205 Westwood Ave, Long Branch, NJ 07740  
 Phone: 866-94 BOARDS (26273) / (732)-222-1511  
 Fax: (732)-222-7088 | E-mail: sales@touchboards.com

**STEP 11:** Hold TDDS up to upper legs on right side of cart FLUSH WITH THE TOP OF THE SHELF. Mark where to pre drill holes for drop down shelf attachment with punch if desired. Turn unit on it's side and attach the brackets with screws. Turn unit right side up.

Finished Cart

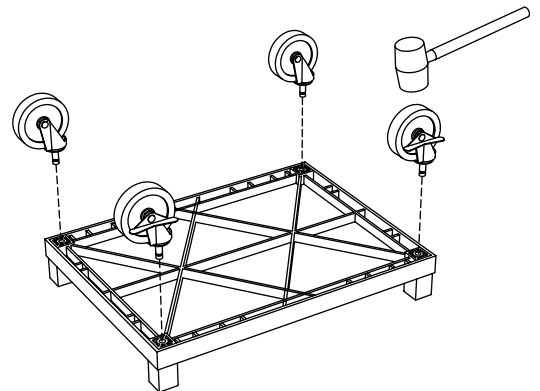

**STEP 12:** Turn cart upside down on a level and firm floor surface. Insert the stems of the 4 casters into the holes in the underside of the bottom shelf, locking casters in the front 24" W side. Tap casters into socket with rubber mallet until fully seated. Turn right side up.