

Weller®



CE

WX
compatible



- DE Originalbetriebsanleitung
- GB Translation of the original instructions
- ES Traducción del manual original
- FR Traduction de la notice originale
- IT Traduzione delle istruzioni originali
- PT Tradução do manual original
- NL Vertaling van de oorspronkelijke gebruiksaanwijzing
- SV Översättning av bruksanvisning i original
- DK Oversættelse af den originale brugsanvisning
- FI Alkuperäisten ohjeiden käännös
- GR Μετάφραση του πρωτοτύπου των οδηγιών χρήσης
- TR Orijinal işletme talimatı çevirisi
- CZ Překlad původního návodu k používání
- PL Tłumaczeniem instrukcji oryginalnej
- HU Eredeti használati utasítás fordítása
- SK Preklad pôvodného návodu na použitie
- SL Prevod izvirnih navodil
- EE Algupärased kasutusjuhendi tõlge
- LV Instrukciju tulkojumam no oriģinālvalodas
- LT Originalios instrukcijos vertimas
- BG превод на оригиналната инструкция
- RO Traducere a instructiunilor originale
- HR Prijevod originalnih uputa
- RU Оригинальное руководство по эксплуатации
- CN 原装使用说明
- KO 오리지널 사용 설명서
- JP 取扱説明書

WXP 65

WXP 80

WXP 90

WXP 120

WXP 200

WXDP 120

WXDP 120 Robust

WXDV 120

WXHAP 200



www.weller-tools.com



MANUAL



VIDEO



FAQ



1 WX 1 / WX 2 / WXD 2

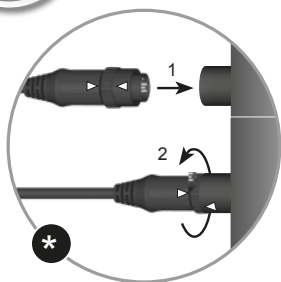

230 V / 110-120V

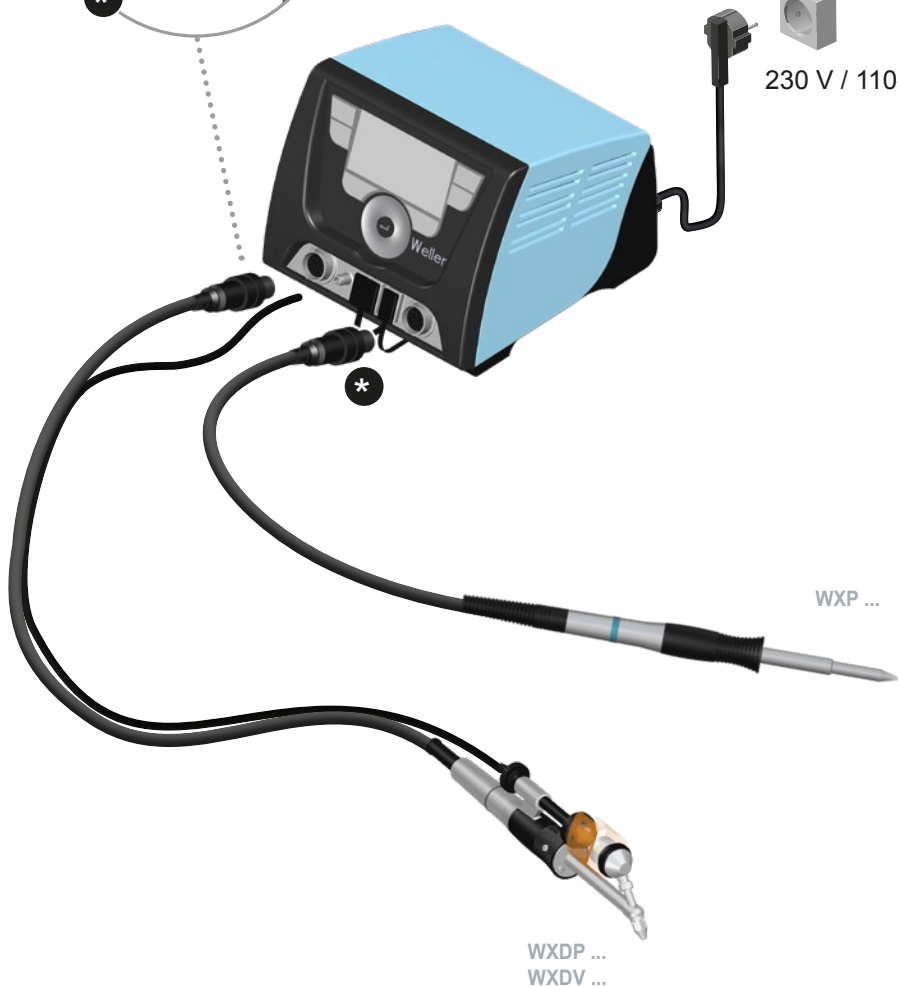

1

WXA 2

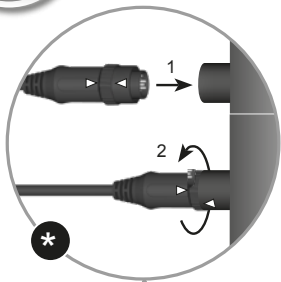

230 V / 110-120V

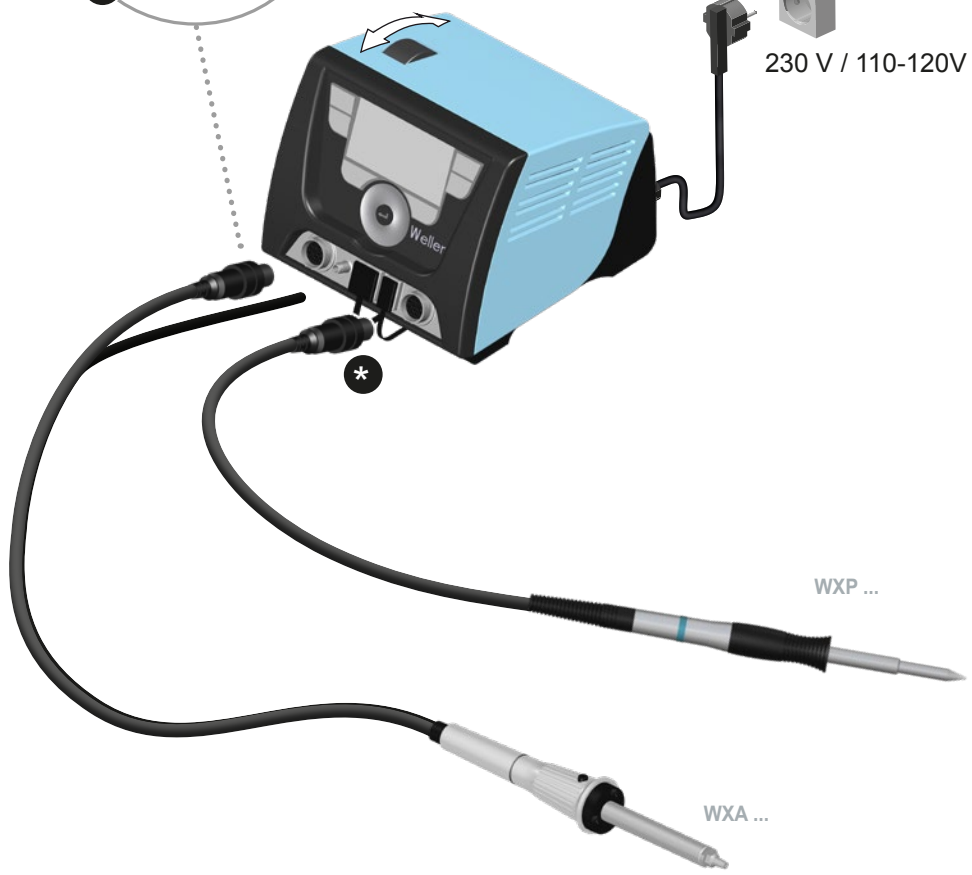

2

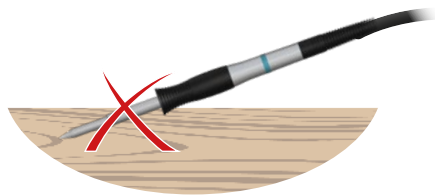
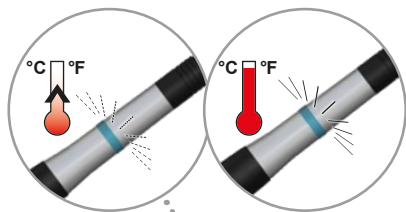

3

WXP 65 / WXP 120



WXP 65 T0052921199



XNT A 1,6 x 0,4 mm
T0054485199

WXP 120 T0052920199



XT B 2,4 x 0,8 mm
T0054470499

&

WXP 65 Set / WXP 120 Set

+ **WDH 10** T0051384199

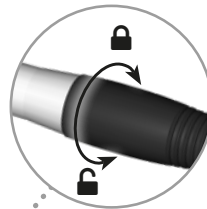
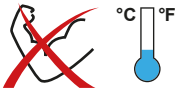

WXP 65



WXP 120

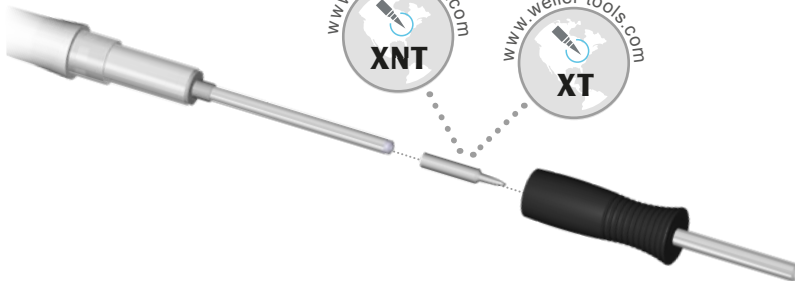

WXP 80



WXP 80 T0052920899



LT B 2,4 x 0,8 mm
T0054440599

&

WXP 80 Set

+ **WDH 10** T0051384199

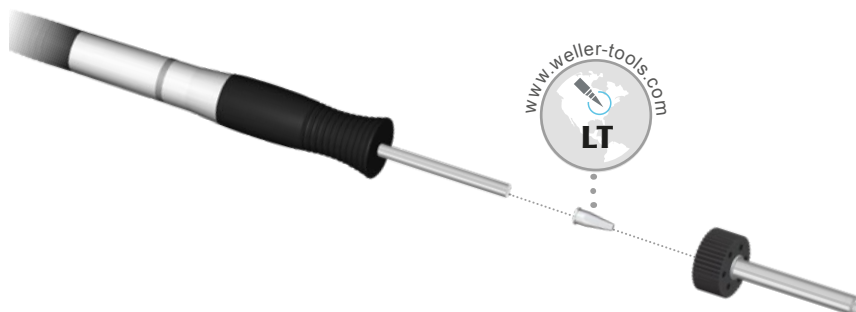
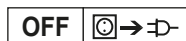

WXP 90



WXP 90 T0052922499



XNT A 1,6 x 0,4 mm
T0054440599



WXP 90 Set

+ **WDH 51** T0051384199

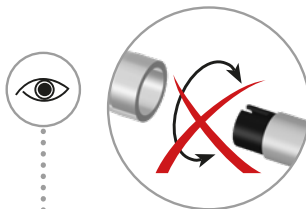
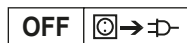

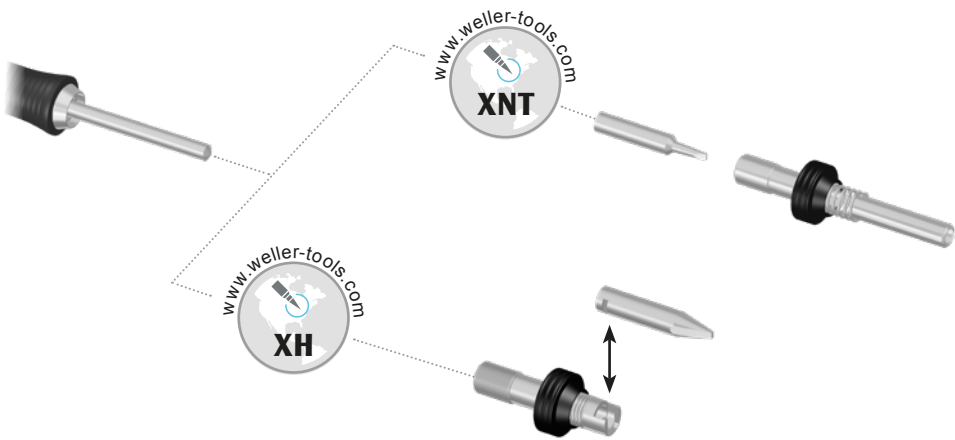
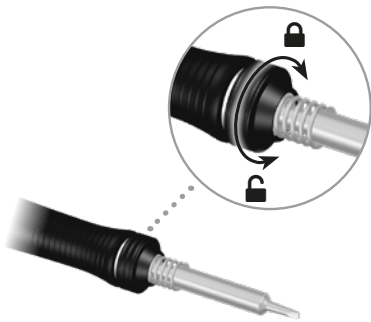

WXP 200



WXP 200 T0052920599

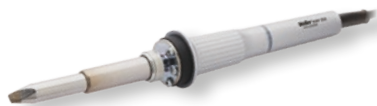

XHT D 5,0 x 1,2 mm
T0054480199



SW 17
T0058741753

&

WXP 200 Set

+ **WDH 31** T0051384199



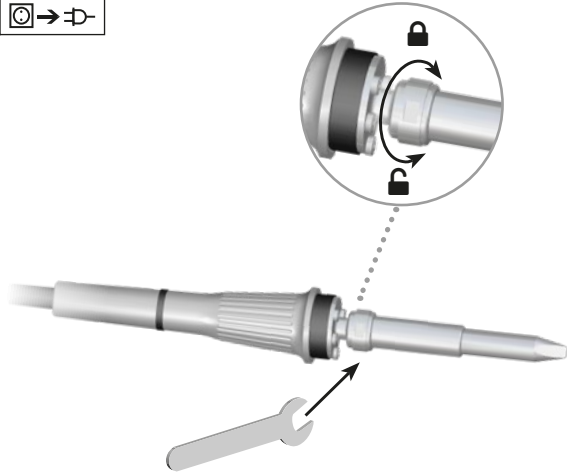
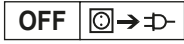

WXDP 120 / WXDP 120 Robust



WXDP 120 T0051320199



XDS 1 Ø 1,4 x Ø 2,5 mm
T0051325099

T0058765773

T0058765801



T0058765772



WXDP 120 Set

+ **WDH 70** T0051517299

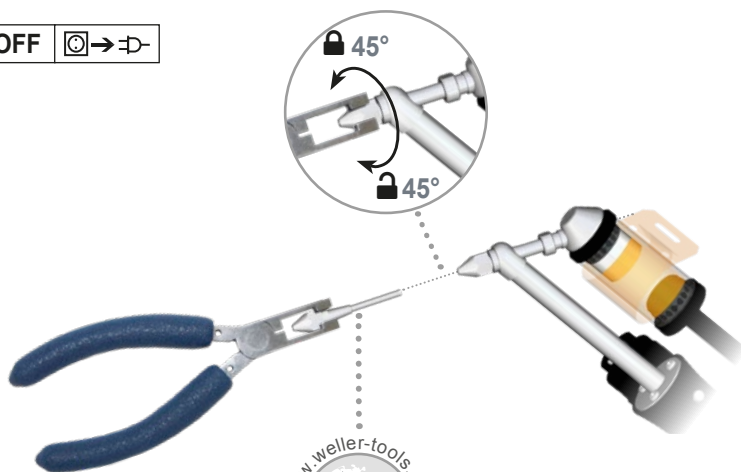

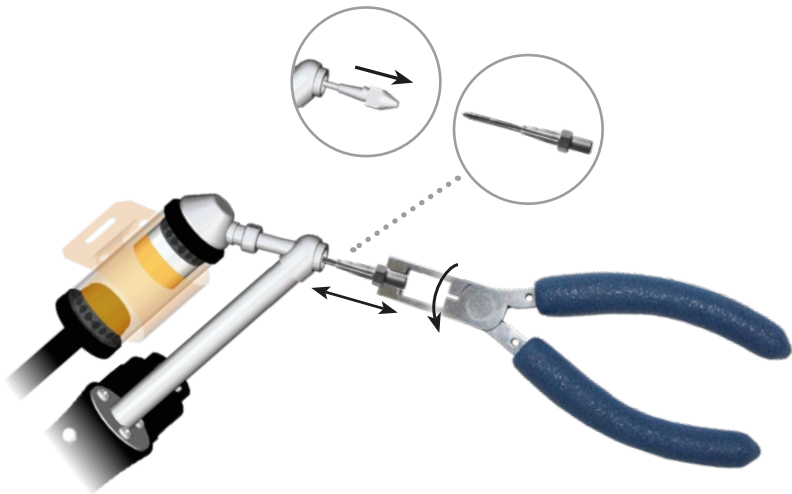
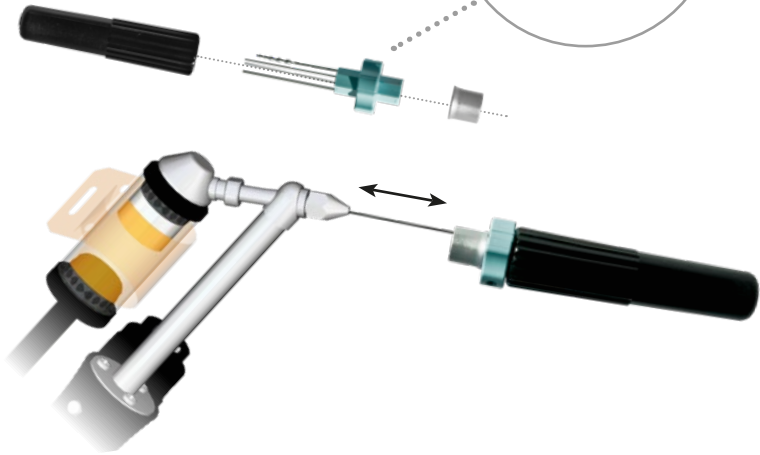
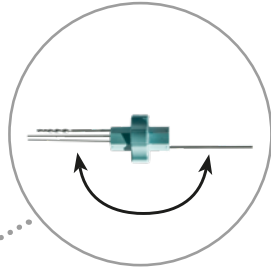

WXDP 120 / WXDP 120 Robust

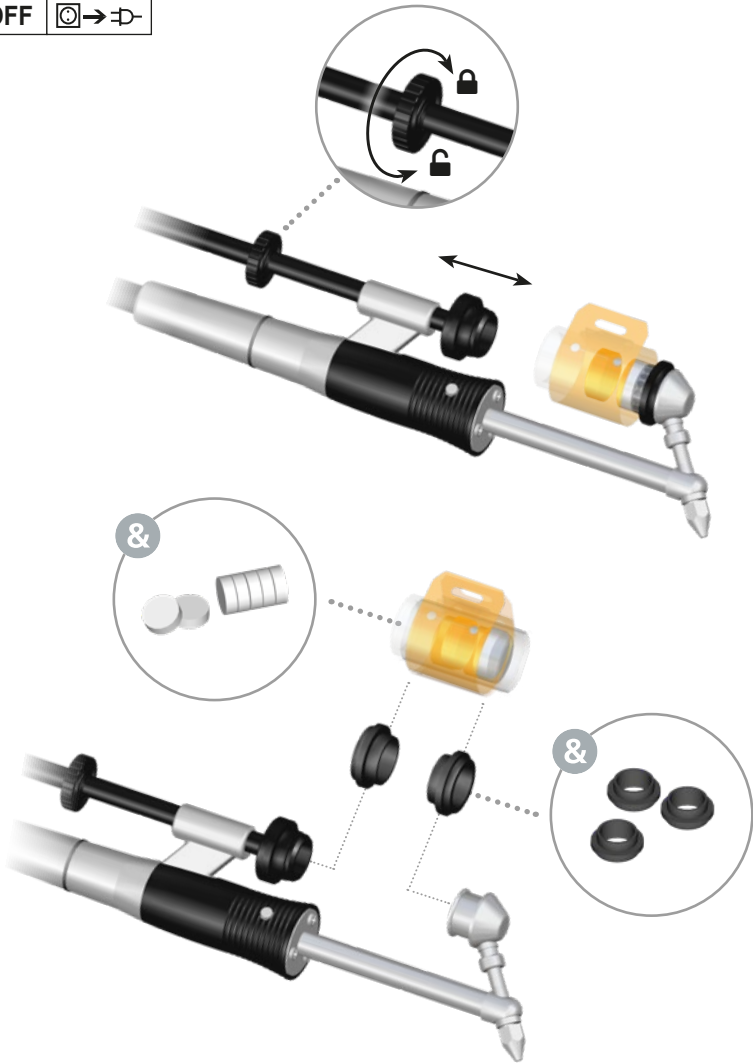
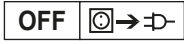
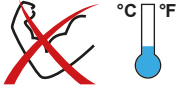

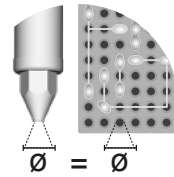
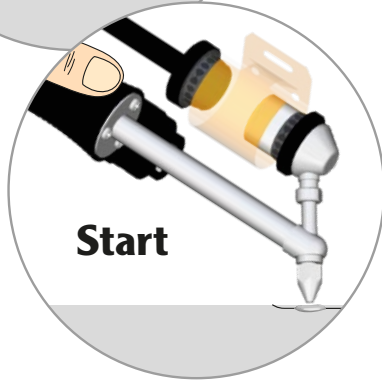
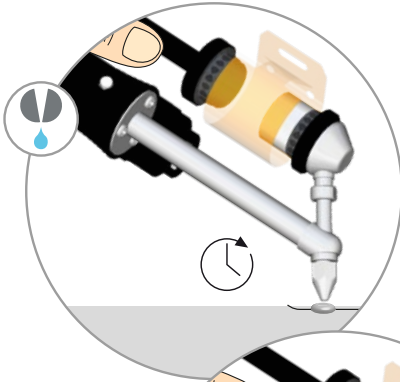

WXDV 120



WXDV 120 T0051320499



XDS 1 Ø 1,4 x 2,5 mm
T0051325099

T0058765773



T0058765772



T0058765801



WXDV Set

+ **WDH 40** T0051515399



T0058741815



Ø 2,7 mm T0058741059

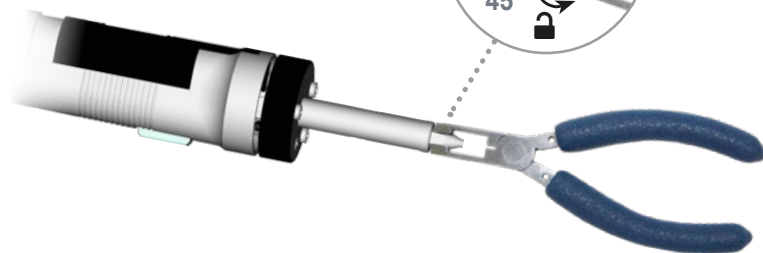
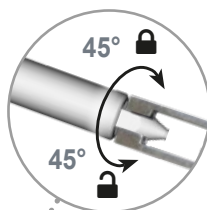
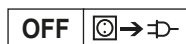

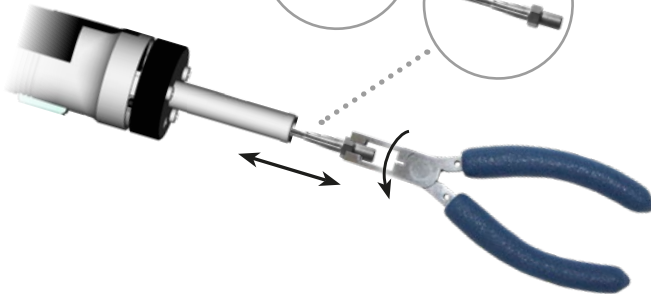
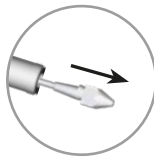
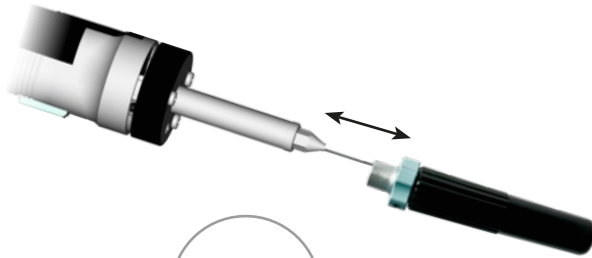
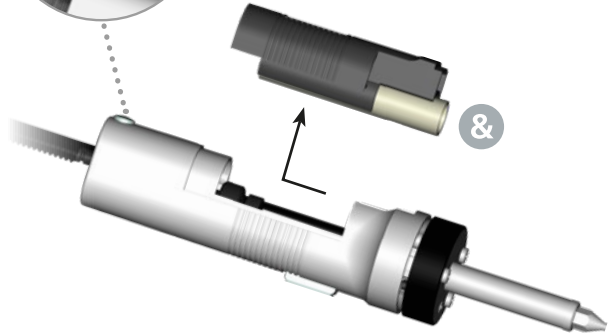
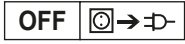
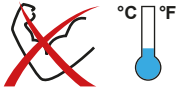

WXDV 120

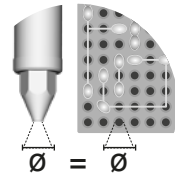
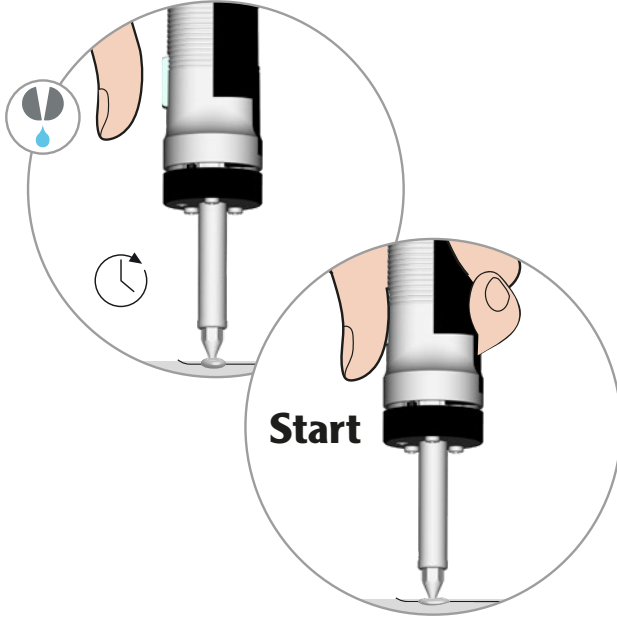

WXHAP 200



WXHAP 200 T0052711999



& WXHAP 200 Set

+ **WDH 30** T0051515299

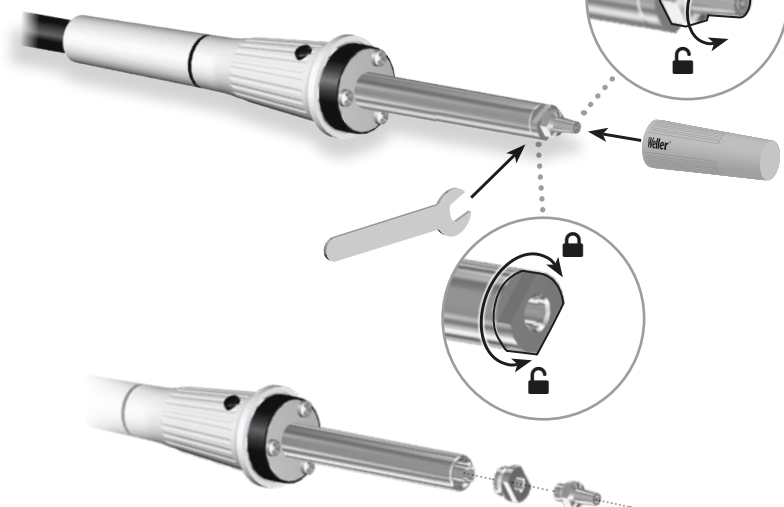
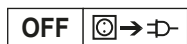

WXHAP 200

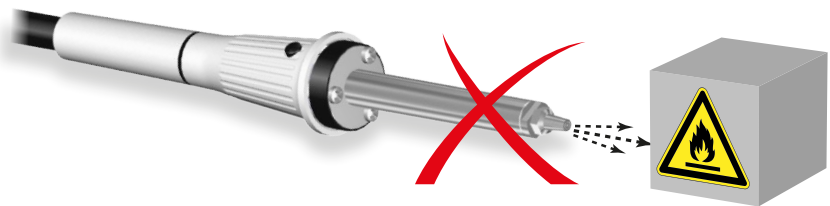
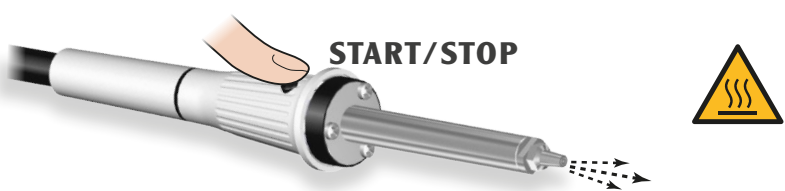

Product Registration

Produkt-Registrierung - Enregistrement produit - Registro de producto - 尊敬的客户您好

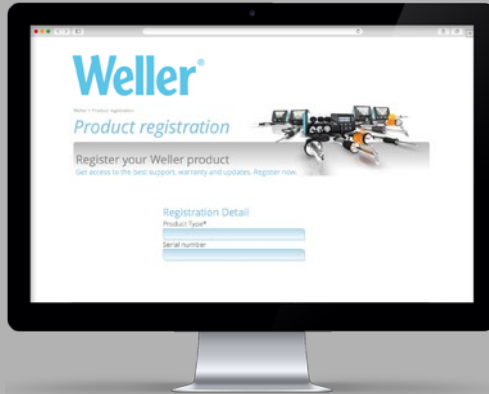

www.weller.de/registration



GERMANY

Weller Tools GmbH
Carl-Benz-Straße 2
74354 Besigheim

Tel: +49 (0)7143 580-0
Fax: +49 (0)7143 580-108

USA

Apex Tool Group, LLC
670 Industrial Drive
Lexington, SC 29072

Tel +1 (800) 688-8949
Fax +1 (800) 234-0472

CHINA

Apex Tool Group
Room 302A, NO 177 Bibo Road
Shanghai, 201203

Tel: +86 (21) 60880288
Fax: +86 (21) 60880289

www.weller-tools.com

© 2019, Apex Tool Group, LLC.

Weller® is a registered Trademark and registered Design of Apex Tool Group, LLC.

Weller®