

FM+ C

Assistive Listening System FM T55C and T55CD

USER MANUAL



Table of Contents

Safety Warnings and Instructions	3
Recycling Instructions	3
System Overview	4
Quick Setup Instructions	5
Installing the ANT 025 Whip Antenna	6
Router and Network Equipment Selection	6
Wiring and Connections	7
Ethernet and Dante RJ-45 Connection	7
Audio Source Connections	7
Multi-Channel Sources	8
Avoiding Hum in the Audio (as a Result of a Ground Loop)	8
Selecting an Audio Source Appropriate for Hearing Impaired Listeners	8
Connecting to other Devices	9
Controls and Features	10
System Settings	12
Audio Settings	12
Audio Source (OLED or Web Page)	12
Audio Input Gain	12
Audio Presets	12
Custom Audio Preset	13
High-pass Filter	13
Low-pass Filter	13
Dynamic Range Compression	13
FM Output Power	13
FM Time-Out	14
Front Display Time-Out	14
Screen Lock	14
User-Entered Transmitter Description	14
Channel	14
Restore Defaults	15
Network Settings	15
Additional WaveCAST Servers	15
Adjusting Network Settings	16
Dante	16
VU Meter Levels	17
Web Page	17
WaveCAST Receiver App	24
Download the WaveCAST App	24
Join the WaveCAST Wi-Fi Network	24
Select an Audio Channel	24
Listen to the Audio	24
Note on Wi-Fi Assist/Smart Network Switching	24
WaveCAST Receiver	25
FM Receivers	25
Troubleshooting	25
Website problems	25
Audio problems	25
Wi-Fi reception difficulties	26
FM reception difficulties	26
Remote Control is not working over the hardwired Ethernet network	27
Remote Control is not working over Wi-Fi	28
Specifications	29
Remote Telnet Control	30
Regulatory Statements	30
FCC	31
ISED	31
2-Year Warranty	32

Safety Warnings and Instructions

WARNING! TO REDUCE THE RISK OF FIRE OR ELECTRIC SHOCK, DO NOT EXPOSE THIS APPLIANCE TO RAIN OR MOISTURE.

CAUTION! TO REDUCE THE RISK OF ELECTRIC SHOCK, DO NOT REMOVE COVER. NO USER-SERVICEABLE PARTS INSIDE. REFER SERVICING TO QUALIFIED SERVICE PERSONNEL.

NOTE: THE FCC REQUIRES THIS DEVICE TO BE USED WITH APPROVED, FCC 15.203 COMPLIANT ANTENNAS AND BE PROFESSIONALLY INSTALLED. REFER TO WILLIAMS AV'S 72 MHz ANTENNA SELECTION INSTALL GUIDE FOR COMPLIANT ANTENNAS FOR THIS PRODUCT.

Precautions:

1. Power – WARNING, BEFORE TURNING ON THE POWER FOR THE FIRST TIME, READ THE FOLLOWING SECTION CAREFULLY. The unit is designed for use only with the line cord of the region in which it will be operated.
2. Voltage Label (Rear Panel) – A label located at the rear panel power connection indicates the DC power input for the unit. The label will read 24VDC. Use the Williams AV TFP 062 power supply for this unit.
3. Do not plug in the input, output, Ethernet, Antenna, or Dante connections while the power switch is switched to the on position.
4. Do not touch the FM+ C with wet hands. Do not handle the FM+ C or power cord when your hands are wet or damp. If water or any other liquid enters the FM+ C cabinet, take the FM+ C to qualified service personnel for inspection.
5. Place the FM+ C in a well ventilated location. Take special care to provide plenty of ventilation on all sides of the FM+ C especially when it is placed in an audio rack. If ventilation is blocked, the FM+ C may over heat and malfunction.
6. Do not expose the FM+ C to direct sun light or heating units as the FM+ C internal components temperature may rise and shorten the life of the components. Avoid damp and dusty places.
7. Care – From time to time you should wipe off the front and side panels and the cabinet with a soft cloth. Do not use rough material, thinners, alcohol or other chemical solvents or cloths since this may damage the finish or remove the panel graphics.

Recycling Instructions

Help Williams AV protect the environment! Please take the time to dispose of your equipment properly.



Product Recycling:

Please do NOT dispose of your equipment in the household trash. Please take the equipment to a electronics recycling center for proper disposal.



Battery Recycling:

Please do NOT dispose of used batteries in the household trash. Please take the batteries to a retail or community collection point for recycling.

System Overview

The groundbreaking FM+ C provides the industry-first choice of using traditional FM receivers or using personal electronic devices over Wi-Fi for hearing assistance. Along with this flexibility comes exceptional audio quality, as the FM+ C is built on a professional digital audio (DSP) platform.

The FM+ C is designed to support those who want to use their own smartphones and headphones for a more discreet assistive listening experience. Simplicity is also available for those who want a more traditional assistive listening system with a dedicated FM receiver and headset. Venues no longer need to choose between providing FM or Wi-Fi assistive listening systems. FM+ C supports the iOS and Android WaveCAST Apps and the Wi-Fi Receiver-- in addition to all of the current and legacy Williams AV FM receivers operating on the 72-76 MHz bandwidth.

Developed for hearing assistance in public venues, the FM+ C includes a complete audio processor optimized for the needs of hearing impaired people and are easily integrated with an existing sound system, or used with a microphone as a stand-alone system.

The FM+ C D unit provides Dante input capability, denoted by the [D] model number.

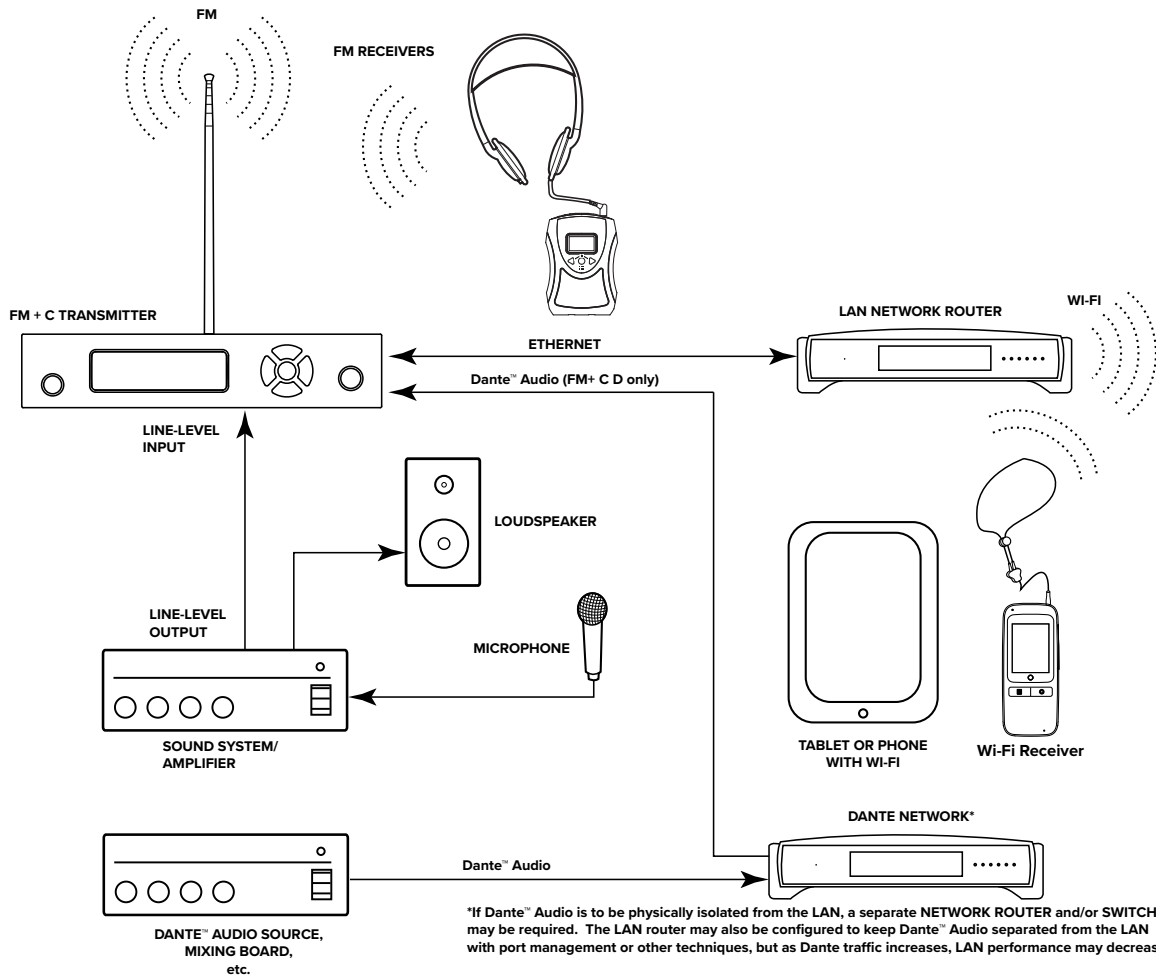

Quick Setup Instructions

1. Position the FM+ C transmitter near the sound system or mixer from which it will receive audio. We do not recommend wall or ceiling mounting, or putting the device on a cart.
 2. Connect the power supply to the Power Supply connector located on the back of the FM+ C. Press in the power button on the front of the FM+ C. The power button should light up. If not, go back and check the power connections.
 3. Choose and configure the analog audio source. The audio source must be configured in the menu before plugging the source into the jack to avoid damage to the input circuit. Push the V (DOWN ARROW) button twice to highlight "Audio Source". Push the right button to choose between ANALOG LINE IN, MIC, PHANTOM MIC +12V, Dante, or 400 Hz Test Tone. When the desired audio source is displayed, it is now live. When selecting phantom mic input, press center okay button to confirm.
 4. Push the power button to turn the unit off.
 5. Connect the audio source to the audio input jack on the rear of the FM T55C.
 6. Push the power button to turn the unit on.
 7. With the audio source playing, adjust the Audio Input Gain on the FM T55C so that the level pulses up to 0dB. Press the < (LEFT ARROW) button repeatedly to increase the Audio Input Gain, or press the > (RIGHT ARROW) button repeatedly to decrease the Audio Input Gain.
 8. Install the telescoping whip antenna that came in the box with the transmitter. (Part No ANT 025). If another antenna option is desired, see the 72 MHz Antenna Selection Install Guide on the Williams AV website for alternatives. See "Installing the ANT 025 Whip Antenna" on page 6. **NOTE: The FCC requires this device to be used with approved, FCC 15.203 compliant antennas and be professionally installed. Refer to Williams AV's 72 MHz Antenna Selection Install Guide for compliant antennas for this product.**
 9. Set the Transmitter Channel. To change the channel/frequency, while on the main info screen, use the ^ or v (UP or DOWN ARROW buttons) to navigate to settings and use the < or > (LEFT or RIGHT ARROW buttons) change channels.
- Note: The FM+ C is shipped from the factory with the channel/frequency set to Ch.1 (72.1 MHz).
10. To test FM Audio, listen with an FM receiver (using a WilliamsAV earphone, headphone, or neckloop) and walk around the listening area. The signal should be clear and quite loud when the volume is turned up.

To adjust settings via a web browser:

1. Connect an Ethernet cable from your local area network, or Wi-Fi router to the connector on the transmitter labelled Ethernet. Besides providing the web page, this network will also be used to broadcast the audio to Wi-Fi enabled receiving devices.
2. Open a web browser on a computer or mobile device that is also connected to the same local network as the FM+ C.
3. In the address bar of the browser, type in the IP address of the FM T55C (the IP Address is shown on the transmitter's main info screen) and push the enter key on the keyboard. (Note: it is not necessary to type "http://" or "www." preceding the IP address.)
4. The browser will open the transmitter's web page, displaying a Login button. Enter the user name "admin" and the default password "admin" then click the log-in button.
5. The web browser will now show the transmitter's Home Page, which shows the current FM+ C status info. The tabs at the top navigate to different pages that can be used to configure the transmitter's settings.

Installing the ANT 025 Whip Antenna

Gently thread the ANT 025 onto the stud recessed in the hole on the top of the transmitter.

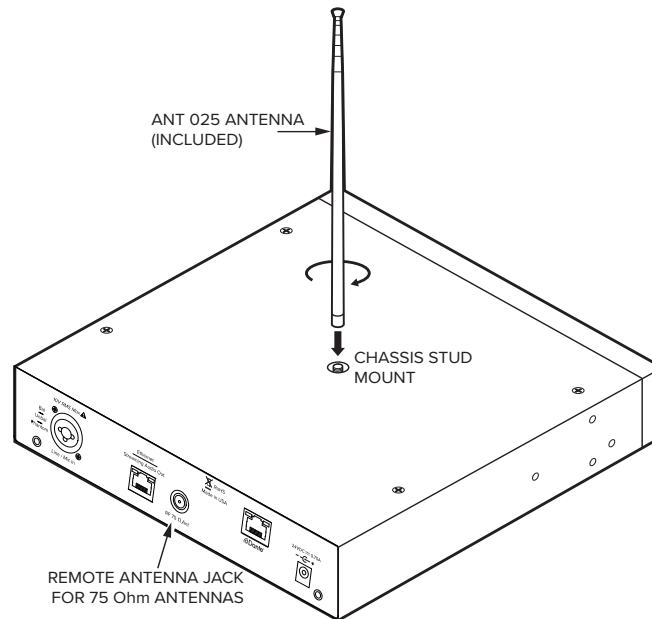

NOTE: If the FM+ C is going to be rack mounted, you will not be able to install the ANT 025 whip antenna. For rack mounting, consider installing a remote antenna like the ANT 005 or ANT 024 - these antennas require using the Remote Antenna Coaxial Jack (above) and a long length of terminated coaxial cable. Another option is to mount the antenna on the rack itself - consider the ANT 029 which includes a 1RU bracket and a 3ft terminated coaxial cable.

A Wi-Fi network is required for streaming to devices

The FM+ C unit does not provide Wi-Fi on its own. If streaming audio is desired, a Wi-Fi Network is required, for the device to receive streaming audio from the FM+ C. The Wi-Fi network will need to be established before the streaming feature can be used. The FM+ C is connected to a hard-wired ethernet network containing a Wi-Fi access point (or a router with Wi-Fi). Audio is streamed out of the RJ-45 ethernet jack over the network and through the access point, to the end device. This ethernet jack, labelled "Streaming Audio Out", is shown on page 7.

Router and Network Equipment Selection

The FM+ C is intended to be set up on an already existing Wi-Fi network; however, upgrades to your network equipment may be necessary depending on the performance desired from the FM+ C. For instance, a higher-end, more powerful router will allow more users to connect to your audio stream than using a cheaper, less powerful router.

The Wi-Fi network will need to be accessible to the users who will be listening to the audio. If the user's devices cannot connect to the network due to security settings, they will not be able to hear the audio.

The FM+ C system will put a demand on the network. If the network cannot handle the demand, whether because it is being used for other networking needs or because the networking hardware is not strong enough, the FM+ C will be unable to reach its maximum audience, and there may be performance issue, such as dropout or "breaks" in the audio.

When streaming to a small or medium sized audience, a basic networking configuration may suffice. When streaming music using multiple channels (such as having several WaveCAST or FM+ C units on your network), a powerful router and network configuration is more likely to be required.

The **WaveCAST Networking Guide** is available on the Williams AV website for additional networking tips. The WaveCAST networking guide applies to the FM+ C as well as other WaveCAST products.

Wiring and Connections

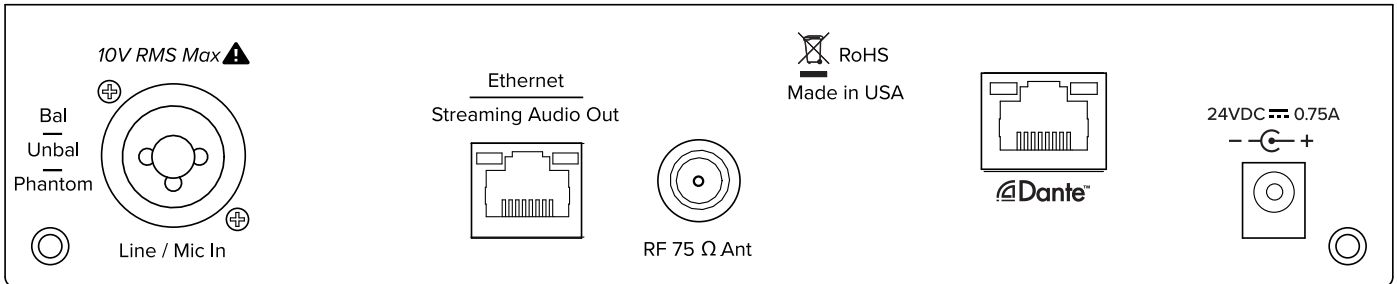
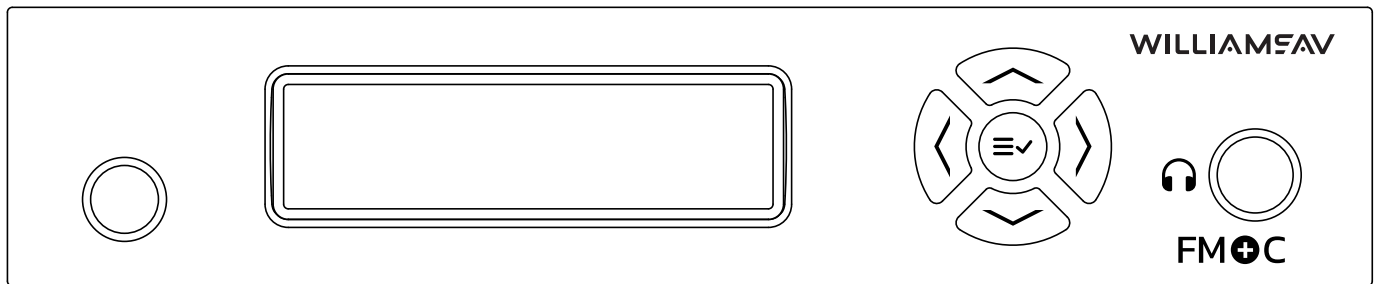

Power Supply Connection

Connect the TFP 062 power supply to the round Power Supply Jack located on the rear of the FM+ C transmitter labelled "24VDC 0.75A".

Ethernet and Dante RJ-45 Connection

If connecting to a network or directly to a PC, a Ethernet cable must be used. A **crossover** cable is not necessary because the T55C is auto-configuring.

Audio Source Connections

The FM+ C transmitter will accept the following audio sources:

1. Balanced Microphone with or without 12 volt phantom power (DIN 45596) on a 3-pin (XLR) connector.
2. Balanced/Unbalanced microphone with or without phantom power on 1/4 inch (TRS) jack
3. Balanced/Unbalanced Line on a 3-pin (XLR) connector.
4. Balanced/Unbalanced Line on 1/4 inch (TRS) jack.
5. Dante on an RJ-45 jack (optional).



WARNING:

The FM+ C is not designed to accept 70 volt speaker signals! This may result in damage to your system. The sound source should come directly from the system mixer or digital source as a low-level or unprocessed signal.

IMPORTANT: When a suitable audio source has been determined, you MUST configure the audio source in the menu of the FM+ C before plugging that source in.

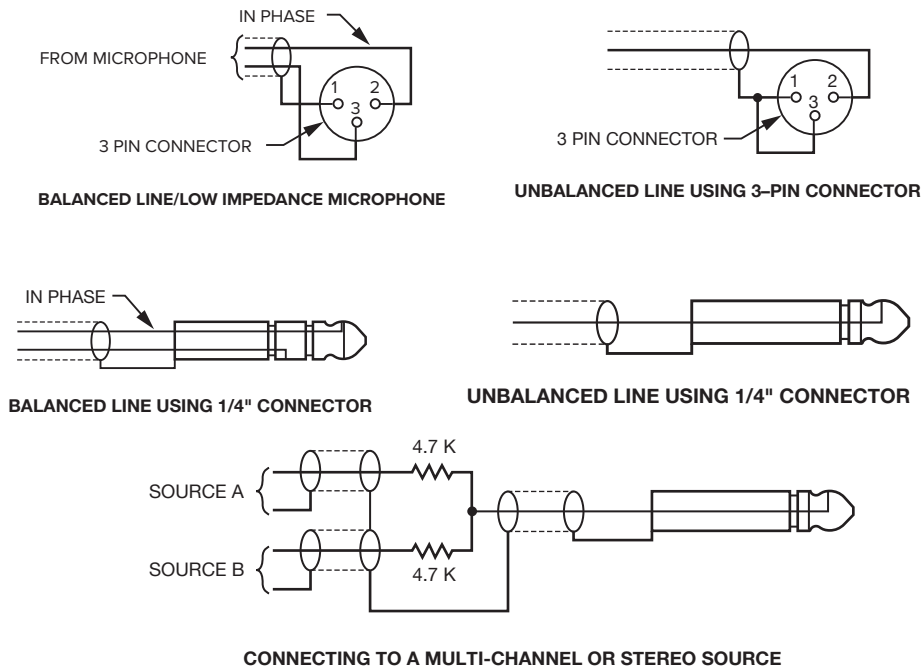

Multi-Channel Sources

By constructing a simple resistive mixer, stereo (or 3 channel) sources can be connected to the FM+ C. Additional channels can be accommodated by adding a resistor for each source.

Note: The Dante audio input will automatically mix the left and right channels.

Avoiding Hum in the Audio (as a Result of a Ground Loop)

A hum created by a ground loop can often be eliminated by connecting a capacitor in series with the audio line shield to the transmitter's ground. This method also maintains good radio frequency (RF) shielding. Determining the effectiveness of this method for your installation usually requires some experimentation.

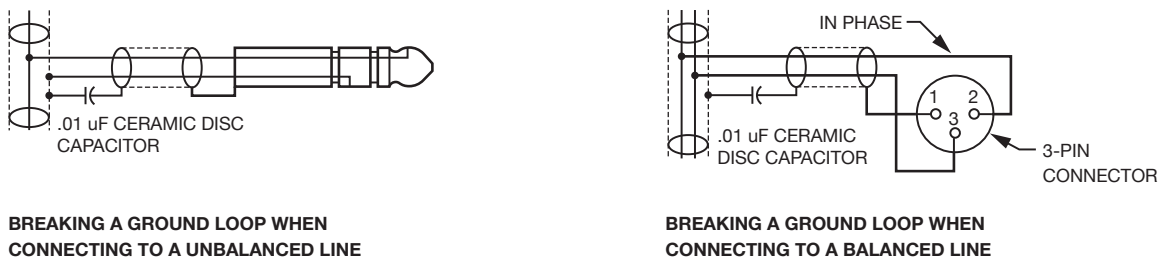

Selecting an Audio Source Appropriate for Hearing Impaired Listeners

The FM+ C transmits audio with excellent fidelity. Therefore, the audio source signal should be of the highest audio quality and not subject to a compressor, limiter, reverberation, or other signal processing equipment. While compressed audio is available through the FM+ C, excessive compression is not helpful to the hearing impaired and can contribute to excessive noise in the audio.

The FM+ C audio source signal is usually connected to a mixer's line output signal which is behind the mixer's parametric equalizers but ahead of any equalization used for house loudspeakers.

If audio delay is available for use in large auditoriums, it's usually best to use it. Because radio signals travel faster than sound, delaying the transmitted audio so that an average listener (in the middle of the listening area) hears

the transmitted audio a few milliseconds after audio from the main sound reinforcement system speaker is helpful. This will also help audience members who lip read.

Connecting to other Devices

The Analog LINE/MIC Input (XLR / 1/4") jack can be used with standard pro audio electronics such as standard pro audio line level condenser microphones up to 15v or an analog line output from a mixer. The combination jack accepts either XLR or 1/4" (TRS). This source **must be configured in the menu** before plugging the source into the jack. If, for example, the MIC Input is selected, and a *line level* source is plugged in, it may be possible to blow out the MIC input circuitry.

The Remote Antenna Connection can be used to connect a remote antenna to the FM+ C when the whip antenna won't be used (as in the case of rack-mounting) or when a larger coverage area is needed. See the **Williams AV's 72 MHz Antenna Selection Install Guide** for a full range of antenna and mounting options. NOTE: The FCC requires this device to be used with approved, FCC 15.203 compliant antennas and be professionally installed. Refer to Williams AV's Antenna Selection Install Guide for compliant antennas for this product.

The Ethernet and Dante RJ-45 jacks can be used to connect the FM+ C to either a local network or directly to a single computer or Dante device.

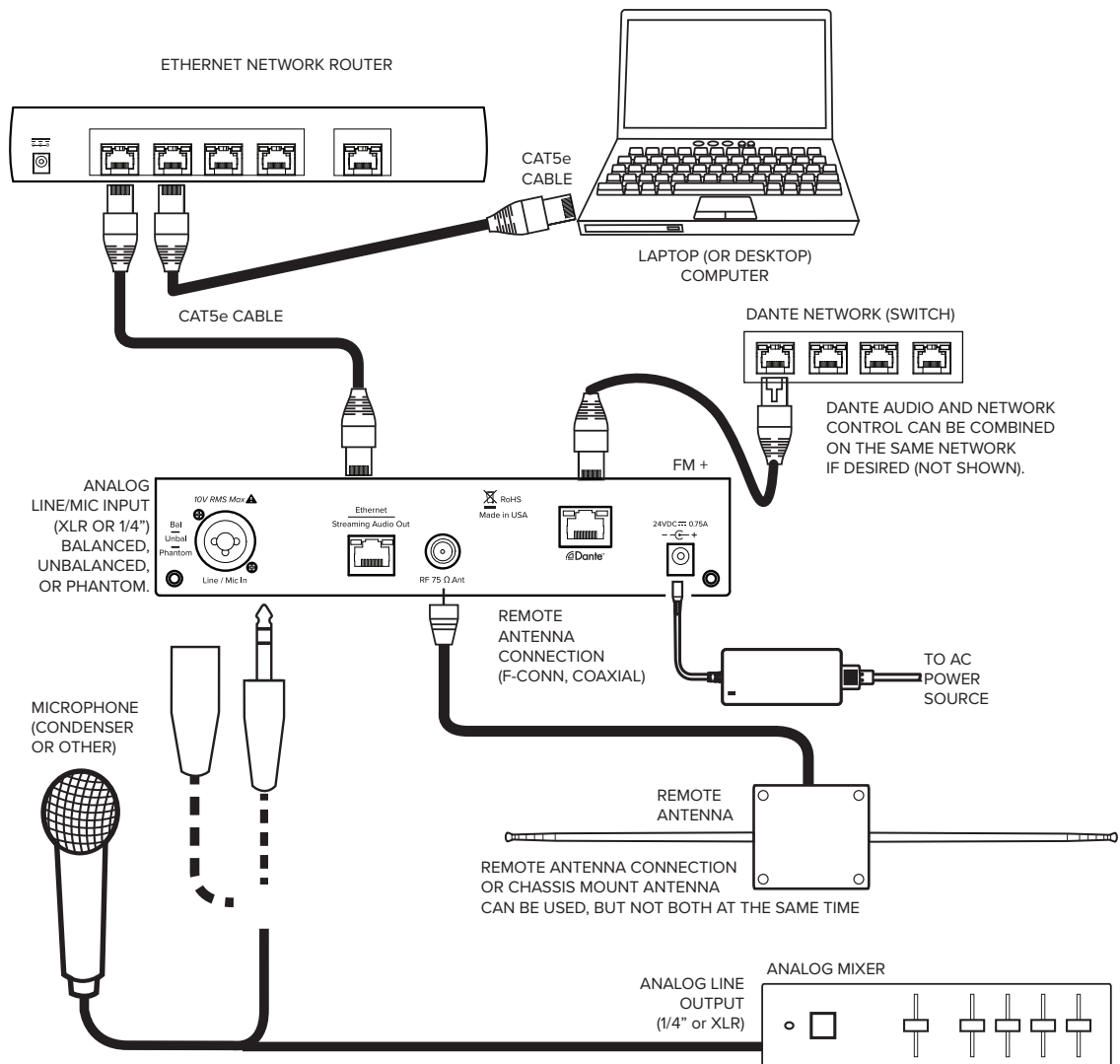

Controls and Features

Power Button

Latching push-button switch turns the transmitter on or off. The desktop power supply provides power to the unit.

OLED Display

This shows current operation settings and is also used with the menu control buttons for configuring the FM+ C. Each time the power of the unit is turned on, the OLED Display shows a FM+ C start-up screen. After several seconds, the default Main Info Screen screen will be displayed. The FM+ C is now fully operational.

NOTE: If the transmitter's internal tests fail, the transmitter will display a failure message. If it continues to fail on repeated boot-ups, call WilliamsAV and ask for Tech Blue to assist.

Main Info Screen

The Main Info Screen will show various setting information including IP Address (If connected to Ethernet network), Server Number, Server Name, EQ Preset, Input Gain, Audio Source, FM Channel and broadcast power level.







If the IP Address is grey, the network connection is not working and the FM+ C is offline.

If the FM Channel is grey, FM is not currently being broadcast.

Screen Navigation

While navigating through the settings, the setting to be changed will be highlighted. Use UP and DOWN arrows to navigate through settings (e.g., Input Gain, Audio Source, etc.), and the LEFT and RIGHT arrows to change that setting (e.g., Audio Input Gain up or down).

- The **Down** button  navigates forward/down through different settings.
- The **Up** button  navigates backward/up through different settings.
- The **Left** button  navigates backward through settings.
- The **Right** button  navigates forward through settings.
- The **Select** button  1. A single push wakes up the display if it is in sleep mode 2. A push and hold brings up the information screen 3. If display is on, a single push of this button does nothing.

For example, to change the Input Gain, push the Select button once to highlight the Input Gain current setting. Then use the left or right arrow button to adjust the Input Gain up or down.



Information Screen

This screen provides Network Info and Firmware Version of the unit, depending on what is selected.

1. Push and hold the Select button until the following screen is displayed:



2. Use the right or left arrow buttons to highlight "Version" or "Network". Select the highlighted one by pushing the select button.

Selecting "Version" will display the following info:



Selecting "Network" will display the following info:

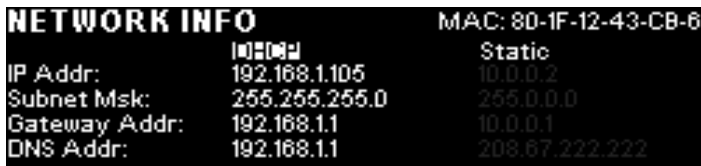

When the network audio server is enabled, the wi-fi symbol in the upper left corner of the VU meter area will appear in bright white. When disabled or disconnected from the network, the icon will appear dim with a small 'x' in one corner.

On the front panel, the status of all servers on the network displays one of the following statements:

- **Server x of n** – the server is enabled and operating normally, where n is the total number of audio servers on the network and x identifies this unit.



- **Wi-Fi Audio OFF** – the network audio transmitter is disabled or the network is disconnected.



- **WARNING: Server stack full** – the attempt to connect this unit to network was unsuccessful as it would exceed the allowable limit of the number of servers. See "Additional WaveCAST Servers" on page 15 or more information.



- **Server not synced** – this unit has not yet or is unable to sync with the master audio server. This only applies when more than one unit is on the same network.



- **Incompat. server at <ip address>** – a server, identified by IP, that cannot be on the same network as this unit has been detected on the same subnet. This applies when the FM+ C unit is on the same network as one or more Wavecast devices with outdated or incompatible firmware. Please contact Tech Blue for help.



FM Power



This icon, located in the lower left corner of the VU meter area, indicates the “on-the-air” and power level status of the FM transmitter. When not broadcasting (no FM signal), this icon will appear fully dim. Otherwise, the number of bright arcs (1: Low, 2: Med, 3: Full) appearing in the icon indicates the configured FM power level. Default: Full power.

The Full power level has been calibrated at the factory in accordance with FCC limits. In the very unlikely event this calibration has been disturbed, and the unit is configured for Full power, actual transmitter power is automatically limited to a medium power level. Under this condition, the icon will appear as “CAL” over the normal medium power icon.

System Settings

Settings can be selected and adjusted either by (1) using the arrows on the front of the FM+ C to navigate the OLED menu system, or, (2) by the web page by using a computer. Not all settings are available in the front panel menu or through the web page, and using both may be necessary for your initial set up.

Audio Settings

The Audio Settings provide the ability to change the audio characteristics for different listening applications, choose the input source, adjust the input level, and adjust the headphone volume.

Audio Source (OLED or Web Page)

The Audio Source menu is used to configure the FM+ C for the audio source jack and type of source that will be used. The audio source **must be configured in the menu** before plugging the source into the jack.

The Audio Source menu has the following selections to choose from: Line Level, Microphone, Mic + 12V (Mic+Phnt), 400Hz 0dB Test Tone or Dante (optional).

This can be set through the front OLED display or the web page.

Note: When selecting Mic +12v, the additional voltage will not activate until ‘Select’ is pressed as confirmation.

Audio Input Gain

The Audio Input Gain adjusts the incoming audio level into the FM+ C. This adjustment only affects analog audio. Changes to the input level will affect the level, indicated by the graphic level display pulsing higher or lower when audio is present. Audio Input Gain is adjustable from -60dB to +24dB in 1dB steps.

Audio Presets

The Audio Presets allow the user to quickly and easily configure the FM+ C for common applications. There is a **Custom** setting if customization is desired, or three pre-configured settings.

There are three pre-configured to choose from: **Hearing Assist, Music, and Voice**. When one of these selections is made, the performance of the FM+ C is immediately optimized for the needs of that application (an adjustment is automatically made to the Low-pass Filter, High-pass Filter, and Compression). Refer to the chart below for a comparison of the Audio Preset configurations.

Audio Preset Configuration Table

Preset	High-pass	Low-pass	Compression
Voice	125 Hz	6.3 kHz	1:1
Music	31 Hz	16 kHz	1:1
Hearing Assist	500 Hz	8.0 kHz	2:1

For music, concerts, and other applications where the highest audio quality is desirable, **Music** is the recommended mode of operation. By default, the FM+ C is shipped in the **Music** mode.

For hearing assistance applications or applications where the message is critical for listening, **Hearing Assist** is the recommended mode of operation.

For speaking and other voice applications, **Voice** is the preferred mode of operation.

This can be set through the web page ONLY.

Custom Audio Preset

If the three preset configurations do not meet the needs of the venue, the Custom audio preset can be used. The custom preset allows the user to adjust the High-Pass Filter cutoff frequency, Low-Pass Filter cutoff frequency, and choose the Compression Ratio. If the audio preset is changed from Custom to Music, Hearing Assist, or Voice, the Custom settings are still saved for use in the future. The custom settings are overwritten when the preset is changed.

This can be set through the web page ONLY.

High-pass Filter

A High-pass Filter cuts off low frequencies and lets high frequencies pass through. The pole frequency chosen is the point where the cutoff takes effect. The high-pass filter will help to remove low frequency noise from the transmitted audio signal, such as room noise, a line hum, or breath accents picked up from an improperly installed microphone. Available frequencies are: 31, 63, 80, 100, 125, 160, 200, 250, 315, 400, 500, and 630 Hz.

This can be set through the web page ONLY.

Low-pass Filter

A Low-pass Filter cuts off high frequencies and lets low frequencies pass through. The pole frequency chosen is the point where the cutoff takes effect. The low-pass filter will help to remove high frequency noise from the transmitted audio signal, such as hiss in the audio line as a result of room noise, sharp speech sounds, or other uncomfortable high frequency sounds. Available frequencies are: 3.5, 4.0, 5.0, 6.3, 8.0, 10.0, 12.5, and 16 kHz.

This can be set through the web page ONLY.

Dynamic Range Compression

Dynamic range compression reduces the volume of loud sounds and amplifies soft sounds. This type of compression is typically used for voice and hearing assistance applications for a listener who has difficulty hearing the quiet sounds of an audio broadcast.

For listening to music programs, concerts, etc., lower compression ratios or no compression is generally used. The FM+ C has three selectable modes of compression: 1:1 (compression off), 1.5:1 (low compression) or 2:1 (high compression).

For applications such as music and voice, where high audio quality is desirable, 1:1 is the recommended mode of operation. For hearing assistance or applications where the transmitted message is critical for listening, 1.5:1 or 2:1 is recommended.

This can be set through the web page ONLY.

NOTE: The FM+ C is shipped from the factory at a 1:1 compression ratio (no compression).

NOTE: Some hearing impaired people cannot tolerate as loud of a sound as those with normal hearing. Using compression can help protect those users. However, compression also can make audio sound flat. Only use compression when it is the best choice for the listeners.

FM Output Power

The selectable transmitter power levels are Full, Medium (-10dB), Low (-20 dB), and Off. By default the FM+ C is set to full power mode. For general listening applications, full power is the preferred mode of operation. Full power provides an operating range of up to 1000 ft (dependent on the environment and antenna installation).

For special listening applications, it may be desirable to reduce the overall operating range if:

- The audio transmission is to be contained to a smaller listening area;
- The signal is too strong and it is overloading the receiver
- Multiple transmitters are used in adjacent rooms where the FM signals overlap each other.

In these cases, the power level can be reduced to -10 dB or -20 dB. The output may be temporarily set to off to help troubleshoot interfering or overlapping Radio Frequency signals.

This can be set through the web page ONLY.

FM Time-Out

The FM Time-Out setting determines how long the transmitter continues to transmit over FM with no audio present or front panel interaction. After the time-out period occurs (with no audio input and no front panel button presses), the FM+ C will go into sleep mode to conserve power. During sleep mode the transmitter is completely shut off and the power switch light will fade from bright to dark to indicate the unit is in sleep mode. The available options are: 30 minutes, 4 hours, or Always On.

This can be set through the web page ONLY.

Note: FM Time-out delay and Screen Time-out delay are two independent events.

Note: Some firmware version may call this setting RF Time-Out on the web page.

Front Display Time-Out

The Screen Time-out is the amount of time the front panel screen will stay lit with no activity. This only indicates that the front panel menu system has not been used for a period of time. It does not indicate whether the device is actively transmitting or not. The available options are: 10 minutes, 30 minutes, 2 hours, and Always On.

This can be set through the web page ONLY.

Screen Lock

The front panel screen of the device can be locked to prevent any changes from being made outside of the web page. The buttons may be locked and unlocked by pressing and holding both the left and right buttons at the same time. When locked, a small lock icon appears at the top middle of the screen. Once locked, if a button is pressed, a popup message will alert that the screen is locked.

Screen lock can be set two ways; 1. Using the front buttons as described, 2. Through the web page on the Options page.

User-Entered Transmitter Description

The Description field allows the user to easily identify the transmitter and can only be adjusted from the settings website. This typically comes into play when multiple transmitters need to be distinguished from each other. The description appears on the front main info screen, the WaveCAST app, and also on the web page. In a rack, all the user has to do is activate the main info screen with a touch of any button on the front, and the description is displayed as one of the fields on the main info screen.

On the web page, this appears under the Channel/Server Description of the Options web page, making it easy to identify which transmitter the web page is controlling. It's possible to enter all blanks in the description field, and then the description will be blank on the front display.

This can be set through the web page ONLY.

Channel

The FM+ C transmitter supports 17-channel and 8-channel modes. 17-channel mode allows the user to select any of the 17 wide band frequencies available in the 72.1-75.9 MHz range approved of for ADA compliance in most of North America. Check your countries laws to see if using this range is legal for accessibility.

To avoid interference in multi-channel applications, select 8-channel mode. These channels have been carefully selected to prevent interference. The first 8 channels can be used simultaneously in the same area, meaning, up to 8 transmitters, each broadcasting one of these channels, can be broadcasting at the same time., in the same area.

This can be set through the front OLED display or the web page.

Note: The FM+ C is shipped from the factory with the frequency pre-set to Channel 1.

Ch	Freq (MHz)	Simultaneous Use
1	72.1	√
2	72.3	√

Ch	Freq (MHz)	Simultaneous Use
3	72.6	✓
4	72.8	✓
5	74.7	✓
6	75.4	✓
7	75.7	✓
8	75.9	✓
9	72.5	
10	72.2	
11	72.4	
12	72.7	
13	72.9	
14	75.3	
15	75.6	
16	75.8	
17	75.5	

Channel/Frequency Selection Chart

8 groups can operate simultaneously without interfering with each other. The first 8 channels (in the first column) have been designed for non-interference, and can be used for this purpose.

Although these 8 channels have been designed to not interfere with each other, outside sources of interference may limit how many of these channels may be used.

Restore Defaults

The Restore Defaults action will restore the transmitter to its original factory settings. Restoring defaults from the front panel or the web page will reset all settings including IP Addresses, Subnet Masks, Gateways, IP Address Mode, and Web Password. After the FM+ C reboots, any static ethernet connections will be lost.

This can be set through the front OLED display or the web page.

Network Settings

The FM+ C is defaulted to DHCP if no configuration has been done. An IP address will be automatically assigned to the FM+ C once an Ethernet cable has been connected to the device and network connection found. (Assuming there is a DHCP server on the network). Any change from the default configuration (DHCP) has to be done through the WebGUI. For example, entering a Static IP, Subnet, etc.

Network Settings can only be edited from the web page.

Additional WaveCAST Servers

Several WaveCAST devices can be on the same network. WaveCAST devices include the original WaveCAST, FM+, IR+, and WaveCAST EIGHTS, along with their Dante counterparts. The number of devices that can be put on the network depends on if the device is or has been configured as a unicast or multicast device.

Up to eight WaveCAST EIGHTS can be on the same network, as these devices are all multicast. Adding in an original WaveCAST or FM+ C running in unicast mode will lower the maximum number of devices to four, because those devices are unicast.

The maximum number of devices allowed on the network can be adjusted with the Max Servers on Subnet option on the web page. This may be necessary if you have a mix of unicast and multicast devices.

This setting must match on all multicast devices on the same network, or the devices will throw an error and be

unable to stream. Unicast device will always be limited to 4 devices on the network, and therefore do not have a Max Servers on Subnet setting. If unicast devices are included on the network, the Max Servers on Subnet setting on multicast devices must be set to 4.

If only multicast devices are included, the maximum can be set to 4 or 8, as long as Max Servers on Subnet settings is the same on all devices. If settings are mismatched, the server will be unable to stream audio and will throw an Incompatible Server error. Devices that are missing this feature may need their firmware updated.

Adjusting Network Settings

The Network Settings screen where the IP Address Mode (Static or DHCP), the IP Address, and Subnet Mask are set via the web page. See "Network Settings" on page 15 for details on how to use the web page.

Network Settings:

IP Address Mode Static or DHCP

IP Address If set to DHCP mode "Current IP Address" is displayed. When set to Static mode, these fields appear as "Static IP Address", "Static Subnet Mask", and "Static Gateway Address". When the "IP Address Mode" is set to Static, the IP information must be manually entered.

Subnet Mask If the IP Address Mode is set to Static, this is where the Subnet Mask is manually entered

Gateway If the IP Address Mode is set to Static, this is where the gateway is manually entered

Note: Subnet Mask and Gateway only apply when Static is selected

Mac Address this is displayed only and cannot be altered

TTL this settings controls the amount of switch hops before the packet is dropped

Advanced Options:

Secure Mode This can be enabled or disabled, and a 6-digit PIN number can be assigned. If enabled, users will need to use this PIN to log on to the audio stream over Wi-F. Users attempting to listen to the stream without the PIN will be unable to do so.

Network Compensation Buffer increasing this setting buffers more packets, thereby reducing the amount of dropped packets (choppy audio), but increases latency (lip-sync delay). Decreasing this setting increases latency and also increases the possibility of dropped packets.

Audio TX Mode Audio can be broadcast as unicast, multicast, or completely shut off.

Max Servers on Subnet When in unicast mode, up to four servers can be active at the same time. When in Multicast mode, up to eight serves can be active. See "Additional WaveCAST Servers" on page 15 for more details.

Multicast Address If needed, the multicast cast address can be enabled and either manually set or randomly generated. This setting is under the Advanced options.

DHCP IP Addresses are usually preferred to manual static IP addresses unless there is a good reason to use a Static IP scheme.

To set up a static IP Address:

1. Determine appropriate static IP, subnet mask and gateway addresses for the FM+ C.
 - a. If someone set up your network, they may be able to help you determine an appropriate IP address (i.e. network system administrator).
 - b. There should be no other device having this same address on the network.
 - c. This will be an address on the same subnet as the router.

For example, if the router's address is 192.168.1.100, the first three sets of numbers will be the same (i.e. 192.168.1), and the last number will be the number you determine for the FM+ C (i.e. .You can choose another number instead of .100).

When you determine this address, remember or write it down. You will need it later.
2. In the web page on the Network Settings page, select 'Static' for the fields to show, then enter the above information for the device.
3. Click **Submit and Reboot** when ready.

4. A notification will be displayed. Acknowledging the notification will save the settings and restart the device. Selecting the "Request a static multicast address" requests a multicast address from the router.

Dante

Dante can be set as an input from the front display or web page. Audio routing is configured through Dante controller. There are no additional settings available on the front screen or the web page.

VU Meter Levels

The VU level corresponds to specific decibel ranges, and may cause issues when set too low or too high. Use the table below to pick an appropriate range for your venue's audio.

VU Level	Decibel Range	Note
11	>= +12	Overrange – '!' appears above meter
10	+9 to < +12	
9	+6 to < +9	
8	+3 to < +6	
7	0 to < +3	Indicated by marks at sides of meter
6	-3 to < 0	
5	-6 to < -3	
4	-9 to < -6	
3	-12 to < -9	
2	-15 to < -12	
1	-18 to < -15	
0	< -18	All bars turned off

Web Page

The FM+ C provides a web page to manage the transmitter settings which can be accessed over either a hard-wired or wireless network connection with most internet browsers.

Most changes take effect when the submit button is clicked. The only setting that takes immediate effect is the audio input gain, so that the changes can be immediately seen on the VU meter. Some changes require a reboot. Any updates made through the front panel will show up on the web page once the current page has been refreshed (navigated away from, going to a new page, or simply refreshing the page).

1. Open the web browser of your choice.
2. In the address bar of the browser, type in the IP address of the FM+ C (displayed on the front OLED screen) and hit Enter.
3. You should see the Login Page of the FM+ C.

Login Page

The default User name is “admin” and the default password is “admin”. The user name and the password can (and should) be changed on the website's Admin page.

Error Alert

If the FM+ encounters an error, a message may appear at the top of the screen. Clicking the Clear Error button will hide the alert. Not all errors require action, however, if an error continues occurring or affects system performance, contact Tech Blue.

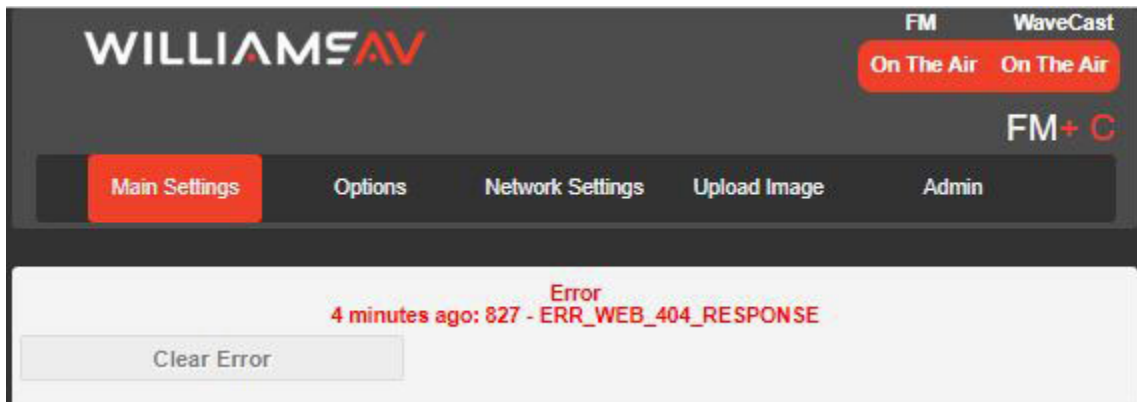

Main Settings Page

The Main Settings page displays all current audio settings, as well as corresponding FM+ C web-based controls. It is the first page to appear when logging into the website.

The RF Settings section only affects FM broadcasts. All other settings apply to both Wi-Fi and FM broadcasts.

Note: Network speed can also affect the audio monitor updating and web page performance.

WILLIAMSAV FM WaveCast
On The Air On The Air

FM+ C

Main Settings Options Network Settings Upload Image Admin

Clear Error

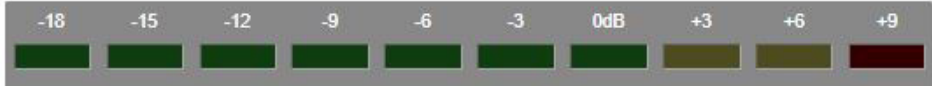

Transmitter Information
Model: FM+ C
Description: Jon Unit
Server 1 of 1

RF Settings
FM Radio: On Off Output: FULL
FM Timeout: 30 Min. Channel Selection: 8-Channel 17-Channel
Channel: 1 (72.1 MHz)

Audio Input Gain
0 dB Down Up

Audio Input Source
Warning: Phantom Powered Mic 12v (XLR / ¼). Phantom powered microphone power source CAN cause damage to certain inputs (such as an MP3 player or cell phone)
Dante

Audio Presets
Voice **Music** Hearing Assist Custom
High Pass Filter: None Hz Low Pass Filter: None kHz Compression: 1:1

Submit

Logout

Options Page

The Options page displays user preferences that can be tailored to each FM+ C system.

The description sets the name of the device, which may be used to uniquely identify the device without referring to the IP address.

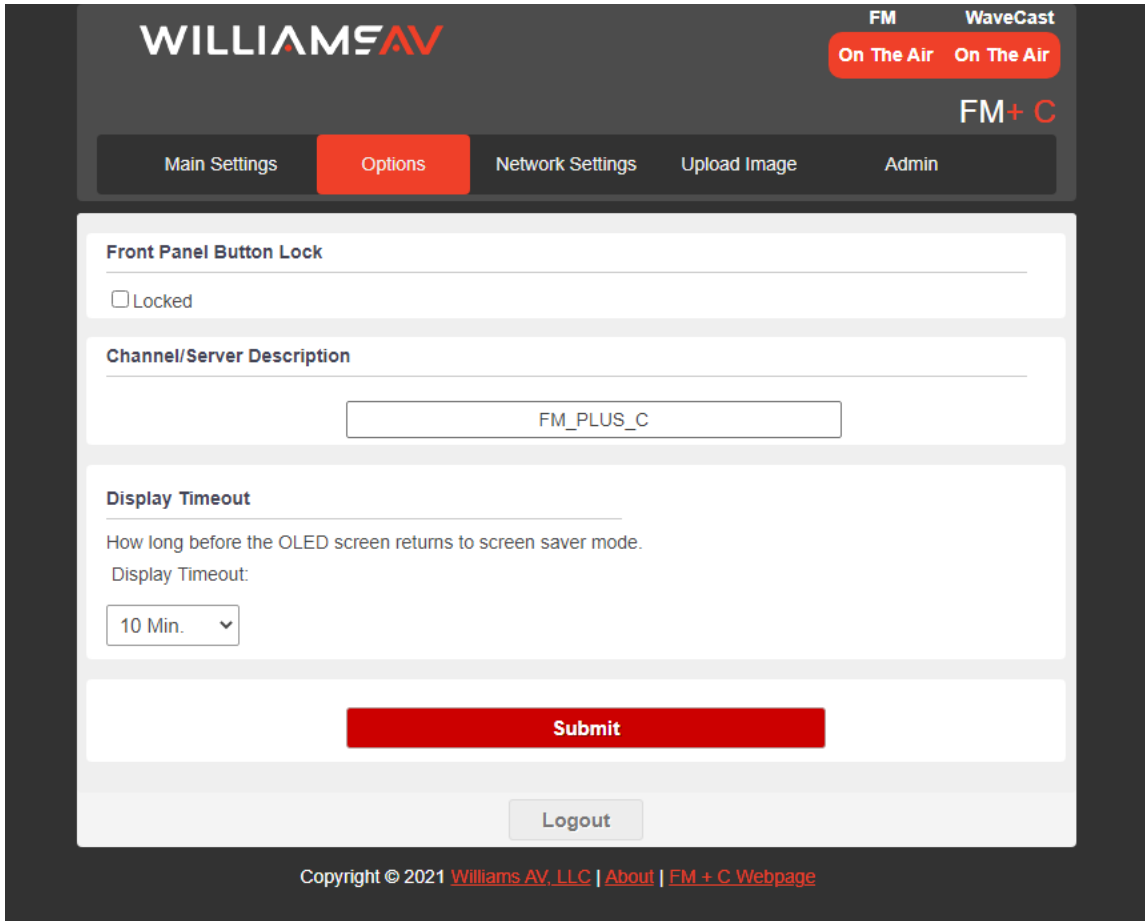

Error Message: ERR_WEB_404_RESPONSE

This error message indicates no internet connection. This connection is optional; however, without an internet connection, most personal devices will seek a different connection for data service. Sometimes without the user's knowledge, the phone's data connection will switch from Wi-Fi to cellular service. When this happens the App will not produce any audio, and the user will have to manually change their phone's data service back to Wi-Fi and make sure they are connected to the Wavecast access point, and possibly need to close and re-open the App. One way around this is to put the phone in Airplane mode, as this limits the phone to Wi-Fi only.

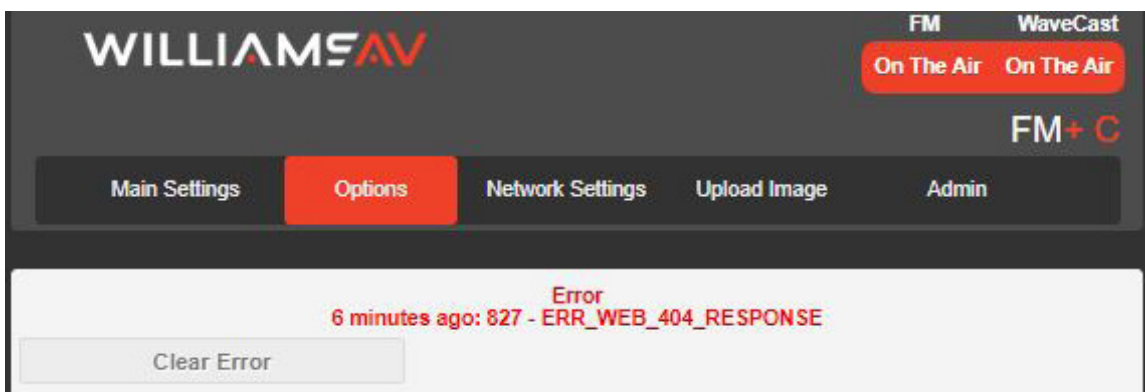

Upload Image Page

An image can be uploaded that will display next to the channel name for any users listening using the WaveCAST Receiver app. This image can be used to easily distinguish the content of your audio broadcast. The image must be under 128kB and be in PNG or JPG format. If no custom image is uploaded, the default Williams AV W logo will display instead:

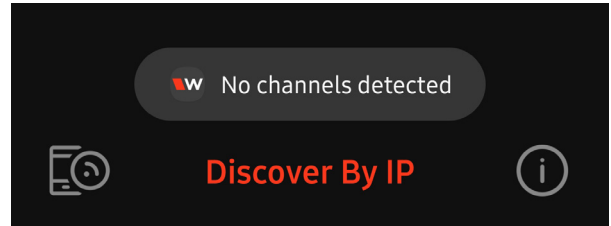

The image can be replaced at any time. To completely remove the image, the device must be reset via the front panel menu.

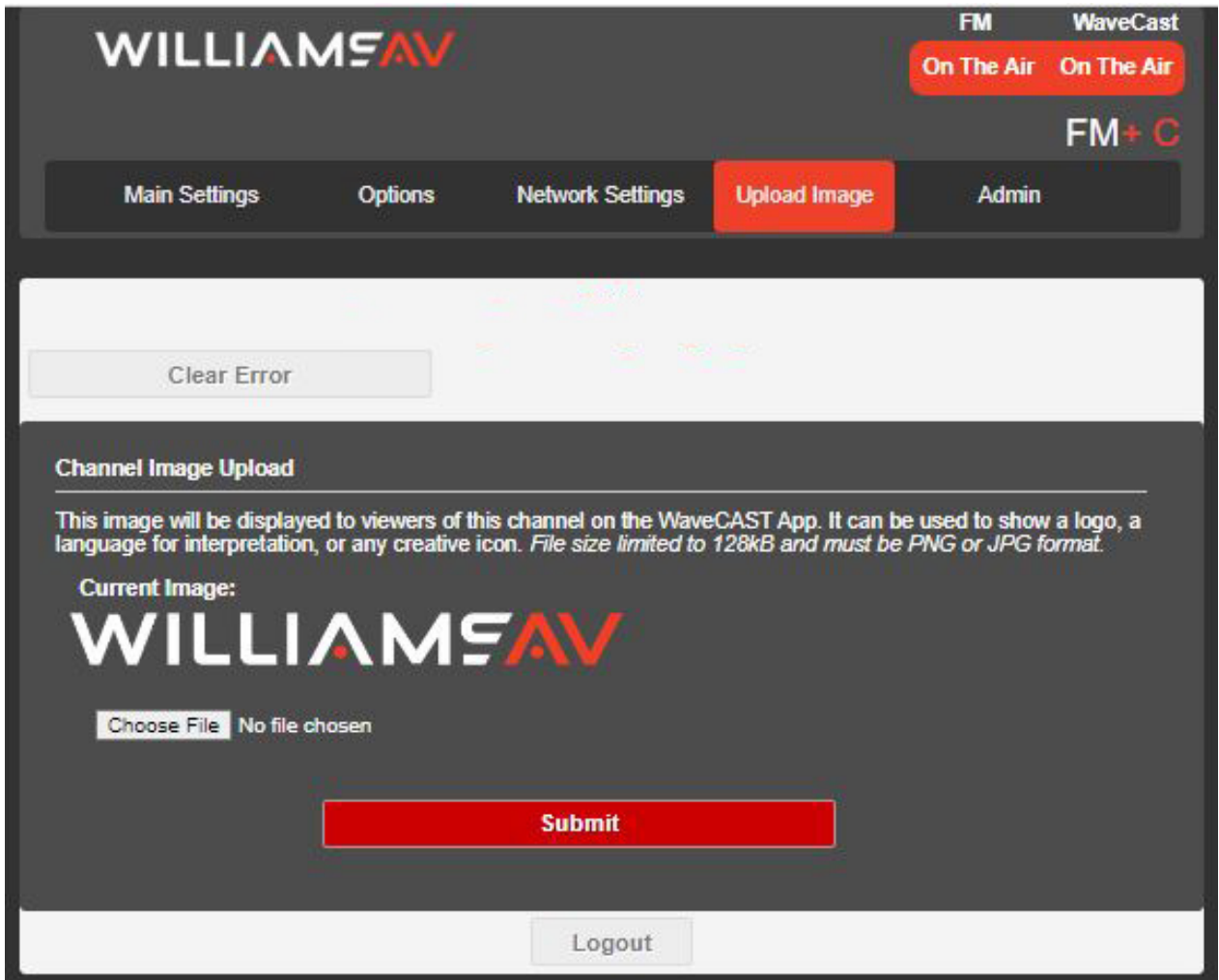

Network Settings Page

The Network Settings page displays the current network configuration of the unit. Typically these are not modified after initial installation is completed.

Changing a static IP address or subnet will not instantly take place. The changed IP address or subnet will only take effect once the device is rebooted. Rebooting can be done with the front power button or by using the "Submit and reboot" button on the Admin web page.

WILLIAMS AV FM WaveCast
On The Air On The Air
FM+ C

Main Settings Options **Network Settings** Upload Image Admin

Clear Error

IP Address Mode

DHCP Static

Current IP Address

192 168 1 113

Mac Address:
80:1F:12:43:D1:B6

TTL
1

A TTL of 1 is recommended for the least latency. The maximum value is 31.
Changing the IP address, TTL or address mode will reboot the device.

Submit and reboot

Advanced Options

Secure Mode
 Enabled Disabled

Network Compensation Buffer
MIN MAX
60 ms

Audio TX Mode
Unicast only allows up to 4 servers on a subnet. Multicast allows a choice of a maximum of 4 or of 8 servers.

Unicast Multicast Network Off

Max Servers on Subnet
 4 8

Multicast Address
Multicast addresses are typically automatically assigned, but a custom address may also be used.
The current multicast address is 239.168.0.0

Request a static multicast address

Submit

Logout

Administration Page

The Admin page displays administrative controls that can be used to help with non-technical FM+ C users, or for remote site troubleshooting purposes.

The login username and password for the website can be set from this screen. If the username or password is ever forgotten, it can be restored to its default value by restoring defaults via the front panel menu.

The Restore Defaults button on the web page (as well as the restore factory defaults function on the front screen) will reset all of the device settings including username, password, and IP information.

Updates are performed from the Admin page. At the bottom of the page, upload the update file (provided by Williams AV) and hit the update button. Your system will begin the update process from there, which will include a reboot. **Do not power down the device until it has successfully rebooted (main info screen has appeared)..** There is no indicator for the progress of the update, but it should take around two minutes.

Updating, restoring or rebooting the device will make the website temporarily unavailable as the system resets.

A full error log can be downloaded by clicking the Download Error Log link. This may be useful when working with Customer Service.

Note: If the IP address or subnet of the device was changed and the device is being rebooted, the website may not be available at the same URL location. Take note of the network information before rebooting the device. See "Network Settings" on page 15 for more information.

FM+ C

Main Settings Options Network Settings Upload Image Admin

Clear Error

Change Password

When using Chrome, you may get a pop-up that your password has been stolen. This is due to choosing a non-unique username and password combination that has been used elsewhere on the internet. This process is fully controlled by Chrome and can be ignored if you so choose.

User Name

Password

Password Verify

Set Password

Additional Functions

Reboot Restore Defaults [Download Error Log](#)

System Update

Updates can be downloaded off our our company website. [Click here to check for the latest update](#)

Package Version: 0.0.10
Firmware Version: 0.0.35
Web Version: 0.0.31

No file chosen

Update

Logout

WaveCAST Receiver App

The WaveCAST Receiver app allows listeners to hear the audio on their personal, Wi-Fi connected devices, such as a mobile phone. Make sure the latest app is downloaded on the device and the latest OS is installed.

Download the WaveCAST App

Download the WaveCAST app from the Apple App Store for iOS devices or Google Play Store for Android devices.

It is recommended that the app is downloaded in advance over an internet-connected wi-fi network or cellular network.

Join the WaveCAST Wi-Fi Network

Once the WaveCAST App is downloaded, join the same Wi-Fi network that the audio is being broadcast over. If no channels are listed when selecting an audio channel, there is no audio being streamed on this Wi-Fi network. Ensure you are on the correct Wi-Fi network.

Select an Audio Channel



When the App is opened for the first time, a list of available channels will appear. Tap on the channel to listen to the audio. The venue should provide the name of the channel to listen to for your event if more than one is available.



Channels marked with a lock icon require a code to join. Enter the join code assigned to the channel when prompted. If a channel is currently streaming, it will have a blue checkmark next to its channel name.

If there are many servers on your network, or your network is set so that servers cannot be discovered by outside devices, the WaveCAST app can connect to a server via IP address. Tap the **Discover by IP** text at the bottom of the channel screen then enter the IP address of the WaveCAST server. The channels being broadcast by that server will then be available on the channel select screen. *It is recommended that this feature is not used with a general audience as they may not type the IP address correctly.*

Listen to the Audio

Once an audio channel has been selected, the audio should start playing automatically. The volume of the audio can be adjusted using the slider in the middle of the screen, or with the physical volume controls on the personal device.



To mute the audio, tap the speaker icon. Tap it again to unmute the audio.

To switch channels, hit the back arrow at the top of the screen.

Note on Wi-Fi Assist/Smart Network Switching

The WaveCAST **does not require** an internet connection. It can be placed on an internal network with no internet connection.

Some phones expect network connections to provide internet access. When the phone cannot reach the internet, it may automatically try to switch to a network connection with an internet connection. Sometimes, the phone determines that the best internet connection is through a mobile data network.

This is not the desired behavior when using the WaveCAST network. The phone will automatically take the user off of the WaveCAST audio streaming network, and onto a unrelated internet network connection. This will prevent the user from hearing the audio, and they may not realize their phone switched networks on them.

Steps for disabling this feature will differ for every phone, but is typically found under the Wi-Fi or Mobile network settings. Look in the manual for your phone for instructions on disabling this feature.

WaveCAST Receiver

The WaveCAST Receiver (WF R1 or WF R2) is available for customers who do not want to use their personal device for listening to Wi-Fi Audio. The receiver is a dedicated listening device with the WaveCAST app available on it. The WaveCAST Receiver will work with the Wi-Fi features of the FM+ C.

For more information on our Wi-Fi receiver, visit williamsav.com for product specifications, manuals and more.

NOTE: Wi-Fi receivers may be required to meet national and international requirements for device minimums when using Wi-Fi audio for assistive listening. Personal devices typically cannot be counted in meeting device requirements; receivers must be available on request. Please check your location's legal requirements to see if you need a Wi-Fi Receiver.

FM Receivers can be used to meet the requirements if FM audio is being broadcast.

FM Receivers

Williams AV has a variety of FM receivers that will work with the FM broadcast of the FM+ C System. Available receiver models include:

- PPA R38
- PPA R37
- PPA R37-8

Contact our TechBlue project planning and technical support team for help determining which receiver is best for your use case. For more information on our receivers in general, visit williamsav.com for product specifications, manuals and more.

Troubleshooting

Website GUI problems

The full website GUI is unavailable.

- If you are only able to install a firmware update, the website stored on the FM+ C has been corrupted, likely by a power outage. Install the firmware for your current version (or newer) of the FM+ C via the firmware update page to restore the website.
- If sections/text or graphics are missing in the WebGUI, but the firmware update section is accessible, try reinstalling the latest firmware. (This can be found on the "Downloads section of the product page on the WAV website). If this doesn't restore the entire WebGUI, the unit may need to come back to WilliamsAV for service.
- Check your network settings. The IP address is viewable on the front panel of the device.

Lost username or password

- Using the front panel menu, restore defaults. See "Restore Defaults" on page 15.

Website not behaving as expected

- The website will only work with a modern browser. For example, do not use Internet Explorer™ 11 or earlier.
- Try switching browsers. Google Chrome™ is our recommended browser.

Audio problems

The On Air Indicator is not on

Note: The front panel display indicates RF status, and the RF Settings section of the web page shows the RF on/off and RF power level status. If either of these are indicating that the RF power status is off, then:

- Ensure the transformer (TFP 062) is plugged into the transmitter and any remote power switch is on.
- Ensure the front power button is pressed and latched to the on position and the power LED is lit.
- Ensure the RF output is not set to off in the RF settings section of the Main Settings web page. See "FM Output Power" on page 13.
- Ensure there is audio present. The RF may time-out and shut off if audio is not present for a period of time.

No Audio heard through earphone jack

- Check that the VU meter is lit to see if there is a signal coming from your audio source. Check and correct your audio source, if necessary.
- Check to see if the Headphone Volume Level hasn't been turned all the way down. If so, increase it.
- Check to see if there is an incorrect or defective connection from your audio source.
- Check and correct your audio gain level, if necessary.

Noise or Distortion in the Audio

- Check to see if there is noise in the audio source. To find out, disconnect the audio cable. If the noise disappears your noise problem is in the source. Correct or repair your audio source.
- Ensure the Audio Source configuration is set to match the audio source input device. See "Audio Source Connections" on page 7 for how to properly configure the Audio Source.
- Check for ground loops or noise on the input signal. If you are still having trouble, call your Authorized Williams AV dealer or representative.

Noise in audio grows when program is silent

- The Audio Gain Control may be set too high. You may be seeing the +6 dB level indicator lighting all the time on the front of the device. See "Audio Source (OLED or Web Page)" on page 12.
- Check the Compression Ratio, which may be inappropriate for the type of program being transmitted. Try setting the Compression Ratio to 1:1 (compression off). See "Dynamic Range Compression" on page 13.

Volume too quiet

- The audio gain control may be set incorrectly on the transmitter. Correct the Audio Gain control setting by adjusting it until the sound level peaks between 0 and 6 dB.
- Check the batteries in the receiver. For non-rechargeable (alkaline) batteries, they may need replaced. If you are using rechargeable batteries, ensure the batteries are fully charged prior to use.
- The audio input may not be configured for the audio source being used. If not, correct the setting of the Audio Source control menu. See "Audio Source Connections" on page 7.
- Some users may not be helped by this system. Severe hearing loss may require using the system with a T-Coil and personal hearing aid rather than headphones.
- If using Wi-Fi, some phones and tablets have the ability to broadcast to a T-coil; research the phone model to see if this is an option.

Wi-Fi reception difficulties**No Reception**

- Ensure the listener's device is connected to the correct WaveCAST network, has the current iOS or Android app installed, and is listening on the same channel as the FM+ C is transmitting on.

Missing Channel Image on App

- Images may not load when many users are connected. Try reloading the list of channels.

FM reception difficulties

NOTE: Be sure to listen to the audio transmission on the FM+ C headphone jack prior to checking the receiver reception.

No Reception

- Ensure the listeners have the receiver on the same channel as the FM+ C is broadcasting on.
- Ensure the FM icon on the front panel is bright or the FM status at the top of the web page shows "On The Air".
- If using an FM Receiver, ensure the Williams AV headphones are properly plugged in. The headphone cord acts as an antenna for the receiver.

Insufficient range, good reception near transmitter, poor at a distance

- Ensure the transmitting antenna was correctly installed (see "Installing the ANT 025 Whip Antenna" on page 6). If not, correct or replace the antenna. If a remote antenna was installed, check the cables and connections. The signal should be clearly audible up to at least a 100-foot distance with the ANT 025.
- Ensure the transmitting antenna is not in an unsuitable location. Perhaps the transmitting antenna was installed inside a metal enclosure or is separated from the reception area by electrically conducting objects. (i.e., steel stud walls, heating ducts, substantial structural steel, or 2x2 or 2x4 ceiling grid.) In either case, reinstall the antenna according to installation instructions, locating it outside metal enclosures and away from electrically conducting objects.
- A strong interfering signal may exist. Ensure the transmitter and antenna are correctly installed. Set the transmitter to FULL power output. If this does not solve the problem, try operating the transmitter on a different channel/frequency.

- Ensure the antenna selected is the best fit for your application. See the **72 MHz Antenna Selection Install Guide** on the Williams AV website for further advice. NOTE: The FCC requires this device to be used with approved, FCC 15.203 compliant antennas and be professionally installed. Refer to Williams AV's Antenna Selection Install Guide for compliant antennas for this product.

Users complain of too much noise during soft audio. Dynamic range of music reduced too greatly.

- The transmitter could be set for High Compression (2:1) when Reduced Compression (1.5:1) or No Compression (1:1) would be more suitable, given the program material. If so, set the Compression Ratio to 1.5:1 or 1:1 and see if this reduces the noise. See "Dynamic Range Compression" on page 13.

Buzz in other equipment when transmitter is on or off

- This is likely caused by incorrect audio connections, a ground loop, or defective equipment. To remedy, use proper audio wiring practice to make connections.

Buzz or other noise in equipment only when transmitter is on

- Make certain the transmitter chassis is connected to the equipment cabinet rails if installed in a rack. Buzz/hum in system may be experienced when the chassis is insufficiently grounded. In this case, install a ground wire to the chassis and terminate to a verified ground source.
- Ensure antenna connections are secure.
- Select medium power output for the Power Output setting.
- Install transmitter at a distance from sensitive equipment.
- Use a remote antenna (ANT 005 or ANT 024).
- Make sensitive equipment more immune to RFI/EMI. The manufacturers of your audio equipment may offer application notes for this purpose. Download **Technical Bulletin: Buzz Or Hum Remedies** from the Williams AV website for suggestions for improving radio frequency (RF) immunity in existing audio equipment.

Specifications

FM T55C / FM T55CD

Dimensions	8.45" W x 8.25" D x 1.72"H (21.5 cm x 21 cm x 4.4 cm)
Weight	Transmitter: 3.2 lbs (1.45 kg)
Color	Black
Rack Mount	Standard 19" Rack, one EIA rack space high, 1/2 space wide 1-2 units can be mounted in a single rack space with optional RPK 005 (single) or RPK 006 (double) Rack Mount Kits
Power Supply	Desktop Style Transformer (TFP 062); Input: 100-240 VAC, 50/60 Hz. IEC Line Cord; Output: 24 VDC, 750 mA, 18W. 2.5mm ID center positive barrel connector
Power ON Indicator	Push On/Push Off latching power button with backlight. Green backlight indicates power ON, backlight off indicates power OFF.
Temperature Range	Operating: +32° F to +122° F (0° C to 50° C); Storage: -4° F to +158° F (-20° C to 70° C)
Ethernet	RJ-45 on back of unit supports CAT 5e cable lengths up to 328 feet (100 meters); 10/100 Base-T IEEE 802.3 compliant, unique MAC address. RJ-45 jack used for web interface and streaming audio out. An external Router/DHCP Server is required to stream audio to receiving devices.
Dante	(1x) RJ-45 jack. Only available on FM T55CD
User Interfaces	1. 3.12" High Resolution OLED display with selections via buttons, 2. Hosted Web page, 3. Telnet commands over ethernet (see our "WaveCAST and FM+ Programmers Guide" for available commands and protocol).
RF Section	
Operating Frequencies	72.1-75.9 MHz, 17 wideband channels (selectable)
Frequency Accuracy	± 2 ppm stability, 0-50° C

Deviation	± 75 kHz maximum		
Pre-Emphasis	75 µsec		
RF Field Strength	Does not exceed 80 mV/m at 3 m		
Compatible Antennas	ANT 005, ANT 021, ANT 024, ANT 025, ANT 028, ANT 029, ANT 034 <i>Refer to Williams AV's 72 MHz Antenna Selection Install Guide for FCC-compliant antennas for this product.</i>		
Transmission Range	Up to 1000 ft (304 m) with ANT 005 coaxial antenna mounted on rear chassis F-connector		
RF Outputs	(1x) #10-32 stud connector in center of unit (pcb mounted) (1x) F-connector on rear chassis		
RF Transmit (RF) Power Indicator	1 OLED On Air Indicator with 4 states indicating power level Off, Low, Medium and Full Power.		
RF Time Out (sleep mode)	30 min. duration, 4 hr. duration, or Always On; selected via web interface. When audio drops below -18 dB, the selected duration begins, and when it expires the unit stops transmitting and goes into a low-power ("sleep") mode. Any button press or resumption of audio above -18 dB "awakens" the unit and it begins transmitting again.		
Audio Section			
Audio Inputs	(1x) Combination 3-pin XLR, 1/4" (TRS) jack for balanced or unbalanced line level, or balanced or unbalanced microphone with selectable phantom power. Optional RJ-45 Dante Input ("D" models only).		
Audio Processor Functions	DSP based; Compression: 1:1, 1.5:1 or 2:1; High-pass and Low-pass Filter Frequency control, Music, Voice and Hearing Assistance Audio Presets		
Frequency Response	31-16000 Hz, ±3 dB (re: 1 kHz) ("Music" Audio Preset)		
Signal-to-Noise Ratio	64 dB (typical) Transmitted RF @ 1kHz		
Total Harmonic Distortion	Less than 0.25% @ 1 kHz (RF output)		
Common Mode Rejection	>57 dB @ 1 kHz, Mic or Line mode		
Audio Input Gain Adjust	Adjustable from +24dB to -60 dB, in 1dB steps from front screen or web interface.		
Phantom Power	14.4 VDC applied through 2.2 kΩ resistors to analog combo jack: Pin 2 and Pin 3 on XLR jack, or tip and ring on 1/4" TRS jack		
Audio Level Display	Front screen bar graph display, each segment representing 3dB. It ranges from -18 (1 segment lit) to +12dB (10 segments lit). Over-range warning is indicated by 'OVL'D' and flashing empty bar.		
Headphone Output	1/4" TRS stereo jack, mono signal, 7.8mW total power with 33 Ω.		
Dante Input	(1x) RJ-45 jack, only available on FM T55CD.		
Input Level (Bal or Unbal) (at Audio Input Gain = 0dB) at 1 kHz	Nominal (@ 7th Segment Lit) Indicated by Audio Level Display	Overload Warning Indicated by Audio Level Display "OVL'D"	Absolute Max. Rating Stresses above these ratings may cause permanent damage or degrade reliability.
Microphone	-45 dBV (5.6 mV RMS)	-20 dBV (100 mV RMS)	+20 dBV (10.0 V RMS)
Line	-8.4 dBV (380 mV RMS)	+16 dBV (6.5V RMS)	+20 dBV (10.0 V RMS)
Approvals	FCC, RoHS3, WEEE, Industry Canada		
Warranty	2-year parts and labor		

NOTE: SPECIFICATIONS SUBJECT TO CHANGE WITHOUT NOTICE

** Stresses above these ratings may cause permanent damage. Exposure for extended periods may degrade reliability. This device complies with Industry Canada licence-exempt RSS standard(s) and FCC part 15.105[b] for the United States. Operation is subject to the following two conditions: [1] this device may not cause interference, and [2] this device must accept any interference, including interference that may cause undesired operation of the device.

Remote Telnet Control

A separate Telnet Control Guide is available for download. It is located on the WilliamsAV website, on the product model page, under the Download Tab.

Regulatory Statements

FCC

FCC ID: CNMFMT55C

FCC Compliance Statement

This equipment has been tested and found to comply with the limits for a Class B digital device, pursuant to Part 15 of the FCC Rules.

These limits are designed to provide reasonable protection against harmful interference in a residential installation.

This equipment generates, uses and can radiate radio frequency energy and, if not installed and used in accordance with the instructions, may cause harmful interference to radio communications. However, there is no guarantee that interference will not occur in a particular installation. If this equipment does cause harmful interference to radio or television reception, which can be determined by turning the equipment off and on, the user is encouraged to try to correct the interference by one of the following measures:

- Reorient or relocate the receiving antenna.
- Increase the separation between the equipment and receiver.
- Connect the equipment into an outlet on a circuit different from that to which the receiver is connected.
- Consult the dealer or an experienced radio/TV technician for help.

This device complies with Part 15 of the FCC Rules. Operation is subject to the following two conditions:

1. This device may not cause harmful interference, and
2. This device must accept any interference received, including interference that may cause undesired operation.

Caution: Any changes or modifications to the equipment not expressly approved by the party responsible for compliance could void your authority to operate the equipment.

Note: The FCC requires this device to be used with approved, FCC 15.203 Compliant antennas and be professionally installed. Refer to Williams AV's 72 MHz Antenna Selection Install Guide for compliant antennas for this product.

ISED

IC ID: 1360A-FMT55C

Innovation, Science and Economic Development Canada Statement

Per RSS-Gen, Section 8.4 This device complies with Innovation, Science and Economic Development Canada license-exempt RSS standard(s). Operation is subject to the following two conditions:

- (1) this device may not cause interference, and
- (2) this device must accept any interference, including interference that may cause undesired operation of the device.

This radio transmitter 1360A-FMT55C has been approved by Innovation, Science and Economic Development Canada to operate with the antenna types listed below, with the maximum permissible gain indicated. Antenna types not included in this list that have a gain greater than the maximum gain indicated for any type listed are strictly prohibited for use with this device.

Par RSS - Gen, Section 8.4 Cet appareil est conforme à Innovation, Sciences et Développement économique Canada exempts de licence standards RSS. Le fonctionnement est soumis aux deux conditions suivantes :

- (1) ce dispositif ne peut pas provoquer d'interférences et
- (2) cet appareil doit accepter toute interférence , y compris les interférences qui peuvent causer un mauvais fonctionnement de l'appareil.

Le présent émetteur radio 1360A-FMT55C a été approuvé par Innovation, Sciences et Développement économique Canada pour fonctionner avec les types d'antenne énumérés ci-dessous et ayant un gain admissible maximal et l'impédance requise pour chaque type d'antenne. Les types d'antenne non inclus dans cette liste, ou dont le gain est supérieur au gain maximal indiqué, sont strictement interdits pour l'exploitation de l'émetteur.

TYPE	MANUFACTURER / FABRICANT	MODEL / MODÈLE	IMPEDANCE / IMPÉDANCE	GAIN
Folded dipole	Williams AV	ANT 005	75 Ω	2.4 dBi
Collapsible whip monopole	Williams AV	ANT 025	75 Ω	2.4 dBi
Rubber duck monopole	Williams AV	ANT 021 / ANT 029	75 Ω	-3 dBi
Electrically short dipole	Williams AV	ANT 024	75 Ω	0 dBi

2-Year Warranty

Williams AV products are engineered, designed, and manufactured under carefully controlled conditions to provide you with many years of reliable service.

Williams AV warrants the FM+ C transmitters against defects in materials and workmanship under normal use and conditions for the 2-years from the product from date of purchase.

This warranty is available to the original end purchaser of the product and CAN BE transferred to subsequent purchasers of the product.

Microphones, earphones, headphones, batteries, chargers, cables, carry cases, and most other accessory products carry a 90-day warranty.

Williams AV has no control over the conditions under which this product is used. Williams AV, therefore, disclaims all warranties not set forth above, both express and implied, with respect to the FM+ C, including but not limited to, any implied warranty of merchantability or fitness of use of such equipment including, without limitation, any warranty that the use of such equipment for any purpose will comply with applicable laws and regulations. Williams AV shall not be liable to any person or entity for any medical expenses or any direct, incidental or consequential damages caused by any use, defect, failure or malfunctioning of the product, whether a claim for such damages is based upon warranty, contract, tort or otherwise, the sole remedy for any defect, failure or malfunction of the products is replacement of the product. No person has any authority to bind Williams AV to any representation or warranty with respect to the FM+ C System. Unauthorized repairs or modifications will void the warranty. This warranty is void if damage occurred because of misuse, or if the product has been repaired or modified by anyone other than a factory authorized service technician. Warranty does not cover normal wear and tear on the product or any other physical damage unless the damage was the result of a manufacturing defect. Williams AV is not liable for consequential damages due to any failure of equipment to perform as intended. Williams AV shall bear no responsibility or obligation with respect to the manner of use of any equipment sold by it.

This warranty does not cover reimbursement for your costs of removing and transporting the product for warranty service evaluation or installation of any replacement product provided under this warranty.

The exclusions and limitations set out above are not intended to, and should not be construed so as to contravene mandatory provisions of applicable law. If any part or term of this Disclaimer of Warranty is held to be illegal, unenforceable, or in conflict with applicable law by a court of competent jurisdiction, the validity of the remaining portions of this Disclaimer of Warranty shall not be affected, and all rights and obligations shall be construed and enforced as if this warranty did not contain the particular part or term held to be invalid. The terms of the warranty are governed by the laws of the State of Minnesota.

Prices and the specifications of the products are subject to change without notice.

For Complete Warranty Statement go to: <https://williamsav.com/support/warranty-product-registration/>

NOTICE: Williams AV products are NOT designed for use in extreme temperature, humidity or chemical environments. The introduction of chemicals such as chlorine, salt water or human sweat into the product will cause damage to the circuitry. Damage due to these causes is NOT covered under the Product Warranty.

If you experience difficulty with your system, call toll-free for customer assistance: **1-800-843-3544 (U.S.A.) or +1 952 943 2252** (outside the U.S.A.)

If it is necessary to return the system for service, your Customer Service Representative will give you a Return Authorization Number (RA) and shipping instructions.

Pack the system carefully and send it to:

Williams AV

Attn: Repair Dept.

10300 Valley View Road

Eden Prairie, MN 55344 USA

Your warranty becomes effective the date you purchase your system. If your sales receipt is not available, the date code on the product will determine your warranty status.

This page intentionally left blank