

WOLFVISION[®]

EYE SERIES MOUNTING KIT INSTALLATION GUIDE

Ceiling Tile Installations – Part 1

Sheetrock Installations – Part 2

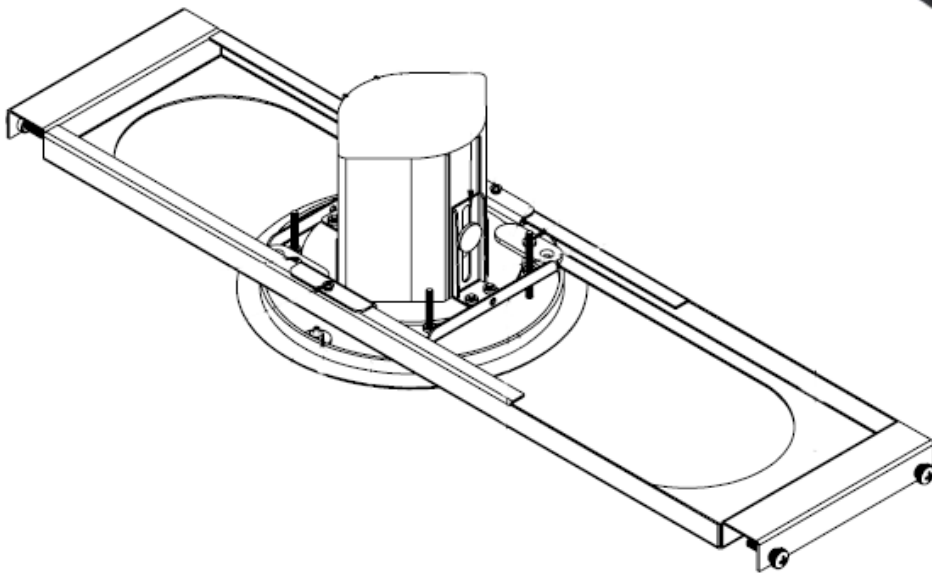

Touchboards

205 Westwood Ave, Long Branch, NJ 07740
Phone: 866-94 BOARDS (26273) / (732)-222-1511
Fax: (732)-222-7088 | E-mail: sales@touchboards.com

Ceiling Tile

EYE Series Mounting Kit Part 1: Tile Bridge Installation

The Ceiling Tile Bridge is designed to support the WolfVision EYE-10 and EYE-12 models only. T-Grid ceilings are not designed to support weight loads – support wires must be attached to the structural ceiling above. It is the responsibility of the installer to ensure this product is properly supported and meets all local building codes and plenum requirements. Make sure the ceiling structure is capable of holding at least 12 lbs. (4x the combined weight of the mount and camera).

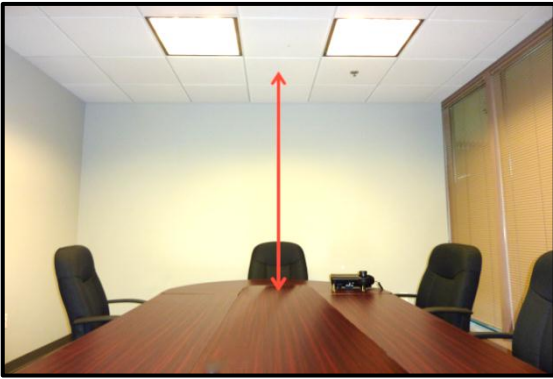

Steps:

I Inspect Installation Location

- 1) Determine mounting location within T-grid ceiling based upon the center of the desired focal point on the working surface.

Note: An adjacent tile will also have to be removable for access.

- 2) Verify structural support (T-grid wire above the ceiling tile). Check overhead clearance. A minimum of $8\frac{1}{2}$ " above Ceiling tile is required. After you have verified all clearances, replace the ceiling tile.

Note: Center of installation must be at least $3\frac{11}{16}$ " from both ceiling grid structures to allow for hole clearance.

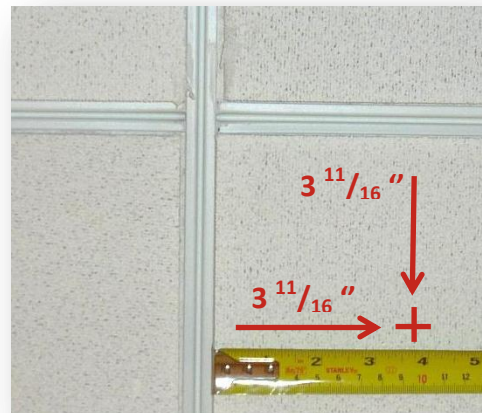
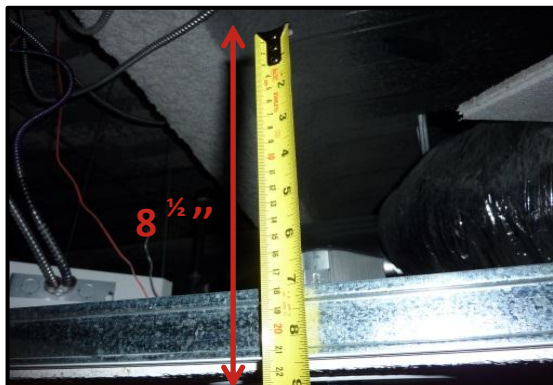

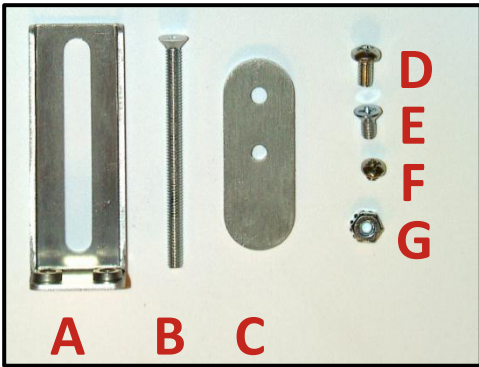

II Assemble Unit

3)

- A** Camera Bracket
- B** Trim Mounting Screw
- C** Mounting Tab
- D** Mounting Screw
- E** Mounting Screw
- F** Rail Clamp Screw
- G** Alignment Ring Nut

4) Using Mounting Screw (**E**), attach Camera Bracket (**A**) to circular plate.

Note: For installations using optional lenses, longer brackets are available for purchase.

5) Slide circular plate into mounting assembly.

6) Secure circular plate into mounting assembly using Mounting Tabs (**C**) and Mounting Screws (**D**).

Note: Use the center hole of the Mounting Tab (**C**). (Countersunk screw hole is not needed in this step). Only 2 Tabs are required. You must use the screw holes closest to rail clamps (see photo).

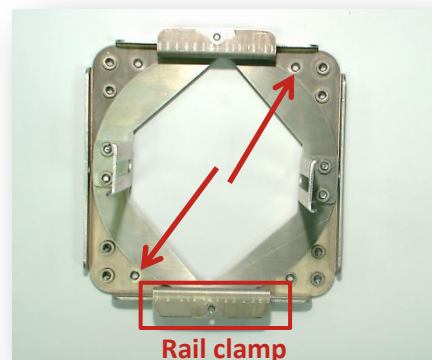
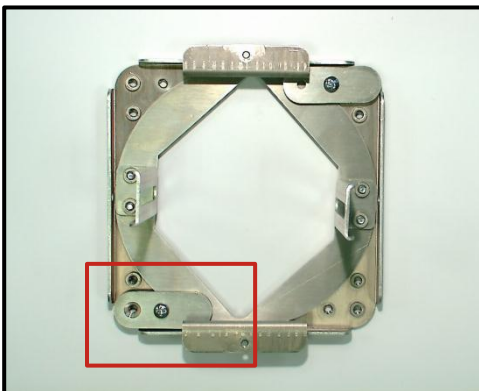
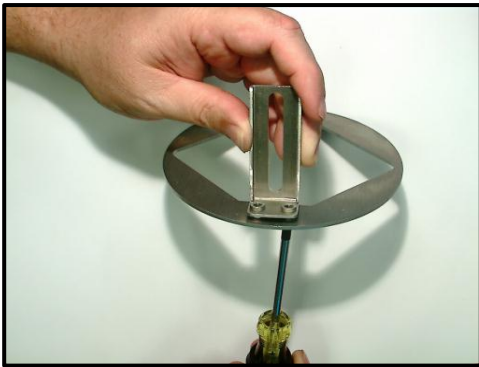

Ceiling Tile

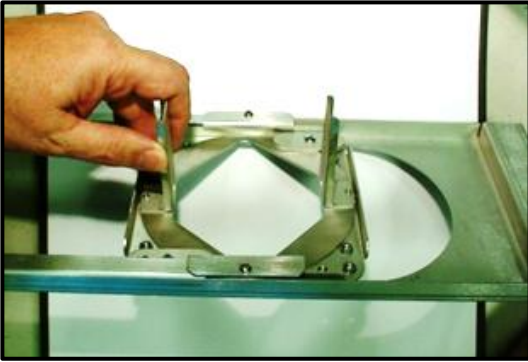

7) Slide assembly into the frame.

Note: After assembly is in place, insert the two Rail Clamp Screws (F).



8) Loosen frame screws.



9) Install camera into the assembly – tighten $\frac{1}{4}$ - 20 knurled screws (supplied with camera).

Note: It is recommended that the lens cap be left on for the entire installation process.

III Mounting Instructions



- 10) Using the center focal point on the table, run a plum-line to the ceiling tile and mark the center point where the camera will mount.

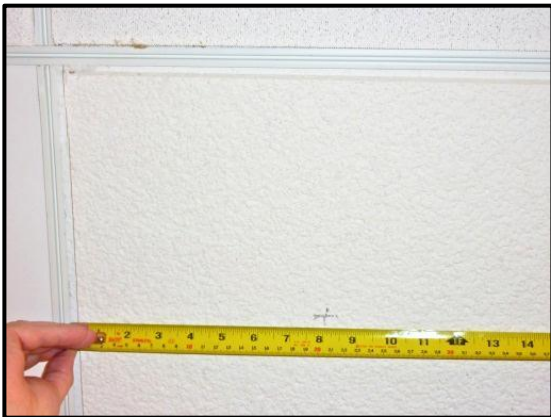
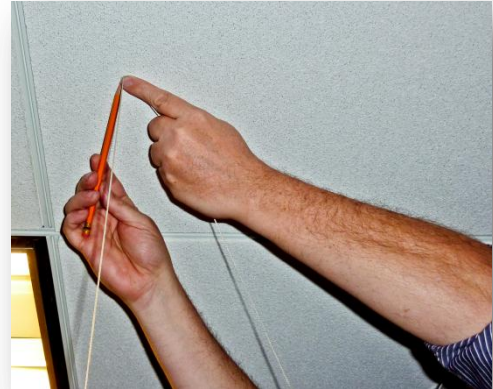

- 11) At this point you are ready to cut the hole. Be sure you have checked the clearances side to side and above the tile. (As stipulated in step 2)

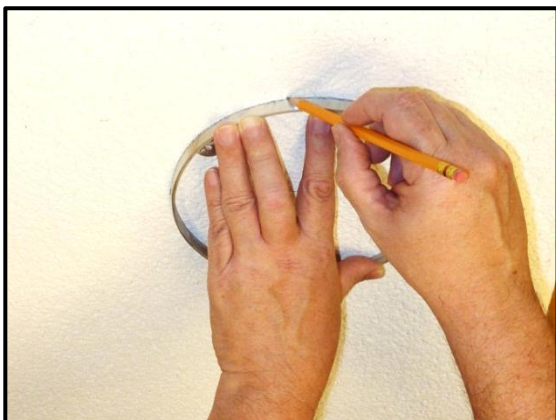

- 12) Cut a $7\frac{3}{8}$ " diameter hole. The alignment ring may be used as a template.



Ceiling Tile



- 13) Install assembly above ceiling tile. Verify the hole alignment.



- 14) Secure assembly by tightening the Frame Screws onto the grid and tightening the Rail Clamp Screws (F).

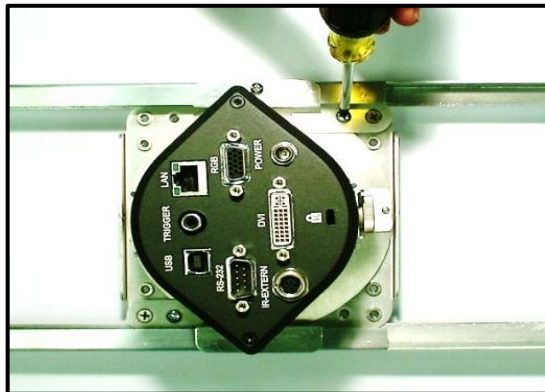
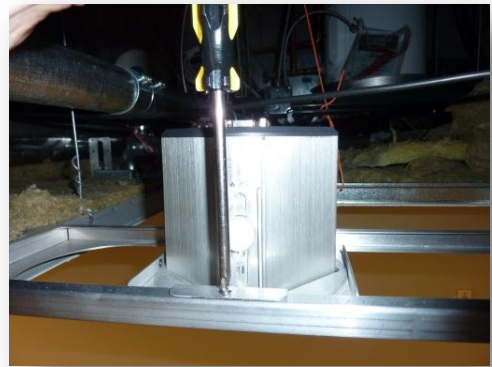

- Note: If you need to change the orientation of the image to match the architectural specifications of the room, loosen the Mounting Tabs (C) and rotate the camera assembly as needed. Secure Tabs.

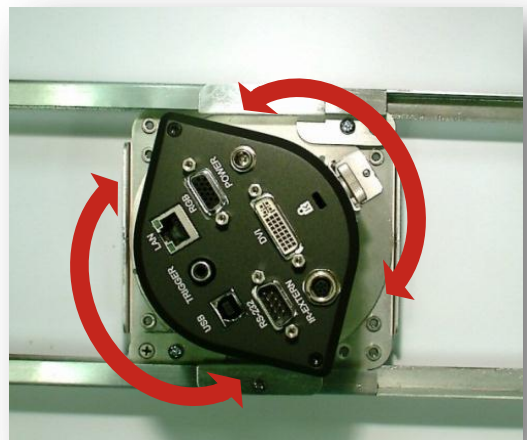

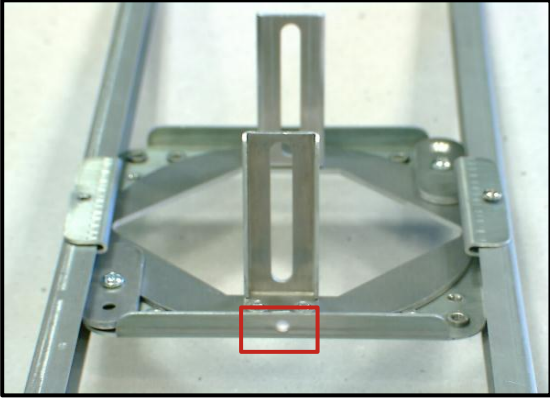

- 15) Using this anchor point, attach safety cable to building structure.
(Safety cable not included)

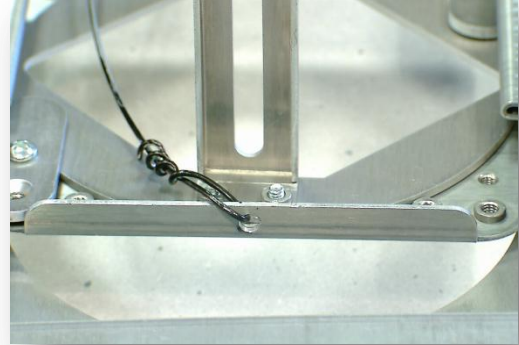

- 16) Loosen knurled screws and lower camera until flush with bottom of ceiling tile. A straight edge may be used to verify.

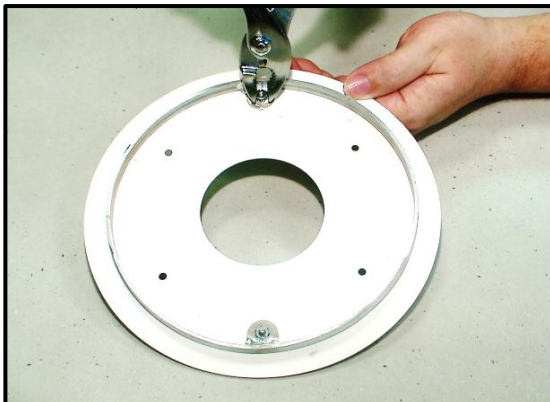

- 17) Attach alignment ring to face-plate with Nuts (G) provided.

Ceiling Tile

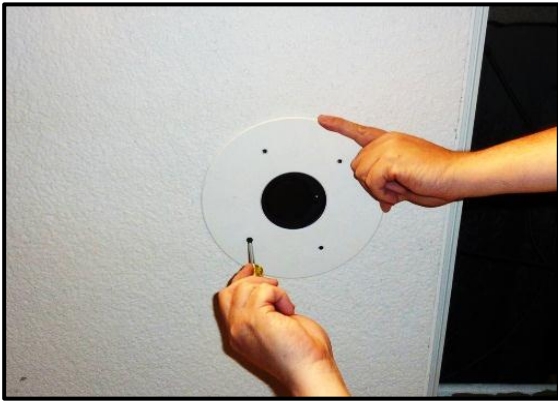

- 18) Install face-plate ring using Trim Mounting Screws (B).

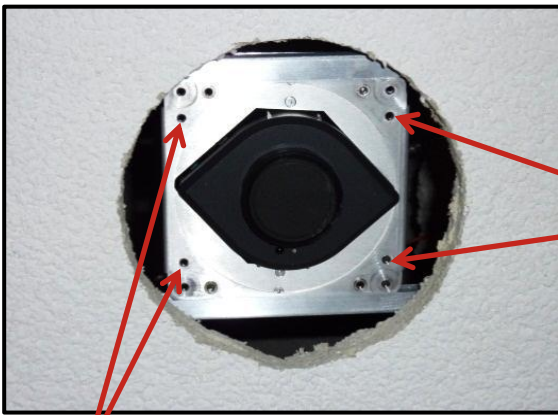

Note: Screws must go into holes designated by these arrows.

Trim Mounting Screws

Trim Mounting Screws

Final Product



EYE Series Mounting Kit

Part 2: Sheetrock Installation Guide

This lightweight mounting bracket is designed to support the WolfVision EYE-10 and EYE-12 models above sheetrock ceilings. A safety cable anchor point is provided to secure the unit to the building structure. It is the responsibility of the installer to ensure this product is properly supported and meets all local building codes and plenum requirements. Make sure the ceiling structure is capable of holding at least 12 lbs. (4x the combined weight of the mount and camera).

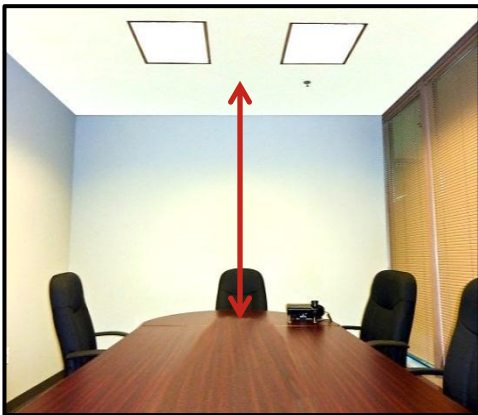

Steps:

I Inspect Installation Location

- 1) Determine mounting location ceiling based upon the center of the desired focal point on the working surface.

A minimum of 8 $\frac{1}{2}$ " clearance above ceiling is required.

Center of installation must be at least 3 $\frac{11}{16}$ " from structural members in ceiling to allow for hole clearance.

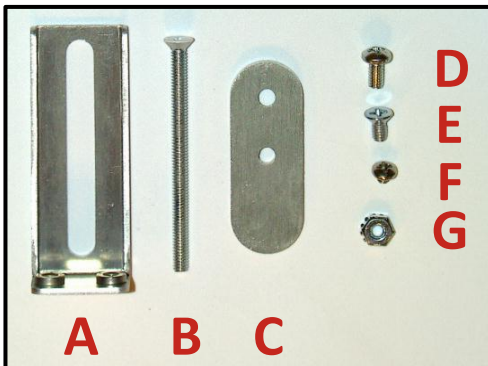

II Assemble Unit

- 2)
 - A** Camera Bracket
 - B** Trim Mounting Screw
 - C** Mounting Tab
 - D** Mounting Screw
 - E** Mounting Screw
 - F** (Not used with sheetrock installation)
 - G** Alignment Ring Nut
- 3) Using Mounting Screw (**E**), attach Camera Bracket (**A**) to circular plate.

Note: For installations using optional lenses, longer brackets are available for purchase.

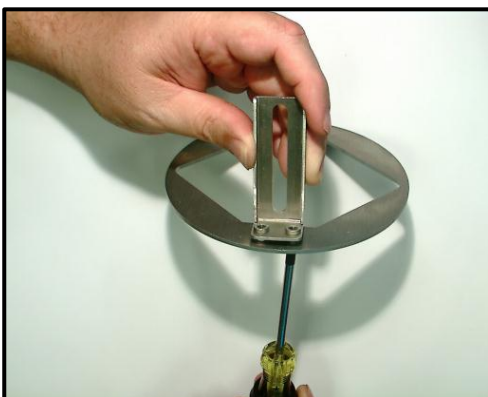

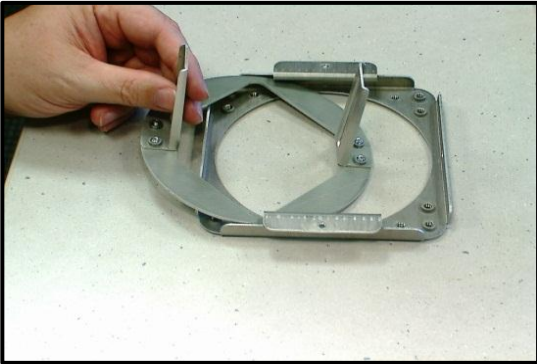

- 4) Slide circular plate into mounting assembly.

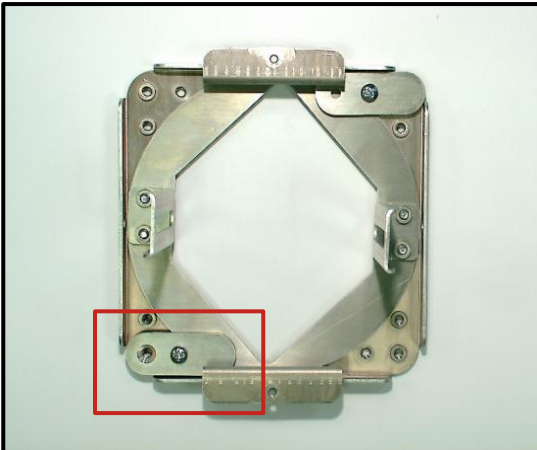

- 5) Secure circular plate into mounting assembly using Mounting Tabs (C) and Mounting Screws (D).

Note: Use the center hole of the Mounting Tab (C). (Countersunk screw hole is not needed in this step). Only 2 Tabs are required. You must use the screw holes closest to rail clamps (see photo).

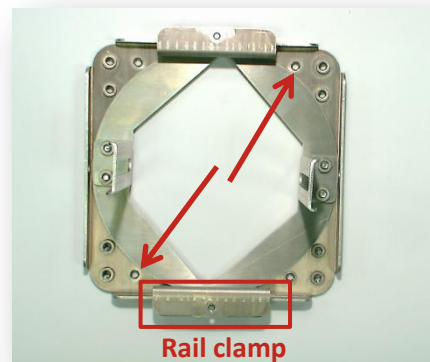

- 6) Attach the four Mounting Tabs (C) with Mounting Screws (E). Do not tighten screws.

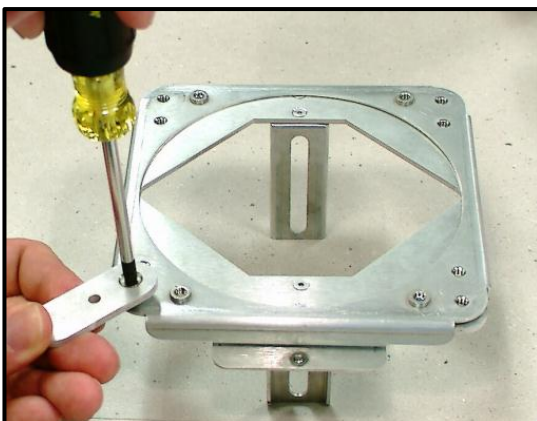

Sheetrock

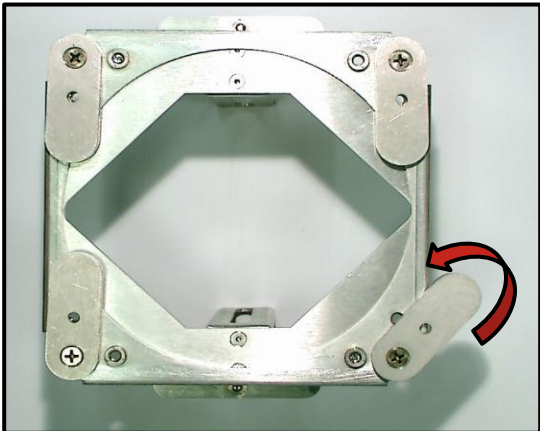

7) Rotate Tabs inward until inside the edge of the assembly.

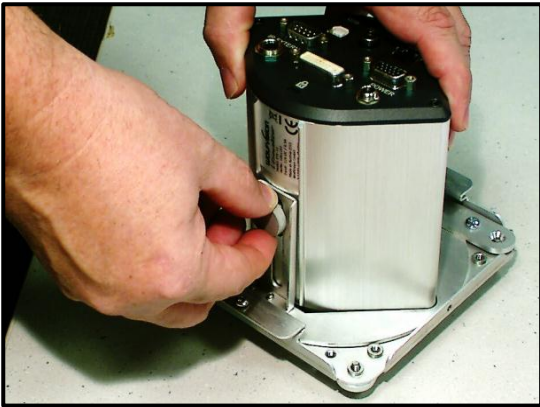

8) Install camera into the assembly using ¼ - 20 knurled screws (supplied with camera).

Note: It is recommended that the lens cap be left on for the entire installation process.

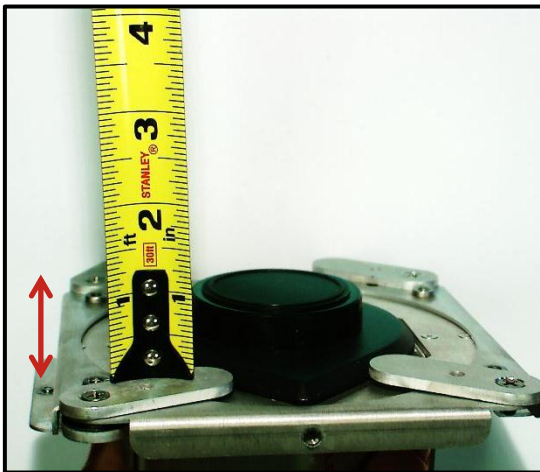

9) Adjust the camera until the distance from the front of the Mounting Tab to the end of the camera matches the ceiling thickness. Then secure camera with knurled screws.



II Mounting Instructions

- 10) Using the center focal point on the table, run a plum-line to the ceiling tile and mark the center point where the camera will mount.

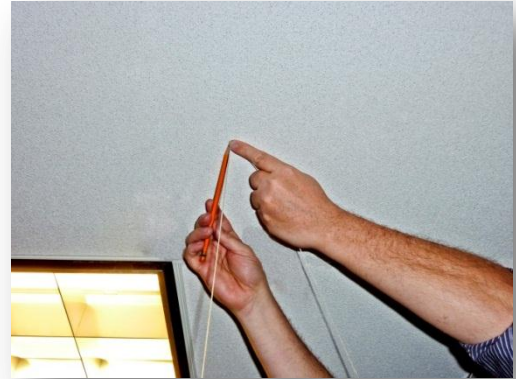

- 11) Be sure you have checked the clearances side to side and above the ceiling. Cut a $7\frac{3}{8}$ " diameter hole. The alignment ring may be used as a template.

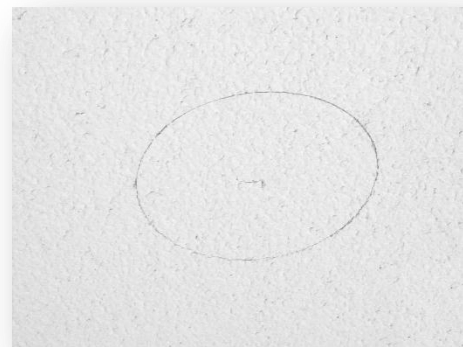

- 12) Any cables needed for camera must be pre-installed.

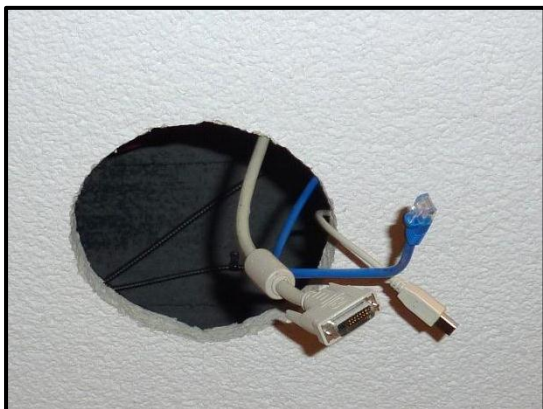
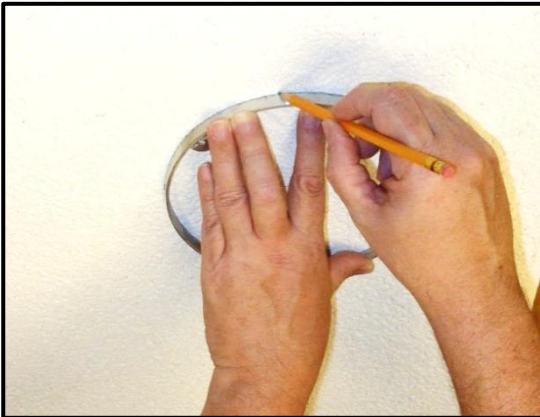

Sheetrock



- 13) Connect all necessary cables to the camera at this time.



- 14) Using this anchor point, attach safety cable to building structure.



- 15) Carefully insert assembly with all cables attached into the hole.

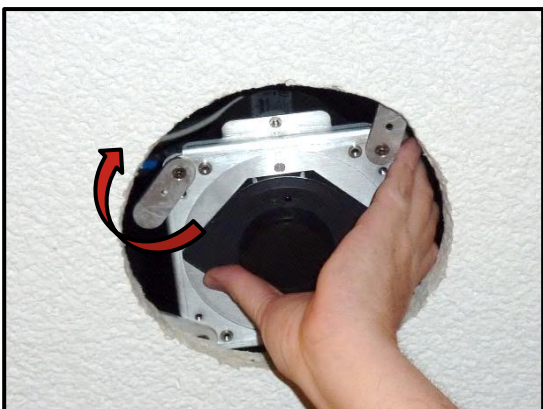

- 16) Rotate Mounting Tabs outward so they support the weight of the assembly above the ceiling.

Sheetrock

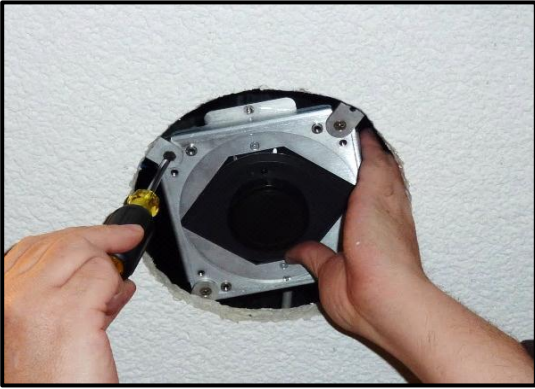

- 17) Tighten Screws on Mounting Tabs.

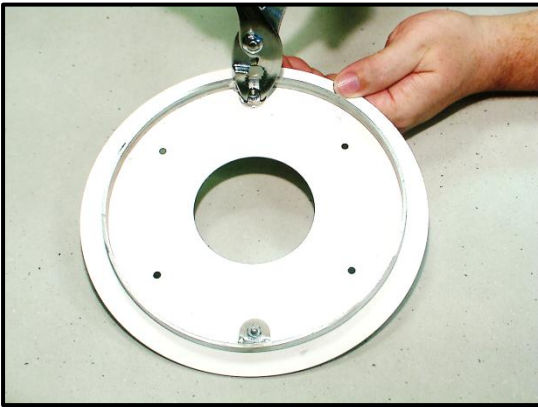

- 18) Attach alignment ring to face-plate with Nuts (**G**) provided.

This ring centers and stabilizes the assembly once the face-plate is installed.

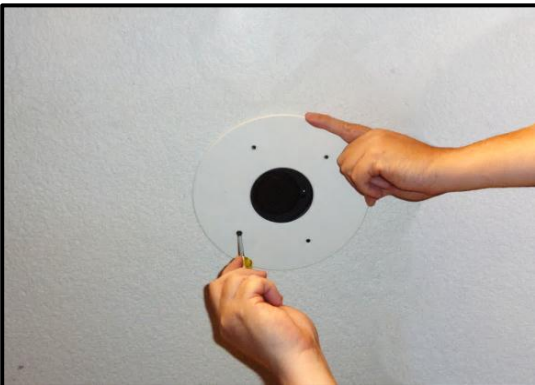

- 19) Install face-plate using Trim Mounting Screws (**B**).

Sheetrock

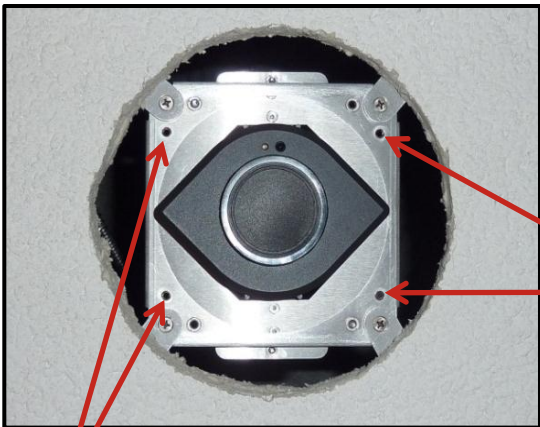

Note: Screws must go into the holes designated by these arrows.

Trim Mounting Screws

Trim Mounting Screws

Final Product



WOLFVISION[®]

Touchboards

205 Westwood Ave, Long Branch, NJ 07740
Phone: 866-94 BOARDS (26273) / (732)-222-1511
Fax: (732)-222-7088 | E-mail: sales@touchboards.com