

YSI incorporated

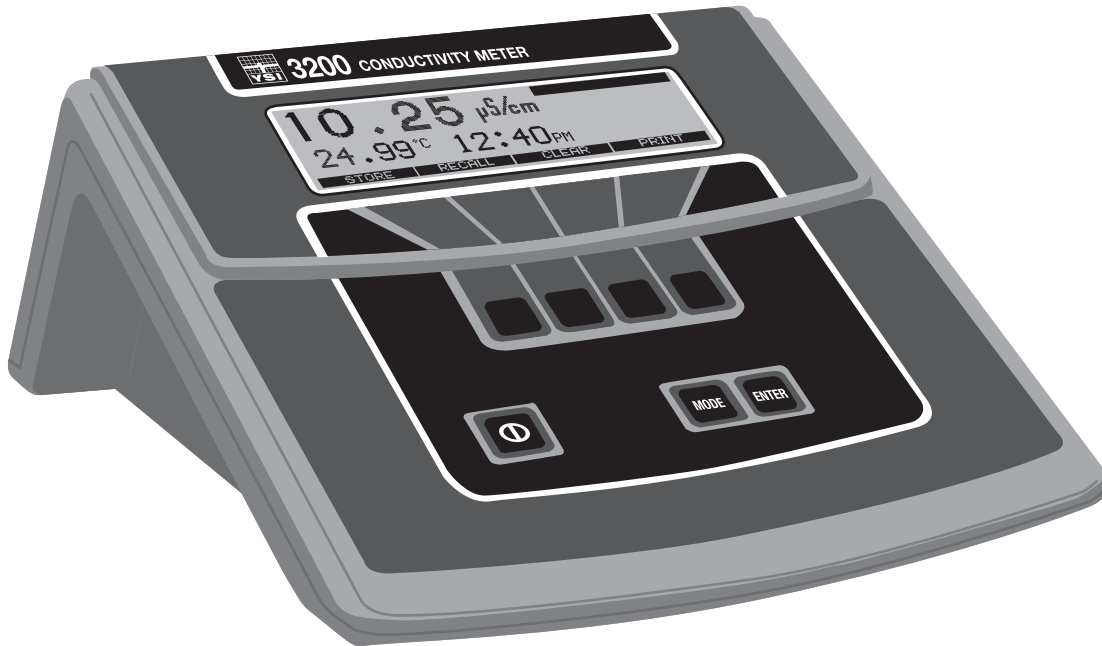

YSI Model 3200
Conductance,
Resistance,
Salinity,
Total Dissolved Solids and
Temperature Instrument

Operations Manual

CONTENTS

1. Introduction	1
1.1 Capabilities	1
1.2 User Features	2
1.3 Controls.....	3
Front Panel	3
Rear Panel.....	5
2. Getting Started	7
2.1 Unpacking.....	7
2.2 Warranty Card.....	7
2.3 What You Need	7
2.4 Setting Up	7
3. System Configuration and Operation.....	11
3.1 Menu	11
3.2 Cell Calibration.....	12
Configure.....	12
Cal K	14
3.3 Temperature Compensation	16
Temp.....	17
3.4 Platinization	19
3.5 Display Configuration.....	19
Measurement Units.....	20
Contrast	21
Time/Date.....	21
Alarms	21
Beeper.....	22
Ranging	23
3.6 Making Measurements.....	25
4. Data Storage and Retrieval.....	27
4.1 Store	27
4.2 Review	28
Recall.....	29
Send All.....	29
Clear	29
Clear All	30
4.3 Send	31
Send Setup.....	31
Data Logging.....	33
5. Diagnostics	35
5.1 Send	35
5.2 Beep	35
6. Maintenance.....	37
6.1 Cell Cleaning and Storage	37
6.2 Platinization	37

7. Troubleshooting	39
Error Messages.....	39
8. Principles of Operation	41
8.1 Ratiometric Conductivity.....	41
8.2 Conductivity Principles.....	41
Introduction	41
Conductivity Fundamentals.....	41
Cell Constant	42
Choosing a Conductivity Cell	43
Cell Constant Calculation.....	45
Conductivity Cell Calibration - Some Things To Remember	45
Conductivity Law.....	46
Low Conductivity Measurements.....	46
General Conductivity Measurement Precautions	47
Platinization.....	47
Temperature Correction.....	47
Small Sample Measurements.....	49
Conductivity System Accuracy Considerations	49
8.3 Salinity.....	50
8.4 Total Dissolved Solids	50
8.5 Temperature	50
8.6 Sources of Errors	50
Cell Contamination.....	50
Cell Platinizing.....	50
Electrical-Noise Errors	51
Contact Resistance	51
Cable Series Resistance and Shunt Capacitance	51
Galvanic and Miscellaneous Effects	51
9. Warranty & Repair	53
Cleaning Instructions	56
Packing Instructions.....	57
9.1 Software Upgrade Procedure	58
9.2 Disassembly/Assembly Procedures	59
9.3 Test and Verification Procedure	60
10. Accessories and Replacement Parts	63
10.1 YSI Conductivity Cells.....	64
10.2 Standard Calibrator Solutions	65
Appendix A - Specifications	67
Appendix B - Required Notice	69
Appendix C - RS232 Connections	71
Appendix D - Temperature Correction Data for Typical Solutions	73
Appendix E - Conversion Factors	77
Appendix F - Glossary of Terms	79

SECTION 1 INTRODUCTION

The Model 3200 is a microprocessor based; menu-driven instrument designed to perform laboratory measurement of conductivity, resistivity, salinity, total dissolved solids and temperature. The instrument's menu system makes it simple to use.

The new YSI 3200 series conductivity cells contain internal temperature sensors for temperature measurement and automatic temperature compensation. The Model 3200 is compatible with YSI 3400 series conductivity cells when used with the YSI Model 3232 cell adapter.

Internal memory for storing up to 100 sets of data and an RS232 port allow you to upload data from the Model 3200 directly to your computer or serial printer.

1.1 CAPABILITIES

- Adjustable cell constant
0.005 to 100
- Readout units selectable
uS/cm, uS, ppt, ohm-cm, ohm, TDS
- Auto or manual ranges
- Adjustable reference temperature
0 to 100°C
- Adjustable automatic temperature compensation factor
0-10%/°C linear, prestored non-linear curves
- Six cell setup memory, with solution memories
Remembers cell constant, compensation method, multi-point cals and linear or non-linear solution curves
- 100 data point memory
Stores date, time, temperature and conductivity
- Field software updates
Via RS232 port
- RS232 serial port
Output suitable for import to any spreadsheet
- Serial printer output
- AC line power
- 7-pin mini-DIN probe connector
- Separate connection for standard YSI temperature probes

1.2 USER FEATURES

- Audio feedback
- Soft key/menu system
- Real time clock

- Auto linear temperature compensation calibration

Two temperature points are tested in a known solution to automatically determine the solution's compensation slope. Alternatively, the user may input a temperature compensation factor directly (0 - 10%/°C).

- Auto non-linear temperature compensation calibration

This is a technique where a known solution is used to calibrate over a wide range of temperature. The solution is ramped through a temperature range while the instrument automatically and continuously generates calibration data. The calibration would be done once and the results stored in non-volatile memory for recall any time that solution is tested. Data for six solutions can be stored at any one time.

The user may also select from 2 pre-programmed non-linear temperature compensation curves.

- Single or multi-point cell calibration

The cell constant can be calibrated at several points and stored in permanent memory. During a reading, the closest calibration point is used as the cell constant.

- High/low alarm

1.3 CONTROLS

FRONT PANEL

The front panel of the instrument contains the display and keypad as shown below.

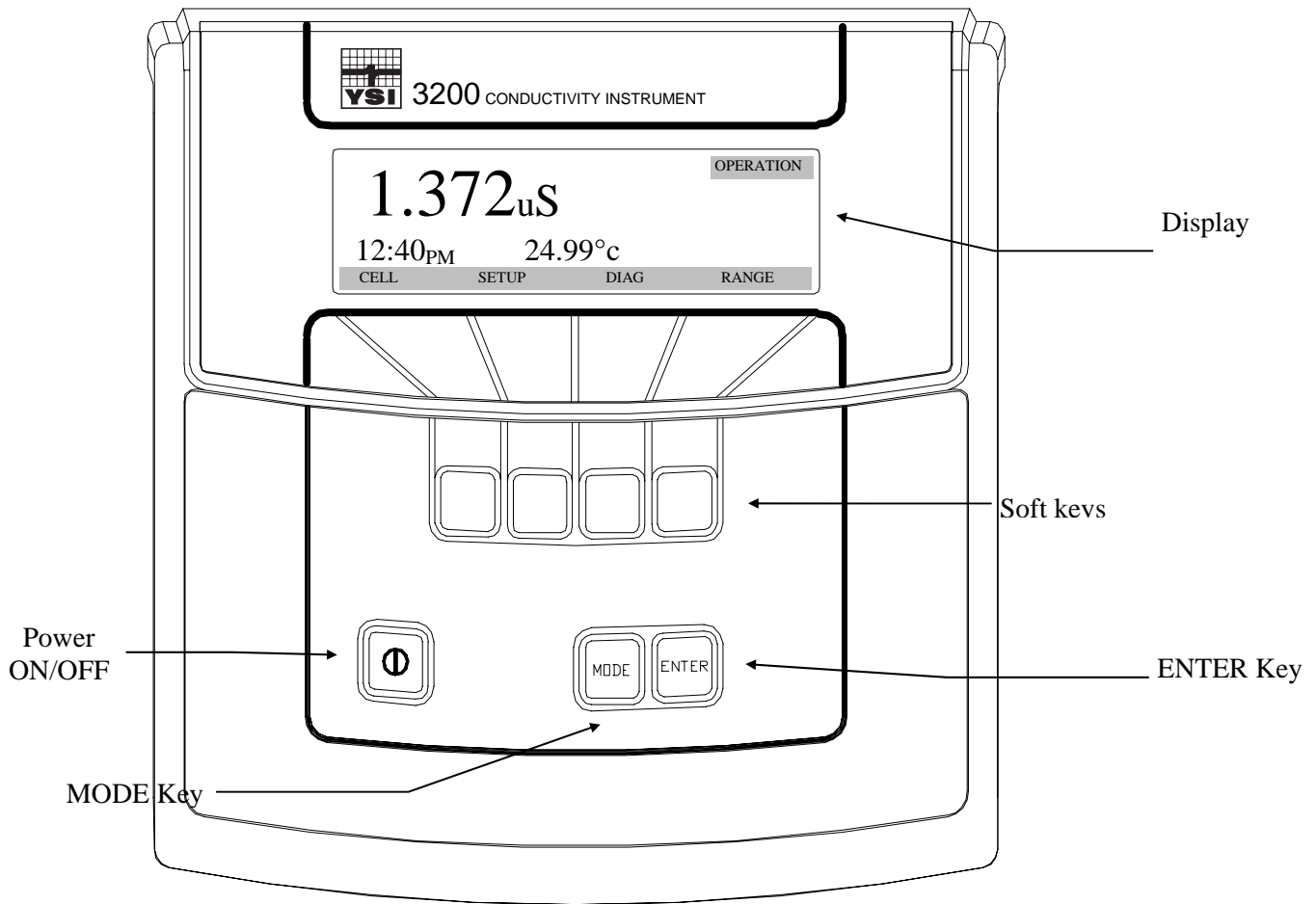

The 3200 has two main operating modes, Data and Operation. The current mode is displayed in the dark bar at the top right corner of the display. The following diagram shows the typical display while the instrument is in the Operation mode.

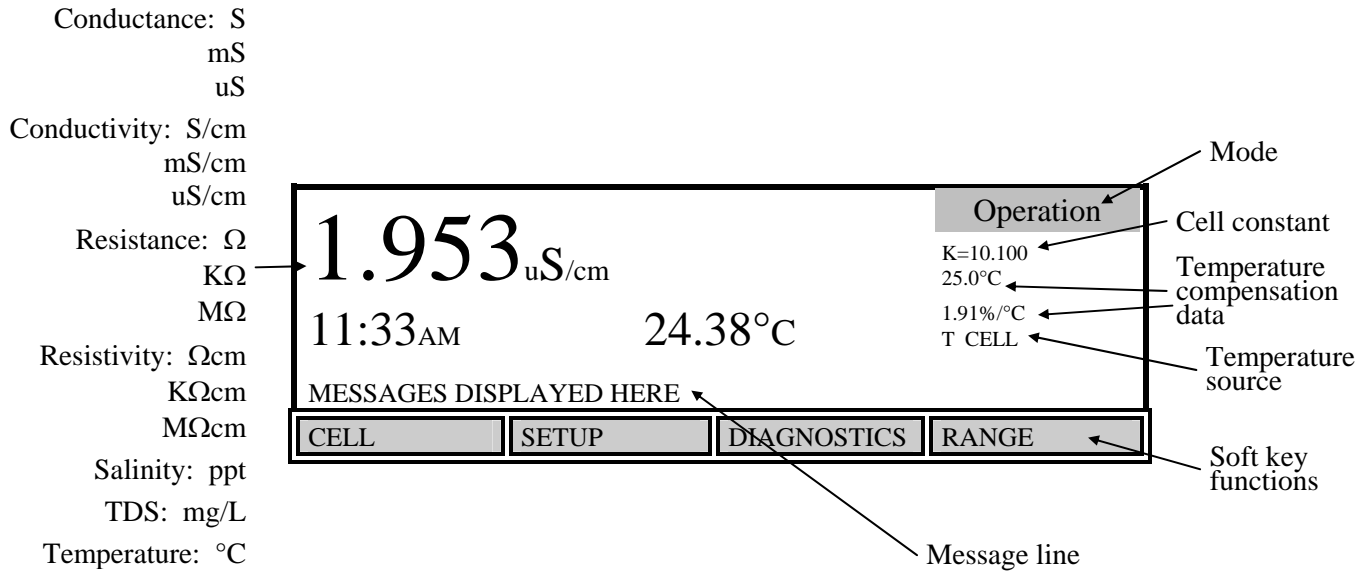

The bottom row of the display identifies the function of the four soft keys, which are located on the keypad below the display. The function of each of these keys changes with each mode.

The [Mode] key and soft keys are used to navigate through the menus. The [Mode] key is used to cycle between the two main operating modes. Pressing a soft key will bring up a new set of soft key functions (menu). The [Mode] key is also used to backup through the menus to the top level.

The right side of the display shows the cell constant, temperature compensation data and current temperature source.

K= 10.100 indicates that a single fixed cell constant of 10.100 is being used. K= would change to Km= when using multipoint calibration.

25.0 $^{\circ}$ C indicates that readings are temperature corrected to 25 $^{\circ}$ C using a coefficient of 1.91%/ $^{\circ}$ C, as indicated just below on the screen. When non-linear temperature compensation is used, N.L. is displayed here. When a standard non-linear curve is selected, the name of the curve (Pure, Natural) is displayed here. When no temperature compensation is being used, these two lines of the 3200 display are blank.

T CELL indicates that the temperature source is a conductivity cell with an internal temperature sensor (YSI 3200 series). T PROBE is displayed when the temperature source is an external temperature probe.

REAR PANEL

The rear panel contains the connections for the power supply, cell, external temperature probe and RS232 serial port. It also has a mounting post for the 3232 adapter as shown below.

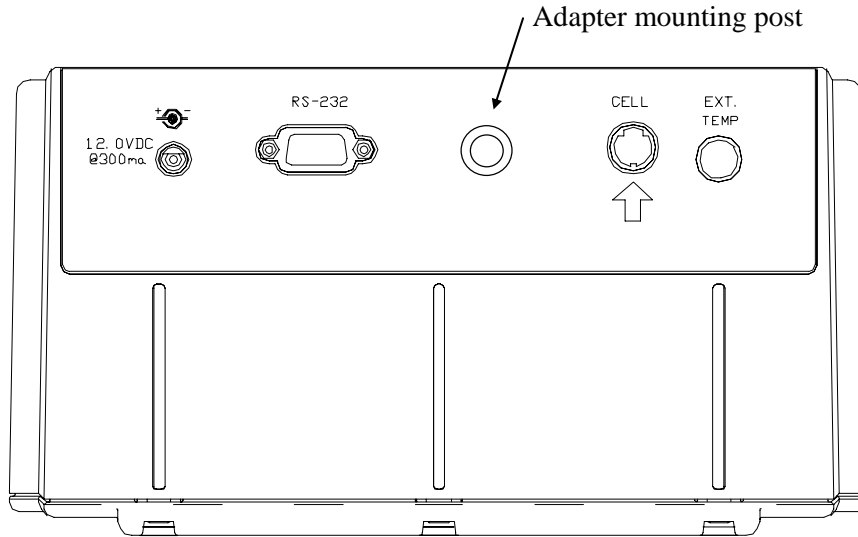

POWER SUPPLY CONNECTION

The power supply connection requires a 12 VDC power supply (included) with at least 300 ma current. The polarity is marked on the instrument.

CELL CONNECTION

The connector for the cell is a 7-pin mini DIN connector and is marked with an arrow to show proper alignment. Be sure to align the arrows when plugging in the cell.

YSI 3200 series cells utilize a mini DIN connector that plugs directly into the 3200. If, however, you have a YSI 3400 series cell, the YSI 3232 cell adapter and a YSI 3220 or YSI 700 series temperature probe will be required. The YSI 3232 cell adapter mounts on the post on the rear of the 3200. It has a 7-pin mini-DIN connector and two binding posts. The mini-DIN connector plugs into the 3200 cell socket and a YSI 3400 series cell (or equivalent) connects to the binding posts.

RS232 CONNECTION

The RS232 connection is a standard DB9 connector. This connector allows the 3200 to be connected to the serial port of a computer or serial printer. A standard straight (NOT a null modem) cable is required for connecting to a computer. To connect to a serial printer, use a straight 9-pin male to 25 pin female cable (see Appendix - B).

EXTERNAL TEMPERATURE CONNECTION

The external temperature probe connection is used for temperature measurement and compensation whenever the conductivity cell currently connected does NOT contain an internal

temperature sensor. All YSI 3200 series cells contain an internal temperature sensor; therefore, an external temperature probe is NOT necessary when using a 3200 series cell. However, if an external temperature probe is used with a YSI 3200 series cell, the external temperature probe will override the temperature sensor in the cell.

YSI 3400 series cells do not contain an internal temperature sensor; therefore, an external temperature probe (YSI 3220 or YSI 700 series) is needed for temperature measurement or compensation.

CE COMPLIANCE

Use of an external temperature probe or the YSI Model 3232 cell adapter with this instrument may cause non-compliance with CE standards. See the Declaration of Conformity.

SECTION 2 GETTING STARTED

2.1 UNPACKING

When you unpack your new YSI Model 3200 for the first time, check the packing list to make sure you have received everything you should have. If there is anything missing or damaged, call the dealer from whom you purchased the Model 3200. If you do not know which of our authorized dealers sold the system to you, call YSI Customer Service at 800-765-4974 or 937-767-7241, and we'll be happy to help you.

2.2 WARRANTY CARD

Please complete the Warranty Card and return it to YSI. This will record your purchase of this instrument in our computer system. Once your purchase is recorded, you will receive prompt, efficient service in the event any part of your YSI Model 3200 should ever need repair.

2.3 WHAT YOU NEED

Several things are needed in order to make accurate conductivity measurements using the YSI 3200. The following list shows the basic items required.

- Instrument
- Power Supply
- Conductivity Cell
- Standard Solution(s)
- Beakers
- Rinsing Solution

2.4 SETTING UP

1. Power

Plug the power supply into its mating connector on the back of the instrument.

Depress the  (on/off) key to turn the instrument on. The following screen should be displayed.

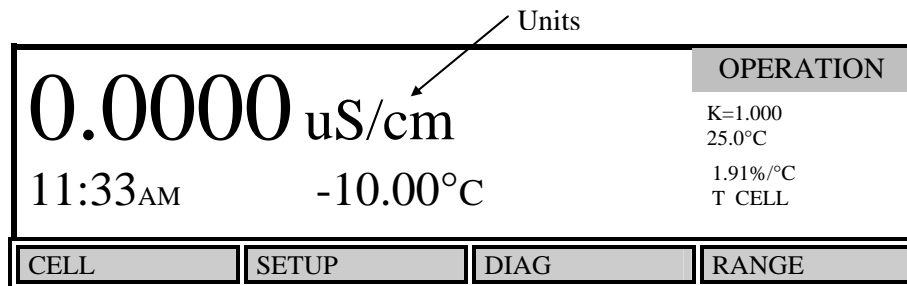

Notice that the units displayed are “uS/cm” indicating that the 3200 is in conductivity mode (conductivity = conductance x cell constant). If the units are displayed as “uS” (no “/cm”), the 3200 is reading only conductance (as shown on the following page).

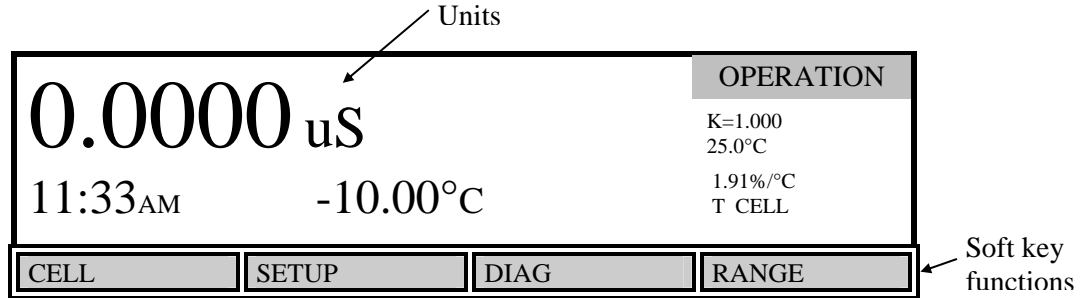

It is important to remember that the cell constant is NOT used when displaying conductance. To change the measurement units, see 3.5 Display Configuration, Measurement Units.

The bottom row of the display shows the soft key menu.

2. Set the Date and Time

Press the [SETUP] soft key to enter the Setup menu.

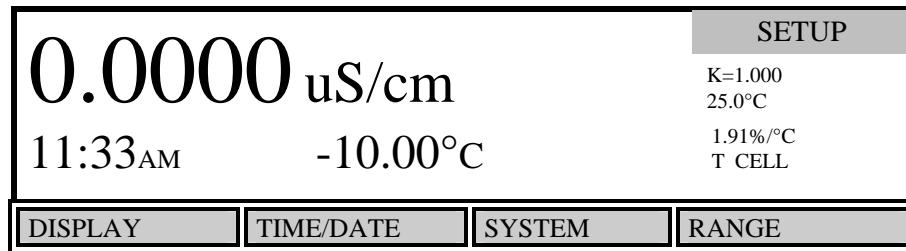

Then, press the [TIME/DATE] soft key to enter the Time/Date menu. The following screen will be displayed.

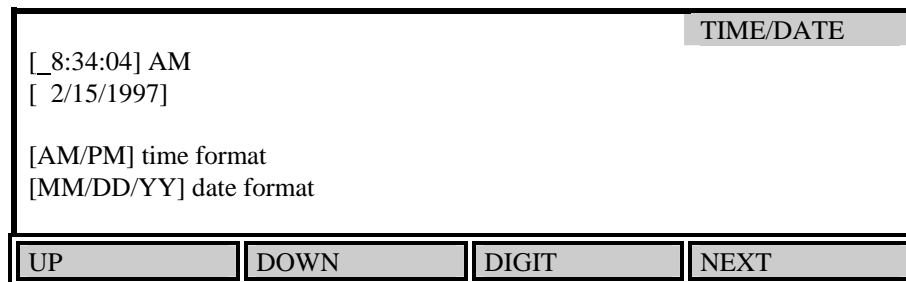

The cursor (underline) starts at the first digit of the time field. Use the [UP] or [DOWN] soft key to change the underlined digit. When you have the correct digit displayed, press the [DIGIT] soft key to move the cursor to the next digit, then use the [UP] or [DOWN] soft key to change that digit. After you have entered the correct time, press the [NEXT] soft key to move the cursor to the date field, then enter the correct date using the [UP], [DOWN] and [DIGIT] soft keys.

After you have entered the correct date and time, press the [MODE] key two times to save and exit to the Setup menu.

3. Connect the Cell

Plug the cell (YSI 3200 series) into the connector on the back of the instrument marked cell.

NOTE: If you are using a YSI 3400 series cell, you will need the following:

- 3232 adapter
- YSI 3220 or 700 series temperature probe

4. Configure the 3200

Next, you **must** configure the 3200 with the correct cell constant of the cell you are using. From Operation mode, press the [CELL] soft key to enter the Cell menu.

[0] # Configuration number	CELL
[CONFIG 0] Title	0.0000uS offset
[Single] Cell Cal	[1.00] K
[Linear] Comp	[1.91] %/°C Comp val
[0.68] T.D.S. mult	[25.0] °C Comp Temp
ENTER TO SEND CONFIGURATION	
CONFIGURE	CAL K
TEMP	PLATIN

Then, press the [CONFIGURE] soft key to enter the Configure menu. Configure is used to select and configure the current cell and temperature compensation. The 3200 stores six configurations numbered 0 to 5.

K field (cell constant)

[0] # Configuration number	CONFIG
[CONFIG 0] Title	0.0000uS offset
[Single] Cell Cal	[1.00] K
[Linear] Comp	[1.91] %/°C Comp val
[0.68] T.D.S. mult	[25.0] °C Comp Temp
ENTER TO SEND CONFIGURATION	
UP	DOWN
DIGIT	NEXT

Press the [UP] or [DOWN] soft key until you have selected configuration 0. The default configuration is a single fixed cell constant of $K = 1$, linear temperature compensation corrected to 25°C using a coefficient of 1.91%/°C.

Press the [NEXT] soft key to move the cursor (underline) to the Title field. Using the [UP], [DOWN] and [DIGIT] soft keys, you may enter a name for this configuration.

Press the [NEXT] soft key four times to move the cursor to the K field. Using the [UP], [DOWN] and [DIGIT] soft keys, enter the manufacturer's stated cell constant for the cell that you are using ($K = 0.1, 1.0, 5.0, 10.0$ etc.).

Press the [MODE] key two times to return to the Operation menu.

5. Measurement

After setting up the 3200 instrument and cell as described above, the following basic steps should be used to make measurements.

1. Immerse the cell (YSI 3200 series) in the solution to be measured. If using a YSI 3400 series cell, also place the temperature probe in the solution.
2. Gently tap the cell to remove any air bubbles and dip the cell in the solution 2 or 3 times to ensure proper wetting. The cell electrodes must be submerged and the electrode chamber must not contain any trapped air. If using a flow through or fill cell, be certain it is completely full.
3. Allow time for the temperature to stabilize.
4. Read the display, send the reading to a computer or serial printer (see section 4.3 Send), or store the reading in memory (see section 4.1 Store).
5. Remove the cell (and temperature probe, if used) from the sample solution and rinse with distilled or deionized water.

SECTION 3 SYSTEM CONFIGURATION AND OPERATION

3.1 MENU

The following section shows the software flow chart for the 3200. The two operating modes, Data and Operation, are shown at the top with the soft key functions that are accessed in each mode below them.

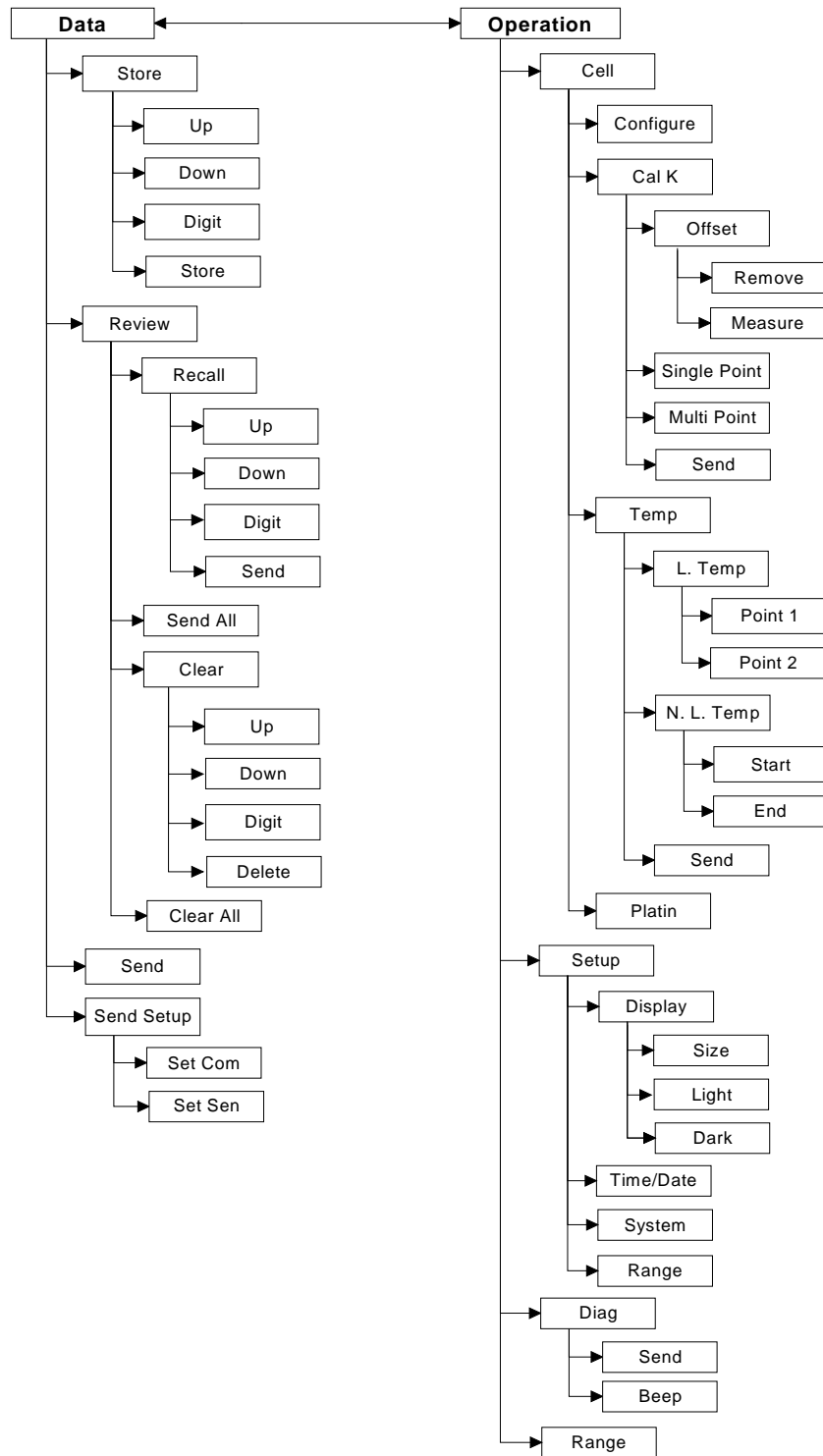

3.2 CELL CALIBRATION

Before operating the 3200, or whenever you change cells, you must configure the 3200 to match the cell used. There are two ways to do this. Choose the **one** that best meets your needs.

1. You may directly enter the manufacturer's stated (or your manually calculated) cell constant (K). See 3.2 Cell Calibration, Configure.

or

2. Allow the 3200 to calculate the cell constant and calibrate the system using standard conductivity solution(s). See 3.2 Cell Calibration, Cal K.

The cell constant of up to six different cells (# 0 - 5) can be stored in non-volatile memory. The 3200 can determine the cell constant for a cell at a single point or up to five points using different standard solutions.

Remember that Conductance (uS, mS or S) or Resistance (Ω , K Ω or M Ω) readings do NOT use the cell constant. The 3200 must be set up to read Conductivity (uS/cm, mS/cm or S/cm) or Resistivity (Ω -cm, K Ω -cm or M Ω -cm) for the cell constant to be used. See 8.2 Conductivity Principles, Conductivity Fundamentals.

From the Operation mode, press the [CELL] soft key to enter the Cell menu. The bottom row of the display shows the soft key menu.

[0] # Configuration number		CELL
[CONFIG 0] Title	0.0000uS offset	
[Single] Cell Cal	[1.00] K	
[Linear] Comp	[1.91] %/°C Comp val	
[0.68] T.D.S. mult	[25.0] °C Comp Temp	
ENTER TO SEND CONFIGURATION		
CONFIGURE	CAL K	TEMP PLATIN

The Cell screen shows the configuration for the currently selected cell. The first two soft keys are used to select the current cell configuration and calculate the cell constant (K). The cell constant can be calculated at a single point with a standard solution or up to five points with different solutions.

The last two soft keys are used to calculate the temperature coefficient of solutions and to replatinize the electrodes of the cell.

CONFIGURE

Configure allows the user to directly input the cell constant (K), temperature compensation mode and factor and total dissolved solids (TDS) multiplier. It also allows you to select a standard non-linear temperature compensation curve for ultrapure or natural water. Alternatively, you may calibrate the cell constant (K) and measure the temperature compensation factor in menus Cal K and Temp. See 3.2 Cell Calibration, Cal k and 3.3 Temperature Compensation, Temp.

From the Cell menu, press the [CONFIGURE] soft key to enter the Configure menu. The bottom row of the display shows the soft key selections.

[0] # Configuration number	CONFIG
[CONFIG 0] Title	0.0000uS offset
[Single] Cell Cal	[1.00] K
[Linear] Comp	[1.91] %/°C Comp val
[0.68] T.D.S. mult	[25.0] °C Comp Temp
ENTER TO SEND CONFIGURATION	
UP	DOWN
DIGIT	NEXT

Press the [UP] or [DOWN] soft key to select one of the six (0-5) stored configurations. Each configuration contains the single cell constant, zero offset, multiple cell constants, total dissolved solids (TDS) multiplier, linear temperature compensation coefficient **and** non-linear temperature compensation data.

To change the currently selected configuration, press [NEXT] to move the cursor to the field you want to change. Then, use the [UP], [DOWN] and [DIGIT] soft keys to change the field, except Offset. The Offset field can only be changed from the Offset menu. The following table shows the choices for each field.

Example: To select the standard non-linear temperature compensation curve for ultrapure water, press [NEXT] three times, to move the cursor to the Comp field, then, press the [UP] or [DOWN] soft key to cycle through the selections until Pure is displayed. Press [MODE] two times to exit to the Operation menu.

Field	Range / options	Description
Title	A - Z or 0 - 9	User defined name for this configuration.
Cell Cal	Single or Multi	Selects between a single fixed cell constant and multiple cell constants.
Comp	Linear, N. Linear, Pure, Natural or Off	Selects between a linear temperature compensation coefficient, non-linear temperature compensation curve, standard non-linear temperature compensation curve (pure or natural) or no temperature compensation.
TDS mult	0.55 - 0.90	Factor used to calculate the total dissolved solids from the conductivity.
uS offset	0.0000 - 0.0150	Zero offset. Used only when measuring conductance below 10uS to offset cell lead insulation resistance. This value can only be changed from the Offset menu.
K	0.001 - 100.999	Single fixed cell constant value (K). This value is only used when the Cell Cal field is set to Single.

Field	Range / options	Description
%/°C comp val	0.0 - 10	Linear temperature compensation value. This value is only used when the Comp field is set to Linear.
°C comp temp	0.0 - 100	Reference temperature that readings are compensated to when temperature compensation is used.

After you have finished changing the current configuration, press [MODE] two times to return to Operation mode.

From the Config menu, the [ENTER] key may be used to send the current configuration data to a computer or serial printer via the RS232 port.

CAL K

From the Cell menu, press the [CAL K] soft key to enter the Calibrate K menu. This menu is used to measure the cell constant (K) of the current cell and store it in the currently selected configuration. The cell constant can be measured at a single point using a single standard solution or at multiple points using different value standard solutions. Alternatively, you may directly input the cell constant in Cell Configuration. See 3.2 Cell Calibration, Configure.

[0] # Configuration number	CALIBRATE K		
[CONFIG 5] Title	0.0000uS offset		
[Single] Cell Cal	[1.00] K		
[Linear] Comp	[1.91] %/°C Comp val		
[0.68] T.D.S. mult	[25.0] °C Comp Temp		
OFFSET	SINGLE PT	MULTI PT	SEND

Single Point

To calculate and store the cell constant (K) at a single point:

1. From the Calibrate K menu, press the [SINGLE PT] soft key.
2. Clean the container and cell (and temperature probe, if used) with deionized water.
3. Rinse the cell (and temperature probe, if used) with some of the standard solution.
4. Place the cell (and temperature probe, if used) in the standard solution and wait for the temperature reading and measured K value to stabilize.
5. Using the [UP], [DOWN] and [DIGIT] soft keys, enter the value of the standard solution at the current temperature. Temperature compensation is OFF during cell calibration. Example: YSI 3161 Conductivity Calibrator is 1000uS at 25°C, but at 23°C you would enter 961uS.
6. Press [ENTER] to store the current cell constant (K). Press [MODE] three times to exit.
7. Remove the cell (and temperature probe, if used) from the solution and rinse with deionized water.

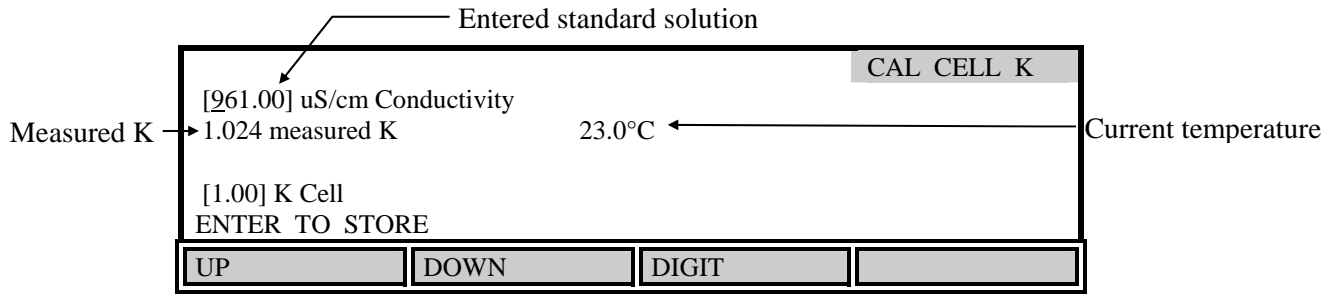

Multi Point

To calculate and store the cell constant (K) at multiple points using different value standard solutions:

1. From the Calibrate K menu, press the [MULTI PT] soft key.
2. Clean the container and cell (and temperature probe, if used) with deionized water.
3. Rinse the cell (and temperature probe, if used) with some of the standard solution.
4. Place the cell (and temperature probe, if used) in the solution and wait for the temperature reading and measured K value to stabilize.
5. Using the [UP], [DOWN] and [DIGIT] soft keys, enter the value of the standard solution at the current temperature. Temperature compensation is OFF during cell calibration. Example: YSI 3161 Conductivity Calibrator is 1000uS at 25°C, but at 23°C you would enter 961uS.
6. Press [ENTER] to store the current cell constant (K). Stored values are displayed at the bottom of the screen.
7. Repeat steps 3 - 6 for the remaining solutions.
8. If you have entered less than 5 solutions, enter 0.0uS for each remaining (unused) point and press [ENTER] to store each one.
9. When you have measured all the solutions and stored all 5 points, press [MODE] two times to exit to the Cell menu.
10. Press the [CONFIGURE] soft key to enter the Configure menu, then press [NEXT] two times to move the cursor to the Cell Cal field. Press the [UP] or [DOWN] soft key to select Multi cell calibration. Press [MODE] two times to exit to Operation mode.
11. Remove the cell (and temperature probe, if used) and rinse with deionized water.

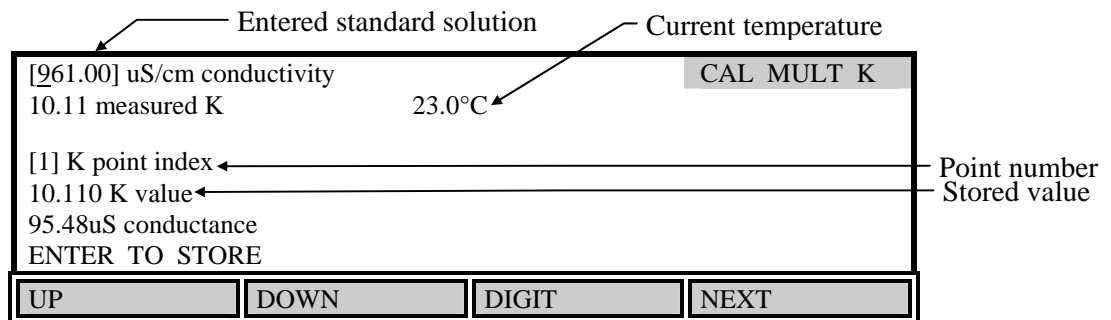

After calculating and storing multiple cell constants, the Operation screen shows the current cell constant used during measurements. Notice that the K= changes to Km= to show that multiple cell constants are in use.

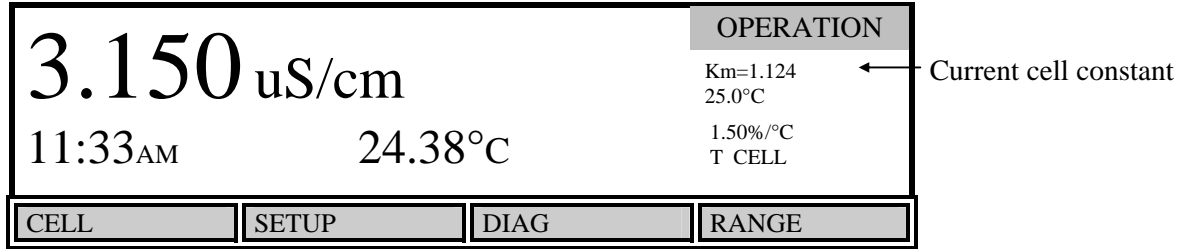

Offset

When measuring conductance below 10uS (resistance above 100KΩ), the insulation resistance of the cell leads may be a source of error. This error may be greatly reduced by allowing the 3200 to calculate and store a zero offset value.

From the Calibrate K menu, press the [OFFSET] soft key to enter the Offset menu.

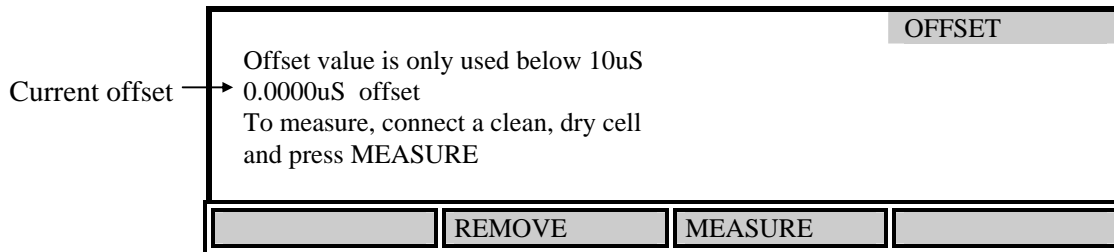

To measure and store the offset for the current cell in the currently selected configuration, connect a clean, dry cell to the 3200, then, press the [MEASURE] soft key. The current offset is displayed on the screen.

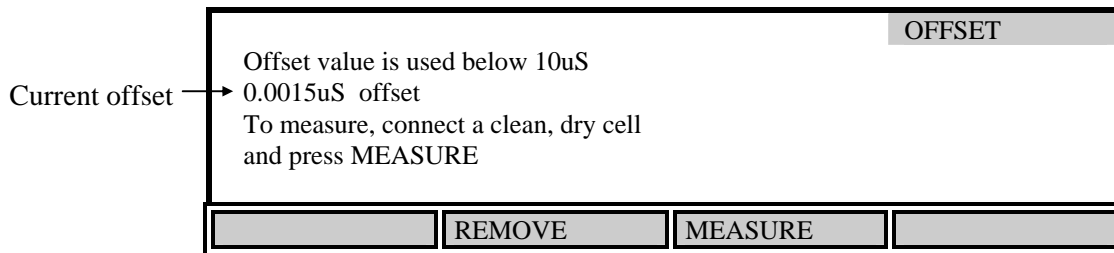

To remove a stored offset (set the offset to zero), press the [REMOVE] soft key.

Send

From the Calibrate K menu, the [SEND] soft key may be used to send the current cell constant data to a computer or serial printer via the RS232 port.

3.3 TEMPERATURE COMPENSATION

There are four options for temperature compensation on the YSI 3200.

1. Directly enter a linear temperature compensation factor (0 - 10%/°C)
2. Select a standard non-linear compensation curve (ultrapure, natural).

3. Measure a linear temperature compensation factor.
4. Measure a non-linear temperature compensation curve.

The previous section, 3.2 Cell Calibration, describes the first two options. The following section, Temp, describes how options 3 and 4 are used.

TEMP

From the Cell menu, press the [TEMP] soft key to enter the Cell Temp menu. This menu is used to calculate the linear or non-linear temperature compensation coefficient of a particular solution and store it in the currently selected configuration. Although the cell used is recorded, the temperature compensation information can be used with any cell. Non-linear temperature compensation [N.L. Temp] records multiple points over a temperature range and stores the overall curve. Linear temperature compensation [L. Temp] measures a solution at only two points and calculates a linear temperature coefficient in $\%/^{\circ}\text{C}$. Alternatively, you may input a linear temperature compensation factor (0 - 10 $\%/^{\circ}\text{C}$). See 3.2 Cell Calibration, Configure.

[5] # Configuration number	CELL TEMP
[CONFIG 5] Title	0.0000uS offset
[Single] Cell Cal	[1.00] K
[Linear] Comp	[1.50] $\%/^{\circ}\text{C}$ Comp val
[0.68] T.D.S. mult	[25.0] $^{\circ}\text{C}$ Comp Temp
<div style="display: flex; justify-content: space-between; border-top: 1px solid black; border-bottom: 1px solid black;"> L. TEMP N. L. TEMP SEND </div>	

Linear Temperature Compensation

From the Cell Temp menu, press the [L. TEMP] soft key to enter the Lin Temp menu. This menu enables the user to calculate the linear temperature compensation coefficient of a solution by measuring it at two temperature points.

NOTE : If you already know the linear temperature compensation coefficient of the solution, you may enter it directly in the Configure menu. See 3.2 Cell Calibration, Configure.

[25.00] $^{\circ}\text{C}$ p1	LIN TEMP
[0.00] uS p1	22.61 $^{\circ}\text{C}$
[25.00] $^{\circ}\text{C}$ p2	895.1 uS
[0.00] uS p2	
[0.00] $\%/^{\circ}\text{C}$ calculated	
ENTER TO STORE	
<div style="display: flex; justify-content: space-between; border-top: 1px solid black; border-bottom: 1px solid black;"> POINT 1 POINT 2 </div>	

Stored points

Current

Calculated temperature coefficient

To calculate and store the linear temperature compensation coefficient:

1. Verify that the current configuration contains the correct cell constant for the current cell.
2. Clean the container and YSI 3200 Series cell (or YSI 3400 Series and temperature probe) with deionized water.
3. Rinse the cell (and temperature probe, if used) with some of the solution to be analyzed.

4. Place the cell (and temperature probe, if used) in the solution at the first desired temperature point and wait for the reading to stabilize. Ensure that the cell and temperature probe are submerged and that no air bubbles are trapped in the cell.
5. Press the [POINT 1] soft key to store point 1.
6. Place the cell (and temperature probe, if used) in the same solution at the second desired temperature point and wait for the reading to stabilize.
7. Press the [POINT 2] soft key to store point 2.
8. Remove the cell (and temperature probe, if used) and rinse with deionized water.

The linear temperature compensation coefficient has now been calculated and stored under the current cell configuration.

NOTE: Any non-linear temperature compensation curve stored under the current configuration will be retained.

Non-linear Temperature Compensation

From the Cell Temp menu, press the [N. L. TEMP] soft key to enter the NL Temp menu. This menu enables the user to calculate a non-linear temperature compensation curve for a solution by measuring it while the temperature is changed.

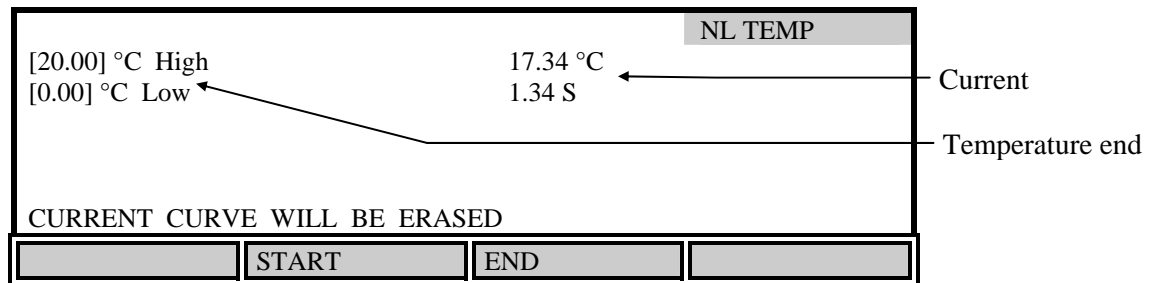

To calculate and store the non-linear temperature compensation curve:

1. Verify that the current configuration contains the correct cell constant for the current cell.
2. Clean the container and YSI 3200 Series cell (or YSI 3400 Series and temperature probe) with deionized water.
3. Rinse the cell (and temperature probe, if used) with some of the solution to be analyzed.
4. Place the cell (and temperature probe, if used) in the solution at one end of the temperature range that you want to compensate over and wait for the reading to stabilize.
5. Press the [START] soft key.
6. Change the temperature of the solution while the cell (and temperature probe, if used) is measuring it.
7. When the temperature reaches the end of the range you want to compensate over, press the [END] soft key.
8. Remove the cell (and temperature probe, if used) and rinse with deionized water.

The non-linear temperature compensation curve has now been calculated and stored under the current cell configuration.

Send

From the Cell Temp menu, the [SEND] soft key may be used to send the current temperature compensation data to a computer or serial printer via the RS232 port.

3.4 PLATINIZATION

The 3200 can be used to replatinize the electrodes of the cell. See section 6.2 Platinization for details.

3.5 DISPLAY CONFIGURATION

The 3200 display is extremely flexible. The user may select from two screen sizes and may select what data is displayed in each field.

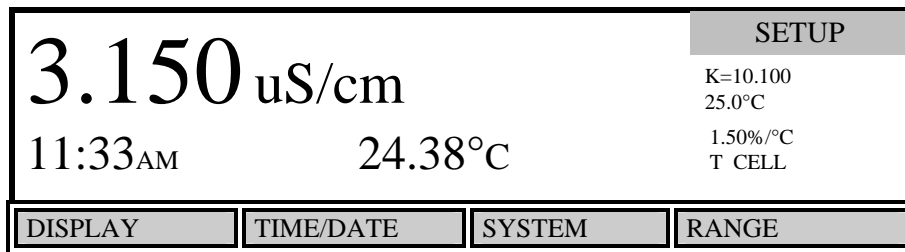

From Operation mode, press the [SETUP] soft key, then press [DISPLAY] to enter the Setup Disp menu. The default display is the large display with three user selectable fields. Conductivity is in the large field and temperature and time are in the smaller fields.

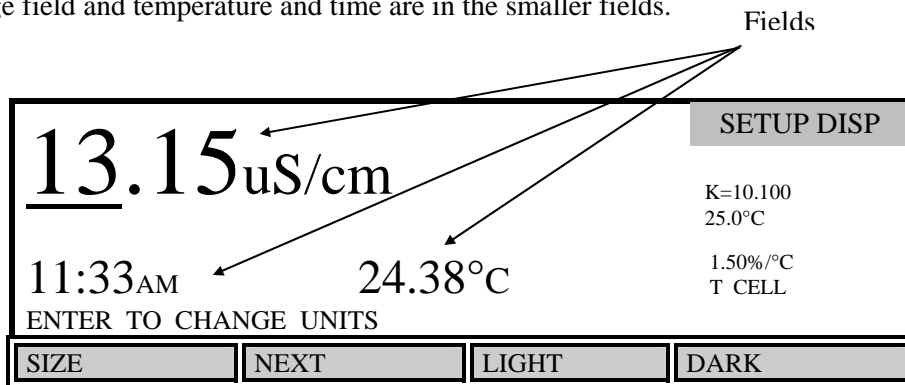

To change the display size, press the [SIZE] soft key. The small display contains six user selectable fields. The first three fields in the small display correspond to the fields of the large display. The following is an example of the small display.

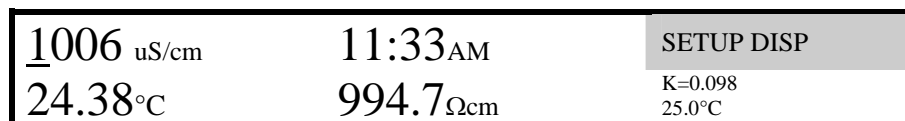

684	mg/L TDS	0.4	ppt SAL	1.91%/°C T CELL
ENTER TO CHANGE UNITS				
SIZE	NEXT	LIGHT	DARK	

MEASUREMENT UNITS

Each of the six fields on the small display (three fields on the large display) may be setup by the user. Selection of fields is important, even if only the large display is used, because, when a reading is stored in the 3200 memory, the date, time, temperature and conductivity are stored, along with the first two additional fields (fields other than date, time, temperature and conductivity) currently on the display. These same selected fields are also used when logging data to a computer or serial printer.

1006	uS/cm	9999	uS	SETUP DISP
65.68	°F	97.8	Ω	K=0.098 25.0°C
684	mg/L TDS	0.4	ppt SAL	1.91%/°C T CELL
ENTER TO CHANGE UNITS				
SIZE	NEXT	LIGHT	DARK	

From the Setup Disp screen, press the [NEXT] soft key to select the field you want to change, then press [ENTER] repeatedly to change the field until the information you want is displayed. Each field may contain one of the following:

- Conductance, S, mS, uS
- Conductivity, S/cm, mS/cm, uS/cm
- Resistance, Ω (ohms), KΩ, MΩ
- Resistivity, Ω-cm, KΩ-cm, MΩ-cm
- Total Dissolved Solids, mg/L
- Salinity, ppt
- Time
- Date
- Temperature, °C
- Temperature, °F
- Blank

CONTRAST

The display contrast is adjusted from the Setup Display menu.

13.15 $\mu\text{S/cm}$			SETUP DISP
			K=0.100 25.0°C
11:33 _{AM}	24.38°C	1.50%/°C T CELL	
ENTER TO CHANGE UNITS			
SIZE	NEXT	LIGHT	DARK

Press the [LIGHT] or [DARK] soft keys to change the display contrast as necessary.

TIME/DATE

From Operation mode, press the [SETUP] soft key, then press [TIME/DATE] to enter the Time/Date screen. This screen is used to set the time and date values and format.

			TIME/DATE
[_8:34:04] AM			
[2/15/1997]			
[AM/PM] time format			
[MM/DD/YY] date format			
UP	DOWN	DIGIT	NEXT

The first two fields are used to enter the current time and date. Use the [UP], [DOWN] and [DIGIT] soft keys to enter the correct time. Press [NEXT] to change to the date field, then enter the correct date. The default time and date formats are AM/PM and Month/Day/Year. To change these formats, use the [NEXT] soft key to select the field, then use the [UP] or [DOWN] soft key to change the format to 24Hr or Day/Month/Year. After you have entered the correct values, press [MODE] to save and exit to the Setup menu. Press [MODE] again to return to the Operation menu.

ALARMS

The 3200 has both high and low user programmable alarms. When an alarm is triggered, the 3200 screen will display “ALARM! READINGS OUT OF LIMITS” and can also be set to beep and/or send the information to a computer or serial printer via the RS232 port.

To activate the alarm(s):

1. From Operation mode, press the [SETUP] soft key, then, press [SYSTEM] to enter the Setup Sys menu. The following menu will be displayed.

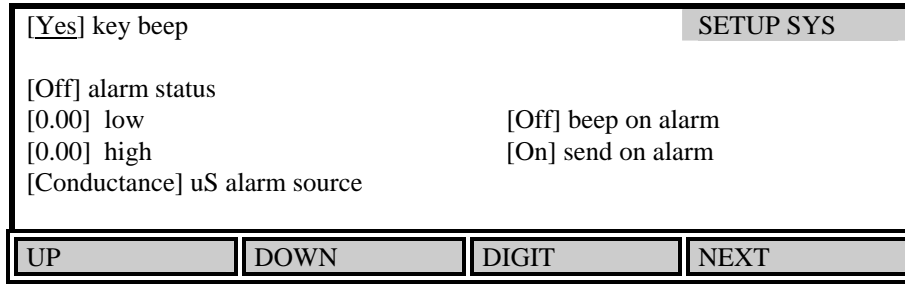

2. Use the [NEXT] soft key to select the Alarm status field, then press [UP] or [DOWN] to change the Alarm status to “On”.
3. Press [NEXT] to select the Low field, then use the [UP], [DOWN] and [DIGIT] soft keys to enter the set point for the low alarm.
4. Press [NEXT] to select the High field and use the [UP], [DOWN] and [DIGIT] soft keys to enter the set point for the high alarm.
5. Press [NEXT] to select the alarm source, then press [UP] or [DOWN] to change the source. The source may be conductance, conductivity or resistance.
6. Press [NEXT] to select “beep on alarm”, then press [UP] or [DOWN] to turn the alarm beeper on or off.
7. Press [NEXT] to select “send on alarm”. When this parameter is enabled (On), readings will be sent to a computer or serial printer whenever the alarm is triggered.

Press [MODE] once, to return to the Setup menu, or two times to return to Operation mode.

NOTE: To setup the communications parameters or select the report format and which data fields will be sent over the RS232 serial port, see 4.3 Send, Send Setup.

BEEPER

The 3200 contains a beeper to indicate when a key has been pressed. The beeper may be turned on or off from the Setup Sys menu. Press the [SETUP] soft key, while Operation mode, then press [SYSTEM] to enter the Setup Sys menu .

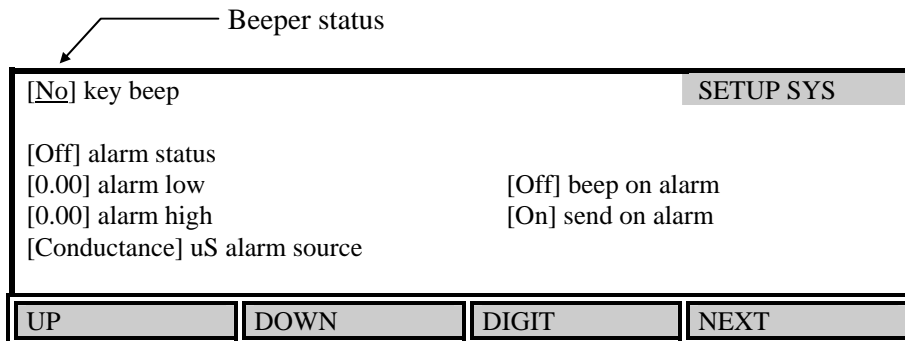

Since the cursor is already in the Key beep field, press [UP] or [DOWN] to change the status of the beeper. Press [MODE] two times to return to Operation mode.

RANGING

The Range menu allows the user to select between Auto and Manual ranging. The default is autoranging, where the 3200 will automatically select the range that displays the highest resolution for the sample being measured. Since this automatic selection takes time, the user may select manual ranging when measuring several samples that fall into the same range.

From Operation mode, press the [SETUP] soft key, then press the [RANGE] soft key to enter the Setup Range menu.

SETUP RANGE			
[AUTO] Auto/Manual Range			
[950 - 9999uS] Current range			
UP	DOWN		NEXT

The Range menu allows the user to select between Auto and Manual ranging. Press the [UP] or [DOWN] soft key to change from Auto to Manual. When ranging is set to Manual, the current range can be set by pressing the [NEXT] soft key (to move the cursor to the Current range field), then pressing the [UP] or [DOWN] soft key to select the desired range. The following hardware ranges may be selected:

95.0mS - 3.00S
 9.50 - 99.99mS
 950 - 9999uS
 95.0 - 999.9uS
 9.50 - 99.99uS
 0.950 - 9.999uS
 0 - 0.9999uS

After setting up manual ranging, press the [MODE] key two times to return to Operation mode.

13.15uS			OPERATION
			K=0.100 25.0°C
11:33AM	24.38°C	1.50%/°C T CELL	
CELL	SETUP	DIAGNOSTICS	RANGE

While making measurements (in Operation mode), the range can also be manually selected by pressing the [RANGE] soft key. The current range selected will be displayed on the message line.

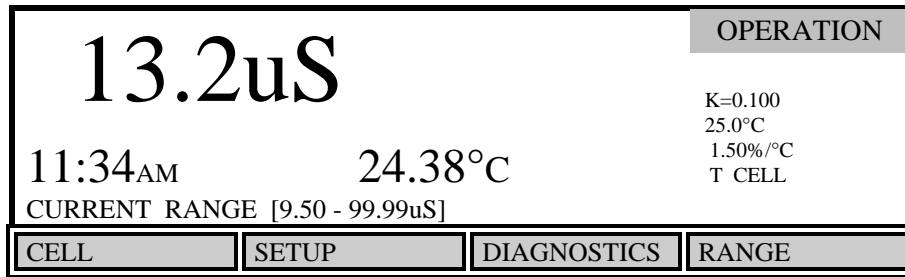

If the range selected cannot display the current reading, an “OUT OF RANGE” message is displayed as shown below.

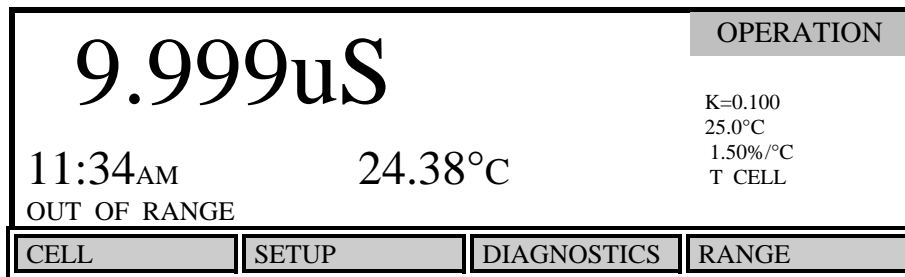

Each time the [RANGE] soft key is pressed, the 3200 hardware will change the current conductance/resistance range. If measurements are currently displayed as conductance or resistance, you will see the range change on the display. If, however, you are displaying conductivity, resistivity, TDS or salinity, as you change ranges, the display will automatically select the best resolution and the hardware range change will not be visible.

Example:

With the 3200 in manual range mode, 9.50 - 99.99mS range, the display is as follows:

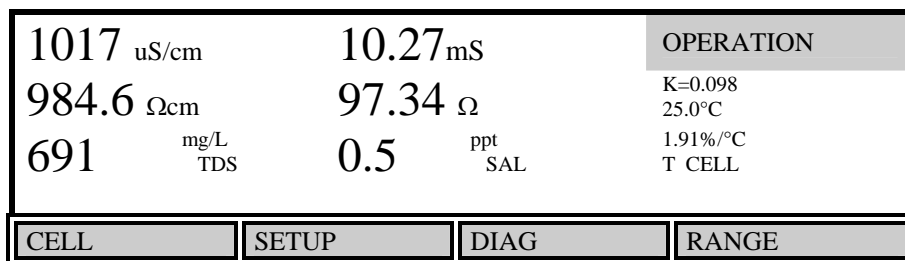

If the [RANGE] soft key is pressed, the hardware switches to the 95.0mS - 2.99S range. The conductance and resistance fields reflect the change, but the conductivity, resistivity, TDS and salinity fields remain essentially unchanged.

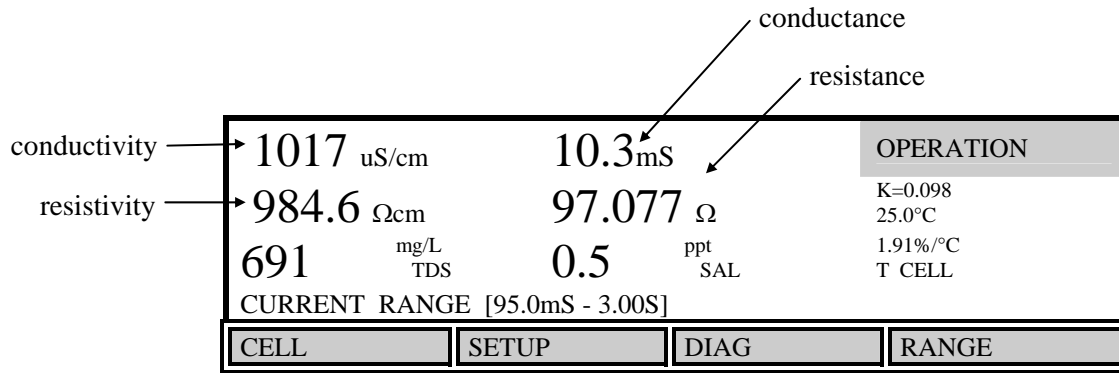

If the [RANGE] soft key is pressed again, the hardware switches to the 0 - 0.9999uS range. The conductance and resistance fields are now out of range and the 3200 displays a warning. The conductivity, resistivity, TDS and salinity fields are still operating, but, since the hardware is out of range, readings are no longer accurate.

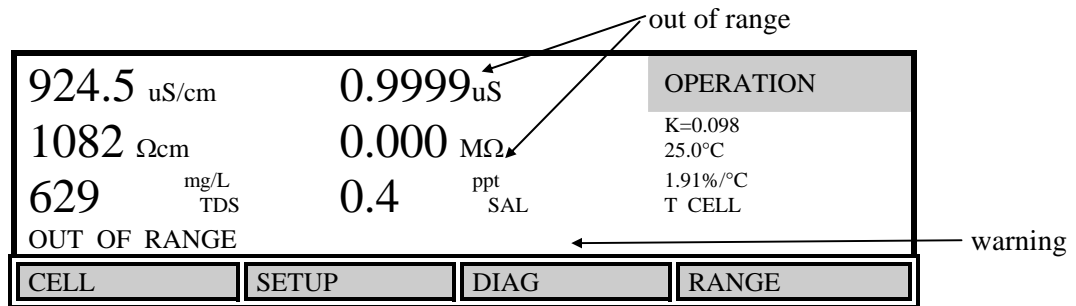

3.6 MAKING MEASUREMENTS

After setting up the 3200 instrument and cell as described earlier, the following basic steps should be used to make measurements.

1. Make sure that the 3200 is setup to read the units you wish to measure in (conductance, conductivity, resistivity, etc.). To change the units see section 3.5 Display Configuration, Measurement Units.
2. Verify that the 3200 is properly setup to use the current cell by measuring, or calibrating with, standard conductivity solution(s). See section 3.2 Cell Calibration.
3. Immerse the cell (YSI 3200 series) in the solution to be measured. If using a YSI 3400 series cell and correcting for temperature, also place the temperature probe in the solution.
4. Gently tap the cell to remove any air bubbles and dip the cell in the solution 2 or 3 times to ensure proper wetting. The cell electrodes must be submerged and the electrode chamber must not contain any trapped air. If using a flow through or fill cell, be certain it is completely full.
5. Allow time for the temperature to stabilize.
6. Read the display, send the reading to a computer or serial printer, or store the reading in memory.
7. Rinse the cell (and temperature probe, if used) with distilled or deionized water.

SECTION 4 DATA STORAGE AND RETRIEVAL

From Operation mode, press the [MENU] key to enter Data mode. Data mode is used to store, review or delete readings and to send the current reading to a computer or serial printer.

31.15 $\mu\text{S}/\text{cm}$			DATA
11:33 _{AM}	24.38 $^{\circ}\text{C}$	K=1.100	25.0 $^{\circ}\text{C}$
		1.50%/ $^{\circ}\text{C}$	T CELL
STORE	REVIEW	SEND	SND SETUP

4.1 STORE

From the data menu, press the [STORE] soft key to enter Store mode and display the following menu.

3.150 $\mu\text{S}/\text{cm}$			STORE
11:33 _{AM}	24.38 $^{\circ}\text{C}$	Record #	
		[_0]	← Record number
		EMPTY	← Status
UP	DOWN	DIGIT	STORE

The Store menu is used to control the storing of data. The 3200 can store 100 readings (records 0 - 99). The current record number and status are shown in the display on the right side.

Press the [STORE] soft key to store the current readings. The message "RECORD STORED" will be displayed briefly on the screen and the record number will increase to the next memory location. The 3200 stores the date, time, temperature and conductivity along with the first two additional fields (fields other than date, time, temperature and conductivity) currently on the display. To setup the units to display/store, see 3.5 Display Configuration, Measurement Units.

3.150 $\mu\text{S}/\text{cm}$			STORE
11:33 _{AM}	24.38 $^{\circ}\text{C}$	Record #	
		[1]	← Record number
		EMPTY	
		RECORD STORED	← Message
UP	DOWN	DIGIT	STORE

If you wish to store a record at a location other than the current one, use the [UP], [DOWN] and [DIGIT] soft keys to select the memory location desired.

If the current record location contains data, you will see the following display to warn you that the current memory location contains data.

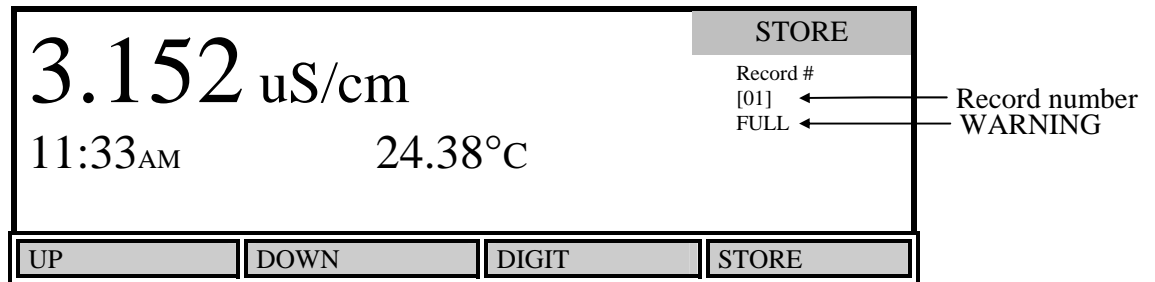

If the current memory location already contains data and you press [STORE], the current readings will be stored and the previous readings will be erased.

NOTE: There is NO way to restore previous data once it has been erased.

When you have finished storing records, press [MODE] two times to return to Operation mode.

4.2 REVIEW

From the Data menu, press the [REVIEW] soft key to enter Review mode and display the following menu.

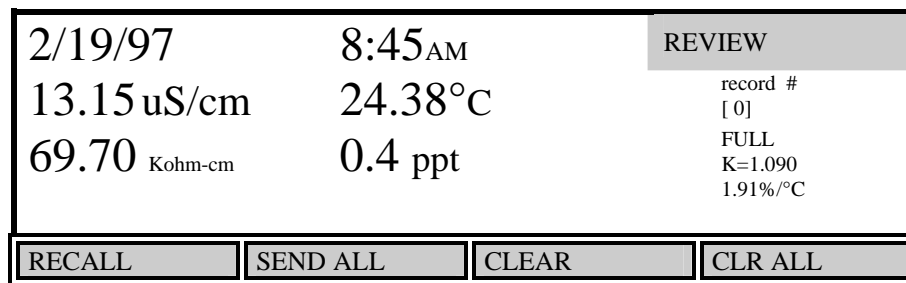

Review is used to recall stored readings (records), send stored readings via the RS232 serial port or delete stored readings.

RECALL

From the Review menu, press the [RECALL] soft key to enter Recall mode and display the following menu.

2/19/97	8:45 _{AM}	RECALL	
13.15 uS/cm	24.38°C	record #	
69.70 _{Kohm-cm}	0.4 ppt	[0]	
		FULL	
		K=1.090	
		1.91%/°C	
UP	DOWN	DIGIT	SEND

The Recall menu is used to recall or send data that was previously stored. The current record number is shown on the right side of the display along with its status.

Use the [UP], [DOWN] and [DIGIT] soft keys to view a different record number.

Press the [SEND] soft key to send the currently displayed record to a computer or serial printer via the RS232 port. See section 4.3 Send, Send Setup for format.

When you have finished recalling records, press [MODE] two times to return to Operation mode.

SEND ALL

From the Review menu, you may send ALL stored records to a computer or serial printer by pressing the [SEND ALL] soft key. See section 4.3 Send, Send Setup for format.

CLEAR

From the Review menu, press the [CLEAR] soft key to display the following menu.

2/19/97	8:45 _{AM}	CLEAR	
13.15 uS/cm	24.38°C	record #	
69.70 _{Kohm-cm}	0.4 ppt	[0]	
		FULL	
		K=1.090	
		1.91%/°C	
UP	DOWN	DIGIT	DELETE

The Clear menu is used to delete data that was previously stored. The current record number is shown in the display on the right side along with its status.

Use the [UP], [DOWN] and [DIGIT] soft keys to select the record that you want to delete. Press the [DELETE] soft key to delete the selected record.

NOTE: It is not necessary to clear records before new data can be stored. The new data will overwrite the previous data.

1/ 1/95	12:00 _{AM}	CLEAR
0.0	0.00°C	record #
0.0	0.0	[0]
		EMPTY
		K=1.090
		1.91%/°C
UP	DOWN	DIGIT
		DELETE

NOTE: There is NO way to restore data once it has been deleted.

When you have finished deleting records, press [MODE] three times to return to Operation mode.

CLEAR ALL

To delete ALL stored data, from the Review menu, press the [CLR ALL] soft key to display the following:

2/14/97	11:45 _{AM}	CLEAR ALL
2.133 mS/cm	25.48°C	record #
468.8 Ω-cm	45.1 ppt	[10]
		FULL
		K=1.090
		1.91%/°C
ENTER TO CONFIRM DELETE ALL		

Press [ENTER] to confirm your decision and delete ALL stored data. Press [MODE], instead of [ENTER], if you wish to abort.

NOTE: There is NO way to restore data once it has been deleted.

Press [MODE] two times to return to Operation mode.

4.3 SEND

While in the Data menu, the [SEND] soft key is used to send the current live display readings to a computer or serial printer via the RS232 port. This is an alternative to storing results, recalling them, and then printing them.

3.150 $\mu\text{S/cm}$ 24.38°C 317.5 $\text{K}\Omega\text{-cm}$			DATA
			K=10.100 25.0°C 1.91%/°C T CELL
STORE	REVIEW	SEND	SND SETUP

Each time [SEND] is pressed, the current readings are sent to a computer or serial printer via the RS232 port. To setup the format of the data, see the following section (Send Setup).

SEND SETUP

From the Data menu, the [SND SETUP] soft key is used to set the format of, and data fields included in, the information that is sent to a computer or serial printer via the RS232 port.

3.150 $\mu\text{S/cm}$ 24.38°C 317.5 $\text{K}\Omega\text{-cm}$			SEND SETUP
			K=10.100 25.0°C 1.50%/°C T CELL
	SET COM	SET SEN	

To setup the communications parameters, press the [SET COM] soft key. The following screen will be displayed.

			COMM SETUP
[Computer] Serial Device [9600] Baud rate			
UP	DOWN		NEXT

Use the [NEXT] soft key to select between the Serial device and Baud rate fields. Use the [UP] or [DOWN] soft key to change the parameter. The Serial device can be set to computer or printer.

The baud rate range is 1200 to 19200. After you have selected the parameters, press [MODE] once, to return to the Send Setup menu, or three times to return to Operation mode.

To select the report format and which data fields will be sent over the RS232 serial port when the [SEND] soft key is pressed, press the [SET SEN] soft key. The following screen will be displayed.

[] Field delimiter		SETUP SEND	
[] Space units		[*] Temperature	
[*] Date		[Conductance]	
[*] Time		[Conductivity]	
[] Cell config			
[] Compensation		[0] S interval	
UP		DOWN	DIGIT
		NEXT	

Each parameter is selected by placing an asterisk character between the brackets in front of it. Press the [NEXT] soft key to select the parameter that you want to change. Then press the [UP] or [DOWN] soft key to turn the asterisk character on or off.

You can select the report format that you wish to use by changing the field delimiter. The default is a space []. This provides a standard text output. You may also select a comma [,] by pressing the [UP] or [DOWN] soft key.

When Space units is selected, by placing an asterisk character between the brackets in front of it [*], a space will be inserted between the value and the units. This is useful when importing the data to a spreadsheet.

The following are examples of each send format:

Space Delimited Format, send (current display)

1/23/97 12:34:56AM 0# 1.23%/°C 12.34C 12.3mS 1.23ppt

12/12/97 12:34:56AM 0# 1.23%/C 12.34C 1234uS/cm 0.12ppt

Comma Delimited Format, send (current display)

1/23/97, 12:34:56AM, 0# ,1.23%/°C, 12.34C , 12.3mS ,1.23ppt

12/12/97, 12:34:56AM, 0# ,1.23%/C, 12.34C , 1234uS/cm ,0.12ppt

Space Delimited Format, send (recalled data)

0 3/20/97 5:37:17PM 1234uS/cm 23.45C K=0.09 1.91%/C 9999uS

1 3/20/97 5:46:15PM 1234uS/cm 23.45C K=0.09 1.91%/C 9999uS

2 3/20/97 5:57:34PM 1234uS/cm 23.45C K=0.09 1.91%/C 9999uS

Comma Delimited Format, send (recalled data)

0 ,3/20/97, 5:37:17PM, 1234uS/cm ,23.45C ,K=0.09,1.91%/C, 9999uS

1 ,3/20/97, 5:46:15PM, 1234uS/cm ,23.45C ,K=0.09,1.91%/C, 9999uS

2 ,3/20/97, 5:57:34PM, 1234uS/cm ,23.45C ,K=0.09,1.91%/C, 9999uS

The two fields on the right of the 3200 setup send display, below temperature, allow the user to select the measurement parameters that will be sent. Each of the two fields, (last two fields of the report) can be set to read one of the following parameters:

- Conductance
- Conductivity
- Resistance
- Resistivity
- Salinity
- Total dissolved solids

NOTE: When sending recalled data, the units cannot be selected from the Setup send menu, since they were already selected when the readings were previously stored.

After you have selected the parameters, press [MODE] once, to return to the Send Setup menu, or three times to return to Operation mode.

DATA LOGGING

The 3200 can be setup to automatically send results to a computer or serial printer via the RS232 port at a user selected time interval from 5 to 1800 seconds (30 minutes).

From the Data menu, press the [SND SETUP] soft key, then press the [SET SEN] soft key. The following screen will be displayed.

[] Field delimiter		SETUP SEND	
[] Space units		[*] Temperature	
[*] Date		[Conductance]	
[*] Time		[Conductivity]	
[] Cell config			
[] Compensation		[0] S interval	
UP		DOWN	DIGIT
		NEXT	

Setting the S interval parameter to a value other than zero programs the 3200 to automatically send the current readings via the RS232 serial port. This allows data to be logged to a computer or serial printer. The S interval is the number of seconds between transmissions. For example, if the S interval is set to 30, every 30 seconds the 3200 will send the current readings over the RS232 port.

To change the S interval, press the [NEXT] soft key to select the S interval field. Then, use the [UP], [DOWN] and [DIGIT] soft keys to enter the S interval parameter.

<input type="checkbox"/> Field delimiter		SETUP SEND	
<input type="checkbox"/> Space units		[*] Temperature	
[*] Date		[Conductance]	
[*] Time		[Conductivity]	
<input type="checkbox"/> Cell config			
<input type="checkbox"/> Compensation		[30] S interval	
UP	DOWN	DIGIT	NEXT

After you have entered the S interval value, press [MODE] once, to return to the Send Setup menu, or three times to return to Operation mode.

SECTION 5 DIAGNOSTICS

The YSI 3200 has a diagnostic mode that is used to test RS232 communications and the internal beeper. From the Operation menu, press the [DIAG] soft key to enter Diagnostics mode. The following screen will be displayed.

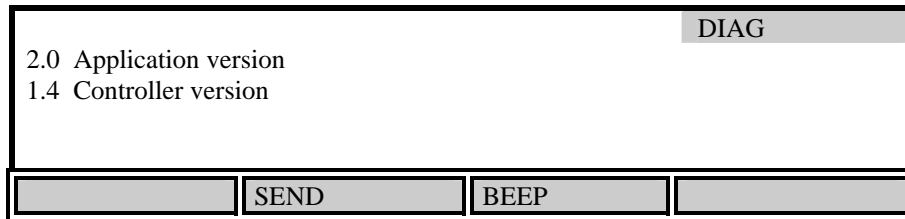

This screen shows the current software version numbers and has soft keys for testing the RS232 communications and the internal beeper.

NOTE: While operating the 3200, the instrument may sense a problem and display an error message. Refer to section 7 Troubleshooting for information on error messages.

5.1 SEND

The send diagnostic function is useful for setting up RS232 communications parameters. The send key causes strings of data to be sent to the serial port at every supported baud rate. From the Diagnostics menu, press the [SEND] soft key to start sending test data strings.

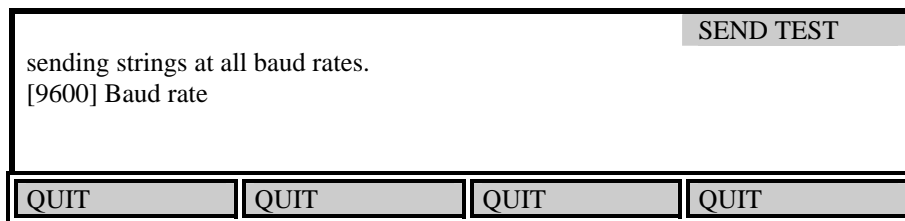

The 3200 will cycle through all supported baud rates. You will see garbage on the computer or serial printer when the baud rates do not match. When the baud rate is correct, legible text will be displayed on the computer or serial printer. The legible text will tell you what baud rate setting to use. Press the [QUIT] soft key to exit, then program the 3200 for the legible baud rate. See 4.3 Send, Send Setup.

5.2 BEEP

The [BEEP] soft key is used to confirm the operation of the beeper. Each time the [BEEP] soft key is pressed, a beep should be heard.

SECTION 6 MAINTENANCE

6.1 CELL CLEANING AND STORAGE

The single most important requirement for accurate and reproducible results in conductivity measurement is a clean cell. A dirty cell will change the conductivity of a solution by contaminating it.

To clean a conductivity cell:

1. Dip or fill the cell with cleaning solution and agitate for two to three minutes. Any one of the foaming acid tile cleaners, such as Dow Chemical Bathroom Cleaner, will clean the cell adequately. When a stronger cleaning preparation is required, use a solution of 1:1 isopropyl alcohol and 1N HCl or Sulfuric Acid or Ethanol or Methanol.

CAUTION: Cells should not be cleaned in aqua regia or in any solution known to etch platinum or gold.

2. Remove the cell from the solution and rinse in several changes of distilled or deionized water. Inspect the platinum black to see if replatinizing is required.

Storage

Short term: Store conductivity cells in deionized or distilled water. Change the water frequently to prevent any growth that may cause electrode fouling.

Long term: Rinse thoroughly with deionized or distilled water and store dry. Any cell that has been stored dry should be soaked in distilled water until the electrodes appear black before use.

6.2 PLATINIZATION

The 3200 can be used to replatinize the electrodes of the cell. From Operation mode, press the [CELL] soft key, to enter the Cell menu, then, press the [PLATIN] soft key to enter the Platinize menu and display the following screen.

PLATINIZE			
[6] Min platinization time			
ENTER TO BEGIN PLATINIZATION			
UP	DOWN	DIGIT	

WARNING: Before replatinizing the electrodes of a cell, make sure that the cell is designed to have a platinum coating on the electrodes.

1. Clean the cell as described previously.

2. Use the [UP], [DOWN] and [DIGIT] soft keys to enter the platinization time required in minutes. Six minutes is usually sufficient for most electrodes.
3. Immerse the cell in the platinizing solution (YSI 3140). Make sure that both electrodes are submerged.
4. Press [ENTER] to start the platinization process. The following screen, showing the time remaining and the polarity of the polarization current, will be displayed.

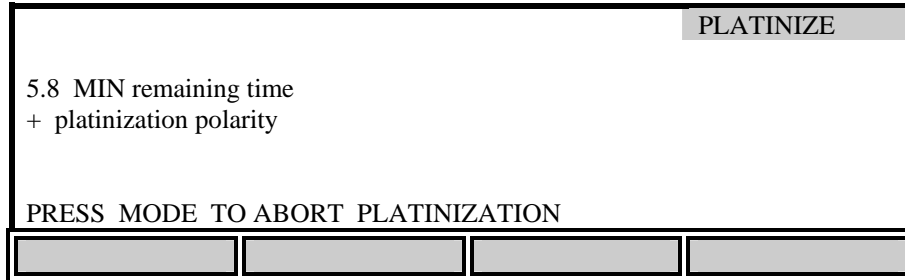

5. After the platinization process is complete, remove the cell from the platinizing solution. If you want to stop the platinization before the timer reaches zero, press the [MODE] key to abort.
6. Thoroughly rinse the cell with distilled or deionized water.
7. Promptly return the platinizing solution to its container.

SECTION 7 TROUBLESHOOTING

7.1 ERROR MESSAGES

The instrument performs a Power On Self Test each time it is turned on. The following error messages are provided to facilitate troubleshooting. They appear on the bottom line of the LCD when an error is detected.

TEMP OUT OF COMPENSATION RANGE

The unit is configured to use a non-linear temperature compensation curve (either measured or pre-stored). The current measurement temperature is outside the limits of the temperature compensation curve. i.e. a user records a temp compensation curve from 15 to 45°C. This error will be displayed if they then measure a sample below 15°C or above 45°C.

REF TEMP OUT OF RANGE

The unit is configured to use a non-linear temperature compensation curve (either measured or pre-stored). The current reference temperature is outside the limits of the temperature compensation curve. i.e. a user records a temp compensation curve from 15 to 45°C. This error will be displayed if they then set the reference temperature below 15°C or above 45°C.

NO TEMPERATURE INPUT

The system is configured to use a form of temperature compensation but no temperature probe is connected. To temperature compensate either a conductivity cell with integrated temperature probe or a separate temperature probe is required.

TEMPERATURE COMP OVERRUN

The current configuration along with current measured temperature has produced a temperature compensation of more than 5 times the reading (500%) or less than 1/10 the reading (10%). The instrument will not read correctly with temp comp beyond this range. Example: Compensation is set to 10.0%/°C at 0°C while the current temperature is 100°C.

OUT OF RANGE

In manual ranging mode. The currently selected conductance range is reading outside its limit.

ALARM! READINGS OUT OF LIMITS

This is NOT an error. The user has enabled the alarm and the current reading has triggered the alarm. See 3.5 Display Configuration, Alarms.

SECTION 8 PRINCIPLES OF OPERATION

8.1 RATIOMETRIC CONDUCTIVITY

The basic concept of microprocessor based ratiometric conductivity measurement is to place an unknown conductance and a known conductance in a series circuit with an AC voltage source, measure the voltage across each conductance and compute the value of the unknown. The object of conductivity measurement is to measure the resistive portion of the complex impedance of the cell. Measurement of AC voltage is done with a synchronous rectifier followed by an integrating A/D converter that is synchronized with the signal waveform. The phase reference for the synchronous rectifier can be selected to eliminate either series or parallel capacitance. Using the voltage across the reference resistor as the phase reference eliminates series capacitance, which is the dominant error source at high conductance. In this mode, the A/D only "sees" the portion of the cell voltage that is in phase with the current thus eliminating the series capacitance. Using the voltage across the cell as the phase reference can likewise eliminate parallel (cable) capacitance, which is the dominant error source in ultrapure water measurement. In this mode, the A/D only "sees" that portion of the voltage across the reference resistor that is caused by the in-phase cell current thus eliminating parallel capacitance.

8.2 CONDUCTIVITY PRINCIPLES

INTRODUCTION

Conductivity measurements are used in wastewater treatment, industry, pharmaceutical, and military etc. as a measurement of the purity or the condition of a process. Conductivity is used as a measurement of a solution's ability to conduct electric current. The ability of a solution to conduct electric current depends upon ions: their concentration, size, mobility, viscosity, valence and the temperature of the solution. Inorganic solutions are relatively good conductors. Organic solutions are poor conductors.

CONDUCTIVITY FUNDAMENTALS

Electrical **conductance (k)** is defined as the ratio of the current (I) in a conductor to the difference in the electrical potential (V) between its ends ($k=I/V$), measured in mhos or siemens (S). Conductance, therefore, is not a specific measurement. Its value is dependent upon the length of the conductor. **Conductivity (κ)**, or specific conductance, is the conductance per unit of conductor length. For our purposes, conductivity is defined as the conductance in mhos or siemens measured across the sides of a one-centimeter cube of liquid at a specified temperature.

Looking at our electrodes as sides of a cube, it becomes apparent that the conductance changes as the geometry of the cube changes. If the cube lengthens with respect to the area of the sides, then the conductance will decrease. If the area of the sides increases with respect to the distance between them, then the conductance will increase. The conductivity, however, will remain the same, regardless of the geometry, provided that the temperature and composition of the measured solution remain constant. A factor called the **cell constant (K)** relates conductivity to conductance. The cell constant is defined as the ratio of the **distance between the electrodes (d)** to the **area normal to the current flow (A)**:

$$\text{Cell Constant} = K = \frac{d}{A}$$

$$\kappa = k \times K$$

Therefore, conductivity equals conductance multiplied by the cell constant.

Example: For an observed conductance of 100 micro mhos (100 microsiemens) and a cell constant of 0.1/cm

$$\begin{aligned} \kappa &= k \times K \\ &= 100 \mu \text{ mho} \times 0.1 / \text{cm} \\ &= 10 \mu \text{ mho} / \text{cm} \end{aligned}$$

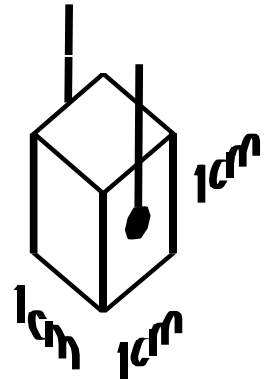

In SI units, the cell constant $K=0.1/\text{cm}$ would become $K=10/\text{m}$, and the same conductivity would be expressed:

$$\begin{aligned} \kappa &= k \times K \\ &= 100 \mu \text{ S} \times 10 / \text{m} \\ &= 1 \text{ mS} / \text{m} \end{aligned}$$

CELL CONSTANT

The **cell constant (K)** is used to determine the resistivity or conductivity of a solution. It is defined as the ratio of the **distance between electrode (d)** to the **area normal to the current flow (A)**. Cells with constants of 1.0/cm or greater normally have small, widely-spaced electrodes, while cells with constants or 0.1/cm

$K = 1.0/\text{cm}$

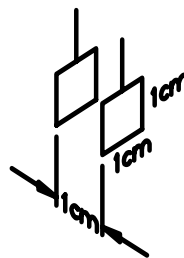

$K = 0.1/\text{cm}$

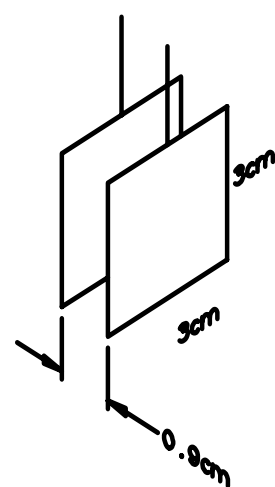

or less have larger electrodes that are closely-spaced.

CHOOSING A CONDUCTIVITY CELL

Decide which cell will be the most useful for your conditions by considering the conductivity of the solution you want to measure and the size of the sample.

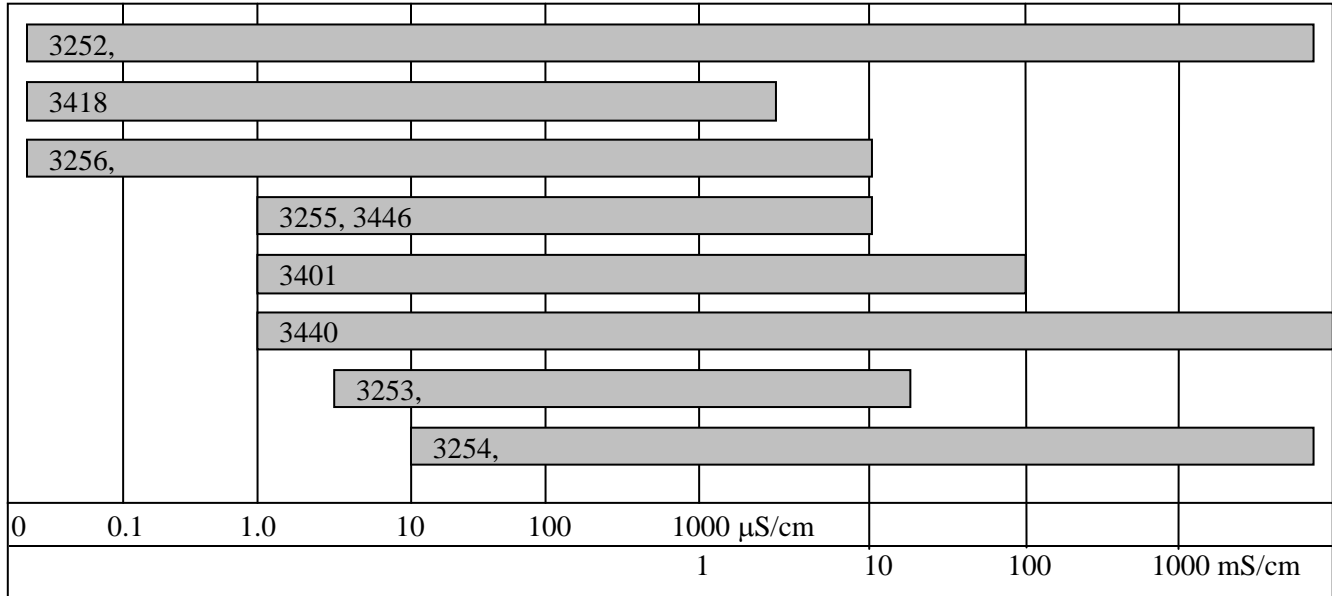

Conductivity

The chart above reflects general guidelines. Refer to cell specifications for details.

The multipoint calibration option on the YSI Model 3200 Conductivity Instrument gives greater flexibility and performance when using one cell over a wide conductivity range. This feature allows users to calibrate one cell with up to 5 different conductivity standard solutions. When analyzing a sample, the instrument selects the calibration value that is closest in conductivity to the sample.

3200 SERIES CONDUCTIVITY CELLS

Dip cells are generally used for routine conductivity measurements. The 3254 Fill Cell is designed for small sample or high throughput work. It requires only 5 ml of sample and can take measurements quickly from one sample to the next.

The 3255 Flow Cell is designed for in-line conductivity measurements, such as for ultrapure water systems.

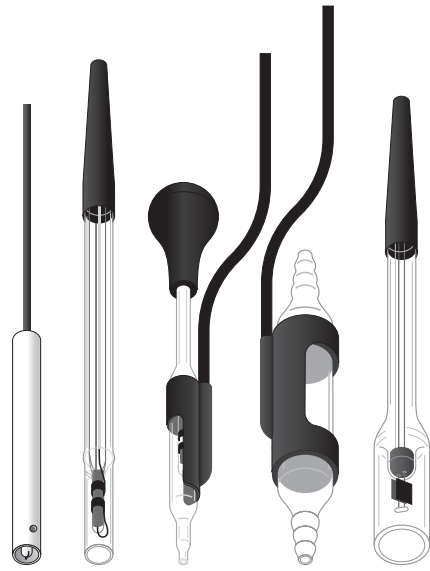

3252 3253 3254 3255 3256

CELL CONSTANT CALCULATION

YSI 3200 and 3400 Series conductivity cells are calibrated to $\pm 1\%$ of nominal by means of a YSI transfer standard traceable to OIML Recommendation 56 and NIST.

Anytime the condition of the conductivity cell changes, it is possible that the cell constant has also changed. Therefore, you should calibrate your system regularly (See section 3.2 Cell Calibration, Cal K). If you want to manually calculate your cell constant, measure the conductance of a standard solution and compare with the theoretical conductivity of the solution. The formula for determining the cell constant is:

$$K = \frac{\aleph}{k}$$

where **K** = cell constant in cgs metric units (cm^{-1})
k = measured conductance in $\mu\text{ mho}$
 \aleph = theoretical conductivity in $\mu\text{ mho/cm}$

The measured conductance (k) and conductivity (\aleph) must either be determined at the same temperature or corrected to the same temperature for the equation to be valid. One main reason for cell constant calibration is to increase overall system accuracy.

CONDUCTIVITY CELL CALIBRATION - SOME THINGS TO REMEMBER

1. Rinse the cell and solution container with some calibrator solution before calibration.
2. Prevent contamination of the solution.
3. Minimize evaporation of the solution.
4. Use adequate sample volume.
5. Purge all air from the cell.
6. Allow adequate time for temperature equilibration.
7. Stir the solution slowly.
8. Know the solution temperature accurately; a 1°C temperature error is approximately a 2% error in conductivity.
9. Insure sound electrical connection between the cell and the instrument.

CONDUCTIVITY LAW

SOLUTION CONDUCTIVITY		INSTRUMENT CONDUCTANCE		CELL CONSTANT
S/cm or mho/cm	=	S or mho	×	1/cm
mS/cm or mmho/cm	=	mS or mmho	×	1/cm
μS/cm or μmho/cm	=	μS or μmho	×	1/cm

$$\text{CELL CONSTANT} = \frac{\text{SOLUTION CONDUCTIVITY}}{\text{METER CONDUCTANCE}}$$

$$\text{METER CONDUCTANCE} = \frac{\text{SOLUTION CONDUCTIVITY}}{\text{CELL CONSTANT}}$$

LOW CONDUCTIVITY MEASUREMENTS

When measuring reagent grade water (deionized) or other substances having extremely low conductivity, it is recommended that a flow-through cell having a constant of 0.1/cm be used for the best accuracy. If a flow-through cell is not practical, then extraordinary precautions must be taken in regard to equipment setup, cell cleanliness, electrical interferences, etc. Therefore, when operating on this range, some instability in the least significant digit is normal and should be averaged or ignored.

Error Sources

- Solution temperature coefficient may be upwards of 7% per °C
- Absorption of atmospheric CO₂ may account for 1.3μS/cm at 25°C
- Platinization ions may leach into the solution from the electrodes
- Glass ions may leach into the solution from the cell or container
- Organic substances may leach into the solution if plastic is used
- Electrical noise
- Contact resistance
- Cable series resistance and shunt capacitance
- Cell series and shunt capacitance
- Galvanic effects

Only the first four are of major concern for typical measurements, although the user should also be careful to see that cells are clean and maintained in good condition at all times.

GENERAL CONDUCTIVITY MEASUREMENT PRECAUTIONS

After selecting the proper cell, **observe the following precautions** to ensure accurate, repeatable results:

1. The cell must be clean before making any measurements. When working with substances having low conductivity, extraordinary cleanliness may be required.
2. Soak cells that have been stored dry in deionized water before use.
3. Immerse the cell in the solution deep enough to submerge the vent hole.
4. The electrode chamber should be free of trapped air.
5. The cell should be at least ¼ inch away from any other object, including the walls or bottom of the solution container.
6. Stirring may be necessary for highest accuracy measurements, especially in low-conductivity solutions and to achieve good thermal equilibration.
7. If possible, isolate from ground potential the measurement container.
8. Electrical fields and stray currents caused by stirrer motors, heaters, etc., can interfere with measurements. The user should determine the effects of these and make the necessary corrections, either by shielding or by disconnecting those units that cause trouble.
9. Always handle the cell carefully.
10. Always rinse the cell carefully before transferring it from one solution to another.
11. Never store a dirty or contaminated cell.
12. The cells should not be submerged in aqua regia or any solution that might etch or dissolve gold.

PLATINIZATION

Platinum Black Inspection

The electrodes of YSI 3200 and 3400 Series conductivity cells are coated with platinum black during manufacturing. This coating is extremely important to cell operation, especially in solutions of high conductivity.

The cell should be inspected periodically. If the coating appears to be thin or if it is flaking off, the electrodes should be cleaned, as noted above, and replatinized. Properly maintained conductivity cells will perform for years without replatinizing.

Replatinizing

The 3200 can be used to replatinize a cell that utilizes electrodes coated with platinum. See section 6.2 Platinization. You will need a 2-oz bottle of platinizing solution (YSI 3140).

TEMPERATURE CORRECTION

By convention, the conductivity of a solution is the conductivity it exhibits at 25°C. The conductivity of electrolytic solutions varies with temperature, concentration, and composition. **The amount that the conductivity changes with temperature is expressed as a percent change in conductivity for each degree change in temperature (%/°C), which is called the**

temperature coefficient. In extreme cases, the temperature coefficient may have a value as high as 7%/°C. Each conductive ion has a different temperature coefficient.

When practical, control the temperature of the solution to be analyzed. For high precision work ($\pm 1\%$), maintain the temperature at $25^\circ\text{C} \pm 0.1^\circ\text{C}$. For routine lab work, $25^\circ\text{C} \pm 0.5^\circ\text{C}$ may be acceptable. (Ref: ASTM D1125-82 Standard Methods of Test for Electrical Conductivity of Water)

When sample temperature control is not practical, use temperature correction to determine the conductivity at 25°C . The temperature coefficient of your sample can be determined either from published data or from measurements of representative samples. This coefficient may then be applied to correct future measurements on samples of similar composition. If sample composition changes appreciably, the coefficient should be redetermined.

Once the temperature coefficient is known, the conductivity at 25°C can be manually determined from the following equation:

$$\kappa_{25} = \frac{\kappa_T}{1 + \alpha(T - 25)}$$

where **T** = temperature of sample
 κ_{25} = conductivity at 25°C
 κ_T = conductivity at measurement temperature **T**
 α = temperature coefficient of the conductivity solution

Prestored Temperature Compensation Curves

The YSI 3200 has two pre-stored non-linear temperature compensation curves, ultrapure water and natural water. These curves were obtained from the following references:

- Ultrapure water: Conductivity and Resistivity of Water from the Melting to Critical Points, Truman S. Light and Stuart L. Licht, Analytical Chemistry, 59, 2327.
- Natural water: Water quality - Method for the determination of electrical conductivity, BS EN 27888 : 1993.

Determining The Temperature Coefficient

You can manually determine the linear temperature correction coefficient of a solution by measuring its conductivity at different temperatures using the following equation:

$$\alpha = \frac{\kappa_T - \kappa_{25}}{\kappa_{25}(T - 25)}$$

where **T** = temperature of sample
 κ_{25} = conductivity at 25°C
 κ_T = conductivity at measurement temperature **T**
 α = temperature coefficient of the conductivity solution

SMALL SAMPLE MEASUREMENTS

It is not always possible to immerse the conductivity cell in a solution for measurements. If the quantity of solution is not sufficient for a proper measurement with a dip cell, a sample must be removed for assay. For this application, use the 3254 fill cell. This cell requires 5 ml of sample. Alternatively, any 3200 or 3400 Series cell, except the 3418, may be inverted and used as a fill cell.

The cell you use for small sample applications depends upon the quantity of solution available and the conductivity of the solution. The 3401 cell ($K=1.0/\text{cm}$) requires 15 ml, the 3256 and 3402 cells ($K=0.1/\text{cm}$) require 12 ml, the 3253 and 3403 cells ($K=1.0/\text{cm}$) require 3 ml, and the 3252 and 3417 cells ($K=1.0/\text{cm}$) require 1 ml of sample.

When a dip cell is used as a fill cell, the cell's vent hole is sealed and the electrode chamber is inverted and filled with solution, changing the cell constant (K). The cell will require calibration after being configured as a fill cell.

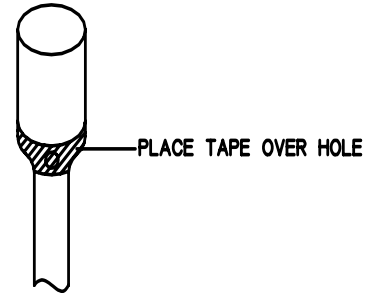

CONDUCTIVITY SYSTEM ACCURACY CONSIDERATIONS

System accuracy for conductivity measurements is equal to the sum of the errors contributed by the environment and the various components of the measurement setup. These include:

- **Instrument accuracy**
- **Cell-constant accuracy**
- **Temperature measurement accuracy**

Instrument Accuracy

YSI meters are very accurate; however, each instrument and range has its own accuracy statement and therefore, must be accounted for in the overall accuracy determination.

Cell-Constant Accuracy

YSI cells are warranted to be accurate to within one percent, for more accurate work you should calibrate the cell to determine the exact cell constant.

Temperature Accuracy

The solution temperature accuracy is the sum of the instrument accuracy plus the temperature probe accuracy.

If the conductivity is to be expressed at 25°C, some additional errors will be introduced either by the instrument's temperature correction electronics or by the mathematics used for the conversion to 25°C.

8.3 SALINITY

Salinity is determined automatically from the Model 3200 conductivity and temperature readings according to algorithms found in Standard Methods for the Examination of Water and Wastewater (ed. 1995). The use of the Practical Salinity Scale 1978 results in values which are unitless, since the measurements are carried out in reference to the conductivity of standard seawater at 15°C. However, the unitless salinity values are very close to those determined by the previously-used method where the mass of dissolved salts in a given mass of water (parts per thousand) was reported. Hence, the designation "ppt" is reported by the instrument to provide a more conventional output.

8.4 TOTAL DISSOLVED SOLIDS

Total dissolved solids (TDS) is determined automatically by the Model 3200 by multiplying conductivity by an empirical factor (Standard Methods for the Examination of Water and Wastewater ed. 1995). The factor may vary from 0.55 to 0.9, depending on the composition of the water and the temperature.

8.5 TEMPERATURE

The Model 3200 system utilizes a thermistor of sintered metallic oxide that changes predictably in resistance with temperature variation. The algorithm for conversion of resistance to temperature is built-in to the Model 3200 software, and accurate temperature readings in degrees Celsius or Fahrenheit are provided automatically. No calibration or maintenance of the temperature sensor is required.

8.6 SOURCES OF ERRORS

CELL CONTAMINATION

This error is usually due to contamination of the cell by some previous solution. Normally this is in the form of an organic film that reduces the solution-electrode interface conductance. Follow the cleaning instructions carefully.

An entirely different form of contamination sometimes occurs when cells are stored for long periods of time wet; alga and other life forms grow on the electrodes. While rare, such deposits have, on occasion, markedly reduced the effectiveness of the cell by reducing the solution-electrode interface conductance.

CELL PLATINIZING

Cells that have begun to lose their electrode coating of platinum black when measuring solutions having high conductivity values can introduce errors. The effect of poor platinization is a loss of linearity and a noticeably large change in conductance from range to range on the instrument.

When you suspect a problem with the cell platinization, follow the instructions for electrode inspection and replatinization carefully before attempting any critical measurements.

ELECTRICAL-NOISE ERRORS

Electrical noise can be a problem in any measurement range, but will contribute the most error and be the most difficult to eliminate when using the lowest conductance settings. The noise may be either line-conducted or radiated or both, and may require revised lead dress, grounding, shielding, or all three. Often, all that is necessary is to make sure that parallel leads are of equal length and twisted together.

CONTACT RESISTANCE

YSI 3200 series cells utilize a 4-wire connection virtually eliminating errors due to contact resistance.

When using the YSI 3232 cell adapter to connect a 2-wire cell (such as the YSI 3400 series cells), contact resistance can be a source of error when measuring high conductivity. Lugs should be clean and free of mechanical distortion. They should fit squarely on terminal posts that are properly tightened. Leads should also be inspected to verify that no physical damage has occurred that might degrade electrical contact.

CABLE SERIES RESISTANCE AND SHUNT CAPACITANCE

YSI 3200 series cells utilize a 4-wire connection virtually eliminating errors due to cable resistance.

The short cables provided as a part of regular cell assemblies will introduce negligible error in most measurements. However, if longer cables are required or if extraordinary accuracy is necessary, special precautions may be prudent.

When using the YSI 3232 cell adapter and a 2-wire cell (such as the YSI 3400 series cells) with solutions having very high conductivity values, a high cable resistance will become a major source of error unless accounted for. When working with solutions having very low conductivity values and long cables with large capacitance, such as might be used with a flow-through cells at remote locations, the large cable capacitance will become a major source of error.

GALVANIC AND MISCELLANEOUS EFFECTS

In addition to the error sources described above, there is another class of contributors that can be ignored for all but the most meticulous of laboratory measurements. These errors are always small and are generally completely masked by the error budget for cell-constant calibration, instrument accuracy, etc. Examples range from parasitic reactance associated with the solution container and its proximity to external objects to the minor galvanic effects resulting from oxide formation or deposition on electrodes. Only trial and error in the actual measurement environment can be suggested as an approach to reduce such errors. If the reading does not change as the setup is adjusted, errors due to such factors can be considered too small to see.

SECTION 9 WARRANTY AND REPAIR

YSI Model 3200 Instruments are warranted for two years from date of purchase by the end user against defects in materials and workmanship. YSI cells and cables are warranted for one year from date of purchase by the end user against defects in material and workmanship. Within the warranty period, YSI will repair or replace, at its sole discretion, free of charge, any product that YSI determines to be covered by this warranty.

To exercise this warranty, write or call your local YSI representative, or contact YSI Customer Service in Yellow Springs, Ohio. Send the product and proof of purchase, transportation prepaid, to the Authorized Service Center selected by YSI. Repair or replacement will be made and the product returned, transportation prepaid. Repaired or replaced products are warranted for the balance of the original warranty period, or at least 90 days from date of repair or replacement.

Limitation of Warranty

This Warranty does not apply to any YSI product damage or failure caused by (i) failure to install, operate or use the product in accordance with YSI's written instructions, (ii) abuse or misuse of the product, (iii) failure to maintain the product in accordance with YSI's written instructions or standard industry procedure, (iv) any improper repairs to the product, (v) use by you of defective or improper components or parts in servicing or repairing the product, or (vi) modification of the product in any way not expressly authorized by YSI.

THIS WARRANTY IS IN LIEU OF ALL OTHER WARRANTIES, EXPRESSED OR IMPLIED, INCLUDING ANY WARRANTY OF MERCHANTABILITY OR FITNESS FOR A PARTICULAR PURPOSE. YSI's LIABILITY UNDER THIS WARRANTY IS LIMITED TO REPAIR OR REPLACEMENT OF THE PRODUCT, AND THIS SHALL BE YOUR SOLE AND EXCLUSIVE REMEDY FOR ANY DEFECTIVE PRODUCT COVERED BY THIS WARRANTY. IN NO EVENT SHALL YSI BE LIABLE FOR ANY SPECIAL, INDIRECT, INCIDENTAL OR CONSEQUENTIAL DAMAGES RESULTING FROM ANY DEFECTIVE PRODUCT COVERED BY THIS WARRANTY.

AUTHORIZED U.S. SERVICE CENTERS

FOR THE NEAREST AUTHORIZED SERVICE CENTER, CONTACT:

YSI Technical Support • 1725 Brannum Lane • Yellow Springs, Ohio 45387

Phone: +1 (937) 767-7241 • (800) 897-4151 (US) • Fax: (937) 767-1058

Email: environmental@ysi.com • www.ysi.com

CLEANING INSTRUCTIONS

NOTE: Before they can be serviced, equipment exposed to biological, radioactive, or toxic materials must be cleaned and disinfected. Biological contamination is presumed for any instrument, probe, or other device that has been used with body fluids or tissues, or with wastewater. Radioactive contamination is presumed for any instrument, probe or other device that has been used near any radioactive source.

If an instrument, probe, or other part is returned or presented for service without a Cleaning Certificate, and if in our opinion it represents a potential biological or radioactive hazard, our service personnel reserve the right to withhold service until appropriate cleaning, decontamination, and certification has been completed. We will contact the sender for instructions as to the disposition of the equipment. Disposition costs will be the responsibility of the sender.

When service is required, either at the user's facility or at YSI, the following steps must be taken to insure the safety of our service personnel.

1. In a manner appropriate to each device, decontaminate all exposed surfaces, including any containers. 70% isopropyl alcohol or a solution of 1/4 cup bleach to 1-gallon tap water are suitable for most disinfecting. Instruments used with wastewater may be disinfected with .5% Lysol if this is more convenient to the user.
2. The user shall take normal precautions to prevent radioactive contamination and must use appropriate decontamination procedures should exposure occur.
3. If exposure has occurred, the customer must certify that decontamination has been accomplished and that no radioactivity is detectable by survey equipment.
4. Any product being returned to the YSI Repair Center, should be packed securely to prevent damage.
5. Cleaning must be completed and certified on any product before returning it to YSI.

PACKING INSTRUCTIONS

1. Clean and decontaminate items to insure the safety of the handler.
2. Complete and include the Cleaning Certificate.
3. Place the product in a plastic bag to keep out dirt and packing material.
4. Use a large carton, preferably the original, and surround the product completely with packing material.
5. Insure for the replacement value of the product.

Cleaning Certificate

Organization _____

Department _____

Address _____

City _____ State _____ Zip _____

Country _____ Phone _____

Model No. of Device _____ Lot Number _____

Contaminant (if known) _____

Cleaning Agent(s) used _____

Radioactive Decontamination Certified?

(Answer only if there has been radioactive exposure) ___ Yes ___ No

Cleaning Certified By _____

Name

Date

9.1 SOFTWARE UPGRADE PROCEDURE

If necessary, the YSI Model 3200's software can be upgraded using a computer with a serial port. All that is needed is any standard communications software, new 3200 software and a straight RS232 serial cable (not a null modem cable). The 3200 has a female DB-9 connector. A 9 to 25 pin adapter will also be needed if the computer has a 25 pin serial port. The instructions are as follows:

1. Connect the 3200 to your computer serial port using a straight RS232 cable.
2. Insert the software update disk into the appropriate drive (usually A: or B:).
3. Start your communications program (such as ProComm™ or Windows™ terminal).
4. Set your communications parameters (in the communications software on the computer) to the following:

Baud Rate: 9600

Data Length: 8 bits

Parity: None

Stop Bits: 1

NOTE: Make sure the COM port matches the one that the 3200 is connected to.

5. Turn the 3200 on and quickly press [ESC] on the computer keyboard.

The 3200 screen should go blank, the computer screen should display:

"Press (ESC) to cancel application"

"3200 Bootware ver 1.1"

"\$"

6. On the computer keyboard, type "LOAD" then press [ENTER].

The computer screen should display:

"MFG = 0089 Device = 4470"

"Erase ROM(Yes/No/Abort)?"

7. On the computer keyboard, type "Y".

After 2 or 3 seconds, the computer screen should display "Load File:"

8. Enter your communications program command to "Upload File" (such as the PageUp key in ProComm™ or "Send text file" in Windows™ terminal. If you are prompted for a protocol, select "ASCII".

9. When prompted for the file name, enter "A:3200A1.HEX" or "B: 3200A1.HEX" (depending on the drive you placed the disk in). **NOTE:** The file name may vary.

Letters/numbers (hex) should count up on the computer screen and it may display:

"SENDING: M3200A1.HEX"

After the file is finished (a few minutes), the computer will beep and the \$ sign will appear on the screen again.

1. Unplug the 3200's power plug and RS 232 cable. After 5 seconds, reconnect the power plug and turn the instrument on for normal operation.

NOTE: If anything goes wrong (garbage all over the computer screen), turn off the 3200 (by unplugging the power supply from the back of the instrument) and start again.

9.2 DISASSEMBLY/ASSEMBLY PROCEDURES

Place the instrument face down on a padded surface for all procedures below.

Case Disassembly

- While applying slight separation force to the front, curved edge of the case near one corner, use a small straight-blade screwdriver to release the snap (A) on the same side.
- When that snap releases, keep applying the separation force, and use the screwdriver to release the front snap (B) nearest the same corner.
- Repeat the procedure on the other corner to release both front and both side snaps.
- Swing the case open slowly, pivoting on the three rear snaps (C) until they release.
- Lay the lower case assembly to the side.

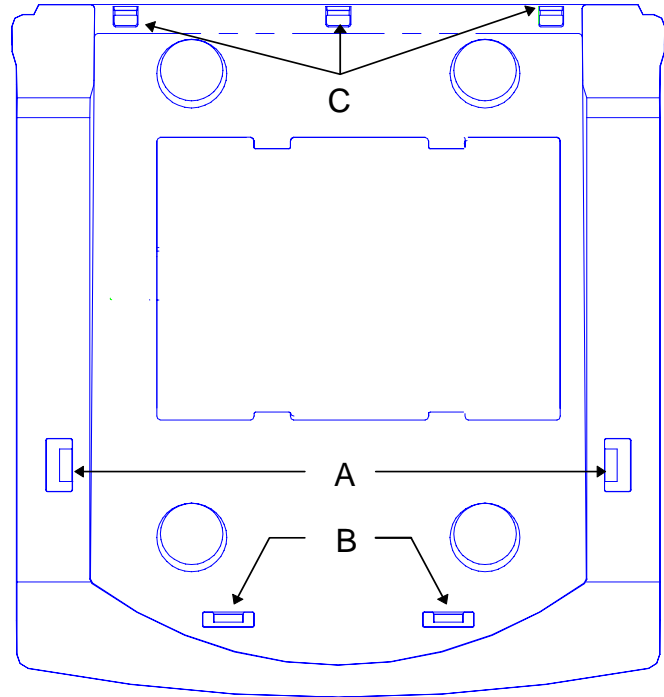

PC Board Removal

- Gently release the two snaps nearest the front, curved edge of the unit.
- With the snaps released, lift the front of the board slightly and slide the board out of the rear connector openings.

PC Board Re-installation

- Remove the protective covering from the display. **DO NOT TOUCH THE FACE OF THE DISPLAY, FINGERPRINTS CANNOT BE EASILY REMOVED.**
- Slip the connector end of the board into place against the gaskets at the rear of the case, then rotate the board down into position, engaging each snap as you go. Be sure that the switch extenders line up with the switches.
- Inspect the assembly to insure that all board snaps are fully engaged and the board is in the proper position in the case. Turn the assembly over and activate each switch. Be sure you can hear and feel each switch click as it is pressed.

Case Re-assembly

- Hook the three snaps at the rear of the case into place and rotate the lower case into place on the upper case. Make sure all four snaps are fully engaged. Press firmly down on the three rear snaps to make sure they are completely engaged.

9.3 TEST AND VERIFICATION PROCEDURE

Connect the YSI Model 3200 as shown in the Test and Verification Figure and follow the charts below to verify its accuracy.

Equipment Required:

If using the YSI 3166 Precision Calibrator Set to simulate conductance, a YSI 3232 adapter is required for proper connection to the cell connector. When using the 3232 adapter, temperature can only be accessed via the EXT. TEMP connector which requires a .25" three conductor phone plug.

If a decade resistance box is used to simulate conductance and temperature, a YSI #003229 cable is required for connection to the cell connector.

Important Notes:

1. Temperature compensation must be turned off.
2. Put the 3200 in manual range mode.
3. Set the units to conductance and/or resistance.
4. The 3200 has no internal calibration. Opening the case should only be attempted by a qualified service technician or permanent damage may result.

Resistance/Conductance Verification

Resistance Input @ Cell Connector	3200 Range	Displayed Resistance	Displayed Conductance
1.000 $\Omega \pm 0.5\%$	3.00 S *	1.000 $\pm .025 \Omega$	1.00 $\pm .04$ S
10.00 $\Omega \pm 0.2\%$	999.9 mS *	10.00 $\pm .119 \Omega$	100.0 ± 3.2 mS
100.00 $\Omega \pm 0.1\%$	99.99 mS	100.0 $\pm 1.09 \Omega$	10.00 $\pm .11$ mS
1000.0 $\Omega \pm 0.1\%$	9999 μ S	1.000 $\pm .011$ K Ω	1000 ± 11 μ S
10.0 K $\Omega \pm 0.1\%$	999.9 μ S	10.00 $\pm .11$ K Ω	100.0 ± 1.1 μ S
100.0 K $\Omega \pm 0.1\%$	99.99 μ S	100.0 ± 2.1 K Ω	10.00 $\pm .11$ μ S
1.000 M $\Omega \pm 0.1\%$	9.999 μ S	1.00 $\pm .05$ M Ω	1.000 $\pm .021$ μ S

* No manual range change required. Instrument will display in correct range based on resistance input value.

Temperature Verification

Temperature	Cell Connector Pin 1 & 2 Input Resistance **	EX. TEMP Connector Input Resistance **	Displayed Temperature
0 °C	32660 $\Omega \pm .25\%$	19600 $\Omega \pm .25\%$	0.00 $\pm .15$ °C
25 °C	10000 $\Omega \pm .25\%$	6000 $\Omega \pm .25\%$	25.00 $\pm .15$ °C
40 °C	5329 $\Omega \pm .25\%$	3197 $\Omega \pm .25\%$	40.00 $\pm .15$ °C
70 °C	1752 $\Omega \pm .25\%$	1051 $\Omega \pm .25\%$	70.00 $\pm .20$ °C
100 °C	678.5 $\Omega \pm .25\%$	407.1 $\Omega \pm .25\%$	100.00 $\pm .20$ °C

** Input temperature resistances either via the EXT. TEMP connector or via pins 1 & 2 of the mini DIN connector, not both. See the following figure, Test and Verification.

Test and Verification Figure

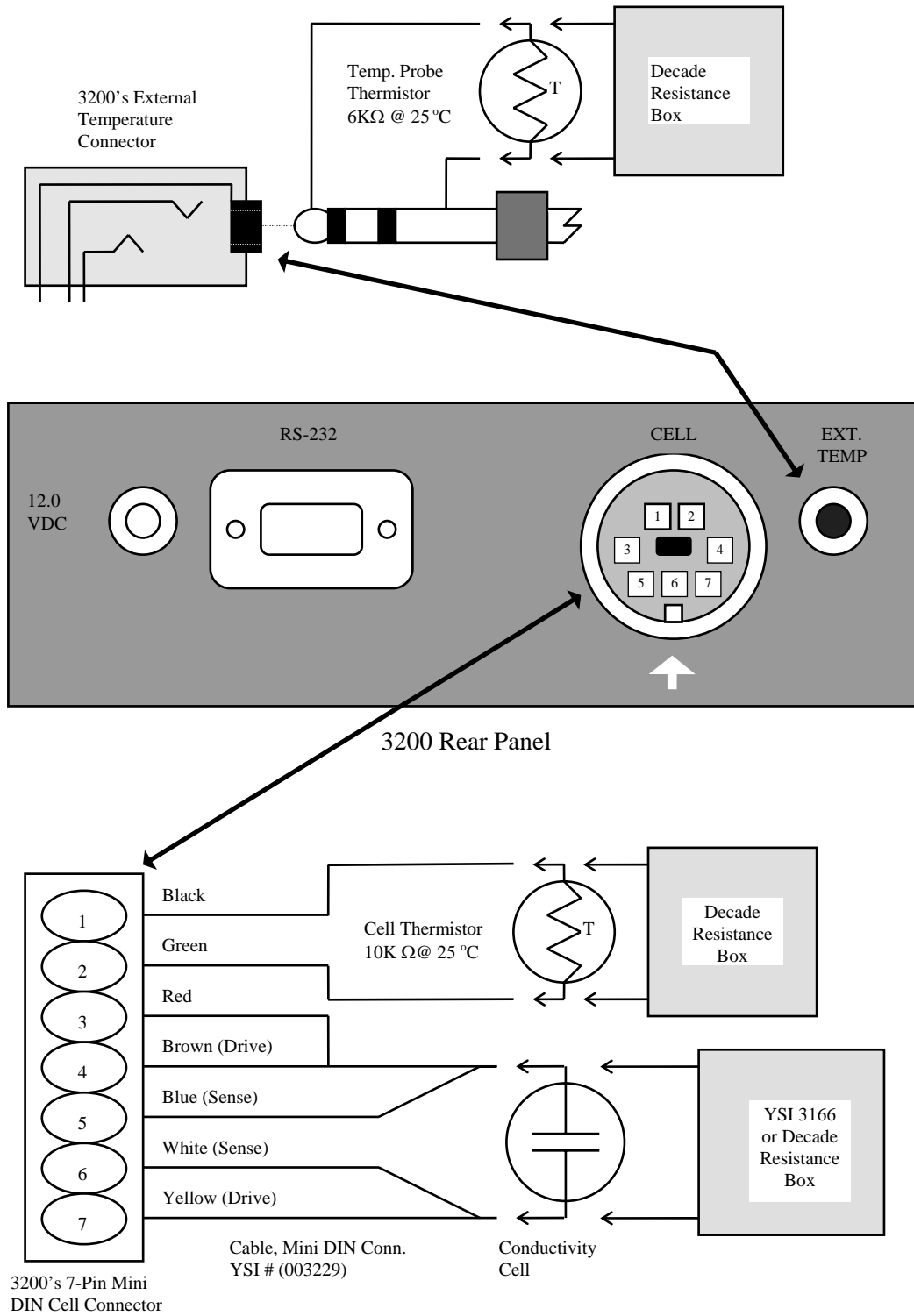

SECTION 10 ACCESSORIES AND REPLACEMENT PARTS

YSI Item #	Description	Comments
3208	Power Supply, 115 VAC	
3209	Power Supply, 240 VAC	
003213	Overlay, Window	
051016	Overlay, Keypad	
051009	Window	
111215	Board Assy, PC, Main	
111021	Display Assy	
111012	Case Assy, Upper	
111027	Case Assy, Lower	Includes 003226 weight
003226	Weight, SS	
051043	Foot, Rubber, Self-Stick	
032061	Gasket, Connector, Cell	
032062	Gasket, Connector, Ext. Temp.	
032063	Gasket, Connector, Power	
032064	Gasket, Connector, RS232	
051025	Standoff, .25, Snap-In	Retain display
003228	Extension, Switch	
003224	Operations Manual	
052021	RS232 Cable, DB9	For computer
003229	Cable Assy, Cell	7-pin mini DIN to pigtail
3232	Cell adapter	For YSI 3400 Series cells
3166	Calibrator resistor set	Requires 3232 cell adapter

10.1 YSI CONDUCTIVITY CELLS

YSI 3200 series conductivity cells have a built in temperature sensor for automatic temperature compensation. Dip, fill and flow-through conductivity cells are available, each utilizing platinized platinum iridium electrodes. These cells have the following specifications:

Part Number	cgs Cell Constant	SI Cell Constant	Material	Overall Length	O.D.	Chamber I.D.	Chamber Depth
3200 Series Dip Cells							
3252	1.0/cm	100/m	ABS plastic	146 mm	13 mm	10 mm	20 mm
3253	1.0/cm	100/m	glass	178 mm	13 mm	10 mm	51 mm
3256	0.1/cm	10/m	glass	159 mm	25 mm	21 mm	52 mm
3200 Series Fill Cell							
3254	1.0/cm	100/m	glass	135 mm	19 mm	11 mm	83 mm
3200 Series Flow-Through Cell							
3255	0.1/cm	10/m	glass	146 mm	25 mm	21 mm	76 mm

YSI also offers 3400 series cells which do not contain temperature sensors. Several dip and flow-through conductivity cells are available, each utilizing platinized platinum iridium electrodes, except the YSI 3418, which has platinized nickel electrodes. **These cells require the 3232 adapter and a 3220 or 700 series temperature probe for use with the YSI 3200.** These cells have the following specifications:

Part Number	cgs Cell Constant	SI Cell Constant	Material	Overall Length	O.D.	Chamber I.D.	Chamber Depth
3400 Series Dip Cells							
3401	1.0/cm	100/m	Pyrex 7740	191 mm	25 mm	21 mm	76 mm
3402	0.1/cm	10/m	Pyrex 7740	159 mm	25 mm	21 mm	52 mm
3403	1.0/cm	100/m	Pyrex 7740	178 mm	13 mm	10 mm	51 mm
3417	1.0/cm	100/m	ABS Plastic	146 mm	13 mm	10 mm	20 mm
3418	0.1/cm	10/m	ABS Plastic	159 mm	13 mm	10 mm	30 mm
3440	10.0/cm	1000/m	Pyrex 7740	203 mm	13 mm	2 mm	86 mm
3400 Series Flow-Through Cells							
3445	1.0/cm	100/m	Pyrex 7740	146 mm	19 mm	10 mm	76 mm
3446	0.1/cm	10/m	Pyrex 7740	146 mm	25 mm	21 mm	76 mm

The nominal volumes of the cells are 15 ml for the YSI 3445 and 30 ml for the YSI 3255 and 3446 and 5 ml for the YSI 3254.

10.2 STANDARD CALIBRATOR SOLUTIONS

YSI manufactures NIST-traceable conductivity calibrator solutions for calibration purposes. The following conductivity calibrator solutions are available from YSI.

Part Number	Size	Conductivity at 25.00°C
3161	1 quart	1,000 μ mho/cm \pm 0.50%
3163	1 quart	10,000 μ mho/cm \pm 0.25%
3165	1 quart	100,000 μ mho/cm \pm 0.25%
3167	8 pints	1,000 μ mho/cm \pm 1.0%
3168	8 pints	10,000 μ mho/cm \pm 1.0%
3169	8 pints	50,000 μ mho/cm \pm 1.0%

APPENDIX A - SPECIFICATIONS

Modes
 Conductivity
 Conductance
 Resistivity
 Resistance
 Salinity
 TDS
 Temperature

Conductance	Range	Accuracy	Resolution	Frequency
	0 - 0.9999 μ S	$\pm 0.30\%$ full scale	0.0001 μ S	40 Hz
	0.950 - 9.999 μ S	$\pm 0.20\%$ full scale	0.001 μ S	80 Hz
	9.50 μ S - 99.99 μ S	$\pm 0.10\%$ full scale	0.01 μ S	290 Hz
	95.0 - 999.9 μ S	$\pm 0.10\%$ full scale	0.1 μ S	1010 Hz
	950 - 9999 μ S	$\pm 0.10\%$ full scale	1 μ S	1010 Hz
	9.50 - 99.99 mS	$\pm 0.10\%$ full scale	0.01 mS	1010 Hz
	95.0 - 999.9 mS	$\pm 0.30\%$ full scale	0.1 mS	1460 Hz
	0.95 - 3.00 S	$\pm 1.0\%$ full scale	0.01 S	1460 Hz

Resistance	Range	Accuracy	Resolution	Frequency
	0 - 9.999 Ω	$\pm 0.2\%$ full scale	0.001 Ω	1460 Hz
	0 - 99.99 Ω	$\pm 0.1\%$ full scale	0.01 Ω	1460 Hz
	0 - 999.9 Ω	$\pm 0.1\%$ full scale	0.1 Ω	1010 Hz
	0 - 9.999 k Ω	$\pm 0.1\%$ full scale	0.001 k Ω	1010 Hz
	0 - 99.99 k Ω	$\pm 0.1\%$ full scale	0.01 k Ω	1010 Hz
	100.0 - 999.9 k Ω	$\pm 0.2\%$ full scale	0.1 k Ω	290 Hz
	1.00 - 9.99 M Ω	$\pm 0.5\%$ full scale	0.01 M Ω	80 Hz
	10.0 - 29.9 M Ω	$\pm 1\%$ full scale	0.1 M Ω	40 Hz

Salinity	Range	Accuracy	Resolution
	0-80 ppt (NaCl)	± 1 ppt	0.1 ppt

TDS	Range	Accuracy	Resolution
	0-19,999 mg/L	0.50%	1 mg/L

Temperature	Range	Accuracy	Resolution
	-5 - 100 $^{\circ}$ C	$\pm 0.1^{\circ}$ C	0.01 $^{\circ}$ C

Temperature Compensation	Method Ref. temp., °C Temp. Coef.	Linear, nonlinear 0 - 100 0 - 10%/°C, nonlinear
Cell Information Storage		6 Configurations
Data Storage		100 points
Cell constant, cm⁻¹		0.001 - 100
Calibration		Multipoint, up to 5 points
Outputs		RS232
Alarm		Yes
Clock		Yes
Display		Graphic LCD
Cell connector		7 pin Mini Din
Platinizing capability		Included
Power		AC, 115V, 220V
Approvals		UL, CSA, CE
Environmental requirements		95% RH non-cond
Size		9 x 9.5 x 4.4 inches 22.9 x 24.1 x 11.2 cm
Weight		2.6 pounds 1.1 kg

APPENDIX B REQUIRED NOTICE

This equipment generates and uses radio frequency energy and if not installed and used properly, may cause interference to radio and television reception. There is no guarantee that interference will not occur in a particular installation. If this equipment does cause interference to radio or television reception, which can be determined by turning the equipment off and on, the user is encouraged to try to correct the interference by one or more of the following measures:

- Reorient the receiving antenna
- Relocate the computer with respect to the receiver
- Move the computer away from the receiver
- Plug the computer into a different outlet so that the computer and receiver are on different branch circuits.

If necessary, the user should consult the dealer or an experienced radio/television technician for additional suggestions. The user may find the following booklet, prepared by the Federal Communications Commission, helpful: "How to Identify and Resolve Radio-TV Interference Problems." This booklet is available from the U.S. Government Printing Office, Washington, DC 20402, Stock No. 0004-000-00345-4.

APPENDIX C - RS232 CONNECTIONS

Serial Printer Connection

To connect to a serial printer, use a 9-pin male to 25 pin male cable.

<u>3200: 9 pin d-sub (male)</u>	<u>Printer: 25 pin d-sub (male)</u>
pin 2	pin 2
pin 5	pin 7

NOTE: Only two connections are required for a serial printer.

The following printer, manufactured by Nippon Primex Co., Ltd., has been tested for use with the YSI 3200:

NP-104-RBR120 Printer with batteries and power supply
NP-104-S-RNR Printer without batteries

Serial Computer Connection

A standard straight (NOT a null modem) cable is required for connecting to a computer RS232 serial port. The 3200 requires a male DB9 connector.

<u>3200: 9 pin d-sub (male)</u>	<u>Computer: 9 pin d-sub</u>	<u>Computer: 25 pin d-sub</u>
pin 2	pin 2	pin 3
pin 3	pin 3	pin 2
pin 5	pin 5	pin 7

NOTE: Only three connections are required for a computer.

APPENDIX D TEMPERATURE CORRECTION DATA FOR TYPICAL SOLUTIONS

A. Potassium Chloride ** (KCl)

Concentration: 1 mole/liter			Concentration: 1 x 10 ⁻¹ mole/liter		
C	mS/cm	%/ C (to 25 C)	C	mS/cm	%/ C (to 25 C)
0	65.10	1.67	0	7.13	1.78
5	73.89	1.70	5	8.22	1.80
10	82.97	1.72	10	9.34	1.83
15	92.33	1.75	15	10.48	1.85
20	101.97	1.77	20	11.65	1.88
25	111.90	1.80	25	12.86	1.90
			30	14.10	1.93
			35	15.38	1.96
			37.5	16.04	1.98
			40	16.70	1.99
			45	18.05	2.02
			50	19.43	2.04

Concentration: 1 x 10 ⁻² mole/liter			Concentration: 1 x 10 ⁻³ mole/liter		
C	mS/cm	%/ C (to 25 C)	C	mS/cm	%/ C (to 25 C)
0	0.773	1.81	0	0.080	1.84
5	0.892	1.84	5	0.092	1.88
10	1.015	1.87	10	0.105	1.92
15	1.143	1.90	15	0.119	1.96
20	1.275	1.93	20	0.133	1.99
25	1.412	1.96	25	0.147	2.02
30	1.553	1.99	30	0.162	2.05
35	1.697	2.02	35	0.178	2.07
37.5	1.771	2.03	37.5	0.186	2.08
40	1.845	2.05	40	0.194	2.09
45	1.997	2.07	45	0.210	2.11
50	2.151	2.09	50	0.226	2.13

** Charts developed by interpolating data from International Critical Tables, Vol. 6, pp. 229-253, McGraw-Hill Book Co., NY.

B. Sodium Chloride* (NaCl)

Saturated solutions at all temperatures			Concentration: 0.5 mole/liter		
C	mS/cm	%/ C (to 25 C)	C	mS/cm	%/ C (to 25 C)
0	134.50	1.86	0	25.90	1.78
5	155.55	1.91	5	29.64	1.82
10	177.90	1.95	10	33.61	1.86
15	201.40	1.99	15	37.79	1.90
20	225.92	2.02	20	42.14	1.93
25	251.30	2.05	25	46.65	1.96
30	277.40	2.08	30	51.28	1.99
			35	56.01	2.01
			37.5	58.40	2.02
			40	60.81	2.02
			45	65.65	2.04
			50	70.50	2.05

Concentration: 1×10^{-1} mole/liter			Concentration: 1×10^{-2} mole/liter		
C	mS/cm	%/ C (to 25 C)	C	mS/cm	%/ C (to 25 C)
0	5.77	1.83	0	0.632	1.87
5	6.65	1.88	5	0.731	1.92
10	7.58	1.92	10	0.836	1.97
15	8.57	1.96	15	0.948	2.01
20	9.60	1.99	20	1.064	2.05
25	10.66	2.02	25	1.186	2.09
30	11.75	2.04	30	1.312	2.12
35	12.86	2.06	35	1.442	2.16
37.5	13.42	2.07	37.5	1.508	2.17
40	13.99	2.08	40	1.575	2.19
45	15.14	2.10	45	1.711	2.21
50	16.30	2.12	50	1.850	2.24

Concentration: 1×10^{-3} mole/liter		
C	mS/cm	%/ C (to 25 C)
0	0.066	1.88
5	0.076	1.93
10	0.087	1.98
15	0.099	2.02
20	0.111	2.07
25	0.124	2.11
30	0.137	2.15
35	0.151	2.19
37.5	0.158	2.20
40	0.165	2.22
45	0.180	2.25
50	0.195	2.29

* Charts developed by interpolating data from the CRC Handbook of Chemistry and Physics, 42nd ed., p. 2606, The Chemical Rubber Company, Cleveland.

C. Lithium Chloride* (LiCl)

Concentration: 1 mole/liter			Concentration: 1×10^{-1} mole/liter		
C	mS/cm	%/ C (to 25 C)	C	mS/cm	%/ C (to 25 C)
0	39.85	1.82	0	5.07	1.87
5	46.01	1.85	5	5.98	1.85
10	52.42	1.89	10	6.87	1.85
15	59.07	1.92	15	7.75	1.85
20	65.97	1.95	20	8.62	1.85
25	73.10	1.98	25	9.50	1.86
30	80.47	2.02	30	10.40	1.88
35	88.08	2.05	35	11.31	1.91
37.5	91.97	2.07	37.5	11.78	1.92
40	95.92	2.08	40	12.26	1.94
45	103.99	2.11	45	13.26	1.98
50	112.30	2.15	50	14.30	2.02

Concentration: 1×10^{-2} mole/liter			Concentration: 1×10^{-3} mole/liter		
C	mS/cm	%/ C (to 25 C)	C	mS/cm	%/ C (to 25 C)
0	0.567	1.88	0	0.059	1.93
5	0.659	1.92	5	0.068	2.03
10	0.755	1.96	10	0.078	2.12
15	0.856	2.00	15	0.089	2.19
20	0.961	2.04	20	0.101	2.25
25	1.070	2.08	25	0.114	2.28
30	1.183	2.12	30	0.127	2.31
35	1.301	2.16	35	0.140	2.32
37.5	1.362	2.18	37.5	0.147	2.32
40	1.423	2.20	40	0.154	2.31
45	1.549	2.24	45	0.166	2.29
50	1.680	2.28	50	0.178	2.25

D. Potassium Nitrate (KNO₃)**

Concentration: 1×10^{-1} mole/liter			Concentration: 1×10^{-2} mole/liter		
C	mS/cm	%/ C (to 25 C)	C	mS/cm	%/ C (to 25 C)
0	6.68	1.78	0	0.756	1.77
5	7.71	1.79	5	0.868	1.80
10	8.75	1.81	10	0.984	1.83
15	9.81	1.83	15	1.105	1.86
20	10.90	1.85	20	1.229	1.88
25	12.01	1.87	25	1.357	1.90
30	13.15	1.90	30	1.488	1.93
35	14.32	1.92	35	1.622	1.95
37.5	14.92	1.94	37.5	1.690	1.96
40	15.52	1.95	40	1.759	1.97
45	16.75	1.97	45	1.898	1.99
50	18.00	2.00	50	2.040	2.01

* Charts developed by interpolating data from the CRC Handbook of Chemistry and Physics, 42nd ed., p. 2606, The Chemical Rubber Company, Cleveland.

** Charts developed by interpolating data from International Critical Tables, Vol. 6, pp. 229-253, McGraw-Hill Book Co., NY.

E. Ammonium Chloride* (NH₄Cl)

Concentration: 1 mole/liter			Concentration: 1 x 10 ⁻¹ mole/liter		
C	mS/cm	%/ C (to 25 °C)	C	mS/cm	%/ C (to 25 °C)
0	64.10	1.60	0	6.96	1.82
5	74.36	1.53	5	7.98	1.88
10	83.77	1.45	10	9.09	1.93
15	92.35	1.37	15	10.27	1.97
20	100.10	1.29	20	11.50	2.00
25	107.00	1.21	25	12.78	2.03
			30	14.09	2.06
			35	15.43	2.07
			37.5	16.10	2.08
			40	16.78	2.08
			45	18.12	2.09
			50	19.45	2.09

Concentration: 1 x 10 ⁻² mole/liter			Concentration: 1 x 10 ⁻³ mole/liter		
C	mS/cm	%/ C (to 25 °C)	C	mS/cm	%/ C (to 25 °C)
0	0.764	1.84	0	0.078	1.88
5	0.889	1.86	5	0.092	1.90
10	1.015	1.88	10	0.105	1.91
15	1.144	1.91	15	0.119	1.93
20	1.277	1.94	20	0.133	1.95
25	1.414	1.97	25	0.148	1.98
30	1.557	2.02	30	0.162	2.01
35	1.706	2.06	35	0.178	2.04
37.5	1.782	2.08	37.5	0.186	2.06
40	1.860	2.10	40	0.194	2.07
45	2.020	2.14	45	0.210	2.11
50	2.186	2.18	50	0.227	2.15

* Charts developed by interpolating data from the CRC Handbook of Chemistry and Physics, 42nd ed., p. 2606, The Chemical Rubber Company, Cleveland.

APPENDIX E - CONVERSION FACTORS

TO CONVERT FROM	TO	EQUATION
mhos	Siemens	Multiply by 1
mhos	ohms	1/mho
ohms	mhos	1/ohm
Feet	Meters	Multiply by 0.3048
Meters	Feet	Multiply by 3.2808399
Degrees Celsius	Degrees Fahrenheit	$9/5 (°C)+32$
Degrees Fahrenheit	Degrees Celsius	$5/9 (°F-32)$

Units of Measure

MEASUREMENT	UNITS	SYMBOLS
RESISTANCE	OHM	Ω
CONDUCTANCE	SIEMENS	S
CONDUCTANCE	1 / RESISTANCE	$1 / \Omega$
CONDUCTIVITY	SIEMENS / METER	S / m
CELL CONSTANT	1 / cm or 1 / m	or MHO / CENTIMETER

Calculate conductivity by multiplying the measured conductance in mhos or siemens by the appropriate cell constant (K), observing the dimensions of the constant.

RESISTIVITY OF CONDUCTIVITY SOLUTIONS

100,000	$\mu\text{S/cm}$	=	10	ohm cm
50,000	$\mu\text{S/cm}$	=	20	ohm cm
10,000	$\mu\text{S/cm}$	=	100	ohm cm
1,000	$\mu\text{S/cm}$	=	1000	ohm cm

APPENDIX F - GLOSSARY OF TERMS

ampere (A) - SI unit of electric current; one coulomb per second.

amplitude - The maximum deviation of an alternating current from its average value during its cycle.

ASTM - American Society for Testing and Materials

calibrate - To determine, check, or rectify the graduation of any instrument giving quantitative measurements.

calibrator solution - A solution of known value used to calibrate.

capacitance (C) - The ratio of the total charge on an isolated conductor to its potential; the property of being able to collect a charge of electricity. $C = Q/V$.

capacitor - An electrical component able to accumulate and hold an electric charge.

cell constant (K) - The ratio of the distance between two electrodes to the area normal to the current flow. $K=d/A$.

cgs - Abbreviation for the centimeter-gram-second system of metric units. Mostly superseded by SI units.

conductance (k) - The ratio of the current in a conductor to the potential difference between its ends; the ability of a conductor to transmit current; the reciprocal of resistance. The SI unit is siemens (S), also measured in mhos.

conductivity (ℳ) - The ratio of the current density in a conductor to the electric field causing the current to flow; the inverse of resistivity; the conductance between opposite faces of a cube of the measured material of 1 cm (cgs units) or 1 m (SI units) edge. Measured in mho/cm (cgs units) or S/m (SI units)

conductivity cell - Any cell with electrodes used to measure the conductivity of liquid.

coulomb - The quantity of electric charge which flowing by any point in one second produces a current of one ampere.

current (I) - The rate of flow of an electric charge, usually expressed in amperes.

electrode - A conductor whereby an electric current enters or leaves a liquid, gas, or vacuum.

ion - Any atom or molecule that has an electric charge due to the loss or gain of valence electrons.

mks - Abbreviation for the meter-kilogram-second system of metric units.

mho - A unit of conductance; the reciprocal of an ohm.

micro (μ) - The metric prefix indicating 10^{-6} .

milli (m) - The metric prefix indicating 10^{-3} .

NIST - National Institute of Standards and Technology. The US government agency that defines measurement standards in the United States.

ohm (Ω) - SI unit of resistance

OIML - Organisation Internationale de Métrologie Légale is a treaty organization for the harmonization of practical applications of measurement standards.

platinum black - Platinum precipitated from a solution of the (IV) chloride by reducing agents. A velvety-black powder.

polarization - The separation of the positive and negative charges of a molecule by an external agent.

Pyrex - A trademark name for heat-resistant and chemical-resistant glass.

reference voltage - A closely controlled d.c. or a.c. voltage used as a reference.

replatinize - To deposit a new layer of platinum black on an electrode.

resistance (R) - Opposition to the passage of current that causes electrical energy to be transformed into heat.

resistivity - An intrinsic property of a conductor, which gives the resistance in terms of its dimensions; the resistance between opposite faces of a one-centimeter cube of a given material; the inverse of conductivity.

SI - Système International is the international system of units.

siemens (S) - SI unit of electrical conductance; the reciprocal of an ohm; equivalent to a mho.

temperature correction - An adjustment made to a measurement to compensate for the difference between the measured and nominal temperatures.

temperature coefficient - The change in any particular physical quantity per degree change in temperature.

voltage - Electromotive force or potential expressed in volts.

YSI incorporated



1700/1725 Brannum Lane
Yellow Springs, Ohio 45387 USA
(800) 765-4974 • (937) 767-7241
FAX (937) 767-9353
Email: environmental@ysi.com
Website: www.YSI.com

ITEM # 003224 – Web
DRW # A03224
Revision F
April 1999