



Front Surround System
ESB-1090
Owner's Manual

To use the unit safely and correctly, be sure to read this guide with "ESB-1090 Safety Brochure" carefully before using it.

EN

Contents

Information	15
Notice Concerning Trademarks, etc.	15
About the content in this manual	16
Accessories	17
Part names and functions	17
Top/Front panel	19
Rear panel	22
Remote control	25
Preparing the remote control	25
Operating range of the remote control	26
Replacing the battery in the remote control	26
Installation	27
Installing the unit on a TV stand	27
Mounting the unit on a wall	27
Connections	30
1. Connecting a computer or AV device	30
2. Connecting a TV	32
3. Connecting an external subwoofer	32
4. Connecting the power cord	32
Mode of the unit	15
Types of modes	15
Setting the mode	16
Functions of each mode	17
Conference mode	17
Hotel mode	19
Education mode	22
Other functions	25
Operating the unit with the TV remote control	25
Connecting a Bluetooth® device	26
Restore the settings to their original state at the time of purchase	26
Appendix	27
Specifications	30
Main specifications	30
Supported HDMI audio/video formats	32
Supported digital audio formats	32

Notice Concerning Trademarks, etc.



Dolby, Dolby Audio, Pro Logic, and the double-D symbol are trademarks of Dolby Laboratories Licensing Corporation. Manufactured under license from Dolby Laboratories. Confidential unpublished works.

Copyright © 2012–2020 Dolby Laboratories. All rights reserved.



For DTS patents, see <http://patents.dts.com>.

Manufactured under license from DTS, Inc. DTS, the Symbol, DTS and the Symbol together, DTS Digital Surround, and DTS Virtual:X are registered trademarks or trademarks of DTS, Inc. in the United States and/or other countries.

© DTS, Inc. All Rights Reserved.



The terms HDMI and HDMI High-Definition Multimedia Interface, and the HDMI Logo are trademarks or registered trademarks of HDMI Licensing Administrator, Inc. in the United States and other countries.





“X.v.Color” is a trademark of Sony Corporation.



The Bluetooth® word mark and logos are registered trademarks owned by Bluetooth SIG, Inc. and any use of such marks by Yamaha Corporation is under license. Other trademarks and trade names are those of their respective owners.

About the content in this manual

- This Manual uses the following signal words for the important information:

WARNING 	This content indicates "risk of serious injury or death."
CAUTION 	This content indicates "risk of injury."
NOTICE	Indicates content that you must observe in order to prevent the product from malfunctioning, being damaged, or operating incorrectly, and to avoid data loss.
IMPORTANT	Indicates content that you must know in order to operate and use the product correctly.
NOTE	Indicates information that is related to operation and use. Read this for your reference.

- The illustrations and screens in this manual are for instructional purposes only.
- The company names and product names in this manual are the trademarks or registered trademarks of their respective companies.
- Yamaha continuously makes improvements and updates to the software included in this product. You can download the latest software from the Yamaha website.
- Unauthorized copying of this document in part or in its entirety is prohibited.

Accessories

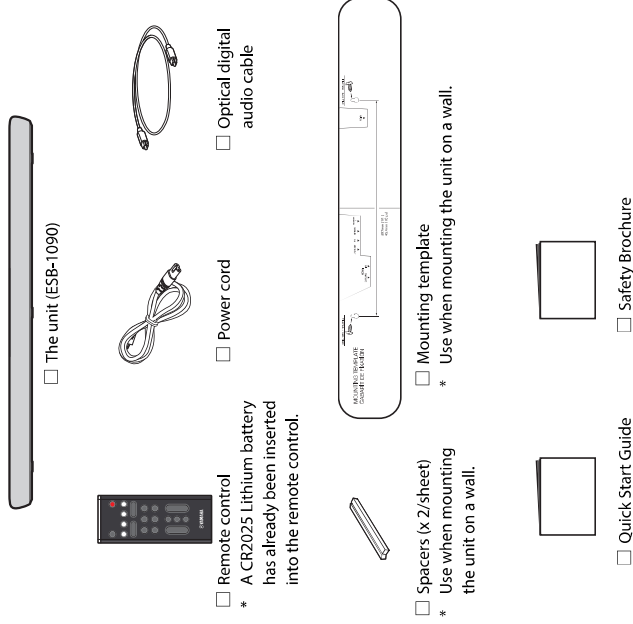

Top/Front panel

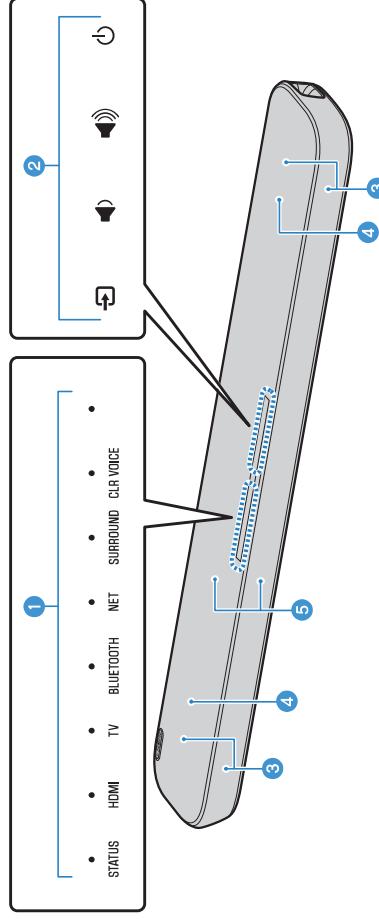

1 Indicators

- STATUS indicator
- HDMI indicator
- TV indicator
- BLUETOOTH indicator
- NET indicator
- SURROUND indicator
- CLR VOICE indicator
- Additional indicator

2 Touch panel

- Input source setting button
- Volume (-) button
- Volume (+) button
- Power button

3 Speakers

4 Subwoofers

5 Remote control sensor

NOTICE

To prevent unintended operation, do not place any objects on the touch panel.

Rear panel

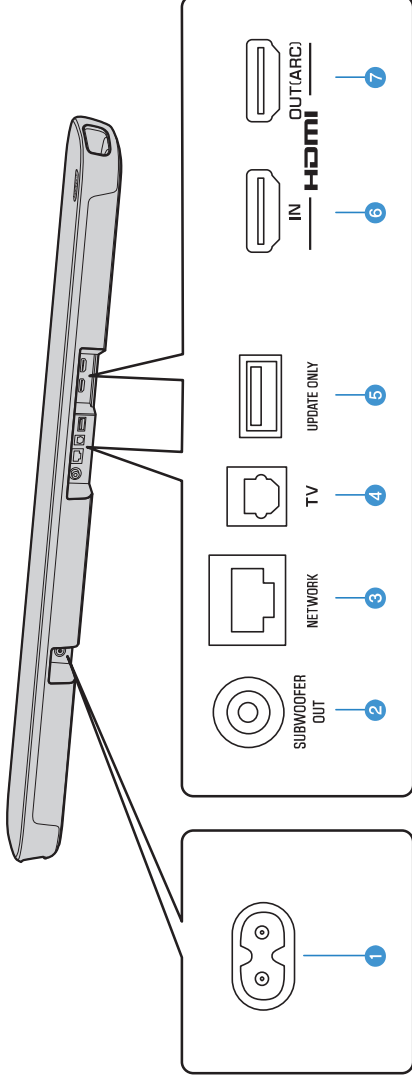

1 Power connector

2 SUBWOOFER OUT jack

3 NETWORK jack

This is used to connect the unit to the network.

NOTICE

- Do not connect the unit to Internet service directly. Only connect this product to the Internet through a router with strong password protections. Consult your router manufacturer for information on optimum security practices.
- Use STP (Shielded Twisted Pair) cable to prevent electromagnetic interference.

4 TV jack

5 UPDATE ONLY jack

This is used to update the unit's firmware. Refer to the instructions supplied with the firmware for details.

6 HDMI IN jack

7 HDMI OUT (ARC) jack

Remote control

Preparing the remote control

Pull out the battery insulating strip before use.

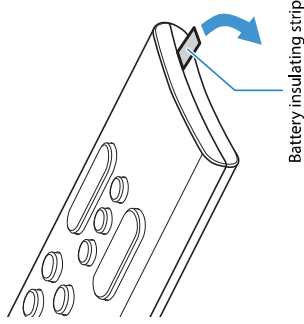

Operating range of the remote control

Operate the remote control within the range shown in the following figure.

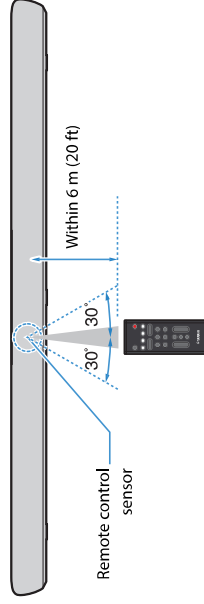

Replacing the battery in the remote control

1. Press and hold ▽ on the rear cover of the remote control, slide the cover out in the direction of the arrow to remove it.
2. Remove the old battery and insert a new one.
3. Slide the rear cover back into place in the direction of the arrow to install.

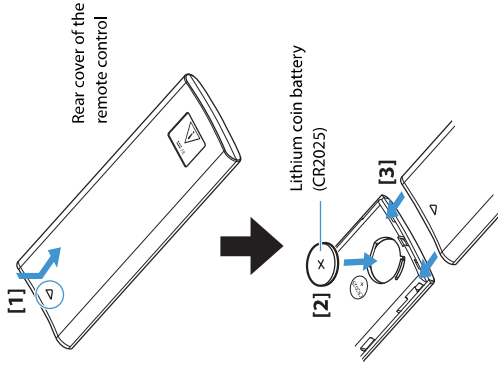

⚠ WARNING

- DO NOT SWALLOW THE BATTERY.
- Keep new and used batteries away from children.
- If the battery compartment does not close securely, stop using the product and keep it away from children.

The remote control supplied with this product contains a coin/button cell battery. If the coin/button cell battery is swallowed, it can cause severe internal burns in just two hours and can eventually lead to death. If you think a battery might have been swallowed or placed inside any part of the body, seek immediate medical attention.

⚠ CAUTION

- Do not put in a pocket or bag, carry, or store batteries together with pieces of metal. The battery could short, burst, or leak, causing a fire or injury.
- When storing or discarding batteries, insulate the terminal area by applying tape, or some other protection. Mixing them with other batteries or metal objects can cause a fire, burns, or inflammation due to fluid.

Installing the unit on a TV stand

It can be installed as shown in the figure.

NOTICE

- Do not apply excessive force to the unit when moving it. Doing so may damage the speakers or the portion covered with fabric.
- When installing the unit, do not stack with other equipment. Doing so may cause a malfunction due to vibrations.
- The unit contains non-magnetic shielding speakers. Do not place magnetically sensitive items (hard disk drive, etc.) near the unit.

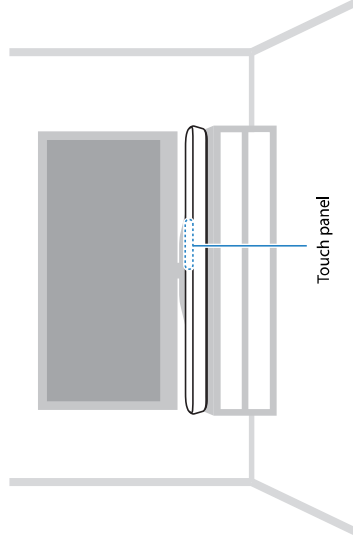

Mounting the unit on a wall

It can be installed as shown in the figure. Be sure to follow the instructions on page 11 for installation.

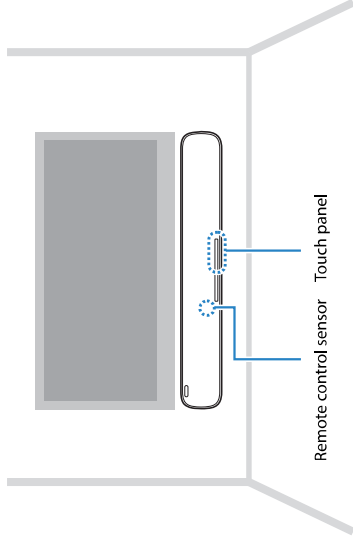

CAUTION

- Please have a qualified contractor or dealer when mounting the unit on a wall. Some skills and experience are required for safe installation.
- To prevent the unit from falling, attach it to a wall constructed of drywall (plasterboard).
- Make sure you use screws (sold separately) that can support the weight of the installation. Using clamps other than specified screws, such as short screws, nails, and two-sided tape, may cause the unit to fall.
- Fix the cables in place where they will not become loose. If your foot or hand accidentally gets caught on a loose cable, the unit may fall.
- Do not lean on the unit or apply excessive force to the top of the unit. Doing so may cause the unit to fall.
- Check that the unit is securely fixed after the installation. Yamaha will bear no responsibility for any accidents caused by improper installations.

1. **Attach the mounting template (supplied) on a wall and mark the two locations for the screw holes.**

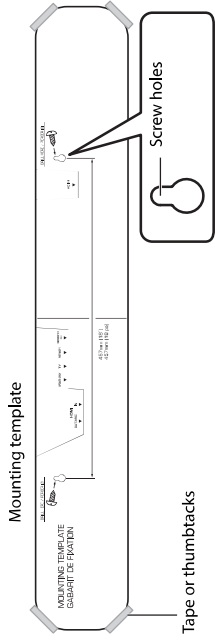

2. **Remove the mounting template from the wall, and then install screws (sold separately) at the points marked on the wall.**

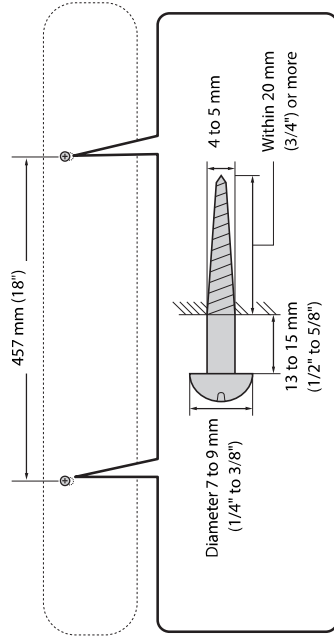

3. **Attach the supplied spacers to the bottom of the unit.**
Peel off the backing from the spacer and press the adhesive part against the bottom of the unit.

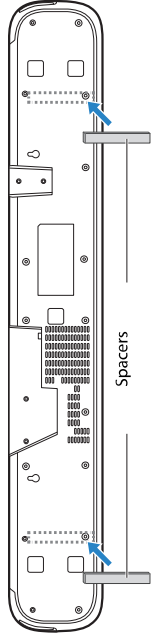

4. **Hang the unit on the screws you installed.**

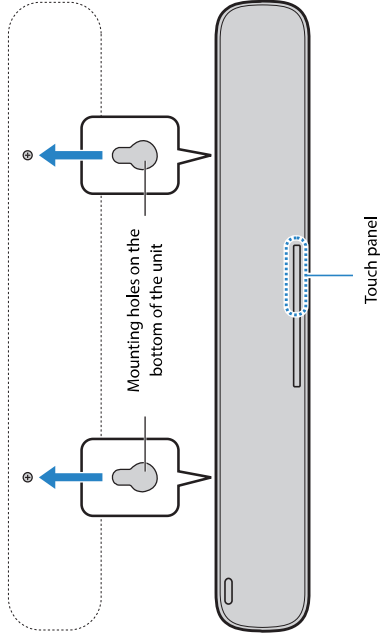

1. Connecting a computer or AV device

Use a HDMI cable (sold separately) and connect as shown in the figure.

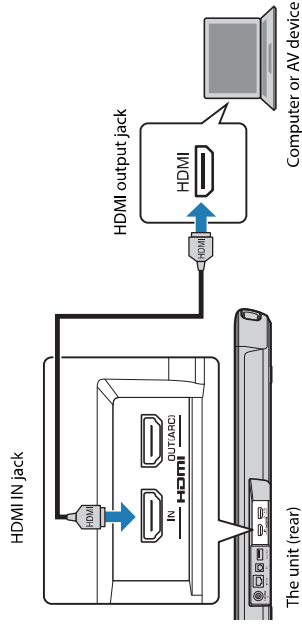

NOTICE

- Use a 19-pin HDMI cable with the HDMI logo printed on it.
- Keep the cable as short as possible to prevent any degradation in signal quality.

2. Connecting a TV

[Connecting a TV that supports **Audio Return Channel (ARC)**]

Use an ARC-compatible HDMI cable (sold separately) and connect as shown in the figure.

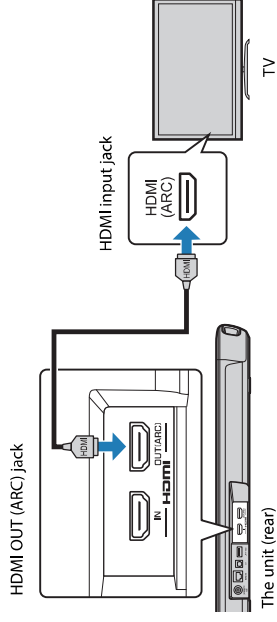

NOTICE

- Use a 19-pin HDMI cable with the HDMI logo printed on it.
- Keep the cable as short as possible to prevent any degradation in signal quality.

NOTE

The TV jack on the unit cannot be used when the ARC function is in use.

[Connecting a TV that does not support Audio Return Channel (ARC)]
 Use an HDMI cable (sold separately) and the optical digital audio cable (supplied) to connect as shown in the figure.

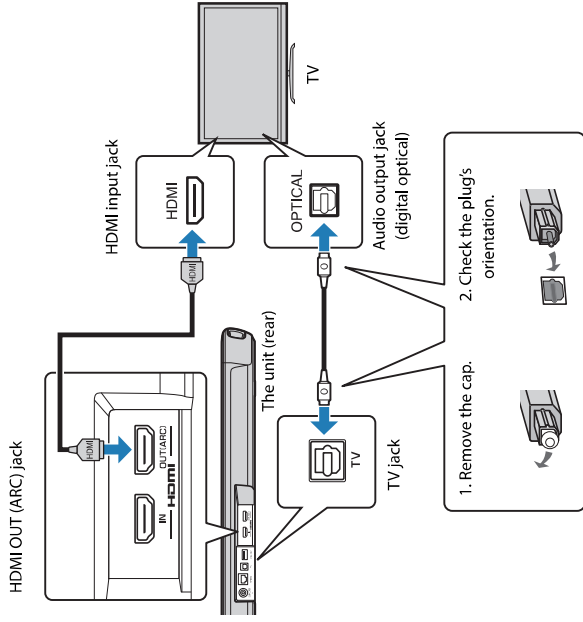

3. Connecting an external subwoofer

Use a mono pin cable (sold separately) and connect as shown in the figure.

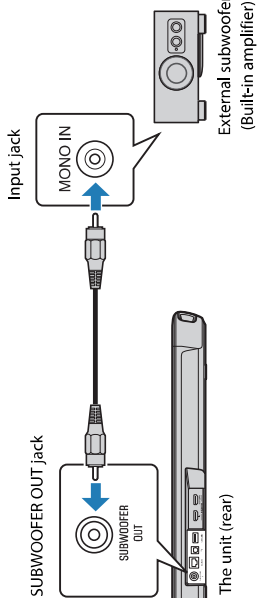

NOTE

Audio is output from both the unit's built-in subwoofers and the external subwoofer.

NOTICE

- Use a 19-pin HDMI cable with the HDMI logo printed on it.
- Keep the cable as short as possible to prevent any degradation in signal quality.

4. Connecting the power cord

Connect the supplied power cord to the unit, followed by the plug into the wall outlet.

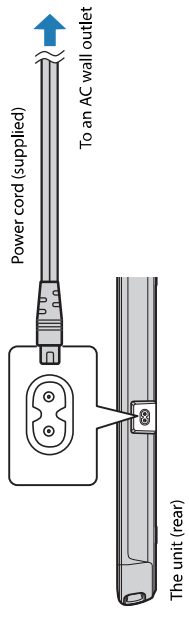

When the plug is inserted into the wall outlet, the unit will turn on.

Mode of the unit

Types of modes

The unit has three modes.

Conference mode:

This mode is for installing the unit in a conference room and using it as a speaker for remote conferencing.

Hotel mode:

The mode is for installing the unit in a hotel lobby or guest room and using it as a speaker for watching movies and TV programs, or listening music.

Education mode:

This mode is for installing the unit in a classroom and using it as a speaker for playing educational audio materials.

NOTE

At the time of purchase, the unit is set to Conference mode.

Setting the mode

The procedure is as follows.

1.

Press the power button on the remote control to turn off the unit.

2.

Press the buttons on the remote control in the following order.

[When setting to Conference mode]

"Press INFO button once." > "Press VOLUME (+) button twice."
> "Press the mute button once." > "Press TV button once."

[When setting to Hotel mode]

"Press INFO button once." > "Press VOLUME (+) button twice."
> "Press the mute button once." > "Press HDMI button once."

[When setting to Education mode]

"Press INFO button once." > "Press VOLUME (+) button twice."
> "Press the mute button once." > "Press BLUETOOTH button once."

That's all for the procedure. When the settings are completed, the unit will turn on.

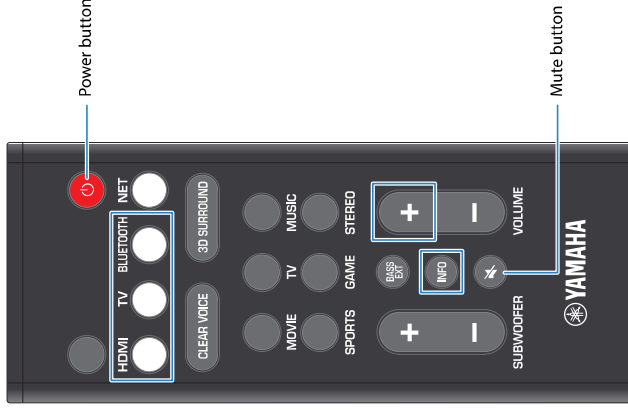

NOTE

You can also use the setup file to set the mode. Please read the "ESB-1090 Installation Guide" for details.

Conference mode

NOTE

- The indicator will always be off (it will light/flash temporarily when you adjust the volume or mute the sound).
- The computer or AV device (connected to the HDMI jack) is always set as the input source of the audio signal.
- The playback method is always set to stereo playback.

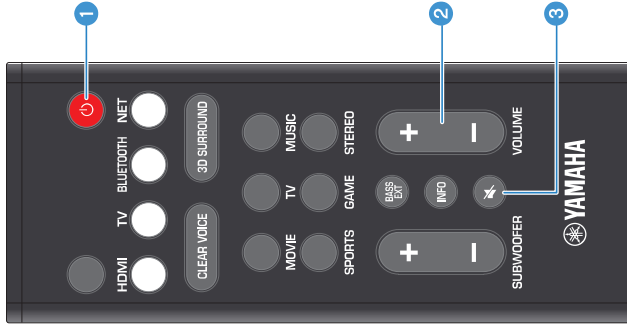

[Remote control]

1 Power button

You can turn on/off the power of the unit.

When turned on, the STATUS indicator turns off, and when turned off, the STATUS indicator turns red.

2 VOLUME (+) button, VOLUME (-) button

You can adjust the volume of the speaker.

You can check the volume by the number of indicators that light up during adjustment.



Volume goes down (-)

Volume goes up (+)

3 Mute button

You can mute the audio from the speakers and subwoofers. You can also unmute the sound.

When muted, the indicator flashes as shown in the figure.



Operation by other buttons is invalid.

[Touch panel]

Operation by all buttons on the touch panel is invalid.

Hotel mode

[Remote control]

1 Power button

You can turn on/off the power of the unit.

When turned on, the STATUS indicator turns off, and when turned off, the STATUS indicator turns red.

2 Input source setting button

• **HDMI button** : You can set a computer or AV device (connected to the HDMI IN jack) as the input source of the audio signal.

• **TV button** : You can set the TV as the input source of the audio signal.

• **BLUETOOTH button** : You can set a Bluetooth device as the input source of the audio signal.
Please read page 26 for more information.

3 CLEAR VOICE button

You can enable/disable the clear voice function (a function that makes it easier to hear and play back human voices, such as dialogues and narrations).

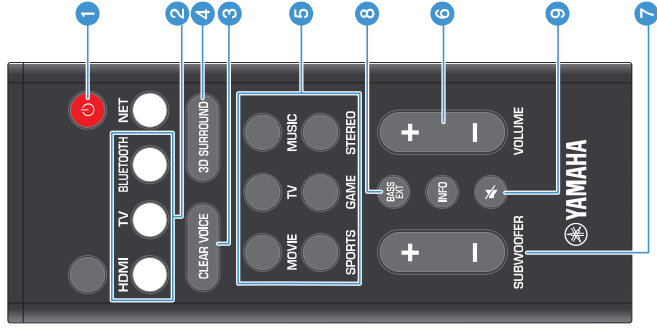

4 3D SURROUND button

You can set the playback method to 3D surround playback. In addition, 3D surround playback can be canceled and set to surround playback.

The SURROUND indicator lights blue during 3D surround playback and white during surround sound playback.

NOTE

During 3D surround playback, audio is reproduced not only horizontally but also vertically, creating a three-dimensional sound field.

5 Surround program buttons

- **MOVIE button :** You can call up the appropriate sound settings for watching a movie.
- **TV button :** You can call up the appropriate sound settings for watching a TV program.
- **MUSIC button :** You can call up the appropriate sound settings for music appreciation.
- **SPORTS button :** You can call up the appropriate sound settings for watching sports.
- **GAME button :** You can call up the appropriate sound settings for video game play.
- **STEREO button :** You can set the playback method to stereo playback.

The SURROUND indicator goes out during stereo playback.

6 VOLUME (+) button, VOLUME (-) button

You can adjust the volume of the speaker.

You can check the volume by the number of indicators that light up during adjustment.



Volume goes down (-) Volume goes up (+)

7 SUBWOOFER (+) button, SUBWOOFER (-) button

You can adjust the volume of the subwoofer.

You can check the volume by the type of indicator that lights up during adjustment.



Volume goes down (-) Volume goes up (+)

8 BASS EXT button

You can enable/disable the bass extension function (a function that enhances bass sound for playback).

The indicator flashes three times when it goes from disabled to enabled, and once when it goes from enabled to disabled, as shown in the figure.



④ Mute button

You can mute the audio from the speakers and subwoofers. You can also unmute the sound.

When muted, the indicator flashes as shown in the figure.



Operation by other buttons is invalid.

[Touch panel]

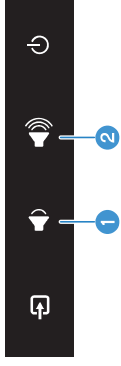

① Volume (-) button

② Volume (+) button

You can adjust the volume of the speaker.

Operation by other buttons is invalid.

Education mode

NOTE

The playback method is always set to stereo playback.

[Remote control]

1 Power button

You can turn on/off the power of the unit.

When turned on, the STATUS indicator turns off, and when turned off, the STATUS indicator turns red.

2 Input source setting button

• **HDMI button** : You can set a computer or AV device (connected to the HDMI IN jack) as the input source of the audio signal.

• **TV button** : You can set the TV as the input source of the audio signal.

• **BLUETOOTH button** : You can set a Bluetooth device as the input source of the audio signal.
Please read page 26 for more information.

3 CLEAR VOICE button

You can enable/disable the clear voice function (a function that makes it easier to hear and play back human voices, such as dialogues and narrations).

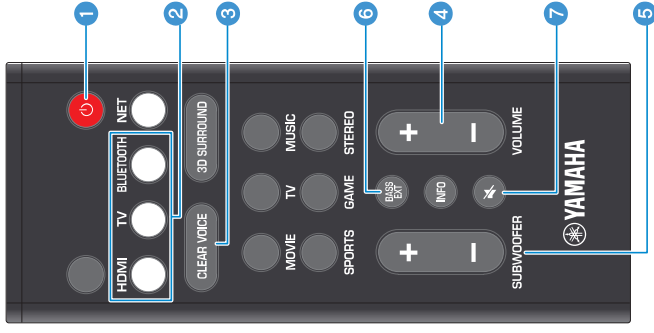

4 VOLUME (+) button, VOLUME (-) button

You can adjust the volume of the speaker.
You can check the volume by the number of indicators that light up during adjustment.

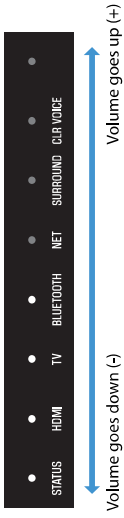

5 SUBWOOFER (+) button, SUBWOOFER (-) button

You can adjust the volume of the subwoofer.
You can check the volume by the type of indicator that lights up during adjustment.

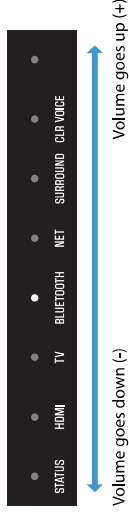

6 BASS EXT button

You can enable/disable the bass extension function (a function that enhances bass sound for playback).
The indicator flashes three times when it goes from disabled to enabled, and once when it goes from enabled to disabled, as shown in the figure.



7 Mute button

You can mute the audio from the speakers and subwoofers. You can also unmute the sound.
When muted, the indicator flashes as shown in the figure.



Operation by other buttons is invalid.

[Touch panel]

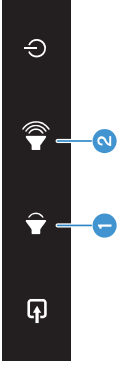

1 Volume (-) button

2 Volume (+) button

You can adjust the volume of the speaker.

Operation by other buttons is invalid.

Operating the unit with the TV remote control

The HDMI control function (a function that links this unit to a TV connected with an HDMI cable) allows you to operate this unit with the TV's remote control.

[Example]

- Turning on/off the power of the unit with the TV remote control
- Setting the input source of the audio signal with the TV remote control
- Set the speakers that output audio with the TV remote control
- Adjusting the volume of the speaker with the TV remote control

NOTE

Details of the functions vary depending on the type of TV and remote control.

Note that the HDMI control function can be enabled/disabled by following the procedure below.

1. **Press the power button on the remote control to turn off the unit.**
2. **Press the buttons on the remote control in the following order.**
"Press MUSIC button once." > "Press VOLUME (-) button twice."
> "Press the mute button once."

The unit will turn on.

3. **Press the power button on the remote control to turn off the unit.**

4. **Press and hold HDMI button on the remote control for at least 5 seconds.**

The HDMI indicator lights up when the unit is enabled from disabled. When going from enabled to disabled, none of the indicators will be lit.

That's all for the procedure. When the switchover is complete, the unit will turn on.

IMPORTANT

When the switchover is complete, the unit is in the mode deactivated state. Follow the procedure described on page 16 to reconfigure the mode.

NOTE

- When the HDMI control function is enabled, the standby power consumption of the unit is higher than when it is disabled.
- When both the HDMI control function and the Bluetooth standby function (described on page 28) are disabled, the STATUS indicator does not light up even when the unit is turned off.

Connecting a Bluetooth® device

When this unit is in Hotel mode/Education mode, you can connect the unit to a Bluetooth device (such as a smartphone or digital music player) by following the procedure below.

1. **Press BLUETOOTH button on the remote control.**

The BLUETOOTH indicator blinks.

2. **Enable the Bluetooth function of the Bluetooth device.**

A list of peripherals that can be connected is displayed on the Bluetooth devices screen.

3. **Select "ESB-1090 XXXXXX Bluetooth" (XXXXX depends on the Bluetooth address) from the list.**

The unit and the Bluetooth device are paired and connected.

That's all for the procedure. When the connection is completed, the BLUETOOTH indicator will light up.

Restore the settings to their original state at the time of purchase

The procedure is as follows.

1. **Press the power button on the remote control to turn off the unit.**

2. **Touch and hold the Volume (+) button on the touch panel, and also touch the power button.**

All lights will flash and a reset of the settings will be performed.

That's all for the procedure. When the resetting of the settings is completed, the unit will turn on.

The unit can be used even when the mode is deactivated.

Cancel mode

The procedure is as follows.

1. **Press the power button on the remote control to turn off the unit.**
2. **Press the buttons on the remote control in the following order.**
"Press MUSIC button once." > "Press VOLUME (-) button twice."
> "Press the mute button once."

That's all for the procedure. When the settings are completed, the unit will turn on.

Function when the mode is canceled

[Remote control]

This is the same as Hotel mode.

[Touch panel]

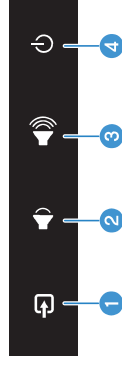

- 1 **Input source setting button**
You can set the input source of the audio signal.
- 2 **Volume (-) button**
- 3 **Volume (+) button**
You can adjust the volume of the speaker.
- 4 **Power button**
You can turn on/off the power of the unit.

[Automatic standby function]

You can use the automatic standby function (a function that automatically turns off the power to the unit). When this function is enabled, the unit turns off automatically in either of the following conditions.

- Eight hours have passed without operation of the unit.
- 10 minutes have passed without operation of the unit and without input of an audio signal to the unit.

The automatic standby function can be enabled/disabled by following the procedure below.

1. Turn off the power to the unit.

2. Touch and hold the input source setting button on the touch panel, and also touch the power button for at least 5 seconds.

The CLR VOICE indicator lights up when the unit is disabled from enabled.

When going from disabled to enabled, none of the indicators will be lit.

That's all for the procedure. When the switchover is complete, the unit will turn on.

[Bluetooth standby function]

You can use the Bluetooth standby function (a function that allows you to operate the unit with a Bluetooth device). When this function is enabled, you can turn on the unit by following the steps below.

1. Enable the Bluetooth function of the Bluetooth device (already paired).

A list of peripherals that can be connected is displayed on the Bluetooth devices screen.

2. Select "ESB-1090 XXXXXX Bluetooth" (XXXXXX depends on the Bluetooth address) from the list.

That's all for the procedure. The unit will turn on.

The Bluetooth standby function can be enabled/disabled by following the procedure below.

1. Turn off the power to the unit.

2. Press and hold SPORTS button on the remote control for at least 5 seconds.

The BLUETOOTH indicator lights up when the device is enabled from disabled.

When going from enabled to disabled, none of the indicators will be lit.

That's all for the procedure. When the switchover is complete, the unit will turn on.

NOTE

- When the Bluetooth standby function is enabled, the standby power consumption of the unit becomes larger than when it is disabled.
- When both the Bluetooth standby function and the HDMI control function (described on page 25) are disabled, the STATUS indicator does not light up even when the unit is turned off.

Specifications

The contents of this manual apply to the latest specifications as of the publishing date. To obtain the latest manual, access the Yamaha website then download the manual file.

Main specifications

General

Drivers	<ul style="list-style-type: none"> • Front L/R: 5.5 cm (2-1/8") cone x 2 • Tweeter: 2.5 cm (1") dome x 2 • Subwoofer: 7.5 cm (3") cone x 2
Output power (Asynchronous drive, JEITA)	<ul style="list-style-type: none"> • Front L/R: 30 W x 2 • Subwoofer: 60 W
Power supply	[U.S.A. and Canada models] AC100 V to 120 V, 50/60 Hz [U.K., Europe and Russia models] AC100 V to 240 V, 50/60 Hz
Power consumption	30 W (Rated)
Standby power consumption	<ul style="list-style-type: none"> • HDMI control off, Bluetooth standby off: 0.2 W • HDMI control off, Bluetooth standby on: 1.7 W • HDMI control on, Bluetooth standby off: 0.6 W • HDMI control on, Bluetooth standby on: 2.2 W
Maximum volume	Max SPL: 96 dB at 1 m
Frequency bandwidth	<ul style="list-style-type: none"> • Front L/R: 170 Hz to 22,000 Hz • Tweeter: 5,000 Hz to 23,000 Hz • Subwoofer: 62 Hz to 170 Hz
Dimensions (W x H x D)	<ul style="list-style-type: none"> • Installing the unit on a TV stand, etc.: 890 mm x 53 mm x 131 mm (35" x 2-1/8" x 5-1/8") • Mounting the unit on a wall, with spacers: 890 mm x 131 mm x 62 mm (35" x 5-1/8" x 2-1/2")
Weight	3.4 kg (7.5 lbs)

Operating environment	<ul style="list-style-type: none"> • Temperature: 5°C to 40°C (41°F to 104°F) • Humidity: 30% to 90% (no condensation)
Storage environment	<ul style="list-style-type: none"> • Temperature: -20°C to 60°C (-4°F to 140°F) • Humidity: 30% to 90% (no condensation)

Decoder

Supported audio signal (HDMI/optical input)	<ul style="list-style-type: none"> • PCM (up to 5.1 channels) • Dolby Digital (up to 5.1 channels) • Dolby Pro Logic II (up to 5.1 channels) • DTS Digital Surround (up to 5.1 channels)
---	--

Interface

Input jacks	<ul style="list-style-type: none"> • HDMI: 1 (HDMI IN jack) • Digital (optical): 1 (TV jack)
Output jacks	<ul style="list-style-type: none"> • HDMI: 1 (HDMI OUT (ARC) jack) • Analog (RCA/monaural): 1 (SUBWOOFER OUT jack)
Other jacks	<ul style="list-style-type: none"> • USB: 1 (UPDATE ONLY jack) • Network (ethernet): 1 (NETWORK jack)
Bluetooth	<ul style="list-style-type: none"> • Version: 4.2 • Supported profiles: A2DP • Supported codecs: SBC, AAC • Class: Bluetooth Class 2 • Range (line-of-sight): Approx. 10 m (33 ft) • Supported content protection method: SCMS-T (sink function) [UK, Europe and Russia models] • Radio frequency: 2402 MHz to 2480 MHz • Maximum output power (EIRP): 9.5 dBm (8.9 mW)
Wired network	<ul style="list-style-type: none"> • Ethernet standard: 100 BASE-TX/10 BASE-T

Supported HDMI audio/video formats

Video signal	<ul style="list-style-type: none"> • Deep Color • x.v.Color • 3D visual signal • High Dynamic Range (HDR) video: HDR10, HLG
Resolutions	<ul style="list-style-type: none"> • VGA • 480i/60 Hz • 480p/60 Hz • 576i/50 Hz • 576p/50 Hz • 720p/60 Hz, 50 Hz • 1080i/60 Hz, 50 Hz • 1080p/60 Hz, 50 Hz, 30 Hz, 25 Hz, 24 Hz • 4K/60 Hz, 50 Hz, 30 Hz, 25 Hz, 24 Hz
Audio signals	<ul style="list-style-type: none"> • 2ch linear PCM: 2 channels, 32 kHz to 192 kHz, 16 bit/20 bit/24 bit • Multi-ch linear PCM: 6 channels, 32 kHz to 192 kHz, 16 bit/20 bit/24 bit • Bitstream: Dolby Digital, DTS Digital Surround
Copyright Protection Standard	HDCP 2.3

Supported digital audio formats

HDMI (ARC)	<ul style="list-style-type: none"> • 2ch linear PCM: 2 channels, 32 kHz to 192 kHz, 16 bit/20 bit/24 bit • Bitstream: Dolby Digital, DTS Digital Surround
Optical	<ul style="list-style-type: none"> • 2ch linear PCM: 2 channels, 32 kHz to 192 kHz, 16 bit/20 bit/24 bit • Bitstream: Dolby Digital, DTS Digital Surround

Yamaha Global Site
U.S.A. and Canada
<https://uc.yamaha.com/>
Other countries
<https://www.yamaha.com/>

Yamaha Downloads
U.S.A. and Canada
<https://uc.yamaha.com/support/>
Other countries
<https://download.yamaha.com/>

© 2021 Yamaha Corporation
Published 09/2022
IPOD-B0