



Boundary Microphone

RM-TT

Reference Manual

CONTENTS

| | |
|--|-----------|
| INTRODUCTION | 1 |
| Information..... | 1 |
| CONTROLS AND FUNCTIONS | 2 |
| Top panel/side panel | 2 |
| Bottom panel..... | 3 |
| WEB GUI | 4 |
| Starting RM-TT Device Manager..... | 4 |
| Structure of RM-TT Device Manager..... | 6 |
| Functions of RM-TT Device Manager..... | 8 |
| Alert log list | 22 |
| MAIN SPECIFICATIONS | 24 |

INTRODUCTION

Thank you for purchasing the Yamaha RM-TT boundary microphone. This document provides detailed information on the product functions and specifications as well as the Web GUI. For correct and safe use of this product, be sure to first read this manual carefully together with the RM-TT Installation Manual (included with the product).

Information

- The illustrations and images shown in this manual are for instructional purposes only.
- The company names and product names in this manual are trademarks or registered trademarks of their respective companies.
- We are continuously improving the software for our products. The latest version can be downloaded from the Yamaha website.
- This document is based on the latest specifications at the time of publication. The latest version can be downloaded from the Yamaha website.
- Reproduction of this manual in whole or in part without permission is prohibited.

CONTROLS AND FUNCTIONS

Top panel/side panel

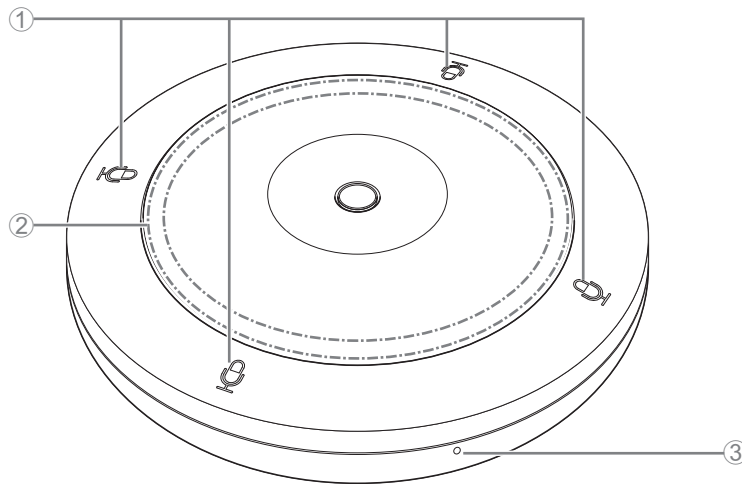

① Mic buttons/indicators

| Condition | Mic indicator | Unit status |
|--|--------------------------------------|---|
| In Toggle mode: Mic button touched | Lit green | Microphone on |
| In Toggle mode: Mic button touched | Lit red (Flashes every 2 seconds) | Microphone off |
| In Push to talk mode: Mic button touched continuously | Lit green | Microphone on while the button is touched |
| In Push to talk mode: Mic button released | Lit red (Flashes every 2 seconds) | Microphone off |

NOTE: Push to talk is a communication method that allows you to talk only while a button is pressed. Multiple devices cannot be used to talk at the same time. For details on switching to Toggle mode or Push to talk mode, refer to page 16.

② Status indicator

| Condition | Status indicator | Unit status |
|--|---|---|
| In Toggle mode: Mic button touched | Lit green | Microphone on |
| In Toggle mode: Mic button touched | Lit red | Microphone off |
| In Push to talk mode: Mic button touched continuously | Lit green | Microphone on while the button is touched |
| In Push to talk mode: Mic button released | Lit red | Microphone off |
| LAN cable plugged into Dante/PoE port | Flashes green | Starting up |
| Identify icon in Web GUI clicked | Flashes white | Responding (to Identify function) |
| Updating firmware | Flashes white quickly | Firmware being updated |
| Updating firmware | (After flashing white quickly) Flashes green quickly | Firmware updated successfully |
| – | Flashes red | Error occurring |
| – | Flashes red quickly | Severe error occurring |

NOTE:

- The lighting of the Status indicator varies according to the directivity of the microphone.
- Occurrences of errors and severe errors are recorded in the alert log. For details, refer to page 22.

③ Reset button

| Condition | Status indicator | Unit status |
|--|--|---|
| Reset button long-pressed for 4 seconds to less than 8 seconds, then released | Flashes blue twice per second (during long-pressing/resetting) | Network-related settings Waiting for resetting/Resetting |
| Reset button long-pressed for 8 seconds to less than 12 seconds, then released | Flashes blue three times per second (during long-pressing/resetting) | All settings Waiting for resetting/Resetting |

NOTE: Use a fine-tipped object such as an ejector pin to press the Reset button.

Bottom panel

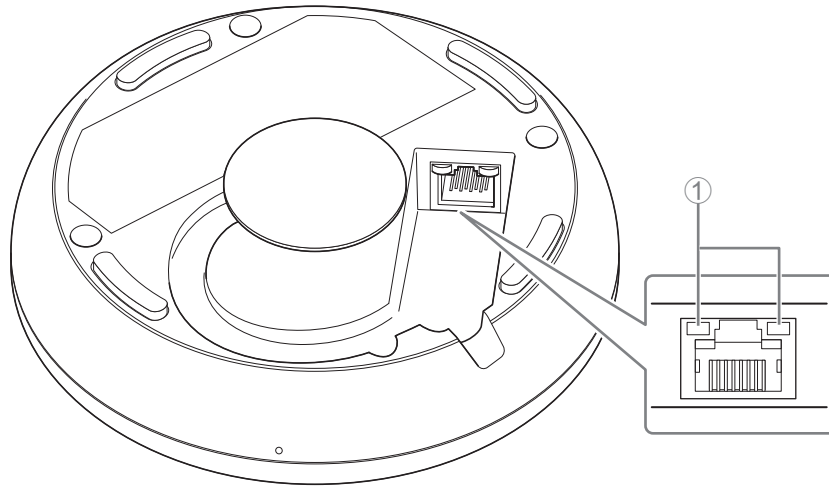

① Network port indicators (Dante/PoE port)

| Network port indicator | Unit status |
|--------------------------------|---|
| Left indicator lit green | Link up |
| Left indicator flashes green | Transferring data |
| Left indicator unlit | Link down |
| Right indicator lit green | Operating on word clock of peripheral device (leader) |
| Right indicator flashes green | Acting as word-clock leader |
| Right indicator flashes orange | Word clock unlocked |

- NOTICE:**
- When disconnecting the LAN cable from the Dante/PoE port, wait at least five seconds before reconnecting the cable. Otherwise, damage or malfunctions may result.
 - With a Dante network, do not use the EEE function* of the network switch. Although mutual power consumption settings are automatically adjusted between switches that support the EEE function, some switches do not perform that properly. As a result, the switch's EEE function may be enabled inappropriately in the Dante network, possibly degrading clock synchronization performance and interrupting audio. Therefore, please note the following.
 - When using managed switches, turn off the EEE function on all ports used for Dante. Do not use a switch that does not allow the EEE function to be turned off.
 - When using unmanaged switches, do not use switches that support the EEE function. In such switches, the EEE function cannot be turned off.
- * EEE (Energy-Efficient Ethernet) function: Technology that reduces the power consumption of Ethernet devices during periods of low network traffic; also known as Green Ethernet or IEEE802.3az.

WEB GUI

Use the Web GUI “RM-TT Device Manager” to check/change the settings of this unit.

Starting RM-TT Device Manager

Prepare the following.

- Computer
- LAN cable

- 1. Download the application “RM Device Finder” from the Yamaha website (U.S.A. and Canada: <https://uc.yamaha.com/support/>, Other countries: <https://download.yamaha.com/>), and then start it.**
- 2. Using a LAN cable, connect the computer to the network switch where this unit is connected.**
- 3. Select a network in the [Select Network Interface Card] window, and then click [OK].**

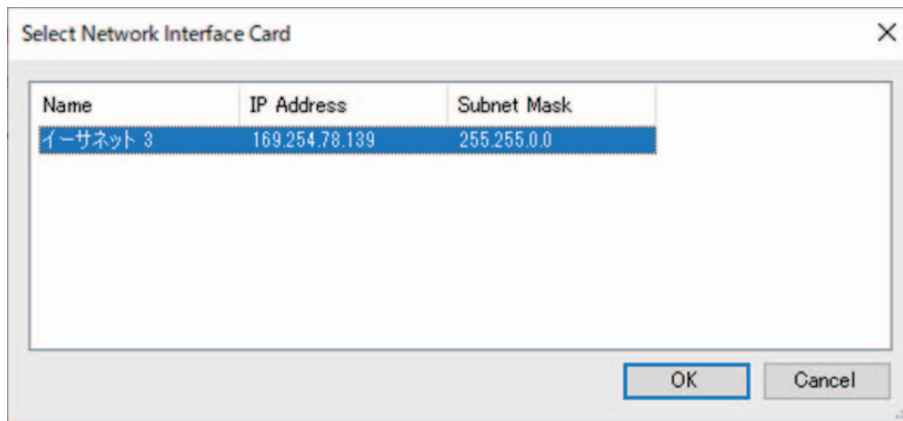

- 4. Double-click this unit in the [Detected Devices] window. Alternatively, select this unit, and then click the [Browse] button.**

The first login window of RM-TT Device Manager appears.

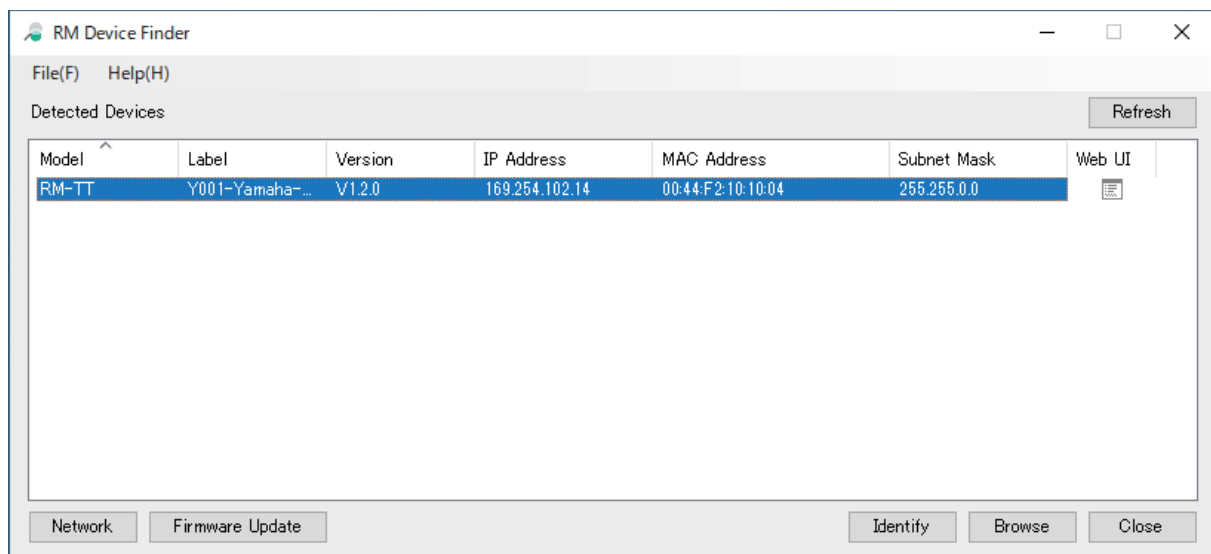

5. Click the [SIGN UP] button in the first login window.

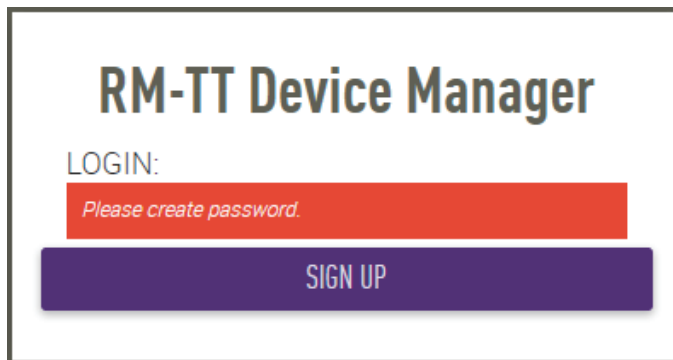

RM-TT Device Manager

LOGIN:

Please create password.

SIGN UP

6. Specify a password in the password settings window, and then click the [SUBMIT] button.

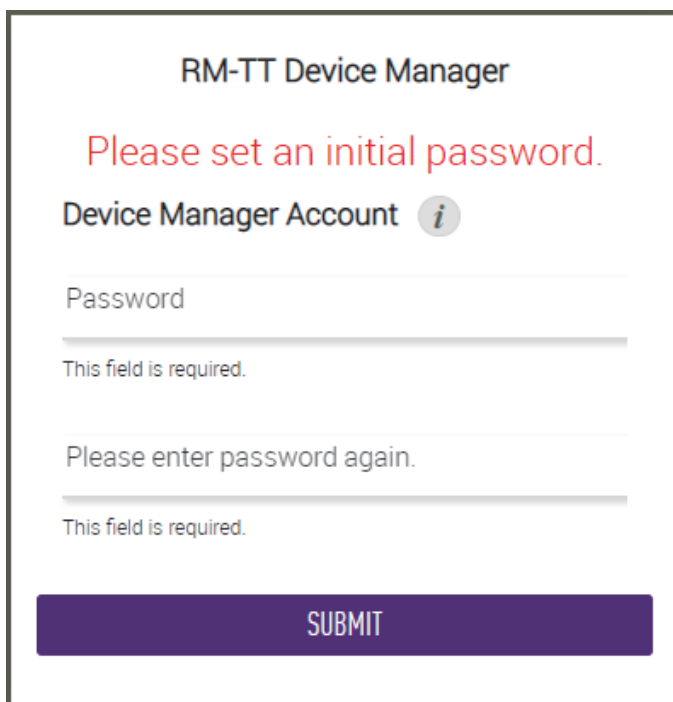

RM-TT Device Manager

Please set an initial password.

Device Manager Account *i*

Password

This field is required.

Please enter password again.

This field is required.

SUBMIT

7. Type the password into the login window, and then click the [LOGIN] button.

The [HOME] window appears.

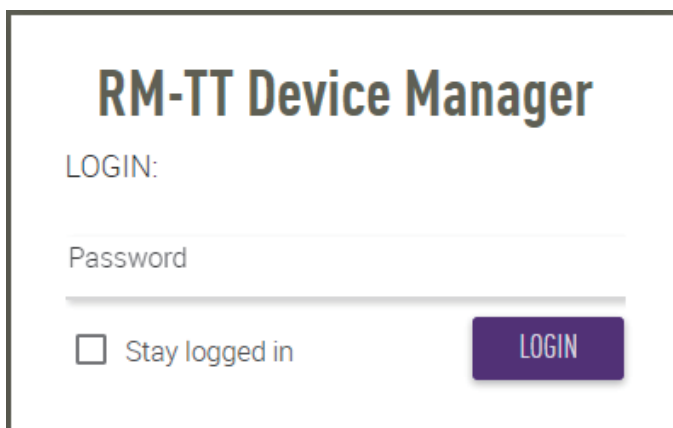

RM-TT Device Manager

LOGIN:

Password

Stay logged in

LOGIN

This completes the startup.

Structure of RM-TT Device Manager

Refer to the page listed to the right for details on each item available in the various windows.

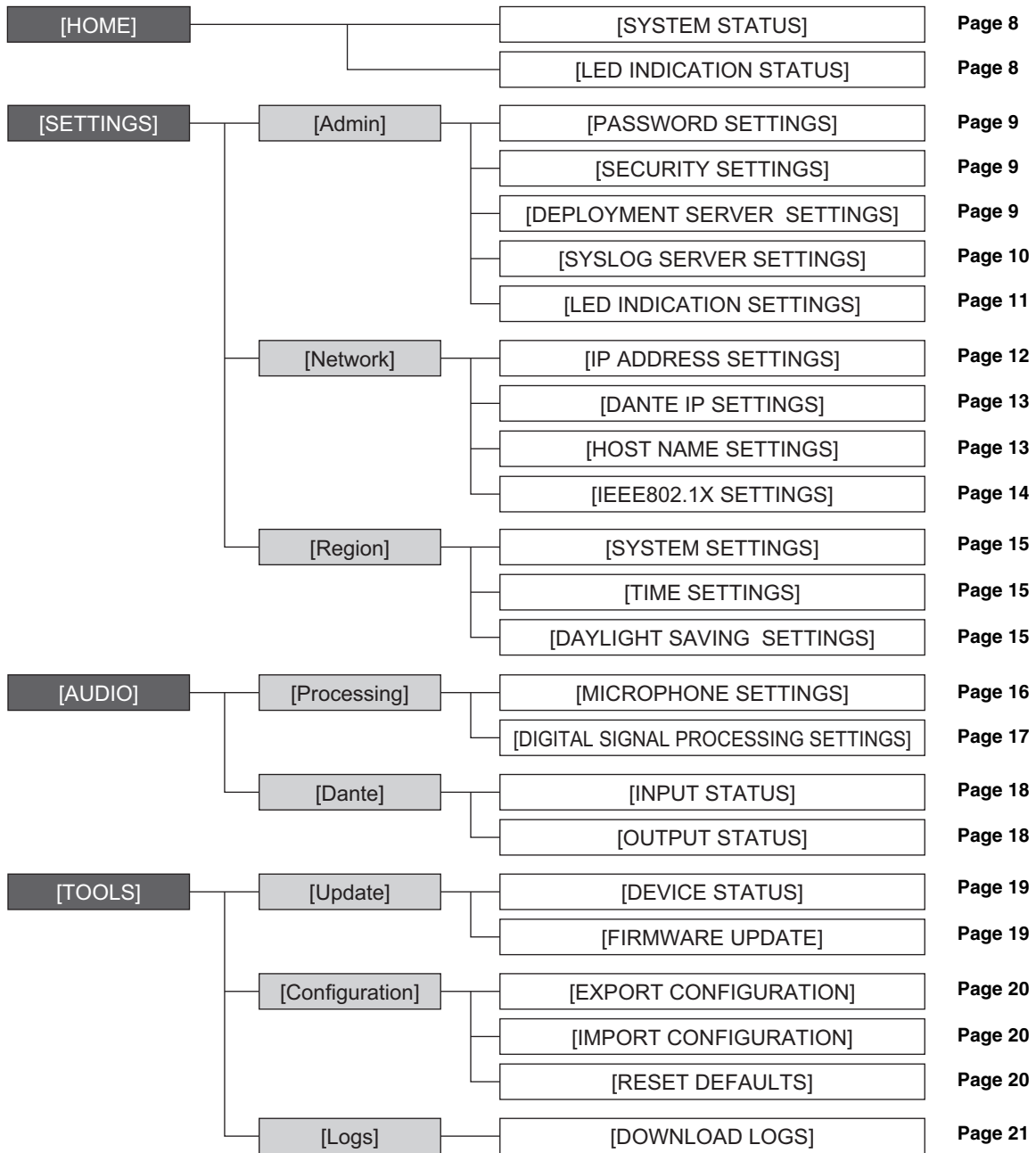

The following icons/buttons are used in RM-TT Device Manager.



(Information icon): Move the pointer over this icon to see more information about the item.



(Identify button): Click to cause the indicator of the corresponding device to flash.

IMPORTANT: Be sure to click the [SUBMIT] button after changing settings in RM-TT Device Manager. The [SUBMIT] button always appears in the upper-right corner of the window.

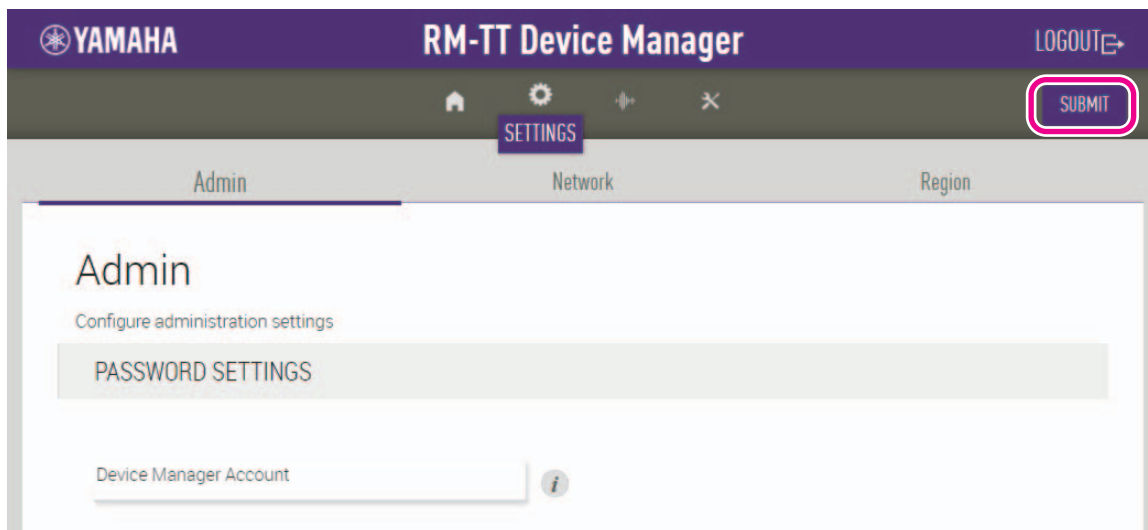

Functions of RM-TT Device Manager

[HOME]

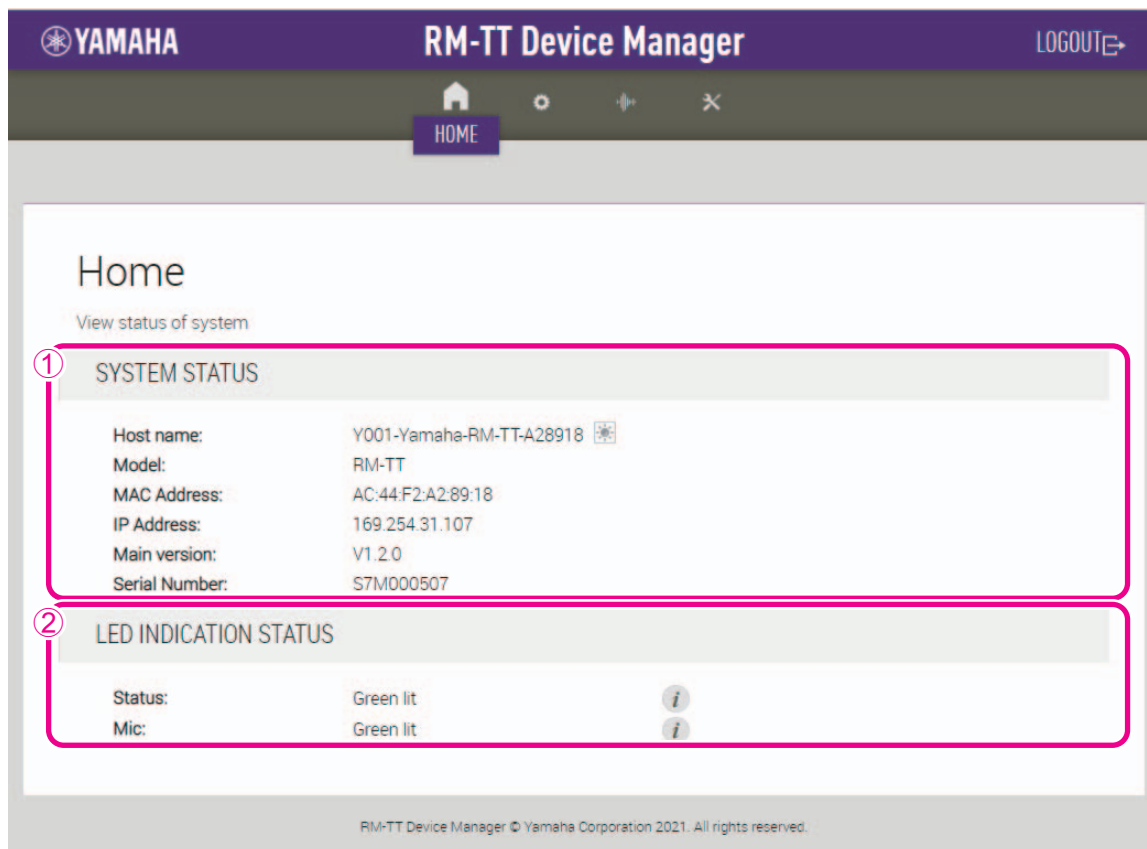

① [SYSTEM STATUS]

Allows you to check basic information on this unit.

② [LED INDICATION STATUS]

Allows you to check the status of the indicators on this unit.

[SETTINGS]

[Admin]

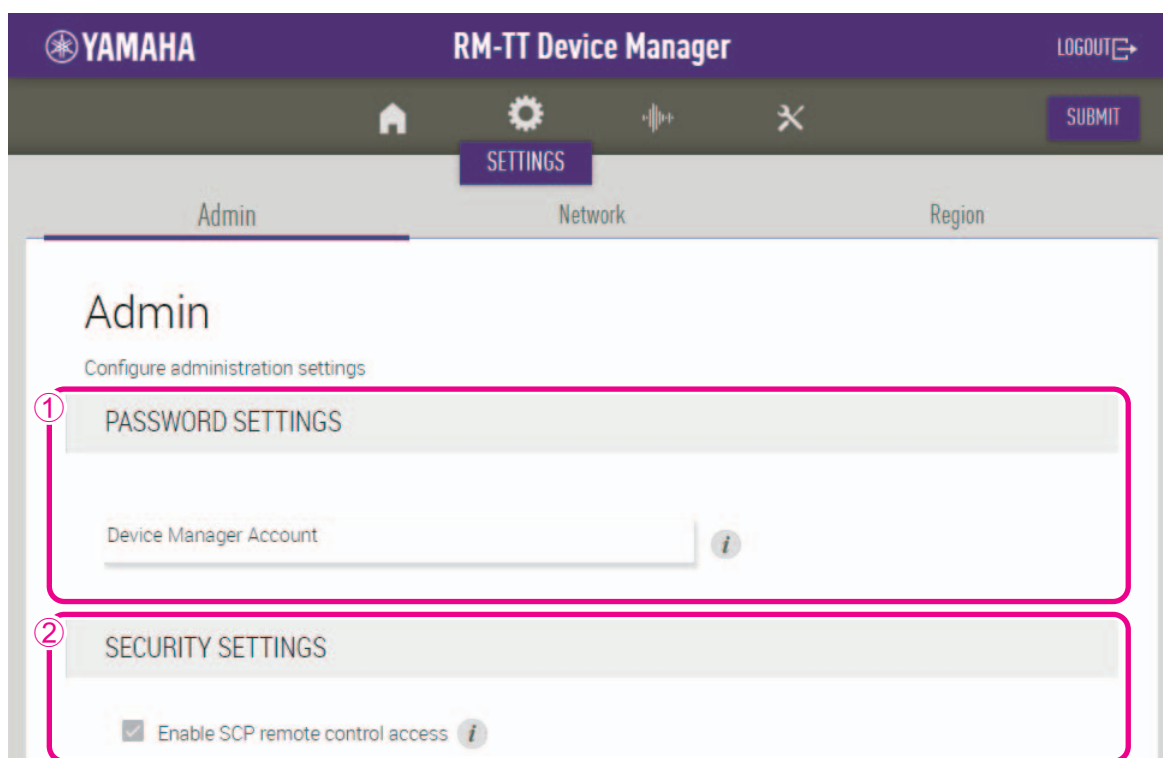

① [PASSWORD SETTINGS]

Allows you to check/change the password for logging in to RM-TT Device Manager.

② [SECURITY SETTINGS]

Allows you to select whether to enable SCP remote control.

For details on SCP, refer to the RM Series Remote Control Protocol Specifications. The specifications can be downloaded from the Yamaha website.

Yamaha website

U.S.A. and Canada:

<https://uc.yamaha.com/support/>

Other countries:

<https://download.yamaha.com/>

IMPORTANT: This must be enabled for this unit to link to the RM-CR signal processor.

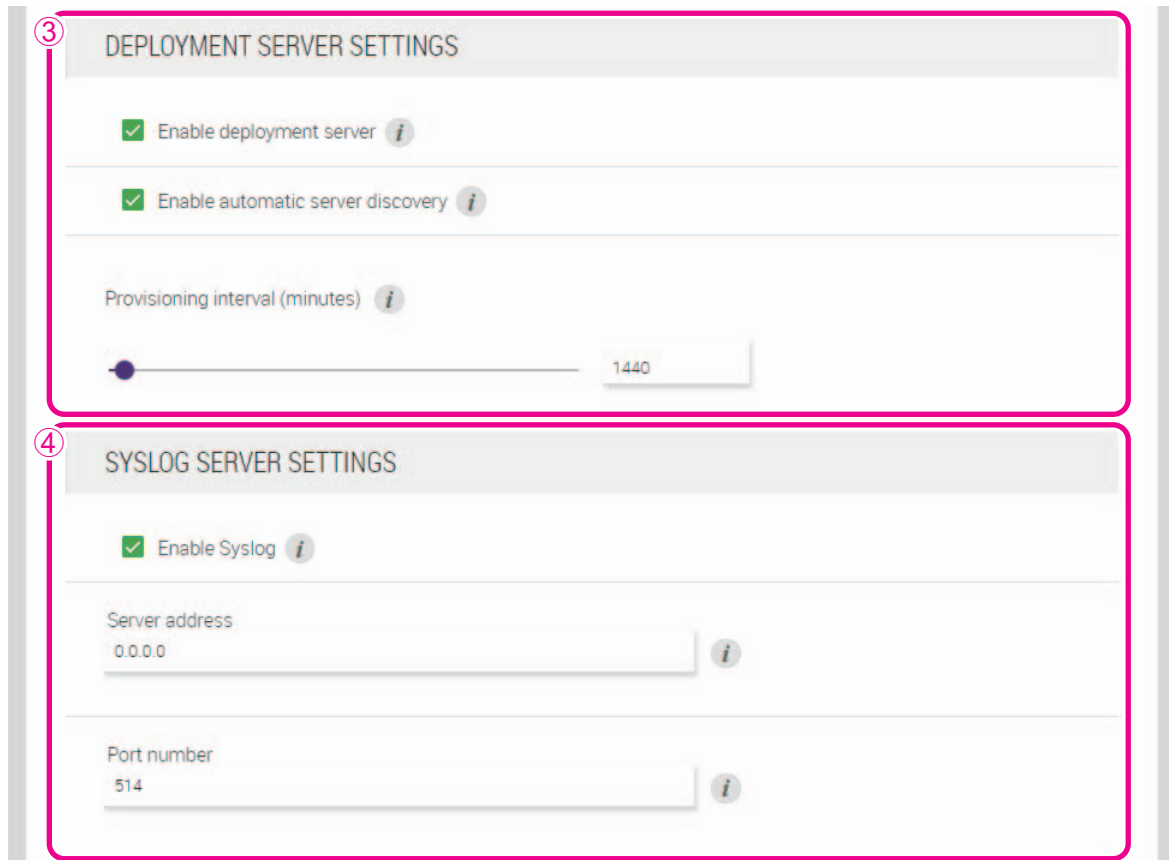

③ [DEPLOYMENT SERVER SETTINGS]

- Allows you to select whether to use a deployment server. If using a server, select whether to detect it automatically or configure it manually.
- Allows you to check/adjust the server provisioning interval.

④ [SYSLOG SERVER SETTINGS]

Allows you to select whether to use a Syslog server.

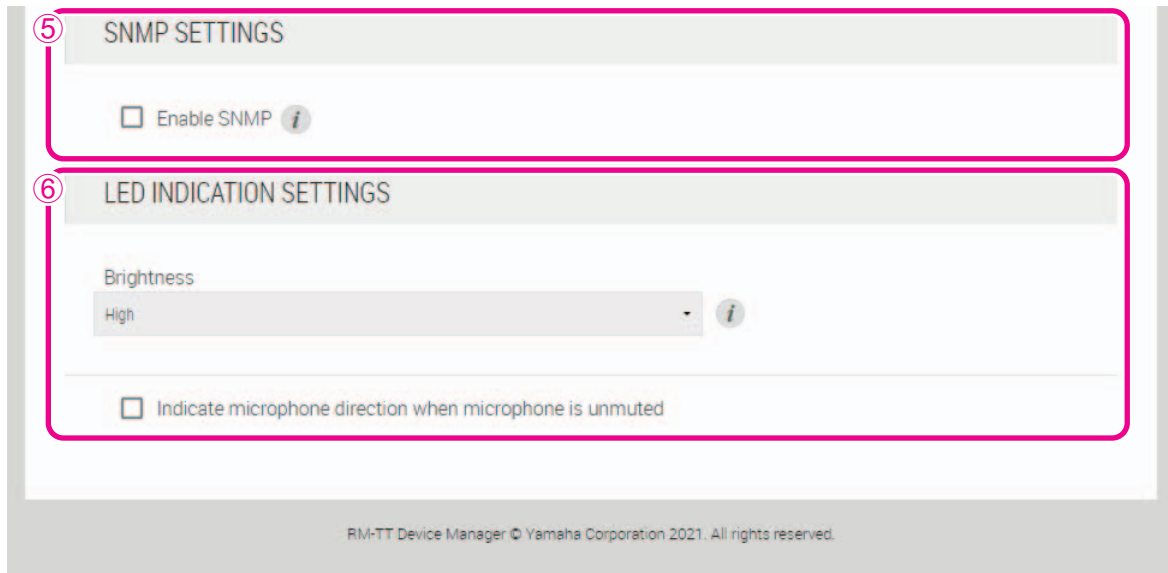

⑤ [SNMP SETTINGS]

Allows you to select whether to use SNMP.

SNMP is a protocol used to monitor and manage networks.

⑥ [LED INDICATION SETTINGS]

- Allows you to check/adjust the brightness of the front panel indicator.
- Allows you to select whether the lighting/flashing of the Status indicator varies according to the directivity of the microphone. This is available when the directivity of the microphone is set to [Cardioid], [Hypercardioid] or [Supercardioid].

[Network]

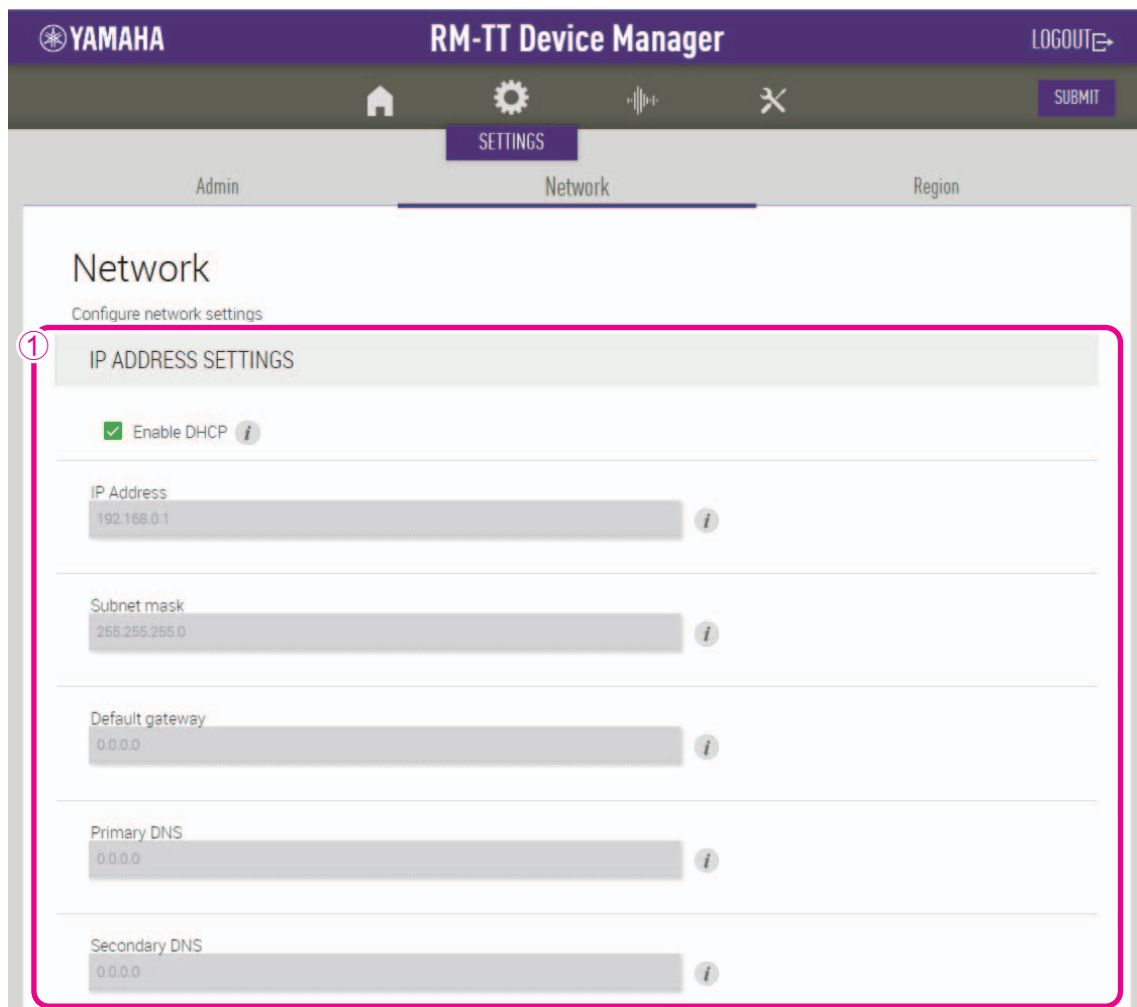

① [IP ADDRESS SETTINGS]

Allows you to select whether to use DHCP.

②

DANTE IP SETTINGS

Note: Updating the Dante firmware requires that the Dante network address be on the same subnet as the Device Network address. [?](#)

Enable DHCP *i*

IP Address
0.0.0.0 *i*

Subnet mask
0.0.0.0 *i*

Default gateway
0.0.0.0 *i*

DNS Address
0.0.0.0 *i*

③

HOST NAME SETTINGS

Mode
Yamaha Host Name using Unit ID *i*

UnitID
1 *i*

Host Name
Y001-Yamaha-RM-TT-123456 *i*

② [DANTE IP SETTINGS]

- Allows you to specify settings for the network used by Dante.
- Allows you to select whether to use DHCP.

③ [HOST NAME SETTINGS]

Allows you to select whether to specify the host name of this unit automatically or manually.

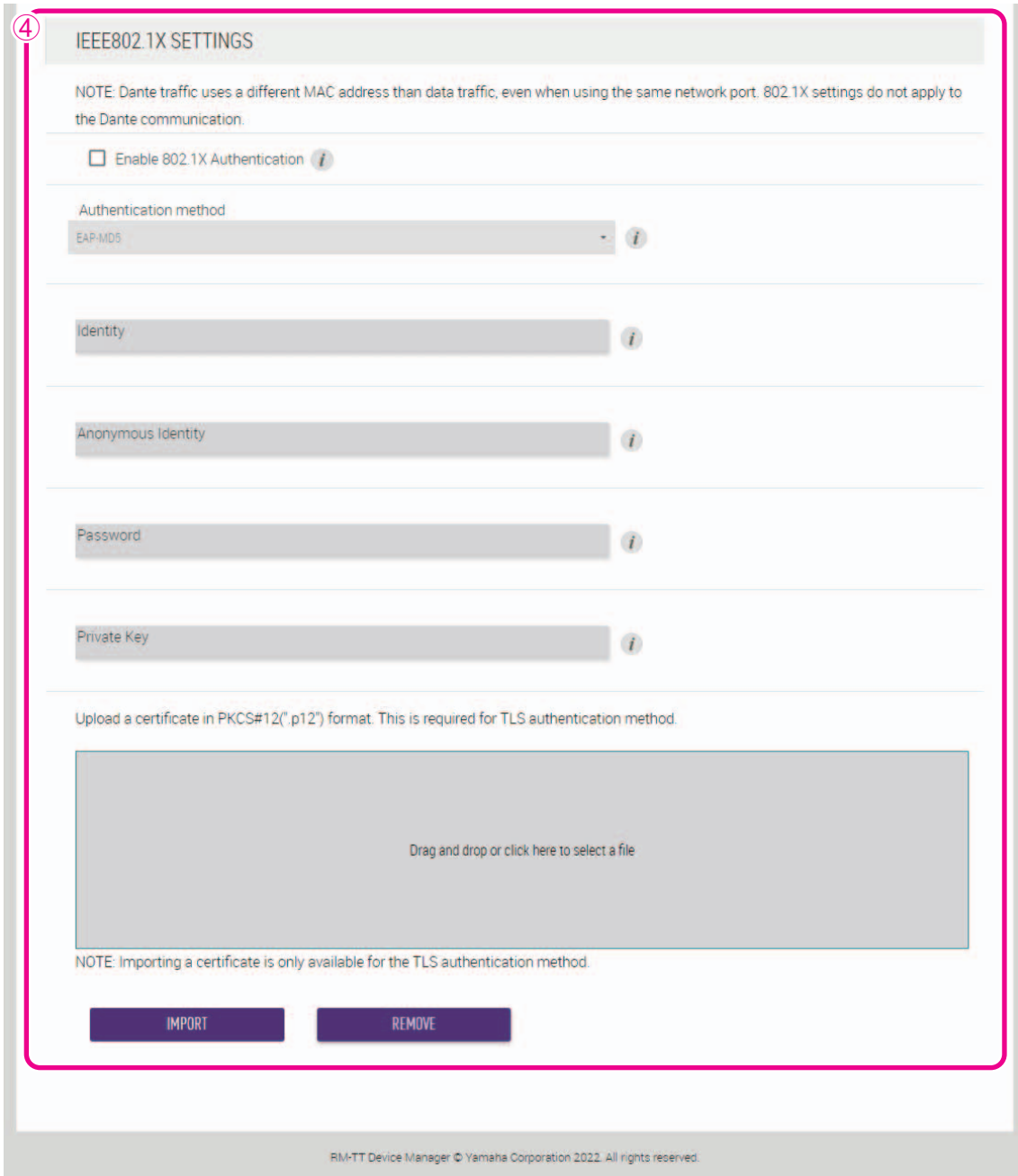

④ [IEEE802.1X SETTINGS]

- Allows you to select whether to use IEEE802.1X authentication.
- Allows you to select the authentication method.
- Allows you to upload a certificate.
- Allows you to delete a certificate.

[Region]

YAMAHA RM-TT Device Manager LOGOUT

Admin Network **Region**

Region

Configure region settings

① **SYSTEM SETTINGS**

Time zone
0:00 GMT

② **TIME SETTINGS**

NTP support

Network time server 1

Network time server 2

Network time server 3

Network time server 4

③ **DAYLIGHT SAVING SETTINGS**

Enable Daylight Saving Time adjustment

Daylight Saving Time start time

Month: January Week: First Day: Monday Hour: 00:00

Daylight Saving Time end time

Month: January Week: First Day: Monday Hour: 00:00

① [SYSTEM SETTINGS]

Allows you to specify the time zone.

② [TIME SETTINGS]

Allows you to select whether to use NTP.

③ [DAYLIGHT SAVING SETTINGS]

Allows you to select whether to use daylight saving time with this unit.

[AUDIO]

[Processing]

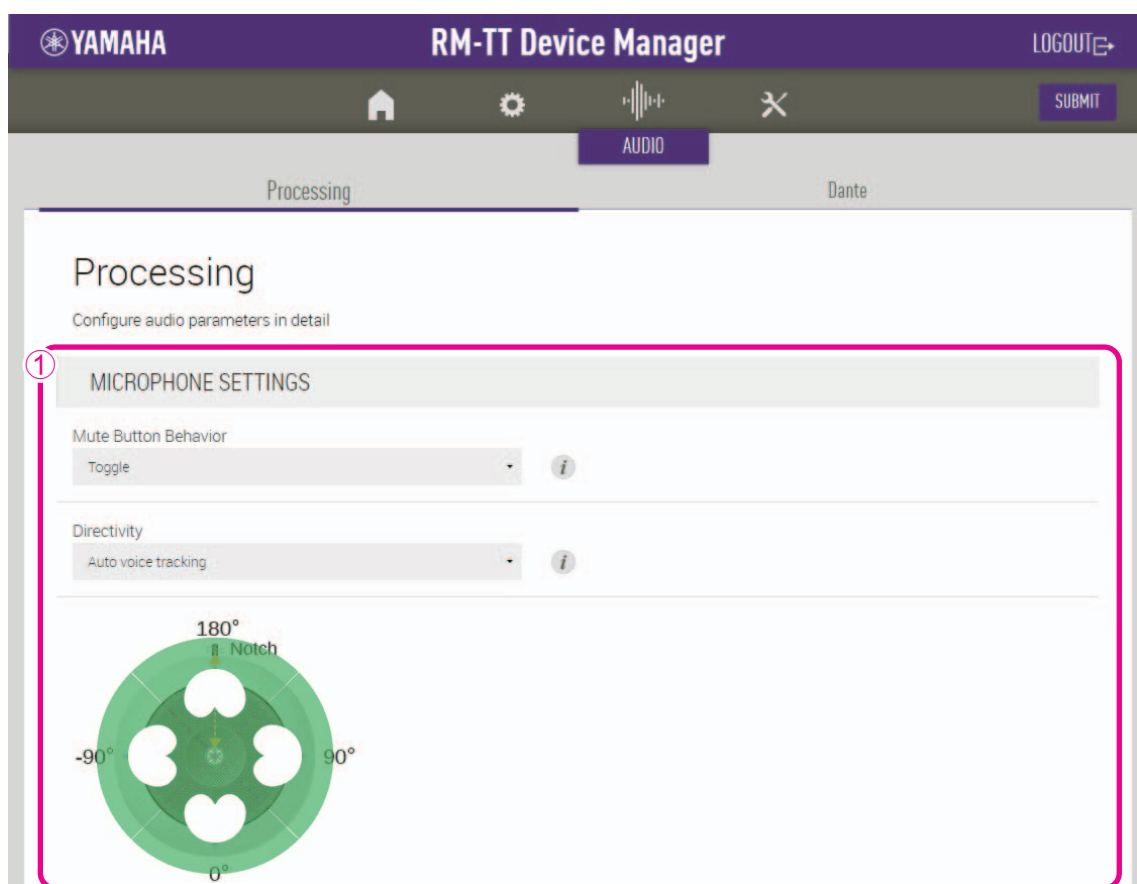

① [MICROPHONE SETTINGS]

- Allows you to set the operation of the Mic button to one of the following.
 - [Toggle]: Turn on/off the microphone by touching the Mic button.
 - [Push to talk]: The microphone is on while the Mic button is touched.
 - [Disable]: The Mic button is deactivated.
- Allows you to set the directivity of the microphone to one of the following.
 - Auto voice tracking
 - Cardioid
 - Hypercardioid
 - Supercardioid
 - Non-directional
 - Bidirectional
 - Toroid

NOTE: When the directivity of the microphone is set to [Cardioid], [Hypercardioid] or [Supercardioid], you can check/change the automixer settings.

②

DIGITAL SIGNAL PROCESSING SETTINGS

Input gain

21dB

Adaptive echo canceller

Medium

Noise reduction

Medium

Dereverberation

Medium

AGC type

High

AGC speed

Low

Enable low latency mode on Ch.2

Audio processing diagram

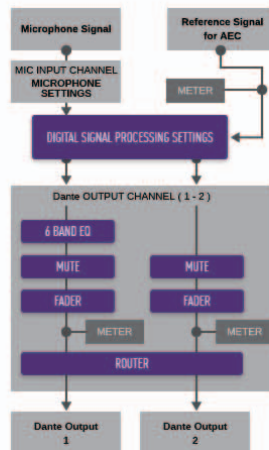

RM-TT Device Manager © Yamaha Corporation 2022. All rights reserved.

② [DIGITAL SIGNAL PROCESSING SETTINGS]

Ch. 1 handles audio signals for remote sites, and Ch. 2 can be used for microphone input signals.

- Allows you to check/change settings for the following.

| | Ch. 1 | Ch. 2 | |
|-------------------------|-------|--------------------|----|
| | | Low latency mode | |
| | | OFF | ON |
| Input gain | ✓ | ✓ | ✓ |
| Adaptive echo canceller | ✓ | Partial processing | — |
| Noise reduction | ✓ | Partial processing | — |
| Dereverberation | ✓ | — | — |
| Auto gain control type | ✓ | — | — |
| Auto gain control speed | ✓ | — | — |

- To bypass Ch. 2's adaptive echo canceller and noise reduction, select the [Enable low latency mode on Ch.2] check box. This reduces delay and can be used for the audio signal of your local site. Use this function when using only the RM-TT.
- Click a button in the [Audio processing diagram] to open a window for checking/changing parameters for digital signal processing.

IMPORTANT: Parameter changes are immediately reflected in the acoustics of the unit.

[Dante]

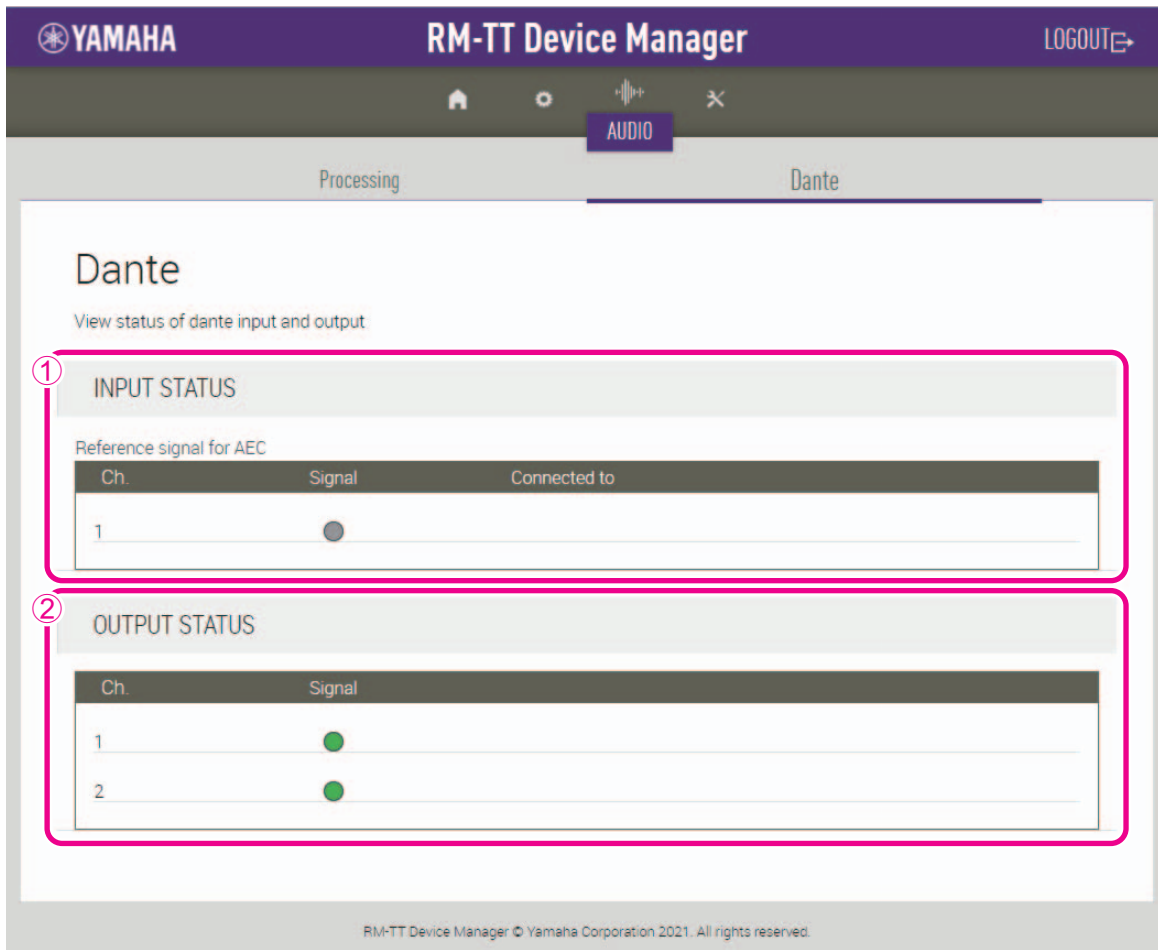

① **[INPUT STATUS]**

Allows you to check the Dante input status for each connected device.

② **[OUTPUT STATUS]**

Allows you to check the Dante output status for each connected device.

[TOOLS]

[Update]

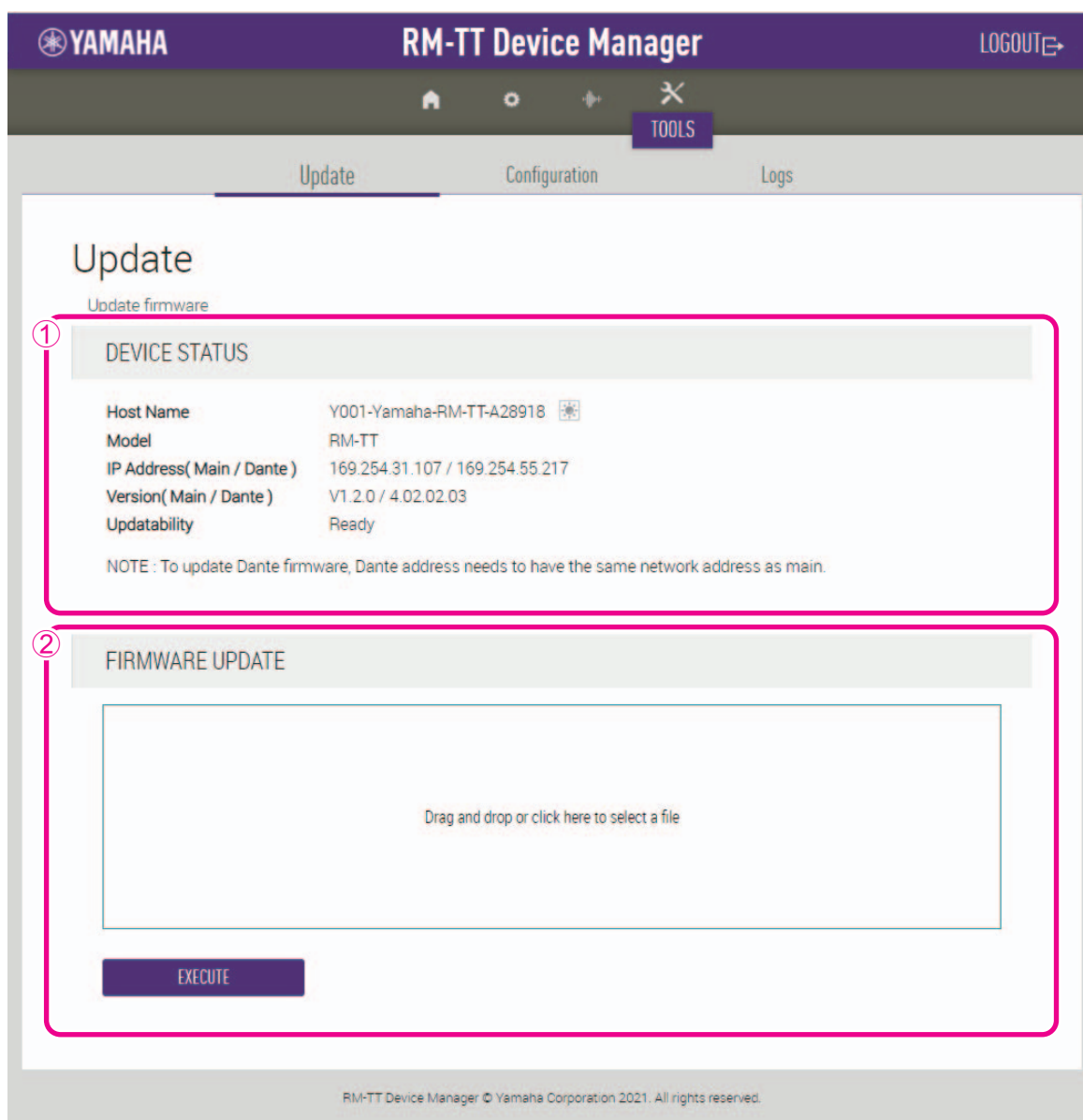

YAMAHA RM-TT Device Manager LOGOUT

Update Configuration Logs

Update

Update firmware

① **DEVICE STATUS**

| | |
|----------------------------|---------------------------------|
| Host Name | Y001-Yamaha-RM-TT-A28918 |
| Model | RM-TT |
| IP Address(Main / Dante) | 169.254.31.107 / 169.254.55.217 |
| Version(Main / Dante) | V1.2.0 / 4.02.02.03 |
| Updatability | Ready |

NOTE: To update Dante firmware, Dante address needs to have the same network address as main.

② **FIRMWARE UPDATE**

Drag and drop or click here to select a file

EXECUTE

RM-TT Device Manager © Yamaha Corporation 2021. All rights reserved.

① [DEVICE STATUS]

Allows you to check the versions of the firmware and Dante of this unit. The firmware and Dante of this unit can be updated when [Ready] appears below [Updatability].

IMPORTANT: In order to update Dante, the network portion of this unit's IP address and the network portion of Dante's IP address must be the same.

② [FIRMWARE UPDATE]

Allows you to update the firmware and Dante collectively or individually by dragging and dropping the update file(s) into the box, then clicking the [EXECUTE] button.

The files for the latest firmware can be downloaded from the Yamaha website.

Yamaha website

U.S.A. and Canada:

<https://uc.yamaha.com/support/>

Other countries:

<https://download.yamaha.com/>

[Configuration]

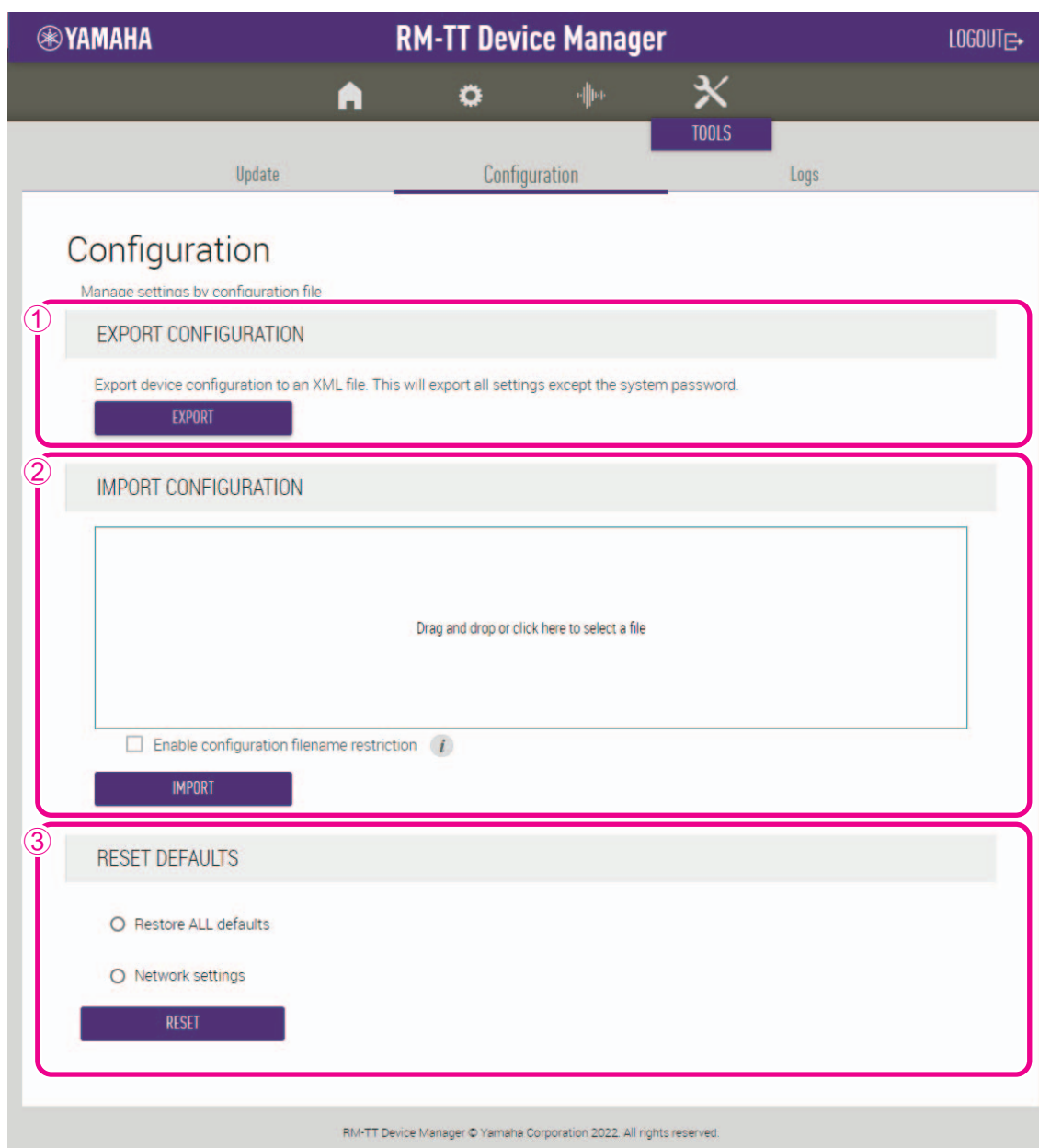

① [EXPORT CONFIGURATION]

Allows you to export the settings of this unit by clicking the [EXPORT] button.

② [IMPORT CONFIGURATION]

Allows you to import settings into this unit by dragging and dropping the settings file into the box, then clicking the [IMPORT] button.

NOTE: Create the settings file to be imported by editing the one exported in ①.

③ [RESET DEFAULTS]

Allows you to reset the settings of this unit by clicking the [RESET] button.

IMPORTANT: Be sure to check what is to be reset before doing it.

[Logs]

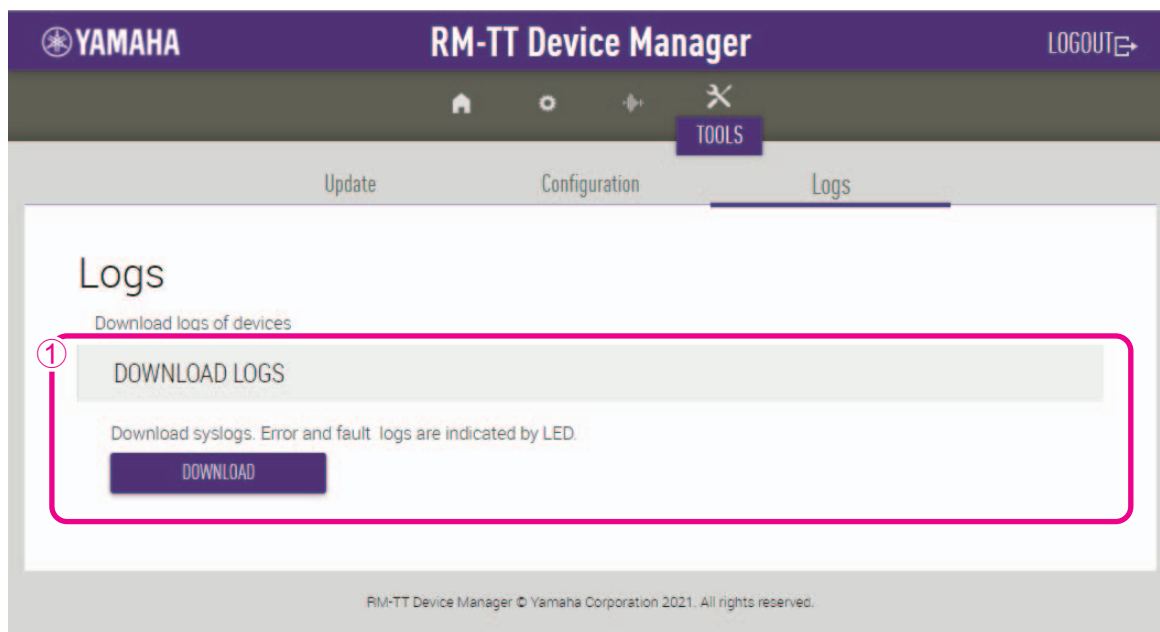

① [DOWNLOAD LOGS]

Allows you to download logs by clicking the [DOWNLOAD] button.

NOTE: Be sure to read alert log list on the following pages for explanations on the displayed alert log and the recommended solutions.

Alert log list

| Display | Description | What to do |
|--|---|---|
| important mic CH* broken | Important mic CH* broken. | Please contact your Yamaha dealer. |
| Dante hardware error | Dante has not started up correctly. | Turn the power off, then turn the power on after waiting at least six seconds. If this does not solve the problem, please initialize the memory. Should this also fails, contact your Yamaha dealer. |
| Firmware update failed, because of * | Failure of firmware update has occurred. | Check firmware file on the firmware update pages of Web GUI. |
| Firmware update failed, because of internal error | | Turn the power off, then turn the power on after waiting at least six seconds. If this does not solve the problem, please contact your Yamaha dealer. |
| Web UI internal failure | Internal failure has occurred in Web GUI. | Turn the power off, then turn the power on after waiting at least six seconds. If this does not solve the problem, please initialize settings. Should this also fails, contact your Yamaha dealer. |
| failed to start audio proc | The device audio has not started up correctly. | Turn the power off, then turn on after waiting at least six seconds. If this does not solve the problem, please initialize the memory. Should this also fails, contact your Yamaha dealer. |
| System error | The device has not started up correctly. | |
| Power unstable | The device is not supplying power normally. | Connect to a PoE compatible switch. If this does not solve the problem, please turn the power off, then turn on after waiting at least six seconds. Should this also fail, contact your Yamaha dealer. |
| Syslog setting error | Failed to update syslog transfer servers. | Turn the power off, then turn the power on after waiting at least six seconds. If this does not solve the problem, please initialize settings. |
| logging error | Failed to restart logging. | |
| Automatic audio tuning failed, because of internal error. | Automatic audio tuning has failed, because internal error has occurred. | Turn the power off, then turn the power on after waiting at least six seconds. Please try again. If this does not solve the problem, contact your Yamaha dealer. |
| Dante started in fail safe mode | Dante has started in failsafe mode. | Execute Failsafe Recovery using Audinate's firmware update tool. |
| Unable to configure Dante, because the Dante device is locked. | Dante is currently limited to control settings, because the device is locked. | Unlock device lock using Dante Controller or check Dante Domain Manager settings. |
| Resume data lost | The settings saved in internal memory has been lost. | Initialize the memory. If this dose not solve the problem, contact your Yamaha dealer. |
| Saving setting data failed | The device has not started up correctly. | Turn the power off, then turn the power on after waiting at least six seconds. If this does not solve the problem, please initialize the memory. Contact your Yamaha dealer if problem still exists. |
| CPU temperature too high | CPU temperature has been too high. | Turn the power off, let the CPU cool down. Turn the power on again. If the temperature is still too high, check the installation environment and whether dirt or a foreign object could have clogged the cooling fan, and clean the fan if necessary. |

| Display | Description | What to do |
|--|---|---|
| Too many devices on the network | Too many devices are connected to the network. | Reduce the number of devices connected to the network. |
| Configuration import failed, because of file download failure (*) | Configuration import has failed, because of file download failure. | Check network, server address settings, existence of configuration file at server. |
| Configuration import failed, because of file format error (*) | Configuration import has failed, because of file format error. | Check contents and format of configuration file. |
| Configuration import transfer failed, because of wrong filename or peripheral disconnected (*) | Configuration import transfer has failed, because of wrong filename or peripheral disconnected. | Check file name and connection status of peripheral device. |
| Configuration import failed, because the system is busy (*) | Configuration import has failed, because of system busy. | Check device status and try again. If it is still not working, please update firmware or reset all of the settings. |
| Configuration import failed, because of internal error (*) | Configuration import has failed, because of internal error. | Try again. If its not working again, please update firmware or reset all of settings. |
| Schedule data lost | The schedule data saved in internal memory has been lost. | If this occurs often, contact your Yamaha dealer. |
| Peripheral communication error | A peripheral device within the system was not found on the network. | Power-on all peripheral devices in the system, and make sure that they are correctly connected to the network. |
| Factory reset failed | Factory reset has failed. | - |
| * reset failed | Partial reset has failed. | |
| Web UI login failure by * | Web GUI login failure has occurred by (IP address). | Check password. |
| Scheduling event failed, because of * | Scheduling event has failed. | Check the number of scheduled events. |
| Audio processing restarted | Audio processing failure has occurred, then restarted. | If this occurs often, contact your Yamaha dealer. |
| SNMP error | SNMP operation has failed to start. | Turn the device off, then on again after waiting at least six seconds. If this does not solve the problem, initialize the memory. Contact your Yamaha dealer if the problem persists. |
| IEEE802.1X restart failed | Failed to start the IEEE802.1X operation. | Turn the unit off, then on again after waiting at least six seconds. Contact your Yamaha dealer if the problem persists. |

MAIN SPECIFICATIONS

General specifications

| | | |
|---|--------------------|--|
| Dimensions | | W 140.0 mm × D 140.0 mm × H 40.0 mm (excluding protrusions) |
| Weight | | 310 g |
| Power requirements | | PoE (IEEE802.3af), DC48 V |
| Maximum power consumption | | 4.5 W |
| In operation | Temperature | 0 °C – 40 °C |
| | Humidity | 30% – 90% (no condensation) |
| Storage | Temperature | –20 °C – 60 °C |
| | Humidity | 20% – 90% (no condensation) |
| Indicators | | <ul style="list-style-type: none"> • Mic • Status • Network port |
| Maximum number of connections to RM-CR | | 14 (maximum 16 when not using VXL1-16P) |
| Accessories | | <ul style="list-style-type: none"> • Tabletop mounting adaptor : 1 • Mounting screw : 3 • Spacer : 3 • Installation Manual : 1 |

Network specifications

| | |
|-----------------------|--|
| Dante/PoE port | <ul style="list-style-type: none"> • Dante audio/Dante control • Remote control • PoE • Cable requirements: CAT5e or higher, STP |
|-----------------------|--|

Audio specifications

| | |
|--|---|
| Frequency response | 160 Hz – 16 kHz (–10 dB) |
| Sampling rate | 48 kHz |
| Bit depth | 24-bit |
| Latency | Default <ul style="list-style-type: none"> • 46 [ms] (with directivity other than toroid) • 50 [ms] (with toroid directivity) |
| | Low latency mode <ul style="list-style-type: none"> • 20 [ms] (with directivity other than toroid) • 23 [ms] (with toroid directivity) |
| Audio input/output (Dante) | 1in×2out <ul style="list-style-type: none"> • In1 : AEC reference signal • Out1 : output of beam mix • Out2 : output of beam mix (simple processed) |
| Maximum input level of SPL (0 dBFs) | 106.8 dB SPL |
| Self noise | 6.3 dBA SPL |
| SNR (Ref. 94 dB SPL at 1 kHz) | 87.7 dBA |
| Sensitivity | –12.8 dBFS/Pa |
| Dynamic range | 100.5 dBA |
| Signal processing | <ul style="list-style-type: none"> • Auto voice tracking • Selectable polar pattern: Cardioid, Hypercardioid, Supercardioid, Omnidirectional, Bidirectional, Toroid • AEC, NR, Dereverberation, Auto Mixer, AGC, User PEQ, Output gain |