

Yamato

Desktop Type Low Constant Temperature Water Bath

Model

BBL101/301

Instruction Manual

- First Edition -

- Thank you for purchasing "Low Constant Temperature Water Bath, BBL Series" of Yamato Scientific Co., Ltd.
- To use this unit properly, read this "Instruction Manual" thoroughly before using this unit. Keep this instruction manual around this unit for referring at anytime.



WARNING!:

Carefully read and thoroughly understand the important warning items described in this manual before using this unit.

Yamato Scientific Co. LTD.

◆ Cautions in Using with Safety	5
• Explanation.....	5
• Table of Illustrated Symbols	6
• Fundamental Matters of "WARNING!" and "CAUTION!"	7
◆ Before Using This Unit	8
• Requirements for Installation.....	8
• Installation Procedure.....	11
◆ Description and Function of Each Part	13
• Main Unit	13
• Control Panel.....	14
• Characters of the Controller	15
◆ Operation Method	16
• Operation Mode and Function List	16
• Operation Mode, Function Setting Key, and Characters	18
• Setting of Overheating Prevention Device	19
• Fixed Temperature Operation.....	20
• Quick Auto Stop Operation	22
• Auto Stop Operation	23
• Auto Start Operation.....	25
• Calibration Offset Function.....	27
• Lock Function	28
• Temperature Output Terminal.....	29
• RS485 Communication Function.....	31
• Cooling curve, cooling capacity curve (reference data).....	43
• Flow Rate and Head (reference data)	44
• Nybrine Freezing Temperature and Viscosity (reference data)	45
• Device to Install (reference data)	46
◆ Handling Precautions	47
◆ Maintenance Method	50
• Daily Inspection and Maintenance	50
◆ Long storage and disposal	52
• When not using this unit for long term / When disposing	52
◆ In the Event of Failure	53
• Safety Device and Error Code.....	53
• Trouble Shooting	54

◆ After Service and Warranty	55
◆ Specification	56
◆ Wiring Diagram	57
◆ Piping Diagram	58
◆ Replacement Parts Table	59
◆ Reference	60
• List of Dangerous Substances	60
◆ Installation Standard Manual	61

Explanation

MEANING OF ILLUSTRATED SYMBOLS

Illustrated Symbols

Various symbols are used in this safety manual in order to use the unit without danger of injury and damage of the unit. A list of problems caused by ignoring the warnings and improper handling is divided as shown below. Be sure that you understand the warnings and cautions in this manual before operating the unit.

 **WARNING!** If the warning is ignored, there is the danger of a problem that may cause a serious accident or even fatality.

 **CAUTION!** If the caution is ignored, there is the danger of a problem that may cause injury/damage to property or the unit itself.

Meaning of Symbols



This symbol indicates items that urge the warning (including the caution). A detailed warning message is shown adjacent to the symbol.



This symbol indicates items that are strictly prohibited. A detailed message is shown adjacent to the symbol with specific actions not to perform.



This symbol indicates items that should be always performed. A detailed message with instructions is shown adjacent to the symbol.

Table of Illustrated Symbols

Warning



Warning,
generally

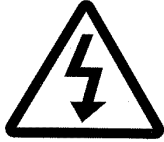

Warning,
high voltage



Warning,
high temperature



Warning,
drive train



Warning,
explosive

Caution



Caution,
generally



Caution,
electrical shock



Caution,
scald



Caution,
no road heating



Caution,
not to drench



Caution,
water only



Caution,
deadly poison

Prohibit



Prohibit,
generally



Prohibit,
inflammable



Prohibit,
to disassemble



Prohibit,
to touch

Compulsion



Compulsion,
generally



Compulsion,
connect to the
grounding
terminal



Compulsion,
install on a flat
surface



Compulsion,
disconnect the
power plug



Compulsion,
periodical
inspection

Cautions in Using with Safety

Fundamental Matters of "WARNING!" and "CAUTION!"

WARNING!

Do not use this unit in an area where there is flammable or explosive gas

Never use this unit in an area where there is flammable or explosive gas. This unit is not explosion-proof. An arc may be generated when the power switch is turned on or off, and fire/explosion may result. (Refer to page 60 "List of Dangerous Substances".)

Always ground this unit

Always ground this unit on the power equipment side in order to avoid electrical shock due to a power surge.

If a problem occurs

If smoke or strange odor should come out of this unit for some reason, turn off the circuit breaker right away, and then disconnect the power plug. Immediately contact a service technician for inspection. If this procedure is not followed, fire or electrical shock may result. Never perform repair work yourself, since it is dangerous and not recommended.

Do not use the power cord if it is bundled or tangled

Do not use the power cord if it is bundled or tangled. If it is used in this manner, it can overheat and fire may be caused.

Do not process, bend, wring, or stretch the power cord forcibly

Do not process, bend, wring, or stretch the power cord forcibly. Fire or electrical shock may result.

Substances that can not be used

Never use explosive substances, flammable substances and substances that include explosive or flammable ingredients in this unit. Explosion or fire may occur. (Refer to page 60 "List of Dangerous Substances".)

Do not disassemble or modify this unit

Do not disassemble or modify this unit. Fire or electrical shock or failure may be caused.

Do not touch high-temperature parts

The inside of the body or the door may become hot during and just after operation. It may cause burns.

CAUTION!

During a thunder storm

During a thunderstorm, turn off the power key immediately, then turn off the circuit breaker and the main power. If this procedure is not followed, fire or electrical shock may be caused.

Requirements for Installation

WARNING!

1. Choose a proper place for installation



- Do not install this unit in a place where:
 - ◆ Rough or dirty surface.
 - ◆ Flammable gas or corrosive gas is generated.
 - ◆ Ambient temperature above 30°C.
 - ◆ Ambient temperature fluctuates violently.
 - ◆ There is direct sunlight.
 - ◆ There is excessive humidity and dust.
 - ◆ There is a constant vibration.
 - ◆ Winds from the air conditioner, etc. hit the sample container directly.



- Install this unit on a stable place with the space as shown below.

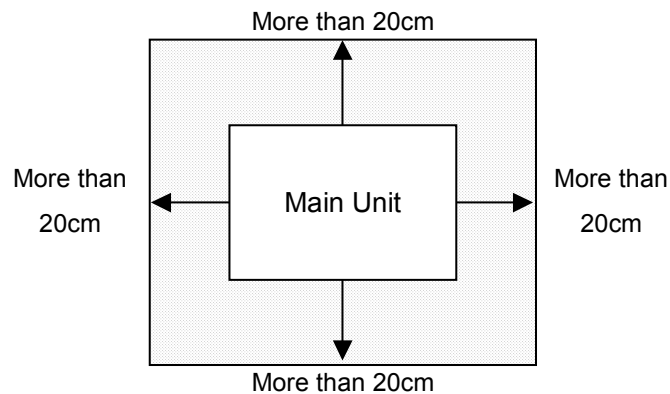

2. Installation on horizontal surface



- Place this unit as flat a place as possible. If the four feet are not in uniform contact with the floor surface, noise or vibration may result.



- Additionally, the unit may cause a problem or malfunction.
- Weight of unit is BBL101 type: 50kg BBL301 type: 55kg. Conveyance and installation should be done carefully by two or more persons.

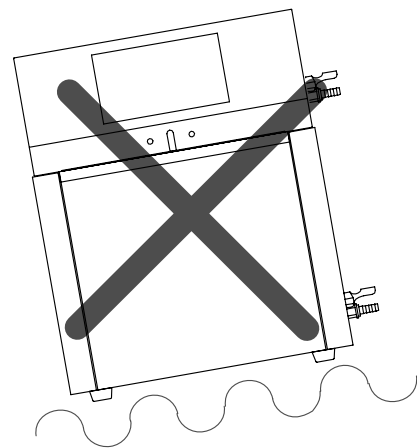

3. Before/after installing



- It may cause injure to a person if this unit falls down or moves by the earthquake and the impact. etc..To prevent, take measures that the unit cannot fall down, and not install to busy place.

Requirements for Installation

4. Secure the ventilation of device



- Do not operate while the device side/back is obstructed. The temperature inside the device rises and may become the cause of an accident, a failure and a fire.

5. Do not use in the place that the device is exposed to liquid



- Do not operate in the place that the device is exposed to liquid. If liquid go inside of the device, it will become the cause of an accident, failure, an electric shock, and a fire.

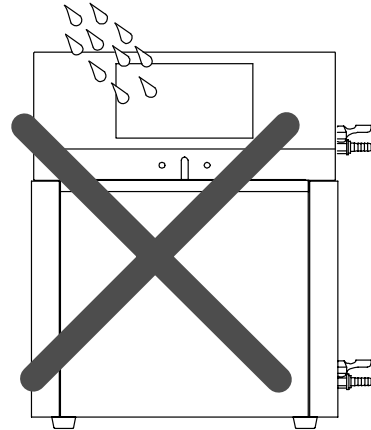

6. Do not use this unit in an area where there is flammable or explosive gas



- Never use this unit in an area where there is flammable or explosive gas. This unit is not explosion-proof. An arc may be generated when the power switch is turned ON or OFF, and fire/explosion may result.
- To know about flammable or explosive gas, refer to page 60 "List of Dangerous Substances".

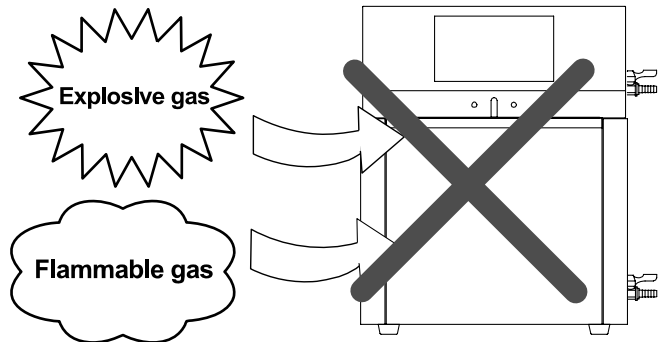

Requirements for Installation

CAUTION!

7. Choose a correct power distribution board or receptacle



- Choose a correct power distribution board or receptacle that meets the unit's rated electric capacity.

Electric capacity: BBL101: 100V AC, 9.3A
 BBL301: 100V AC, 12.5A

NOTE)

There could be the case that the unit does not run even after turning ON the power. Inspect whether the voltage of the main power is lowered than the specified value, or whether other device(s) uses the same power line of this unit. If the phenomena might be found, change the power line of this unit to the other power line.

- Starburst connection with a branching receptacle or extended wiring with a cord reel lowers electrical power voltage, which may cause the degradation of refrigeration capability.
- Connect the unit to only the power supply. If it is connected to a gas pipe, water pipe or telephone line, an accident or malfunction may result.

8. Handling of power code



- Do not entangle the power cord. This will cause overheating and possibly a fire.
- Do not bend or twist the power cord, or apply excessive tension to it. This may cause a fire and electrical shock.
- Do not lay the power cord under a desk or chair, and do not allow it to be pinched in order to prevent it from being damaged and to avoid a fire or electrical shock.
- Keep the power cord away from any heating equipment such as a room heater. The cord's insulation may melt and cause a fire or electrical shock.



- If the power cord becomes damaged (wiring exposed, breakage, etc.), immediately turn off the power at the rear of this unit and shut off the main supply power. Then contact your nearest dealer for replacement of the power cord. Leaving it may cause a fire or electrical shock.
- Connect the power plug to the receptacle which is supplied appropriate power and voltage.

9. Always ground this unit



- Be sure to connect the earth wire (the green cable of power cord) to the grounding conductor or ground terminal to prevent accidents caused by electric leakage.



- Do not connect the earth wire to gas or water pipes. If not, fire disaster may be caused.
- Do not connect the earth wire to the ground for telephone wire or lightning conductor. If not, fire disaster or electric shock may be caused.
- Please consult your local electrical contractor for power connecting work.

Installation Procedure

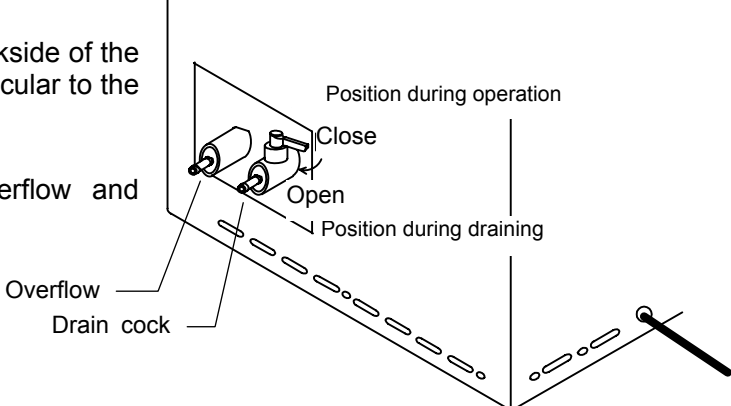
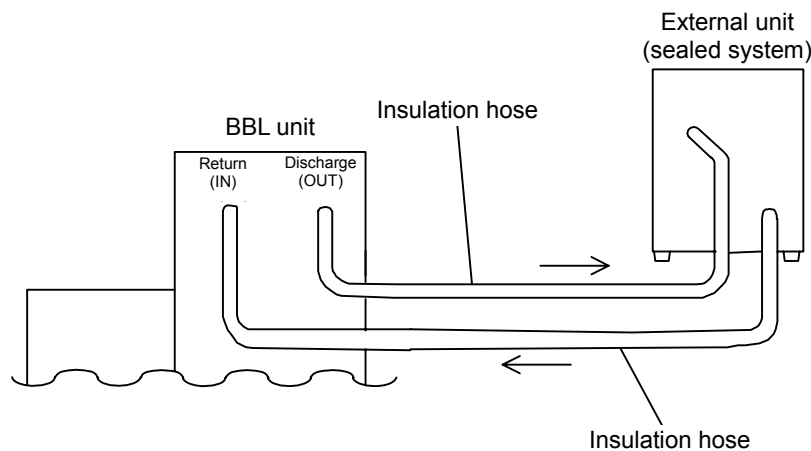
1	<p>Decide the place to put the device on. Confirm that four rubber feet of the device are on a flat place.</p>
2	<p>Check the drain cock. Confirm that the drain cock on the backside of the unit is in the "Close" position (perpendicular to the cock).</p> <p>Confirmation of overflow. Connect the attached hose for overflow and prepare a container etc. separately.</p> 
3	<p>For external sealed unit connection (The package does not include any circulation hose. Please prepare it yourself.)</p> <p>Connect the connection port of the main part to the circulation route of the external sealing system so that there may be no leakage. Connect the hose to the return port (IN) and discharge port (OUT) of the main part. The diameter of a hose nipple is $\phi 10.5$ mm. Refer to the following figure.</p> 
4	<p>Precautions about the circulating path</p> <ul style="list-style-type: none"> • Carefully check the direction of circulation, and connect the hoses properly. Improper connection results in an accident or malfunction of the unit and the circulating path. • Minimize the length of the circulating path. If resistance inside the piping increases, the quantity of circulating fluid decreases, resulting in lower cooling efficiency. For the capacity of the circulating pump, see "Flow Rate and Head (reference data)" on page 44. • Check the circulation capacity and withstand pressure of the circulating path. Excessive circulation or pressure may result in an accident or malfunction. • Do not connect any powered unit or a unit with a motor to the circulating path. It may cause an accident or failure. • When changing flux, execute the operation slowly. A rapid change of flux may damage the durability of the pump. • If the unit is to be connected to a circulation unit installed in a higher place than it, beware of the backflow of the circulating fluid. If the fluid flows back, it may overflow the water bath of the unit. Add a valve to the circulating path or take other proper measures to prevent a backflow.

Installation Procedure

5	<p>Connecting the power. Confirm that the earth leakage breaker is turned off, then connect the power plug to a receptacle.</p>
6	<p>Pour circulating fluid into the bath.</p> <ul style="list-style-type: none"> • Check overflow. Connect the attached hose for overflow to the overflow cock, and place the hose point in a container etc. Prepare a container separately. • Confirm that the drain cock is closed. Pour the circulating fluid over the level of the cooling coil. <div style="text-align: center; margin: 10px 0;"> <p>The diagram illustrates the correct fluid level in the bath. A vertical line indicates the 'Bath top' level. A horizontal dashed line represents the 'Bath' level. A vertical arrow points to the 'Proper water level', which is slightly below the bath top. Below the bath, a 'Cooling coil fixing plate' is shown with three circles representing the 'Cooling coil'. An 'Overflow hole' is also indicated at the top left of the bath assembly.</p> </div> <ul style="list-style-type: none"> • Open the drain cock and confirm that the circulating route is filled with the circulating fluid, then close the drain cock. • Go on to the next operation at this state. Turn on the earth leakage breaker and RUN/STOP key, and circulate the fluid. • As for external sealing system connection, open the discharge valve for circulation, and circulate to the refrigerator of external sealing system to be cooled. • After the resupply of the circulating fluid, turn "off" the leakage breaker. Caution) Slowly pour the circulating oil. <div style="border: 1px solid black; padding: 5px; margin-top: 10px;"> <p> Exercise care not to allow the circulating fluid to get on the unit. If it gets on any electric part, leakage or electric shock may result. If it splashes on the operation panel, wipe it out.</p> </div>

Description and Function of Each Part

Main Unit

Front view

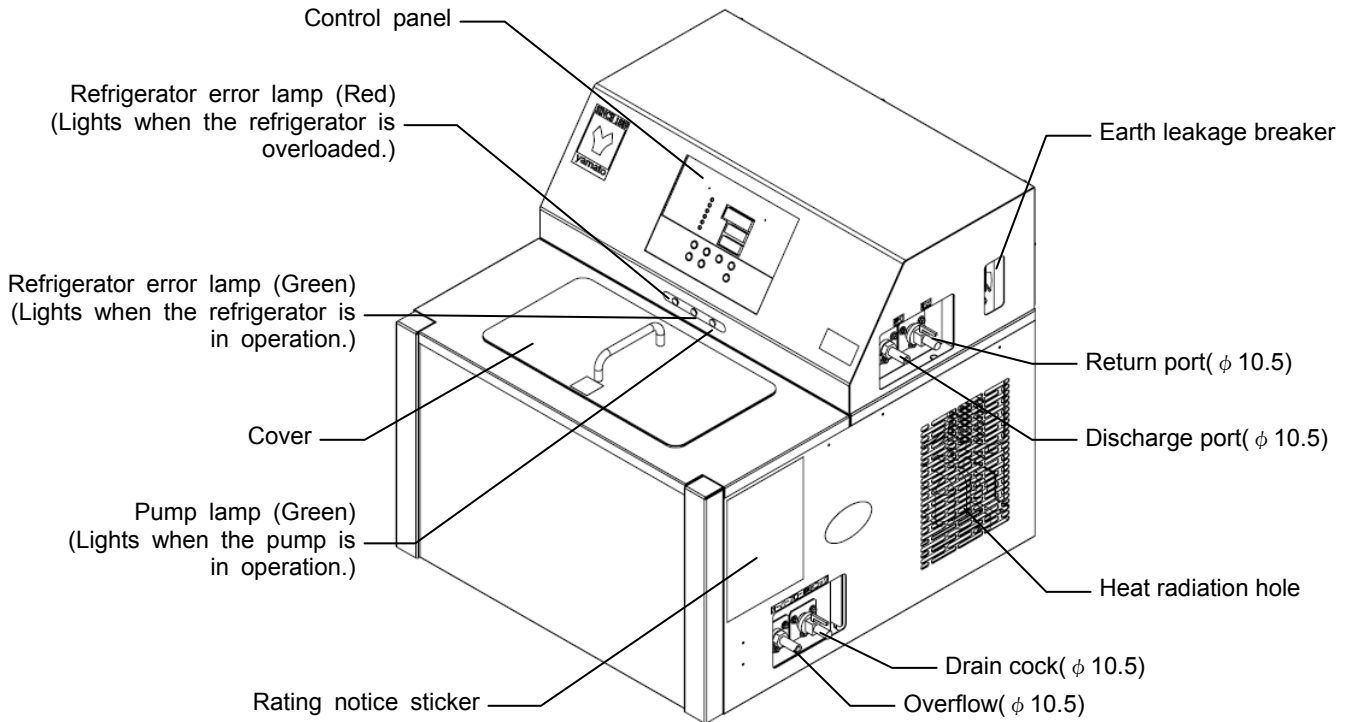

Rear view

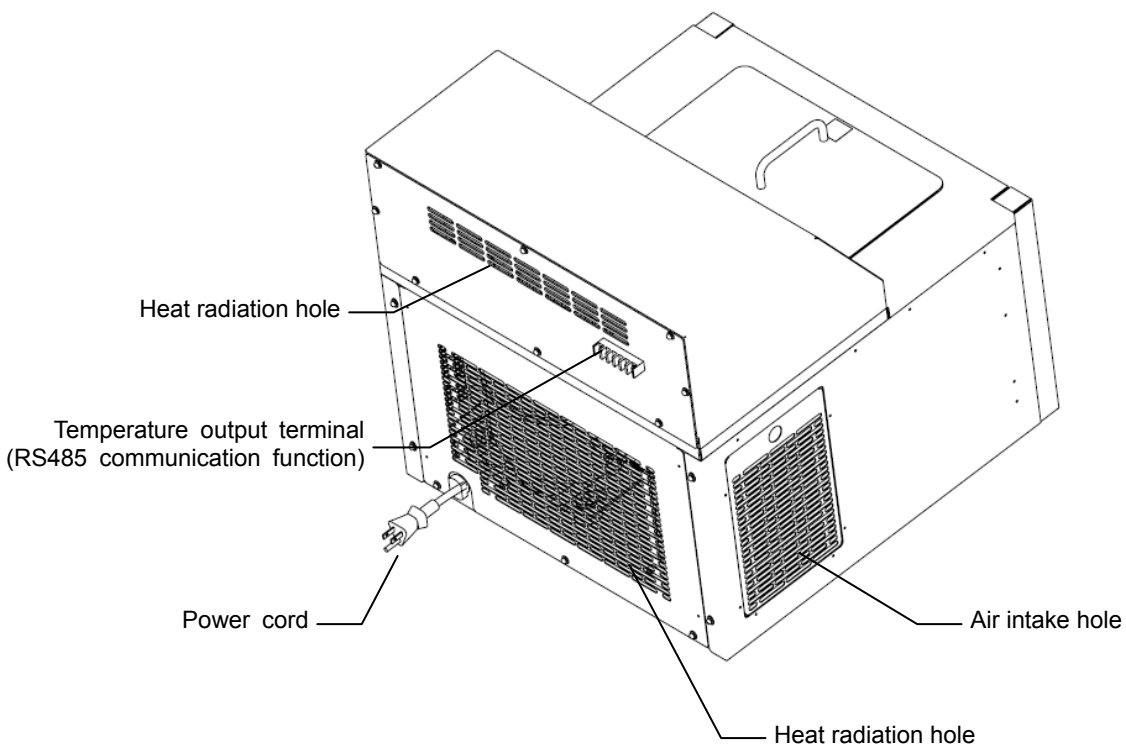

Description and Function of Each Part

Control Panel

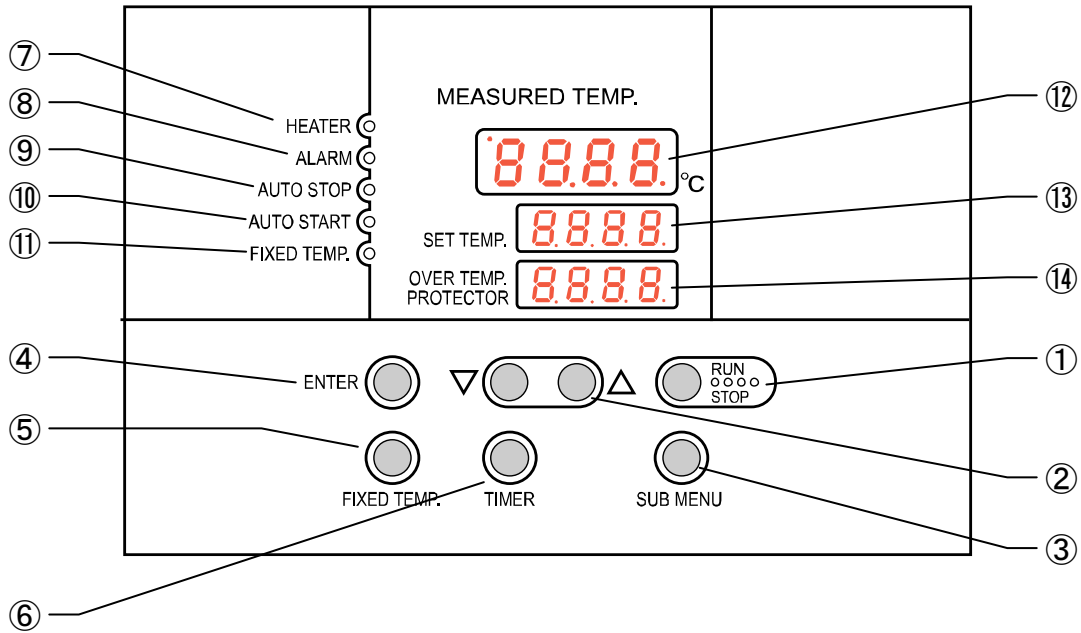







No.	Name	Function
①	RUN/STOP Key :	Starts/stops the operation.
②	▲▼ Key :	Uses for rising UP/lowering DOWN the setting value.
③	SUB MENU Key :	Uses for setting the overheating prevention temperature, calibration offset temperature, or key lock function.
④	ENTER Key :	Settles the inputted value.
⑤	FIXED TEMP Key :	Chooses the fixed temperature operation.
⑥	TIMER Key :	Chooses the timer operation (Quick Auto Stop/Auto Stop/Auto Start).
⑦	HEATER Lamp :	Lights while the heater works.
⑧	ALARM Lamp :	Lights up when an error occurs. (Buzzer sounds simultaneously.)
⑨	AUTO STOP Lamp :	Blinks while setting quick auto stop timer or auto stop timer. Lights while quick auto stop timer or auto stop timer is running.
⑩	AUTO START Lamp :	Blinks while setting auto start timer. Lights while auto start timer is running.
⑪	FIXED TEMP Lamp :	Blinks while setting fixed temperature operation. Lights while fixed temperature operation is running.
⑫	Measurement Temperature Display :	Displays the measured temperature, setting character, alarm information.
⑬	Setting Temperature Display :	Displays the setting temperature, setting value for timer mode, remaining time.
⑭	Overheating Prevention Temperature Display :	Displays the setting temperature for overheating prevention device.

Description and Function of Each Part

Characters of the Controller

The characters controller shows are as follows:

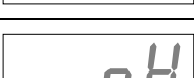
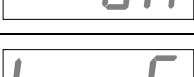
Character	Identifier	Name	Purpose
	FiX	Fixed Temperature Setting Mode	Used for setting the fixed temperature operation.
	Sv	Temperature Setting	Used for setting the temperature.
	AStP	Auto Stop Setting	Used for setting the auto stop operation.
	AStr	Auto Start Setting	Used for setting the auto start operation.
	tim	Time Setting	Used for setting the time.
	End	Time-up	Displayed when timer operation is ended.
	cAL	Calibration Offset Setting	Used for inputting the calibration offset temperature. (Refer to Page 27 "Calibration Offset Function".)
	oH	Overheating Prevention Setting	Used for setting temperature for overheating prevention device. (Refer to Page 19 "Setting of Overheating Prevention Device".)
	Lock	Key Lock	Locks the keys on control panel to protect from unnecessary operation. (Refer to Page 28 "Lock Function".)

* Also refer to Page 18 "Operation Mode, Function Setting Key, and Characters".

Operation Mode and Function List

The operation modes of this unit are as follows;

Name	Description	Page
Fixed Temperature Operation	Pressing the FIXED TEMP key enters into the fixed temperature operation setting mode. Pressing it again enters into the temperature setting mode. The "▲▼" are used to set temperature. Pressing the RUN/STOP key starts or stops operation.	20
Quick Auto Stop Operation	This operation is used to specify the period up to automatic stop during operation. The period up to operation stop can be set by pressing the TIMER key during fixed temperature operation. The "▲▼" are used to set the time. Pressing the START key starts the quick auto stop operation, activates the timer function and stops the operation automatically after specified period.	22
Auto Stop Operation	This operation is used to specify the automatic stop time in the fixed temperature operation. Pressing the TIMER key displays "AS t P". The setting temperature "Sv" can be set by pressing the ENTER key. The operation time "tim" can be set by pressing it again. Pressing the RUN/STOP key starts the auto stop operation.	23
Auto Start Operation	This operation is used to specify the period up to automatic start after power on. Pressing the TIMER key displays "AS t r". The setting temperature "Sv" can be set by pressing the ENTER key. The operation time "tim" can be set by pressing it again. Pressing the RUN/STOP key starts the auto start operation.	25

NOTE) This unit is impossible to be changed the mode during the operation. If the mode requires to be changed, stop the operation.

Operation Mode and Function List

The operation functions of this unit are as follows;

Name		Description	Page
Overheating prevention function	Auto overheating prevention function	This function is set to be automatically activated (auto reset) when the temperature exceeds the setting temperature by 6°C.	19
	Overheating prevention device	Though the device shares power source, display, and key input with the controller, it has independent temperature measurement circuit, CPU, sensor and output circuit. Overheating prevention temperature can be set using the operation panel. The unit stops operation when the device is activated. The unit starts operation again when the POWER switch is pressed again (manual reset).	
Calibration offset function		This calibration offset function is for calibrating the difference occurred between the required in- bath temperature and control temperature (sensor temperature) of the controller. This unit can be calibrated toward either plus side or minus side of the whole temperature range.	27
Setting value locking		This function locks the established operation status. It can be set and cancelled with the SUB MENU key.	28
Temperature Output Terminal		Transmits and outputs the measured temperature of the controller at 4 to 20 mA.	29
RS485 Communication Function		The function to allow communication between the VS3 controller and a personal computer or another unit. An optional RS485-RS232C conversion adapter is required for external communication. A sample program is uploaded on our website. http://www.yamato-net.co.jp/support/program/index.htm	31

Operation Mode, Function Setting Key, and Characters

The operation mode setting and function setting use the key operation and characters show in the following figure.

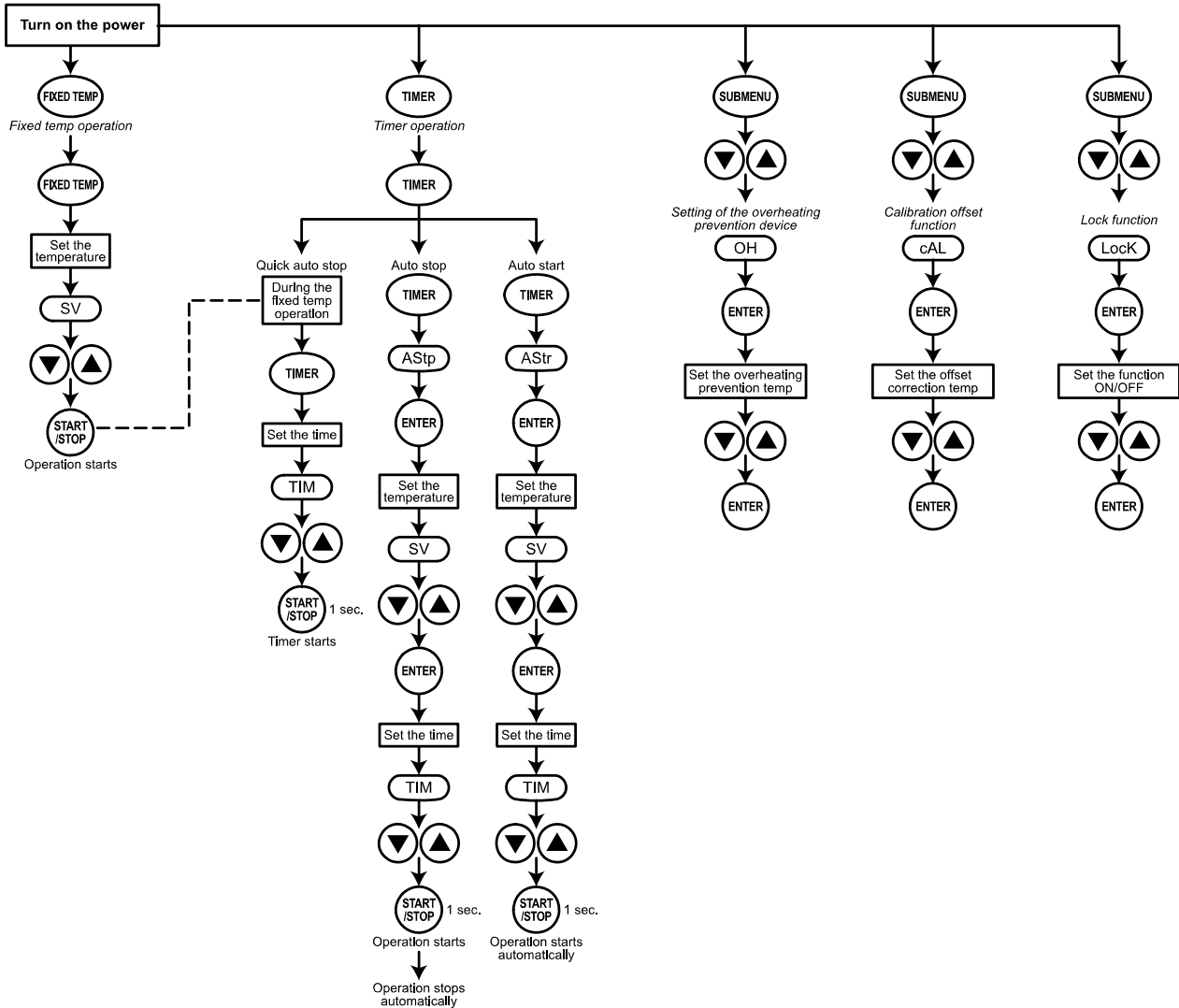

Setting of Overheating Prevention Device

The unit has the overheating prevention device (manual reset) that consists of independent temperature measurement circuit, CPU, sensor and output circuit (it shares power source, display, and key input with the controller) in addition to the automatic overheating prevention function (auto reset) in the controller.

Setting range/function

The unit has failsafe functions against overheating. One of them is built in the controller and previously set at factory shipment so to be automatically activated when the temperature exceeds the setting temperature of temperature controller by 6°C, where the heater repeats on and off.

The other is united with the controller, which can be set by operating the keys on the controller.

The setting range of latter is from 0°C to 50°C.

In case the temperature in bath exceeds the setting temperature of controller to reach to that of overheating prevention device, the circuit is shut off and "Er19" is displayed with blinking on the screen of controller with buzzer sound.

If the device is once activated, "Er19" continues to be displayed until the power is newly turned on.

Temperature setting procedure

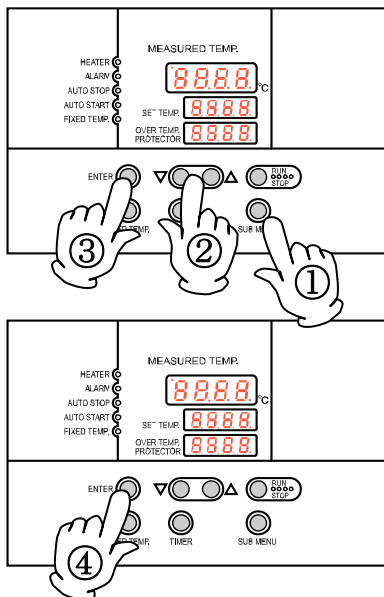

1. Turn on the power (turn on the breaker in front)

- The default value is displayed for about four seconds after turning on the power. The screen then displays the initial setting. The current temperature in bath, operation mode character and setting temperature of overheating prevention device are displayed on respective screens.

2. Set the temperature for overheating prevention

- Press the SUB MENU key.
- Press the "▼▲" several times to select the setting character of overheating prevention temperature "OH".
- Press the ENTER key. The current setting temperature is displayed with blinking on the setting temperature screen.

Note: To prevent improper operation, set the value 10°C or more over the setting temperature of controller.

- Select the value using the "▼▲" and then press the ENTER key. This completes the setting.

Notes:



- The standard setting temperature of device is "the maximum setting temperature of unit plus 10°C" or "setting temperature plus 10°C". If the unit performs improper operation, increase it 5°C more.
- The setting range of overheating prevention device is from 0°C to 50°C. Improper setting of temperature may cause inoperative of unit, malfunction of device, e.g. it is activated during increasing in temperature in bath, or unexpected accidents such as fire disaster. To prevent such matters, set a proper value.
The temperature is set to 90°C at factory shipment.
- The purpose of overheating prevention device is to protect the unit from overheating. It does not intend to protect the samples, or to protect them from the accident caused by the use of explosive or inflammability.

Fixed Temperature Operation

In this mode, the unit starts to operate by pressing RUN/STOP key and continues operating at the set temperature until RUN/STOP key is re-pressed, as shown in the figure below.

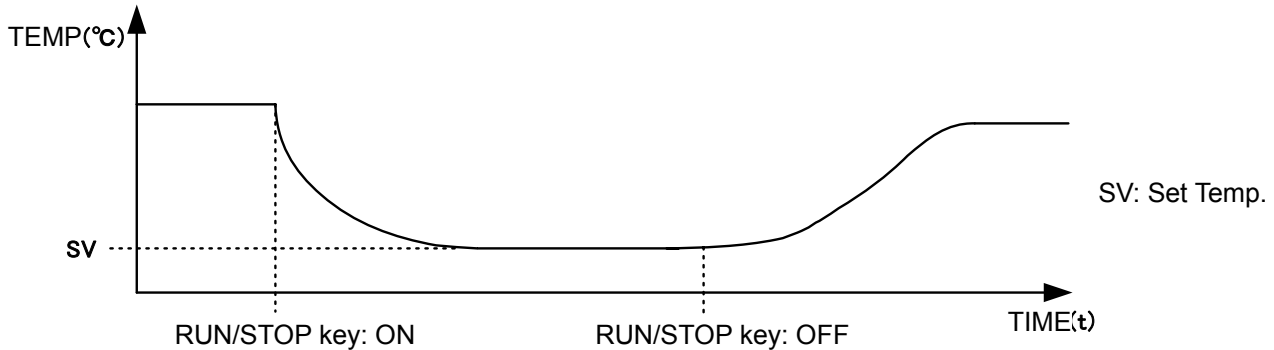

Fixed temperature operation procedure

1. Turn on the power (turn on the breaker in front)

- ❖ Current version of the software is displayed for about four seconds after turning on the power. The screen then displays the initial setting. The current temperature in bath, operation mode character and setting temperature of overheating prevention device are displayed on respective screens.

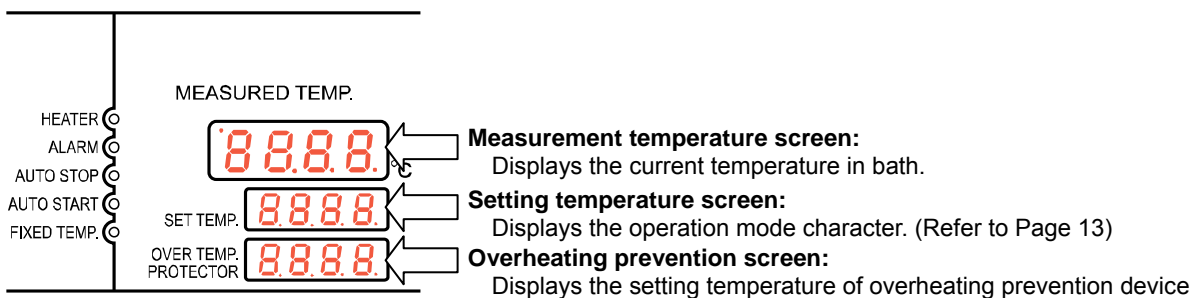

2. Select the operation mode

- Press the FIXED TEMP key to display "FIX", which indicates the fixed temperature operation, on the center display screen.

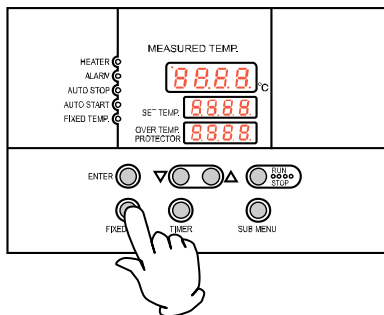

3. Set the temperature

- ① Press the FIXED TEMP key again.
The setting temperature screen displays the character "Sv" which indicates the temperature setting. Also it displays the current setting temperature with blinking. The FIXED TEMP lamp blinks, too.
- ② Set the temperature by pressing the "▼▲".
The temperature can be set to the first decimal place.

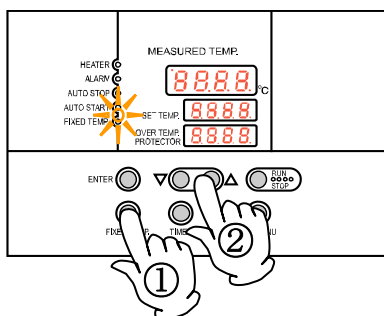

Fixed Temperature Operation

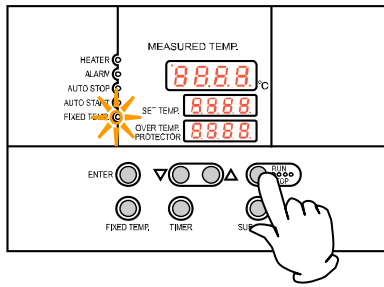

4. Start operation

- Press the orange RUN/STOP key for about one second. The unit starts operation and the blinking FIXED TEMP lamp lights on.

5. Stop operation

- Press the orange RUN/STOP key for about one second. The unit stops operation and the FIXED TEMP lamp lights off. The screen returns to the initial setting screen.

To correct or check setting...

Press the FIXED TEMP key again to correct or check the setting.

Changing the setting temperature during operation is also possible by pressing the FIXED TEMP key.

Press the ENTER key after changing the setting.

Quick Auto Stop Operation

Quick auto stop operation procedure

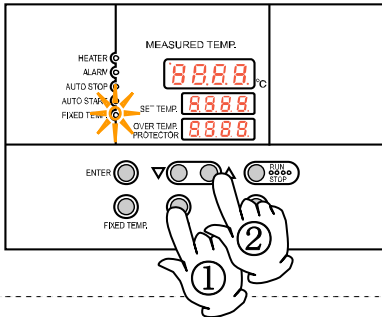

This operation is used to specify the period up to automatic stop, i.e., sets the auto stop timer during operation.

1. Set the time up to stop during fixed temperature operation

- ① Check that the FIXED TEMP lamp lights on and that the unit is under operation. Press the TIMER key. The measurement temperature display screen displays the character "tim", which indicates the timer setting. The setting temperature display screen displays the current setting time with blinking.
- ② Select the time by pressing the "▼▲".

Timer function:

- The maximum setting time is "999 hours and 50 minutes".
- The time can be set in increments of a minute under 99 hours and 59 minutes.
- It can be set in increment of ten minutes over 100 hours.
- The "▼▲" can change the setting time quickly when it is pressed continuously. Press them discontinuously when fine adjustment is needed.

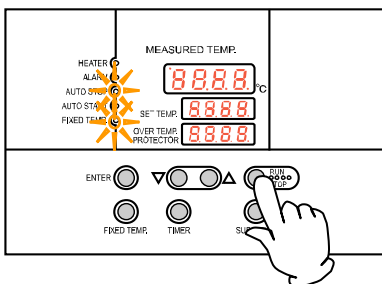

2. Start timer operation

- Press the RUN/STOP key for one second after deciding the time.
- Timer operation starts with the FIXED TEMP and AUTO STOP lamps lighting on.
- The timer is activated at the point when the RUN/STOP key is pressed.

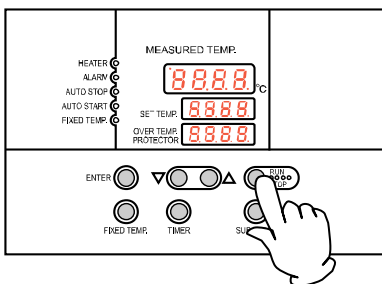

3. Stop/terminate timer operation

- The operation stops automatically at setting time.
- Buzzer continues to sound for about five minutes at operation stop.
- The setting temperature screen displays the character "End", which indicates termination of operation, with the FIXED TEMP and AUTO STOP lamps lighting on. Press the RUN/STOP key to terminate the timer operation mode. The screen returns to the initial setting screen.

To correct or check setting...

Changing the setting temperature during operation is possible by pressing the FIXED TEMP key. Press the ENTER key after changing the setting.

Changing the setting time during operation is possible by pressing the TIMER key. (Note that the time setting is required using the value calculated by adding a new additional time to the already passed time in this case.) Press the RUN/STOP key after changing the setting.

Press the ▼ key to display the setting temperature, operation mode and residual time on the setting temperature screen.

Auto Stop Operation

In this mode, the unit automatically comes to a stop after the set period passes away from the start of fixed-value operation according to timer setting, as shown in the figure below.

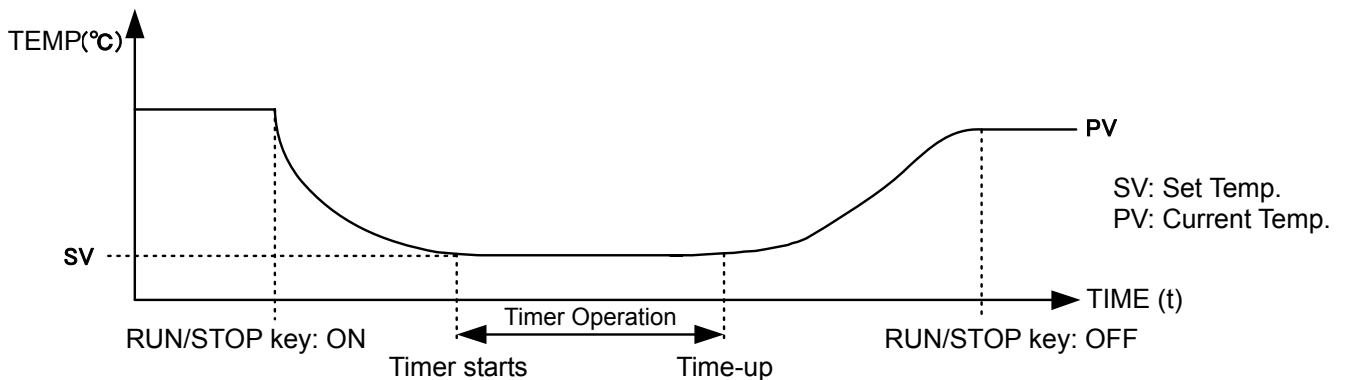

Auto stop operation procedure

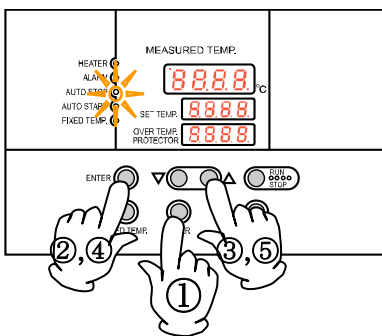

This operation is used to specify the automatic stop time in the fixed temperature operation.

1. Set stop time

- ① Press the TIMER key on the initial screen.
The setting temperature display screen displays the character "AstP", which indicates the auto stop operation, with blinking.
- ② Press the ENTER key.
The measurement temperature screen displays the character "SV", which indicates the temperature setting. The setting temperature screen displays the current setting temperature with blinking. The AUTO STOP lamp blinks, too.
- ③ Set the temperature using the "▼▲".
The temperature can be set to the first decimal place.
- ④ Press the ENTER key again.
The measurement temperature display screen displays the character "tim", which indicates the timer setting. The setting temperature display screen displays the current setting time with blinking.
- ⑤ Set the time using the "▼▲".

Timer function:

- The maximum setting time is "999 hours and 50 minutes".
- The time can be set in increments of a minute under 99 hours and 59 minutes.
- It can be set in increment of ten minutes over 100 hours.
- The "▼▲" can change the setting time quickly when it is pressed continuously. Press them discontinuously when fine adjustment is needed.

Auto Stop Operation

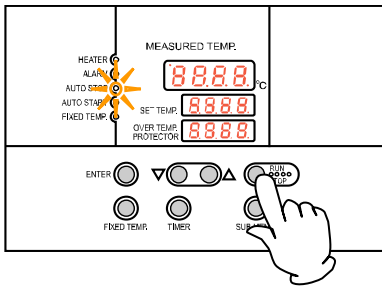

2. Start timer operation

- Press the RUN/STOP for one second after deciding the time.
- Timer operation starts with the AUTO STOP lamp lighting on.
- The timer is activated at the point when the temperature in bath (measurement temperature) reaches to the setting temperature.

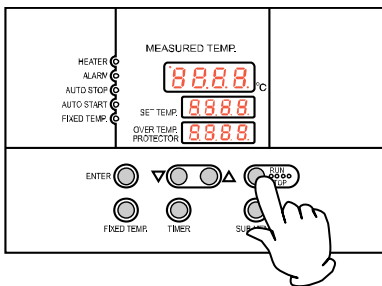

3. Stop/terminate timer operation

- The operation stops automatically at setting time.
- Buzzer continues to sound for about five minutes at operation stop.
- The setting temperature screen displays the character "End", which indicates termination of operation, with the FIXED TEMP and AUTO STOP lamps lighting on. Press the RUN/STOP to terminate the timer operation mode. The screen returns to the initial setting screen.

To correct or check setting...

Changing the setting temperature or time during operation is possible by pressing the TIMER key. Use the "▼▲" to change the setting value. Press the ENTER key respectively after changing the setting. (Note that the time setting is required using the value calculated by adding a new additional time to the already passed time in this case.)

Press the "▼" to display the setting temperature, operation mode and residual time on the setting temperature screen.

When the dot is blinked, the indicator of the remaining time e.g."1.30" indicates the countdown. When the dot is lit, the unit is under waiting (that is, the unit is under increasing or decreasing toward setting temperature), and the timer stop s counting.

Auto Start Operation

In this mode, the unit automatically starts to operate after the set period passes away from the start of fixed-value operation according to timer setting, as shown in the figure below. However, it does not automatically come to a stop and must be manually deactivated.

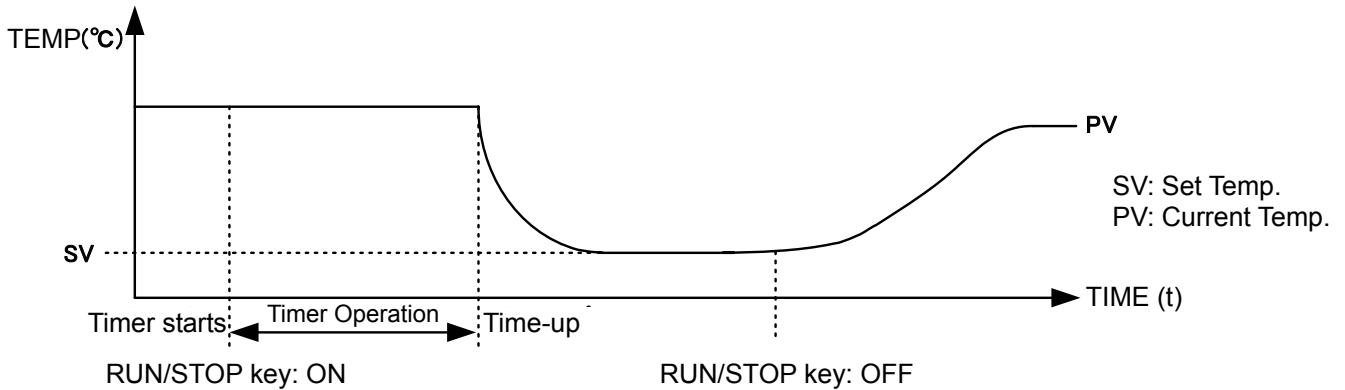

Auto start operation procedure

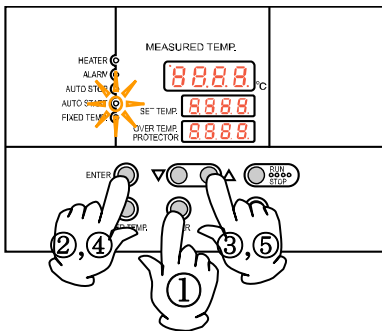

1. Set start time

- ① Press the TIMER key on the initial screen.
The setting temperature display screen displays the character "Astr", which indicates the auto start operation, with blinking.
- ② Press the ENTER key.
The measurement temperature screen displays the character "SV", which indicates the temperature setting. The setting temperature screen displays the current setting temperature with blinking. The AUTO START lamp blinks, too.
- ③ Set the temperature using the "▼▲".
The temperature can be set to the first decimal place.
- ④ Press the ENTER key again.
The measurement temperature display screen displays the character "tim", which indicates the timer setting. The setting temperature display screen displays the current setting time with blinking.
- ⑤ Set the time using the "▼▲".

Timer function:

- The maximum setting time is "999 hours and 50 minutes".
- The time can be set in increments of a minute under 99 hours and 59 minutes.
- It can be set in increment of ten minutes over 100 hours.
- The "▼▲" can change the setting time quickly when it is pressed continuously. Press them discontinuously when fine adjustment is needed.

Auto Start Operation

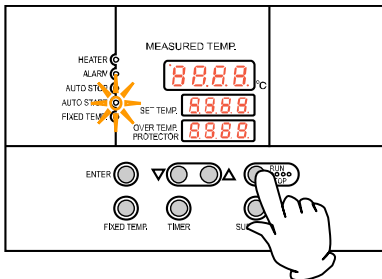

2. Start timer operation

- Press the RUN/STOP for one second after deciding the time.
- Timer operation starts with the AUTO START lamp lighting on.

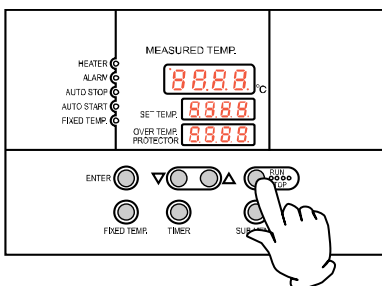

3. Stop/terminate timer operation

- The operation starts automatically at setting time.
- Press the RUN/STOP for one second to stop or terminate operation. The screen returns to the timer setting screen.

To correct or check setting...

Changing the setting temperature or time during operation is possible by pressing the TIMER key. Use the "▼▲" to change the setting value. Press the ENTER key respectively after changing the setting. (Note that the time setting is required using the value calculated by adding a new additional time to the already passed time in this case.)

Press the "▼" to display the setting temperature, operation mode and residual time on the setting temperature screen.

Note that the setting condition is impossible to change once starting the operation after passing the auto start operation time. In this case, stop the operation by pressing RUN/STOP, and reset to initial status.

Calibration Offset Function

Calibration offset is a function which corrects the difference between the temperature in bath and that of controller (sensor temperature) if arises. The function parallel corrects the difference either to the plus or minus side within the whole temperature range of unit. The function can be set or cancelled by the SUB MENU key.

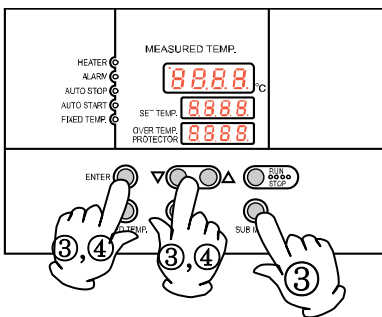
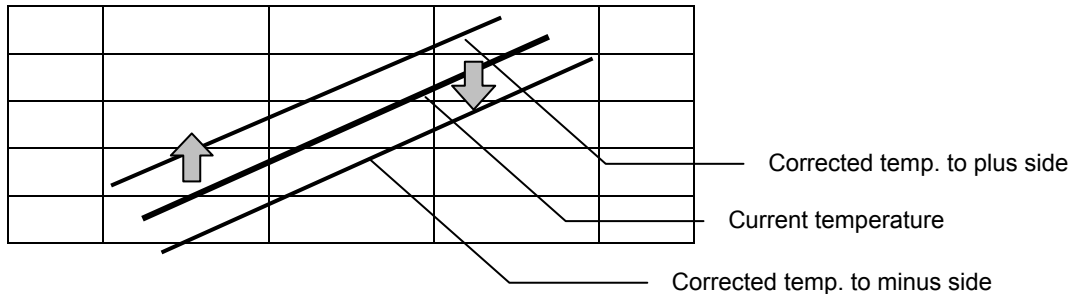

- ① Start operation with the target setting temperature. Check the temperature in bath with a thermograph after it is stabilized.
 - ② Check the difference between the setting temperature and that in bath.
 - ③ Press the SUB MENU key. Select the character "cAL", which indicates the calibration offset, using the "▲▼", and then press the ENTER key.
 - ④ Input the difference using the "▲▼" and then press the ENTER key. This completes the setting.
- ❖ The setting range of offset correction temperature is +99°C to plus side and -99°C to minus side respectively.
When it is set to the minus side, the temperature on the measurement temperature display screen falls by the setting temperature, while the temperature on bath rises.
When it is set to the plus side, the temperature on the measurement temperature display screen rises by the setting temperature, while the temperature on bath falls.
 - ❖ The unit has two-point correction function, which performs offset between low-temperature zone and high-temperature zone.
 - ❖ Please consult our local branch office when carrying out validation of temperature controller.

Lock Function

This function locks the operation status previously set. The function can be set or cancelled by the SUB MENU key.

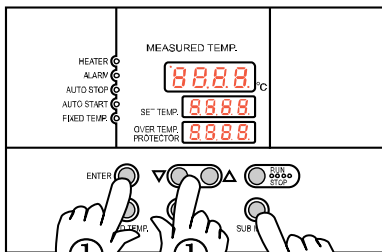

- ① Press the SUB MENU key. Select the character "Lock", which indicates the lock of setting value, using the "▲▼", and then press the ENTER key.

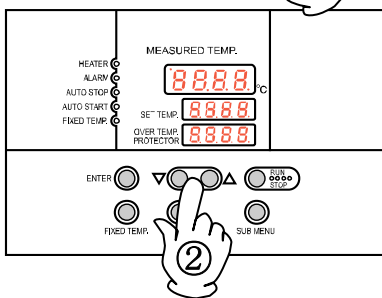

- ② The setting temperature screen displays "oFF". The setting value is locked when it is turned to "o n" using the "▲".

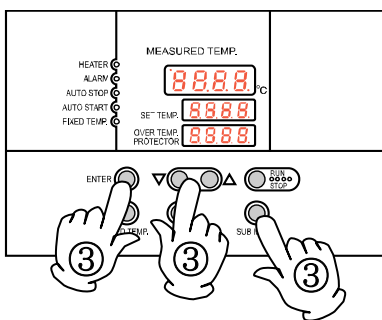

- ③ Press the SUB MENU key again to cancel the lock. Select the character "Lock", which indicates the lock of setting value, using the "▲▼", and then press the ENTER key. Select "oFF" with the "▼" and then press the ENTER key to cancel the function.

❖ All keys other than the RUN/STOP and SUB MENU keys are lock when the lock function is on.

Temperature Output Terminal

Precautions



- Operate this product according to the procedure described in this Operation Manual. Failure to follow the operation procedure described herein may result in a problem. The guarantee will not apply if you operate the product in the wrong manner.



CAUTION!



- Turn off the breaker before connecting the cables.
- Connect a recorder or another appliance of 600 W or less in input impedance to the temperature output terminal.
- Securely fasten all connections with the screws attached to the terminal block.

Connection procedure



- Connect the cables to the appropriate terminals.
- When using temperature output, use a shielded wire for the cable to be connected to prevent noise.

ANALOG	RS-485		
+	-	A+	A-

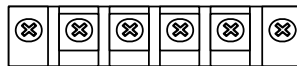

Connection terminal

Temperature Output Terminal

Specification

Temperature Output (ANALOG)	<ul style="list-style-type: none"> • The voltage (DC) corresponding to the measured temperature is output. • Output temperature range: -15 to 85°C • Output voltage: 4 to 20mA DC • Load: 600Ω or bellow • Resolution: $\pm 1^\circ\text{C}$ • Connection: M4 screw terminal block
--------------------------------	---

Temperature Output

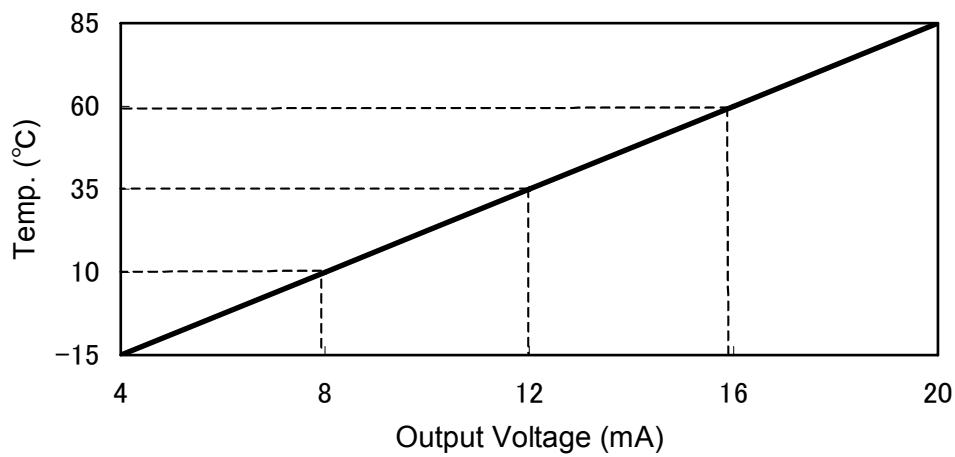

RS485 Communication Function

1. Settings Relating to Communication

1.1 Communication Settings

Before starting communication with the VS3 controller (hereinafter called the "unit"), set communication parameters on the personal computer.

	Item	Communication setting
1	Data length	8 bits
2	Stop bit length	2 bits
3	Parity	Disabled
4	BCC check	Enabled
5	Baud rate	4800BPS
6	Response delay time	0msec

1.2 Communication Connections

- Personal computer
 - Use channel 1 (COM1/COM2 port) of the RS232C interface.
- RS232C/RS485 converter
 - For the converter, System Sacom's KS-485 is recommended.
 - Our optional accessory "external communication adapter (RS485-232C) ODK18" permits the connections described in Note 1) below (except the personal computer). A sample program is uploaded on our website.
<http://www.yamato-net.co.jp/support/program/index.htm>
- Communication cable for connection

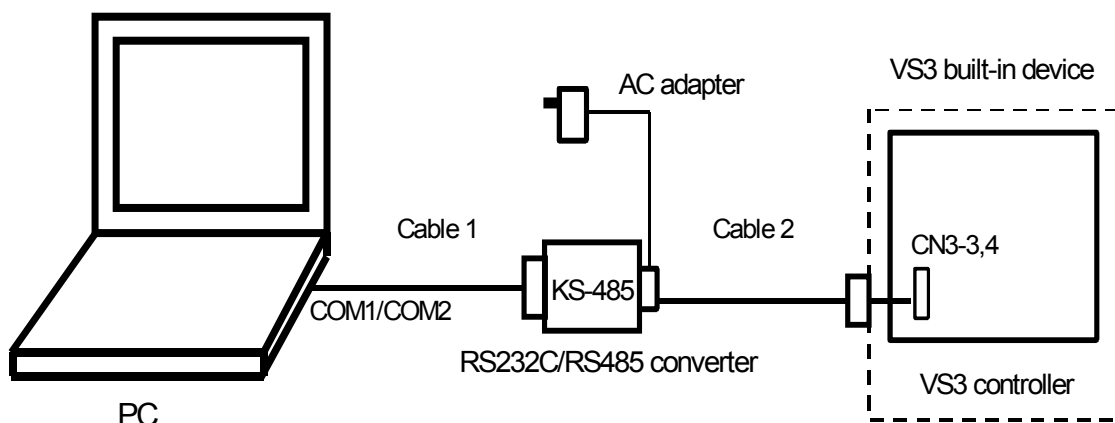

Note)

The optional accessory "external communication adapter (RS485-232C) ODK18" comprises the following:

- ① Communication cable 1: One-meter-long RS-232C cable with a connector (for IBM nine-pin appliance connection) to the personal computer and System Sacom's CBL16 connector (Dsub 25-pin male) to the KS-485
- ② Communication cable 2: Three-meter-long UL2464TASB two-core AWG20 cable with a connector (Dsub nine-pin male) to the KDS-485 and a Y-terminal (with a 100W terminating resistor) to the unit
- ③ RS-232C <=> KS-485 conversion unit: System Sacom's KS-485 with an AC adapter

RS485 Communication Function

2. Data Transmission Method

Item	Specification
Communication standard	EIA standard, complying with RS-485
Synchronization method	Asynchronous communication method
Communication method	Half-duplex communication
Transmission code	ASCII code
Baud rate	1200/2400/4800/9600BPS
Communication distance	Max. 500 m (It depends on the effect of the ambient environment.)
Network	Multi-drop method (up 1:31 stations)
Signal wire	Two wires for transmission and receipt
Stop bit length	1/2bits
Data length	7/8bits
Parity	None/Odd/Even
BCC check	Enabled/Disabled
Response delay time	0 to 250msec
Communication address	1 to 99 stations (however, 1:31 stations at maximum)
Communication mode switching	RO/RW

Note) The shading indicates the initial setting of the unit.

3. Transmission Control Characters

Symbol	Name	Code	Detail
STX	Start of text	02H	Indicates the start of the text.
ETX	End of text	03H	Indicates the end of the text.
R	Read	52H	The command to read a request.
W	Write	57H	The command to write a request.
ACK	Acknowledge Character	06H	Transmits a reply when data is properly received.
NAK	Negative Acknowledge	15H	Transmits a replay in case of a receiving error.

Note)

R: Read (command to read settings or measured values)

W: Write (command to write set values)

R commands can be communicated at all times in all modes.

W commands can be communicated in regular mode only, and the parameters that can be set depend on the operation state (during operation). See "7. List of Identifiers/Commands."

4. Transmission Control Procedures

4.1 Communication Procedure

- This unit returns a "reply message" to a "request message" from the host computer but does not start transmission.
- This unit does not start communication (no reply) for about four seconds after the power is turned on. Set a delay until communication begins after the power is turned on.

RS485 Communication Function

4.2 Message Types

- Message types include transmission request messages from the host computer and transmission reply messages from this unit.
- All codes from STY, address, request, identifier to ETX (except BCC) are represented by ASCII codes.

4.3 Request Message Structures (transmission from the host computer to the unit)

4.3.1 Structure of Read Request Messages

①	Start code
②	Address
③	Request (read)
④	Identifier
⑤	-
⑥	End code
⑦	BCC data

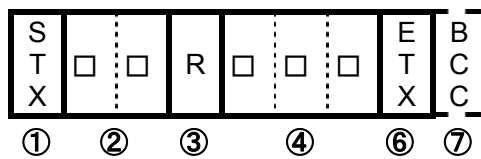

4.3.2 Structure of Write Request Messages

①	Start code
②	Address
③	Request (write)
④	Identifier
⑤	Numeric data
⑥	End code
⑦	BCC data

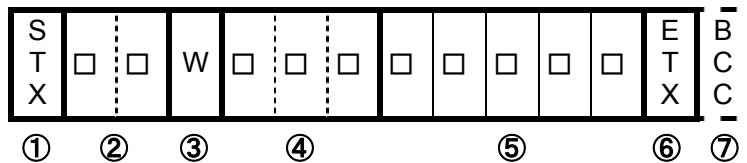

4.3.3 Structure of Storage Request Messages

①	Start code
②	Address
③	Request (write)
④	Identifier
⑤	-
⑥	End code
⑦	BCC data

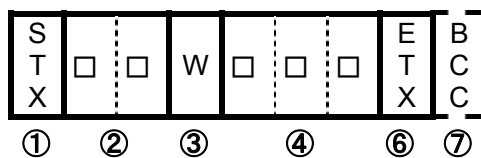

RS485 Communication Function

4.4 Reply Message Structures

4.4.1 Reply Messages to Read Request Messages

①	Start code
②	Address
④	Identifier
⑤	Numeric data
⑥	End code
⑦	BCC data
⑧	Acknowledgement code

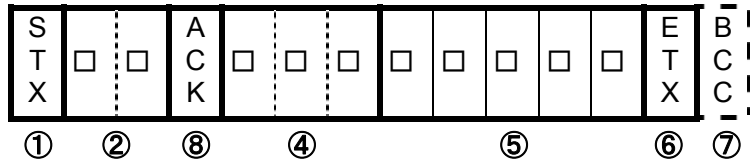

4.4.2 Reply Messages to Write Request/Storage Request Messages

①	Start code
②	Address
⑥	End code
⑦	BCC data
⑧	Acknowledgement code

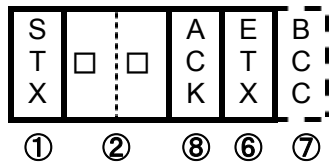

4.4.3 Reply Messages In Case of an Error

①	Start code
②	Address
⑥	End code
⑦	BCC data
⑨	Negative acknowledgement code
⑩	ERR type

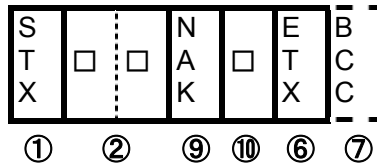

RS485 Communication Function

4.5 Description of Codes

- The following codes from ①STX, ②address to ⑩error type are represented by ASCII codes.
- For ASCII codes, see "8. List of ASCII Codes."
- For conversion into ASCII codes, see "5. Communication Examples."

① STX

This code is required for the receiving side to detect the head of a message. Add it at the head of the character string to be transmitted.

② Address

This is the address of the unit with which the host computer communicates. The address within a reply message from the unit indicates the unit that has transmitted the message.

③ Request

Enter the symbol "R" or "W."

R: To read data from the unit

W: To write data to the unit or save it in the unit

④ Identifier

This is the classification symbol (identifier) of the data to be read or written and represented by a three-digit alphanumeric ASCII code. See "7. List of Identifiers/Commands."

⑤ Numeric data

This is the data to be read or written and always represented by five digits, irrespective of the type. Negative data: The symbol "-" is at the highest digit.

Position of decimal point: Five-digit data does not include any decimal point.

Example) The meaning of the five-digit numeric data **0 0 1 0 1** is shown in the table below.

Example		Meaning of numeric data
Set temperature (SV1)	When the temperature sensor is a thermocouple	→ 101°C
	When the temperature sensor is platinum	→ 10.1°C
Set time (TIM)		→ One hour and one minute

⑥ ETX

This code is required for the receiving side to detect the end of the message. Add it at the end of the character string to be transmitted (except BCC).

⑦ BCC

This is the check code for error detection and takes the exclusive OR (EX-OR) of all characters from STX to ETX. When "Enabled" is selected for BCC check among the communication settings for the unit, this code (BCC) will not be included in the reply message.

⑧ ACK

This is an acknowledgement code and included and returned in the "reply message" from the unit when no error is found in the received message.

RS485 Communication Function

⑨ **NAK**

This is a negative acknowledgement code and included and returned in the "reply message" from the unit when there is an error in the "request message" received by the unit.

⑩ **ERR type**

If there is an error in the "request message" received by the unit, this code is included in the "reply message" from the unit after "(9) NAK" to report the type of the error.

This is a communication-related error, and details of display are omitted.

If STX is not transmitted from the unit within the specified reply wait time after the host computer receives BCC, it is considered receive time-out.

RS485 Communication Function

5. Communication Examples

5.1 Read communication example

Example) Request message:

A request for reading PV is transmitted to the unit set at address 02.

Reply message from the unit to this request message: The data of PV (00123) is returned.

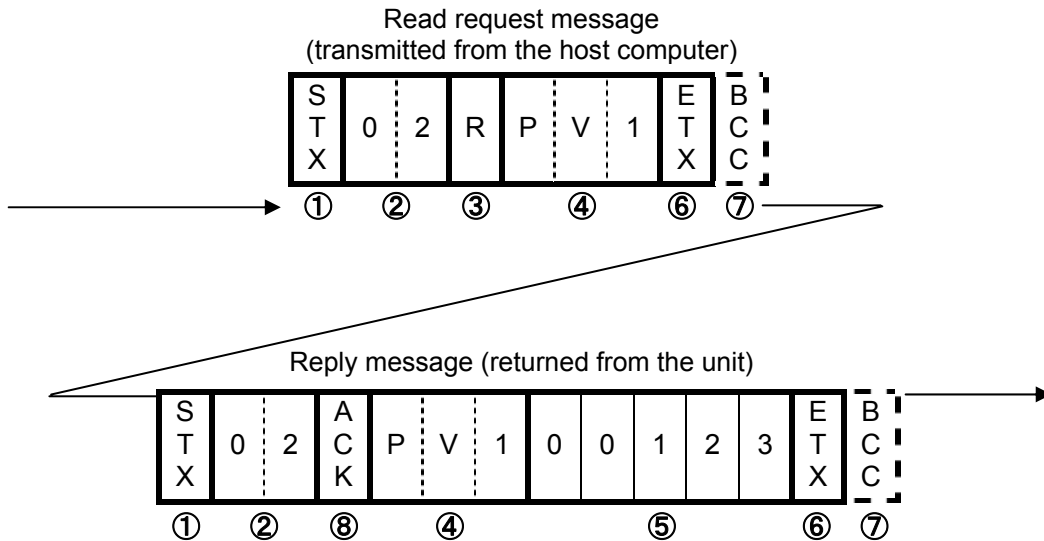

Code	Symbol/Data	ASCII code ^{*2}
① Start Code	STX	02H
② Address	02	30H 32H
③ Request (Read)	R	52H
④ Identifier ^{*1}	PV1	50H 56H 31H
⑤ Numeric Data	00123	30H 30H 31H 32H 33H
⑥ End Code	ETX	03H
⑦ BCC data	Request	61H
	Reply	02H
⑧ Acknowledgement code	ACK	06H

*1): See "7. List of Identifiers/Commands."

*2): For ASCII codes, see "8. List of ASCII Codes."

RS485 Communication Function

5.2 Write communication example

Example) Request message:

A request for setting "SV to 135" (writing 135) is transmitted to the unit set at address 03.

Reply message from the unit to this request message: Information that the request message has been received is returned.

- Confirm that the data has been properly written by reading it separately.

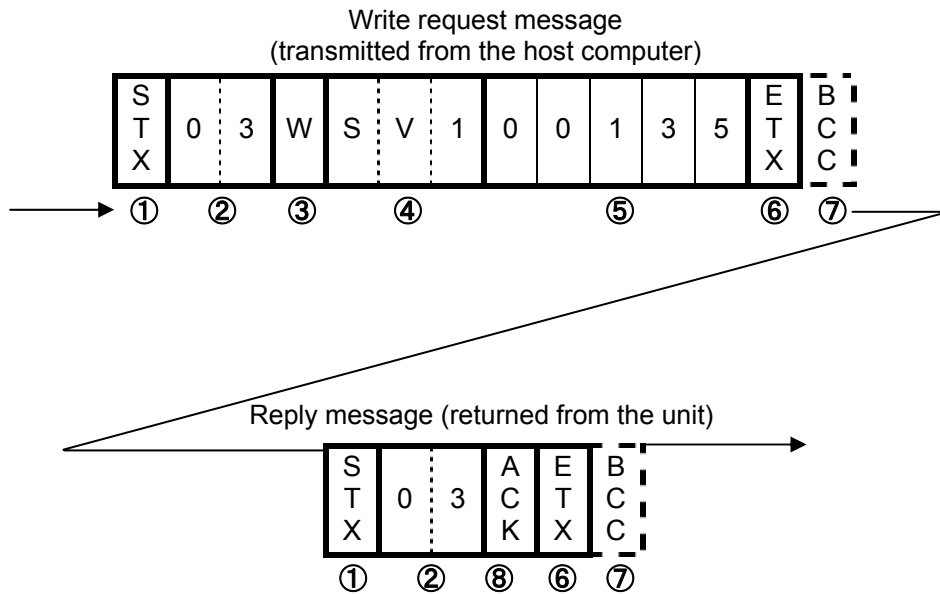

Code	Symbol/Data	ASCII code *2
① Start Code	STX	02H
② Address	03	30H 33H
③ Request (Write)	W	57H
④ Identifier *1	PV1	53H 56H 31H
⑤ Numeric Data	00135	30H 30H 31H 33H 35H
⑥ End Code	ETX	03H
⑦ BCC data	Request	56H
	Reply	04H
⑧ Acknowledgement code	ACK	06H

*1): See "7. List of Identifiers/Commands."

*2): For ASCII codes, see "8. List of ASCII Codes."

RS485 Communication Function

6. Wire Connection

Shown below is an example of multi-drop wire connection.

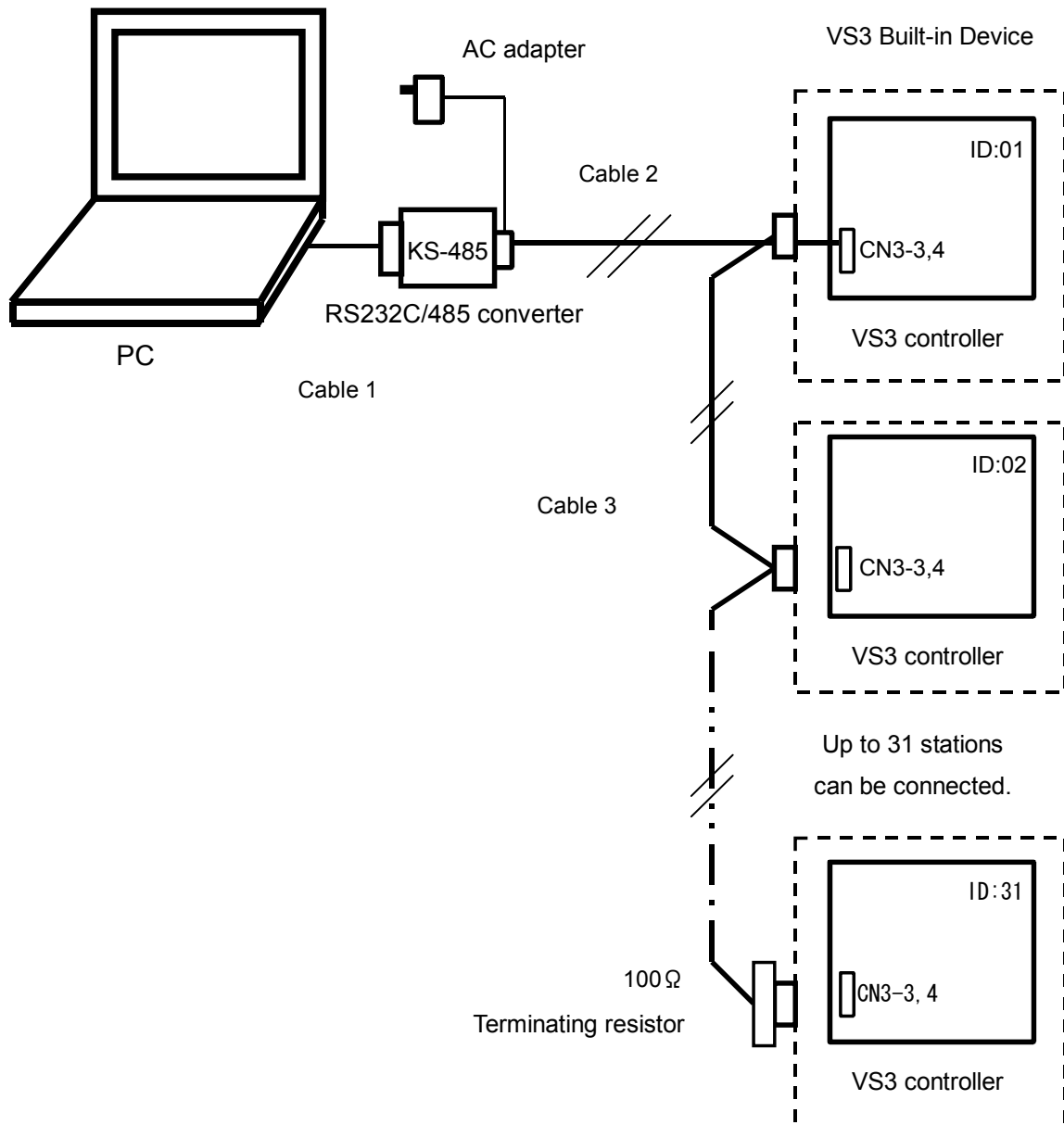

Note 1) Communication cable 1: One-meter-long RS-232C cable with a connector (for IBM nine-pin appliance connection) to the personal computer and System Sacom's CBL16 connector (Dsub 25-pin male) to the KS-485

Note 2) Communication cables 2 and 3: Custom-made items.

Note 3) Terminating resistor: Custom-made item. If you prepare a terminating resistor yourself, connect a fixed resistor of 100 Ω and 1/4 W or over to the last cable appliance terminal block.

RS485 Communication Function

7. List of Identifiers/Commands

<Identifiers and set values>

*1: " _ " means a space.

*2: The setting range depends on other parameters. (See the table shown below.)

*3: A parameter with which a W command is valid during each operation (valid during operation in regular mode).

Fixed-value operation parameters

Name	Identifier	Command	Set value
Temperature setting	SV1	R/W	SLL~SLH : Set value limiter lower limit - set value limiter upper limit °C (*2, *3)

Store command

Name	Identifier	Command	Set value
Store set value	SV1	R/W	None (This command is required to store temperature and time settings.)

RS485 Communication Function

Other Parameters

Name	Identifier	Command	Setting Value
Key lock	LOC	R/W	00000 : Key lock released 00001 : Key lock
Operation start/stop	RUN	R/W	00000 : Stop (*3) 00001 : Start
Operation type selection	RST	R/W	00000 : Fixed temperature operation selected (*3)
Remaining hour monitor	_TI	R	00000 : Time-up (*1) 00001~09950 : 0 hours and a minute to 999 hours and 50 minutes
Output monitor	OM1	R	00000 : First digit = Heater output Second digit = Refrigerator output Third digit = Main output Fourth digit = Time-up or alarm output Fifth digit = Overheat prevention output ※ Output state: 0 = Output OFF, 1 = Output ON
Error monitor 1	ER1	R	00000 : First digit = Memory error Second digit = Sensor error Third digit = AT error Fourth digit = Heater wire disconnection error Fifth digit = SSR short error ※ Error state: 0 = No error exists., 1 = An error exists.
Error monitor 2	ER2	R	00000 : First digit = Boil-dry error Second digit = Overheating prevention 1 error Third digit = Overheating prevention 2 error Fourth digit = Internal communication/Temperature input circuit error Fifth digit = Unused *Error state: 0 = No error exists., 1 = An error exists.
Measured temperature monitor	PV1	R	(Example) 00100 = 100°C (when the temperature sensor is a thermocouple input) 01000 = 100.0°C (when the temperature sensor is a platinum input) HHHHH = Measured temperature over-scale (input common) LLLLL = Measured temperature under-scale (input common) *The measured temperature resolution of the platinum input is ten times that of the thermocouple input.

RS485 Communication Function

8. List of ASCII Codes

ASCII code	02H	03H	06H	15H						
Symbol	STX	ETX	ACK	NAK						

ASCII code	30H	31H	32H	33H	34H	35H	36H	37H	38H	39H
Numeric	0	1	2	3	4	5	6	7	8	9

ASCII code	2DH	20H								
Numeric	— (minus)	SP (space)								

ASCII code	41H	42H	43H	44H	45H	46H	47H	48H	49H	4AH
Symbol	A	B	C	D	E	F	G	H	I	J

ASCII コード	4BH	4CH	4DH	4EH	4FH	50H	51H	52H	53H	54H
Symbol	K	L	M	N	O	P	Q	R	S	T

ASCII コード	55H	56H	57H	58H	59H	5AH	20H			
Symbol	U	V	W	X	Y	Z	SP (space)			

Cooling curve, cooling capacity curve (reference data)



The graphs show the cooling and cooling capacity curves of each model below. Use the values just for reference because they depend on the sample volume, the ambient temperature, etc.

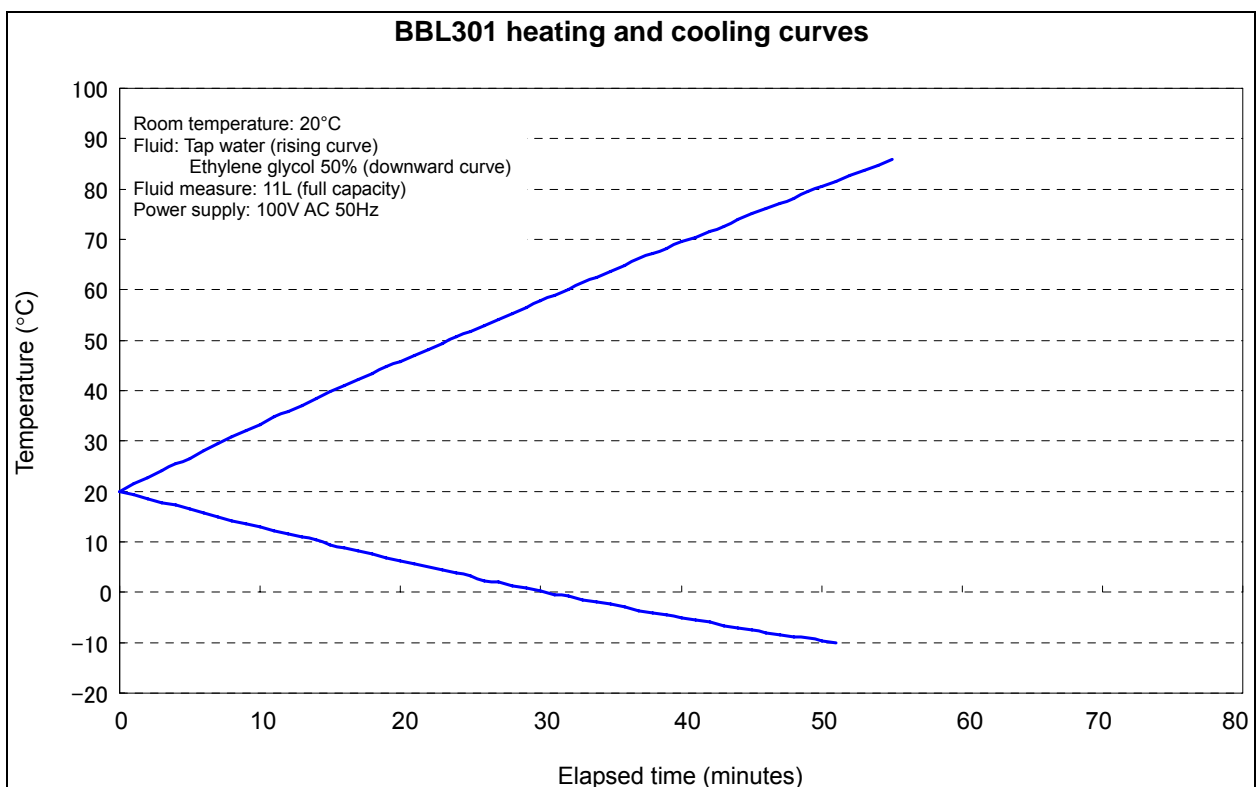
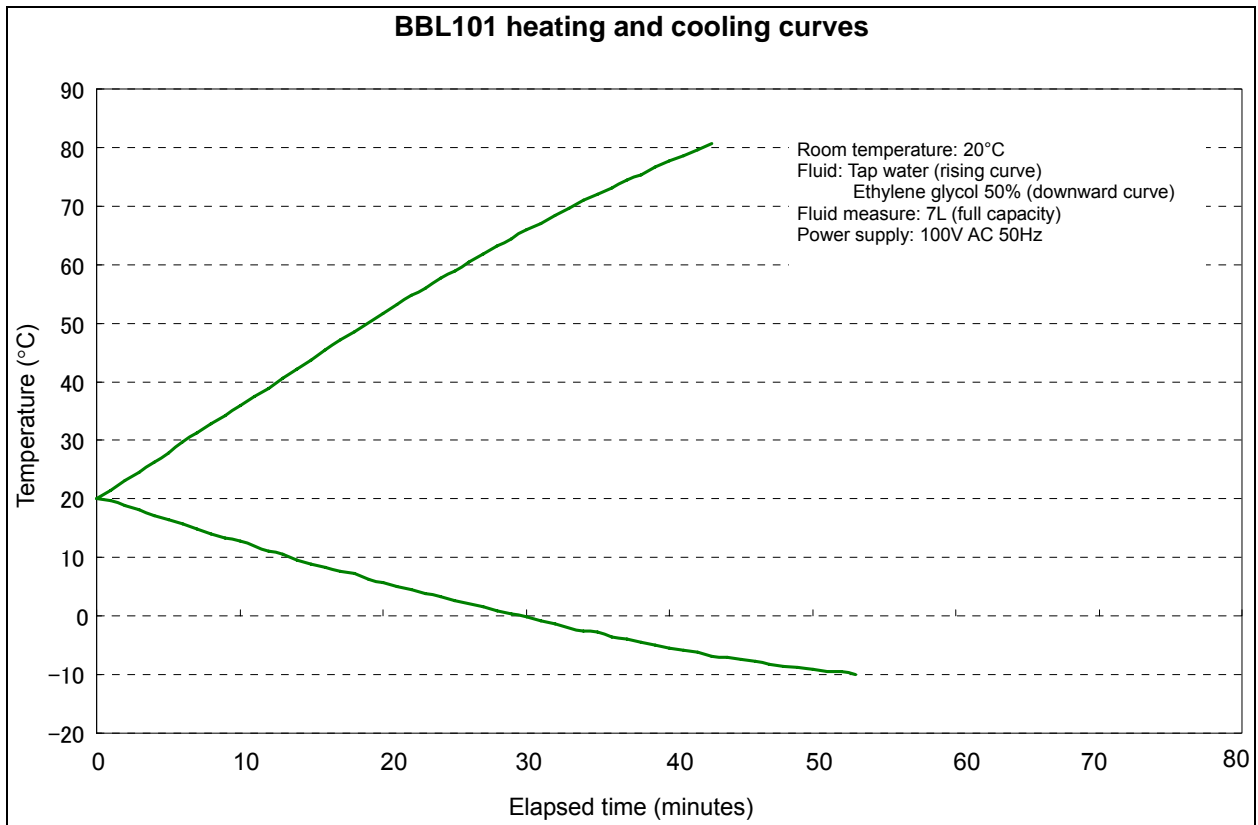

Cooling curve, cooling capacity curve (reference data)

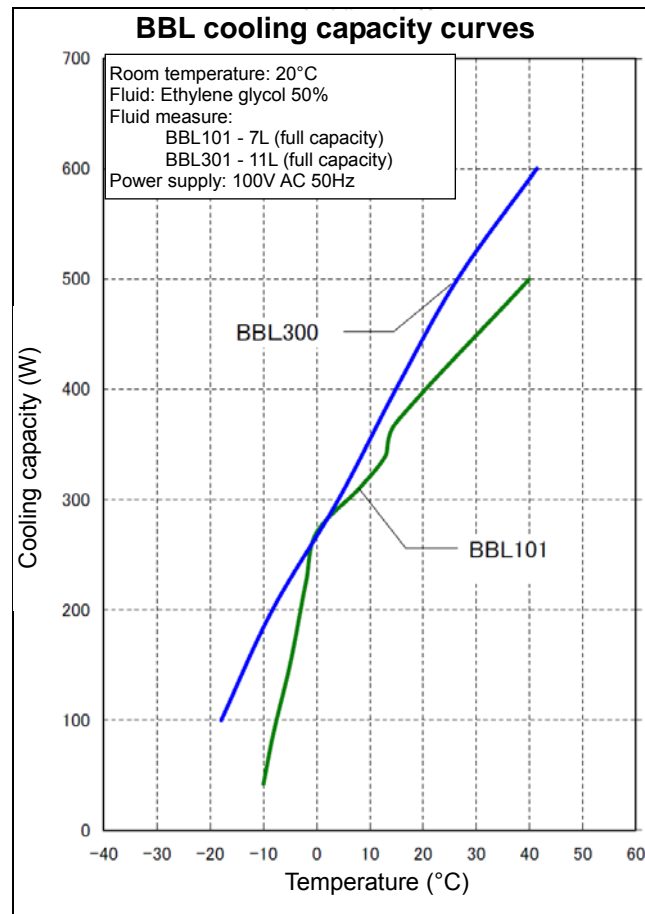

Flow Rate and Head (reference data)

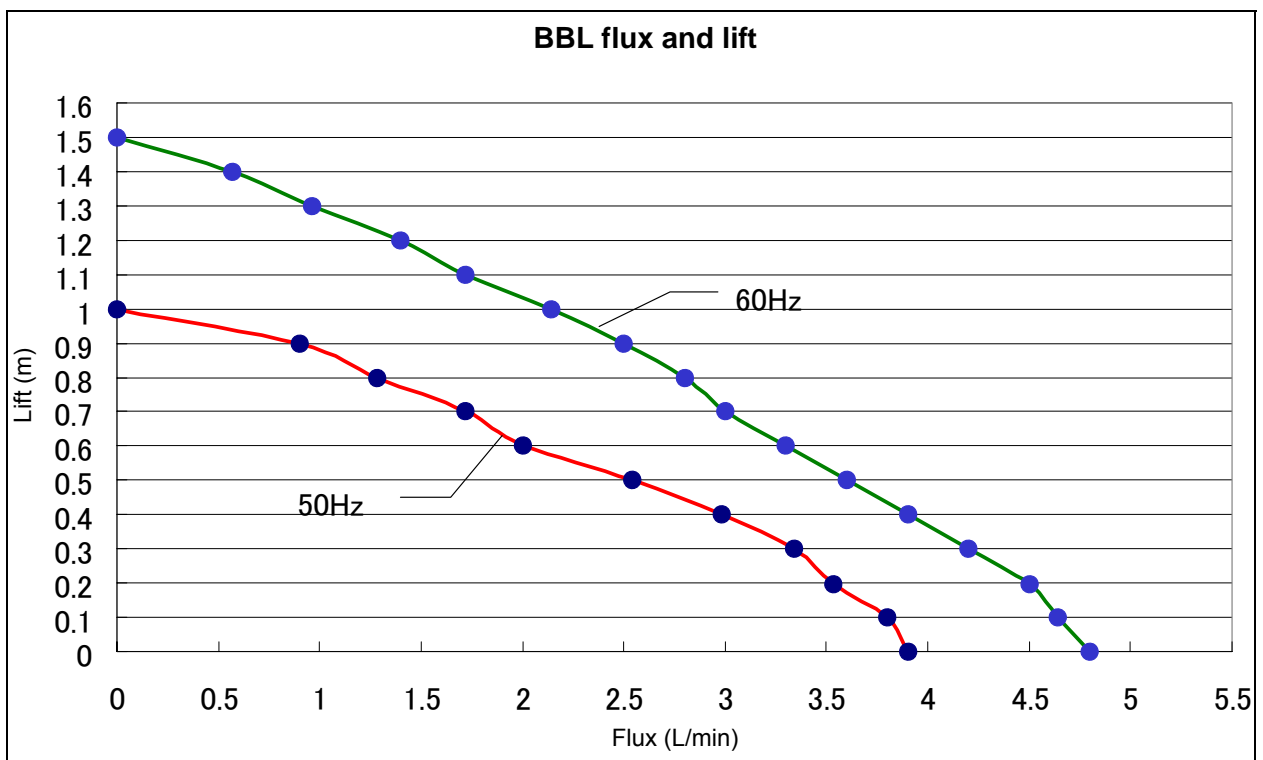

Nybrine Freezing Temperature and Viscosity (reference data)

"Nybrine" is a brand name which Maruzen Chemicals developed. The main ingredients are good Ethylene Glycol and Propylene Glycol. It is a heat transmittal medium which is well-considered for safety and rust prevention of the equipment by adding various antiseptics.

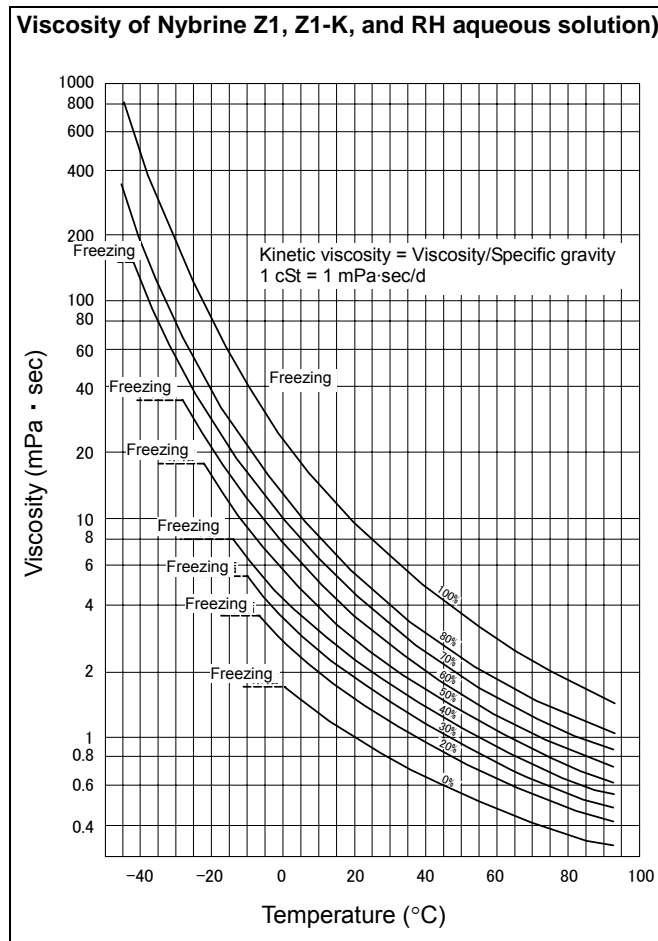
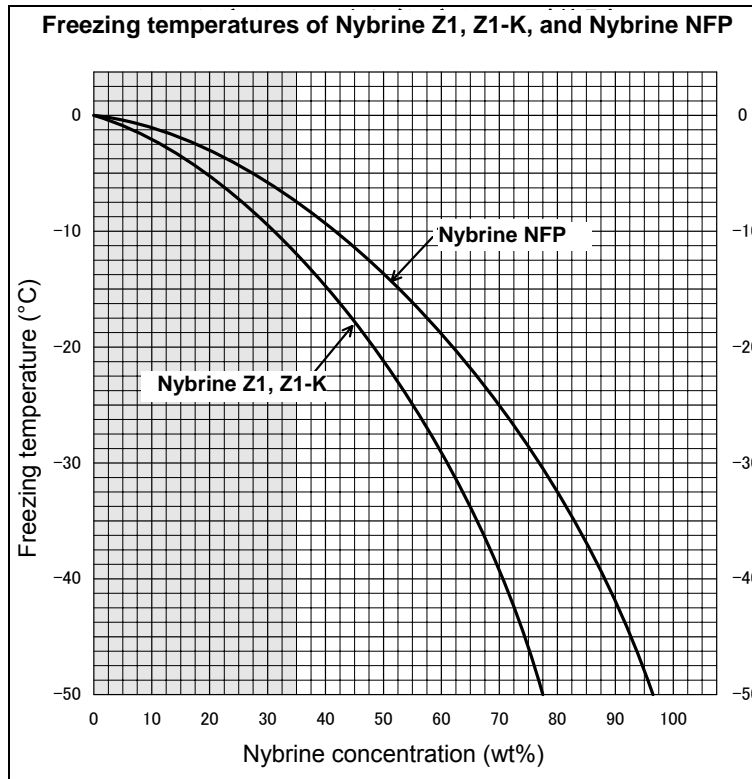

Device to Install (reference data)

Bath capacity of this unit is BBL101 type: 6.7L, BBL301 type: 11.5L.
Be careful that it may leak outside if the quantity is beyond the capacity.

Kinds and quantity of Erlenmeyer flask to be set in the bath is as follows.

	300mL	500mL	1000mL
BBL101	3	2	0
BBL301	5	3	2

* Erlenmeyer flask size (maximum diameter x height x neck diameter) reference value

300mL: 90×148×30

500mL: 108×171×37

1000mL: 134×215×40

WARNING!

If a problem occurs

-  If smoke or strange odor should come out of this unit for some reason, turn off the power key right away, and then turn off the circuit breaker and the main power. Immediately contact a service technician for inspection. If this procedure is not followed, fire or electrical shock may result. Never perform repair work yourself, since it is dangerous and not recommended.

Measure for flammability and handling of flammable solvent

-  This unit is not designed as the explosion-proof construction. Pay special attention to the handling of the sample to be handled with this unit on the consumption with the explosive material, flammable material, and similar ones. The flammable material may be vaporized by leaving it at the temperature higher than room temperature, and could cause the fire or explosion. When handling such material, provide ventilation with enough before the operation. (Refer to page 60 "List of Dangerous Substances".)

Keep the unit well-ventilated

-  Keep the air holes in the side and back of the unit open during operation. If they are closed, the inside temperature of the unit may increase, its performance may deteriorate, or an accident, malfunction or fire may result.

Exercise care not to allow a liquid to get on the unit

-  Exercise care not to allow a liquid to get on the unit or enter the unit through the air intake or heat radiation hole in the side or back of the unit. If it enters the unit, stop the operation. Otherwise, an accident, malfunction, electric shock or fire may result.

Do not drop metallic pieces into the unit

-  Do not drop metallic pieces, such as clips, staples and screws, into the unit. If such a metallic piece has dropped into the unit, turn it off. An accident, malfunction, electric shock or fire may result.

Do not open the panels and covers

-  Do not operate the unit with the fixed panels and covers open. An accident, malfunction or electric shock may result.

Do not operate the unit with the filter for the air intakes removed

-  Do not operate the unit with the filter for the air intakes removed. An accident, malfunction or electric shock may result.

Do not modify

-  Do not modify this unit. An accident, malfunction, electric shock or fire may result.

CAUTION!

Do not step on this unit

 Do not step on this unit. It will cause injury if this unit fall down or break.

Do not place or drop anything on the unit

 Do not place or drop anything on the unit. Since the unit contains precision components, it may malfunction due to vibration, impact, etc.

During a thunder storm

 During a thunderstorm, turn off the power key immediately, then turn off the circuit breaker and the main power. If this procedure is not followed, fire or electrical shock may be caused.

Countermeasure for stop operation during night or long-term stop

 In case of stopping operation during night or long-term, toggle the breaker and power switch to "OFF".

Thoroughly wash the unit.

 The unit was washed already. However, when you first use it or operate it after a long period of deactivation, thoroughly wash it.

Circulating fluid

 Specify circulating fluid upon the temperature at the time of use.

Specified temperature + 10°C or above : Water

Specified temperature + 10°C or below : Antifreeze solution (Nai brain60% or Ethylene Glycol 50%)

- Antifreeze solution changes a condensing point according to concentration or kinds. Select the antifreeze solution which has coagulation point at least 10 degrees lower than the temperature at the time of use. If antifreeze solution which has higher coagulation point than that, there is a possibility that the coolant part freezes and the heat exchange capability may decline. Moreover, if a circulation course freezes, it may become the cause of an accident or a failure of the equipment.
- If antifreeze solution is used for a long time, its concentration will change. If it used in such condition, antifreeze solution may be frozen or become the cause of a failure with its strong adhesion.
- Use distilled water or tap water for circulating fluid. Bad water in quality may cause lower performance of pump and heater with scale accumulated. Also it may be the cause of failure. (Well water etc.)
- If circulation solution which has large specific gravity or strong adhesion is used, the pump gets overload and its performance may decline. (Flourinert, Galden etc.)
- Do not use things with corrosive, or things which generate corrosive substance at the time of heating. It may become the cause of failure. (Flourinert etc.)
- Do not use what may cause damage when its steam is inhaled. (Methyl alcohol)

Recovery from a power failure



If the unit was deactivated in the middle of operation due to a power failure and is re-energized, the unit automatically returns to the state just before the power failure and resumes operation. If the resumption of operation by automatic recovery is inconvenient, turn off the leakage breaker.

Abnormal refrigerator pressure



If the refrigerator operates in a high-temperature range, the refrigerator overload relay protecting circuit may work to illuminate Refrigerator error lamp deactivate the refrigerator. In this case, reduce thermal load by changing the fluid, or taking other appropriate measures.

Abnormal fluid level



Turn off the earth leakage breaker once and check the water amount of the circulating fluid. After checking, supply the circulation fluid or freezer coolant water.

Do not open the drain cock in the middle of operation



Do not open the drain cock in the middle of operation or operate the unit with the cock open. The pump may malfunction.

Do not operate the unit without a fluid



Do not operate the unit without a fluid. Operating the unit with the heater or cooling coil exposed, the unit may malfunction.

Do not perform what is not described in the Instruction Manual



Do not perform what is not described in the Instruction Manual. An unexpected accident may occur.

Daily Inspection and Maintenance

For the safety use of this unit, please perform the daily inspection and maintenance without fail. Using the city water to this unit might attach dirt. Do inspect and maintain this point while performing daily inspection and maintenance.

WARNING!

- Disconnect the power cable from the power source when doing an inspection or maintenance unless needed.
- Perform the daily inspection and maintenance after returning the temperature of this unit to the normal one.
- Do not disassemble this unit.

CAUTION!

- Use a well-drained soft cloth to wipe dirt on this unit. Do not use benzene, thinner or cleanser for wiping. Do not scrub this unit. Deformation, deterioration or color change may result in.

Monthly maintenance

- Check the earth leakage breaker function.
 1. Connect the power cord.
 2. Turn the breaker on.
 3. Push the red test switch by a ballpoint pen etc.
 4. If there is no problem, the earth leakage breaker will be turned off.

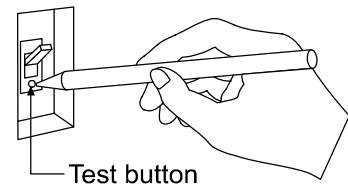

Maintaining the water bath

- Some types of circulating fluid condense and accelerate the accumulation of scale. If the water bath is contaminated by fur or scale, dip out the water or drain it out from the drain cock, and wash the bath clean.
- Use ion-exchanged water or distilled water, and clean the water bath as appropriate. If ground water or tap water is used, fur or scale accumulates inside the bath and not only contaminates it but also deteriorates heater efficiency and service life. Clean it as appropriate.



Exercise extreme care not to get injured. It is very dangerous for you to perform operations with bare hands. Wear gloves.

- ① Remove the power cord from switchboard or socket.
- ② Discharge the circulating fluid. (Open the discharge cock on the right surface of the unit.)
Confirm that circulating fluid is not hot (+40°C or below) when discharging.



Before draining off the circulating fluid, confirm that it is not hot (+40°C or below). If it is hot, you may get burned.

Daily Inspection and Maintenance

Cleaning the filter

A clogged filter deteriorates cooling performance or causes the refrigerator to malfunction. The clogged state depends on the ambient environment or working period. Clean the filter at regular intervals according to the working conditions.



Pull the filter attachment board at the left side of the device to the front. Since it is magnet, do the attachment as it is.

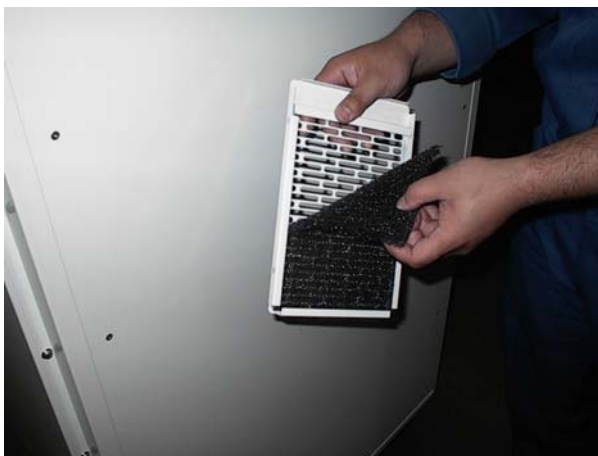

Since the filter is attached to the filter attachment board, remove and wash the filter or remove dust with a cleaner etc.



A condensation machine fin is in the inner part of air intake board.

For any questions, contact the dealer who you purchased this unit from, or the nearest sales division in our company.

When not using this unit for long term / When disposing

CAUTION!

When not using this unit for long term...

- Turn off the power and disconnect the power cord.

WARNING!

When disposing...

- Keep out of reach of children.
- The unit uses a CFCs substitute. Ask a qualified disposal service company for the disposal of it.

Environmental protection should be considered

We request you to disassemble this unit as possible and recycle the reusable parts considering to the environmental protection. The feature components of this unit and materials used are listed below.

Component Name	Material
Exterior Parts	
Outer covering	Bonderizing steel plate baked with melamine resin coating
Inner bath	Stainless steel SUS304
Plates	PET resin film
Electrical Parts	
Switches, Relay	Resin, copper and other
Circuit boards	Composite of glass fiber and other
Pipe heater	SUS316L
Power cord	Synthetic rubber coated wiring materials, copper and nickel
Pump	Iron, copper, resin and ceramic
Refrigerator	Iron and copper
Piping Parts	
Hoses	Silicon
Drain hose	Silicon
Hose clamp	66 nylon
Insulation hose	Polyurethane sponge
Pipes	SUS304
Condenser	Iron, copper and aluminum
Cooling medium	
Cooling medium	BBL101: HFC-R134a, BBL301: HFC-R404A

Safety Device and Error Code

This unit has an automatic diagnosis function built in the controller and safety devices independent of the controller. The table below shows the cause and the solution method when the safety device operates.

Error Code:

When an abnormal condition occurs, an error code appears and the alarm lamp lights in the controller, the buzzer sounds simultaneously. Record the error code and turn off the power of device immediately.

Safety Device	Notify	Cause/Solution
Sensor trouble detection	"ALARM" lamp lights on, "Er.01" appears	<ul style="list-style-type: none"> • Failure in temperature input circuit. • Temperature sensor is broken or disconnected. • The measured temperature is out of the display range. ❖ Make a call for service.
SSR short-circuit detection	"ALARM" lamp lights on, "Er.02" appears	<ul style="list-style-type: none"> • SSR is in short-circuit ❖ Make a call for service.
Heater disconnecting detection	"ALARM" lamp lights on, "Er.03" appears	<ul style="list-style-type: none"> • Heater is disconnected. ❖ Make a call for service.
Measured temperature lower limit error	"ALARM" lamp lights on, "Er.13" appears	<ul style="list-style-type: none"> • When the temperature warning function issues a lower limit warning. ❖ Make a call for service.
Memory error	"ALARM" lamp lights on, "Er.15" appears	<ul style="list-style-type: none"> • Failure in internal memory. ❖ Make a call for service.
Internal communication error	"ALARM" lamp lights on, "Er.17" appears	<ul style="list-style-type: none"> • Failure in internal communication or temperature inputting circuit. ❖ Make a call for service.
Overheating	"ALARM" lamp lights on, "Er.19" appears	<ul style="list-style-type: none"> • Overheating prevention device is in operation. • Reset the power supply, and then adjust the setting temperature of the overheating protection device. ❖ If the state does not recover, make a call for service.
Abnormal fluid level	"ALARM" lamp lights on, "Er.20" appears	<ul style="list-style-type: none"> • The quantity of the circulating fluid is insufficient. • Refer to page 49 "Abnormal fluid level" ❖ If the state does not recover, make a call for service.
Measurement temperature error	"ALARM" lamp lights on, "----" appears	<ul style="list-style-type: none"> • Measurement value is out of display range. ❖ Make a call for service.
Refrigerator pressure error	"REFRIGERATO ERROR" lamp lights on	<ul style="list-style-type: none"> • The condenser filter is dirty. • The room temperature is high. • The temperature of the circulating fluid is 40°C or higher.

Trouble Shooting

Phenomenon	Check point
The unit does not start to operate although the leakage breaker is turned on.	<ul style="list-style-type: none"> • Check if the power cable is securely connected to the power supply. • Check if the power fails.
"ALARM" lamp lights on.	<ul style="list-style-type: none"> • Check the error code on page 53.
The temperature does not drop.	<ul style="list-style-type: none"> • Check if the set temperature is higher than the inside temperature of the bath. • Check if the condenser filter is dirty. • Check if the condenser fin is contaminated. • Check if the heat load of the circulation fluid has increased. • Check if the ambient temperature has risen. • Check if the area around the vent is blocked.
The refrigerator does not start to operate.	<ul style="list-style-type: none"> • The refrigerator is overloaded. Immediately turn off the leakage breaker, and check the points described in "The temperature does not drop" above. After a while, turn on the leakage breaker.
The circulating fluid does not circulate.	<ul style="list-style-type: none"> • Check if the circulating path is blocked or extremely constricted. • Check if the specific gravity and viscosity of the circulating fluid is proper.
"REFRIGERATO ERROR" lamp lights on.	<ul style="list-style-type: none"> • Check if the condenser filter is dirty. • Check if the room temperature is high. • Check if the temperature of the circulating fluid is 40°C or higher.
The displayed temperature does not match the measured temperature.	<ul style="list-style-type: none"> • Check if the set value of calibration offset is other than "0". Set it at "0". • Check the set value according to P.27 "Calibration Offset Function".

When a power failure occur

If the unit was deactivated in the middle of operation due to a power failure and is re-energized, the unit automatically returns to the state just before the power failure and resumes operation. If the resumption of operation by automatic recovery is inconvenient, turn off the leakage breaker.

In the case if the error other than listed above occurred, turn off the power switch and primary power source immediately. Contact the shop of your purchase or nearest Yamato Scientific Service Office.

In Case of Request for Repair

If the failure occurs, stop the operation, turn OFF the power switch, and unplug the power plug. Please contact the sales agency that this unit was purchased, or the Yamato Scientific's sales office.

< Check following items before contact >

- ◆ Model Name of Product
 - ◆ Production Number
 - ◆ Purchase Date
 - ◆ About Trouble (in detail as possible)
- } See the production plate attached to this unit.

Minimum Retention Period of Performance Parts for Repair

The minimum retention period of performance parts for repair of this unit is 7 years after discontinuance of this unit.

The "performance part for repair" is the part that is required to maintain this unit.

Product Name		Desktop type low constant temperature water bath	
Model		BBL101	BBL301
Circulation unit		External sealed unit circulation	
Usable ambient temp.		5°C~30°C	
Performance	Temperature control range	-10°C~80°C	
	Temperature adjustment accuracy	±0.1°C	
	Temperature distribution accuracy	±0.3°C	
	Cooling capacity	Approx.370W at15°C	Approx.410W at15°C
	Circulating/stirring method	Magnet pump circulation cooling/external sealed unit circulation	
	Maximum flow rate	3.7/4.7 L/min (50/60Hz)	
	Maximum head	1.0/1.5 m	
Configurations	Bath	SUS304	
	Temperature control system	PID control by microcomputer	
	Sensor	Pt100Ω (for temperature controller) and K-thermocouple (for overheating prevention device)	
	Temperature setting/display method	Digital setting / Digital display	
	Overheating prevention sensor	K-thermocouple	
	Heater	Stainless pipe heater SUS316L	
		700W	900W
	Refrigerator	Air-cooled fully closed compressor (reciprocal type)	Air-cooling sealed rotary
		160W	300W
	Cooling medium	R134a 250g	R404A 220g
	Cooling coil	Copper (nickel-plated)	
External circulating nozzle size	Discharge port and return port have outer diameter 10.5mm hose nipple		
Safety devices		Earth leakage breaker, Overheating prevention device, Pump thermal protector, Refrigerator overload relay protecting circuit, Delay timer for refrigerator protection, Refrigerator pressure detection, Float switch, Self-diagnostic functions (Failure of sensor, Heater disconnection, SSR short-circuit, Automatic overheating prevention)	
Other functions		Drain cock, Key lock Function, Calibration offset, Temperature output terminal, RS485 communication function, Refrigerator pressure indicator, condenser filter	
Standard	Bath dimensions (W×D×H)	300×150×177.5 mm	300×240×177.5 mm
	Effective internal dimensions (W×D×H)	238×100×85 mm	238×190×85 mm
	External dimensions* (W×D×H)	500×530×500 mm (Height of bath: 330 mm)	502×603×500 mm (Height of bath: 330 mm)
	Bath capacity (Effective capacity)	8L (6.75L)	13L (11.5L)
	Power supply (50/60Hz)	100V AC 9.3A	100V AC 12.5A
	Weight	Approx.50kg	Approx.55kg
Accessories		Bottom shelf, Shelf pegs, Cover, 0.5m Drain hose, 0.5m overflow hose, hose bands, Instruction manual	

* A depth size does not contain an external circulation nozzle.

Common to BBL101/301

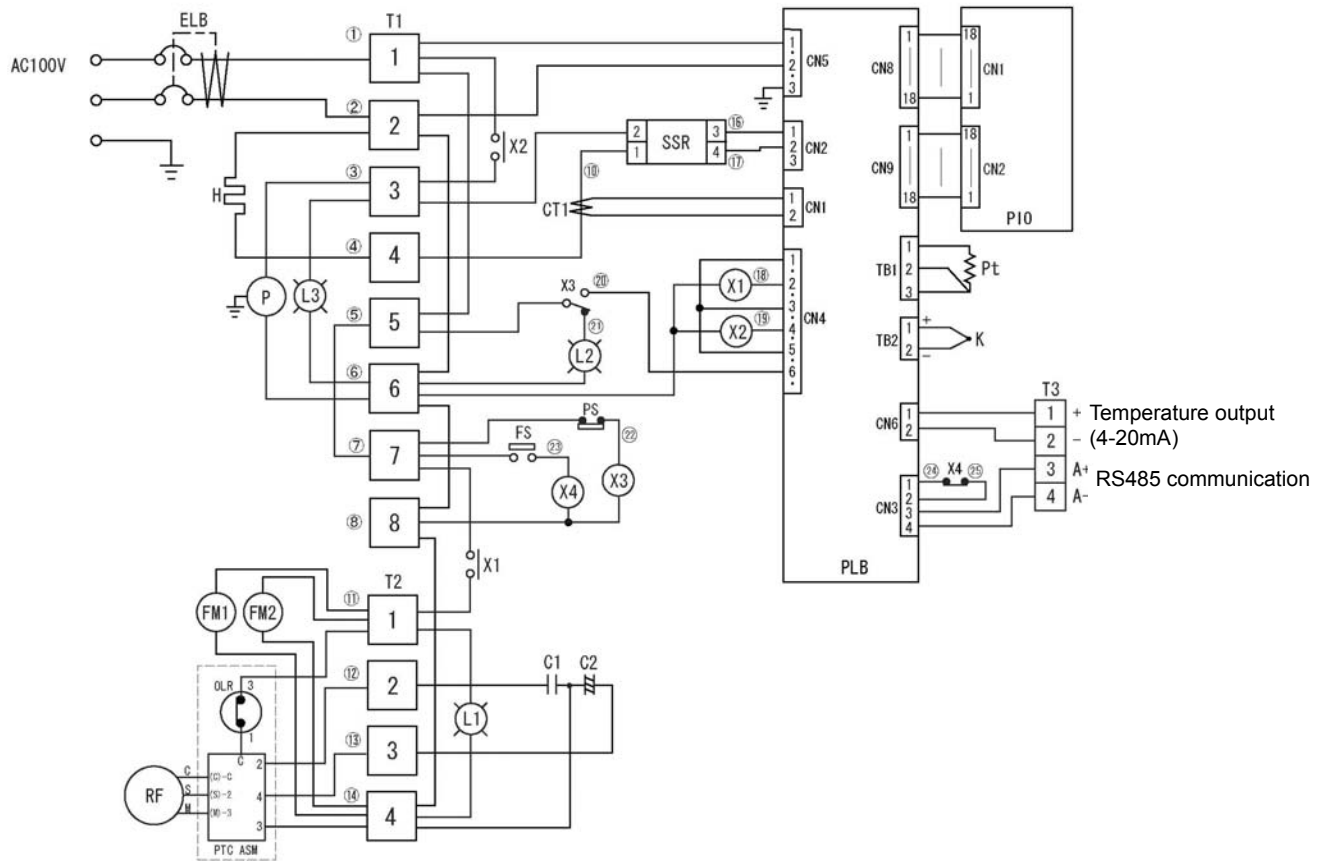

Symbol	Part name	Symbol	Part name
ELB	Earth leakage breaker	OVR	Overload relay
T1	Terminal block	C1	Operation condenser
T2	Terminal block	C2	Start condenser
T3	Terminal block	X5	Start relay
H	Heater	L1	Refrigerator lamp
SSR	SSR	L2	Refrigerator error lamp
CT1	Current transformer	L3	Pump lamp
PLB	PLANAR board	P	Magnet pump
PIO	Display board	X1	Relay (refrigerator)
Pt	Temperature sensor (Pt)	X2	Relay (heater)
K	Temperature sensor (K)	X3	Relay (pressure)
FM1, 2	Fan motor	X4	Relay (float)
RF	Compressor	PS	Pressure switch

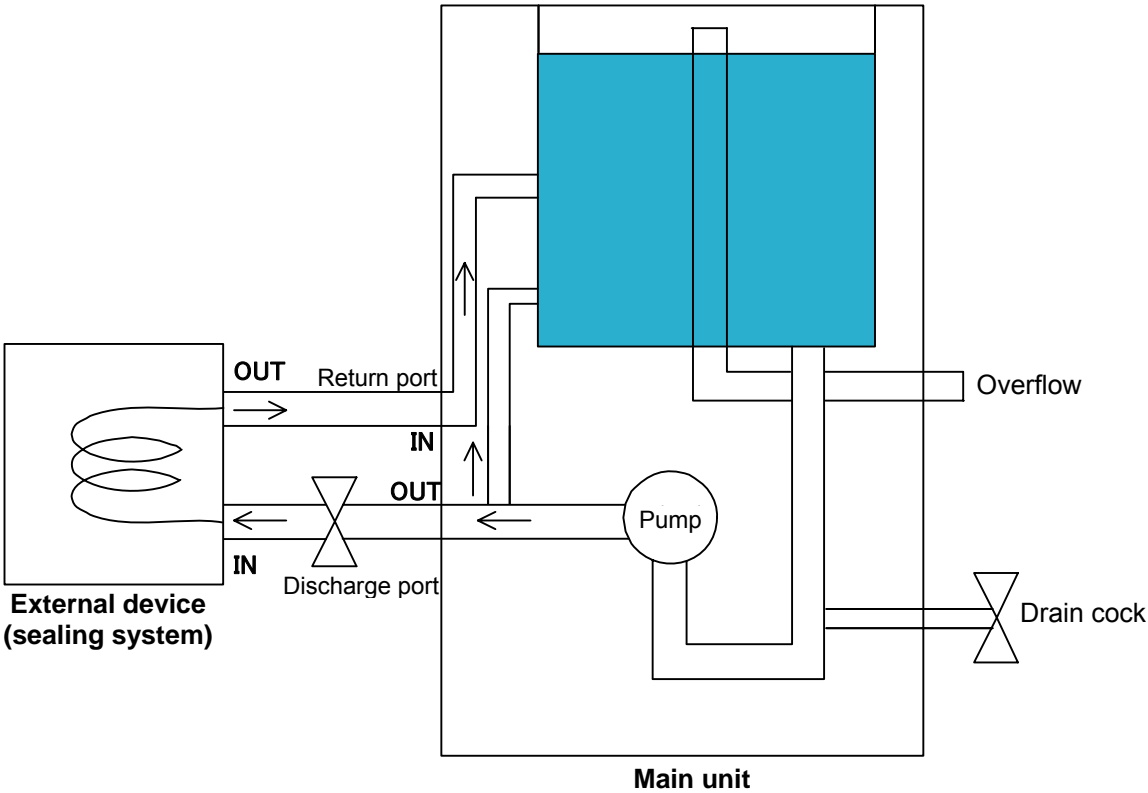

Replacement Parts Table

Common parts

Symbol	Part Name	Code No.	Specification	Manufacturer
PT, K	Double sensor	LT00006505	Pt&K sensor	Nihon Keisoku
PIO	Display board	1020000051	For VS3/4	Yamato Scientific
PLB	PLANAR board	1020000054	VS3P	Yamato Scientific
-	Tough card	1130000009	15P 40mm	Yamato Scientific
CT1	Current sensor	2170010005	CTL-6-S-H	URD
X1	Relay	2050000056	G7L-1A-TUB 100V	OMRON
X2	Relay	2050000043	AHN350XO	Matsushita
X3, X4	Relay	2050000040	AP5524F	Matsushita
FS	Float switch	LT00010383	HL-2B	Keihin Keiki
L1, L3	Lamp	2090060041	BN-9EG	Satoh Parts
L2	Lamp	2090060038	BN-9ER	Satoh Parts
P	Pump	LT00008210	MD-10K-N	Iwaki
SSR	SSR	2160000035	TRS5255	Yamato Scientific
ELB	Earth leakage breaker	LT00029774	NV-L22GR 15A 30mA	Mitsubishi
FM	Fan motor	2150000010	UF12A10-H	Japan Autonics

For BBL101

Symbol	Part Name	Code No.	Specification	Manufacturer
H	Heater	LT00033027	700W	Shinko Denki
RF	Compressor	LT00031836	FL1675-HF	Hitachi

For BBL301

Symbol	Part Name	Code No.	Specification	Manufacturer
H	Heater	LT00007340	900W	Shinko Denki
RF	Compressor		RL3062HA	Hitachi

List of Dangerous Substances



Never use explosive substances, flammable substances and substances that include explosive or flammable ingredients in this unit.

EXPLOSIVE

EXPLOSIVE:	Ethylene glycol dinitrate (nitro glycol), Glycerin trinitrate (nitroglycerine), Cellulose nitrate (nitrocellulose), and other explosive nitrate esters
	Trinitrobenzene, Trinitrotoluene, Trinitrophenol (picric acid), and other explosive nitro compounds
	Acetyl hidroperoxide (peracetic acid), Methyl ethyl ketone peroxide, Benzyl peroxide, and other organic peroxides

FLAMMABLE

IGNITING:	Lithium (metal), Potassium (metal), Sodium (metal), Yellow phosphorus, Phosphorus sulfide, Red phosphorus, Celluloid compounds, Calcium carbide, Lime phosphate, Magnesium (powder), Aluminum (powder), Powder of metals other than magnesium and aluminum, Sodium hydrosulfite
OXIDIZING:	Potassium chlorate, Sodium chlorate, Ammonium chlorate, and other chlorate
	Potassium perchlorate, Sodium perchlorate, Ammonium perchlorate, and other perchlorate
	Potassium peroxide, Sodium peroxide, Barium peroxide, and other inorganic peroxide
	Potassium nitrate, Sodium nitrate, Ammonium nitrate, and other nitrate
	Sodium chlorite and other chlorites
	Calcium hypochlorite and other hypochlorites
INFLAMMABLE LIQUID:	Ethyl ether, Gasoline, Acetaldehyde, Propylene chloride, Carbon disulfide, and other flammable substances having a flash point of lower than -30°C
	Normal hexane, ethylene oxide, acetone, benzene, methyl ethyl ketone, and other flammable substances having a flash point of -30°C or higher but lower than 0°C
	Methanol, Ethanol, Xylene, Pentyl acetate (amyl acetate), and other flammable substances having a flash point of 0°C or higher but lower than 30°C
	Kerosene, Light oil (gas oil), Oil of turpentine, Isopentyl alcohol (isoamyl alcohol), Acetic acid, and other flammable substances having a flash point of 30°C or higher but lower than 65°C
FLAMMABLE GAS:	Hydrogen, Acetylene, Ethylene, Methane, Propane, Butane, and other flammable substances which assume a gaseous state at 15°C and 1 atm

(Source: Appendix Table 1 of Article 6 of the Industrial Safety and Health Order in Japan)

* Install the unit according the procedure described below (check options and special specifications separately).

Model	Serial number	Date	Person in charge of installation (company name)	Person in charge of installation	Judgment

No.	Item	Method	Reference operation manual	Judgment
Specifications				
1	Accessories	Check the quantities of accessories with the quantities shown in the Accessory column.	Specification	P.56
2	Installation	<ul style="list-style-type: none"> Visually check the surrounding area. Caution: Pay attention to the ambient environment.	Before Using This Unit "1. Choose a proper place for installation"	P.8
		<ul style="list-style-type: none"> Keep space. 		
		<ul style="list-style-type: none"> Pour water into the water bath. 	Before Using This Unit "Installation Procedure"	P.11
Operation				
1	Power voltage	<ul style="list-style-type: none"> Using a tester, measure the voltage of the voltage used by the customer (distribution board, outlet, etc.). Measure the voltage during operation (the voltage must be within the standard). Caution: When a unit is to be connected to the plug or breaker, use one that conforms to the standard.	Before Using This Unit "9. Always ground this unit"	P.10
			Before Using This Unit "7. Choose a correct power distribution board or receptacle"	P.10
			Specification	P.56
2	Start of operation	<ul style="list-style-type: none"> Start operation. Set a value about 5°C lower than the room temperature, and check the stabilized state of the temperature drop time. Check: Water leakage is not permissible.	Before Using This Unit "Installation Procedure"	P.11
			Operation Method	P.16
Description				
1	Description of operation	Explain the operation of each unit to the customer according to this Operation Manual.	All	
2	Error code	Explain error codes and the procedure for resetting them to the customer according to this Operation Manual.	In the Event of Failure...	P.53
3	Maintenance inspection	Explain the operation of each unit to the customer according to this Operation Manual.	Maintenance Method	P.50
4	Completion of installation Information to be entered	<ul style="list-style-type: none"> Enter the date of installation and the name of the person in charge of installation on the face plate on the unit. Enter necessary information on the guarantee, and pass it to the customer. Explain the after-sale service route to the customer. 	After Service and Warranty	P. 55

Responsibility

Please follow the instructions in this document when using this unit. Yamato Scientific has no responsibility for the accidents or breakdown of device if it is used with a failure to comply. Never conduct what this document forbids. Unexpected accidents or breakdown may result in.

Note

- ◆ The contents of this document may be changed in future without notice.
- ◆ Any books with missing pages or disorderly binding may be replaced.

Instruction Manual for

Desktop Type Low Constant Temperature Water Bath

Model BBL101/301

First Edition Jul. 9, 2009

Revised Feb. 20, 2012

Yamato Scientific Co., Ltd.

2-1-6 Nihonbashi Honcho, Chuo-ku,
Tokyo, 103-8432, Japan

<http://www.yamato-net.co.jp>