



Instrument Drying Oven

Model DG800

Instruction Manual

First edition

- Thank you very much for purchasing this Yamato DG800 instrument drying oven.
- Please read the “Operating Instructions” and “Warranty” before operating this unit to assure proper operation. After reading these documents, be sure to store them securely together with the “Warranty” at a handy place for future reference.

⚠ Warning: Before operating the unit, be sure to read carefully and fully understand important warnings in the operating instructions.

**Yamato Scientific America Inc.
Santa Clara, CA**

Table of contents

1.Safety precautions	1
Explanation of pictograms	1
List of symbols	2
Warning · Cautions	3
2. Before operating the unit	4
Precautions when installing the unit	4
Installation procedures · precautions	7
3. Names and functions of parts	9
Main body	9
Operation panel	10
Explanation of characters	11
4. Operating procedures	12
List of operation modes and functions	12
Operation mode · function setting keys and characters	14
Operating procedures (settings for overheat prevention device)	15
Operating procedures (fixed temperature operation)	16
Operating procedures (auto stop operation)	17
Useful functions (calibration offset function)	19
Useful function (setting lock function)	21
Useful function (power outage compensation function)	23
5.Cautions on handling	25
6. Maintenance procedures	28
Daily inspection/maintenance	28
7.When the unit is not to be used for a long time or when disposing	29
When the unit is not to be used for a long time or when disposing	29
Notes about disposition	29
8.Troubleshooting.	30
Safety device and error codes	30
When a malfunction is suspected	31
9.After sales service and warranty	32
When requesting a repair	32
10.Specifications.	33
11.Wiring diagram.	34
12.List of replacement parts.	35
13.List of dangerous materials	36
14.Standard installation manual	37

1.Safety precautions

Explanation of pictograms

About pictograms

A variety of pictograms are indicated in this operating instruction and on products for safe operation. Possible results from improper operation ignoring them are as follows.

Be sure to fully understand the descriptions below before proceeding to the text.

 **Warning** Indicates a situation which may result in death or serious injury (Note 1.)

 **Caution** Indicates a situation which may result in minor injury (Note 2) and property damages (Note 3.)

(Note 1) Serious injury means a wound, an electrical shock, a bone fracture or intoxication that may leave after effects or require hospitalization or outpatient visits for a long time.

(Note 2) Minor injury means a wound or an electrical shock that does not require hospitalization or outpatient visits for a long time.

(Note 3) Property damage means damage to facilities, devices and buildings or other properties.

Meanings of pictograms



This pictogram indicates a matter that encourages the user to adhere to warning ("caution" included).
Specific description of warning is indicated near this pictogram.



This pictogram indicates prohibitions
Specific prohibition is indicated near this pictogram.



This pictogram indicates matters that the user must perform
Specific instruction is indicated near this pictogram.

1.Safety precautions

List of symbols

Warning



General warnings



Danger!: High voltage



Danger!: High temperature



Danger!: Moving part



Danger!: Hazard of explosion

Caution



General cautions



Electrical shock!



Burning!



Caution for no liquid heating!



Caution for water leak!



For water only



Poisonous material

Prohibitions



General bans



Fire ban



Do not disassemble



Do not touch

Compulsions



General compulsions



Connect ground wire



Install levelly

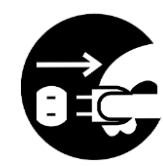

Pull out the power plug



Regular inspection

1.Safety precautions

Warning · Cautions

Warning



Never operate the unit in an atmosphere containing flammable or explosive gas

Never operate the unit in an atmosphere containing flammable or explosive gas. Otherwise, an explosion or a fire may result since the unit is not explosion-proof. See section "13.List of dangerous materials "on page 36.



Be sure to connect the ground wire.

Be sure to connect the ground wire correctly. Otherwise, electrical leak may result and cause an electrical shock or a fire.



Ban on operation when an abnormality occurs

When a smoke or a unusual odor is seen or sensed, immediately turn the electric leakage breaker on the main unit off and pull out the power plug. A fire or an electrical shock may result.



Never use electrical power cords bundled.

When these are used bundled, they might overheat causing a fire.



Take care not to damage electrical power cords.

Avoid tightly bend, pull with a strong force or twist to prevent electrical power cords from damaging. A fire or an electrical shock may result.



Never use an explosive or a flammable material with this unit.

Never use an explosive material, a flammable material or a material containing them. Otherwise, an explosion or a fire may result. See section "13.List of dangerous materials "on page 36.



Never try to touch a hot part.

Some parts of the unit are hot during and immediately after operation. Take special care for possible burning.



Never try to disassemble or alter the unit.

Never try to disassemble or alter the unit. A malfunction, a fire or an electrical shock may result.



Caution



When a thunder is heard.

When a thunder is heard, turn the main power off immediately. A malfunction, fire or an electrical shock may result.

2. Before operating the unit

Precautions when installing the unit

1. Carefully select an installation site.



Take special care not to install the unit at a place described below:

- Uneven surfaces or dirty surfaces
- Where flammable gas or corrosive gas exists
- Where the ambient temperature is 35°C or more
- Where temperature changes severely
- Where humidity is high
- Where subject to direct sunlight
- Where vibration is severe



Install this unit at a place with spaces shown below.

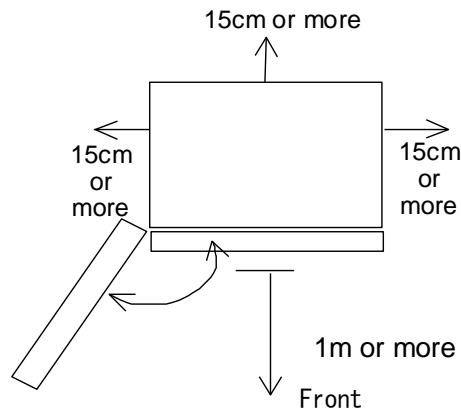

2. Install the unit on a level surface.



Install the unit on a level surface. If the whole bottom surface of the unit does not contact the surface evenly, vibrations or noises may result. This might cause unexpected troubles or malfunctions.

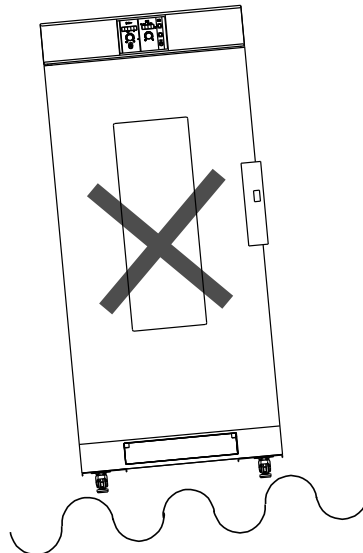

The unit weight is approx. 78 kg.

When lifting the unit for transportation and installation, carefully handle it by at least two people.

3. Installation



The unit might fall down or move by an earthquake or an impact causing a personal injury. We recommend making safety measures such as to avoid installing the unit at a place other than busy places.

2. Before operating the unit

Precautions when installing the unit

4. Secure sufficient ventilation for the unit.

- ⊘ Do not operate the unit when its side panels and vent holes are blocked. Internal temperature of the unit will rise degrading the performance and an accident, a malfunction or a fire may result.

5. Do not operate the unit at such a place that may subject to splash.

- ⊘ Do not operate the unit at such a place that may subject to splash. Liquid entering the inside may cause an accident, a malfunction, an electrical shock or a fire.

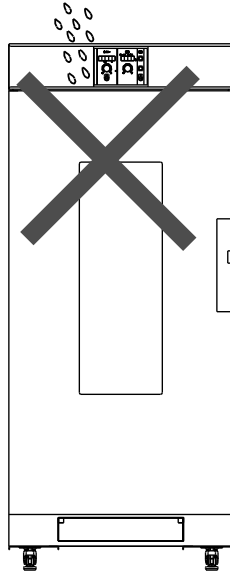

6. Never operate the unit in an atmosphere containing flammable or explosive gas.

- ⊘ Never operate the unit in an atmosphere containing flammable or explosive gas. Since the unit is not explosion-proof, an arc is discharged when switching the electric leakage breaker "ON" and "OFF" and during operation and a fire or an explosion may result.
- ⚠ See the section "13. List of dangerous materials" on page 36 for flammable and explosive gases.

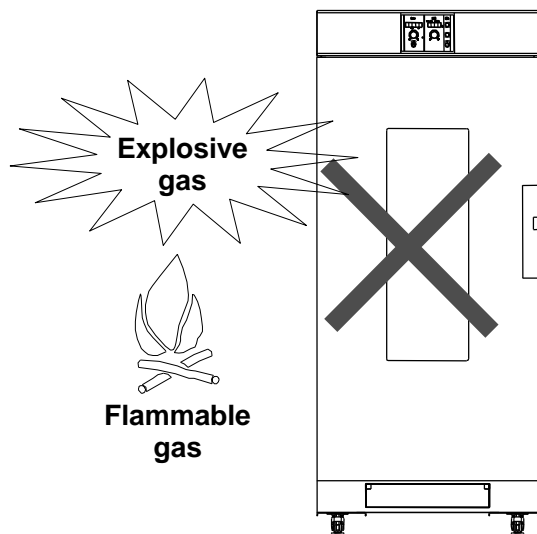

2. Before operating the unit

Precautions when installing the unit

7. Be sure to connect the power plug to the dedicated power distribution panel or a wall outlet.



Use a power distribution panel or a wall outlet that meets the electrical capacity of the unit.

Electrical capacity: DG800 AC115V 12A

- * When the unit will not start even when you turn the electric leakage breaker to "ON", check for low main voltage or if the unit is connected to the same power supply line as other devices and connect it to another line if necessary.

Avoid connecting too many devices using a branching outlet or extending a wire with a cord reel or temperature controlling function may degrade due to voltage drop.



Do not connect the unit to any parts or lines other than a correct power supply line such as a gas pipe, a water pipe or a telephone line.

Otherwise, an accident or a malfunction may result.

8. Handling of a power cord



Never use electrical power cords bundled. When these are used bundled, they might overheat causing a fire.

Do not convert, forcibly bend, twist or pull the power cord. Otherwise, a fire or an electrical shock may result.

Do not place the power cord under a desk or a chair, or sand between objects to avoid it from being damaged.

Otherwise, a fire or an electrical shock may result.

Do not place the power cord close to a stove or other heat generating device. Sheath of the cord may burn and result in a fire or an electrical shock.



If the power cord should be damaged (exposure of core wire or disconnection), immediately turn the ELB off, pull out the power cord (plug) out of the power supply and ask your dealer to replace the cord. Operating the unit with a damaged power cord may cause a fire or an electrical shock.



Connect the power cord to an appropriate wall outlet.

9. Be sure to connect the ground wire.



- When the unit has no ground terminal, class 3 grounding work is necessary and please consult your dealer or our nearest sales office.
- Securely connect to an outlet.



We recommend use of a ground type outlet When a bipolar type outlet tap is used
tap.

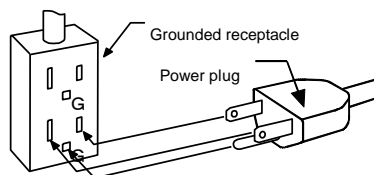

When there is no ground terminal.

In this case, class 3 grounding work is necessary and please consult your dealer or our nearest sales office.

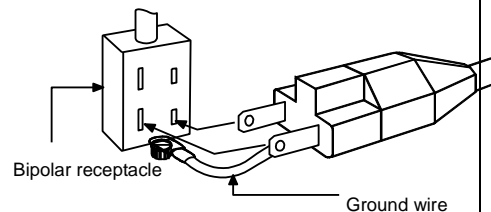

Insert the ground adaptor included as an option, into a power plug confirming the polarity of the outlet. Connect the grounding wire (green) of the ground adaptor to the ground terminal on the power supply equipment.



Do not connect the grounding wire to any parts or lines other than a correct grounding terminal such as a gas pipe, a water pipe or a telephone line.

Otherwise, an accident or a malfunction may result.

2. Before operating the unit

Installation procedures • precautions

- (1) Raise the adjuster feet on the caster wheels.

Raise the adjuster feet on the front/rear and right/left of the caster wheels as shown in the right figure. Make sure casters at the four points move smoothly before trying to move the unit.

*Note that moving the unit over a bump may give an excessive impact to and break the casters. Where there is such a bump, move the unit by lifting it by at least two people.

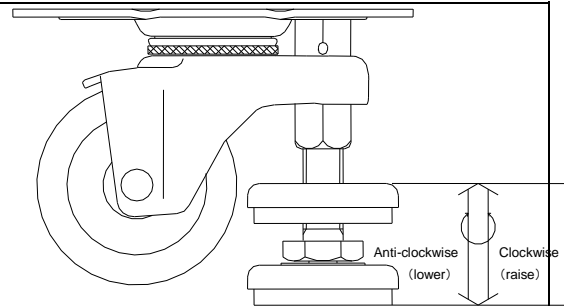

- (2) Select an installation site.

Push down the caster stoppers to lock while making sure that caster wheels at four points securely rest on a flat surface as well as there is no loosened part or inclination of the unit.

- (3) Placement of the drain pan.

Be sure to place a drain pan to receive water generated during the drying process.

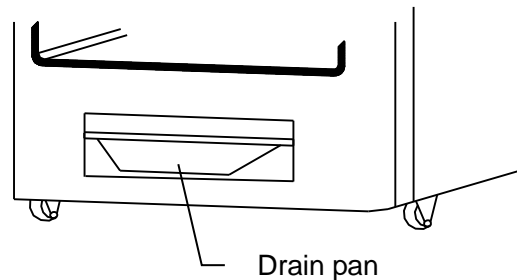

- (4) Install shelf boards.

- Install shelf pegs at heights you want on the right and left shelf posts in the internal bath of the main body.
- Completely push shelf boards by sliding to the end.
- *Take care to put each shelf board on correct pairs of right and left shelf pegs.
- Make sure that shelf boards will not fall nor rattle.
- Withstand load of each shelf board is 15kg in even loading. When putting instruments, arrange them as dispersed as possible.

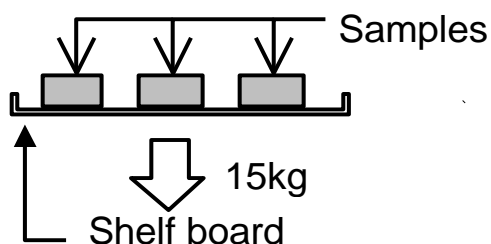

2. Before operating the unit

Installation procedures • precautions

- Put instruments with appropriate spaces between them. Too many instruments may prevent proper temperature control. To assure proper temperature control, put instruments with a space at least 30% of the shelf board area.

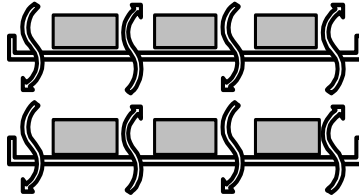

Assure at least 30% space

- (5) Take special care for instruments shown below:
- ① Instruments that contain flammable or explosive components or such instruments to which samples containing those components are attached.
 - The unit is not explosion proof. Never attempt to dry or process instruments to which samples that contain flammable or explosive components are attached.
 - ② Corrosive instruments
 - Take care for handling of corrosive instruments or instruments to which corrosive components are attached. Although SUS304 stainless steel is used for major routes, note that they might corrode with strong acid. Note that packings may corrode with acid, alkali, oil or organic solvents.
- (6) Always operate the unit with the exhaust ports open.
- There are two exhaust ports on the top surface of the unit. In regular operation, open the exhaust ports. Adjust their opening level according to the water amount attached to a specific instrument.



Note that high temperature steam may be blowing out of the exhaust ports.

To prevent a burn, never try to look into the exhaust ports or touch those parts with bare hands.

- (7) Always shut the door completely.
- Make sure that the clamp on the right side of the door is completely locked before operating the unit.

3. Names and functions of parts

Main body

Front panel of DG800

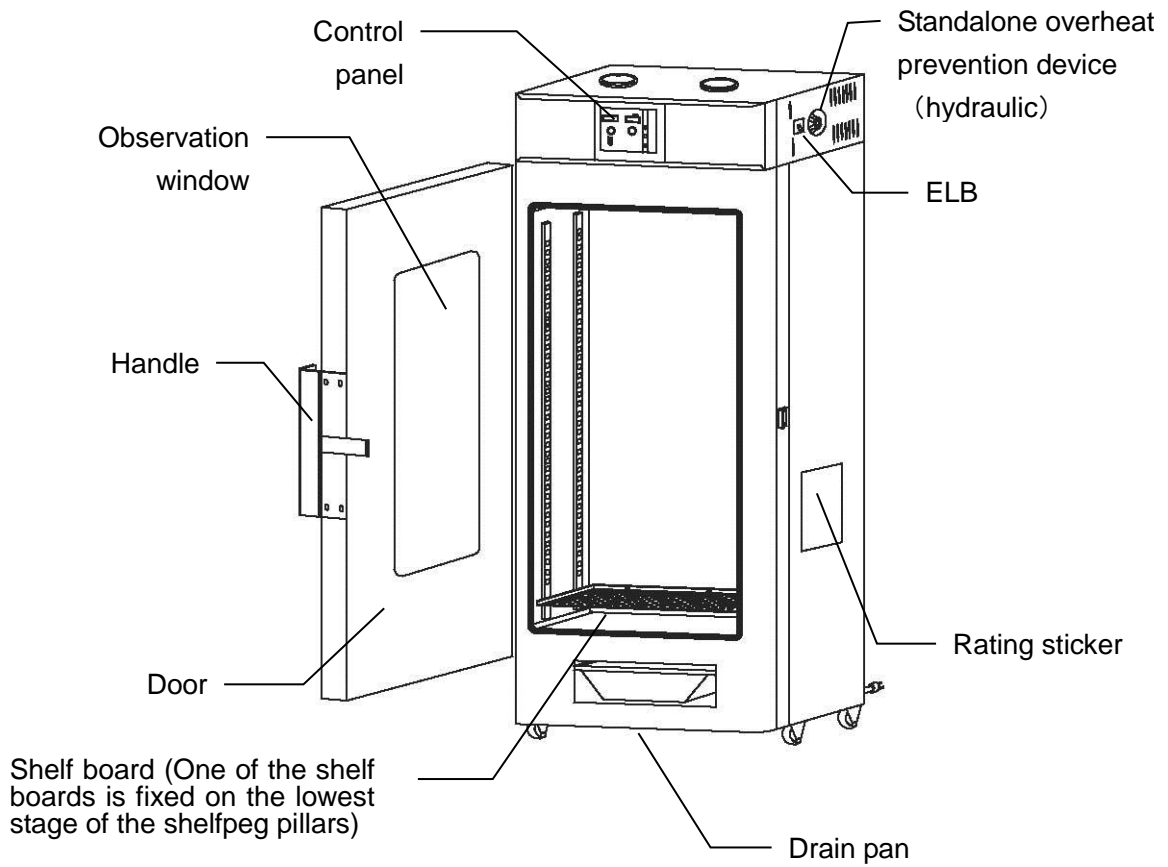

Rear panel of DG800

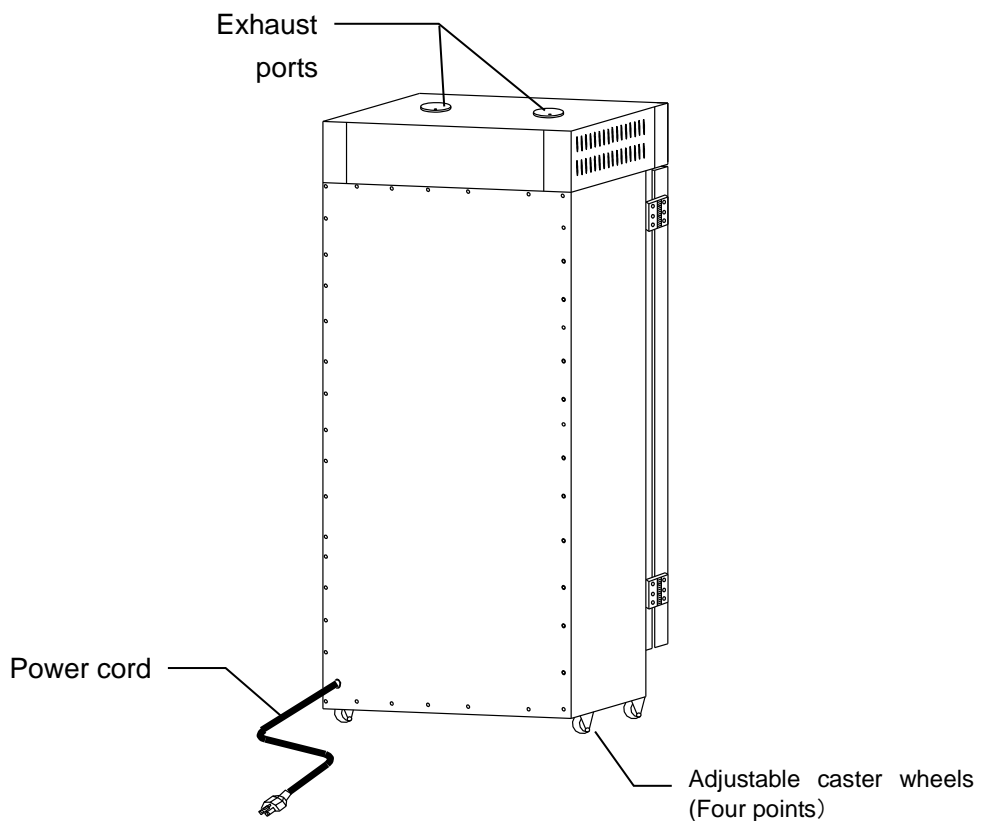

3. Names and functions of parts

Operation panel

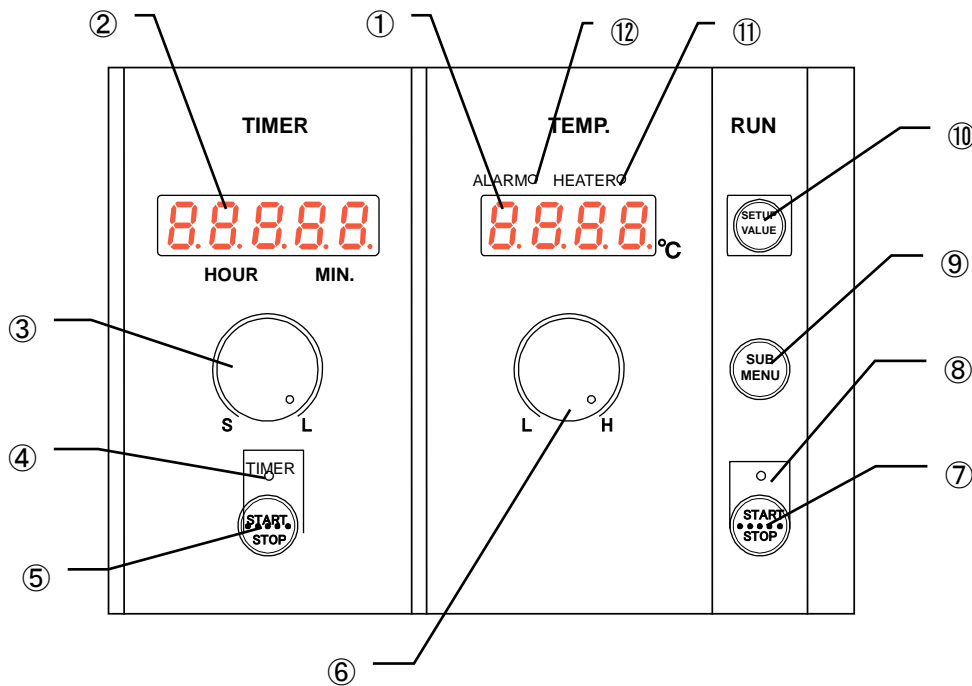

No.	Name	Operation/action
①	Temperature display	Displays a measured temperature, a set temperature, and various parameters.
②	Timer display	Displays a set time, remaining time, setting characters for various parameters.
③	Timer setting dial	Used for changing timer settings.
④	TIMER lamp	Indicates the status of a timer function.
⑤	START/STOP key of TIMER	Used for starting/stopping timer operation.
⑥	Temperature setting dial	Used for setting a temperature.
⑦	START/STOP key of RUN	Used for starting/stopping operation.
⑧	Operation lamp	Indicates the current operating status.
⑨	SUB MENU key	Used to switch to the sub menu.
⑩	SETUP VALUE key	Used to tentatively display settings on the temperature and timer displays.
⑪	HEATER lamp	Indicates the current heater control output status.
⑫	ALARM lamp	Indicates the alarm output status.

3. Names and functions of parts

Explanation of characters

Characters on the controller are explained in this section.

Characters	Identifier	Name	Application
	End	Time up	Displayed when timer operation has ended. See page 17.
	cAL	Calibration offset setting	Used for inputting a calibration offset temperature See section "Using the calibration offset function" on page 19.
	Lock	Key lock of settings	Key locks settings to prevent their alteration. See section "Using the lock function" on page 21.
	Pon	Power outage compensation setting	Used for setting an operation when recovered from power outage. See section "Using the power outage compensation function" on page 23.

* See the section "Operation mode · function setting keys and characters" on page 14 for operation modes and characters of functions.

4. Operating procedures

List of operation modes and functions

Operation modes of the unit are as shown below:

No.	Name	Description	Page
1	Fixed temperature operation	Turning the ELB on to enter the operation setting mode. Turn the Temperature setting dial to set a temperature. Pressing the START/STOP key of RUN starts the operation and pressing it stops operation.	P.16
2	Auto stop operation	Used when you want to “set automatic stop for fixed value operation when making settings for it.” Turn the Temperature setting dial to set the stopping time. Pressing the TIMER START/STOP key of TIMER starts auto stop operation.	P.17

4. Operating procedures

List of operation modes and functions

Functions of the unit are as shown below:

No.	Name	Description	Page
1	Overheat prevention function	<p>Automatic overheat prevention function: This function is linked to the unit set temperature and has been set to so that it is automatically activated (returned automatically) at a temperature 12°C higher than the set temperature in the bath.</p> <p>Standalone overheat prevention device: When the temperature in the bath reaches the set temperature of the overheat prevention device, controller power is shut off. (Controller display will be eliminated) Change temperature setting of the hydraulic overheat preventing device on the right side of the unit to the correct value (set temperature +25°C), turn the ELB OFF once and then turn it ON again.</p>	P.15
2	Calibration offset function	<p>Calibration offset function compensates any differences between the target temperature in the bath and the control temperature of the controller (sensor temperature.) The function can compensate to either plus or minus side for the whole temperature band of the unit. This compensation can be set with the SUBMENU key.</p>	P.19
3	Setting lock function	<p>This function locks the set operation status. The lock can be set or released with the SUBMENU key.</p>	P.21
4	Power outage compensation function	<p>This function returns the main unit operation to the resume status after recovery from power outage, or keeps the current stop status. This compensation can be set with the SUBMENU key.</p>	P.23

4. Operating procedures

Operation mode - function setting keys and characters

Key operations and characters in the diagram below are used for operation mode and function settings.

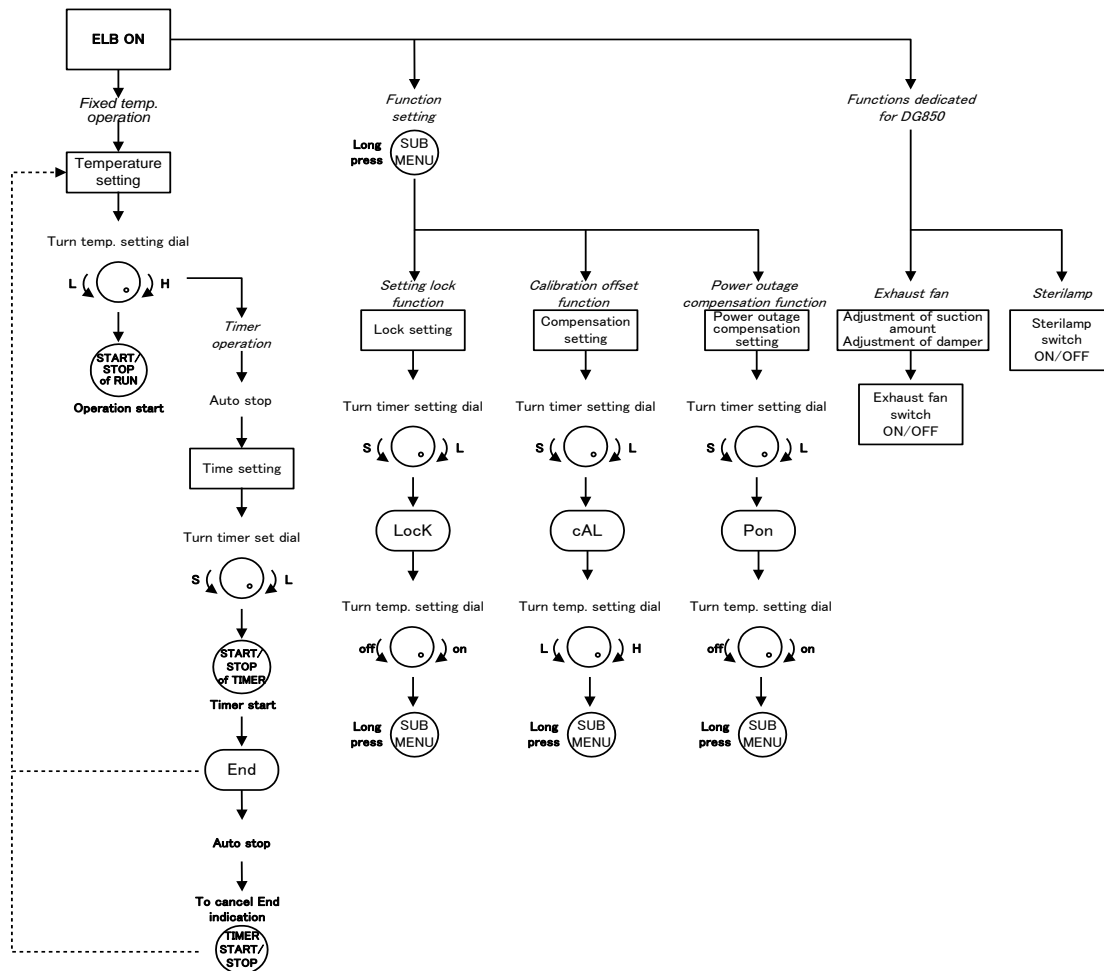

4. Operating procedures

Operating procedures (settings for overheat prevention device)

As a safety measure for preventing overheat, a hydraulic overheat prevention device (manual return) is installed.

Temperature setting range and functions

The temperature setting range for the standalone overheat prevention device is “50°C~120°C.”

When the temperature in the bath keeps rising beyond the controller set temperature and reaches the set temperature of the overheat prevention device, controller power is shut off. (Controller display will be eliminated)

When the overheat prevention device is activated, it will not be released until the ELB is turned on.

Change temperature setting to the correct value (set temperature +25°C), turn the ELB OFF once and then turn it ON again.

How to set temperature

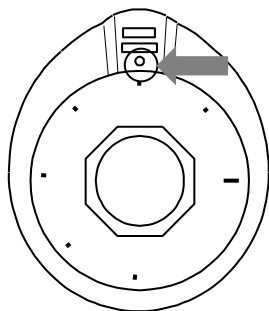

Set the temperature scale
to the arrow

Setting the overheat prevention temperature

- Set the temperature scale on the hydraulic overheat prevention device installed on the upper right side of the unit to the arrow in the diagram shown left.
- Turn the ELB to “OFF” and wait for a while without opening the door.
- After a while, turn the ELB ON (set the ELB “ON”).

Caution

- ① Set temperature as “set temperature +25°C” as a rough standard and add 5°C to the setting if the device functions improperly.
- ② The temperature setting range for the standalone overheat prevention device is “50°C~120°C.” Be sure to set the overheat prevention activation temperature correctly otherwise the device may not start, the overheat prevention device is activated before temperature in the bath increases completely, or a fire or other unexpected accidents may result.
The temperature is set at 120°C on shipping from the factory.
- ③ If the temperature for the standalone overheat prevention device is set at around or below the room temperature, the device may be triggered when the door is opened.
- ④ The overheat prevention device has been designed to prevent overheating of devices not to protect samples. The device does not prevent accidents caused from use of explosive or flammable substances.

4. Operating procedures

Operating procedures (fixed temperature operation)

How to start fixed temperature operation

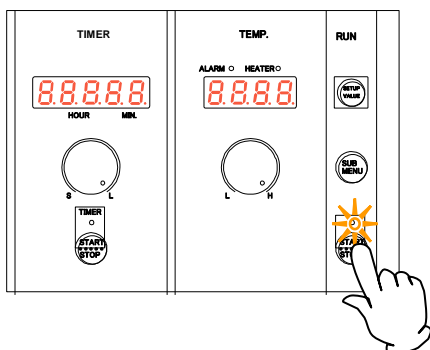
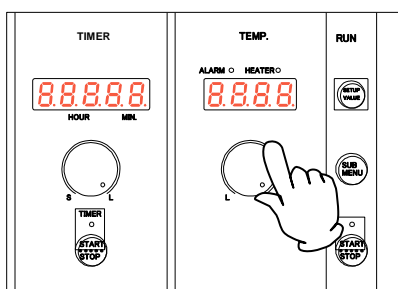
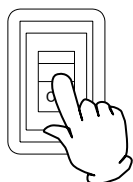

1. Turn the ELB ON. (Turn the ELB to “ON.”)

When the ELB is turned ON, the initial values will be displayed for about four seconds, then the initial screen will appear and the time is displayed in the timer display screen and the current bath temperature, in the temperature display screen.

2. Setting the temperature

Turn the Temperature setting dial to set value on the temperature display to a temperature you want. The temperature can be set with the Temperature setting dial in the range of 0°C~80°C. Turning the dial clockwise increases setting and turning it anti-clockwise decreases it. When the desired temperature is obtained, temperature display flashes three times and changes to the current bath temperature display. Now temperature setting has completed.

3. Starting operation

Press the **START/STOP** key of RUN. Operation lamp above the **START/STOP** key of RUN comes on and operation starts.

4. Stopping operation

Press the **START/STOP** key of RUN. Operation lamp above the **START/STOP** key of RUN goes off and operation stops.

Confirming and changing a set temperature during operation

To confirm the set temperature, press the **SETUP VALUE** key. Indications on the timer display as well as on the temperature display flash three times. The flashing temperature is the set temperature.

To change the set temperature, turn the Temperature setting dial to reset value on the temperature display to a temperature you want. When the desired temperature is obtained, temperature display flashes three times and changes to the current bath temperature display. Now temperature setting during operation has completed.

4. Operating procedures

Operating procedures (auto stop operation)

This function is used when you “want to stop the unit automatically on the time you want after fixed temperature operation is started.” Time can be set from 30 minutes to 24 hours in the unit of 30 minutes.

Procedures for auto stop operation

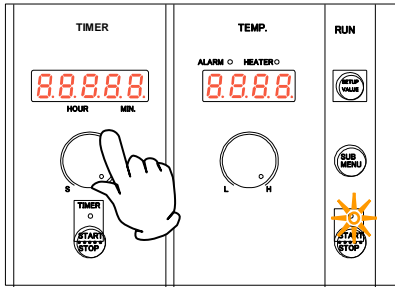

1. Setting a stop time

Make sure that the operation lamp above the **START/STOP** key of RUN is illuminated.

Using the timer setting dial, set time from timer start to stop on the timer display. (Turning the timer setting dial clockwise increases time and turning the dial anti-clockwise decreases time. Time can be set from 30 minutes to 24 hours in the unit of 30 minutes.)

When the temperature you want is obtained, the timer display flashes three times and determined.

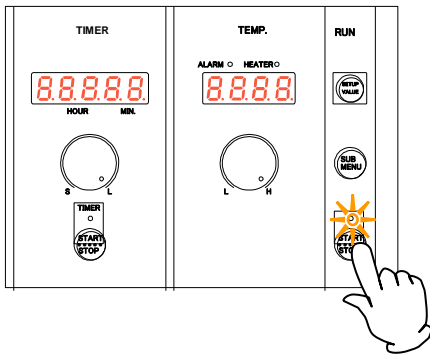

2. Starting timer operation

Confirm that the time displayed on the timer display is the one you want, and then press the **START/STOP** key of TIMER. Countdown starts when the timer lamp above the **START/STOP** key of TIMER comes on and “:” in the timer display flashes.

3. Stopping and ending timer operation

Timer display changes to flashing End **End** when the set time has passed and the remaining time becomes 0 indicating that timer countdown has completed and the unit operation will end automatically.

Aborting countdown

When you want to abort countdown before its end, press the **START/STOP** key of TIMER again and confirm that the timer lamp above the **START/STOP** key of TIMER has gone off. In this case, the time already counted down will be reset.

4. Operating procedures

Operating procedures (auto stop operation)

Operation after stop during auto stop operation

Flashing of End **End** on the timer display can be released with the **START/STOP** key of TIMER. Even without the procedures above, setting can be resumed from step 2 of "Operating procedures (fixed temperature operation)" on page 16



Caution

- ① Pressing the **SETUP VALUE** key during countdown displays the input time on setting on the timer display.
- ② Note that touching the timer setting dial during operation will easily change timer set time, thus the remaining time. If you want to prevent the remaining time from changing easily, we recommend setting as described in the section "Using the lock function on page 21.
- ③ Note that bath temperature remains close to the set temperature immediately after the unit has stopped operation when timer countdown has ended. Operation stop refers only to machine stop and time needed for decreasing the temperature in the bath is not considered.

4. Operating procedures

Useful functions (calibration offset function)

Using the calibration offset function

Calibration offset function compensates any differences between the target temperature in the bath and the control temperature of the controller (sensor temperature.) The function can compensate in parallel to either plus or minus side for the whole temperature band of the unit.

The lock can be set or released with the **SUBMENU** key.

The temperature is set at “0” on shipping from the factory.

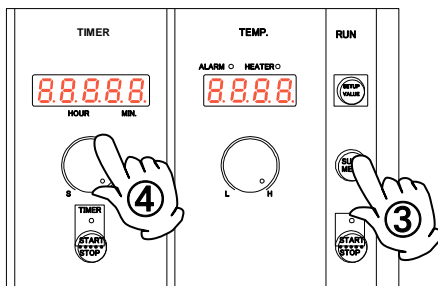
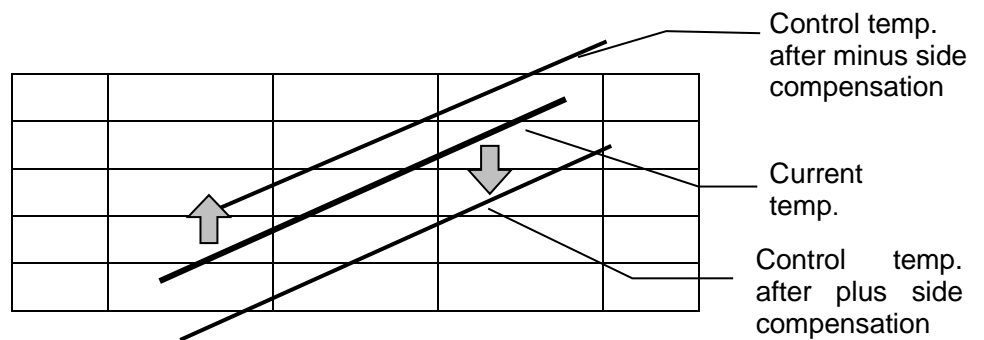

- ① Start operation at the target set temperature and confirm the temperature in the bath with a temperature recorder after temperature has stabilized.
- ② Confirm the difference between the set temperature and that in the bath.
- ③ Press the **SUBMENU** key long until the indication starts to change.
- ④ Turning the timer setting dial clockwise scrolls functions in the order of Lock **Locfi** → cAL **cAL** → Pon **Pon** and turning it anti-clockwise, in the order of Lock **Locfi** → Pon **Pon** → cAL **cAL**.

【Display of functions and modes】

Lock: Key lock function

(Key lock setting and cancel)

cAL: Calibration offset function

Pon: Power outage compensation function

Display cAL **cAL** in the timer display. In this time confirm that “0” (factory setting) is displayed on the temperature display.

4. Operating procedures

Useful functions (calibration offset function)

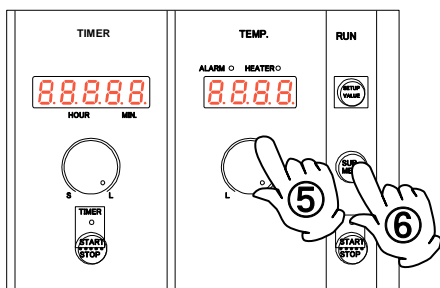

- ⑤ Turn the temperature setting dial to enter difference between the set temperature and the bath temperature. Turning the temperature setting dial clockwise increases setting and turning it anti-clockwise decreases it.

(After calibration offset setting, when you continue to make settings for key lock or power outage compensation move to step 2 of procedures for each of these functions after step ③.)

- ⑥ Confirm that cAL cAL is displayed on the timer display and “setting” on the temperature display, press the SUB MENU key long. Setting is completed when the timer display shows time and the temperature display shows a bath temperature.

- * You can set either of + or – side for the offset compensation temperature in the unit of 1°C. When compensation is set for the – side, the measured temperature display decreases by the compensation temperature while the temperature in the bath increases by the same amount. When compensation is set for the + side, the measured temperature display increases by the compensation temperature while the temperature in the bath decreases by the same amount.
- * Since too large a compensation value may result in larger difference between the actual and indicated temperatures and may present a danger, consult our nearest sales office before entering a large compensation value.
- * The device has, in addition to the calibration offset function, the two-point compensation function that adjusts offset for the lower temperature range and higher temperature range, for which adjustment temperatures have been input on shipping from the factory.
- * Consult the nearest sales office before attempting validation work for the temperature adjusting device.

4. Operating procedures

Useful function (setting lock function)

Using the lock function

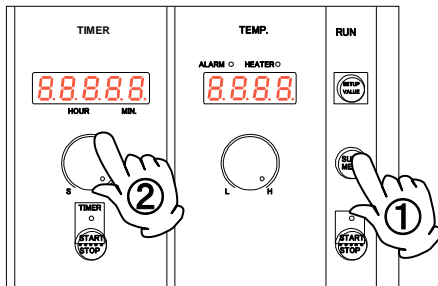

This function locks the set operation status.

The temperature is set at “off” on shipping from the factory.

1. Key lock setting

- ① Press the **SUB MENU** key long until the indication starts to change.
- ② Turning the timer setting dial clockwise scrolls functions in the order of Lock **Lock** → cAL **cAL** → Pon **Pon** and turning it anti-clockwise, in the order of Lock **Lock** → Pon **Pon** → cAL **cAL**.

【Display of functions and modes】

Lock: Key lock function

(Key lock setting and cancel)

cAL: Calibration offset function

Pon: Power outage compensation function

Display Lock **Lock** in the timer display. In this time confirm that “off” (factory setting) is displayed on the temperature display.

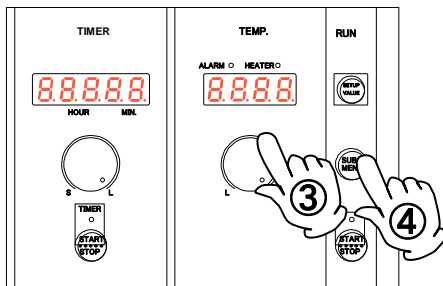

- ③ Turn the temperature setting dial clockwise to confirm that the temperature display is turned “on.”
(Turning the temperature setting dial clockwise turns the display “on” and turning the dial anti-clockwise “off.”)
- ④ Press the **SUB MENU** key long when the timer display shows Lock **Lock** and the temperature display shows “on.” Setting is completed when the timer display shows time and the timer display shows a bath temperature.

* When the lock function is “on”, keys other than the **START/STOP** key of RUN, the **SUB MENU** key and the **START/STOP** key of TIMER are locked. Changes of temperature setting, timer set time and setting of the calibration offset function are disabled.

4. Operating procedures

Useful function (setting lock function)

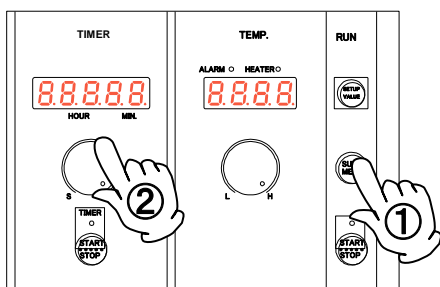

2. Key lock release

- ① Press the **SUB MENU** key long until the indication starts to change.
- ② Turning the timer setting dial clockwise scrolls functions in the order of Lock **LocH** → cAL **cAL** → Pon **Pon** and turning it anti-clockwise, in the order of Lock **LocH** → Pon **Pon** → cAL **cAL**.

【Display of functions and modes】

Lock: Key lock function

(Key lock setting and cancel)

cAL: Calibration offset function

Pon: Power outage compensation function

Display Lock **LocH** in the timer display. In this time confirm that “on” is displayed on the temperature display.

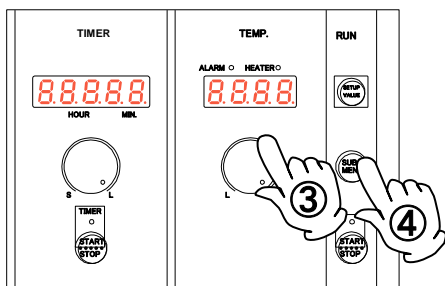

- ③ Turn the temperature setting dial clockwise to confirm that the temperature display is turned “off.”
(Turning the temperature setting dial clockwise turns the display “on” and turning the dial anti-clockwise “off.”)
(After key lock setting, when you continue to make settings for calibration offset or power outage compensation move to step 2 of procedures for each of these functions after step ③.)
- ④ Press the **SUB MENU** key long when the timer display shows Lock **LocH** and the temperature display shows “off.” Setting is completed when the timer display shows time and the timer display shows a bath temperature.

4. Operating procedures

Useful function (power outage compensation function)

Using the power outage compensation function

The power outage compensation function returns the main unit operation to the resume status after recovery from power outage, or keeps the current stop status.

The function is set at “on” on shipping from the factory.

The “on” setting resumes operation after recovery from power outage.

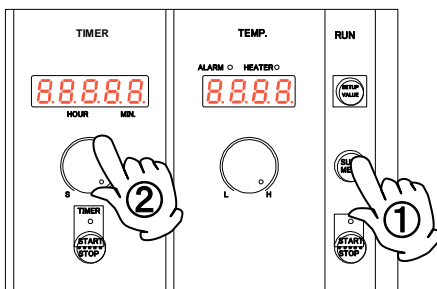

1. Power outage compensation setting

- ① Press the **SUB MENU** key long until the indication starts to change.
- ② Turning the timer setting dial clockwise scrolls functions in the order of Lock **LocH** → cAL **cAL** → Pon **Pon** and turning it anti-clockwise, in the order of Lock **LocH** → Pon **Pon** → cAL **cAL**.

【Display of functions and modes】

Lock: Key lock function

(Key lock setting and cancel)

cAL: Calibration offset function

Pon: Power outage compensation function

Display Pon **Pon** in the timer display. In this time confirm that “on”(factory setting) is displayed on the temperature display.

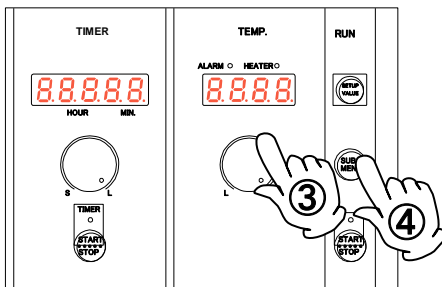

- ③ Turn the temperature setting dial anti-clockwise to confirm that the temperature display is turned “off.”
(Turning the temperature setting dial clockwise turns the display “on” and turning the dial anti-clockwise “off.”)
- ④ Press the **SUB MENU** key long when the timer display shows Pon **Pon** and the temperature display shows “off.” Setting is completed when the timer display shows time and the timer display shows a bath temperature.

The unit remains stopped after recovery from power outage.

4. Operating procedures

Useful function (power outage compensation function)

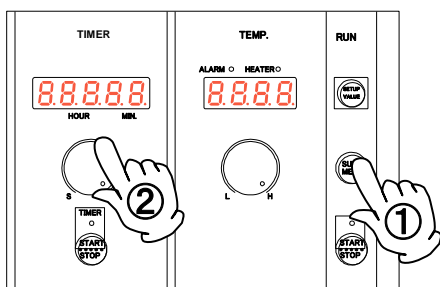

2. Power outage compensation release

- ① Press the **SUB MENU** key long until the indication starts to change.
- ② Turning the timer setting dial clockwise scrolls functions in the order of Lock **LocH** → cAL **cAL** → Pon **Pon** and turning it anti-clockwise, in the order of Lock **LocH** → Pon **Pon** → cAL **cAL**.

【Display of functions and modes】

Lock: Key lock function

(Key lock setting and cancel)

cAL: Calibration offset function

Pon: Power outage compensation function

Display Pon **Pon** in the timer display. In this time confirm that “off” is displayed on the temperature display.

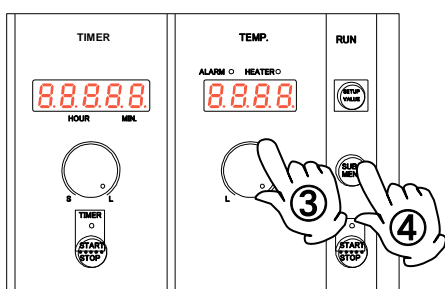

- ③ Turn the temperature setting dial clockwise to confirm that the temperature display is turned “on.”
(Turning the temperature setting dial clockwise turns the display “on” and turning the dial anti-clockwise “off.”)
(After power outage compensation function setting, when you continue to make settings for calibration offset or key lock move to step 2 of procedures for each of these functions after step ③.)
- ④ Press the **SUB MENU** key long when the timer display shows Pon **Pon** and the temperature display shows “on.” Setting is completed when the timer display shows time and the timer display shows a bath temperature.

5.Cautions on handling



Warning

1. About handling of flammable or combustible solution

-  The unit is not explosion proof. Take special care for handling instruments on which explosive materials, combustible materials or materials containing these are attached. Flammable or combustible solution will evaporate when left at a room temperature (or at a lower temperature for some types of solutions) and may be ignited and explode from switches, lights and other ignitable sources. Be sure to assure sufficient ventilation when using these materials.

See the section "13.List of dangerous materials
on page 36

2. Ban on use/countermeasures when an error occurs

-  If smoke is emerges on the unit or an odd odor is felt, immediately turn the ELB on the main unit off, turn the power supply off and contact your dealer or a Yamato sales office for inspection. Otherwise, a fire or an electrical shock may result. The user shall never attempt to repair the unit to avoid any possible dangers.

3. Secure sufficient ventilation for the unit.

-  Do not operate the unit when its side panels and vent holes are blocked. Internal temperature of the unit will rise degrading the performance and an accident, a malfunction or a fire may result.

4. Do not allow liquid to spill over the unit.

-  Do not allow liquid to spill over the unit. Pay special attention not to allow liquid to enter into the vent holes. If liquid is spilt over or into the unit, do not try to operate it any further. Other wise, an accident, a malfunction, a fire or an electrical shock may result.

5. Do not allow a metal piece to fall into the unit.

-  Do not allow a clip, a staple, a screw or other metal pieces to fall into the unit. Stop operating the unit if a metal piece has dropped into the unit. Other wise, an accident, a malfunction, a fire or an electrical shock may result.

6. Do not open the cabinet.

-  Do not open panels or covers fixed on the unit, or do not operate the unit with any of those open. Other wise, an accident, a malfunction, or an electrical shock may result.

7. Do not attempt to operate the unit without the drain pan.

-  Do not attempt to operate the unit without the drain pan. Other wise, an accident, a malfunction, or an electrical shock may result.

8. Do not attempt to modify the unit.

-  The user shall never try to modify the unit; other wise, an accident, a malfunction, a fire or an electrical shock may result.

5. Cautions on handling



1. Do not step on the unit.

-  Do not step on the unit. Otherwise, the unit may trip over or be damaged resulting a personal injury or a malfunction.

2. Do not put or drop an object on the unit.

-  2. Do not put or drop an object on the unit. Since the unit contains high precision devices, vibrations or shock may cause a malfunction.

3. When a thunder is heard.

-  When a thunder is heard, turn the ELB on the main unit off then turn the main power off immediately. Otherwise, a lightning strike may result and cause a fire.

4. During night and not to be operated for a long period of time.

-  During the night and when you want to stop the unit for a longer period of time, turn the ELB to "off" and pull out the power cord from the power supply.

5. About recovery from power outage.

-  When the power is applied again after the unit has stopped due to power outage, the unit will automatically return to the status immediately before the power outage and resumes operation.
Turn the ELB off if you do not want to resume operation by automatic recovery.

6. Always operate the unit at a correct ambient temperature.

-  The operating temperature range is room temperature range from +5~70°C above room temperature.
Never try to operate the unit outside the operating temperature range.

7. When opening or closing the door

- 
 - When opening or closing the door, do not put your hand or face close to the area the door moves (space).
The door may touch your hand or face and causing an injury.
 - After operation has been completed, do not leave the unit with its door open in order to, for example, cool down inside of the bath or dry instruments earlier. Heat from inside the bath may cause deformation of the control panel of a malfunction of the control devices.

8. Do not operate the unit with the door open.

-  When the unit is operated with the door open, proper temperature control is not possible and the heater may overheat causing a possible danger. Be sure to operate the unit with the door closed.

5.Cautions on handling



9.About installation of shelf boards and instruments



Place shelf boards · samples correctly according to the section “Installation · cautions” on page 7. If these are placed incorrectly, the unit will be unable to perform correctly as well as an accident or a malfunction may result.

10.Do not attempt to do anything other than specified in this operation manual.



Do not attempt to do anything other than specified in this operation manual. Otherwise, an unexpected accident may result.

6. Maintenance procedures

Daily inspection/maintenance

Be sure to perform daily inspection and maintenance to assure reliable operation of the unit.

Warning

- Be sure to pull out the power cord unless necessary before trying to do inspection and maintenance works.
- Start these works after the device has returned to the normal temperature.
- Never try to disassemble the unit.

Caution

- Wipe off any dirt with a tightly wrung soft cloth. Never try to clean the unit with benzene, thinner or scouring powder, or rub with a scrubbing brush. Deformation, degradation or discoloration may result.

Every month

Inspect the functions of the ELB.

Test shall be performed with the power cord connected and power is being supplied to the unit.

- First turn the ELB to “off.”
- Then, turn the ELB “on” and press the test button on the device with a ball-point pen to check whether it is turned off to indicate that it is in the normal state.

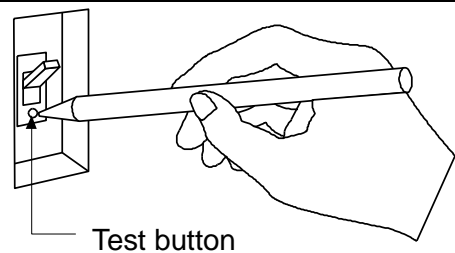

Maintenance of the internal bath

Stop operation and turn the ELB to OFF. Pull out the power cord off the distribution board and the wall outlet. Confirm the temperature in the device and remove shelf boards and clamps.

The internal bath, shelf boards and shelf clamps are made of SUS304 stainless steel and reinforced glass is used for the observation window. To clean these items, thoroughly wipe with a cloth moistened with cleaning alcohol then wipe gently with a dry cloth.

Never use acid detergent, alkaline detergent, oil or organic solvent, which may cause corrosion or damage to the products.



There are sharp protrusions inside the internal bath, shelf boards and shelf pillars and shall be handled with special care to avoid personal injury. Be sure to wear gloves since handling with bare hands may present danger.

7. When the unit is not to be used for a long time or when disposing

When the unit is not to be used for a long time or when disposing



Caution

When the unit is not going to be used for a long time

- Turn the ELB to off and pull out the power cord.



Warning

When disposing the unit

- Do not leave the unit in the area where children may have access.
- Be sure to remove handles before disposing the unit to prevent the doors from locking.
- In general, dispose the unit as a bulky waste.

Notes about disposition

Always pay attention to the preservation of the global environment.

- We highly recommend taking the unit apart as far as possible for separation or recycling to contribute to the preservation of the global environment. Major components and materials for the unit are as follows:

Names of major components	Major materials
Major exterior components	
Exterior	Bonderized steel sheet iron, melamine resin baking finish
Internal bath	Stainless steel SUS304
Packing	Silicon rubber
Nameplates	Polyethylene (PET) resin film
Major electric parts	
Switches and relays	Resin, copper
Boards	Glass fiber
Pipe heater	SUS304
Power cord	Synthesized rubber sheath, copper, nickel



8.Troubleshooting

Safety device and error codes

The unit has the self diagnostic function with a controller and a separate safety device.
Table below shows possible causes and measures when the safety device is triggered.

[Error codes]

When a functional or mechanical abnormality occurs, the alarm lamp will illuminate on the control panel and an error code will be displayed on the control panel. When an abnormality occurs, confirm the error code and immediately stop operation.

Safety device	Symptom	Possible causes and measures
Sensor error	Alarm lamp on  appears	<ul style="list-style-type: none">● Error in the temperature input circuit● Disconnection or other errors in the temperature sensor● Measured temperature is outside the displayable range Contact our service department.
Memory error	Alarm lamp on  appears	<ul style="list-style-type: none">● Memory setting error Contact our service department.
Measured temperature error	Alarm lamp on ---- ---- appears	<ul style="list-style-type: none">● When the upper limit alarm of the temperature alarm function is triggered. Contact our service department.

8.Troubleshooting

When a malfunction is suspected

If any of the symptoms below occurs

Symptom	Check
Turning the ELB to on will not activate the unit.	<ul style="list-style-type: none"> ● If the power cord is connected to the power supply securely. ● If power outage is occurring. ● If the standalone overheat prevention device is working.
Temperature does not rise.	<ul style="list-style-type: none"> ● If the set temperature is below that in the device. ● If the power supply voltage has declined. ● If the ambient temperature is low. ● If cooling load for inside the bath is large.
Temperature fluctuates during operation.	<ul style="list-style-type: none"> ● If the set temperature is appropriate. ● If the power supply voltage has declined. ● If ambient temperature fluctuates widely. ● If load for inside the bath is large.
Displayed temperature differs from the measurement.	<ul style="list-style-type: none"> ● If the calibration offset setting is other than "0". Set it to "0." Confirm the settings in the section "Using the calibration offset function on page 19" .

If power outage occurs

When the power is applied again after the unit has stopped due to power outage, the unit will automatically return to the status immediately before the power outage and resumes operation. Turn the ELB off if you do not want to resume operation by automatic recovery.

- ◆ If the symptom does not match any of the above, immediately turn the ELB on the main unit off, pull out the power cord from the power supply and contact your dealer or one of our sales offices.

9. After sales service and warranty

When requesting a repair

When requesting a repair

If any trouble occurs, immediately stop operation, turn the ELB off, pull out the power plug and contact your dealer or our sales office.

Information necessary for requesting a repair

- Model name of the product
 - Serial number
 - Date (y/m/d) of purchase
 - Description of trouble (as in detail as possible)
- } See the warranty card or the nameplate on the unit.
} See section "3. Names and functions of parts" on page 9.

Be sure to indicate the warranty card to our service representative.

Warranty card (attached separately)

- Warranty card is given by your dealer or one of our sales offices and please fill in your dealer, date of purchase and other information and store securely.
- Warranty period is one full year from the date of purchase. Repair service for free is available according to the conditions written on the warranty card.
- For repairs after the warranty period consult your dealer or one of our sales offices. Paid repair service is available on your request when the product's functionality can be maintained by repair.

Minimum holding period of repair parts

The minimum holding period of repair parts for this product is seven years after end of production.

Repair parts here refer to parts necessary for maintaining performance of the product.

10. Specifications

Product name		Instrument Drying Oven
Model		DG800
System		Natural convection, natural exhaust
Operating temperature range		Room temperature+5°C~70°C
Configuration	Inner material	Stainless steel SUS304
	Observation window	Standard glass 3mm w250 x h700mm
	Heater	SUS pipe heater 1.34kW
Control assembly	Control system	PID control with a micro computer
	Temperature setting · display system	Dial digital setting · digital display
	Operation mode	Fixed temperature operation, auto stop operation
	Sensor	K thermocouple
	Auxiliary functions	Calibration offset function, lock function, power outage compensation function
Safety device	Self diagnostic function	Temperature sensor error, memory error, temperature input circuit error, measured temperature error
	Protection device	ELB with an over current protector, hydraulic standalone overheat prevention device
Standard	Internal dimensions (w x d x h mm)	620 × 600 × 1195
	Outer dimensions (w x d x h mm)	674 × 711 × 1618
	Number of shelves · withstand load	29shelves 15kg/shelf
	Shelf pitch	30 mm
	Capacity	445ℓ
	Power supply(i50/60Hz)	AC115V 12A
	Weight	Approx.78kg
Included items		Shelf boards x 4(One of the shelf boards is fixed on the lowest stage of the shelf peg pillars), drain pan, operating manual, warranty card

*Performance values are for the AC115V power supply with no-load.

*Operating environmental temperature range for this device is 5°C~35°C.

11.Wiring diagram

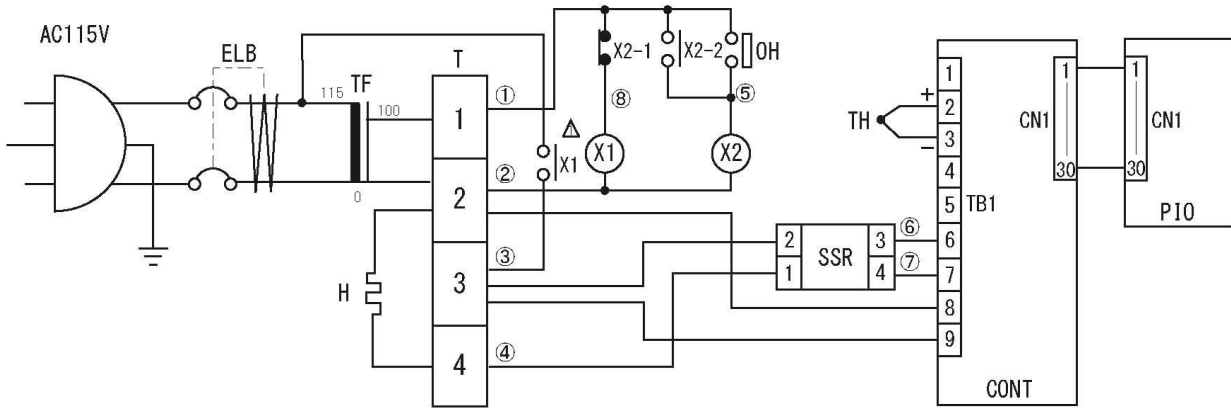

Symbol	Part name	Symbol	Part name
ELB	Electric leakage breaker with an over current protector	OH	Thermostat (Standalone overheat prevention device)
T	Terminal block	TH	Temperature sensor (K)
H	Heater	CONT	Planar circuit board
X1,X2	Relay	PIO	Display circuit board
SSR	Solid state relay	TF	Transformer

12.List of replacement parts

Replacement parts

Symbol	Part name	Code No.	Specifications	Manufacturer
H	Heater		115V 1.34kW	Yamato
TH	Sensor	LT00009360	K thermocouple LCK-MI-3000Y	Yamato
OH	EGO thermostat	LT00008745	55.13225.070	E.G.O
PIO	Display circuit board	LT00010175	RCY	Yamato
CONT	Planar circuit board	LT00009358	RCY	Yamato
X1	Relay	2050000019	AHE1254	Panasonic
X2	Relay	2050080002	AP3124K	Panasonic
SSR	SSR	2160000035	TRS5225	Toho
ELB	ELB	2060050002	BJS2032N 20A	Panasonic
TF	Transformer	LT00018189	UD11-200A2	Toyozumi

13.List of dangerous materials



Never use an explosive substance a flammable substance or a substance containing them for this device.

Explosive substance	Explosive substance	① Nitroglycol, glycerine trinitrate, cellulose nitrate and other explosive nitrate esters
		② Trinitrobenzen, trinitrotoluene, picric acid and other explosive nitro compounds
Flammable substances	Explosive substances	Metal "lithium", metal "potassium", metal "natrium", yellow phosphorus, phosphorus sulfide, red phosphorus, celluloids, calcium carbide (a.k.a, carbide), lime phosphide, magnesium powder, aluminum powder, metal powder other than magnesium and aluminum powder, sodium dithionous acid (a.k.a., hydrosulphite)
	Oxidizing substances	① Potassium chlorate, sodium chlorate, ammonium chlorate, and other chlorates
		② Potassium perchlorate, sodium perchlorate, ammonium perchlorate, and other perchlorates
		③ Potassium peroxide, sodium peroxide, barium peroxide, and other inorganic peroxides
		④ Potassium nitrate, sodium nitrate, ammonium nitrate, and other nitrates
		⑤ Sodium chlorite and other chlorites
		⑥ Calcium hypochlorite and other hypochlorites
	Flammable substances	① Ethyl ether, gasoline, acetaldehyde, propylene chloride, carbon disulfide, and other substances with ignition point at a degree 30 or more degrees below zero.
		② n-hexane, ethylene oxide, acetone, benzene, methyl ethyl ketone and other substances with ignition point between 30 degrees below zero and less than zero.
		③ Methanol, ethanol, xylene, pentyl acetate, (a.k.a.amyl acetate) and other substances with ignition point between zero and less than 30 degrees.
④ Kerosene, light oil, terebinth oil, isopenthyl alcohol(a.k.a. isoamyl alcohol), acetic acid and other substances with ignition point between 30 degrees and less than 65 degrees.		
Combustible gas	Hydrogen, acetylene, ethylene, methane, ethane, propane, butane and other Substance which is a flammable gas at 15°C, one air pressure.	

(Quoted from the separate table 1 in Article 6, the enforcement order of the Industrial Safety and Health Law)

14. Standard installation manual

*Install the product according to the following: (Confirm separately for optional items or special specifications)

Model	Serial number	Date	Installation mgr.(company name)	Installation mgr.	Judgment

No.	Item	Implementation method	TOC No. Reference page of the operating instruction manual	Judgment
Specifications				
1	Included items	Check for number of staffs against the included item field	10. Specifications field P.33	
2	Installation	<ul style="list-style-type: none"> Visual check of environmental conditions Caution: Take care for environment 	2. Before operating the unit <ul style="list-style-type: none"> Carefully select an installation site P. 4	
		<ul style="list-style-type: none"> Securing a space 		
Operation-related matters				
1	Source voltage	<ul style="list-style-type: none"> Measure the user side voltage (outlet) with a tester Measure voltage during operation (shall meet the specifications) Caution: Always use a plug that meets the specification for attaching to the ELB. 	2. Before operating the unit <ul style="list-style-type: none"> Be sure to connect the ground wire. Be sure connect the power plug P. 6 P. 6 P.33 10.Specifications <ul style="list-style-type: none"> Specification-power supply 	
2	Operation start	<ul style="list-style-type: none"> Starts operation Performs fixed temperature operation and auto stop operation 	2. Before operating the unit P. 7 <ul style="list-style-type: none"> Installation procedures... P. 8 4. Operating procedures P. 12 24	
Description				
1	Operational descriptions	Explain operations of each component according to the operational instructions	4. Operating procedures P. 12 <ul style="list-style-type: none"> Operating procedures 24 1.Safety precautions P. 1 ~ 13.List of dangerous materials ~ 36	
2	Error codes	Explain the customer about error codes and procedures for release according to the operational instructions	8.Troubleshooting ~9.After sales service and warranty P.30 32	
3	Maintenance and inspection	Explain operations of each component according to the operational instructions	6. Maintenance procedures P.28 <ul style="list-style-type: none"> Daily inspection/maintenance 	
4	Completion of installation Entries	<ul style="list-style-type: none"> Fill in the installation date and the installation mgr. on the nameplate of the main unit Fill in necessary information to the warranty card and hand it over to the customer Explanation of the route for after-sales service 	9.After sales service and warranty P.32	

Limited liability

Be sure to use the unit strictly following the handling and operating instructions in this operating instruction.

Yamato Scientific Co.,Ltd. assumes no responsibility for an accident or a malfunction caused by use of this product in any way not specified in this operating instruction.

Never attempt to perform matters prohibited in this operation instruction.

Otherwise, an unexpected accident may result.

Notice

- **Descriptions in this operating instruction are subject to change without notice.**
- **We will replace a manual with a missing page or paging disorder.**

Instruction manual
Instrument Drying Oven
DG800
First edition February 8, 2017

Yamato Scientific America, Inc.

925 Walsh Avenue, Santa Clara,

CA 95050, U.S.A

<http://www.yamato-usa.com>

Toll Free: 1-800-2-YAMATO(1-800-292-6286)