

SINCE 1889



Sterilizer

Model

SK102C SK112C

SK201C SK211C

SK301C SK311C

Instruction Manual

- First Edition -

- Thank you for purchasing "Sterilizer, SK Series" of Yamato Scientific Chongqing Co., Ltd.
- To use this unit properly, read this "Instruction Manual" thoroughly before using this unit. Keep this instruction manual around this unit for referring at anytime.

⚠WARNING!

Carefully read and thoroughly understand the important warning items described in this manual before using this unit.

Yamato Scientific Chongqing Co., Ltd

Contents

◆ Cautions in Using with Safety	1
• Explanation	1
• Table of Illustrated Symbols	2
• Fundamental Matters of "WARNING!" and "CAUTION!"	3
◆ Before Using This Unit	5
• Requirements for Installation	5
• Installation Procedure	8
◆ Description and Function of Each Part	10
• Main Unit	10
• Control Panel (Keys)	11
◆ Operation Method	12
• Apparatus/Liquid Sterilization Course	12
• Sterilizing Parameters	16
◆ Handling Precautions	17
• WARNING	17
• CAUTION	18
◆ Maintenance Method	19
• Daily Inspection and Maintenance	19
◆ Long storage and disposal	20
• When not using this unit for long term / When disposing	20
◆ In the Event of Failure	21
• Safety Device and Error Code	21
◆ After Service and Warranty	22
◆ Specification	23
◆ Wiring Diagram	24
◆ Replacement Parts Table	26
◆ Reference	27
• List of Dangerous Substances	27

Explanation

MEANING OF ILLUSTRATED SYMBOLS

Illustrated Symbols

Various symbols are used in this safety manual in order to use the unit without danger of injury and damage of the unit. A list of problems caused by ignoring the warnings and improper handling is divided as shown below. Be sure that you understand the warnings and cautions in this manual before operating the unit.

 **WARNING!** If the warning is ignored, there is the danger of a problem that may cause a serious accident or even fatality.

 **CAUTION!** If the caution is ignored, there is the danger of a problem that may cause injury/damage to property or the unit itself.

Meaning of Symbols



This symbol indicates items that urge the warning (including the caution).
A detailed warning message is shown adjacent to the symbol.



This symbol indicates items that are strictly prohibited.
A detailed message is shown adjacent to the symbol with specific actions not to perform.



This symbol indicates items that should be always performed.
A detailed message with instructions is shown adjacent to the symbol.

Cautions in Using with Safety

Table of Illustrated Symbols

Warning



Warning generally



Warning high voltage



Warning high temperature



Warning drive train



Warning explosive

Caution



Caution generally



Caution electrical shock



Caution scald



Caution no road heating



Caution not to drench



Caution water only



Caution deadly poison

Prohibit



Prohibit generally



Prohibit inflammable



Prohibit to disassemble



Prohibit to touch

Compulsion



Compulsion generally



Compulsion connect to the grounding terminal



Compulsion install on a flat surface



Compulsion disconnect the power plug



Compulsion periodical inspection

Cautions in Using with Safety

Fundamental Matters of "WARNING!" and "CAUTION!"

WARNING!

Do not use this unit in an area where there is flammable or explosive gas

Never use this unit in an area where there is flammable or explosive gas. This unit is not explosion-proof. An arc may be generated when the power switch is turned on or off, and fire/explosion may result. (Refer to page 27 "List of Dangerous Substances".)

Always ground this unit

Always ground this unit on the power equipment side in order to avoid electrical shock due to a power surge.

If a problem occurs

If smoke or strange odor should come out of this unit for some reason, turn off the circuit breaker right away, and then disconnect the power plug or power terminal. Immediately contact a service technician for inspection. If this procedure is not followed, fire or electrical shock may result. Never perform repair work yourself, since it is dangerous and not recommended.

Do not use the power cord if it is bundled or tangled

Do not use the power cord if it is bundled or tangled. If it is used in this manner, it could overheat and fire may be caused.

Do not process, bend, wring, or stretch the power cord forcibly

Do not process, bend, wring, or stretch the power cord forcibly. Fire or electrical shock may result.

Substances that can not be used

Never use explosive substances, flammable substances and substances that include explosive or flammable ingredients in this unit. Explosion or fire may occur. (Refer to page 27 "List of Dangerous Substances".)

Do not disassemble or modify this unit

Do not disassemble or modify this unit. Fire or electrical shock or failure may be caused.

Do not get close to the vapor outlet / Do not block the outlet

The vapor outlet is provided on the left face of equipment. Do not put your hands or face close to the outlet. Do not block the outlet. A burn injury or equipment failure may result in.

Fundamental Matters of "WARNING!" and "CAUTION!"

CAUTION!

When opening the cover...

Make sure that the pressure of equipment has decreased to 0(zero) MPa before opening the cover. Generally the cover does not open due to the safety lock mechanism under the high pressure condition. The high-temperature and pressure vapor blows out if the cover is forced open under high pressure, which may cause a burn injury. A large amount of vapor blows out from inside of the chamber when opening the cover just after the sterilizing operation has completed (when the temperature inside the chamber is high). Do not put your hands and face close to the cover.



When draining water...

Make sure that the pressure of equipment has decreased to **0(zero)** MPa before draining the sterilizing water. The hot water blows out if the valve is opened under high pressure. The sterilizing water remains very hot just after the sterilizing operation has completed even the pressure reading is 0(zero) MPa. Drain the water after it is sufficiently cooled down.

Do not touch the hot section

Some sections on the equipment such as the circumference of cover or drain bottle are very hot during or just after the operation of equipment. Do not touch these sections to avoid burn injury.

When taking the sterile samples from the chamber...

Sufficiently remove the vapor inside the chamber before taking the sterile samples from the chamber. Wear heat-resistant leather gloves to take them from the chamber to protect your hands from high-temperature samples.

Do not touch the heat releasing outlet

Do not directly touch the heat releasing outlet located around the outer covering. The vapor may blow out from the safety valve by an accident during sterilizing operation. Do not block the outlet.

During a thunder storm

During a thunderstorm, turn off the power key immediately, then turn off the circuit breaker and the main power. If this procedure is not followed, fire or electrical shock may be caused.

Requirements for Installation

1. Choose a proper place for installation

- ⊘ Do not install this unit in a place where:
 - ◆ Rough or dirty surface.
 - ◆ Flammable gas or corrosive gas is generated.
 - ◆ Ambient temperature 35°C and above or 5°C and below.
 - ◆ Ambient temperature fluctuates violently.
 - ◆ There is direct sunlight.
 - ◆ There is excessive humidity and dust.
 - ◆ There is a constant vibration.
 - ◆ Not horizontal surface.
 - ◆ The power source is instable.
- ! Install this unit on a stable place with the space as shown below.

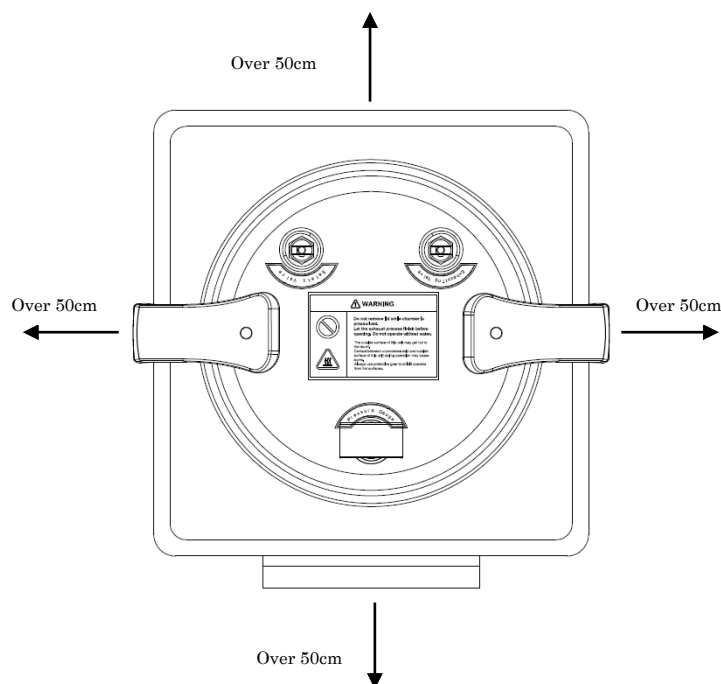

2. Installation on horizontal surface

- Flat ! Use the equipment on the horizontal and firm place to keep the water inside the chamber horizontal. If the equipment tilts and the heater appears from the water surface, the temperature on the area above the water rises and a heater failure or operation stop due to water level detector function may occur.
- ! The weight of main unit is approximately 14kg. Carry and install the equipment carefully by two or more persons.

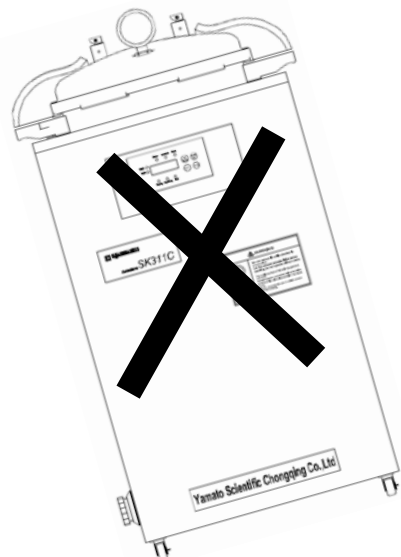

Requirements for Installation

3. Before/after installing



- It may cause injury to a person if this unit falls down or moves by the earthquake and the impact. etc..To prevent, take safety measures that the unit cannot fall down, and do not install it to a busy place.

4. Ventilate the equipment sufficiently



- Do not block the heat releasing outlets on the side face and back face of equipment during operation. The temperature inside the equipment rises, which may cause the deterioration or failure of equipment, accident, or fire disaster.

5. Do not use this unit in an area where there is flammable or explosive gas



- Never use this unit in an area where there is flammable or explosive gas. This unit is not explosion-proof. An arc may be generated when the power switch is turned ON or OFF, and fire/explosion may result.



- To know about flammable or explosive gas, refer to page 27 "List of Dangerous Substances".

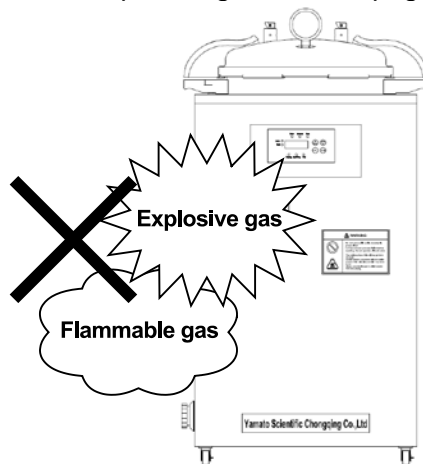

6. Choose a correct power distribution board or receptacle



- Choose a correct power distribution board or receptacle that meets the unit's rated electric capacity.
- Operating voltage range for respective equipment models are as follows.
SK102C models: AC115V SK112C models: AC220~ 230V
SK201C models: AC115V SK211C models: AC220~ 230V
SK301C models: AC115V SK311C models: AC220~ 230V

Electric capacity: SK102C: AC115V /17A, SK112C: AC220~ 230V / 9.5~10A
SK201C: AC115V /17A, SK211C: AC220~ 230V / 9.5~10A
SK301C: AC115V /17A, SK311C: AC220~ 230V / 9.5~10A



NOTE)

There could be a case that the unit won't run even after turning ON the power. Inspect whether the voltage of the main power is lower than the specified value, or whether the other device(s) uses the same power line of this unit. If these phenomena should be found, change the power line of this unit to the other power line.





- Starburst connection with a branching receptacle or extended wiring with a cord reel lowers electrical power voltage, which may cause the degradation of refrigeration capability.
- Connect the unit only to the recommended power supply. If this is connected to a gas pipe, water pipe or telephone line, it may result to an accident or malfunction, could cause injuries or fatality.

Requirements for Installation

7. Handling of power code

-  Do not entangle the power cord. This will cause overheating and possibly a fire.
- Do not bend or twist the power cord, or apply excessive tension to it. This may cause a fire and electrical shock.
- Do not lay the power cord under a desk or chair, and do not allow it to be pinched in order to prevent it from being damaged and to avoid a fire or electrical shock.
- Keep the power cord away from any heating equipment such as a room heater. The cord's insulation may melt and cause a fire or electrical shock.
-  If the power cord becomes damaged (wiring exposed, breakage, etc.), immediately turn off the power at the rear of this unit and shut off the main supply power. Then contact your nearest dealer for replacement of the power cord. Leaving it may cause a fire or electrical shock.
- Connect the power plug to the receptacle which is supplied appropriate power and voltage.

8. Always ground this unit

-  Be sure to connect the earth wire (the green cable of power cord) to the grounding conductor or ground terminal to prevent accidents caused by electric leakage.
-  Do not connect the earth wire to gas or water pipes. If not, fire disaster may be caused.
-  Do not connect the earth wire to the ground for telephone wire or lightning conductor. If not, fire disaster or electric shock may be caused.
-  Please consult your local electrical contractor for power connecting work.
- Do not use a branching receptacle, which may cause the heat generation.
- The D class earth connecting works is required if no ground terminal is provided. In this case, consult with the selling office where you purchased or our sales office.
- Securely connect it to the switchboard or outlet.

SK102C/112C/201/C/211C/301C/311C

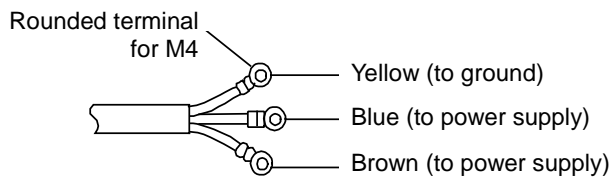

These models do not include the power plug. Correctly connect the ground to fit with the power supply facility to be connected.

9. Connect the power cord paying attention to the color of each core wire

-  When connecting the power cord, do check the breaker on the electric power equipment be "OFF".

Core Wire Color	Interior Wiring
Blue	Power Supply Side
Brown	Power Supply Side
Yellow	Ground Wire Side

Installation Procedure

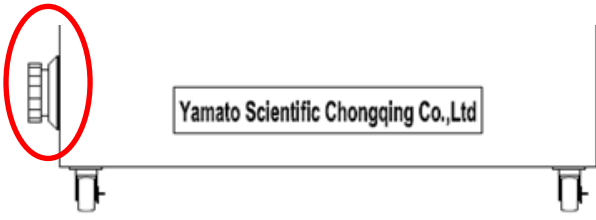
<p>1</p>	<p>Close the drain valve</p> <ul style="list-style-type: none"> Close the drain valve at the bottom on the left side face of main unit. Water leak occurs if not fully closed, which may cause the burn injury no-load (water) operation. The drain valve and lead it to the draining site. 	
<p>2</p>	<p>Pour water into the chamber</p> <ul style="list-style-type: none"> Before setting the sterile samples, pour water into the chamber to the water level gauge (notch) position. Insufficient water may cause the no-load (water) operation. Check the water level every time before operation. Refill it before the level becomes too low. Water is required to be poured at dissolution operation, as well as sterilizing operation. When the water level lowers, the equipment cuts off the heater. Depending on the conditions of equipment, however, the detection requires too much time, which may cause the heater deterioration. Refill water before the water level becomes too low. <p>Refer to the right table for the quantity of water to be refilled.</p>	
<p>3</p>	<p>Use distilled or purified water for sterilizing water</p> <ul style="list-style-type: none"> Fill distilled or purified water inside the chamber. Tap water may be used. Calculus generate inside the chamber when tap water is used. Frequent cleaning is therefore required. Do not use well water. It may cause the corrosion or dirt inside the chamber. 	
<p>4</p>	<p>Set the sterile samples</p> <ul style="list-style-type: none"> Set the samples to the chamber, putting them into the attached rack or cast (sold separately). Put the sample or sterilization bag into the chamber so they should not block or cover the sensor inside the chamber, exhaust outlet and end connection to pressure gauge. If they are blocked or covered, the vapor cannot be discharged and the equipment cannot be operated correctly. Do not spill the samples when taking them out or putting them into the chamber. The failure in piping system, bad smell or dirt may result in. In case liquid such as medicinal solution or medium is sterilized, the amount of liquid should be 60% or less of the capacity of container. They may be boiled over if too much quantity is supplied. Widely open the opening of sterilization bag when used. If it is closed, the samples are insufficiently sterilized. 	

Installation Procedure

6 Close the door before operation

- Place the sterilizing drum with properly-piled items into the pot with the positioning mark on the pot lid to be aligned to the center of the lower handle. Press the lid gently by hand and turn it clockwise for the upper and lower handles to close completely and the safety lock to remain in open position, and the safety lock will lock the upper and lower handles automatically when the pressure in pot rises.

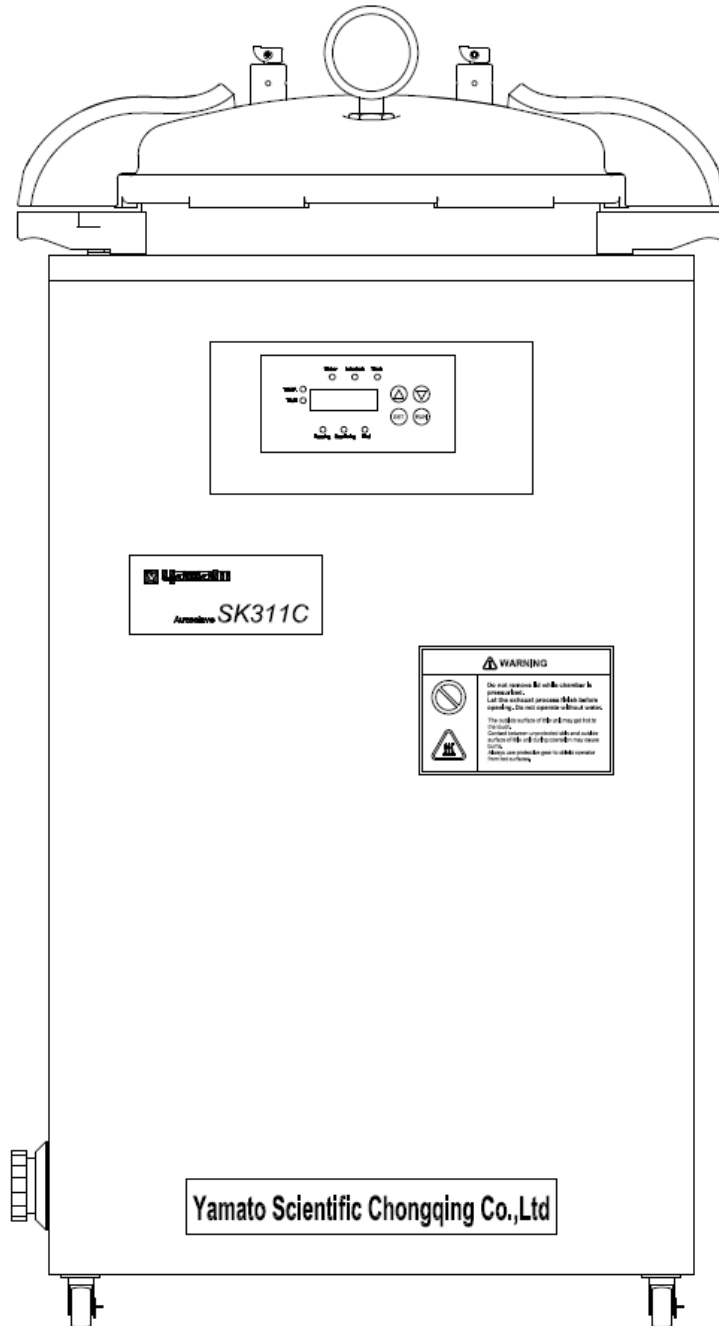

- The lock lever on the cover is held by the hook and does not move when the cover remains open.
- Fully close the cover and slide the lock lever on the cover to the left side. If it is closed inappropriately, the vapor blows out from the inside, which may cause a burns or injury to the people around it.
- Do not press the hook and operate the lock lever for purposes other than maintenance of equipment.

Description and Function of Each Part

Main Unit

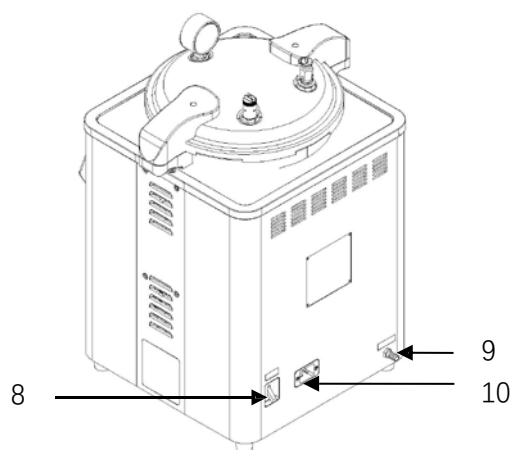
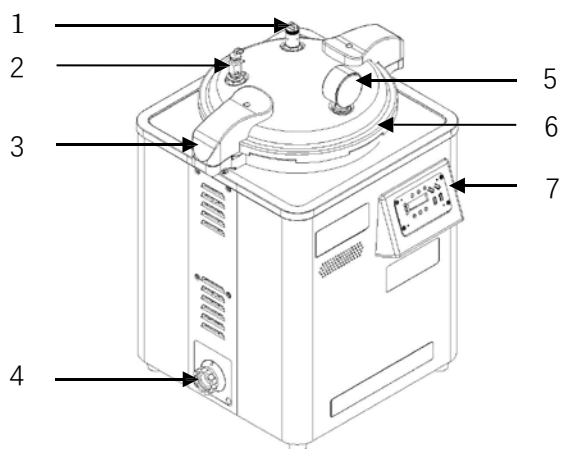

No.	Name	No.	Name
1	Safety valve	6	Upper cover
2	Vent valve	7	Operation panel
3	Handle (up/down)	8	Power switch
4	Exhaust (drain) valve	9	Exhaust (drain) port
5	Pressure gauge	10	Power interface

Description and Function of Each Part

Control Panel (Keys)

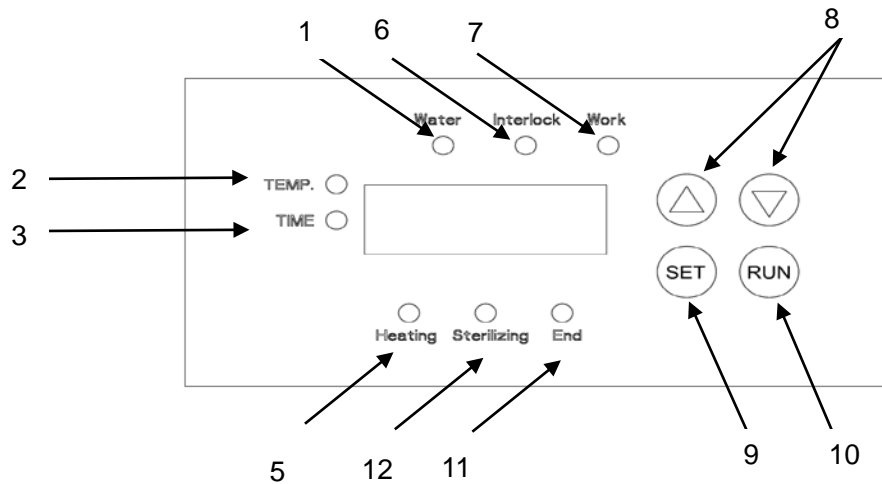

No.	Name	Function
1	Water level lamp	When there is water shortage/cut off in the sterilizer, the lamp normally blinks, with a buzzer alarm sound. When the water is added to the "standard" water level, the water level lamp will be normally ON.
2	Sterilize temp. setting lamp	The indicator lamp is ON when the sterilization temperature is displayed.
3	Sterilize time setting lamp	The indicator lamp is ON when the sterilization time is displayed or entering the countdown.
4	Digital display area	Display the parameters or temperature time.
5	Heating lamp	The indicator lamp is ON when the heater is in the working state, and blinks during the heat preservation process.
6	Interlock lamp	Close the upper cover and rotate until the upper and lower handles are closed, and then the indicator lamp lights up.
7	Working lamp	The indicator lamp is ON when the RUN key is pressed and the product starts to work.
8	Increase/Decrease keys	Press "Up" to increase the parameters to be modified, and press "Down" to decrease the parameters to be modified.
9	Function setting key	Press the "function setting" key once to switch the running state in the display screen to the temperature setting state, press twice to switch to the time state, and then press again to return to the running state. Long press the key for more than 5 secs to open the hidden setting data.
10	RUN key	After setting the required sterilization temperature and time, close the cover, press the RUN key, and the sterilizer starts to heat up and run.
11	END lamp	The indicator lamp is ON (with buzzer sound) at the end of sterilization. *1
12	Sterilizing lamp	The indicator lamp is ON when the sterilizer reaches the set temperature (heat preservation).

*1 Long press the "up" or "down" key for more than 5 secs to check the real-time temperature in the sterilization process.

Apparatus/Liquid Sterilization Course

Follow the procedures below for the setting of apparatus sterilization and liquid sterilization courses.

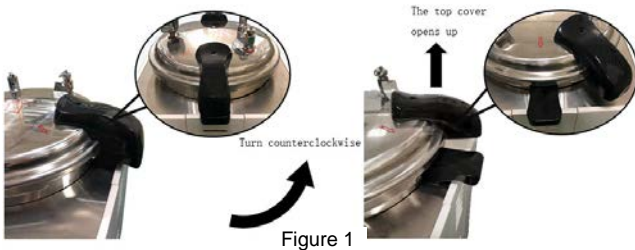

Figure 1



Figure 2

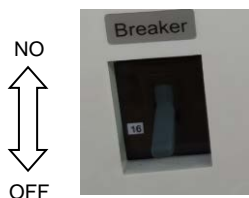

Figure 3

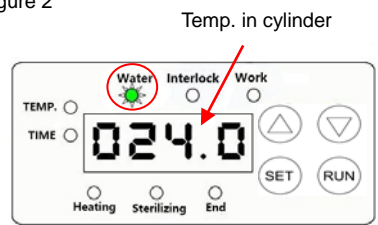

Figure 4

Turn the cover CCW and separate the upper and lower handles completely (Figure 1). Remove the cover and place it on a flat surface (Figure 2). When placing the cover, the pressure gauge should be placed upward to avoid collision and deformation with the case, resulting in the error of the pressure gauge pointer.

Connect to the external power supply of AC 220V±10%, 50Hz±1Hz and power ≥ 2KW, plug into the sterilizer special power socket, turn on the power switch to the ON position (Figure 3), the required setting can be made on the control panel (an electromagnetic switch is set in the handle, and the heater will not work when the cover is not closed or there is water shortage in cylinder). The blinking water level lamp indicates that there is water shortage in the cylinder (Figure 4), and the display screen (Figure 4) indicates the current temperature in the cylinder.

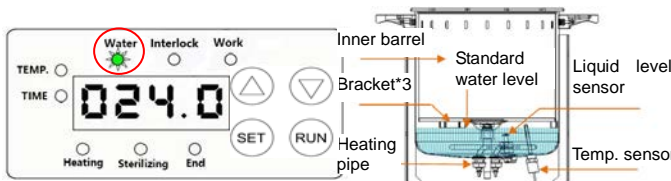

Figure 5

Figure 6



Figure 7



Figure 8

3. Take out the inner barrel, inject the tap water directly into the cylinder and add water until the water level indicator lamp on the control panel is normally ON (Figure 5). If there is too much water in the cylinder, turn on the drain valve (Figure 7) to drain the excess water (the standard water level should reach the lower edge of the three brackets in the cylinder (Figure 6). Turn the drainage knob to the OFF position after the water level is confirmed (Figure 8).

Apparatus/Liquid Sterilization Course

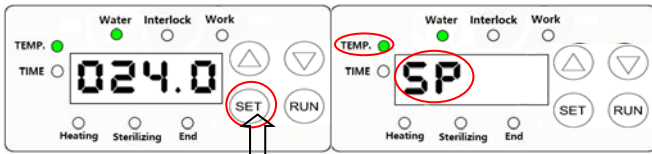

Figure 9

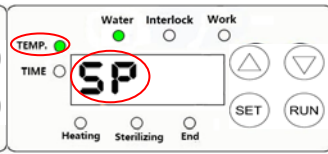

Figure 10



Figure 11



Figure 12

4. The control system in the control platform has the function of data memory, which can store the sterilization temperature and time of the last use for the next continuous use. For the first use, may need to adjust the sterilization temperature and time, it can be adjusted according to the following steps:

① Set the sterilization temperature: press the set key on the control panel (Figure 9), the sterilization temperature indicator lamp on the panel lights up, and SP appears in the display screen (Figure 10). Press the up and down keys (Figure 11) to adjust the required sterilization temperature value. After the adjustment, press the set key twice to store and confirm the new sterilization temperature data (Figure 12).



Figure 13

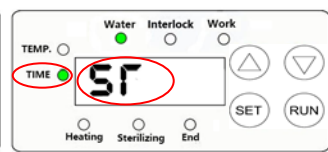

Figure 14

② Set the sterilization time: press the set key on the control panel (Figure 13), the sterilization time indicator lamp on the panel lights up, and ST appears in the display screen (Figure 14).

Press the up and down keys (Figure 15) to adjust the required sterilization time value. After the adjustment, press the set key twice to store and confirm the new sterilization time data (Figure 16).



Figure 15

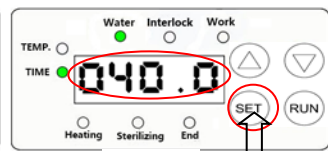

Figure 16

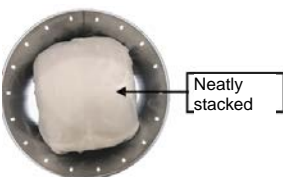

Figure 17-1

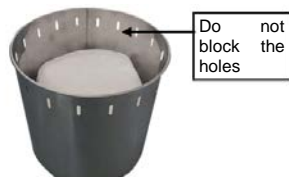

Figure 17-2

The articles need to be sterilized should be properly wrapped and stacked in the inner barrel successively (Figure 17-1). Do not put the easily expanded or unwrapped grain or strip articles into the barrel to sterilize. When stacking the sterilization articles, it is necessary to keep off the vent holes such as of the safety valve and the vent valve (Figure 17-2) to avoid the unsafe accidents caused by blocking the vent holes.

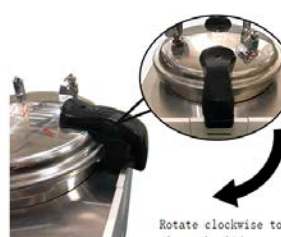

Figure 18

When the sterilization temperature and time are confirmed, close the cover, turn the cover CW until the upper and lower handles are all closed (Figure 18), and the interlock indicator lamp blinks; then press the RUN key on the control panel, the working lamp lights up, and the heater in the sterilizer starts to work.

Apparatus/Liquid Sterilization Course

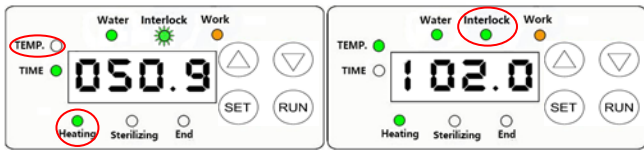

Figure 19



Figure 20

★In order to ensure the sterilization effect, the lower exhaust valve knob should be turned to the micro exhaust state (Figure 21) during the heating, pressure rising and sterilization process to keep a small amount of steam constantly discharged from the cylinder, so that the temperature in the cylinder can become uniform.



Figure 21

When the heater starts to work, both the sterilization temperature lamp and the heating lamp on the control panel light up, indicating that the sterilizer has entered into the operation state of heating, temperature and pressure rising (Figure 19). When the temperature in the cylinder rises to be about 102°C, the interlock indicator lamp will turn to be normally ON (Figure 20).

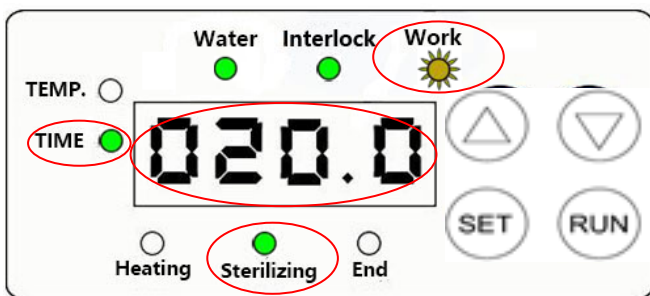

Figure 22

When the temperature of sterilizer rising to the set temperature, the sterilizing lamp and the sterilization time lamp on the control panel light up, the working lamp turns to blink, and the sterilization countdown appears in the display window (Figure 22), indicating that the sterilization articles are being sterilized inside the cylinder of sterilizer.

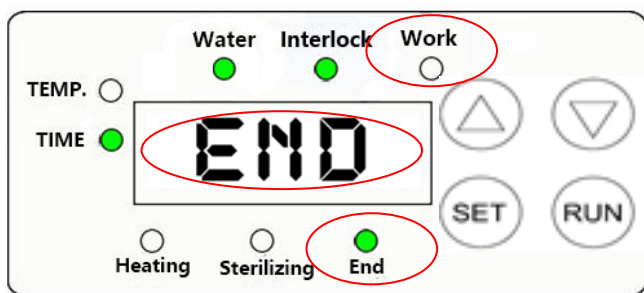

Figure 23

The sterilization countdown is over, the word "END" appears in the display window, the END lamp on the control panel lights up and the working lamp goes out, indicating that the sterilization operation is completed (Figure 23).

Apparatus/Liquid Sterilization Course



Figure 24

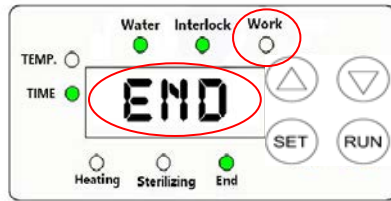

Figure 25

After the sterilization operation, turn the lower exhaust valve knob to the ON position (Figure 24) to discharge the steam in the cylinder for pressure relief. When the temperature in the cylinder is lower than about 102°C, the interlock lamp turns to blink (Figure 25), indicating that the pressure in the cylinder is basically eliminated.

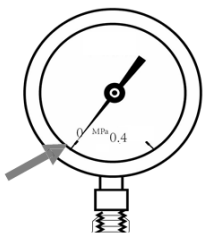

Figure 26



Figure 27

After the pointer of the pressure gauge returns to zero (Figure 26), turn the cover CCW and separate the upper and lower handles completely (Figure 27). At this point, the interlock lamp goes out (Figure 28), indicating that the cover can be removed and the sterilization articles can be taken out. (This figure is for reference only, the pressure gauge is subject to the real object)

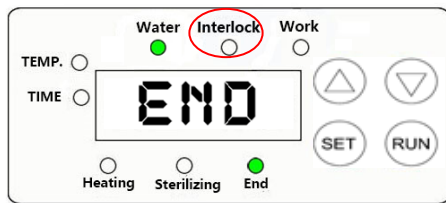

Figure 28

Note: The outside surface of this unit may get hot to the touch contact between unprotected skin and outside surface of this unit during operation may cause burns. Always use protective gear to shield operator from hot surfaces

Sterilizing Parameters

Use calibration offset function

Calibration offset is a function which corrects the difference between the temperature in furnace and that of controller (sensor temperature) if arises. The function parallel corrects the difference either to the plus or minus side within the whole temperature range of unit. The function can be set or cancelled by the **SET** key.

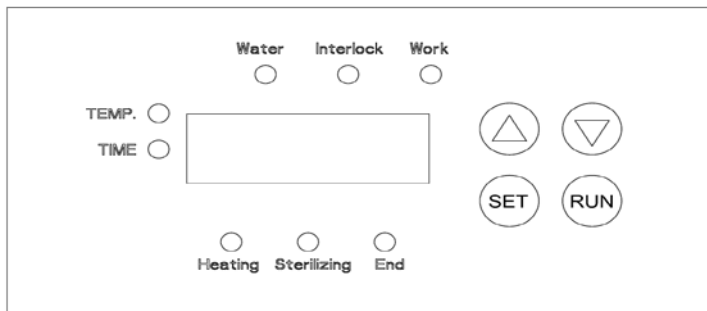
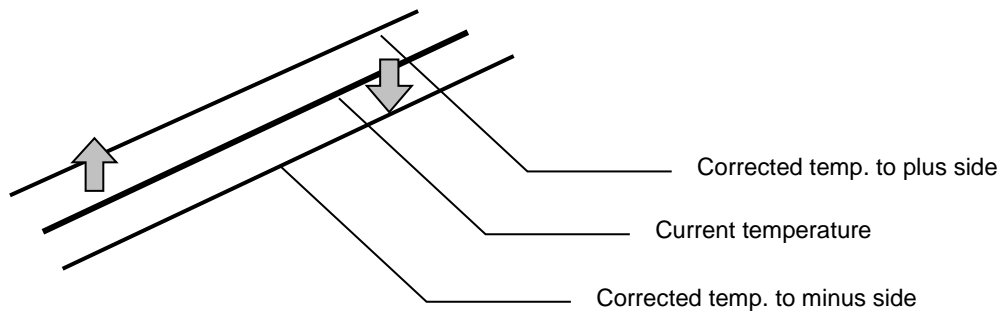

- ① Start operation with the target setting temperature. Check the temperature in furnace (temperature of sample) with a thermograph after it is stabilized.
 - ② Check the difference between the setting temperature and that in furnace (temperature of sample).
 - ③ Press the **SET** key. Select the character "SC", which indicates the calibration offset, using the "▲▼", and then press the **SET** key.
 - ④ Input the difference using the "▲▼" and then press the **SET** key. This completes the setting.
- ❖ The setting range of offset correction temperature is +20°C to plus side and -20°C to minus side respectively.

WARNING



If a problem occurs

-  If smoke or strange odor should come out of this unit for some reason, turn off the power key right away, and then turn off the circuit breaker and the main power. Immediately contact a service technician for inspection. If this procedure is not followed, fire or electrical shock may result. Never perform repair work yourself, since it is dangerous and not recommended.

Measure for flammability and handling of flammable solvent

-  This unit is not designed as the explosion-proof construction. Pay special attention to the handling of the sample to be handled with this unit on the consumption with the explosive material, flammable material, and similar ones. The flammable material may be vaporized by leaving it at the temperature higher than room temperature, and could cause the fire or explosion. When handling such material, provide enough ventilation before the operation. (Refer to page 27 "List of Dangerous Substances".)

Do not modify

-  Do not modify this unit. An accident, malfunction, electric shock or fire may result.

CAUTION

CAUTION!

During a thunder storm

 During a thunderstorm, turn off the power key immediately, then turn off the circuit breaker and the main power. If this procedure is not followed, fire or electrical shock may be caused.

Do not touch the hot section

 The temperature on the cover and top board on the chamber are very hot during operation or just after operation is completed. Do not touch these sections to avoid a burn injury.

When opening the cover...

 Make sure that the pressure gauge reading has decreased to 0(zero) MPa before opening the cover. Open the cover slow carefully. The high-temperature and pressure vapor blows out if the cover is opened during high pressure.

When draining water...

 The water in the chamber is very hot just after the operation is completed. Be careful not to get a burn injury. Drain the water after the water is sufficiently cooled down.
Do not drain water during operation. The hot water blows out if the drain valve is opened while the pressure is increasing.

Do not damage the packing on the cover or flange on the chamber

 Damage or dirt on these areas may cause the vapor leakage, which may be the cause of burn injury. Keep these sections always clean. Do not damage them with the rack when taking out and putting in the sterile samples. The packing degrades with time. It must be replaced if vapor leak occurs frequently. In this case consult with the selling office where you purchased or our sales office.

Replace the packing early

 The packing is a consumable. If it shows the sign of damage or hardening, replace it early. Please consult with the selling office where you purchased or our sales office for the replacement of packing.

Do not perform procedures other than described in this document

 Do not perform procedures other than described in this document. Otherwise an unexpected accident may occur.

Daily Inspection and Maintenance

For the safety use of this unit, please perform the daily inspection and maintenance without fail. Using the city water to this unit might attach dirt. Do inspect and maintain this point while performing daily inspection and maintenance.

WARNING!

- Disconnect the power cable from the power source when doing an inspection or maintenance unless needed.
- Perform the daily inspection and maintenance after the temperature of this unit return to its normal state.
- Do not disassemble this unit.

CAUTION!

- Use a well-drained soft cloth to wipe dirt on this unit. Do not use benzene, thinner or cleanser for wiping. Do not scrub this unit. Deformation, deterioration or discoloration may result.

Cleaning inside the chamber

- Use soft sponge to clean inside the chamber not to damage the surface inside the chamber. Do not remove the filter on the bottom of the chamber when cleaning, if removed, the pipe fitting will get clogged with dirt.
- The heater and sensor are provided on the bottom inside the chamber. Make sure not to bend or damage the filter.

For any questions, contact the dealer who you purchased this unit from, or the nearest sales division in our company.

When not using this unit for long term / When disposing

CAUTION!

When not using this unit for long term...

- Turn off the power and disconnect the power cord.

WARNING!

When disposing...

- Keep out of reach of children.
- Consult with the specialized disposal services when disposing the equipment.

Environmental protection should be considered

We request you to disassemble this unit as possible and recycle the reusable parts considering to the environmental protection. The feature components of this unit and materials used are listed below.

Component Name	Material
Exterior Parts	
Outer covering	Temperature resistant high quality engineering plastics
Chamber, Cover	Stainless steel SUS304
Packing	Silicon rubber
Plates	PET resin film
Electrical Parts	
Switches, Relay	Resin, copper
Circuit boards	Composite of glass fiber and other
Heater	SUS pipe heater
Power cord	Synthetic rubber coated wiring materials, copper and nickel

Safety Device and Error Code

Analysis of Common Failures

Failure	Cause	Solution
1. Not heating after power is on	<ol style="list-style-type: none"> 1. abnormal input power supply 2. heater being damaged 3. incorrect temperature adjustment and time setting 	<ol style="list-style-type: none"> 1. to supply the power according to the nameplate 2. to replace the heater 3. to reset after switching off the machine
2. Steam ejecting from the safety valve after temperature rises.	<ol style="list-style-type: none"> 1. the upper and lower handle failing to reach proper positions 2. the safety lock pin being jammed 	<ol style="list-style-type: none"> 1. to keep the upper and lower handles contacting properly 2. to move the safety pin
3. Safety valve failing to work after exceeding the parameters	<ol style="list-style-type: none"> 1. the safety valve being blocked 2. the safety valve unable to work properly 	<ol style="list-style-type: none"> 1. to unclog the safety valve 2. to replace the safety valve with qualified one
4. The pressure gauge failing to return to zero under non-pressure condition	<ol style="list-style-type: none"> 1. the pressure gauge unable to work properly 	<ol style="list-style-type: none"> 1. to replace the pressure gauge with qualified one
5. Steam leaking from between the lid and the pot after pressure rises	<ol style="list-style-type: none"> 1. the seal being not properly placed 2. the seal being damaged 	<ol style="list-style-type: none"> 1. to move the seal to a proper position 2. to replace the seal with a qualified one
6. The temperature just rise to 100°C	<ol style="list-style-type: none"> 1. The vent is stuck. 	<ol style="list-style-type: none"> 1. to clean the vent and make it smooth 2. If the first solution does not work, please replace the vent with a qualified one

In the case of the error other than listed above occurred, turn off the power switch and primary power source immediately. Contact the shop of your purchase or nearest Yamato Scientific Service Office.

In Case of Request for Repair

If the failure occurs, stop the operation, turn OFF the power switch, and unplug the power plug. Please contact the sales agency that this unit was purchased, or the Yamato Scientific's sales office.

< Check following items before contact >

- ◆ Model Name of Product
 - ◆ Production Number
 - ◆ Purchase Date
 - ◆ About Trouble (in detail as possible)
- } See the production plate attached to this unit.

Minimum Retention Period of Performance Parts for Repair

The minimum retention period of performance parts for repair of this unit is 7 years after discontinuance of this unit.

The "performance part for repair" is the part that is required to maintain this unit.

Product name		Sterilizer					
Model		SK102C	SK112C	SK201C	SK211C	SK301C	SK311C
Performance	Temperature control range	50 to 126°C (sterilization)					
	Maximum Operational Pressure	0.142Mpa					
	Operational ambient temperature	5°C~35°C					
Chamber part	Heater	115V /2000W	220V /2000W	115V /2000W	220V /2000W	115V /2000W	220V /2000W
	Drain valve	Globe valve					
	liquid level sensor	Float Switch					
Configurations	Temperature control system	PID control by microcomputer					
	Setting/display method	Digital setting by UP/DOWN key / Digital display					
	Timer	Range: 0 to 999min					
	Operation functions	Fixed temperature operation procedure					
Safety devices		Water level detection (liquid expansion method), safety valve (0.165MPa), safety interlocking interactive device, spring full lift safety valve					
Pressure vessel standard		Small-sized pressure vessel (notification of installation is not required)					
Standard	Effective dimensions of chamber (Diameter × Depth mm)	Φ280×H292		Φ280×H390		Φ280×H487	
	External dimensions* (Diameter × H mm)	W380×D380×H629mm		W400×D410×H815mm		W400×D410×H815mm	
	Effective capacity of chamber	18L		24L		30L	
	Weight	16Kg		26.5Kg		31.5Kg	
	Power supply (50/60Hz)	AC 115V /17A	AC 220V~230/ 9.5~10A	AC 115V /17A	AC 220V~230/ 9.5~10A	AC 115V /17A	AC 220V~230/ 9.5~10A
Accessories		Rack × 1		Rack × 1		Rack × 1	

*: The external dimension does not include the dimension of projection areas.

SK102C/201/301C

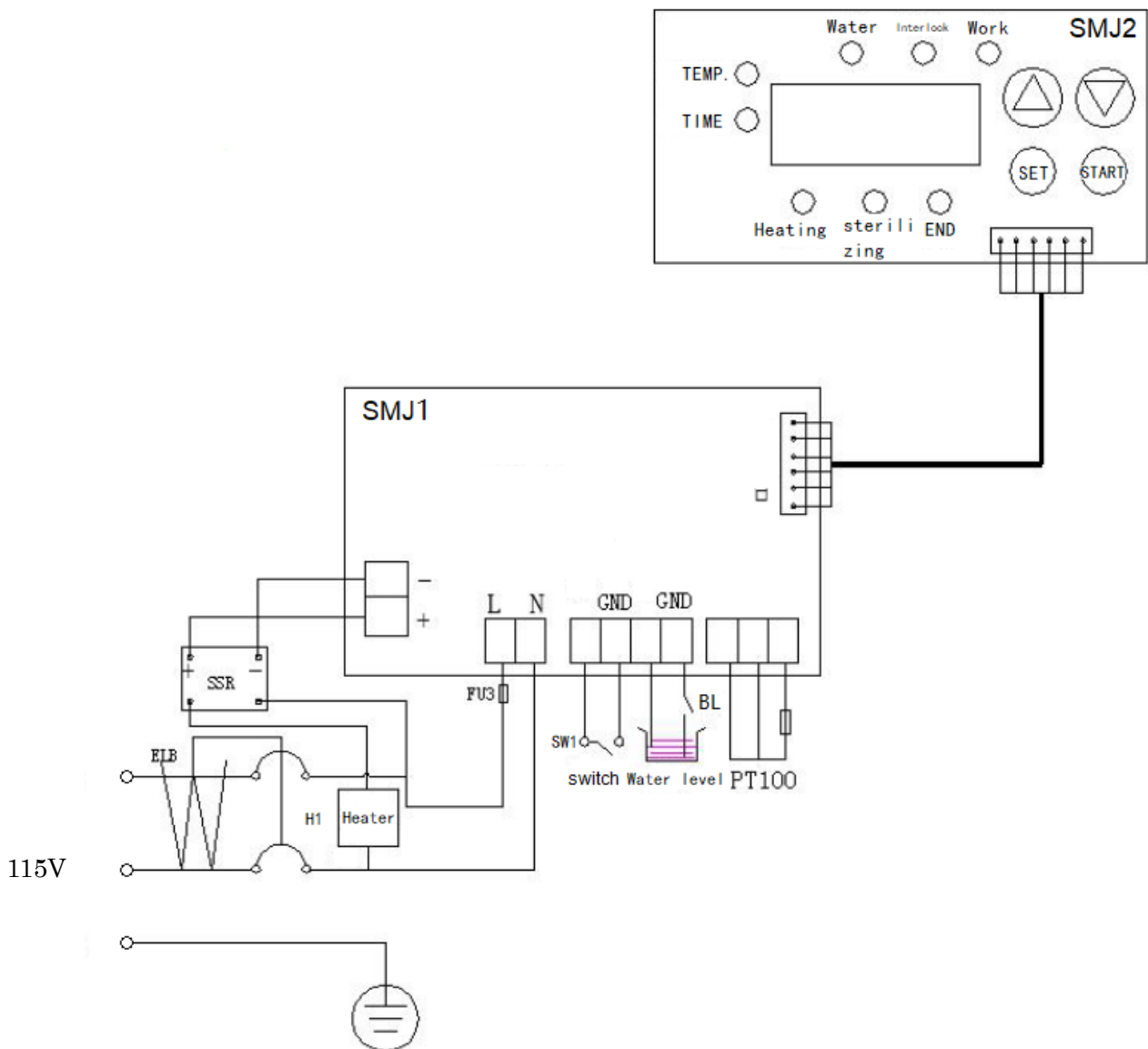

Symbol	Part name	Symbol	Part name
ELB	Power switch	SMJ1	Control board
FU3	Safety tube	SMJ2	Display board
H1	Heater	Pt100	Temperature sensor
BL	Float Switch	SW1	Cover interlock switch

SK112C/211/311C

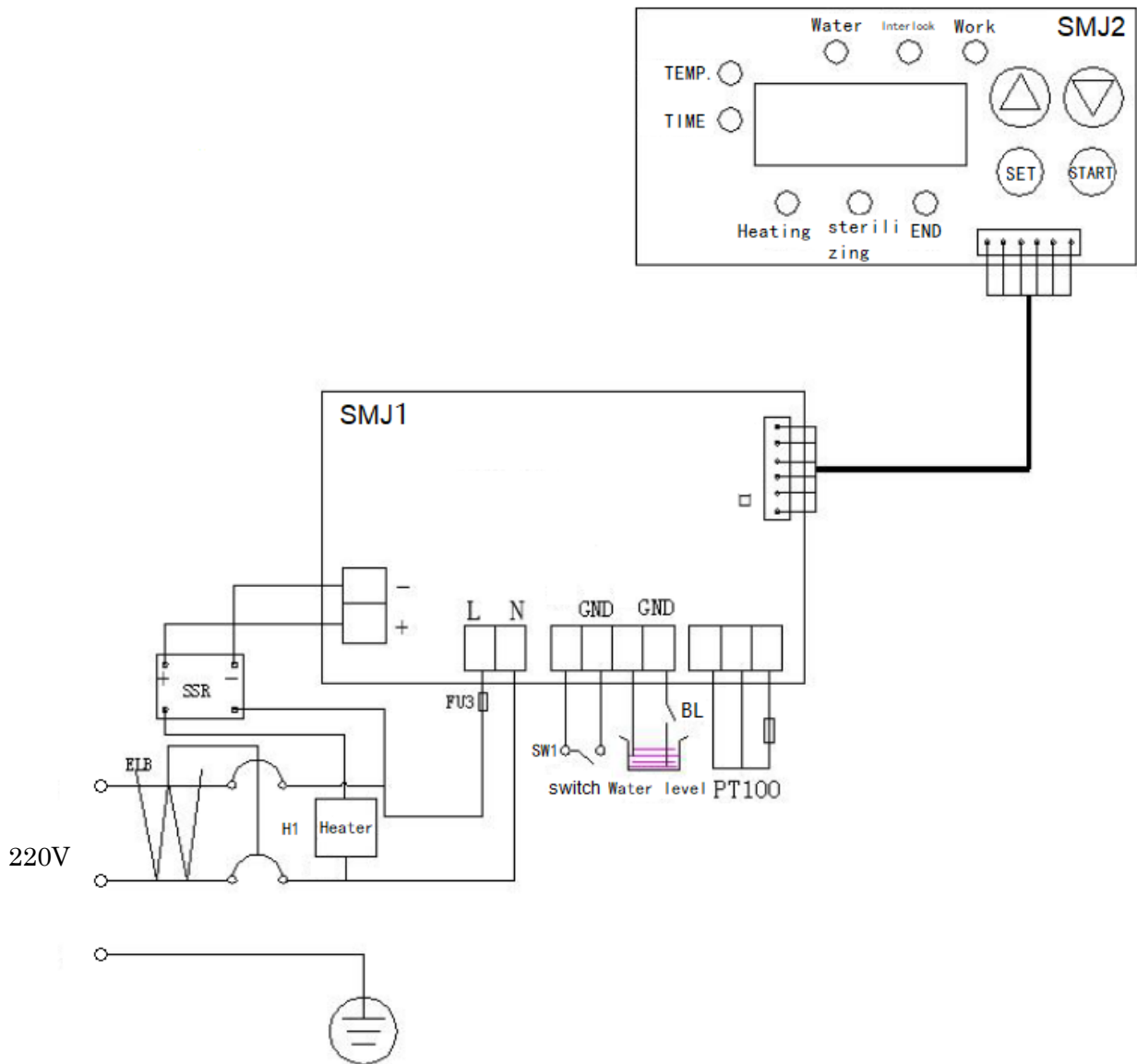

Symbol	Part name	Symbol	Part name
ELB	Power switch	SMJ1	Control board
FU3	Safety tube	SMJ2	Display board
H1	Heater	Pt100	Temperature sensor
BL	Float Switch	SW1	Cover interlock switch

Replacement Parts Table

Common parts

Symbol	Part Name	Code No.	Specification	Manufacturer
SMJ2	Display board	A020105002	SMJ2	YSJ
	Cable	A011307001		YSJ
Pt	Temperature sensor	A010502011	Pt100Ω	YSJ
BL	Float Switch	A011507001		YSJ
SW1	Cover interlock switch	A990101266		YSJ
	Lid Packing	A081902032		YSJ
	Pressure Gauge	A042300019		YSJ
	Safety valve	A990100469		YSJ
	Steam exhaust valve	A990100255		YSJ
	Caster	A080300019	8808049 ϕ 50 White	YSJ
	Caster (With brake)	A080300019	8808062 ϕ 50 White	
TM	Terminal block	A011302002	T3052-6-4P-CLO	YSJ

SK102C/201/301C

Symbol	Part Name	Code No.	Specification	Manufacturer
SMJ1	CONT board	A020105005	SMJ1 110V	YSJ
H1	Heater	A080501015	2000W/115V	YSJ
	Power Cable	A011208003	3*2.08 With plug	YSJ
ELB	Power switch	A010410001	BV-DN 1P+N 20A 30mA	YSJ

SK112C/211/311C

Symbol	Part Name	Code No.	Specification	Manufacturer
SMJ1	CONT board	A020105004	SMJ1 220V	YSJ
H1	Heater	A080501016	2000W/220V	YSJ
	Power Cable	A011210002	3*2.08 Not plug	YSJ
ELB	Power switch	A010410007	BV-DN IP+N 10A 30mA	YSJ

List of Dangerous Substances



Never use explosive substances, flammable substances and substances that include explosive or flammable ingredients in this unit.

EXPLOSIVE

EXPLOSIVE:	Ethylene glycol dinitrate (nitro glycol), Glycerin trinitrate (nitroglycerine), Cellulose nitrate (nitrocellulose), and other explosive nitrate esters
	Trinitrobenzene, Trinitrotoluene, Trinitrophenol (picric acid), and other explosive nitro compounds
	Acetyl hydroperoxide (peracetic acid), Methyl ethyl ketone peroxide, Benzyl peroxide, and other organic peroxides

FLAMMABLE

IGNITING:	Lithium (metal), Potassium (metal), Sodium (metal), Yellow phosphorus, Phosphorus sulfide, Red phosphorus, Celluloid compounds, Calcium carbide, Lime phosphate, Magnesium (powder), Aluminum (powder), Powder of metals other than magnesium and aluminum, Sodium hydrosulfite
OXIDIZING:	Potassium chlorate, Sodium chlorate, Ammonium chlorate, and other chlorate
	Potassium perchlorate, Sodium perchlorate, Ammonium perchlorate, and other perchlorate
	Potassium peroxide, Sodium peroxide, Barium peroxide, and other inorganic peroxide
	Potassium nitrate, Sodium nitrate, Ammonium nitrate, and other nitrate
	Sodium chlorite and other chlorites
	Calcium hypochlorite and other hypochlorites
INFLAMMABLE LIQUID:	Ethyl ether, Gasoline, Acetaldehyde, Propylene chloride, Carbon disulfide, and other flammable substances having a flash point of lower than -30°C
	Normal hexane, ethylene oxide, acetone, benzene, methyl ethyl ketone, and other flammable substances having a flash point of -30°C or higher but lower than 0°C
	Methanol, Ethanol, Xylene, Pentyl acetate (amyl acetate), and other flammable substances having a flash point of 0°C or higher but lower than 30°C
	Kerosene, Light oil (gas oil), Oil of turpentine, Isopentyl alcohol (isoamyl alcohol), Acetic acid, and other flammable substances having a flash point of 30°C or higher but lower than 65°C
FLAMMABLE GAS:	Hydrogen, Acetylene, Ethylene, Methane, Propane, Butane, and other flammable substances which assume a gaseous state at 15°C and 1 atm

(Source: Appendix Table 1 of Article 6 of the Industrial Safety and Health Order in Japan)

Responsibility

Please follow the instructions in this document when using this unit. Yamato Scientific has no responsibility for the accidents or breakdown of device if it is used with a failure to comply. Never conduct what this document forbids. Unexpected accidents or breakdown may result in.

Note

- ◆ The contents of this document may be changed in future without notice.
- ◆ Any books with missing pages or disorderly binding may be replaced.

Sales: Yamato Scientific America, Inc.
925 Walsh Ave, Santa Clara, CA 95050

Yamato Scientific Co.,Ltd
Harumi Triton Square Y-36F, 1-8-11 Harumi,
Chuo-ku, Tokyo 104-6136, Japan

Manufacturer: Yamato Scientific Chongqing CO., LTD
N0.5-37, Yunhan Avenue, Shuitu High-Tech Development Zone,
Beibei District, Chongqing, China

Instruction Manual for

Sterilizer

Model SK102C/112C/201C/211C/301C/311C

First Edition April 12, 2021

Revision