



Constant Temperature Water Bath

Models

BA300/400/500/610/710

Instruction Manual

- Fourth Edition -

- Thank you for choosing BA Series Constant Temperature Water Baths from Yamato Scientific Co., Ltd.
- For proper equipment operation, please read this instruction manual thoroughly before use. Always keep equipment documentation safe and close at hand for convenient future reference.



WARNING:

Read instruction manual warnings and cautions carefully and completely before proceeding.

**Yamato Scientific America Inc.
Santa Clara, CA**

Contents

◆	1. SAFETY PRECAUTIONS	1
	• Explanation of Safety Symbols	1
	• Symbol Glossary	2
	• Warnings & Cautions	3
◆	2. PRE-OPERATION PROCEDURES	4
	• Installation Precautions & Preparations	4
◆	3. COMPONENT NAMES AND FUNCTIONS.....	7
	• Main Unit Overview.....	7
	• Control Panel.....	8
	• Display Characters	9
◆	4. OPERATION PROCEDURES	10
	• Operation Modes	10
	• Operation Functions	11
	• Mode & Function Flow	12
	• Overheat Prevention Device Setup.....	13
	• Constant (fixed) Temperature Mode.....	14
	• Constant Temperature + Quick Auto Stop Mode	15
	• Auto Stop Mode.....	16
	• Auto Start Mode.....	18
	• Programmed Operation	20
	• Building Programs	23
	• Program Planning Worksheet.....	27
	• Calibration Offset Function	29
	• Keypad Lock Function	30
◆	5. HANDLING PRECAUTIONS	31
◆	6. MAINTENANCE PROCEDURES.....	33
◆	7. STORAGE AND DISPOSAL.....	34
◆	8. ERROR CODES	35
◆	9. TROUBLESHOOTING.....	36
◆	10. SERVICE AND REPAIR.....	37
◆	11. SPECIFICATIONS	38
◆	12. WIRING DIAGRAMS	39
◆	13. REPLACEMENT PARTS LIST	40
◆	14. LIST OF HAZARDOUS SUBSTANCES	41

1. SAFETY PRECAUTIONS

Explanation of Safety Symbols

A Word Regarding Symbols

Various symbols are provided throughout this text and on equipment to ensure safe operation. Failure to comprehend the operational hazards and risks associated with these symbols may lead to adverse results as explained below. Become thoroughly familiar with all symbols and their meanings by carefully reading the following text regarding symbols before proceeding.

 **Warning** Signifies a situation which may result in serious injury or death (Note 1)

 **Caution** Signifies a situation which may result in minor injury (Note 2) and/or property damage (Note 3)

(Note 1) Serious injury is defined as bodily wounds, electrocution, bone breaks/fractures or poisoning, which may cause debilitation requiring extended hospitalization and/or outpatient treatment.

(Note 2) Minor injury is defined as bodily wounds or electrocution, which will not require extended hospitalization or outpatient treatment.

(Note 3) Property damage is defined as damage to facilities, equipment, buildings or other property. (Note 1) Serious injury is defined as bodily wounds,

Symbol Meanings

 Signifies warning or caution.
Specific explanation will follow symbol.

 Signifies restriction.
Specific restrictions will follow symbol.

 Signifies an action or actions which operator must undertake.
Specific instructions will follow symbol.

1. SAFETY PRECAUTIONS

Symbol Glossary

Warning



General Warning



Danger!: High Voltage



Danger!: Extremely Hot



Danger!: Moving Parts



Danger!: Blast Hazard

Caution



General Caution



Caution: Electrical Shock Hazard!



Caution: Burn Hazard!



Caution: Do Not Heat Without Water!



Caution: May Leak Water!



Caution: Water Only



Caution: Toxic Chemicals

Restriction



General Restriction



No Open Flame



Do Not Disassemble



Do Not Touch

Action



General Action Required



Connect Ground Wire



Level Installation Required



Disconnect Power



Inspect Regularly

1. SAFETY PRECAUTIONS

Warnings & Cautions

WARNING!

 **Never operate equipment near combustible gases/fumes.**

Do not install or operate BA series units near flammable or explosive gases/fumes. Unit is NOT fire or blast resistant. Negligent use could cause a fire/explosion. See "List of Hazardous Substances" (P.41).

 **Always ground equipment.**

Always ground this unit properly to avoid electric shock.

 **DO NOT operate equipment when abnormalities are detected.**

If smoke or unusual odors begin emitting from unit, or if any other abnormalities are detected, terminate operation immediately, turn off main power switch and disconnect power cable. Continued operation under such conditions may result in fire or electric shock.

 **DO NOT operate equipment with bundled or tangled power cable.**

Operating unit with the power cable bundled or otherwise tangled may cause power cable to overheat and/or catch fire.

 **DO NOT damage power cable.**

Damaging the power cable by forcibly bending, pulling or twisting may cause fire or electric shock to the operator.

 **DO NOT process explosive or flammable substances.**

Never place or process explosive/flammable substances, nor substances that contain explosive/flammable substances in this unit. An explosion or fire may occur. See "List of Hazardous Substances" (P.41).

 **DO NOT disassemble or modify equipment.**

Attempting to dismantle or modify unit in any way, may cause malfunction, fire or electric shock.

 **Avoid touching hot surface areas.**

Bath interior and some exterior surfaces become hot during operation and may remain hot following operation. Avoid contacting these areas with bare fingers and hands. Burns or other injury may result.

CAUTION!

 **DO NOT operate equipment during thunderstorm.**

In the event of a thunderstorm, terminate operation and turn off main power switch immediately. A direct lightning strike may cause damage to equipment, or result in fire or electric shock.

2. PRE-OPERATION PROCEDURES

Installation Precautions & Preparations



1. Ground wire **MUST** be connected properly.



- Ground wire must be connected to a proper grounding line or terminal in order to prevent electric shock.



- Never connect ground wire to gas lines or water pipes.
- Never connect ground wire to telephone grounding lines or to lightning conductor rods. Fire or electrical shock may result.
- Never insert multiple plugs into a single outlet. Doing so may result in power cable overheating, fire or drop in voltage
- Always use a 220V dedicated power supply/outlet for the single-phase 220V All models.

2. Install in a location free of flammables and explosives.



- Never install near flammables or explosives. This unit is NOT fire or blast resistant. Simply switching the main power switch "ON" or "OFF" can produce a spark, which could be relayed during operation, causing a fire or explosion when near flammable or explosive fluids, chemicals or gases/fumes. See "List of Hazardous Substances" (P.41).

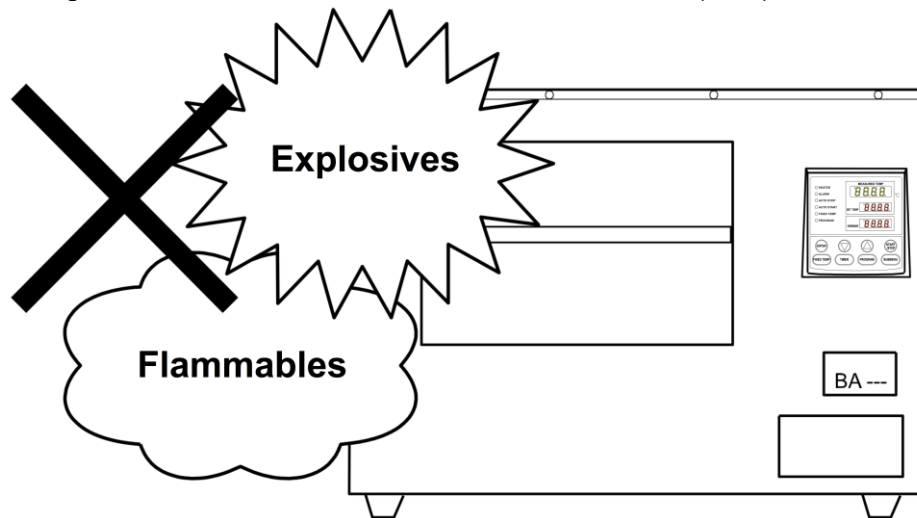

2. PRE-OPERATION PROCEDURES

Installation Precautions & Preparations

3. Choose an appropriate installation site.



- DO NOT install unit:
 - ◆ where flammable or corrosive gases/fumes will be generated.
 - ◆ where ambient temperature will exceed 35°C, will fall below 5°C or will fluctuate.
 - ◆ in excessively humid or dusty locations.
 - ◆ where there is constant vibration.
 - ◆ where power supply is erratic.
 - ◆ in direct sunlight or outdoors.
 - ◆ where there is no exhaust/ventilation hood.



- Install BA series unit in a location with sufficient space, as specified as below.

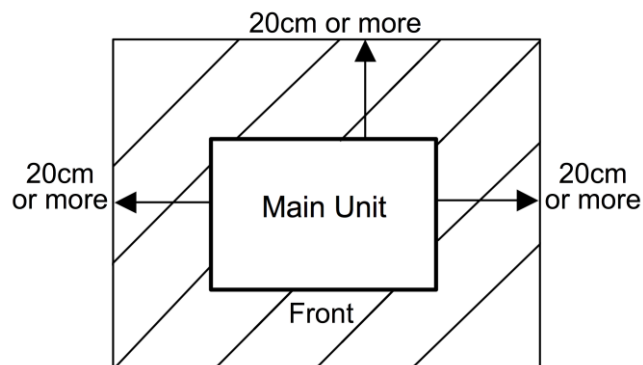

4. DO NOT disassemble or modify.



- Never attempt to disassemble or modify BA units. Doing so may cause equipment malfunction, fire or electric shock.

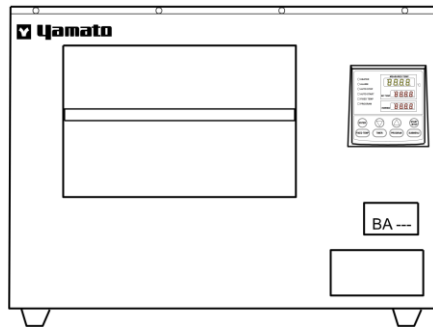

5. Place on a flat surface.



- Install unit on a flat and level surface. Failure to do so may cause abnormal vibrations or noise, resulting in possible complications and/or malfunction. Level off unit, if needed, using adjustable feet.

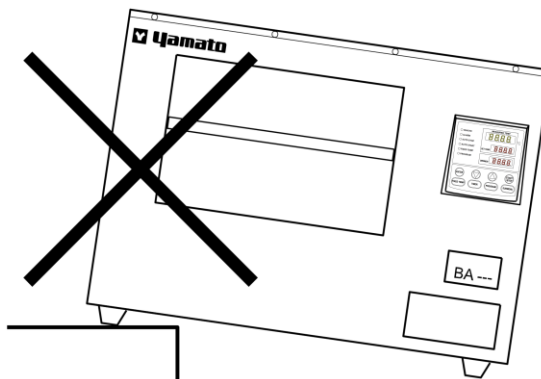

2. PRE-OPERATION PROCEDURES

Installation Precautions & Preparations



6. Connect to an appropriate power source.



- Use a dedicated power supply that matches electrical capacity of unit.

Power capacity:	BA300: AC220 V (Single phase), 6.5A
	BA400: AC220 V (Single phase), 10.5A
	BA500: AC220 V (Single phase), 11.5A
	BA610: AC220 V (Single phase), 16A
	BA710: AC220 V (Single phase), 20.5A

NOTE)

In the unlikely event that unit does not run after turning power ON, inspect whether power supply voltage of the main power is lower than specified, or whether other device(s) are sharing the same supply or line. Change to a dedicated power supply if unit will not run due to low voltage or shared power supply line.

7. Install equipment out of harm's way.



- Unit may fall or shift in an earthquake or other unforeseen incident, resulting in personal injury. Taking appropriate safety measures and installing unit out of harm's way is strongly recommended.

8. Handle power cable with care.



- Never operate unit with power cable bundled or tangled; and do not modify, bend, forcibly twist or pull on power cable. Doing so may cause fire and/or electrical shock.
- Do not risk damage to power cable by positioning it under desks or chairs, or by pinching it between objects. Doing so may cause fire and/or electrical shock.
- Do not place power cable near kerosene/electric heaters or other heat-generating devices. Doing so may cause power cable insulation to overheat, melt and/or catch fire, which may result in electric shock.
- Turn off power switch immediately and disconnect from facility terminal or outlet, if power cable becomes partially severed or damaged in any way. Failure to do so may result in fire or electric shock.



- Contact a local dealer or Yamato sales office for information about replacing power cable if it is damaged.
- Always connect power cable to appropriate facility outlet or terminal.

3. COMPONENT NAMES AND FUNCTIONS

Main Unit Overview

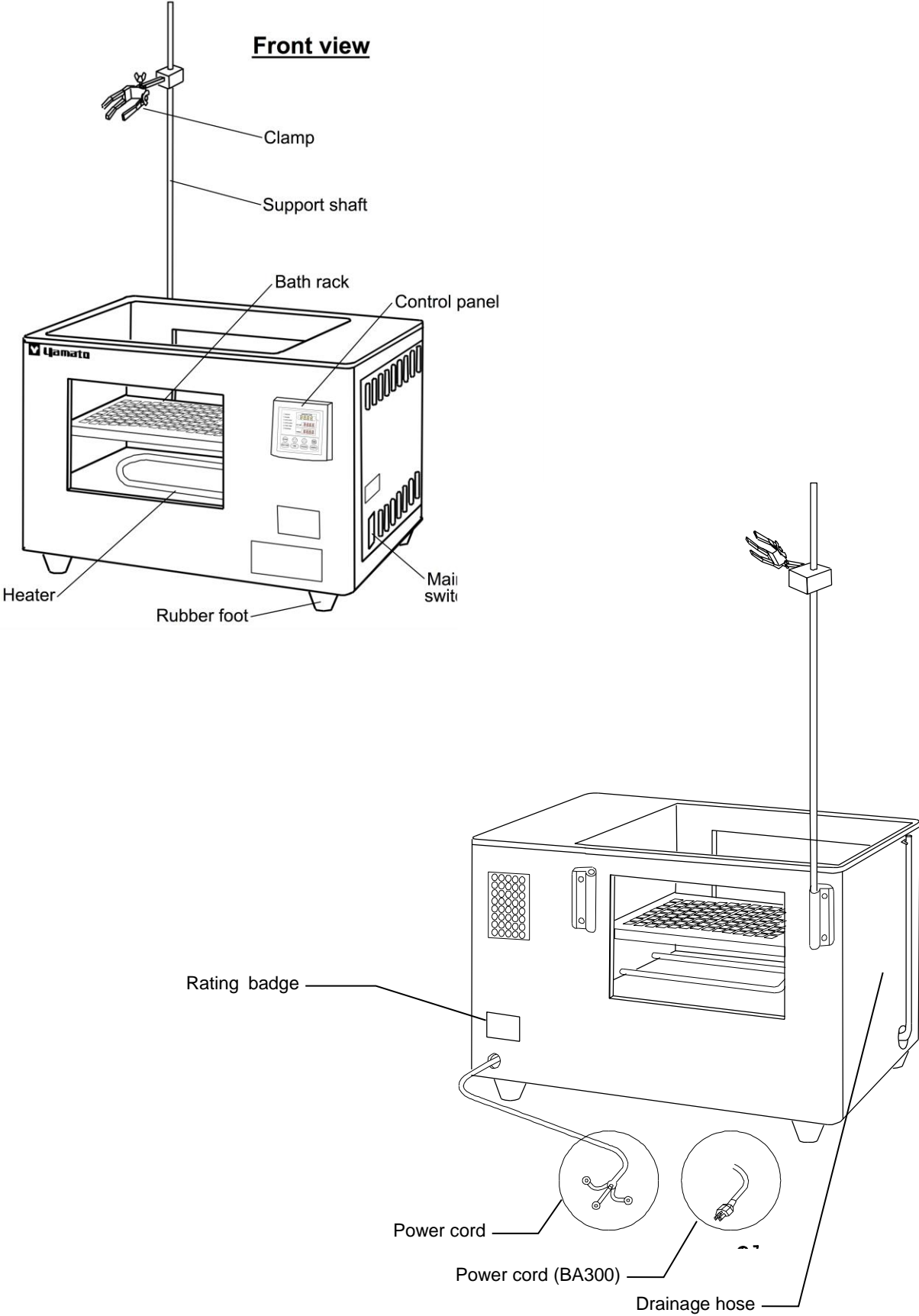

3. COMPONENT NAMES AND FUNCTIONS



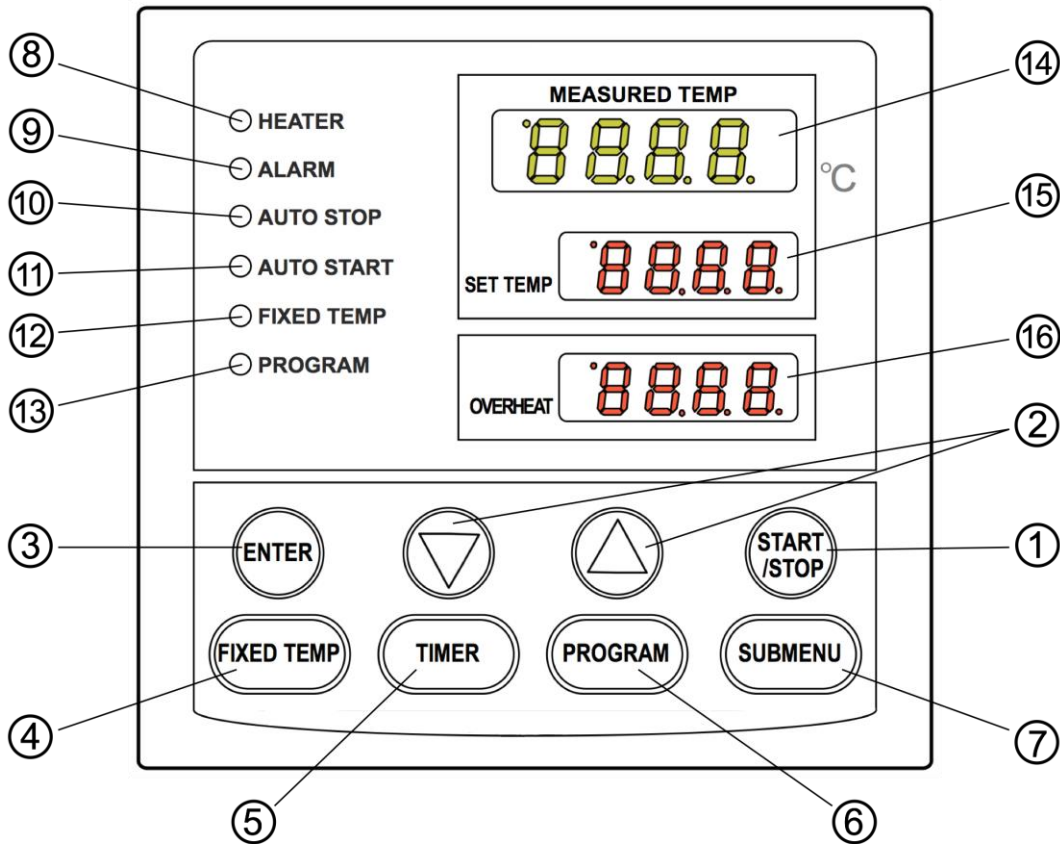









Control Panel

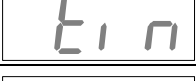

No.	Panel Item	Description
1	START/STOP Key	Press to start or stop an operation.
2	Up/Down Arrow Keys	Press repeatedly to increase or decrease setting value incrementally. Press and hold to increase or decrease setting value perpetually.
3	ENTER Key	Press to finalize setting.
4	FIXED TEMP Key	Press to select FIXED TEMPERATURE mode.
5	TIMER Key	Press to select timed operation. Quick Auto Stop, Auto Stop or Auto Start modes may be selected.
6	PROGRAM Key	Press to select programmed operation.
7	SUBMENU Key	Press to enter overheat prevention temp setting, calibration offset, keypad lock, and program repeat menus.
8	HEATER Indicator Lamp	Illuminates when heater is on and drawing power.
9	ALARM Indicator Lamp	Illuminates when an error occurs (accompanying alarm tone sounds).
10	AUTO STOP Indicator Lamp	Illuminates while Auto Stop operation is in progress. Flashes while setting Quick Auto Stop or Auto Stop modes.
11	AUTO START Indicator Lamp	Illuminates while Auto Start operation is in progress. Flashes while setting.
12	FIXED TEMP Indicator Lamp	Illuminates while Fixed Temperature operation is in progress. Flashes while setting.
13	PROGRAM Indicator Lamp	Illuminates while Programmed operation is in progress. Flashes while setting.
14	Main Display	Shows current chamber temperature, setting characters and error information.
15	Sub Display	Shows temperature setting and remaining time.
16	Overheat Prevention Display	Shows overheat prevention temperature limit setting.

3. COMPONENT NAMES AND FUNCTIONS

Display Characters

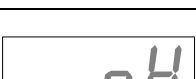
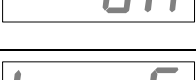
Character	Identifier	Description	Purpose
	Fix	Signifies constant temperature setting mode	Appears while entering settings for constant temperature operation.
	Sv	Signifies temperature setting mode	Appears while entering temperature settings.
	AStP	Signifies auto stop and quick auto stop setting mode	Appears while entering settings for quick auto stop or auto stop mode.
	AStr	Signifies auto start setting mode	Appears while entering settings for auto start mode.
	tim	Signifies timer setting mode	Appears while entering timer settings.
	PrG3	Signifies which program is being set	Appears when selecting which program to use (1, 2 or 3) See "Programmed Operation" (P.20)
	PAt	Signifies program pattern	Appears when selecting a program pattern. See "Programmed Operation" (P.20)
	End	Signifies end of a timed operation	Appears when a timed operation is completed. See pgs. 15~17
	Sv-1	Signifies which step temperature is being set	Appears while setting temperature for each step in a program. (Sv-1 to Sv-30)
	t-1	Signifies which step timer is being set	Appears while setting timer for each step in a program. (t-1 to t-30)
	PS-3	Signifies what step is to be repeated	Appears when selecting step numbers to be repeated in a program. See "Pattern Repeat Function" (P.26)
	Pc-2	Signifies number of times to repeat	Appears when setting the number of times to repeat steps in a program. See "Pattern Repeat Function" (P.26)
	cAL	Signifies calibration offset setting mode	Appears while entering offset temperature values. See "Calibration Offset Function" (P.29)
	oH	Signifies overheat prevention setting mode	Appears while setting activation temperature for overheat prevention device. See "Overheat Prevention Device Setup" (P.13)
	Lock	Signifies that keypad is locked	Appears while control panel keypad is locked. See "Keypad Lock Function" (P.30)

4. OPERATION PROCEDURES

Operation Modes

Operation modes for this unit are defined in the table below:

No.	Name	Description	Page
1.	Constant Temperature Mode (Continuous Operation)	Pressing the FIXED TEMP key brings up constant temperature setup mode. The "▲▼" keys are used to set temperature. Pressing the RUN/STOP key initiates or terminates operation.	14
2.	Quick Auto Stop Mode	This mode is used to automatically terminate an operation when a specified time period has passed (decided during operation). This is done by pressing the TIMER key at any time during constant temperature operation. The "▲▼" keys are used to set the timer. Pressing the RUN/STOP key begins operation in quick auto stop mode, activates the timer (once temp setting is reached) and automatically terminates operation when timer reaches 0:00.	16
3.	Auto Stop Mode	This mode is used to automatically terminate an operation when a specified time period has passed (decided before operation). Pressing the TIMER key displays "AStp". The temperature (Sv) is set by pressing the ENTER key. The operation time (tim) is set by pressing ENTER again. Pressing the RUN/STOP key begins operation in auto stop mode. Operation automatically terminates when timer reaches 0:00.	16
4.	Auto Start Mode	This operation is used to automatically begin an operation after a specified period has passed. Pressing the TIMER key displays "AStr". The temperature (SV) is set by pressing the ENTER key. The operation time (tim) is set by pressing ENTER again. Pressing the RUN/STOP key begins operation in auto start mode.	18
5.	Programmed Operation	This operation is used to run a combination of modes, times and temperatures as one operation. Pressing the PROGRAM key displays "PrG1". Press it again to select program mode. Press the ENTER key to select the pattern (Pat). Press the ENTER key to display "End". Enter the number of patterns to be used. Enter step temperatures and step times for "Sv_x" and "t_x" respectively (where "x" stands for a number or value).	20

NOTE) It is not possible to change modes during operation. If a mode change is required, operation must be terminated and a new mode of operation must be set.

4. OPERATION PROCEDURES

Operation Functions

Operation functions for this unit are defined in the table below:

No	Name		Description	Page
1	Overheat prevention	Auto overheat prevention	This function is set to automatically activate (auto reset) when chamber temperature exceeds the temperature setting by 6°C.	13
		Overheat prevention device	Although this device uses the same power source, display, and keypad as the control panel, it has an independent temperature monitoring circuit, CPU, sensor and output circuit. An overheat prevention temperature can be manually specified using the control panel. Unit operation is terminated when device is activated. Operation may be restarted when the main power (ELB) is switched off (wait 5 seconds), then back on again (manual reset).	
2	Calibration offset		Calibration offset function is to compensate for differences in the temperature reading (as taken by unit sensor) and actual chamber temperature (as taken manually with a thermograph). Unit can be offset to either the positive or negative side of temperature line for entire temperature range of unit	29
3	Overheat prevention temperature calibration function		The temperature specified for the overheat prevention device is automatically recalibrated when temperature reading is corrected with the calibration offset function.	—
4	Power failure recovery		Unit can begin operation again with the same settings (in memory) as before the power failure occurred. Simply press the START/STOP key to begin the operation over from the beginning.	—
5	Keypad lock		This function locks all keys (except SUBMENU and START/STOP) during operation. Lock function is set or cancelled using the SUBMENU key.	30

4. OPERATION PROCEDURES

Mode & Function Flow

The following chart illustrates mode and function flow for BA series units.

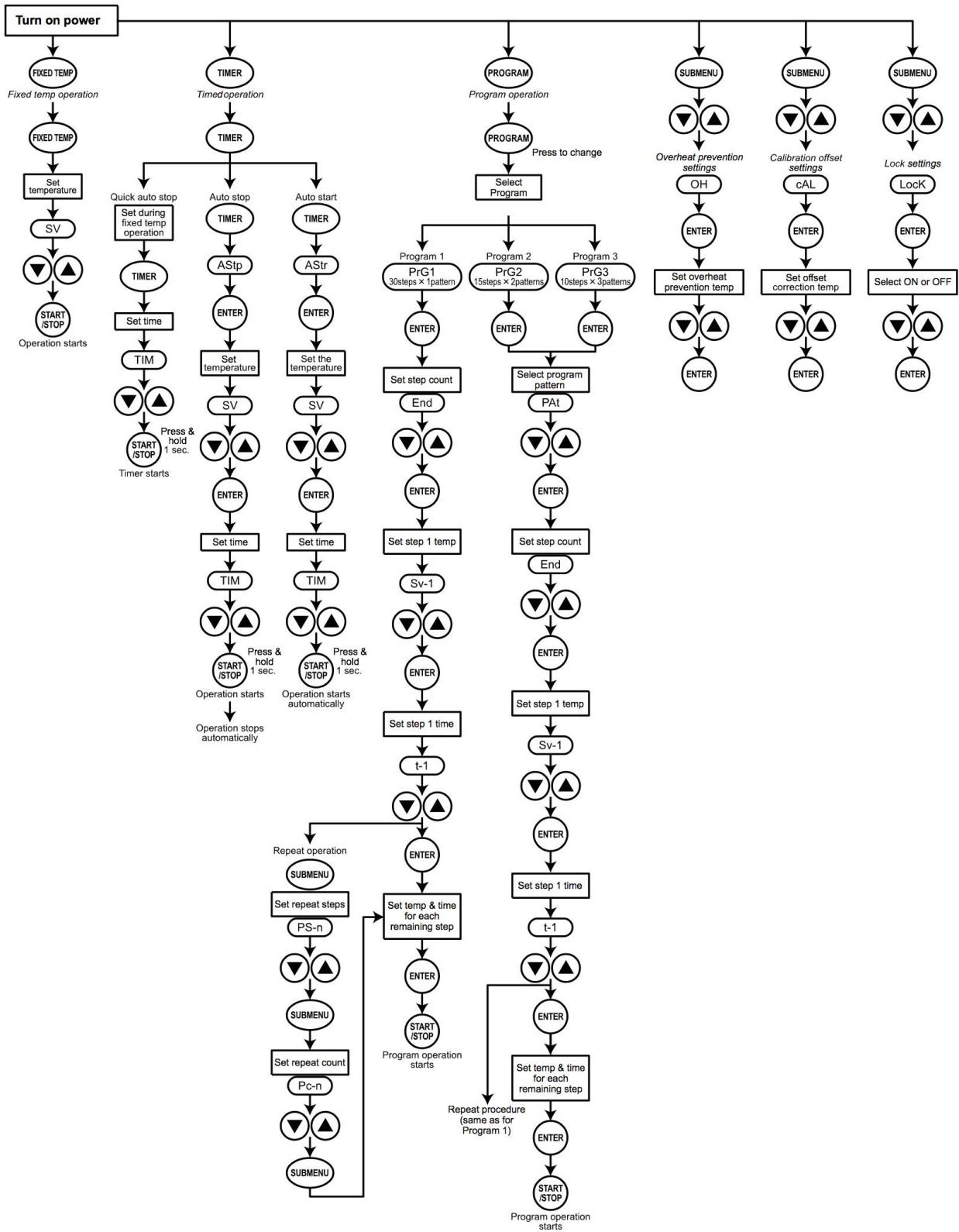

4. OPERATION PROCEDURES

Overheat Prevention Device Setup

This unit features an overheat prevention device (manual reset) which, has an independent temperature monitoring circuit, CPU, sensor and output circuit, but uses the same power source, display, and keys as the control panel. This is in addition to the internal automatic overheat prevention function (auto reset), built in for added measure against overheating.

The automatic overheat prevention function (auto reset) is integrated internally into the unit and is set to automatically activate (cutting off power to heater) when chamber temperature exceeds temperature setting on control panel by 6°C. Function is released (automatically) when temperature returns to 5.9°C or below. These parameters are set at the factory and cannot be modified.

Setting range/function

The overheat prevention device temperature setting range is from 0°C to 50°C beyond the maximum temperature setting for BA series units.

When chamber temperature exceeds objective temperature setting and reaches that of the overheat prevention device, the circuit is shut off and error code "Er19" is shown flashing in the control panel display, accompanied by a sounding alarm.

Once activated, "Er19" continues to be displayed until main power switch (ELB) is turned off (wait 5 seconds) then back on.

Setting temperature for overheat prevention

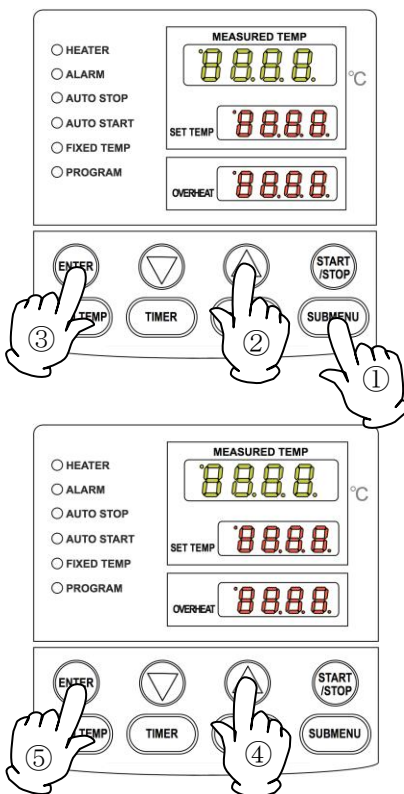

1. Turn on main power switch (ELB).

Default values are displayed for about four seconds.

Turn on power. Displays will show initial settings. Current chamber temperature (top), main temperature setting (center) and temperature setting for overheat prevention device (bottom) will show in respective displays.

2. Set temperature for overheat prevention

- ① Press the **SUBMENU** key.
- ② Press **▼▲** several times until **oH** shows in the top display.
- ③ Press the **ENTER** key. The temperature setting will be shown flashing in center display.

Note: To prevent false errors, set the value 10°C or more above the main temperature setting.

- ④ Select value using the **▼▲** keys and press the **ENTER** key. Setting value will show in the bottom display. This completes the setting.
- ⑤ Press **ENTER**

CAUTION

- ① The standard setting temperature of device is "maximum unit temperature setting of plus 10°C" or "temperature setting plus 10°C". If unit performs poorly, increase by 5°C more. Note that improper temperature settings may cause malfunction resulting in equipment damage or fire. Always use appropriate temperature settings. **The factory default setting for overheat prevention device is 90°C. Do not attempt to set value higher.**
- ② Overheat prevention device is designed to protect unit against overheating, not to protect test samples against damage caused by overheating, nor to protect against injury or death resulting from negligence from processing explosives, inflammables or other hazardous substances in this unit.

4. OPERATION PROCEDURES

Constant (fixed) Temperature Mode

Constant temperature operation procedure

1. Turn on the main power switch (ELB)

- ❖ Default values are displayed for about four seconds after turning on power. Initial settings will then show in respective displays.

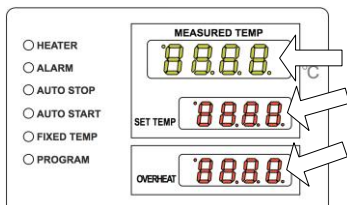

Temperature monitoring display:

Shows current temperature in the chamber and other setting information.

Main temperature setting display:

Shows temperature setting and other setting information.

Overheat prevention display:

Displays the temperature setting of overheat prevention device.

(For more on mode and setting characters, see "Display Characters", P.12)

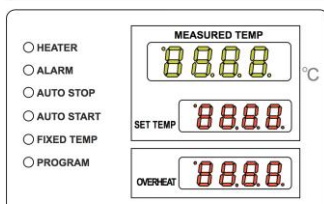

2. Select operation mode

Press the **FIXED TEMP** key to display **Fi II**, indicating constant or "FIX" temperature mode, in center display.

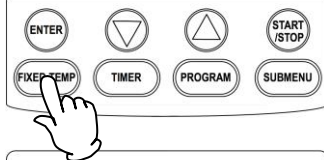

3. Set temperature

Center display shows **50**, indicating temperature can be set. Current temperature will flash in top display. **FIXED TEMP** lamp also flashes.

Set temperature using the **▼▲** keys.

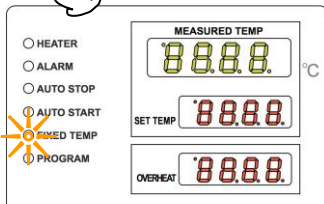

4. Start operation

Press the **START/STOP** key for about one second. Unit will begin operation and **FIXED TEMP** lamp will change from flashing to constant to indicating that unit is currently operating in constant temperature mode.

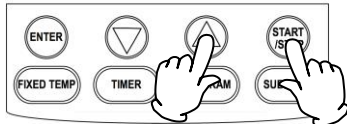

5. Stop operation

Press the **START/STOP** key for about one second. Operation will stop (terminate) and the **FIXED TEMP** lamp will go out. Control panel reverts to initial settings screen.

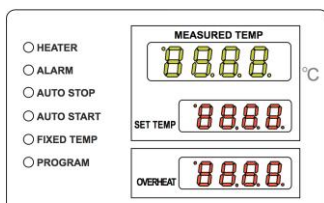

Editing or confirming settings.

Press the **FIXED TEMP** key again to edit or confirm settings.

Changing the temperature setting during operation is also possible using the **FIXED TEMP** key. When setting changes have been made, press the **ENTER** key to finish.

4. OPERATION PROCEDURES

Constant Temperature + Quick Auto Stop Mode

Quick auto stop operation procedure

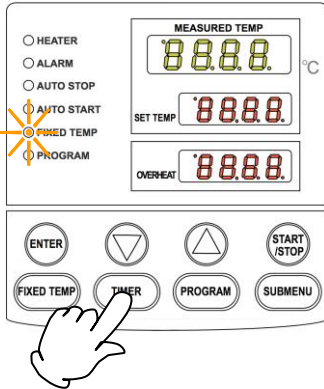

This mode is used to specify when unit should terminate constant temperature operation. This mode is set during operation only.

1. Set timer during constant temperature operation

Confirm that unit is operating by confirming that FIXED TEMP lamp is illuminated.

Press the **TIMER** key.

Top display will show **ti n**, indicating that the timer can be set. Current timer setting will flash in center display.

Set the timer using the **▼▲** keys.

Timer function:

Maximum value for timer is "999 hours and 50 minutes".

The time can be set in increments of one minute, under 99 hours and 59 minutes.

Setting increments are 10 minutes, after 100 hours.

When **▼▲** keys are held down, values advance perpetually. Press repeatedly for incremental adjustment.

2. Start quick auto stop operation

Press the **START/STOP** key for about one second after setting timer.

FIXED TEMP and AUTO STOP lamps will illuminate, indicating quick auto stop operation mode has started.

To manually stop/terminate quick auto stop operation

Operation stops automatically when timer reaches 0.00, and an accompanying alarm sounds for approximately five seconds after operation terminates.

Center display will show **End**, indicating end of operation, with FIXED TEMP and AUTO STOP lamps illuminated. Press **START/STOP** key to at any time during operation or after operation ends, to terminate quick auto stop operation mode. Displays will return to initial settings screen.

Editing or confirming settings

Changing Temperature during operation is possible by pressing the **FIXED TEMP** key. Press the **ENTER** key after changing temperature setting.

Changing the timer setting during operation can be done without terminating operation, simply by pressing the **TIMER** key. Note that this will require adding additional time to the elapsed time. Press the **START/STOP** key when changes have been entered, as desired.

Press the **▼** key at any time thereafter to see temperature setting, operation mode and remaining time in the center display.

4. OPERATION PROCEDURES

Auto Stop Mode

Auto stop operation procedure

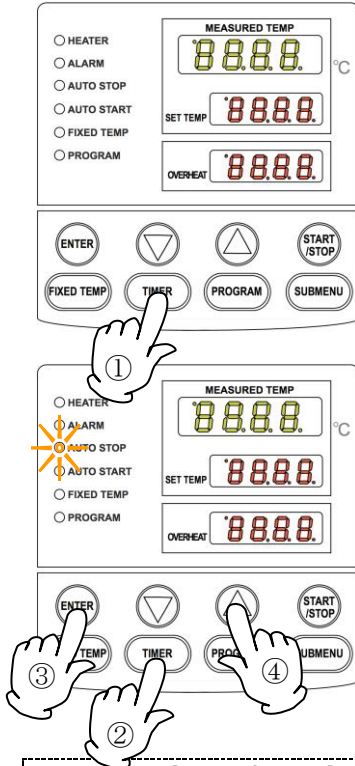

This mode is used to specify when unit should terminate constant temperature operation. In contrast to quick auto stop mode, this mode must be set before operation.

1. Set stop time

- ① Press the **TIMER** key from the initial settings screen.
- ② Mode used in the previous session will be shown in the center display. Press the **TIMER** key again and center display will begin flashing. Use **TIMER** key to select **ASTP**, signifying auto stop operation, then press the **ENTER** key.
- ③ Top display will show **50**, indicating that temperature can be set. Current temperature setting flashes in center display. **AUTO STOP** lamp also flashes.
- ④ Set temperature using **▼▲** keys.
- ⑤ Press the **ENTER** key again. Top display will show **50.0**, indicating that timer can be set. Current timer setting will flash in center display.
- ⑥ Set timer using the **▼▲** keys.

Timer function:

Maximum setting for timer is "999 hours and 50 minutes".

The time can be set in increments of one minute, under 99 hours and 59 minutes.

Setting increments are 10 minutes, after 100 hours.

When the **▼▲** keys are held down, values advance perpetually. Press repeatedly for incremental adjustment.

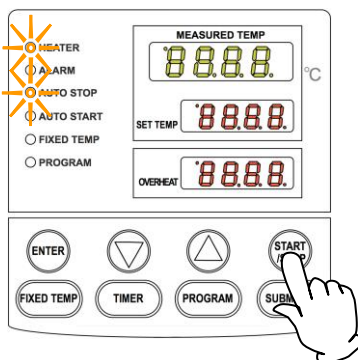

2. Start auto stop operation

Press the **START/STOP** key for about one second after setting timer.

AUTO STOP and **HEATER** lamp illuminate, indicating auto stop operation mode has started.

Timer begins counting down when chamber temperature reaches objective temperature.

4. OPERATION PROCEDURES

Auto Stop Mode

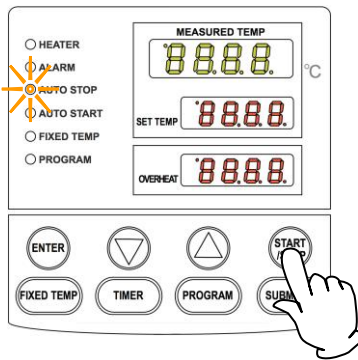

To stop/terminate auto stop operation manually

Operation stops automatically when timer reaches 0.00. An accompanying alarm sounds for approximately five seconds after operation terminates.

Center display shows `End`, indicating end of operation, with AUTO STOP lamps illuminated. Press the `START/STOP` key at any time during operation or after operation ends, to terminate auto stop operation mode. Displays will return to initial settings screen.

Editing or confirming settings

Changing temperature setting or timer setting during operation can be done by pressing the `TIMER` key. Use the `▼▲` keys to change the setting values. Press the `ENTER` key when changes have been entered as desired.

Press the `▼` key at any time thereafter to see temperature setting, operation mode and remaining time in the center display.

Note: Remaining time may be seen `1.30` (center display) with decimal point constant as an indicator that unit is in wait status while temperature rises or falls toward an objective temperature. When decimal point begins flashing, timer is counting down.

4. OPERATION PROCEDURES

Auto Start Mode

Auto start operation procedure

This mode is used to specify an automatic start time for constant temperature operation.

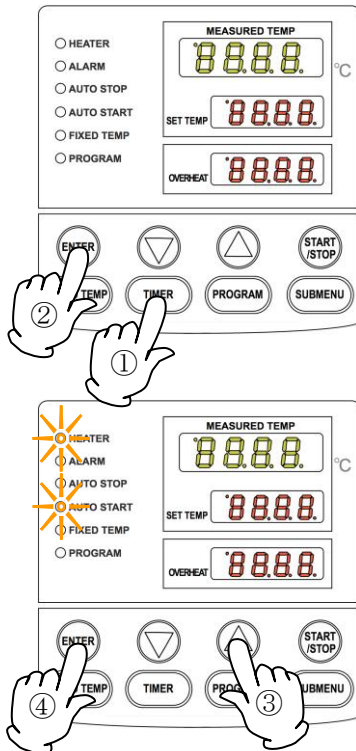

1. Set start time

- ① Press the **TIMER** key from the initial settings screen.
- ② Previous operation mode is displayed in center display. Press the **TIMER** key again and center display begins flashing. Use **TIMER** key to select **AStr**, signifying auto start mode, then press the **ENTER** key.

Top display will show **50**, indicating temperature can now be set. Current temperature setting flashes in the center display. **AUTO START** lamp also flashes.

- ③ Set temperature using the **▼▲** keys.
- ④ Press the **ENTER** key again. Top display shows **tin**, indicating the timer can be set. Current timer setting will flash in the center display.
- ⑤ Set timer using the **▼▲** keys.

Timer function:

Maximum timer setting is "999 hours and 50 minutes".

The time can be set in increments of one minute, under 99 hours and 59 minutes.

Setting increments are 10 minutes, after 100 hours.

When **▼▲** keys are held down, values advance perpetually. Press repeatedly for incremental adjustment.

2. Initialize auto start operation

Press the **START/STOP** key for about one second after setting timer.

Auto start operation mode begins when timer reaches 0.00 and **AUTO START** lamp illuminates.

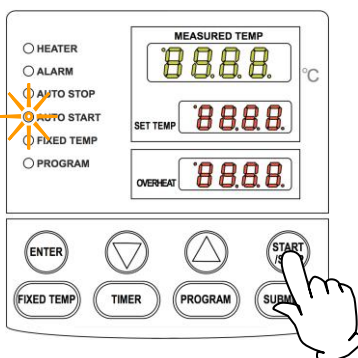

4. OPERATION PROCEDURES

Auto Start Mode

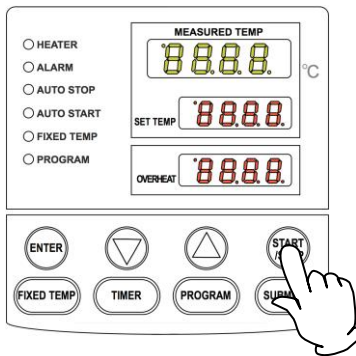

To terminate auto start operation

Operation begins automatically when timer reaches 0.00; but must be stopped manually. Auto start mode can be cancelled any time before or during operation by pressing the **START/STOP** key for about one second. Displays revert to initial settings screen.

Editing or confirming settings

Changing temperature settings or timer settings before an operation begins may be done by pressing the **TIMER** key. Use the **▼▲** keys to change setting values. Press the **ENTER** key when changes have been entered as desired.

These values cannot be modified once operation begins. This can only be done by pressing the **START/STOP** key to terminate operation and setting the values over again.

NOTE: Press the **▼** key at any time after settings are made to see temperature setting, operation mode and remaining time until start, in the center display.

4. OPERATION PROCEDURES

Programmed Operation

Programmed operation

This operation is used to run a combination of temperatures, times and modes as one operation.

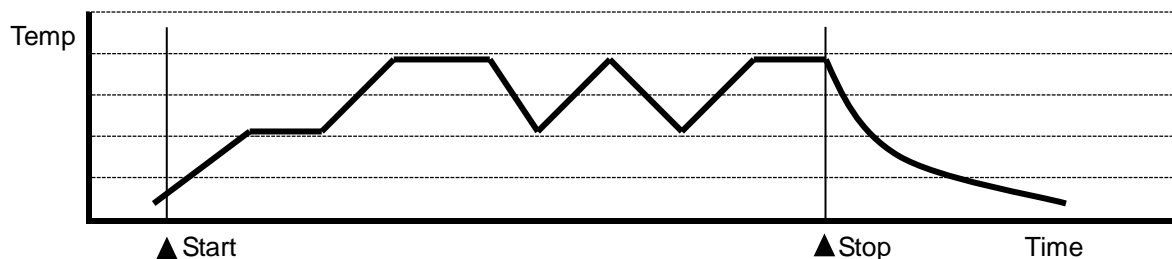

Program types

A maximum of six program pattern types can be entered (middle column).

PrG1	—	1 program pattern using up to 30 steps.
PrG2	PAt1	2 program patterns using up to 15 steps.
	PAt2	
PrG3	PAt1	3 program patterns using up to 10 steps.
	PAt2	
	PAt3	

Before program entry

Enter program patterns before attempting to run a programmed operation.

- ① Confirm the number of steps in a program composition, and its temperatures/times before entering. Using the program planning worksheet on pages 27 and 28 is recommended.
- ② Determine temperature rise/fall capability of unit (refer to tables on next page). Times must be set to accommodate these capabilities.
For example, if unit is capable of increasing or decreasing temperature by 20°C within 10 minutes, approximately 20 minutes will be needed to increase or decrease temperature by 40°C from a given temperature.
- ③ Confirm that the program has a sufficient number of patterns free to allow for the number of steps to be created.
Steps using the repeat function mentioned below, however, are not counted.

Useful function

The repeat function is a convenient feature that can be used, when a series of steps, identical to ones already created, are needed to fill the remainder or remaining part of a program pattern. See “Pattern Repeat Function” (P.26)

4. OPERATION PROCEDURES

Programmed Operation

Temperature fall/rise times for BA models

Temperature rise and fall times for BA models are shown below in 10°C increments.

Numeric values signify time needed (in minutes) for temperature to rise or fall for every 10°C. Temperature stabilization time is an added factor and not included in the table below. Be sure to conduct a test run before finalizing program pattern times.

Temperature rise times

Conditions: room temperature 23°C, no load (time unit: minutes)

Temp °C	BA300 (min)	Deg./min	BA400 (min)	Deg./min	BA500 (min)	Deg./min	BA610 (min)	Deg./min	BA710 (min)	Deg./min
20	—	—	—	—	—	—	—	—	—	—
30	20	0.5	15	0.7	25	0.7	25	0.7	25	0.7
40	15	0.7	15	0.7	25	0.7	25	0.7	25	0.7
50	15	0.7	15	0.7	25	0.7	20	0.5	25	0.7
60	20	0.5	15	0.7	30	0.3	25	0.7	25	0.7
70	20	0.5	15	0.7	30	0.3	30	0.3	30	0.3
80	25	0.4	25	0.4	25	0.4	25	0.7	30	0.3
Total times	Approx. 115 min.	—	Approx. 100 min.	—	Approx. 160 min.	—	Approx. 150 min.	—	Approx. 160 min.	—

Temperature fall times

Conditions: room temperature 23°C, no load (time unit: minutes)

Temp °C	BA300	Deg./min	BA400	Deg./min	BA500	Deg./min	BA610	Deg./min	BA710	Deg./min
80	—	—	—	—	—	—	—	—	—	—
70	35	0.3	30	0.3	40	0.25	45	0.2	55	0.18
60	50	0.2	40	0.25	65	0.15	65	0.15	90	0.1
50	80	0.12	60	0.15	110	0.09	120	0.08	160	0.06
40	150	0.07	110	0.09	200	0.05	200	0.05	220	0.04
30	—	—	165	0.06	—	—	—	—	—	—
Total times	Approx. 315 min	—	Approx. 405 min	—	Approx. 415 min	—	Approx. 430 min	—	Approx. 525 min	—

4. OPERATION PROCEDURES

Programmed Operation

Building Programs

The program pattern below will be used as an example for building programs:

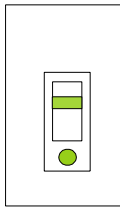
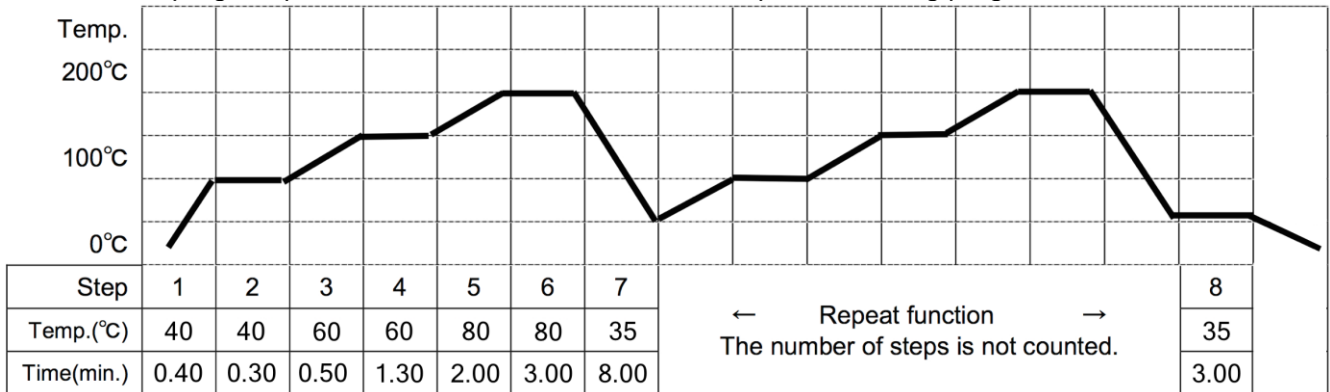

1. Turn on main power switch (ELB ON “I”)

Initial values will be shown for about 4 seconds after power-on, then displays will switch to the initial settings screen, showing current chamber temperature (top), operation mode character (center) and overheat prevention setting (bottom).

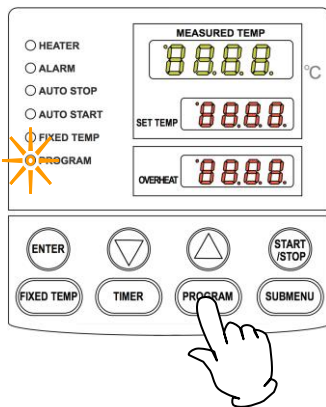

2. Select program mode/program pattern

Press the **PROGRAM** key once.

The top display will show previously used program.

Pressing the **PROGRAM** key again will cause program mode to begin flashing.

Pressing the **PROGRAM** key repeatedly thereafter will toggle between the 3 available program modes (while flashing).

4. OPERATION PROCEDURES

Building Programs

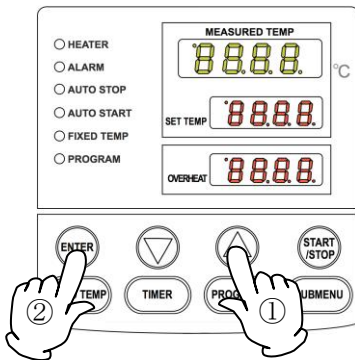

- ① Select mode and press the **ENTER** key.
 - When PrG1 **PrG1** is selected, the top display will show **End**.
 - When PrG2 **PrG2** is selected, the top display will show **PAT**, signifying program "pattern". For PrG2 pattern, select either "1" or "2" (signifying the 2 available patterns) using the **▲▼** keys. Press the ENTER key again. The top display will show "End".
 - When PrG3 is selected, the top display will show "Pat1". For PrG3 **PrG3** patterns, select "1", "2" or "3" (3 available patterns) using the **▲▼** keys. Press the **ENTER** key again. Top display will show "End".

PrG1, PrG2 or PrG3 can be selected for the program example above, since only 8 steps are used.

The following illustrates how to enter a program, using PrG3.

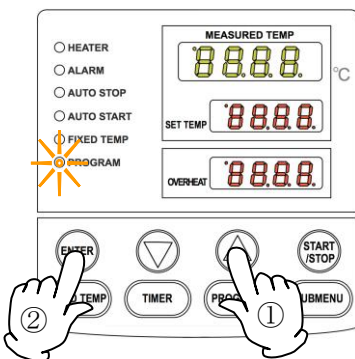

4. Enter program

- ① Select PrG3 according to step 2, above.
- ② Enter the number of steps, temperature and time for each step (use the program planning worksheet on pages 28 & 29).
- ③ Press the **ENTER** key. Pat1 will show, flashing in top display.
("End" is shown if PrG1 is selected. In this case, go to ⑥)
- ④ Select an unused pattern from among Pat1, Pat2 and Pat3 using the **▲▼** keys.
- ⑤ Press the **ENTER** key. "End" will be shown and the step number will be shown flashing.
 - ❖ "End" indicates the total step numbers to be used. In the example above, "8" would be entered here.
- ⑥ Enter the total number of steps (8 in the example above) to be used, using the **▲▼** keys
- ⑦ Press the **ENTER** key. **50.1**, indicating temperature for step 1 can now be set, will show in the top display. Current temperature setting will also be displayed flashing in the center display.
- ⑧ Set the temperature for step 1 using the **▲▼** keys.

4. OPERATION PROCEDURES

Building Programs

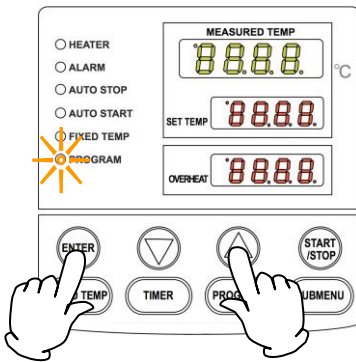

- ⑨ Press the **ENTER** key. `t_1`, indicating timer setting for step 1, will be shown in the top display. Current timer setting will also be shown flashing in the center display.
 - ❖ Before setting the timer, be sure to confirm temperature unit rise/fall capability.
 - ❖ For example, about 30 minutes is needed for a $\pm 10^{\circ}\text{C}$ increase from 50°C to 60°C (see tables on pg. 21 above), on the BA500 model, which is about 1°C every 6 minutes. Accordingly, it would take approximately 60 minutes to reach 70°C at the same rate. This does not include temperature stabilization time.
 - ❖ Maximum timer setting for each step is 999 hours and 50 minutes.
- ⑩ When timer is set, press the **ENTER** key. "Sv_2", indicating temperature for step 2 can now be set, will be shown in top display. Enter temperature and time using the same procedure, described thus far, for all steps (use the program planning worksheet on pages 27 & 28).
- ⑪ When the repeat function becomes necessary, press the **SUBMENU** key after setting timer (step 7 in the above example) in the step where repeat operation is to be used. This brings up repeat function setting mode.
 - ❖ Follow Pattern Repeat Function (P.26) for program repeat function entry procedure.
- ⑫ Screen returns to the initial settings screen, after setting temperature and timer in the final step.

Verification run:

When possible, confirm temperatures and times in a newly entered program by running program with unit unloaded once, before using program on actual test samples.

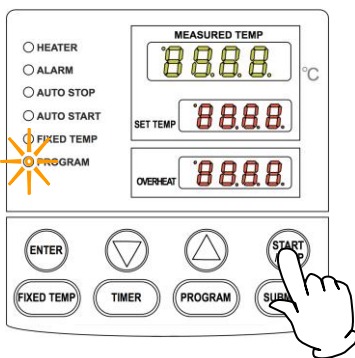

5. Run program

Press the **START/STOP** key for about one second. Program will begin running.

PROGRAM lamp illuminates and the top display will show `5t_1`, signifying that step 1 is currently under way.

- ❖ Use the **▼** to monitor temperature and time (top display) remaining in a currently running step.

4. OPERATION PROCEDURES

Building Programs

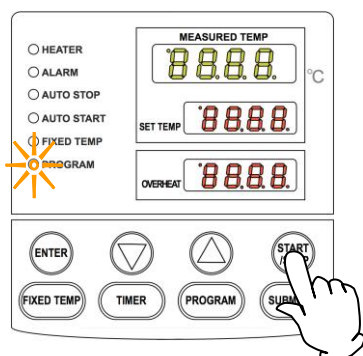

6. End programmed operation

An alert will sound when program ends.

Top display will show "END", indicating that program has finished.

Press the **START/STOP** key to return to initial setting screen.

Timer function:

Maximum setting for timer is 999 hours and 50 minutes.

Timer can be set in increments of one minute, under 99 hours and 59 minutes.

Setting increments are 10 minutes after 100 hours.

When the **▼▲** keys are held down, values will advance rapidly. Press repeatedly for incremental adjustment.

Editing or confirming settings

Press the **FIXED TEMP** key to edit a program, confirm setting values or return to a previous step. Display will return to editing and confirmation screen.

For each time **FIXED TEMP** key is pressed, screen will go back one step.

Note: Editing and confirmation must be done on program setting screen.

Wait status in programmed operation

Succeeding steps will not start if chamber temperature fails to reach, or if it exceeds objective temperature. BA series units, however, are programmed to begin succeeding steps when chamber temperature is within $\pm 3^{\circ}\text{C}$ of objective temperature.

4. OPERATION PROCEDURES

Pattern Repeat Function

Setting program repeat function

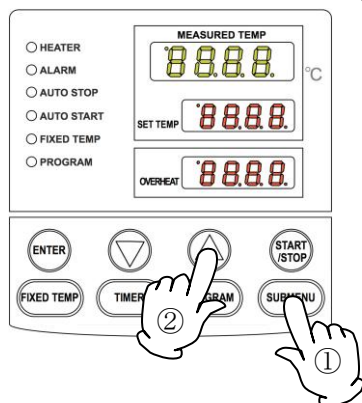

This section illustrates how to use the repeat function (repeat a program pattern) in a programmed operation.

Set program repeat

The following illustration continues from ① of Step 4, "Enter program," above.

This procedure sets the step number to be repeated, "PS_x", and number of times to repeat, "Pc_x" (x = step number)

- ① After setting the timer, press the the **SUBMENU** key (Step 7 in the preceding example). This brings up the repeat function setting mode.
- ② Top display will show "PS_x", indicating the step to be repeated in the program pattern. **PS_7** would be shown in the example above, since repeat function is used at the seventh step. Step numbers 1 to 7 can be entered into the center display. Enter the number (1 in the example) using the **▲▼** keys.
- ③ Press the **SUBMENU** key.
Top will show "Pc_x", indicating the number of times to repeat. Enter this value (2 in the example) into the center display with the **▲▼** keys.
- ④ Screen proceeds to the next step when the **SUBMENU** key is pressed again.
Sv_8 would be displayed next (in the case of example above).

Editing and confirming settings

Editing settings is not possible while in repeat setting mode.

To edit or confirm the settings, complete current step entry, then press the **FIXED TEMP** key, when temperature setting screen for the next step appears. Display will return to previous screen, where editing can be done.

Note: Editing and confirmation must be done in the program setting screen.

Contact a local dealer or Yamato sales office, if further questions arise concerning operation procedures.

4. OPERATION PROCEDURES

Program Planning Worksheet

Input into:	PrG1 PrG2 PrG3 PA1 PA2 PA3	No.	
Project Name		Date	
		Programmer	

Program Pattern

°C	°C	°C	°C	°C	°C	°C	°C	°C	°C	°C	°C	°C	°C	Step No.	1
														2	
														3	
														4	
														5	
														6	
														7	
														8	
														9	
														10	
														11	
														12	
														13	
														14	
														15	
														16	
														17	
														18	
														19	
														20	
														21	
														22	
														23	
														24	
														25	
														26	
														27	
														28	
														29	
														30	

4. OPERATION PROCEDURES

Program Planning Worksheet

Input into:	PrG1 PrG2 PrG3 PA1 PA2 PA3	No.	
Project Name		Date	
		Programmer	

Input Value

	Temperature (°C)	Time (min.)	Repeat Function (Point of return : number of times)
Step 1		:	:
Step 2		:	:
Step 3		:	:
Step 4		:	:
Step 5		:	:
Step 6		:	:
Step 7		:	:
Step 8		:	:
Step 9		:	:
Step 10		:	:
Step 11		:	:
Step 12		:	:
Step 13		:	:
Step 14		:	:
Step 15		:	:
Step 16		:	:
Step 17		:	:
Step 18		:	:
Step 19		:	:
Step 20		:	:
Step 21		:	:
Step 22		:	:
Step 23		:	:
Step 24		:	:
Step 25		:	:
Step 26		:	:
Step 27		:	:
Step 28		:	:
Step 29		:	:
Step 30		:	:

4. OPERATION PROCEDURES

Calibration Offset Function

Using calibration offset

Calibration offset is function which can correct for any differences discovered between actual chamber temperature (taken manually) and the temperature displayed on the control panel (taken by built-in sensor). Offset function can correct to either the positive or negative side of the entire unit temperature range. Offset function can be set or cancelled with the **SUBMENU** key.

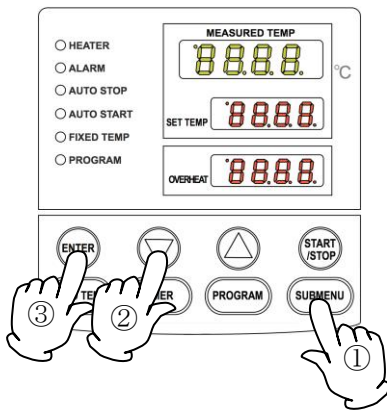
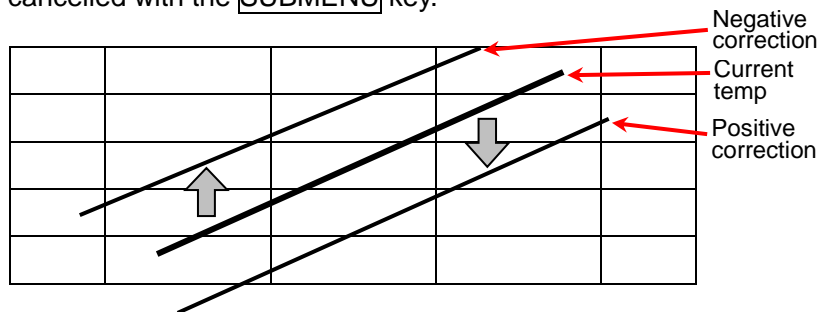

- ① Run unit in constant temperature mode. When temperature stabilizes, gauge chamber temperature with a thermograph.
- ② Confirm whether there is difference between display temperature (shown in top display) and chamber temperature, as recorded by the thermograph. If a difference in temperature values is confirmed, follow the procedure below.
- ③ Press the **SUBMENU** key. Select **CAL**, indicating calibration offset, using the **▲▼** keys and press the **ENTER** key.
- ④ Enter a value that brings temperature display (top display) and chamber temperature into agreement, using the **▲▼** keys and press the **ENTER** key. Example: if chamber temperature as recorded by thermograph is 47°C and temperature in display reads 50°C, in keeping with a temperature setting of also 50°C, a value of -3 should be entered. This forces the unit to compensate by **increasing** the temperature in the chamber by 3°C. This completes the setting, which is effective over entire temperature range of unit.

In addition to the calibration offset function, BA series units have a two-point offset function built in, which has some compensating effects in low and high temperature zones. These offsets have already been entered at the factory.

4. OPERATION PROCEDURES

Keypad Lock Function

Using keypad lock

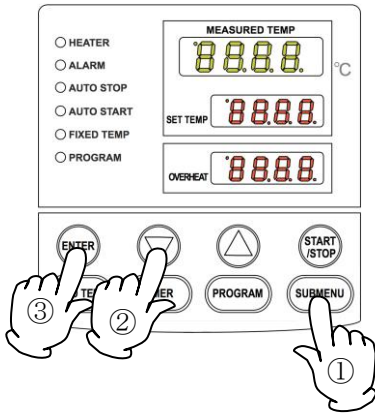

This function locks all keys except the SUBMENU and START/STOP keys, so that settings cannot be unintentionally changed.

Lock is set or cancelled with the **SUBMENU** key.

- ① Press the **SUBMENU** key. Select **Lock**, indicating key lock function, using the **▲▼**, and press the **ENTER** key.
- ② Center display will read "oFF". The the keys are locked when "On" is selected using the **▲** key.
- ③ To cancel the lock, press the **SUBMENU** key again. Select **Lock** using the **▲▼** keys and press the **ENTER** key. Select "oFF" with the **▲** key, then press the **ENTER** key to cancel the function.

5. HANDLING PRECAUTIONS

WARNING!

1. DO NOT operate equipment when abnormalities are detected

-  If unit begins emitting smoke or abnormal odors for reasons unknown, turn off main power (ELB) immediately, disconnect power cable from power supply, and contact a local dealer or Yamato sales office for assistance. Continuing to operate without addressing abnormalities may cause fire or electric shock, resulting in serious injury or death. Never attempt to disassemble or repair unit. Repairs should be always be performed by a certified technician.

2. Hazardous substances

-  Never process explosive or flammable items. Fire or explosion causing serious injury or death may result. See "List of Hazardous Materials" on P.41.

CAUTION!

1. DO NOT climb on equipment

-  Do not attempt to climb onto unit or substitute it for a proper stepladder. Units are not designed to support bodily weight and damage may result. In addition, unit may become unstable and tip over or fall resulting in equipment damage, serious injury or death.

2. DO NOT place items on equipment

-  Do not place any objects on unit. Doing so may cause unit to become unstable and tip over, resulting in possible equipment damage, injury or death..

3. DO NOT operate equipment during thunderstorms

-  In the event of a thunderstorm, turn off main power switch (ELB), and disconnect power cable immediately. A direct lightning strike may cause equipment damage fire or electric shock, resulting in serious injury or death.

4. Clean unit thoroughly before use

-  All BA series units are cleaned before shipping from the factory. To remove packing fragments and other contaminants, which may have collected on unit in shipment, however, thoroughly cleaning unit before initial use and after extended storage periods is recommended.

5. Use proper bath fluids

-  Using purified or distilled water in BA model units is recommended to prevent mineral deposit accumulation.
Never use any fluid other than water. Periodically changing water and washing the bath reservoir is strongly recommended.

6. Supplying water

-  Use care when adding water so that it does not spill on exterior of unit or onto controls and other electronics. If water is spilled onto any of these surfaces, wipe off immediately with a soft, absorbent cloth. Any water or fluid spilled and left on these surfaces may result in equipment damage and/or short circuit or electric shock.

7. Proper shutdown

-  When turning off unit for the day or for extended storage, be sure to turn off the main power switch and disconnect power cable from outlet.

5. HANDLING PRECAUTIONS



8. Unattended operation



If unit is to be left unattended for continuous operation, be sure to equip BA unit with a proper auto water supply device (such as a Level Controller [Model OBF10] product code: 221570) so that it will not be allowed to run dry.

9. DO NOT allow bath to run dry (overheat prevention activation)



Never allow BA units to run without water in the bath reservoir. This may cause the heating element to overheat and may result in damage to element or shortened element lifespan. Likewise, allowing unit to run dry may cause a fire hazard. Confirm fluid level before operation, check periodically throughout operation period and add fluid as needed.

BA series units are equipped with automatic overheat prevention function, which shuts off power to the heating element when temperature goes too far beyond temperature setting. This function alone, however, may be insufficient to prevent damage to heating element in the event of dry operation. Call for inspection/service if unit has been allowed to run dry.

10. Power outage recovery



When power is restored after an outage, operation restarts where it left off immediately before the failure. Leaving device to restart unattended, however, is a safety hazard. Turning the main power switch off in the event of an outage is therefore recommended.

6. MAINTENANCE PROCEDURES

Daily Inspection & Maintenance

Daily general maintenance and inspection is recommended to ensure optimal equipment performance.

! WARNING!

- Be sure that main power switch (ELB) is OFF and power cable disconnected before daily inspection and maintenance of BA series units.
- Perform inspections and maintenance with bath reservoir at room temperature. (Confirm bath water has sufficiently cooled down.)
- Never attempt to disassemble unit.

! CAUTION!

- Clean unit using soft damp cloth.
- Never use benzene, paint thinner, scouring powder, scrubbing brush or other abrasives and solvents to clean unit. Superficial damage and/or discoloration, as well as deformity to some components may result.

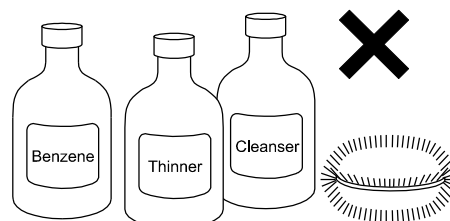

Monthly maintenance

- Check main breaker (ELB) function.*
 1. Prepare unit for inspection by connecting power cable to a facility outlet or terminal.
 2. Confirm that main switch (ELB) is "OFF" then, turn main switch (ELB) back "ON".
 3. With the main switch "ON", depress the test button on the main switch (ELB) using a ball-point pen or other fine-tipped object. If main switch (ELB) shuts off, it is functioning normally.

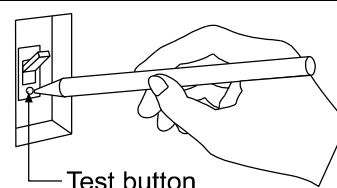

* If so equipped.

Bath reservoir maintenance

- Change bath water at regular intervals to prevent contaminant and mineral buildup on heater element and reservoir interior.

Hose replacement

- In order to be able to operate BA unit continually and without interruption, replacing hoses at least once every 2 years is recommended. Please contact Yamato Scientific regarding proper hose replacement.

For further questions or assistance, please contact your local Yamato dealer or customer service center.

7. STORAGE AND DISPOSAL

Extended Storage / Unit Disposal



Extended storage

- If unit will be out of service for an extended period, turn off main power switch (ELB) and disconnect power cable from facility outlet or terminal.



Unit disposal

- Remove any door handles and hinges to prevent unit from locking.
- Do not leave unit where it will be unattended, or in a location where children may have access.
- Dispose of this unit in accordance with local laws and regulations.

Disposal considerations

Dispose of or recycle this unit in a responsible and environmentally friendly manner.

Yamato Scientific Co., Ltd. strongly recommends disassembling unit, as far as is possible, in order to separate parts and recycle them in contribution to preserving the global environment.

Major components and materials, comprising BA series units are listed in the table below:

Component name	Composition
Exterior	
Exterior structure	Steel paneling
Bath	SUS304 Stainless steel
Observation window	Semi-tempered glass
Support rod	Aluminum die cast
Production labels	Polyethylene (PET) resin film
Unit frame, corner protectors	Alkylbenzenesulfid (ABS) resin
Rubber trim, rubber paneling	Chloroprene rubber
Electrical	
Switches, Relays	Resin, Copper, Other composites
Circuit boards	Glass fiber, Other composites
Tube heater	Copper
Power cable	Composites of synthetic rubber, copper, nickel
Plumbing	
Hoses	Ethylene Propylene Rubber (EPR)
Drain Hose	Cone hose
Hose Clamp	66 Nylon
Drain Cap	Juracon
Options	
Connector	Die cast aluminum
Flask Clip	Die cast aluminum
Shaft	SUS304 stainless steel

8. ERROR CODES







Reading Error Codes

BA series units have a self-diagnostic function built into the CPU board and a separate safety device, independent of the CPU board.

The table below shows possible causes and measures to take when safety device is triggered.

Error Codes

When an operational error or malfunction occurs, the alarm lamp on the control panel illuminates, an error code is displayed, and an alarm sounds. When an error occurs, confirm the error code and terminate operation immediately. Note that a temperature gauging error will be indicated by ALARM lamp illuminating and accompanied by dashes in the display. No error code will be displayed and no alarm will sound.

Safety device	Symptom	Possible causes and countermeasures
Sensor error detected	Alarm lamp on  in display	<ul style="list-style-type: none"> ● Temperature sensor interrupted, disconnected or other malfunction Contact a local dealer or Yamato sales office
Short circuit detected	Alarm lamp on  in display	<ul style="list-style-type: none"> ● Short circuit in SSR (solid state relay) Contact a local dealer or Yamato sales office
Heater interruption detected	Alarm lamp on  in display	<ul style="list-style-type: none"> ● Heater interrupted or disconnected ● Current detection element interrupted, disconnected or other malfunction Contact a local dealer or Yamato sales office
Memory error	Alarm lamp on  in display	<ul style="list-style-type: none"> ● Memory setting error Contact a local dealer or Yamato sales office
Internal communication error	Alarm lamp on  in display	<ul style="list-style-type: none"> ● Internal communication error, temperature input circuit error Contact a local dealer or Yamato sales office
Overheat	Alarm lamp on  in display	<ul style="list-style-type: none"> ● Overheat prevention unit activated ● Overheat prevention unit interrupted disconnected or other malfunction Check the temperature setting. If the unit does not reset, contact service department.
Temperature gauging error	----- in display	Gauged temperature is out of display range Contact a local dealer or Yamato sales office

9. TROUBLESHOOTING

Troubleshooting Guide

Symptom	Check
Unit does not turn on/nothing is displayed in control panel displays when power switch (ELB) is turned "ON".	<ul style="list-style-type: none">● Whether power cable is connected securely to power terminal or outlet.● Whether a power outage is in progress.
Bath temperature does not rise.	<ul style="list-style-type: none">● Whether temperature setting is below bath temperature.● Whether power supply voltage has dropped.● Whether external temperature is within operational temperature range. (operational external temperature range is 5°C~35°C)● Whether bath is overloaded (too many samples).
Temperature fluctuates during operation.	<ul style="list-style-type: none">● Whether temperature setting is appropriate.● Whether power supply voltage has dropped.● Whether there are large fluctuations in external temperature.● Whether bath is overloaded (too many test samples).
Circulation pump emitting abnormal noise	<ul style="list-style-type: none">● Whether pump is circulating air instead of water. Stop pump and be sure that pump is circulating fluid and that any air is bled out.

If problem persists, turn off power immediately; disconnect power cable from outlet or terminal and contact a local dealer, sales office or support center for assistance.

Requests for Repair

When a problem occurs, terminate operation immediately, turn off main power switch (ELB) and disconnect power cable.

Contact a local dealer or Yamato sales office for assistance.

The following information is required for all repairs.

- Model name
 - Serial Number
 - Date (year/month/day) of purchase
 - Description of problem in as much detail as possible
- } Refer to serial no. and rating label on unit.
See P.7 for label location.

Guaranteed Supply Period for Repair Parts

Guaranteed maximum supply period for repair parts is 7 (seven) years from date of discontinuation for BA series baths. "Repair parts" is defined as components which, when installed, allow for continued unit operation.

11. SPECIFICATIONS

	BA300	BA400	BA500	BA610	BA710
Operating temperature range	Ambient temp + 5 to 80°C				
Temperature control accuracy	±0.02~±0.07°C				
Temperature distribution accuracy	±0.1°C				
Time required to reach maximum temperature	Approx. 120min.	Approx. 110min.	Approx. 165min.	Approx. 160min.	Approx. 200min.
Bath reservoir	Stainless steel SUS304, Glass				
Temperature control system	Microcomputer PID control (static value system)				
Sensor	Platinum resistance bulb (Pt 100 Ω)				
Temperature setting system	Digital setting				
Temperature display system	Digital display				
Overheat prevention system	ON/OFF control via microcomputer				
Overheating prevention setting system	Digital setting				
Overheat prevention sensor	K-thermocouple (W-sensor with Pt 100 Ω)				
Heater	Copper tube heater (Nickel plated)				
	1.3KW	2.2KW	2.4KW	3.5KW	4.5KW
Stirring mechanism	Magnet pump				
	6W	30W	30W	60W	
Timer	1 minute to 99 hours 59 minutes, and 100 hours to 999 hours Digital setting on auto start and auto stop mode				
Safety devices	Earth leakage breaker, overheat prevention device, self-diagnostic functions (heater disconnect detection, TRIAC short circuit detection, overheat prevention device)				
Internal dimensions (W × D × H mm)	300 × 300 × 300	400 × 350 × 300	500 × 400 × 350	548 × 500 × 400	640 × 500 × 450
Overall dimensions (W × D × H mm)	490 × 360 × 367	590 × 410 × 367	690 × 460 × 417	738 × 560 × 467	830 × 560 × 517
Observation window dimensions	240 × 215	340 × 215	440 × 265	340 × 215	440 × 265
Bath reservoir capacity	Approx. 27L	Approx. 42L	Approx. 70L	Approx. 109L	Approx. 144L
Drain hose size	φ 15 × 20				
Power supply (50/60Hz)	220V AC single phase				
	6.5A	10.5A	11.5A	16A	20.5A
Weight	Approx. 19Kg	Approx. 25Kg	Approx. 30Kg	Approx. 36Kg	Approx. 46Kg
Included items	Rack: 1, Clamps: 2, Stand: 1, Clamp holders: 2, Instruction manual: 1				

Optional Accessories	Product code			
	Vessel racks	Lids	Viscosity meter support	Cooling line
BA300	221195	221192	221189	221182
BA400	221196	221193	221183	
BA500	221197	221194	221184	
BA610	-	200000	-	-
BA710	-		-	-

12. WIRING DIAGRAMS

All Models

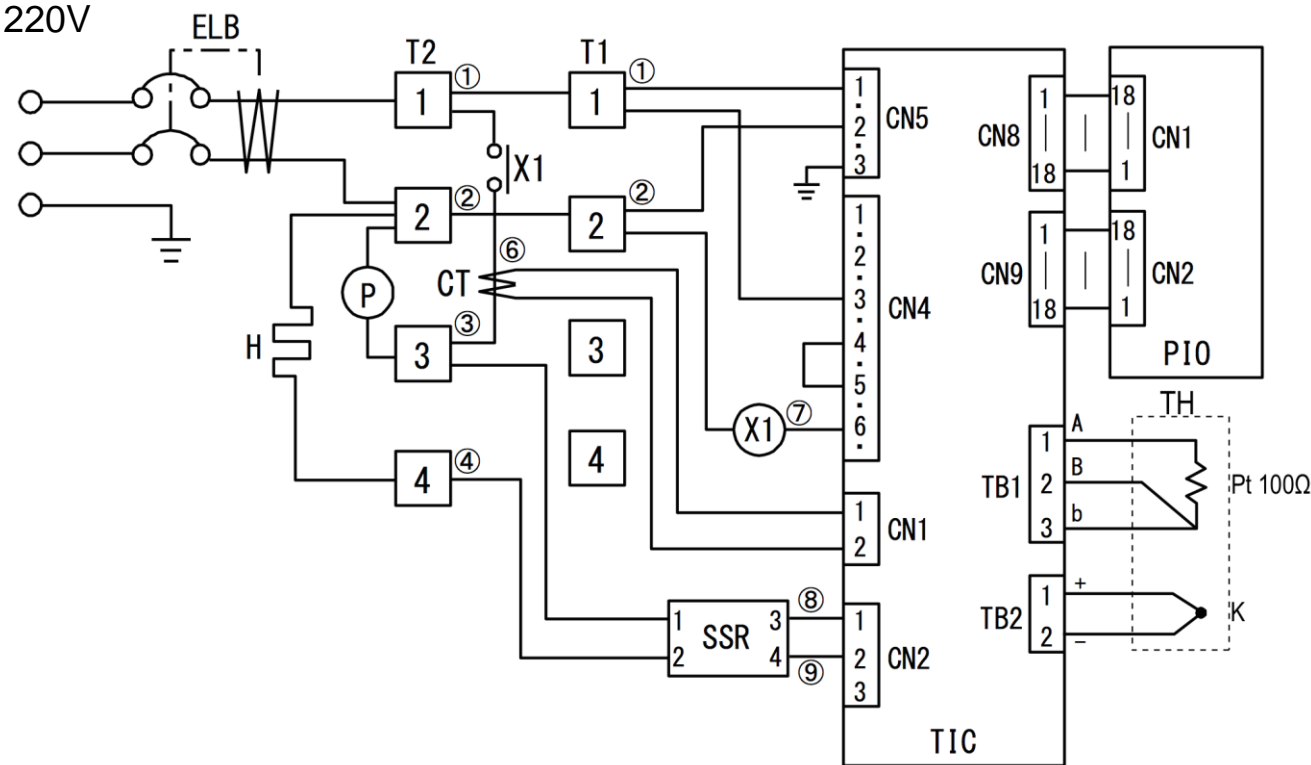

Symbol	Part name
ELB	Earth leakage breaker
T1, T2	Terminal blocks
TIC	Motherboard
PIO 1	Display circuit board
X1	Relay
CT	Current transformer
SSR	Solid state relay
H	Heater
TH	Double sensor
P	Circulation pump

13. REPLACEMENT PARTS LIST

All models

Part Name	Part No.	Specification	Manufacturer
Double sensor	1160030047	K-thermocouple φ 4.8L × 125L PT1/8	Yamato Scientific
VS model thermoregulator motherboard & display board	1020000053	VS-4 (program), PIO, PLANAR, two ribbon cables	Yamato Scientific
Current transformer cell	2170010005	CTL-6-S-H	URD
Terminal block	LT00035672	MKH-250ABC 4P	Terminal
Terminal block	LT00004736	ATK-20-4P	Togi
Relay	2050000059	AHE1275 220V	Panasonic

BA300

Tube heater		SUS316L 220V 1.3KW	Yamato Scientific
Magnet pump		MD-10A 6W 220V	Iwaki
SSR (solid state relay)	2160000035	TRS5225	Toho Electric
Earth leakage breaker	DN104	BJS1532N 15A	Panasonic

BA400

Tube heater		SUS316L 220V 2.2KW	Yamato Scientific
Magnet pump		MD-20R-N 30W 220V	Iwaki
SSR (solid state relay)	2160000036	TRS1245	Toho Electric
Earth leakage breaker	2060050003	BJS3032N 30A	Panasonic

BA500

Tube heater		SUS316L 220V 2.4KW	Yamato Scientific
Magnet pump		MD-30R 30W 220V	Iwaki
SSR (solid state relay)	2160000036	TRS1245	Toho Electric
Earth leakage breaker	2060050003	BJS3032N 30A	Panasonic

BA610

Tube heater		SUS316L 220V 3.5KW	Yamato Scientific
Magnet pump		MD-40R 60W 220V	Iwaki
SSR (solid state relay)	2160000036	TRS1245	Toho
Earth leakage breaker	2060050002	BJS2032N 20A	Panasonic

BA710

Tube heater		SUS316L 220V 4.5KW	Yamato Scientific
Magnet pump		MD-40R 60W 220V	Iwaki
SSR	2160000036	TRS1245	Toho Electric
Earth leakage breaker	2060050003	BJS3032N 30A	Panasonic

14. LIST OF HAZARDOUS SUBSTANCES



Never attempt to process explosives, flammables or any items which contain explosives or flammables

Explosive Substances	1) Nitroglycol, Glycerine trinitrate, Cellulose Nitrate and other explosive nitrate esters
	2) Trinitrobenzen, Trinitrotoluene, Picric Acid and other explosive nitro compounds
	3) Acetyl Hydroperoxide, Methyl Ethyl Ketone Peroxide, Benzoyl Peroxide and other organic peroxides
	4) Metallic Azide, including Sodium Azide, etc.
Combustible Substances	1) Metal "Lithium" 2) Metal "Potassium" 3) Metal "Natrium" 4) Yellow Phosphorus
	5) Phosphorus Sulfide 6) Red Phosphorus 7) Phosphorus Sulfide
	8) Celluloids, Calcium Carbide (a.k.a, Carbide) 9) Lime Phosphide 10) Magnesium Powder
	11) Aluminum Powder 12) Metal Powder other than Magnesium and Aluminum Powder
	13) Sodium Dithionous Acid (a.k.a., Hydrosulphite)
Oxidizing Substances	1) Potassium Chlorate, Sodium Chlorate, Ammonium Chlorate, and other chlorates
	2) Potassium Perchlorate, Sodium Perchlorate, Ammonium Perchlorate, and other perchlorates
	3) Potassium Peroxide, Sodium Peroxide, Barium Peroxide, and other inorganic peroxides
	4) Potassium Nitrate, Sodium Nitrate, Ammonium Nitrate, and other nitrates
	5) Sodium Chlorite and other chlorites
	6) Calcium Hypochlorite and other hypochlorites
Flammable Substances	1) Ethyl Ether, Gasoline, Acetaldehyde, Propylene Chloride, Carbon Disulfide, and other substances having ignition point of 30 or more degrees below zero.
	2) n-hexane, Ethylene Oxide, Acetone, Benzene, Methyl Ethyl Ketone and other substances with ignition point between 30 degrees below zero and less than zero.
	3) Methanol, Ethanol, Xylene, Pentyl n-acetate, (a.k.a.amyl n-acetate) and other substances having ignition point of between zero and less than 30 degrees.
	4) Kerosene, Light Oil, Terebinth Oil, Isopentyl Alcohol(a.k.a. Isoamyl Alcohol), Acetic Acid and other substances having ignition point of between 30 degrees and less than 65 degrees.
Combustible Gas	Hydrogen, Acetylene, Ethylene, Methane, Ethane, Propane, Butane and other gases combustible at 15°C, ambient air pressure.

Excerpt from Table 1, Hazardous Substances, in Cabinet Order from Occupational Safety and Health Law (substances related to Articles 1, 6, and 9)

Limited Liability

Always operate equipment in strict compliance to the handling and operation procedures set forth by this instruction manual.

Yamato Scientific Co., Ltd. assumes no responsibility for malfunction, damage, injury or death, resulting from negligent equipment use.

Never attempt to disassemble, repair or perform any procedure on BA series units which are not expressly mandated by this manual. Doing so may result in equipment malfunction, serious personal injury or death.

Notice

- Instruction manual descriptions and specifications are subject to change without notice.
- Yamato Scientific Co., Ltd. will replace flawed instruction manuals (pages missing, pages out of order, etc.) upon request.

Instruction Manual for

**Constant Temperature Water Bath
Model BA300/400/500/610/710**

Fourth Edition January 18, 2017
Revised

Yamato Scientific America Inc.
925 Walsh Avenue, Santa Clara, CA 95050
Phone: 800.292.6286 / 408.235.7725
<http://www.yamato-usa.com>